

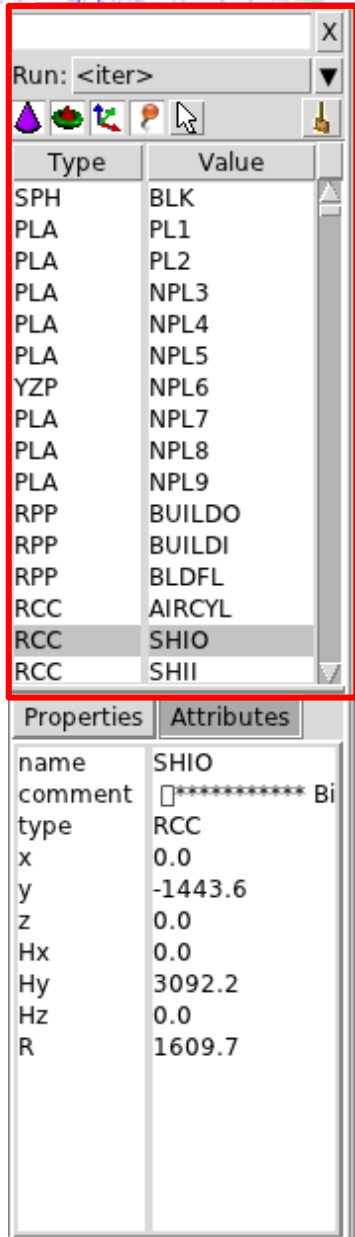

Flair – Geometry Editor – Part II







Advanced FLUKA Course

Listbox - Objects



- Lists the type/name of bodies, regions, objects
- Text coloring:
 - **RED** Error in the card description
 - **Magenta** Visible body/object
 - **Orange** Selection locked
- Filtering text box can narrow the list with items containing the typed-in text

Buttons – on/off the display of

-  Bodies
-  Regions
-  Transformations
-  Materials
-  Objects
-  Selected or Visible items

Listbox – Properties / Attributes

The screenshot shows a software interface with a listbox and a properties/attributes panel. The listbox contains the following items:

Type	Value
SPH	BLK
PLA	PL1
PLA	PL2
PLA	NPL3
PLA	NPL4
PLA	NPL5
YZP	NPL6
PLA	NPL7
PLA	NPL8
PLA	NPL9
RPP	BUILD0
RPP	BUILD1
RPP	BLDFL
RCC	AIRCYL
RCC	SHIO
RCC	SHII

The properties/attributes panel for the selected item (RCC SHIO) is shown below:

Properties	Attributes
name	SHIO
comment	<input type="checkbox"/> ***** Bi
type	RCC
x	0.0
y	-1443.6
z	0.0
Hx	0.0
Hy	3092.2
Hz	0.0
R	1609.7

Properties:

- Displays the common WHATs of the selected cards
 - REGION:
 - If one REGION and Bodies are selected the REGION will stay visible
 - Additionally one can select the **MATERIAL** and automatically an **ASSIGNMAT** will be created/modified
- WARNING: Only if this region is not part of a range or inside an **#if..#endif**



Tips:

- **[Enter]** moves to the next field
- Typing multiple values splits them into many fields:
e.g. x: **1 2 3** **[Enter]**
will split it to x: 1, y: 2, z: 3

Attributes:

- Displays other information related to the card
- Bodies: Visibility, Selection Locking, Wireframe
- Regions: NAZ, Alpha(Transparency), **ROT-DEFI...**

Selection

- **Objects/Bodies/Regions/Zones** can be selected using:
 - Object and/or Properties list boxes
 - graphically with the action [s]  using the **left mouse button** on the viewport;
- [**Ctrl**] + **left mouse button**: allows to toggle the selection (select/unselect);
- **Area selection**: Click on the background and drag the mouse to draw a rectangle area. Everything inside the area will be selected.
- The selected bodies are:
 - outlined in **magenta**
 - **yellow** dots appear on their vertices;
 - highlighted also into the object list in the left bar;
 - Their common properties & attributes will be displayed on the list boxes.
- The selected regions are shaded;
- The select zones are shaded with a hash pattern; To select a zone first you have to select the REGION

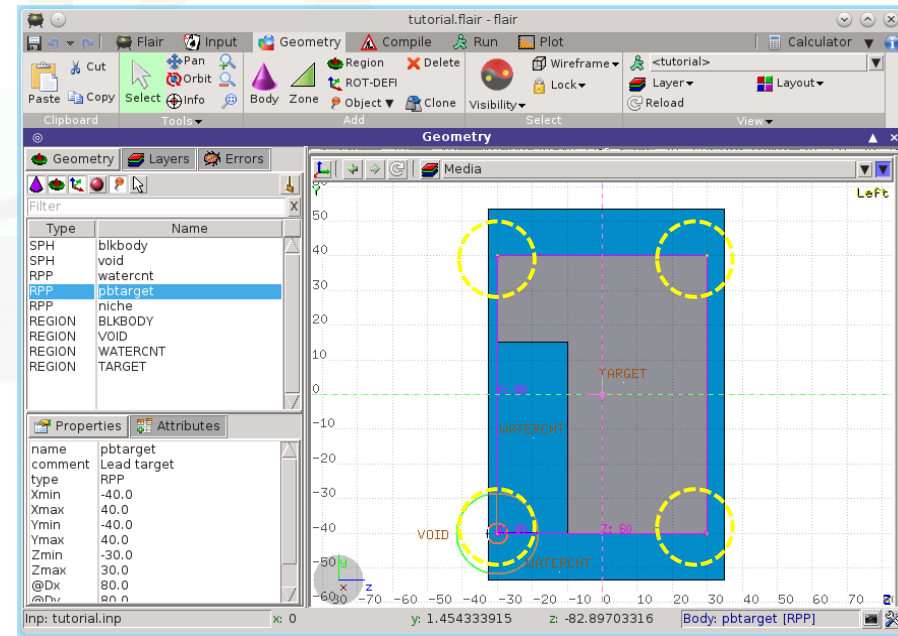

[**ESC**ape] cancels the selection

Objects

There are a few auxiliary objects in flair for helping the drawing

- **Point [p]**
 - to be used as snapping points
 - provide help text to the user
 - automatically generated after image calibration
- **Arrow or line**
 - to be used as snapping points
 - provide basic drawing/pointing means to the user
- **Ruler simple or angle**
 - to measure distances and angles
 - to project snapping points to a different location
 - to be used as snapping points
- **Light for the 3D**

The objects are stored in the input file with the special flair tags:

!point, !arrow, !ruler, !light

All tags starting with ! are treated as comments and ignore by FLUKA

New Body

- Add a body: **Right-Click**, or [**b**] or [**Space**] or [**Ins**] Menu is organized in sub-categories
- [**B**] (capital) to repeat last add body
 - **left-click** on the wished location of the new body
 - **keeping the left-button pressed drag** to the location of the first extend of the body
 - **release** and continue with the next one...
- Renaming a body will automatically rename any reference to it without asking the user
- All new bodies will use the same **name** prefix from the last body renaming



[**n**]ame allows to fast edit the name of the object



New Body Mouse Steps

The default dimension/radius of all new bodies is one grid unit

XYP, ZXP, YZP: Viewport should not be parallel to body

Location

PLA: \perp viewport

Location \rightarrow Second point belonging on the plane

RPP: symmetric around the w-axis

Location \rightarrow Outer corner on the viewing plane

BOX: XY plane // viewport, Z vector = $-\mathbf{w}$

Location \rightarrow X-vector end \rightarrow Move outer plane

WED: as in **BOX**

Location \rightarrow X-vector \rightarrow Y-vector (forced \perp X)

New Body Mouse Steps

RCC: Height will be lying on viewport

Location → Height → Radius

REC: Height will be lying on viewport

Location → Height → Radius-X [→ Radius-Y if viewport permits it]

XCC, YCC, ZCC

Location → Radius

XEC, YEC, ZEC: *be careful on the chosen viewport*

Location → Radius-X [→ Radius-Y if viewport permits it]

TRC: Height will be lying on viewport



Location → Height → Apex radius → Base Radius

ARB: not possible for the moment

QUA: will generate a sphere at desired location

Location

Body Visibility

- Default: Body SEGMENTS ARE ONLY VISIBLE when they represent borders of **REGIONS**
- In order to make them visible (to be able to visually select them):
 - Select the body (from the list box, or from its visible segment) and Either
 - Go to the **Attributes** and click on **Visible [X]** check box
 - **Right-click → Visibility → Set**
 - Shortcut [**v**]
 - Icon on Toolbar 
- Wireframe (experimental) display an approximate 3D wireframe of the bodies. Useful to select or visualize bodies that do not intersect the viewport
 - Go to the **Attributes** and click on **Wireframe [X]** check box
 - **Right-click → Wireframe → Set**
 - Shortcut [**#**]
 - Icon on Toolbar 

Body Editing

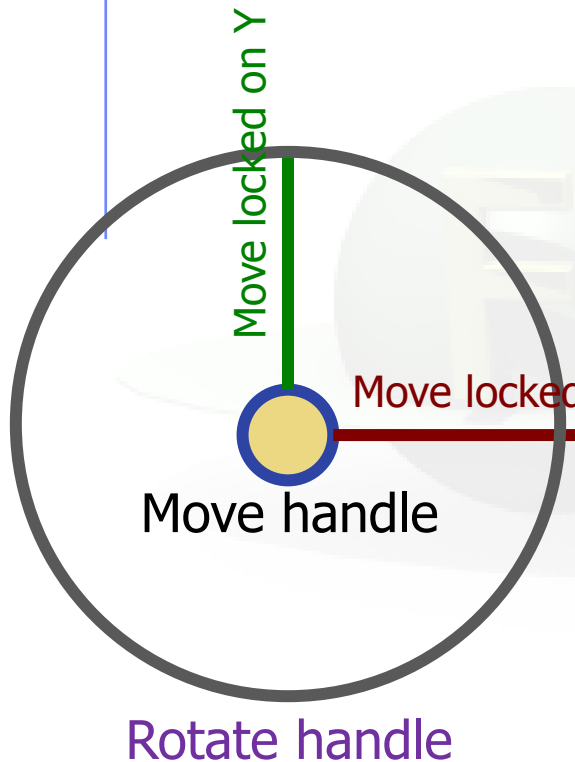

Text:

- Bodies can be edited by typing the correct coordinates in the Properties or in flair

Graphically:

- Select the body and the action handler(s) will be displayed
- **Click** with the mouse for a second time:
 - on the small circle to freely move [**g**]rab
 - on the large circle to rotate [**r**]otate around **w** axis
 - on the **red/green/blue** line to move but locked on X, Y or Z axis
 - Hitting [**x**], [**y**], [**z**] while moving a body toggles the locking on the axis
 - Typing the coordinates moves or resizes the objects e.g. 100 50 10
- **Shift-Click** the mouse to clone the body/object
 - Using **/nnn** or ***nnn** multiple clones can be generated divided or multiple of the distance specified e.g. /5 creates 5 clones in 1/5th of the distance 10

Body Editing

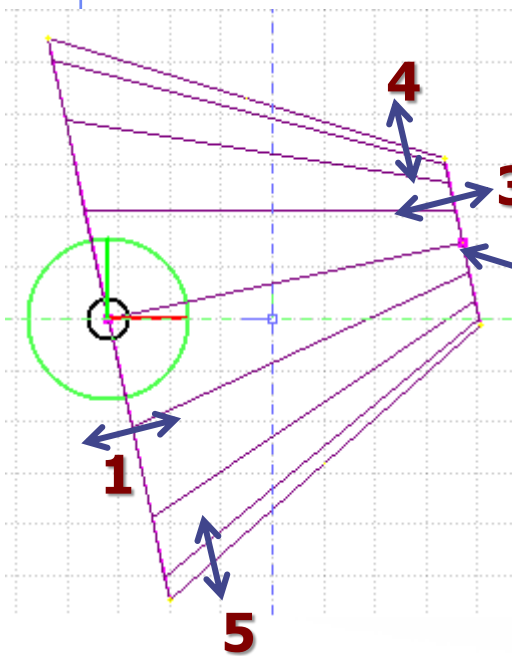

- When a body is selected and the action handlers are shown you can either click & drag the handlers for moving, rotating, resizing the object:

TRC example, click & drag:

1. On the **base plane**, to move it perpendicular \perp to height vector
2. On the **small square handler** on the apex plane, to freely move the height, axis or normal of body
This handler appears only if it lies on the viewing plane
3. On the **apex plane**, to move it perpendicular to the height vector
4. On the **conic surface close to the apex** to resize the apex radius
5. On the **conic surface close to the base** to resize the base radius

Body Context Menu

- When selecting a body the following context menu appears

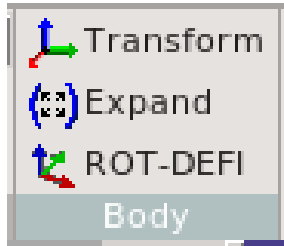

Opens the transformation dialog (below)

Expand a macro body into infinite bodies

Display the ROT-DEFI associated with the body if any

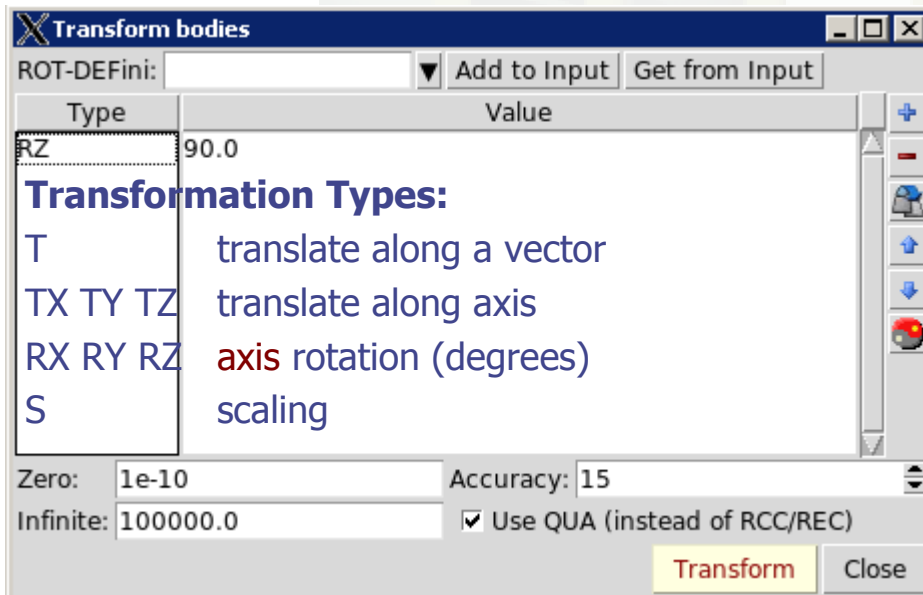

- Applies a user transformation to the selected bodies on the input editor.
- Convert transformations to/from **ROT-DEFini** cards
- Zero**: limit below which to be considered as zero
- Accuracy**: Numeric digits
- Infinite**: infinite bodies when converted to which size to use
- Use **QUA**: convert infinite cylinders to infinite QUAdrics

Remember:



When transforming bodies for use with **LATTICE** card, use the maximum precision

Region Editing

- Add a **REGION**: Right-Click or [**R**] or [**Space**] or [**Ins**]
- Immediately the properties listbox will be activated to edit the name
- Renaming a region will automatically rename any reference to it without asking the user
- When changing the material or transformation of a region flair will automatically add the appropriate **ASSIGNMAT** and/or **LATTICE** cards
- However deleting a region will not delete the associated **ASSIGNMAT** and/or **LATTICE** cards

Shortcuts:

- [**n**] Change the name of a region
- [**M**] Change the material of a region

Context Menu:

Go to material definition

Calculate volume**

Go to LATTICE ROT-DEFI



Expand parenthesis*

* Use with caution (can explode the memory)

** Activated only when the development features are requested

Zone editing

With the keyboard:

- **Add**: Enter an expression in the "+zone" field
- **Modify**: Select the zone to modify and alter with the keyboard the zone expression
- **Delete**: Select the zone and then **Right-Click**→**Delete** or hit the [**Del**] key INSIDE the Property Listbox!

Zone: is a subregion expressed in terms of + and – only
e.g. REGION +a +b | +c –d
contains three zones
zone01: +a +b
zone02: +c –d

Zone editing

Graphically:

- First select the desired **REGION** to add/modify the zone
- **Add** a new zone:
 - Verify that there is no zone selected in the property listbox. If there is any hit **Escape** to unselect them
 - **Add** on the selection **ONLY** the bodies representing the borders of the zone
 - Click on **Right-click** or **[Space]->Zone**  or with **[D]efine** (*capital*)
 - Move the mouse and click in one of the viewports a point that should belong to the wished zone
 - Automatically the zone expression will be created
- **Modify/Edit** an existing zone:
 - Select the zone either on the property listbox or graphically in any viewport clicking a point that belongs to it
 - Automatically all bodies involved in the zone expression will be selected
 - With the zone selected, select or unselect additional bodies if needed
 - Then like in the "Add a new zone" click on "**Zone**" or with **[d]efine** (*small*) and click on point that belongs to it



Do not select bodies that you don't need

Zone Editing: Example [1/7]

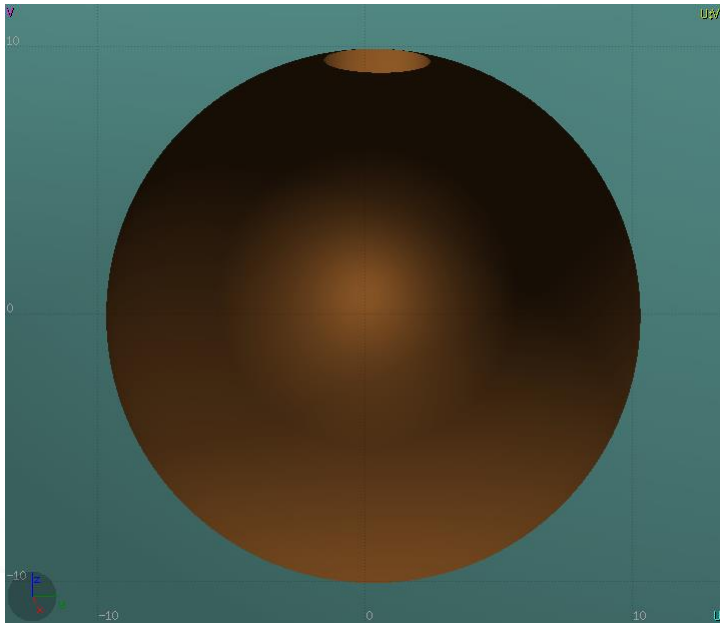

- In this example we will create a sphere with a cylindrical hole cut with a tilted plane (@ 30°)
- First we have to create all necessary bodies
 - sphere
 - infinite cylinder
 - tilted plane

Zone Editing: Example [2/7]

- Then we add a new REGION [Spacebar] → Region 
- The region expression is empty
- Type-in the name and select the appropriate material
- Press [ESCAPE]



The region should remain selected

- Each body e.g. sphere divides the space into 2 zones
- Add to the selection the sphere (holding [Ctrl] pressed) and the sphere outline will be highlighted
- The sphere divides the space into two zones:
 - 1 +sphere inside the sphere
 - 2 -sphere outside the sphere

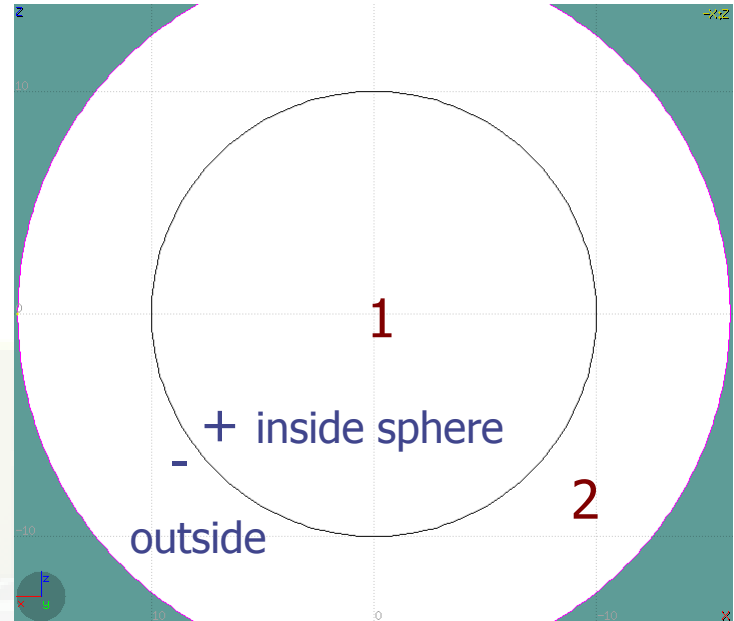

Reference image

Zone Editing: Example [3/7]

- Add to the selection the infinite cylinder with [**Ctrl**] + Left mouse click
- The 2 selected bodies divides the space into 4 zones

- | | | |
|---|---------|-----------|
| 1 | +sphere | +cylinder |
| 2 | +sphere | -cylinder |
| 3 | -sphere | +cylinder |
| 4 | -sphere | -cylinder |

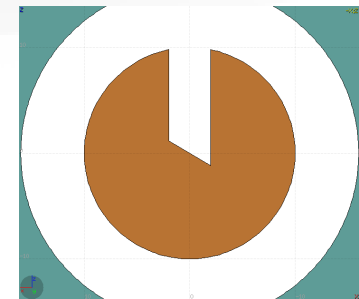
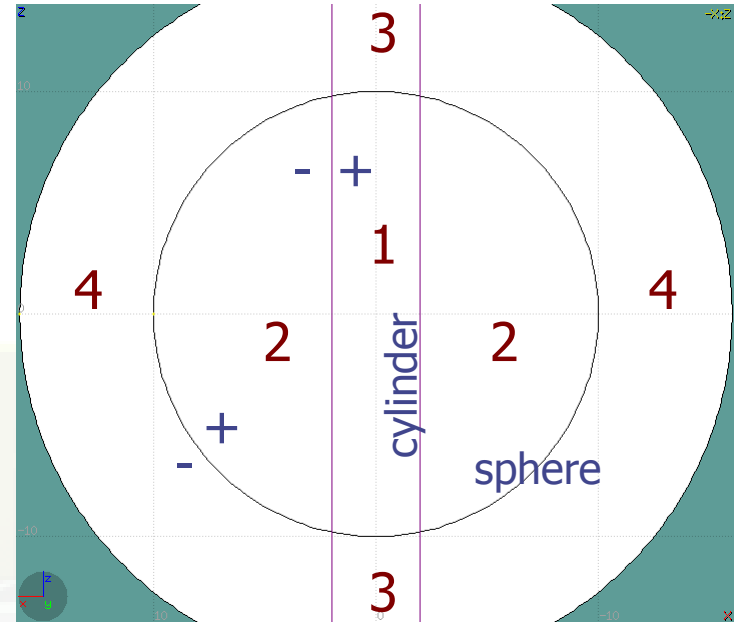

Reference image

Zone Editing: Example [4/7]

- Add to the selection [**Ctrl**]+left click the tilted plane.
- Now the space is divided into 8 zones

- | | | | |
|---|----------|------------|---------|
| 1 | +sphere | +cylinder | +plane |
| 2 | +sphere | +cylinder | - plane |
| 3 | +sphere | - cylinder | +plane |
| 4 | +sphere | - cylinder | - plane |
| 5 | - sphere | +cylinder | +plane |
| 6 | - sphere | +cylinder | - plane |
| 7 | - sphere | - cylinder | +plane |
| 8 | - sphere | - cylinder | - plane |

Number of valid zones $\leq 2^{\text{bodies}}$

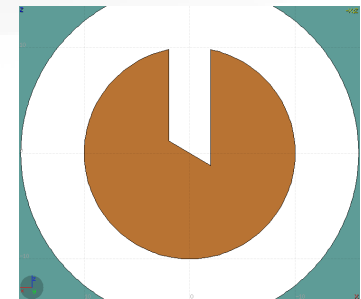
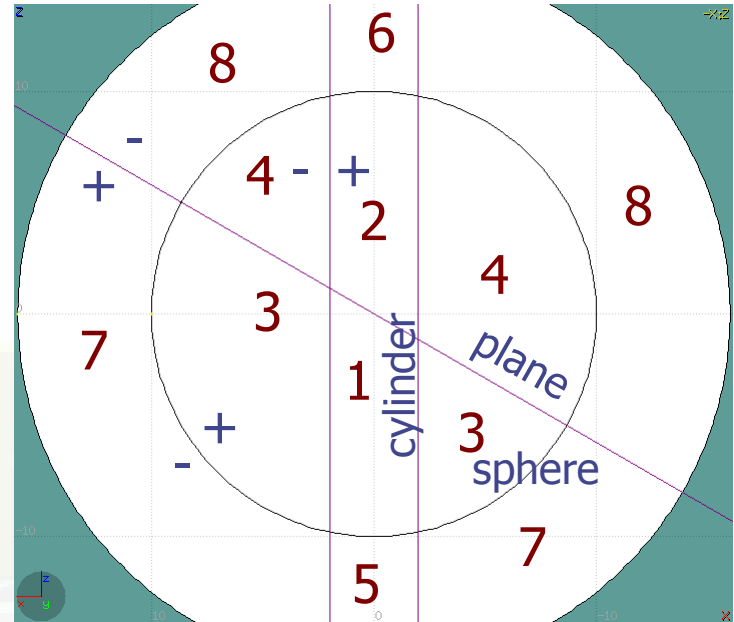

Reference image

Zone Editing: Example [5/7]

- Press [**Spacebar**] and select the action **Zone**  or with the shortcut [**d**]efine
- Moving the mouse, shows the various subdivisions of space and their corresponding expression.
- Point and click with the mouse somewhere inside zone **4**
- Automatically the zone expression
+sphere -cylinder -plane
will be added to the **REGION**

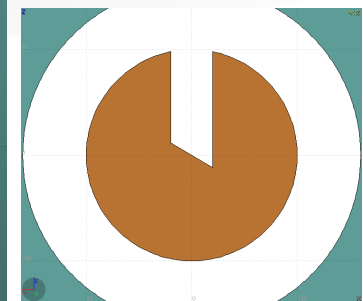
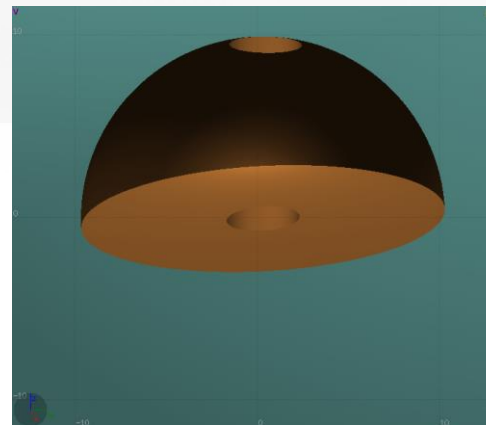
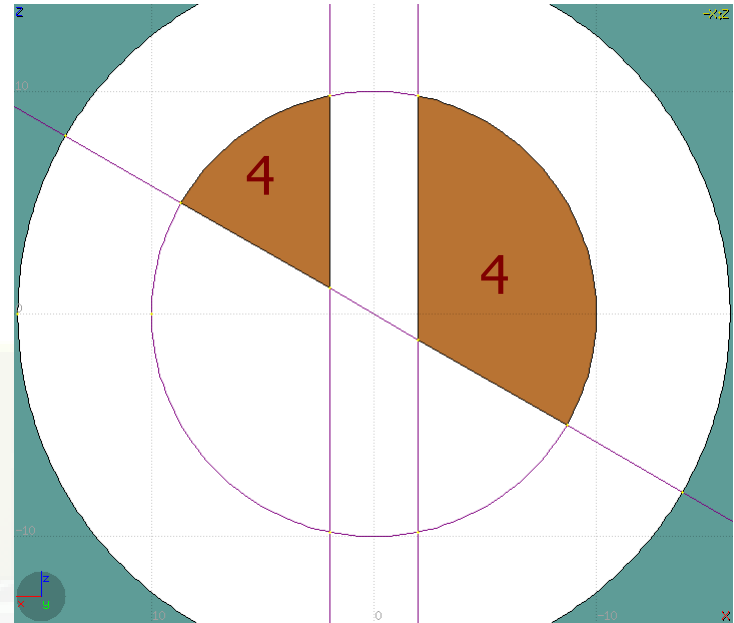

Reference image

Zone Editing: Example [6/7]

- Finally we have to add as second zone the lower half of the sphere.
- Press once **[ESCape]** to unselect the bodies, but to **leave the region selected**
- Select the sphere and plane (or by deselecting the cylinder)
- Again the space is divided into 4 regions

- | | | |
|---|----------|---------|
| 1 | +sphere | +plane |
| 2 | +sphere | - plane |
| 3 | - sphere | +plane |
| 4 | - sphere | - plane |

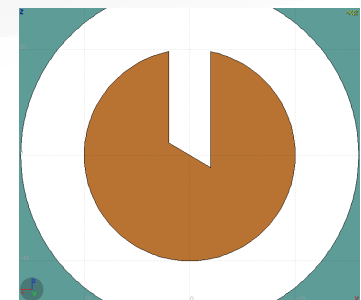
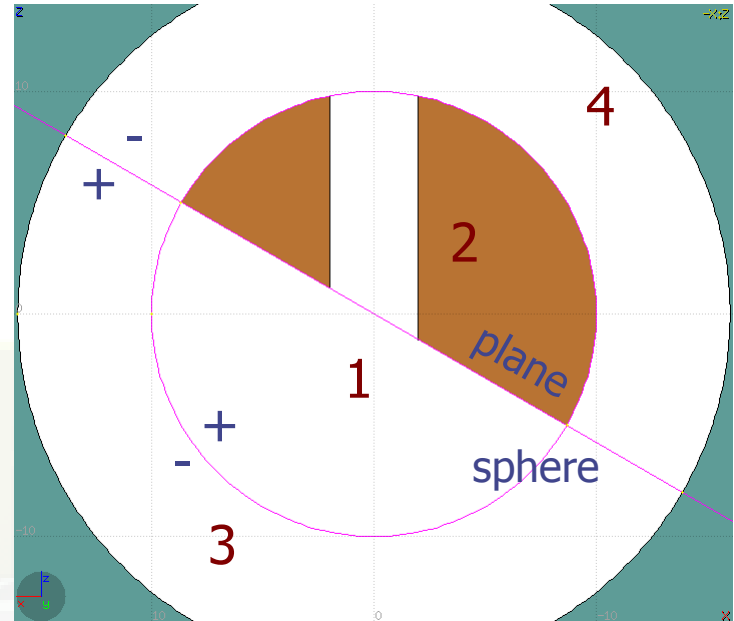

Reference image

Zone Editing: Example [7/7]

- Press [**Spacebar**] and select the action **Zone**  or with the shortcut [**d**]
- Point and click with the mouse somewhere inside zone **1**
- Automatically the zone expression
+sphere +plane
will be appended to the REGION

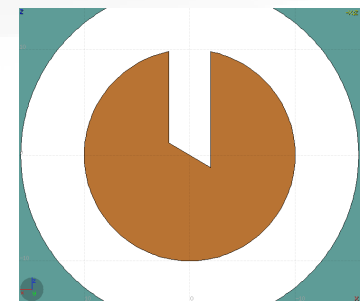
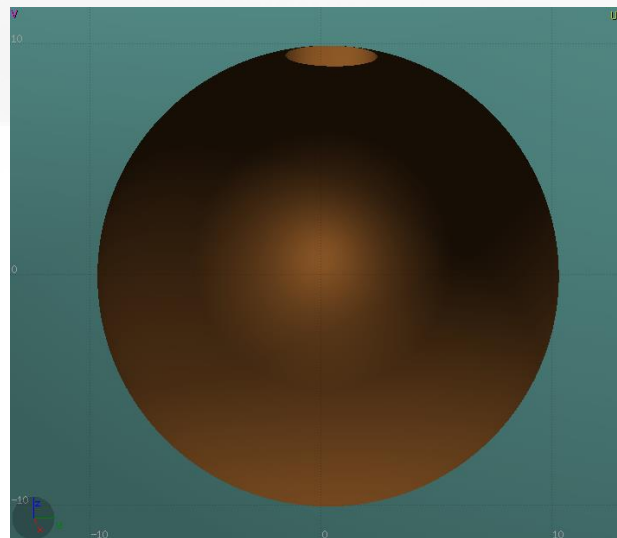
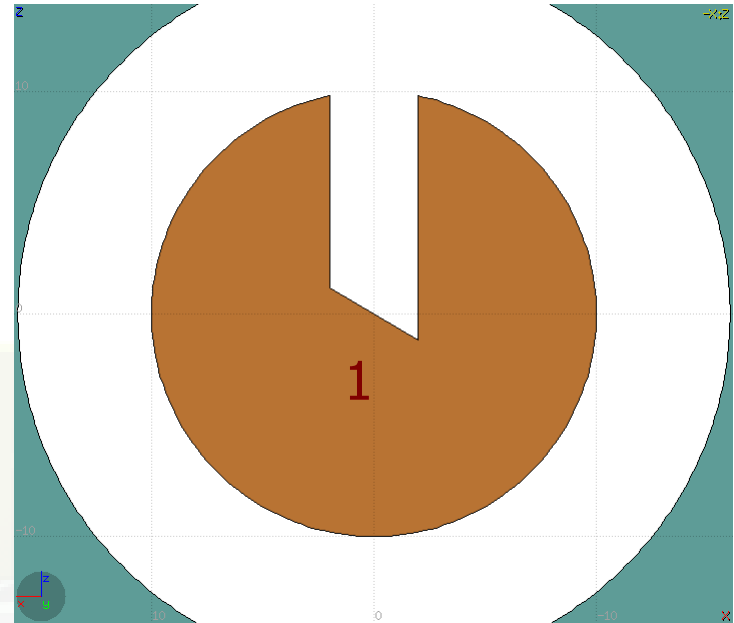

Reference image

Summary: Region and Zone Editing

Remember the sequence:

1. **Create** or **Select** the region to edit
2. Select the **REGION** if not selected
3. Select a **zone to modify** or **none to add** a new one
4. **Add on the selection the bodies** that involve in the zone expression
5. Click on the [**Spacebar**] "Zone▲" action [**d**] or [**D**]
6. Move the mouse and click to a point that belongs to the wished zone
7. Repeat steps 2-6 as many times as required



You have to create a selection containing:

- the **REGION** to edit;
- the **bodies** representing the boundaries of the new zone;
- **optionally an existing zone** if you want to modify it
- Verify the selected items and do NOT select bodies that you don't need

Geometry Layers [1/7]

Custom Layers can be specified in the "Configure Layer menu" ()

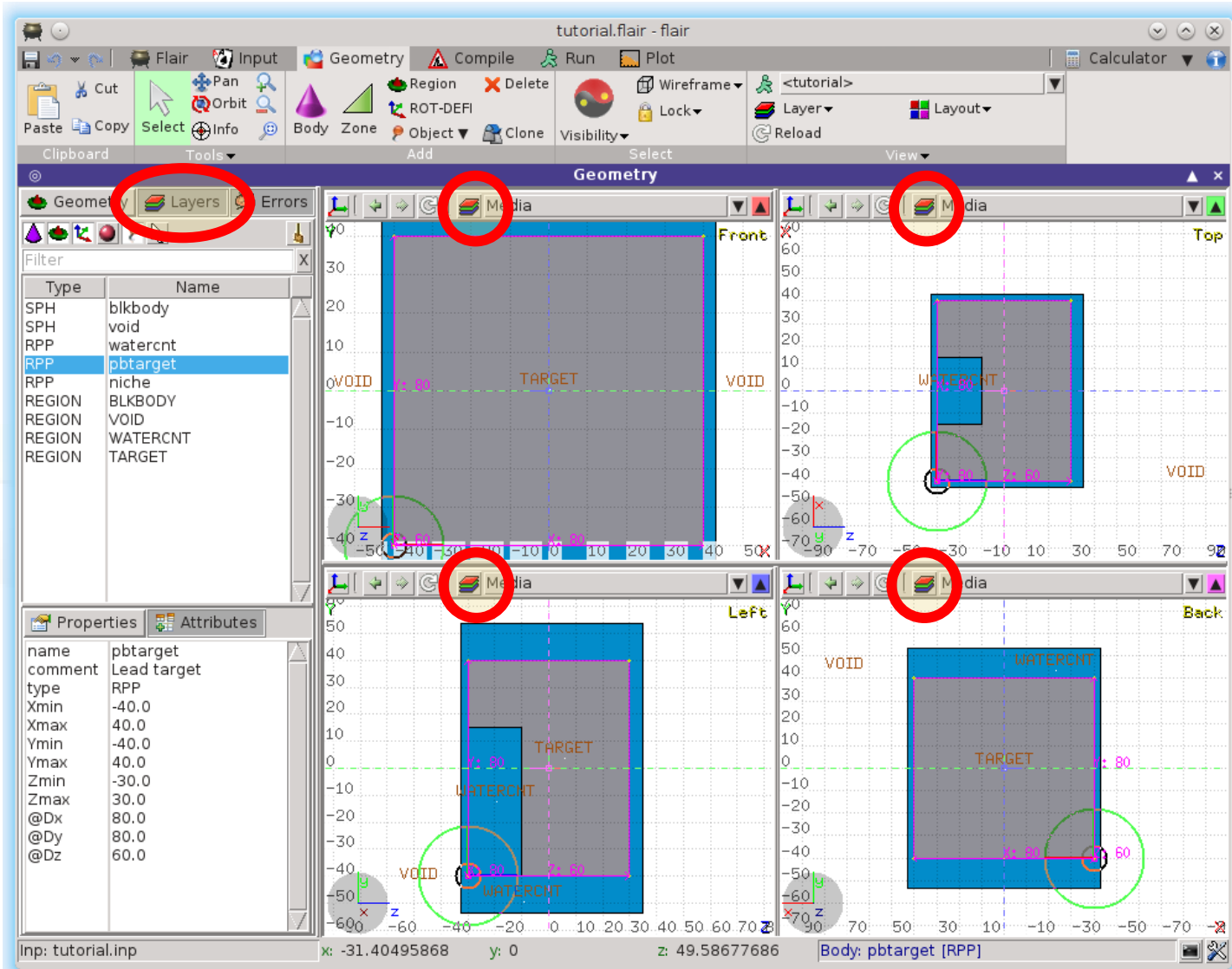

The screenshot displays the Flair software interface with the Geometry Layers menu open. The menu is highlighted with a red circle. The main window shows four 3D views (Front, Top, Left, Back) of a target assembly. The assembly consists of a central 'TARGET' region (RPP) surrounded by 'VOID' regions, and a 'WATERCNT' region (RPP) surrounding the target. The 'WATERCNT' region is highlighted with a green circle in each view. The 'TARGET' region is highlighted with a blue circle in each view. The 'VOID' regions are highlighted with a grey circle in each view. The 'Layer' menu is also highlighted with a red circle in each view. The 'Properties' panel at the bottom left shows the properties for the selected 'pbtarget' region.

Type	Name
SPH	blkbody
SPH	void
RPP	watercnt
RPP	pbtarget
RPP	niche
REGION	BLKBODY
REGION	VOID
REGION	WATERCNT
REGION	TARGET

Property	Value
name	pbtarget
comment	Lead target
type	RPP
Xmin	-40.0
Xmax	40.0
Ymin	-40.0
Ymax	40.0
Zmin	-30.0
Zmax	30.0
@Dx	80.0
@Dy	80.0
@Dz	60.0

Geometry Layers [2/7]

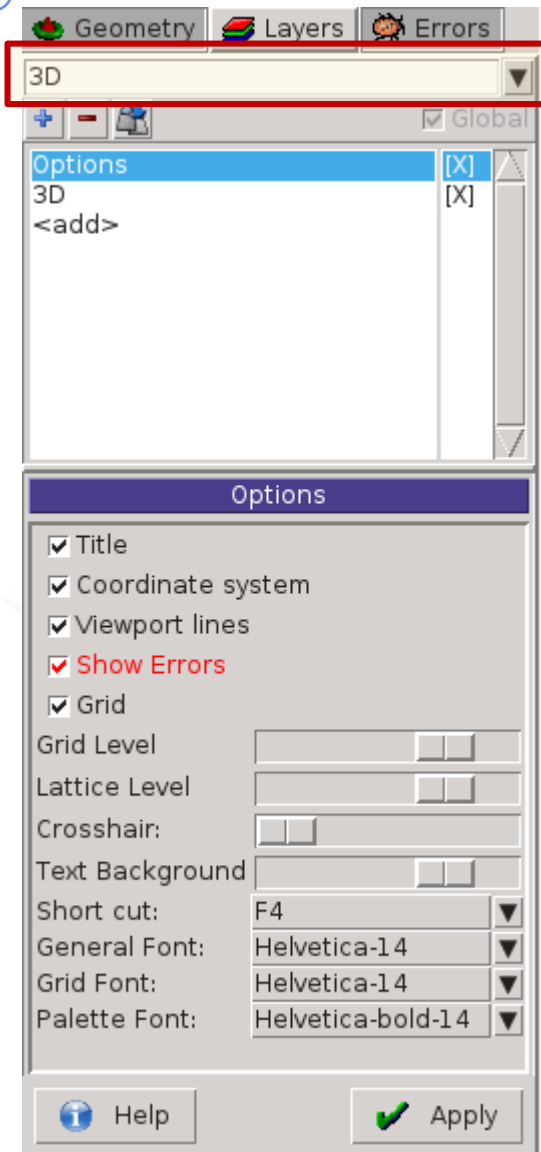

Toolbar:

- **Add/delete/rename/clone layers.**

Options:

- **Enable/Disable:** Title, Coordinate system, Viewport lines, Vertexes and Grid;
- **Adjust:**
 - **Grid level** (set gridline intensity);
 - **Lattice level** (set lattice hash line intensity);
 - **Crosshair** (dimension of the crosshair in the center of the project)
- All layers can be combined together e.g:
 - USRBIN and 3D
 - Custom color values (EMFCUT) with 3D
 - Image and USRBIN
 - ...

Geometry Layers [3/7]



Show: (2D drawing, and color filling options)

- **Bodies**: display the boundaries of bodies;
- **Vertices**: display the intersection of bodies;
- **Enable/Disable**: Lattice and Voxel;
- **Associate Region Colors to:**
 - Regions
 - Materials
 - Density
 - Importance Biasing
 - Splitting
 - Corrfactor
 - Deltaray
 - Thresholds
 - ...

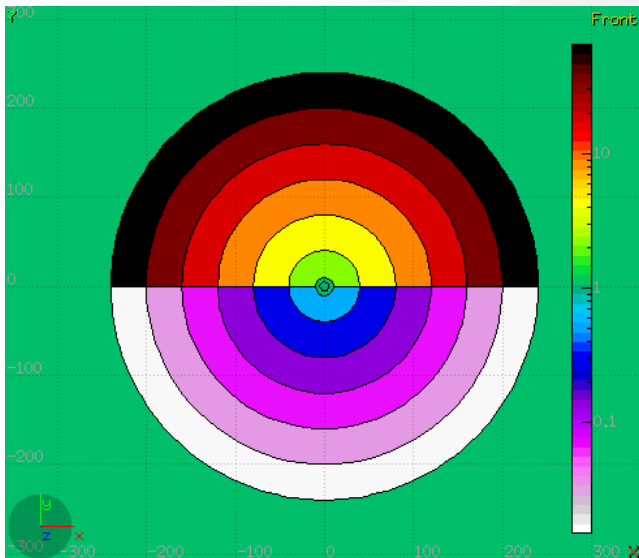

Geometry Layers [4/7]

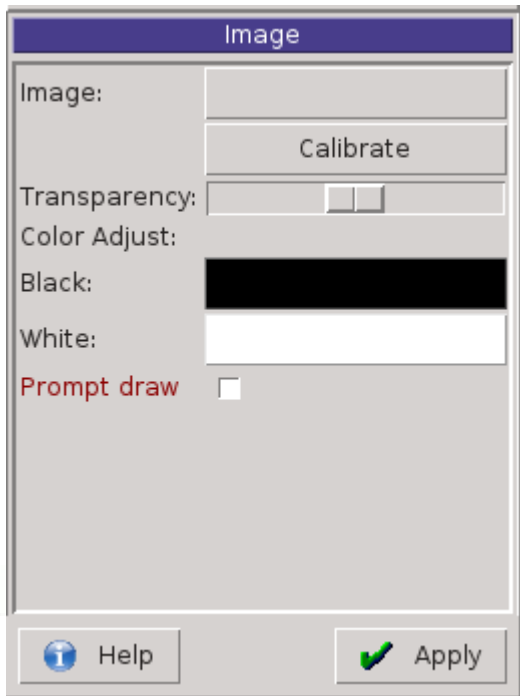
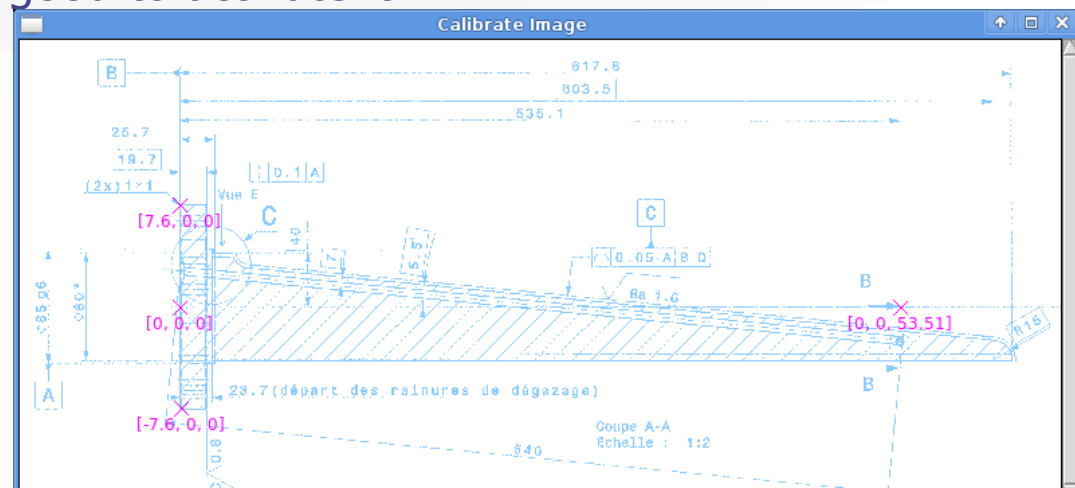
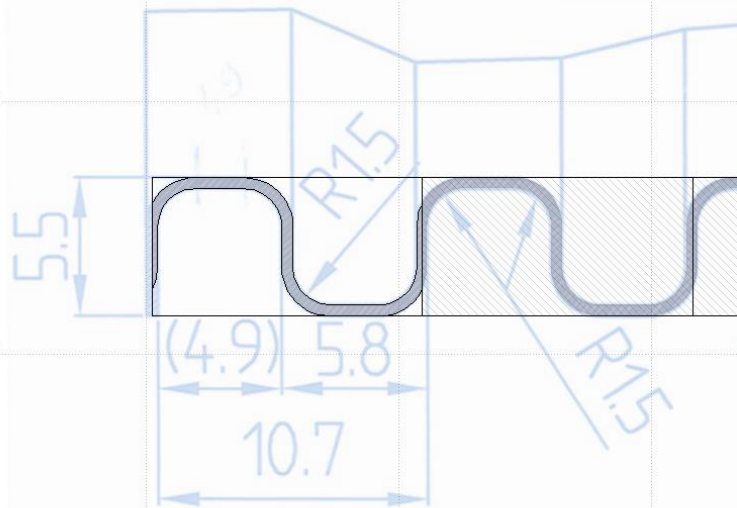
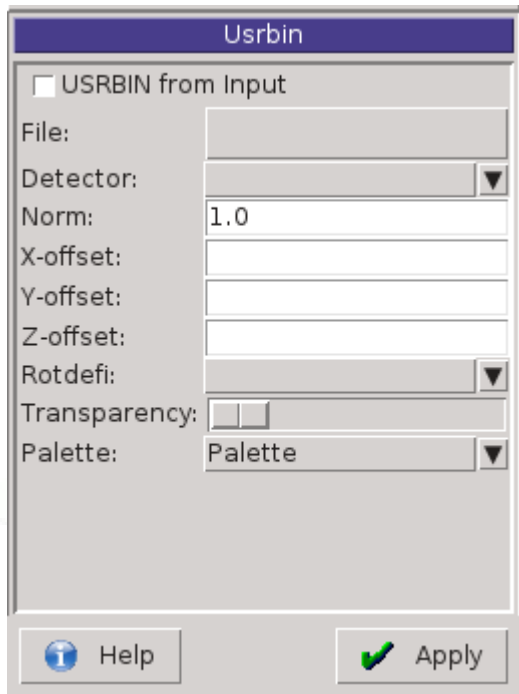

Image: set a background image to the geometry (i.e. a CAD-drawing);

- **Image**: load an image file (.png, .gif or .jpg);
- **Calibrate**: calibrate the image. Define a set of points (min. 3) on the image and specify their coordinate;
- **Alpha**: blending of the image
- **Color Adjust**: readjust the **black** and **white** colors of the loaded image.
- **Prompt draw**: immediate drawing of image (slower) or when display is idle. For editing is good to activate it.



Geometry Layers [5/7]



USRBIN:

- Up to 10 USRBINS can be superimposed per layer
- USRBIN from input: To select a USRBIN card from input and displayed with a checker pattern
- Load **USRBIN file** (see SCORING lecture);
- Select a **detector** (or USRBIN) among the ones present in the file;
- **Normalization** constant;
- Associate a **ROT-DEFI** transformation;
- Alpha blending between USRBIN colors and materials colors



USRBIN should be combined with the Colorband to define the color limits

Geometry Layers [6/7]

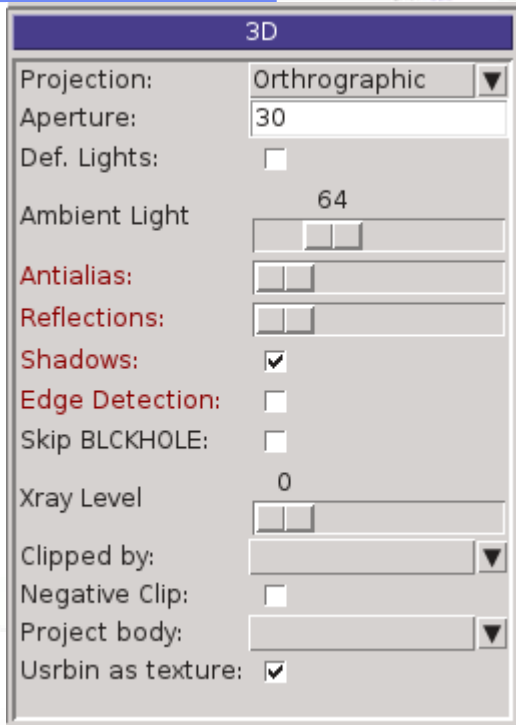

3D: enable 3D rendering

- **Enable/Disable Perspective;**
- Set camera **aperture** angle;
- Intensity of ambient light;
- **Antialias** for supersampling (slow rendering);
- Xray – automatic transparencies;
- Clipped by: setting a clipping body;
- Negative Clip: Use the –clipping body

Colorband: enable/set color band properties

- Change the default color **Palette;**
- **Enable/Disable Log** scale;
- **Set: Maximum, Minimum** and color **steps.**

Geometry Layers [7/7]

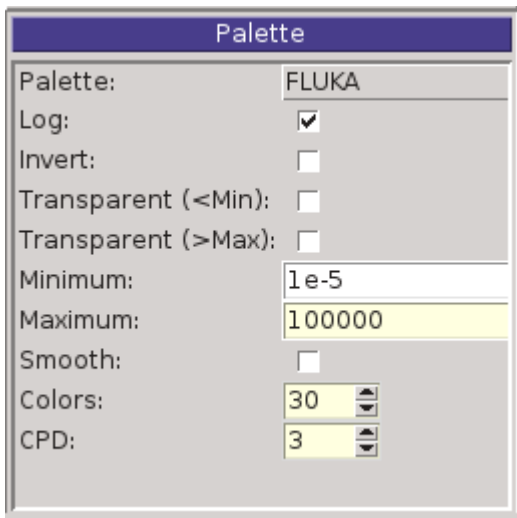

Palette: enable/set color band properties

- Up to 3 palettes can be used per layer
- Change the default color **Palette**;
- **Enable/Disable Log** scale;
- Enable transparency outside the limits useful when combining multiple USRBIN's
- **Set: Maximum, Minimum** and color **steps**.

ESCape

[**ESC**ape] will stop/unselect in the following order on item at a time:

1. Stop the current action e.g. during rotation or panning
2. If a zone is selected unselected the zone
3. Unselect any selected bodies
4. Unselect any selected region

FLUKA