



Greek Teachers Programme 2016

Energy & Power Conversion

Konstantinos Papastergiou | Technology Department
CERN – European Organisation for Nuclear Research



1897

Ανακάλυψη ηλεκτρονίου

Nobel 1906, Jonathan J. Thomson, Cambridge Cavendish Laboratory

Summary

➔ **Energy consumption at CERN**

- ⇒ How is energy used?
- ⇒ Electricity, Water and Gas

➔ **From Electrical to Kinetic Energy**

- ⇒ How is electricity converted to acceleration?

➔ **Key electrical consumers?**

- ⇒ Components with power requirements

➔ **Electronics and Power Electronics**

- ⇒ What is the difference

➔ **Power Conversion Principle**

- ⇒ Why and how is energy converted

➔ **Accelerator Power Electronics**

- ⇒ Real world systems – how do they look

➔ **Research Challenges**

- ⇒ The future in powering accelerators

CERN και ενέργεια

Electricity at CERN

- ➔ Interconnections to both France and Switzerland
- ➔ Approximately 80% of electricity from France
 - ⇒ French Energy mix: 75% Nuclear, 16% Hydro, Thermal 9%
- ➔ 1000 high voltage circuit breakers in operation
- ➔ Consumption
 - ⇒ as high as all households in Geneva area
 - ⇒ 1/10th of the canton (11.3TWh).

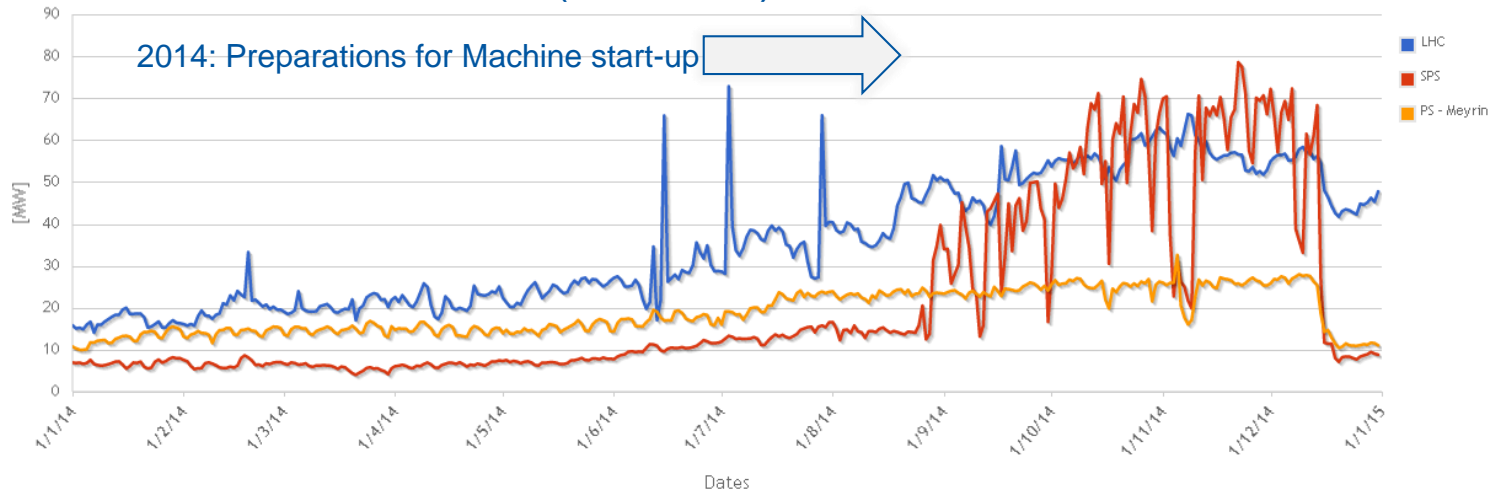

Energy Facts & Figures

- ➔ **Total consumption 1 230 000 000 kWh/yr (at home ~ 11 000kWh/yr)**
 - ⇒ 43% consumed by the LHC
 - Up to 14% by superconductive magnet cooling
 - Up to 9% equipment cooling and tunnel ventilation
 - ⇒ 11% by its Experiments
 - ⇒ 30% by SPS
 - 7% at its Experiments
 - ⇒ 3% PS-booster-Linac
 - ⇒ 6% Data Centres
 - ⇒ 7% in offices, restaurants etc.

Water

- ➔ 5 million m³ of water mainly from the lake
- ➔ Closed circuit of demineralised water and secondary circuit of raw water cooled in cooling towers.
- ➔ Industrial process water
 - ⇒ Surface treatment
 - ⇒ Production of demineralised water

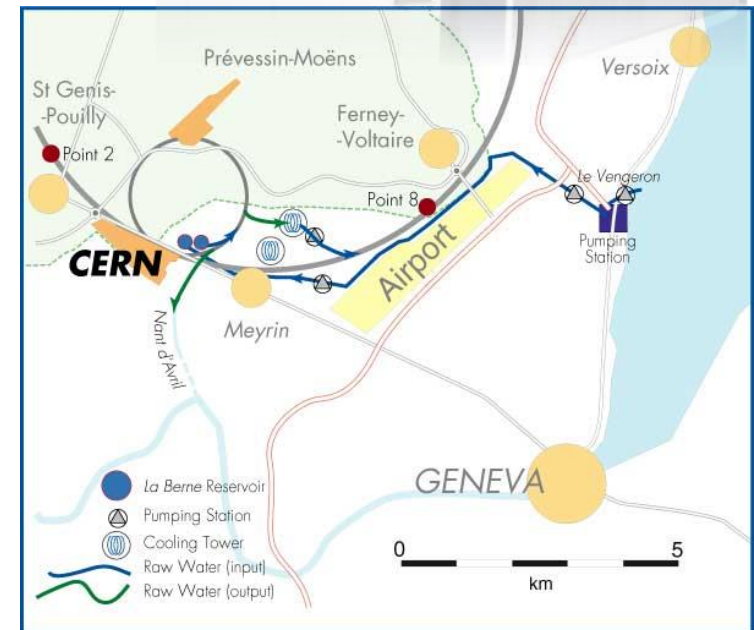





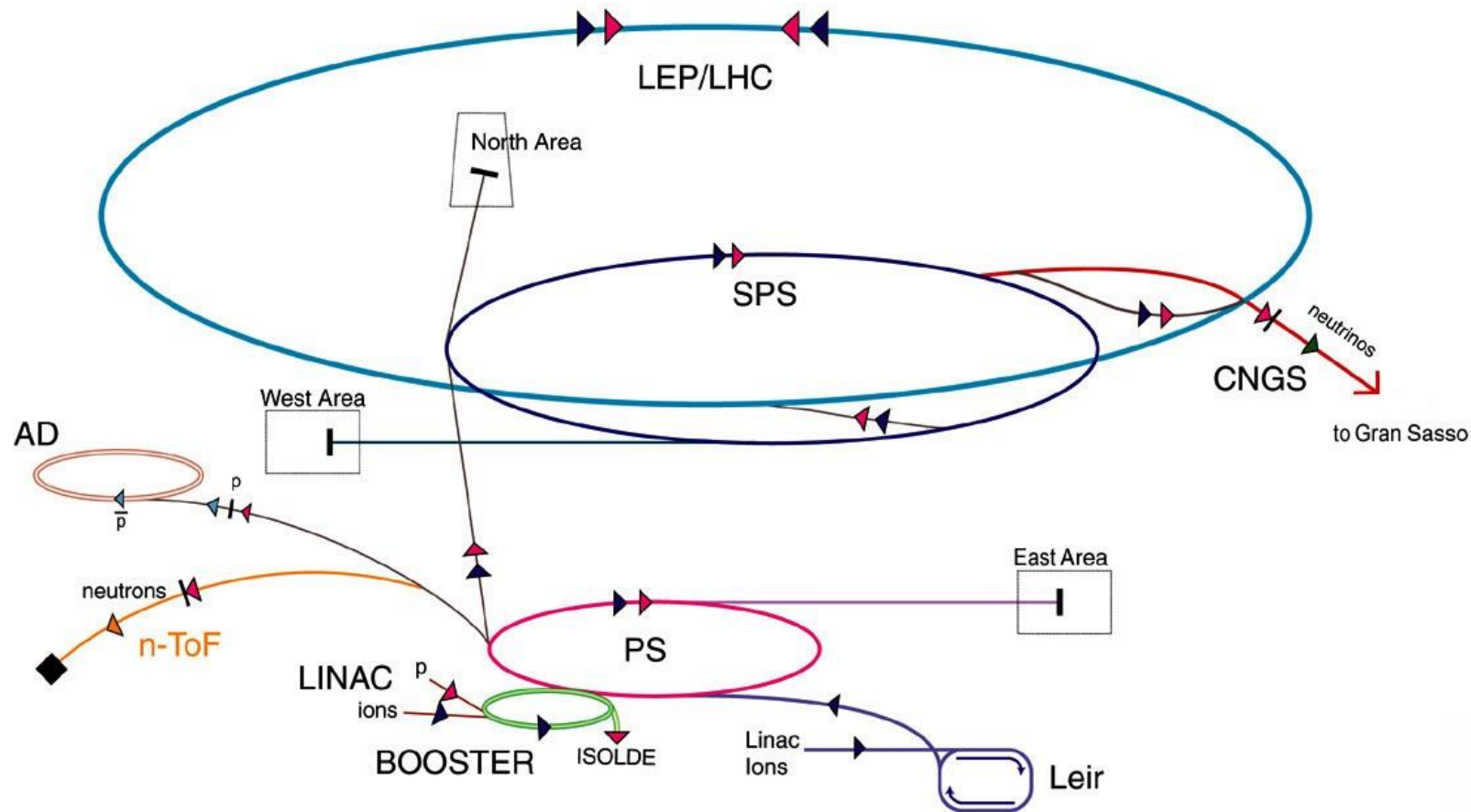

Natural Gas

- ➔ Heating stations at Meyrin 8 million m³
- ➔ Heating station at Preveessin – 1.5million m³
- ➔ Operated by external companies
 - ⇒ Monitor dust, CO, CO₂, nitrogen oxides and sulphur oxides

η ενέργεια στους επιταχυντές

Accelerators at CERN



-  p (proton)
-  ion
-  neutron
-  \bar{p} (antiproton)
-  proton/antiproton conversion
-  neutrino

- AD Antiproton Decelerator
- PS Proton Synchrotron
- SPS Super Proton Synchrotron

- LHC Large Hadron Collider
- n-ToF Neutron Time of Flight
- CNGS Cern Neutrinos Gran Sasso

Key Energy Consumers

➔ Direct Energy to the beam

⇒ RF cavities - Klystron

⇒ Magnets

➔ Environmental Conditioning

⇒ Cryogenics

⇒ Systems cooling

⇒ Tunnel air filtering

➔ Data

⇒ Measurements

⇒ Processing

➔ Infrastructure

➔ Other

(c) Rey.Hori / KEK

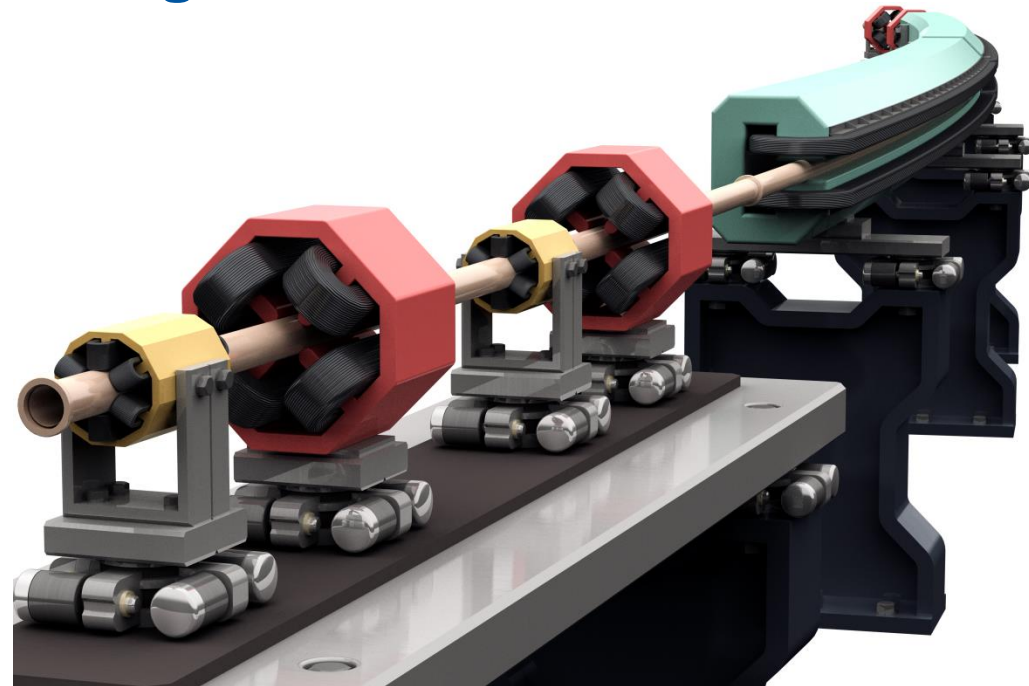

Cryogenics

- ➔ Cryogenic pumps are the largest single electrical consumer at CERN
- ➔ Peak power: 50MW
- ➔ 6 weeks to cool down Helium to 1.8K to 4.2K



Force on Charged Particle

The force on a charged particle is proportional to the charge, the electric field, and the cross product of the velocity vector and magnetic field:

Lorenz force:

$$\vec{\mathbf{F}} = q \cdot (\vec{\mathbf{E}} + \vec{\mathbf{v}} \times \vec{\mathbf{B}})$$

Where q is the electrons' (positrons', protons'...) elementary charge:

$$q = e_0 = 1.602 \cdot 10^{-19} \text{ [C]}$$

For conservative forces (work done independent of the path) the work done by a force F along the path $s_1 \rightarrow s_2$ transversed by the particle is:

$$\Delta E = \int_{s_1}^{s_2} \vec{\mathbf{F}} \cdot d\vec{\mathbf{s}}$$

by differentiating:

$$\frac{\Delta E}{dt} = q \cdot (\vec{\mathbf{v}} \cdot \vec{\mathbf{E}} + \vec{\mathbf{v}} \cdot (\vec{\mathbf{v}} \times \vec{\mathbf{B}})) = q \cdot \vec{\mathbf{v}} \cdot \vec{\mathbf{E}}$$

Conclusion the magnetic field does not produce any work on the direction of the vector travelled by the charged particle. Energy (acceleration) is only gained under the effect of electric field.

RF Cavities - Klystron

Functions:

- Particle acceleration

$$\Delta E = \int_{s1}^{s2} \vec{F} \cdot d\vec{s} = q \cdot \int_{s1}^{s2} \vec{E} \cdot d\vec{s} = q \cdot U$$

* The rhythm of energy build up depends on the particles' charge and the electric field voltage

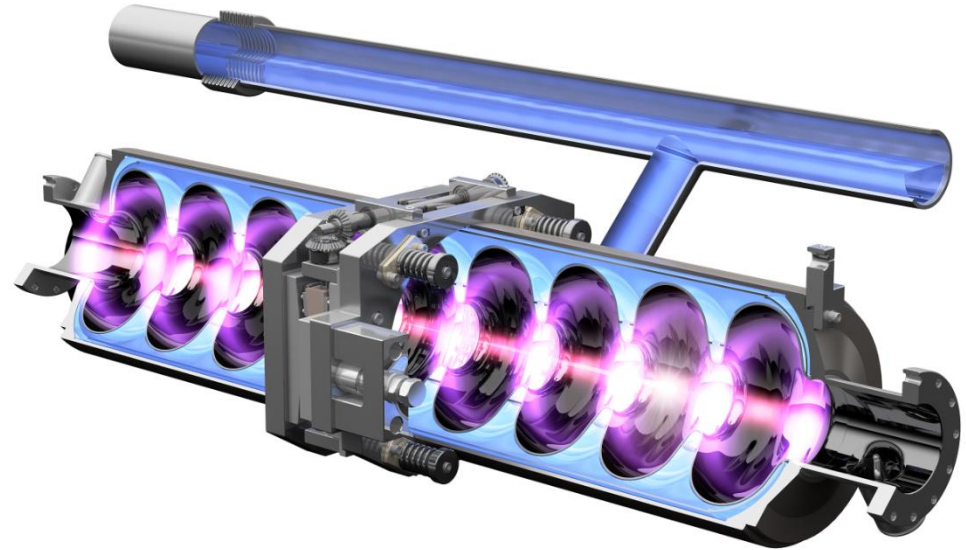

(c) Rey Hori / KEK

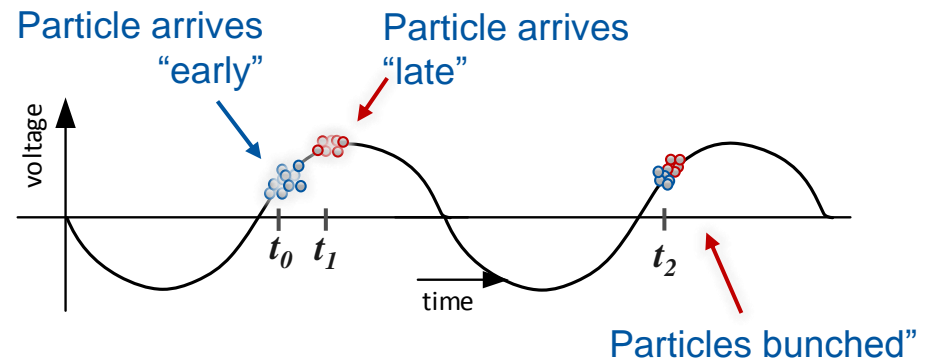
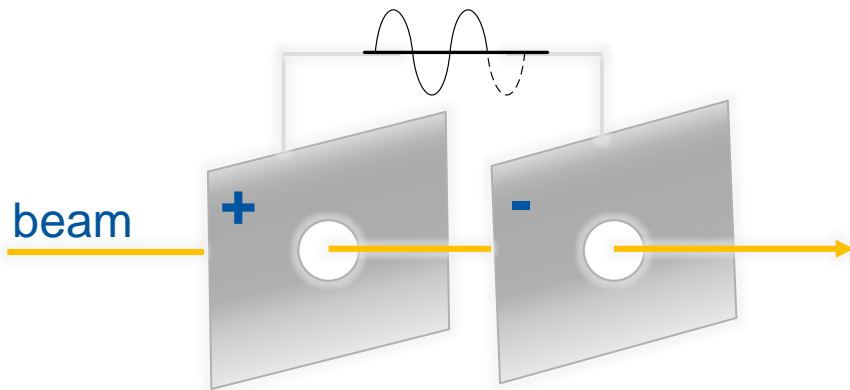

Electro-magnets

Functions:

- Beam steering

$$\vec{F} = q \cdot (\vec{v} \times \vec{B})$$

- At first sight F is not dependent on mass
- Since v on a circle of radius $\rho \rightarrow F = \text{centripetal force}$

$$\vec{F} = q \cdot (\vec{v} \times \vec{B}) = m_r \cdot \vec{a}_C = \frac{m_r \cdot v^2}{\rho}$$

$$m_r = \gamma \cdot m_0$$

* γ : lorenz factor ($\gamma=1/(1-v^2/c^2)$)

- Rearranging yields the beam rigidity i.e. a measure of the force needed to bend the charge direction
- And the bending angle inside a magnet field

$$\vec{B} \cdot \rho = \frac{m \cdot v}{q} = \frac{p}{e}$$

$$a = \frac{\int \vec{B} \cdot ds}{B \cdot \rho}$$

- The integrated field is a magnet property also given by Amperes law:

$$\oint_C \vec{B} \cdot ds = \mu_0 \cdot \iint_A \vec{J} \cdot dA = \mu_0 \cdot I_C$$

* μ_0 : magnetic permeability of the air

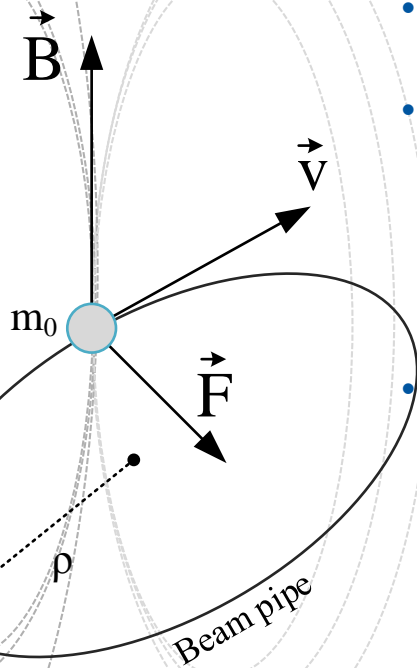

Dipole magnet

Functions:

- Beam steering
- Stores energy $E=0.5 L I^2$
- Consumes power $P=I^2 R$

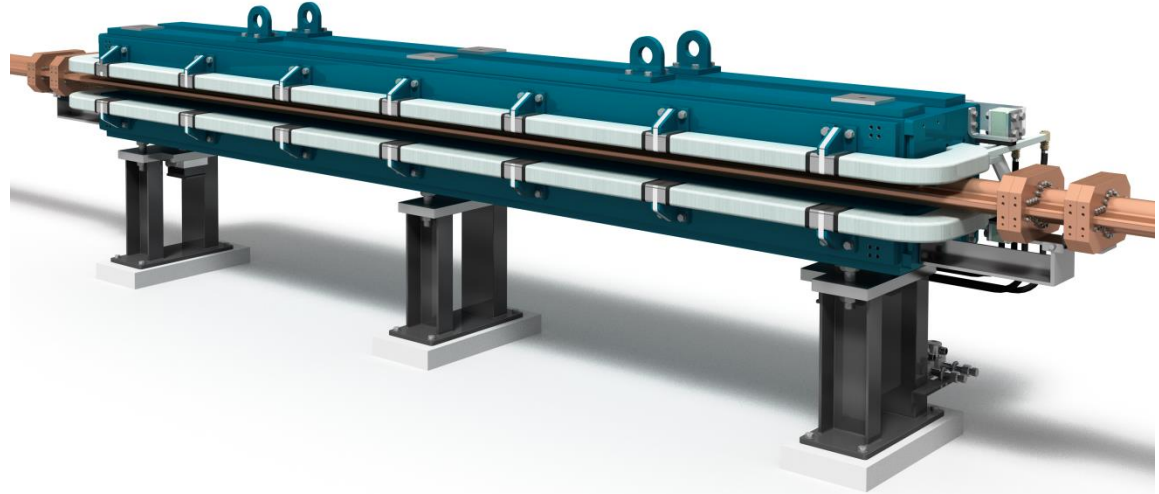

(c) Rey Hori / KEK

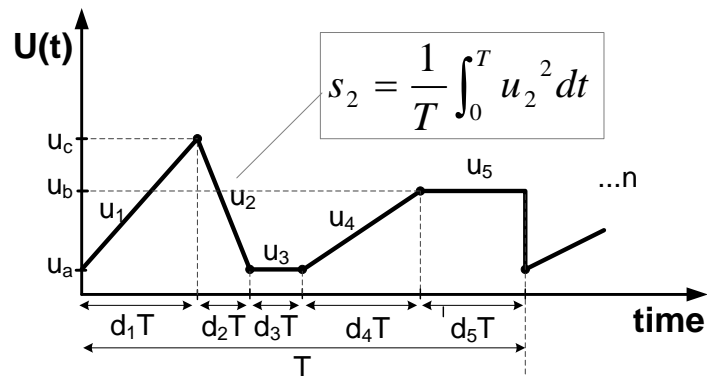

Quadrupole magnets

Functions:

- Focussing-defocussing

Two particles enter in the accelerator with different velocity vectors:

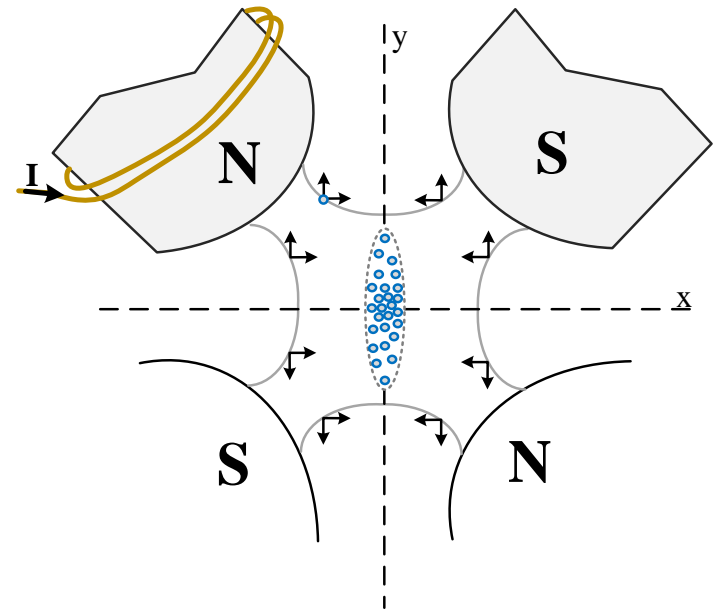
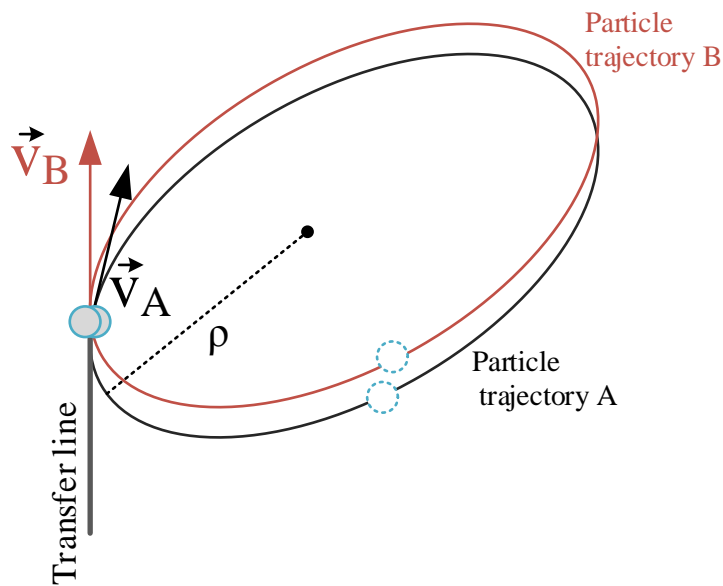

Betatron Oscillation

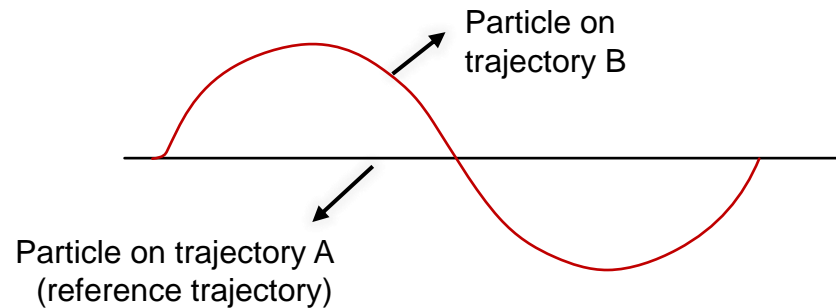

1880s

the war of currents

Thomas Edison VS George Westinghouse

➔ Direct VS alternating current

➔ AC has two key advantages

- ⇒ Voltage/current can be transformed
- ⇒ Current can be interrupted

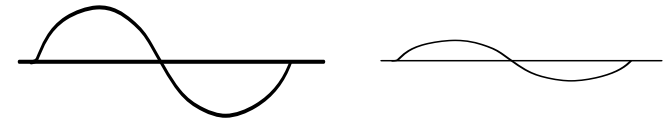

➔ Whereas DC is:

- ⇒ Less dangerous* but
- ⇒ May not be interrupted with standard switches
- ⇒ Could not be transmitted in long distances due to the lack of dc transformers

➔ Westinghouse won the battle!!!

- ⇒ Alternating current is standard and can be transformed, transmitted to distances of several hundred kilometres and may be interrupted with standard mechanical breakers.
- ⇒ It took us a century to develop technology for handling DC currents!

* If compared to a similar voltage level 50Hz alternating current of which the fluctuations can induce arrhythmia and eventually result in ventricular fibrillation of the heart

Edisson VS Westinghouse

- ➔ Electrical power is $P_{\text{tot}} = \text{voltage (v)} \times \text{current (i)}$
- ➔ Using conductors to transmit power hence R_{copper}
- ➔ Power is lost on the way $P_{\text{loss}} = I^2 R$
- ➔ Hence useful power is $P_{\text{useful}} = P_{\text{tot}} - P_{\text{loss}}$

Notice! Ploss is a function of I and R. Decreasing I by a factor of 2 decreases power loss by 4

- ➔ 2 Solutions to save energy:
 - ⇒ Voltage rise -> voltage transformation
 - ⇒ resistance reduction-> superconductive conductors

Εισαγωγή στους Μετατροπείς Ισχύος

Electronics & Power Electronics

- ➔ Electronics is the art of manipulating the flow of electrons to perform certain functions
 - ⇒ Receive, transmit and store information
 - ⇒ Generate electromagnetic waves (heat, light)
 - ⇒ Convert electricity to kinetic energy (motors)

**Analog &
Digital Electronics**



Power Electronics



Power Conversion

- ➔ Electrical voltage needs to be transformed
 - ⇒ From direct to alternating current and the opposite
 - ⇒ From one voltage to another
 - ⇒ From one frequency to another

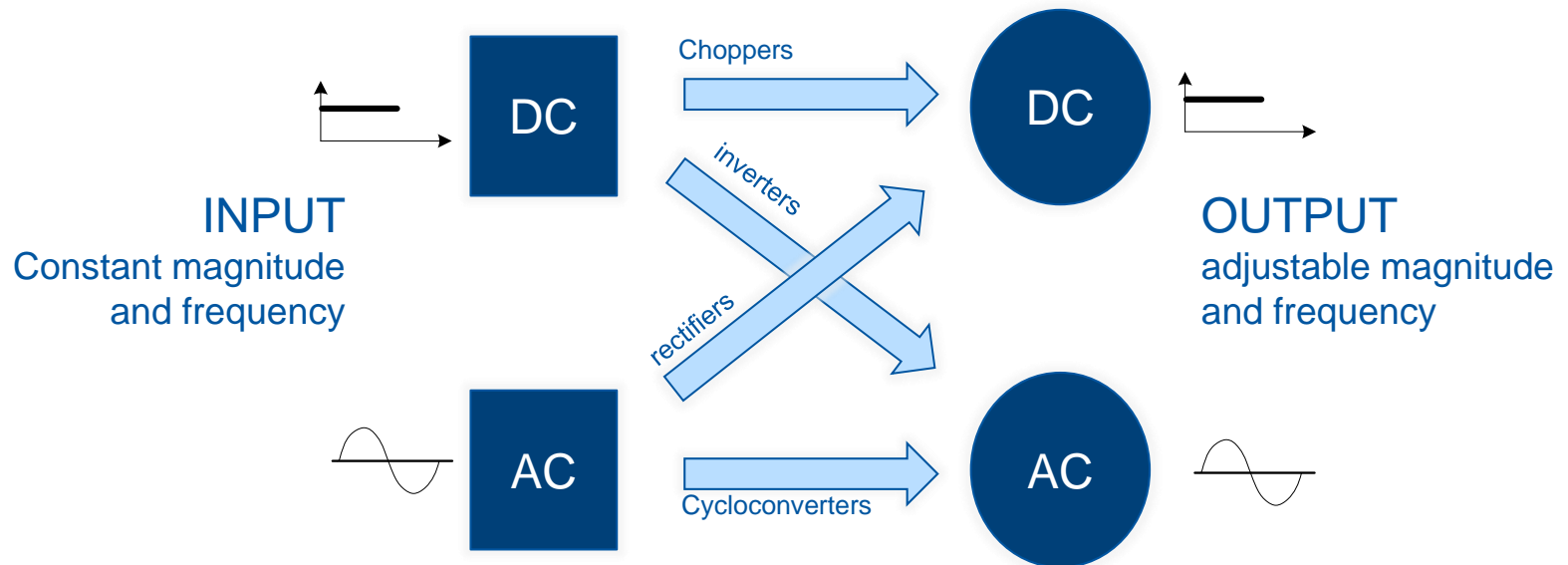

Power Converter Structure

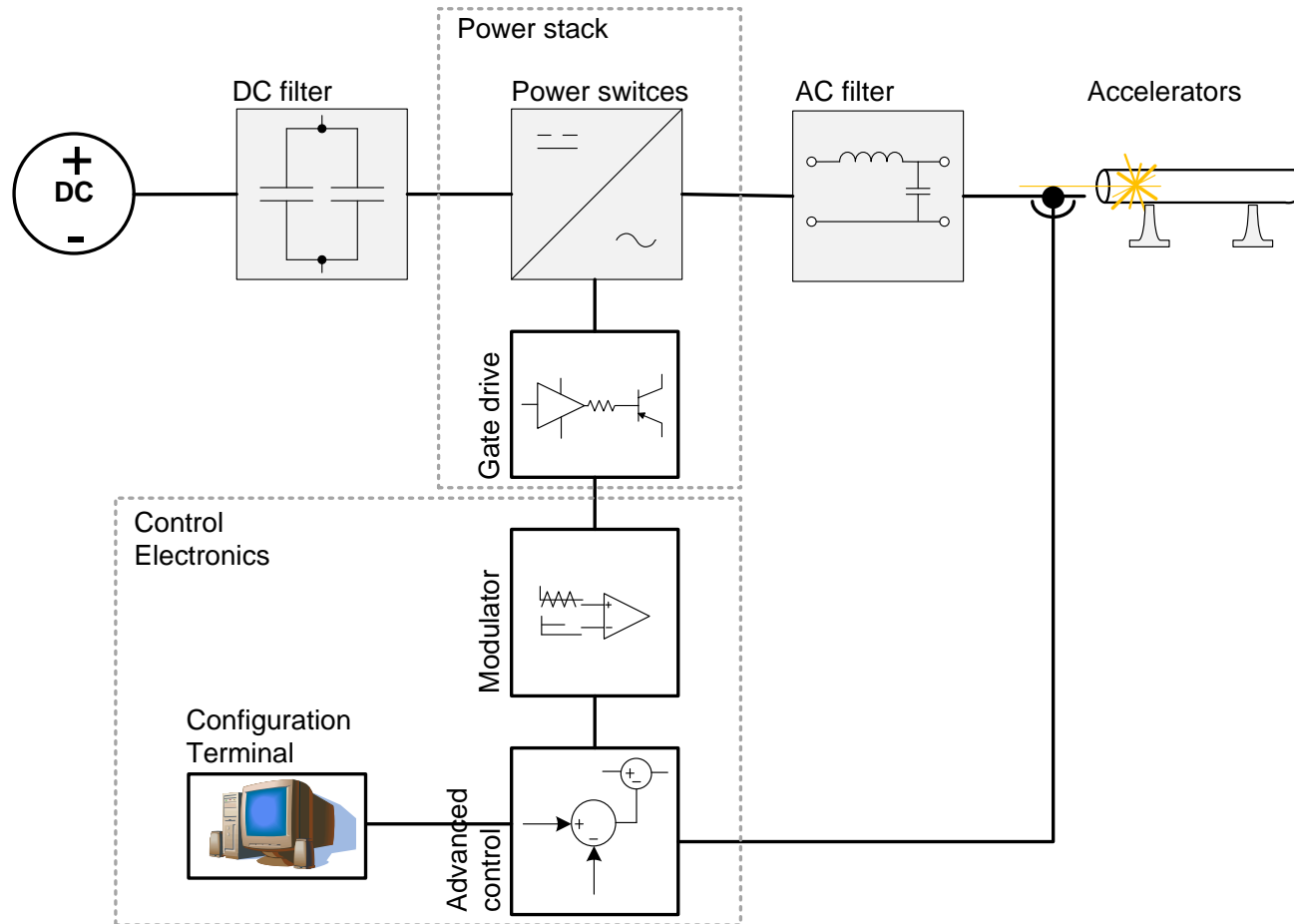

The basic power converter

- ➔ Voltage regulator operation based on switching on and off the input source with a duty cycle D .
- ➔ Inductor operates as averaging device

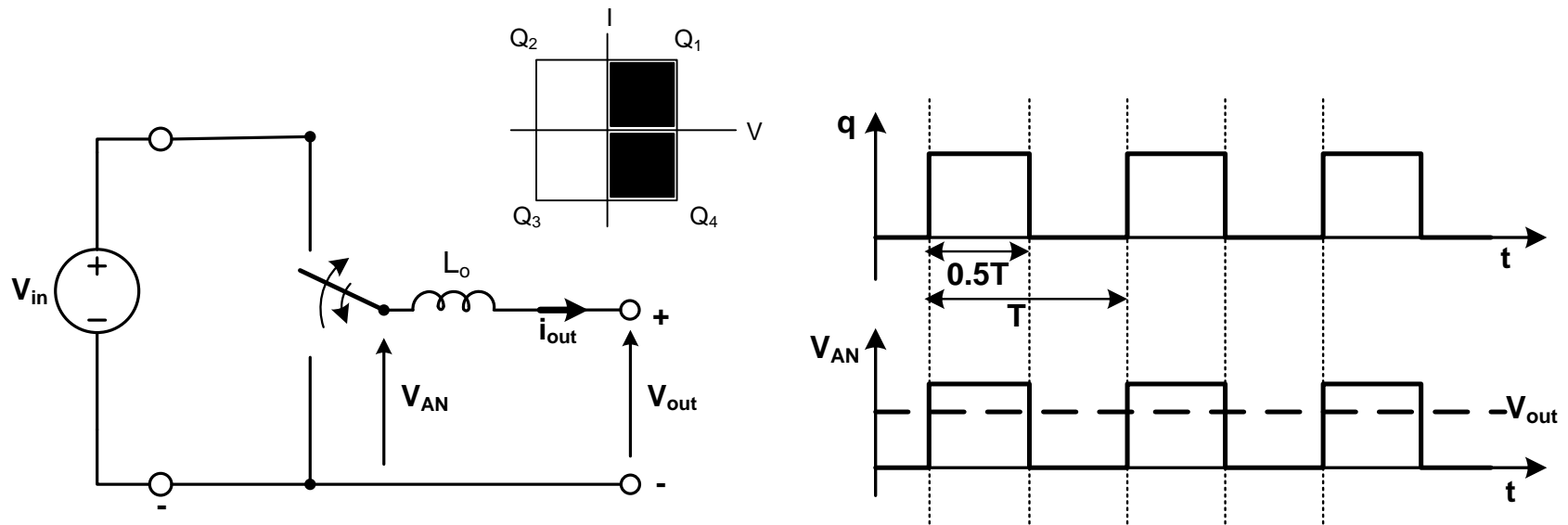

$$V_{out} = D \cdot V_{in} \quad 0 < D < 1$$

Power Semiconductors

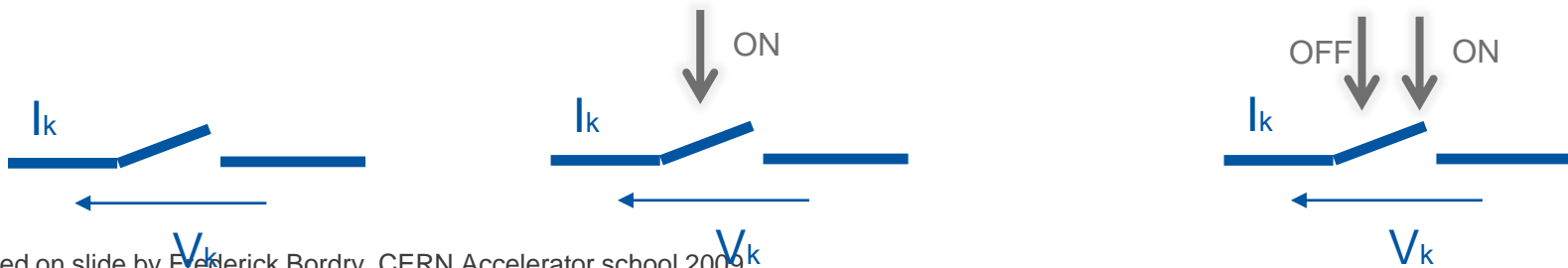
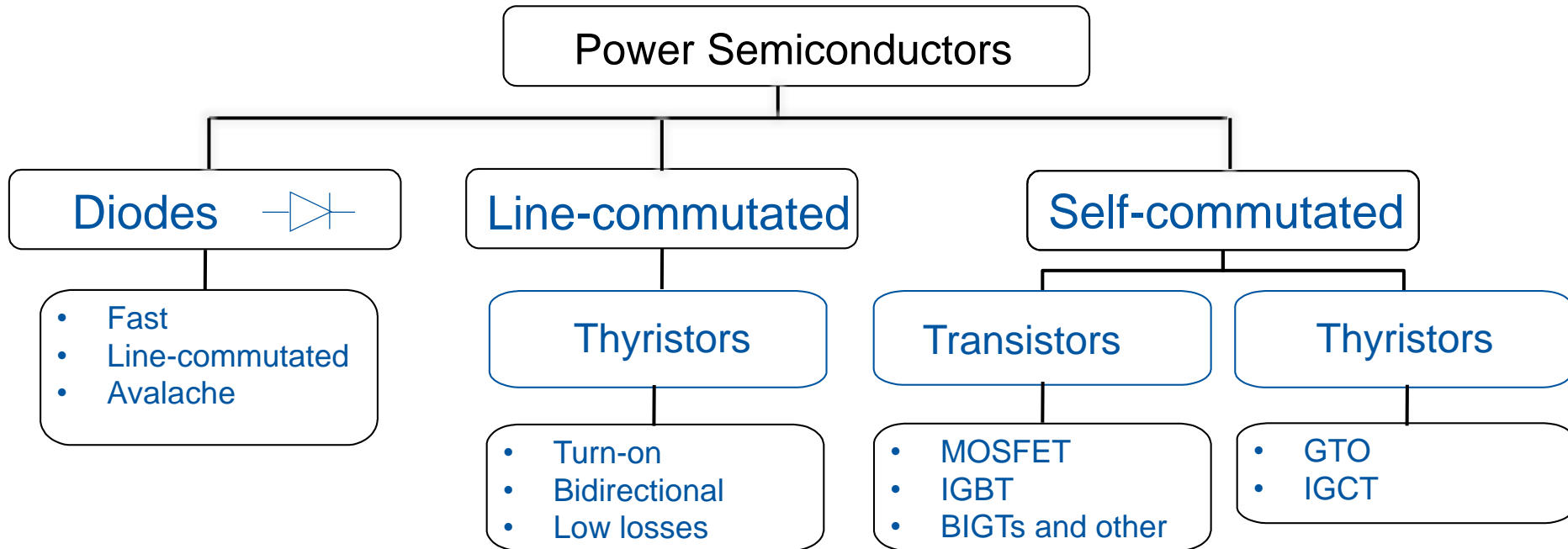

Based on slide by Frederick Bordry, CERN Accelerator school 2009

Modulation

- ➔ Control of the fundamental frequency component (AC or DC) by varying the switch duty ratio

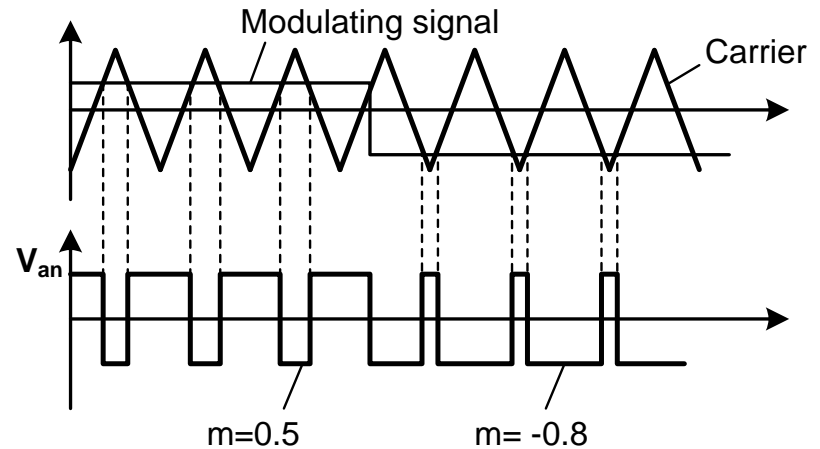
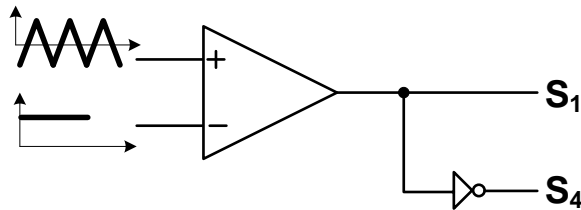

Figures of merit in PE

➔ Power conversion efficiency

⇒ Expresses the effective-ness of a converter in converting input power to useful output power (with less wasted power in the process)

$$n_c = \frac{P_{out,dc}}{P_{in}}$$

➔ Input Power factor

⇒ A high power factor typically indicates a lower input current for delivering a certian output power level. (as usually input sources have a stiff voltage magnitude)

$$\cos\varphi = \frac{P_{in}}{S_{in}}$$

➔ Ripple factor

⇒ Is a measure of the voltage or current ripple magnitude in dc voltage or current waveform

$$RF = \frac{V_{ac,rms}}{V_{dc}}$$

➔ Total Harmonic Distortion (THD)

⇒ is a measure of its RMS power of the harmonic components in comparison with the RMS power of the fundamental component of a voltage or current waveform.

$$THD = \frac{V_{h,rms}}{V_{1,rms}}$$

LHC – the Large Hadron collider

→ The beams are controlled by:

- 1232 SC Main Dipole magnets to bend the beams
- 392 SC Main Quadrupole magnets to focus the beams
- 124 SC Quadrupole / Dipole Insertion magnets
 - (in 196 circuits of ~ 6 kA)
- 6340 SC Corrector magnets
 - (in 1460 circuits 60 to 600A)
- 112 Warm magnets
 - (in 38 circuits 600 to 900A)
- SC RF Cavities to accelerate and stabilize the beam

All ~8000 magnets need to be powered in a very controlled and precise manner

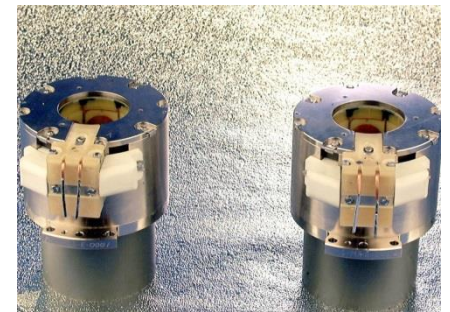

Current Regulation Precision

Current in a transfer line magnet

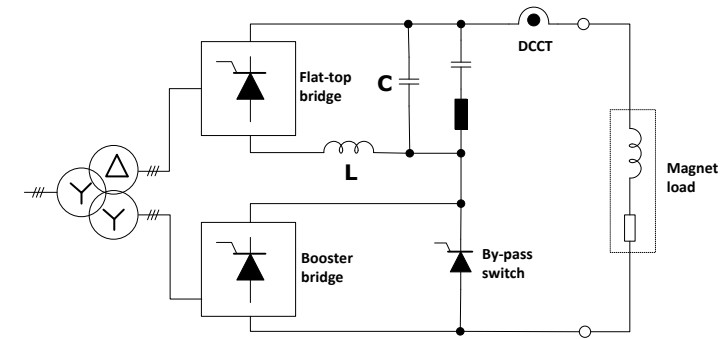
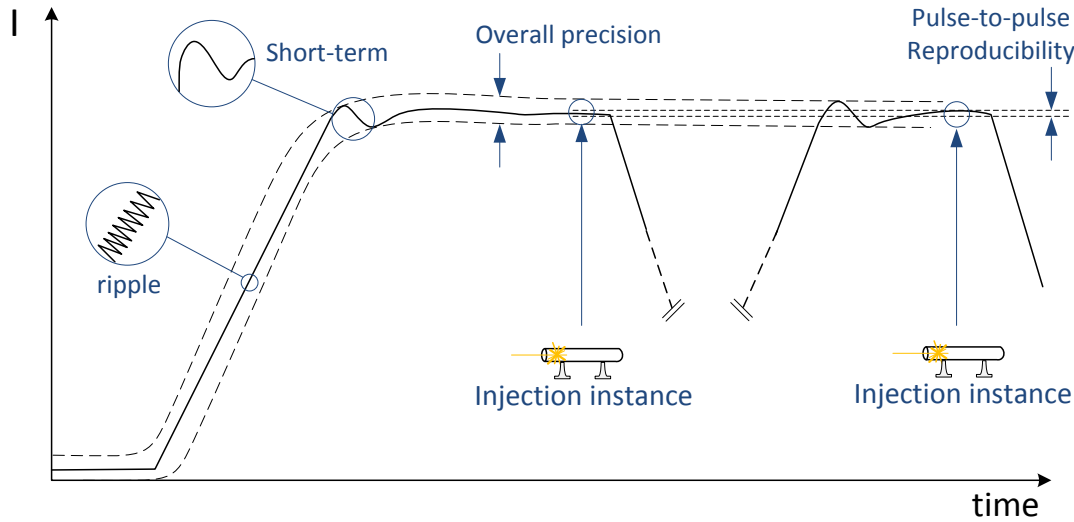

Precision components:

- Current ripple
- Short-term (dynamic behaviour)
- Long term (reproducibility)

Typical requirements:

- 1-100ppm depending on application

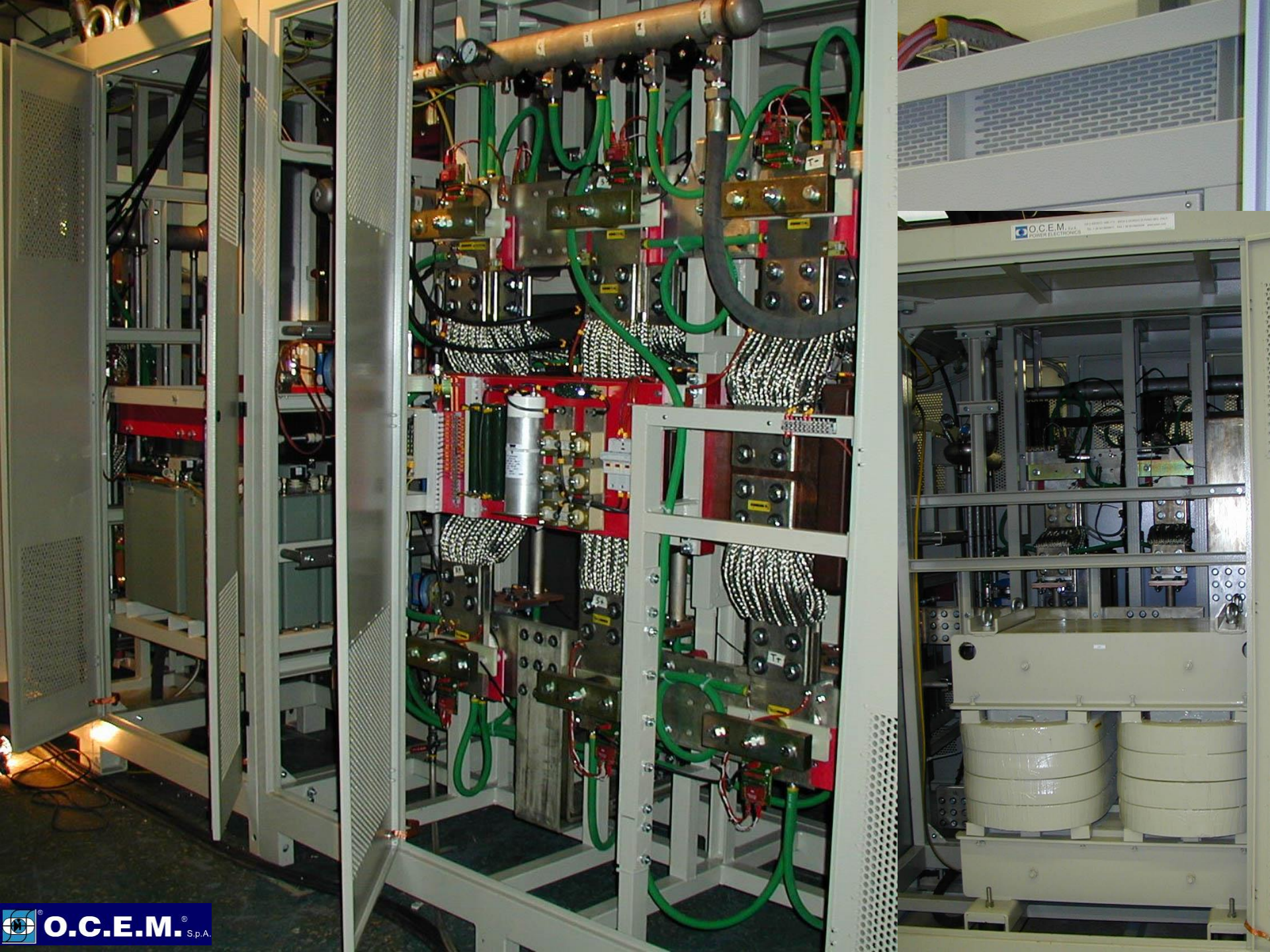

O.C.E.M. S.p.A.
POWER ELECTRONICS



20.5kA power converter – ATLAS solenoid

The load

- Superconducting magnet: $L = 7.5 \text{ H}$
- Nominal current: 20.5 kA
- Stored energy: 1.6 GJ
- Time constant: 37'500 s

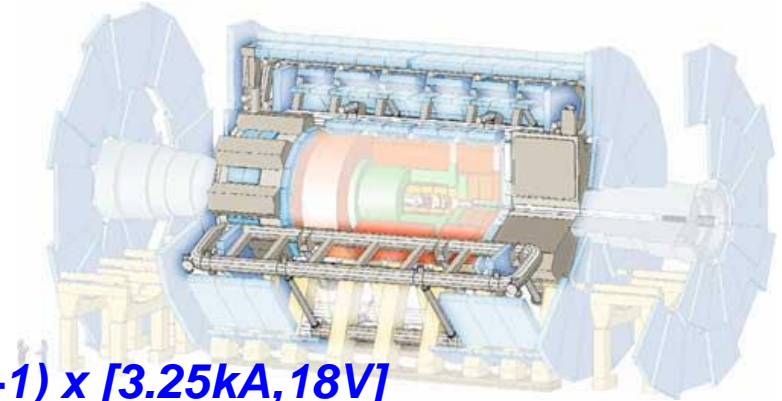

The power converter : [20.5 kA, 18V] ; (7+1) x [3.25kA, 18V]



TRANSTECHNIK

Slide by Frederick Bordry, CERN Accelerator school 2009



- Ερωτήσεις;

Life at CERN





www.cern.ch