

Neutron EDM Experiments at ILL and SNS

Philip Harris

US

University of Sussex

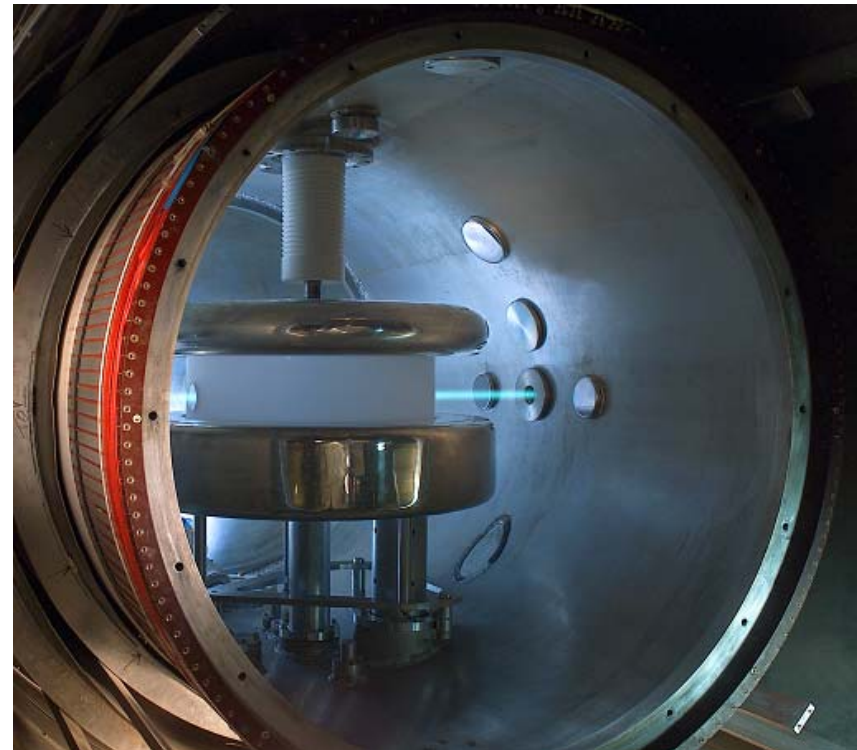

Overview

1. nEDM "Classic"

- New limit:
 $|d_n| < 2.9 \times 10^{-26} \text{ e.cm}$
- Discovery of new systematic effect

2. CryoEDM at ILL

- Starting shortly:
100x improved sensitivity

3. SNS nEDM Proposal

Electric Dipole Moments

- EDMs are P, T odd
- Complementary study of CPv
- Constrains models of new physics

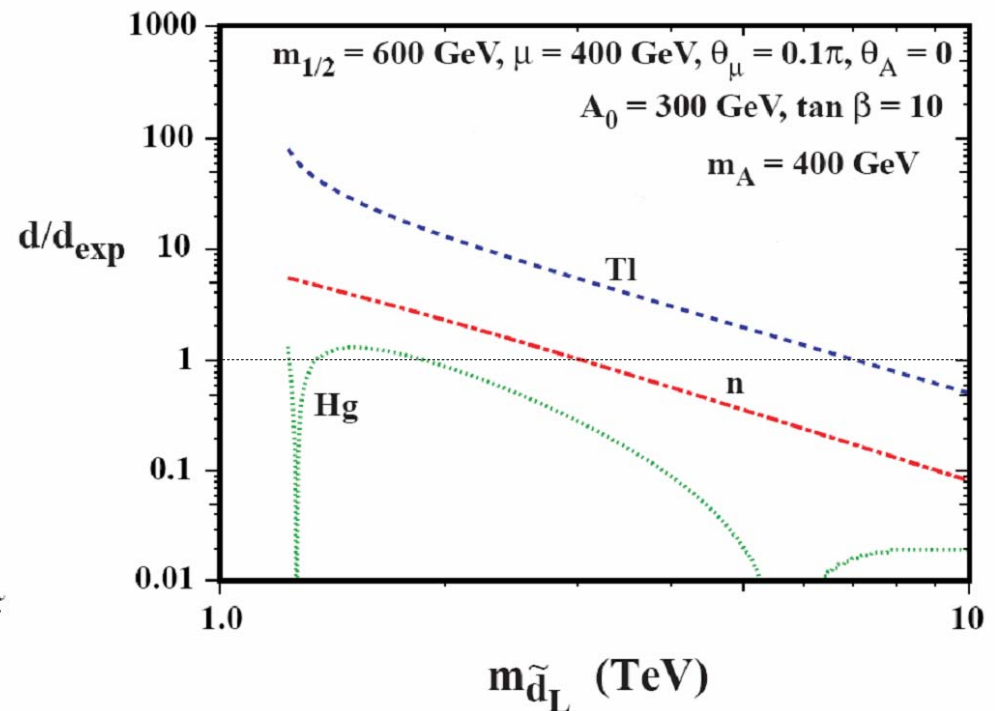
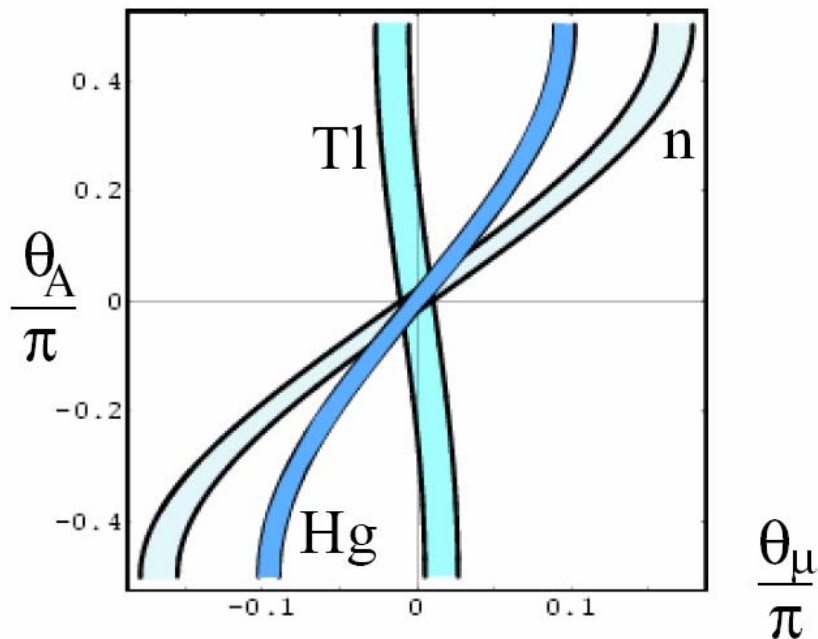
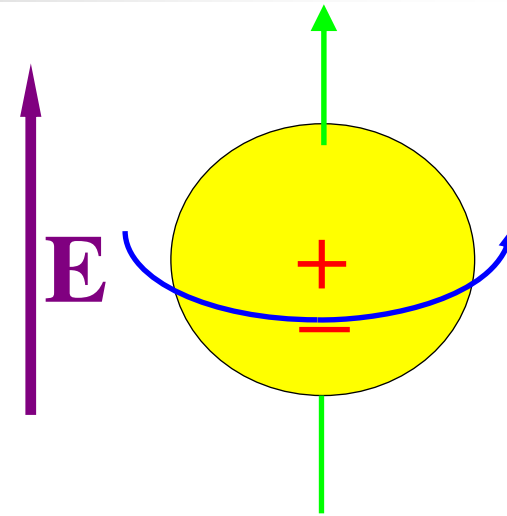

History

Factor 10
every 8 years
on average

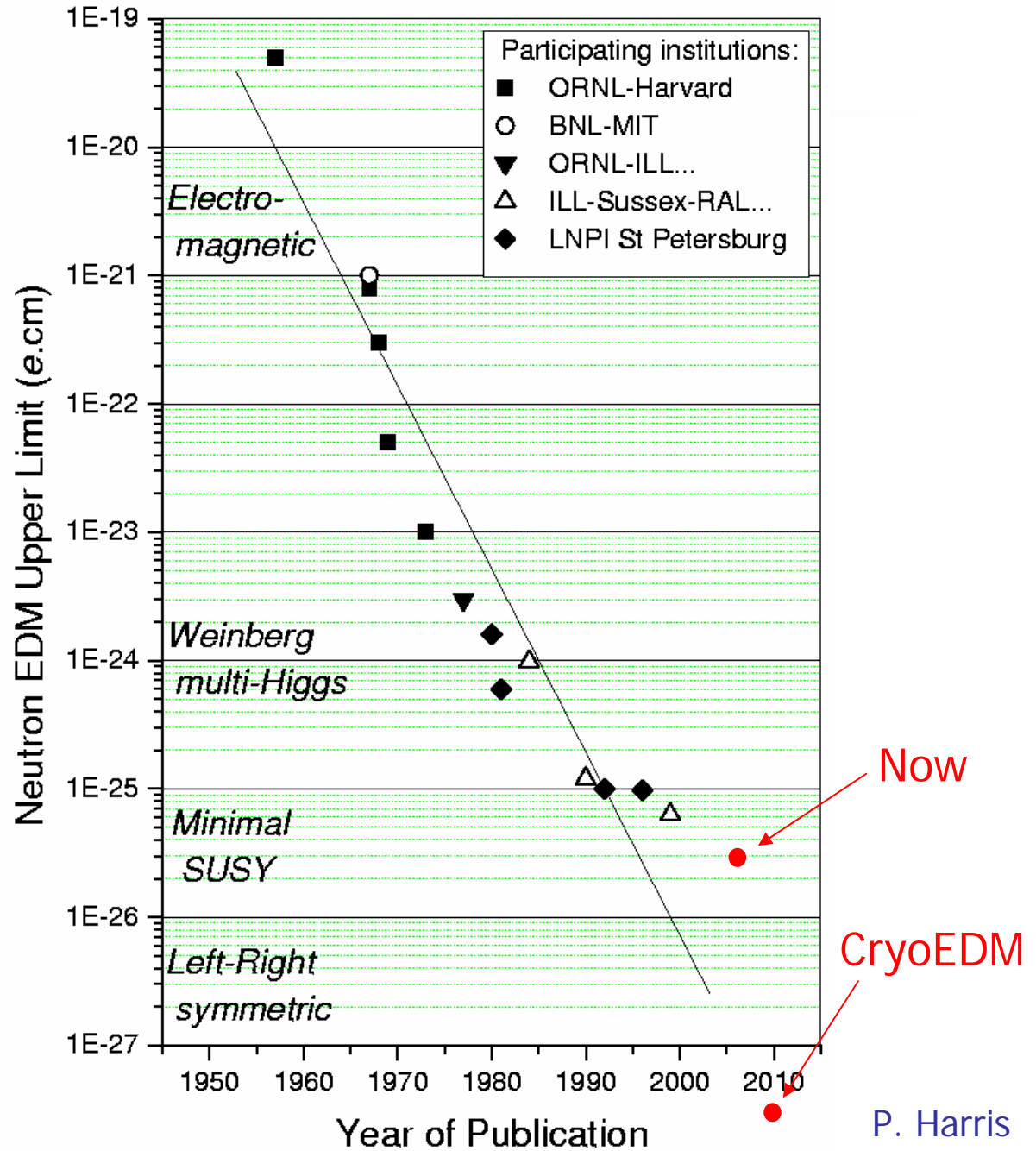

P. Harris
CERN, 9/10/2006

Measurement principle

Use NMR on ultracold neutrons in **B**, **E** fields.

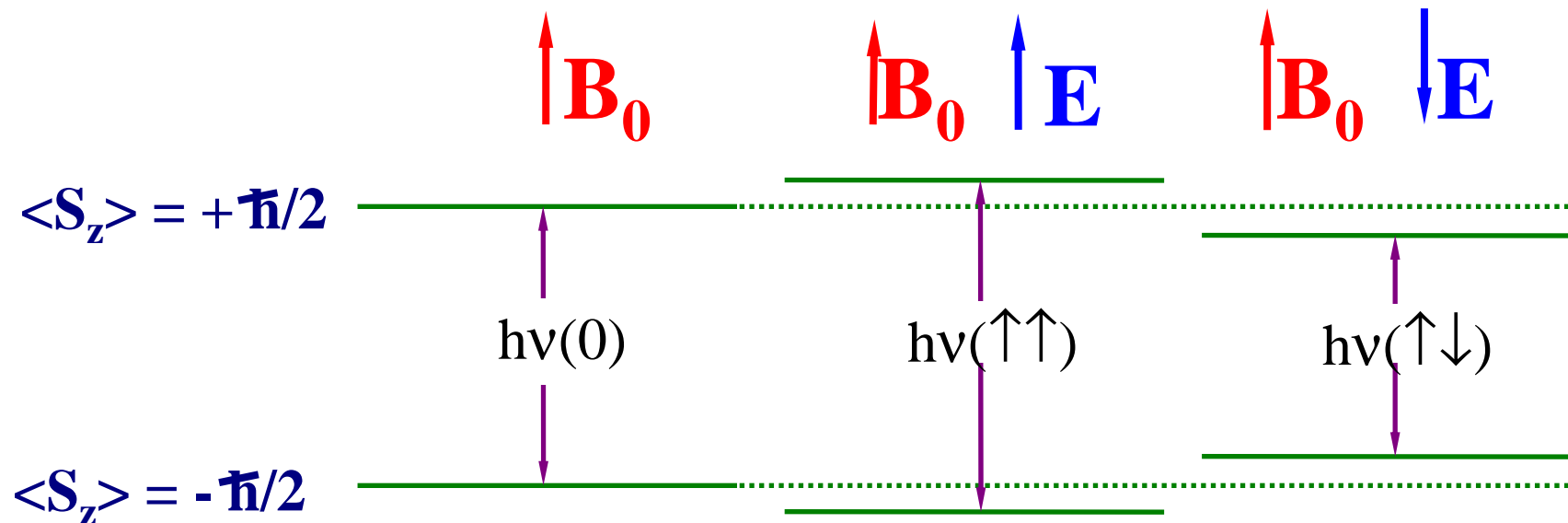

$$\nu(\uparrow\uparrow) - \nu(\uparrow\downarrow) = -4 \mathbf{E} d / \hbar$$

assuming **B** unchanged when **E** is reversed.

Energy resolution of our detector: $<10^{-21}$ eV

Measurement principle

Measure Larmor spin precession freq in parallel & antiparallel **B** and **E** fields

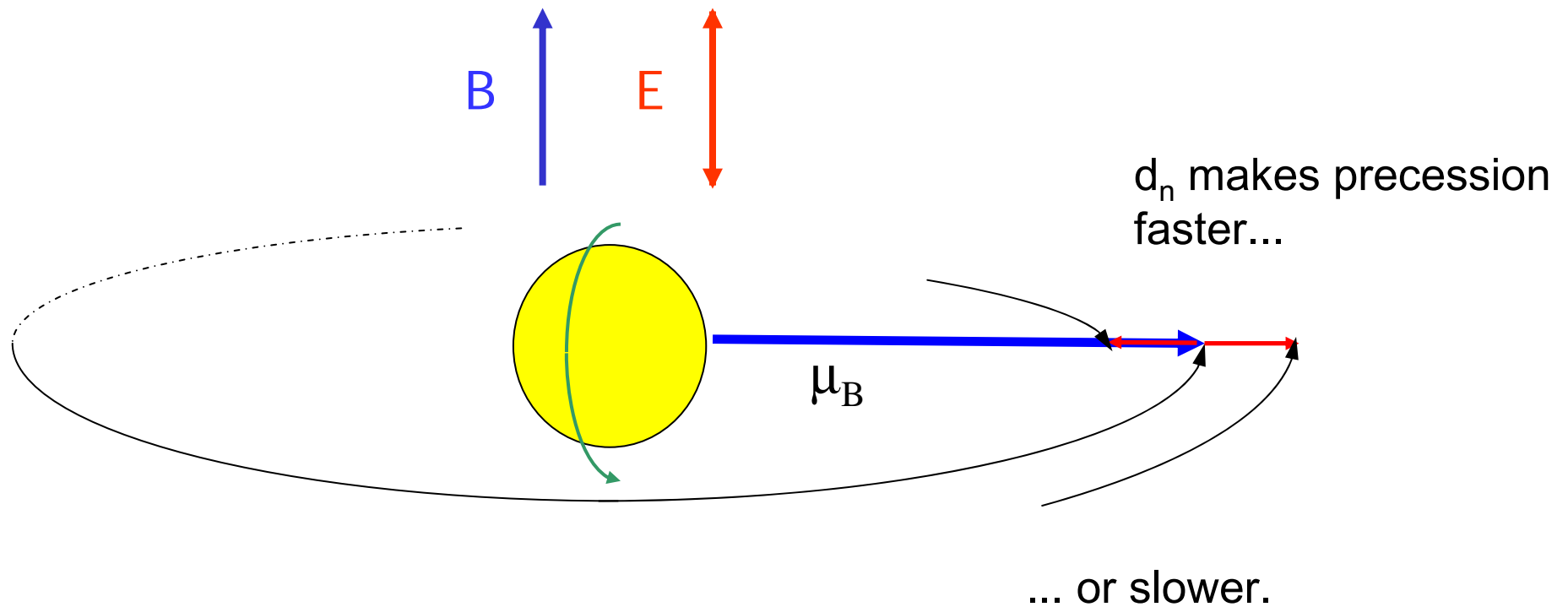

Reverse E relative to B, look for freq shift.

Ramsey method of Separated Oscillating Fields

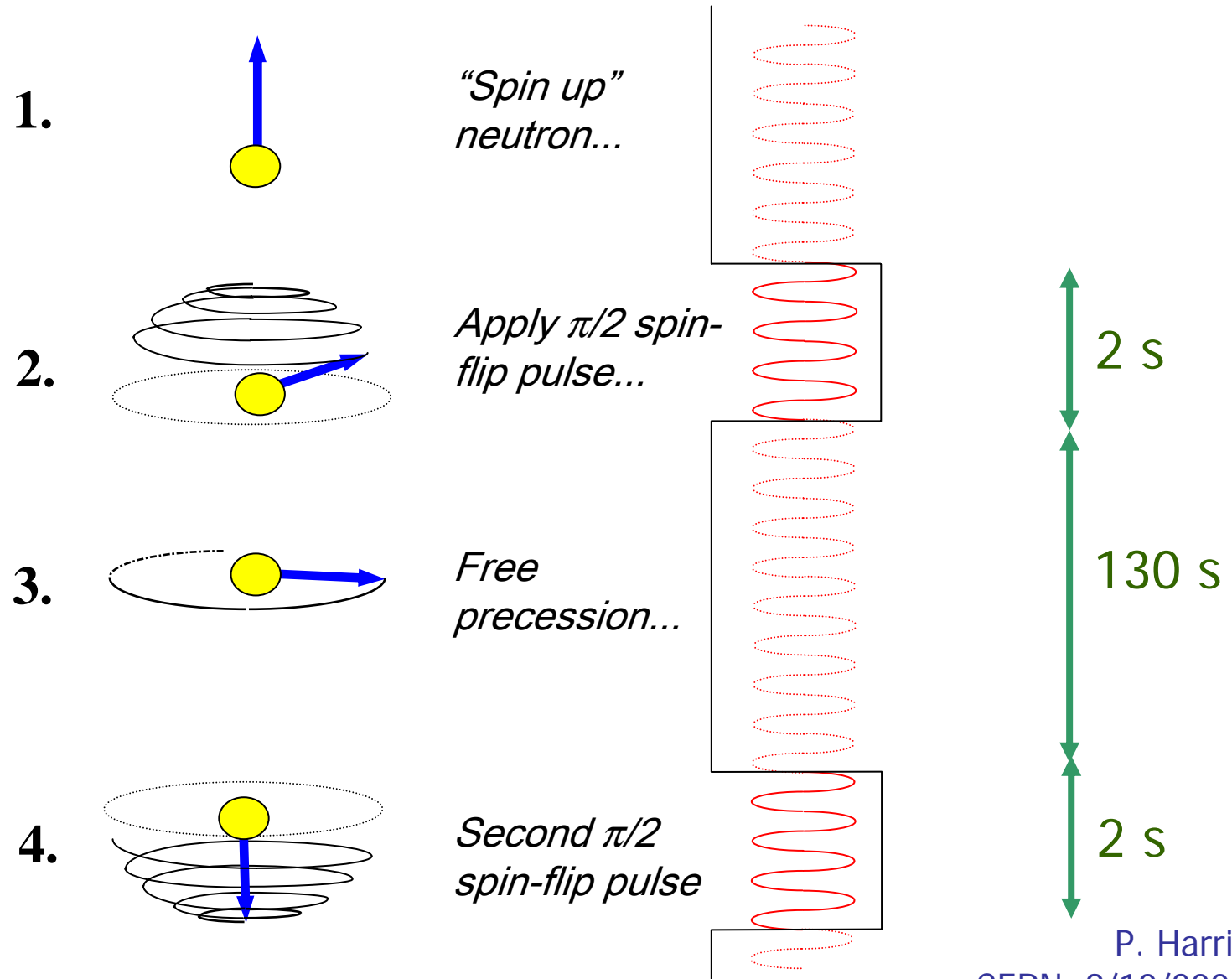

P. Harris
CERN, 9/10/2006

Ramsey resonance

- "2-slit" interference pattern
- Phase gives freq offset from resonance

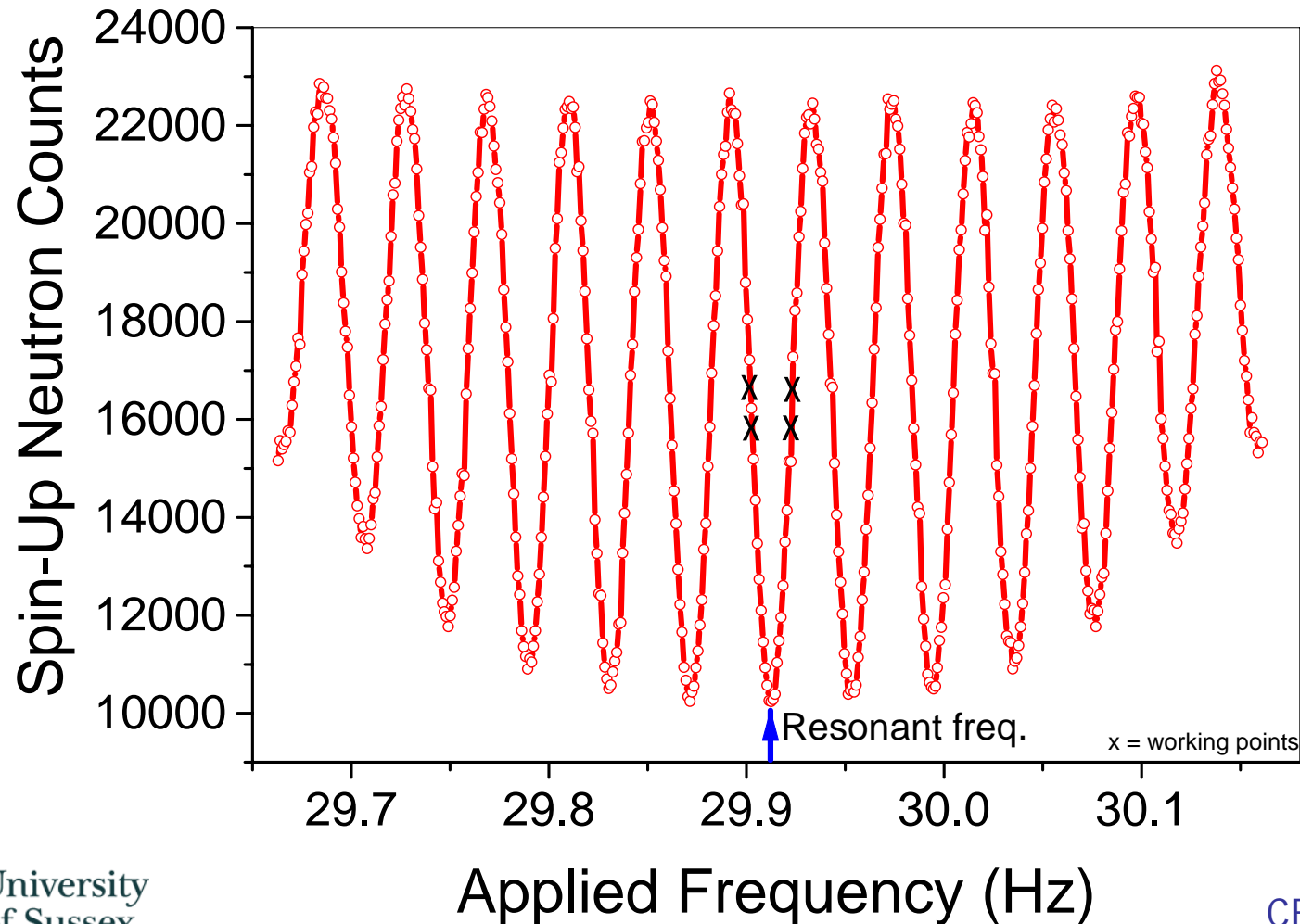

ILL, Grenoble

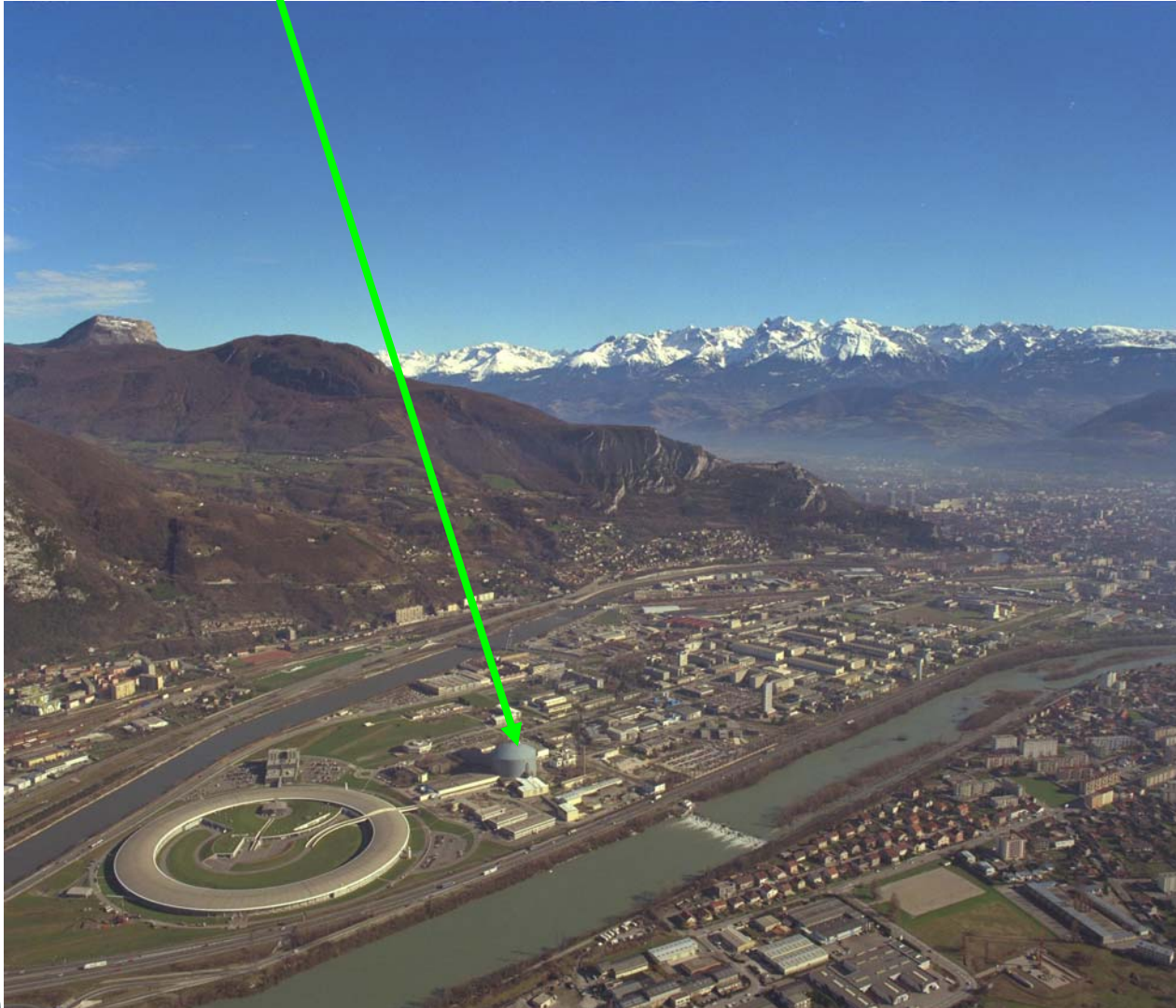

The ILL reactor



Neutron turbine
A. Steyerl (TUM - 1986)

Vertical guide tube

Cold source

Reactor core

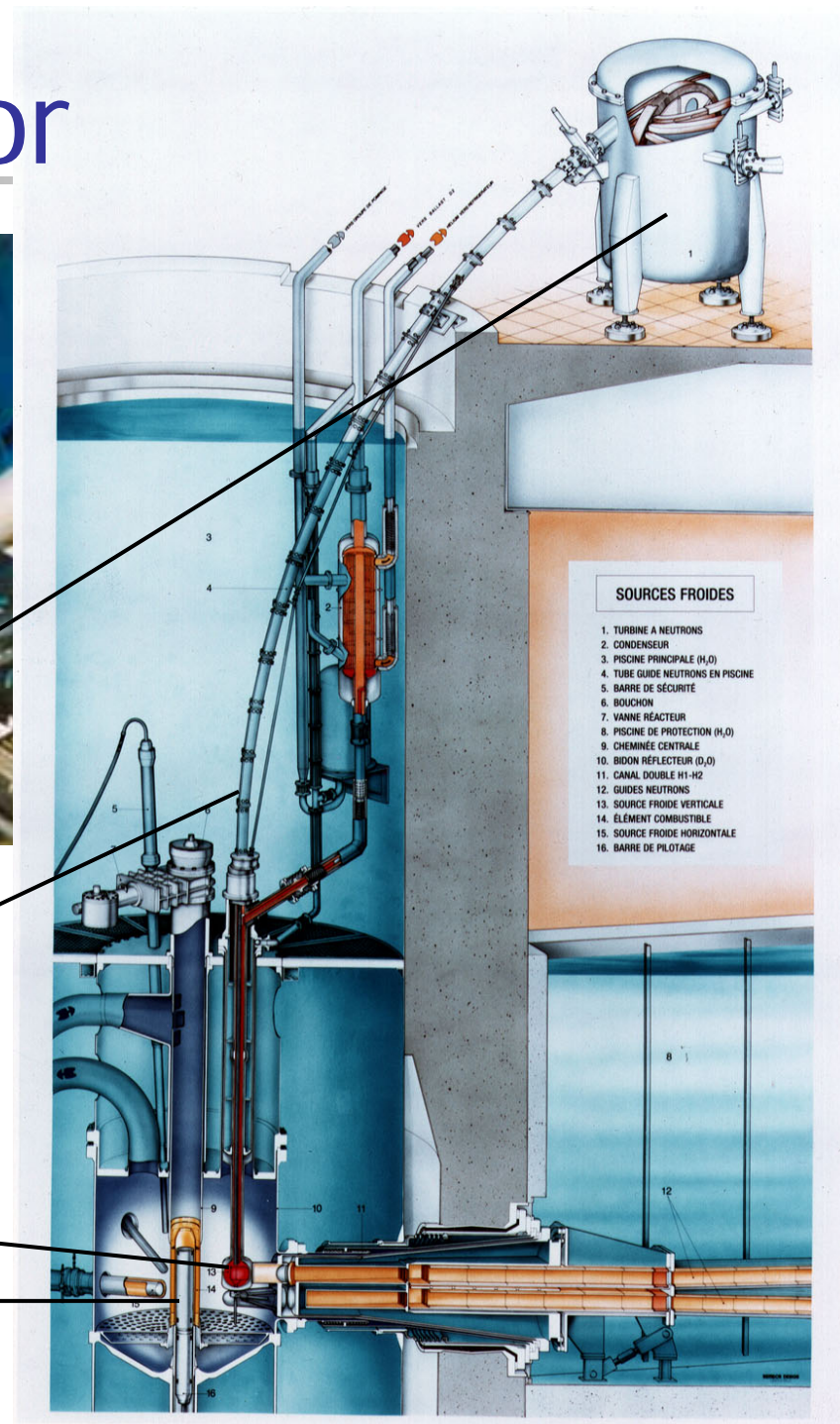

Apparatus

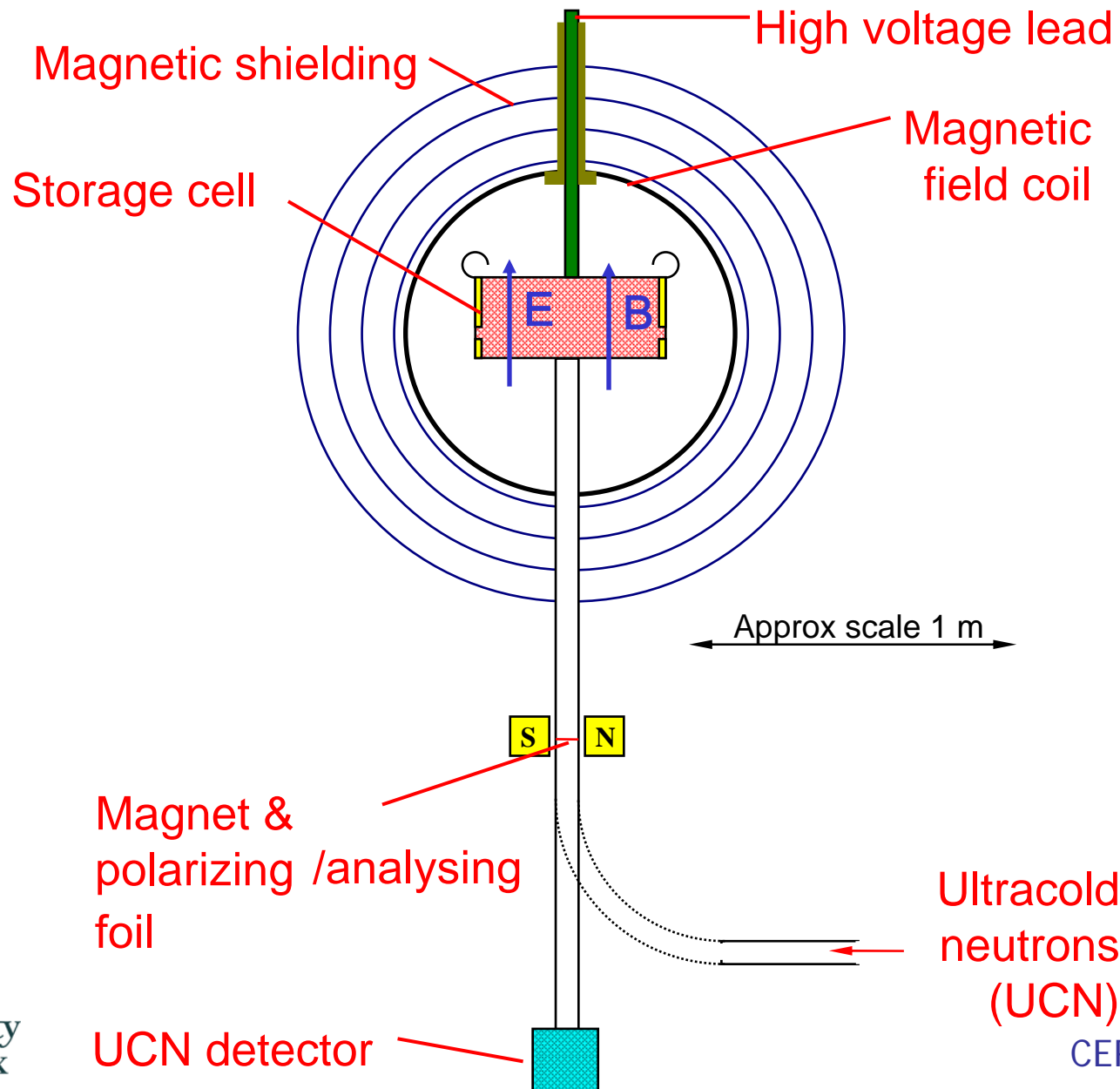

Apparatus

HV feedthru

Neutron storage chamber

B-field coils

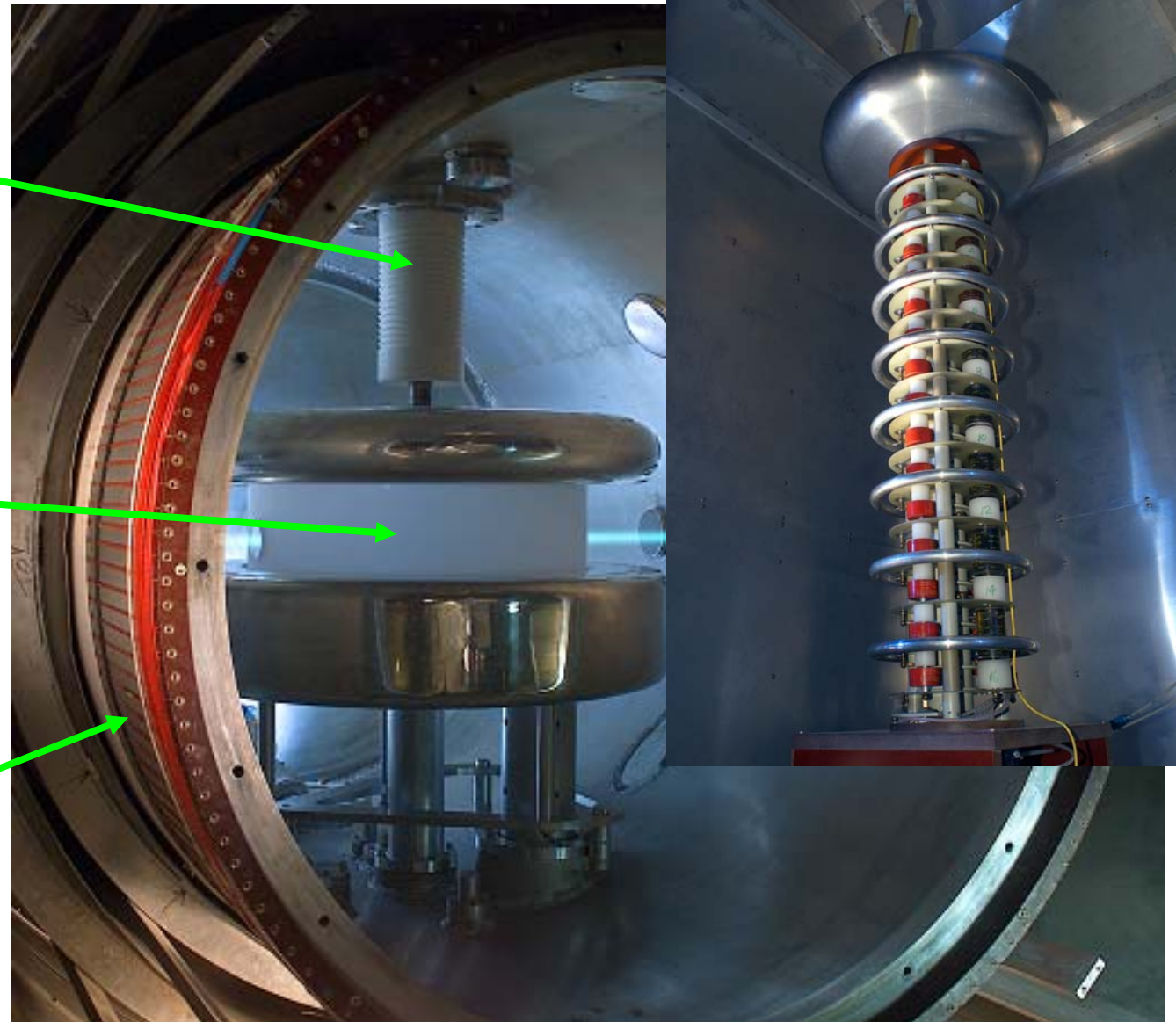

Hg co-magnetometer

$|d_{\text{Hg}}| < 2.1 \times 10^{-28} \text{ e cm}$
[Romalis et al.,
PRL 86 (2001) 8505]

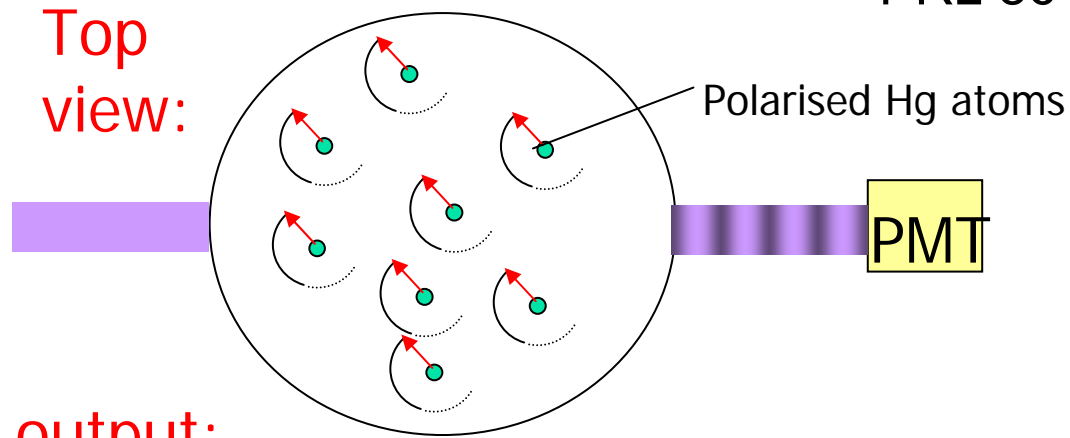

PMT output:

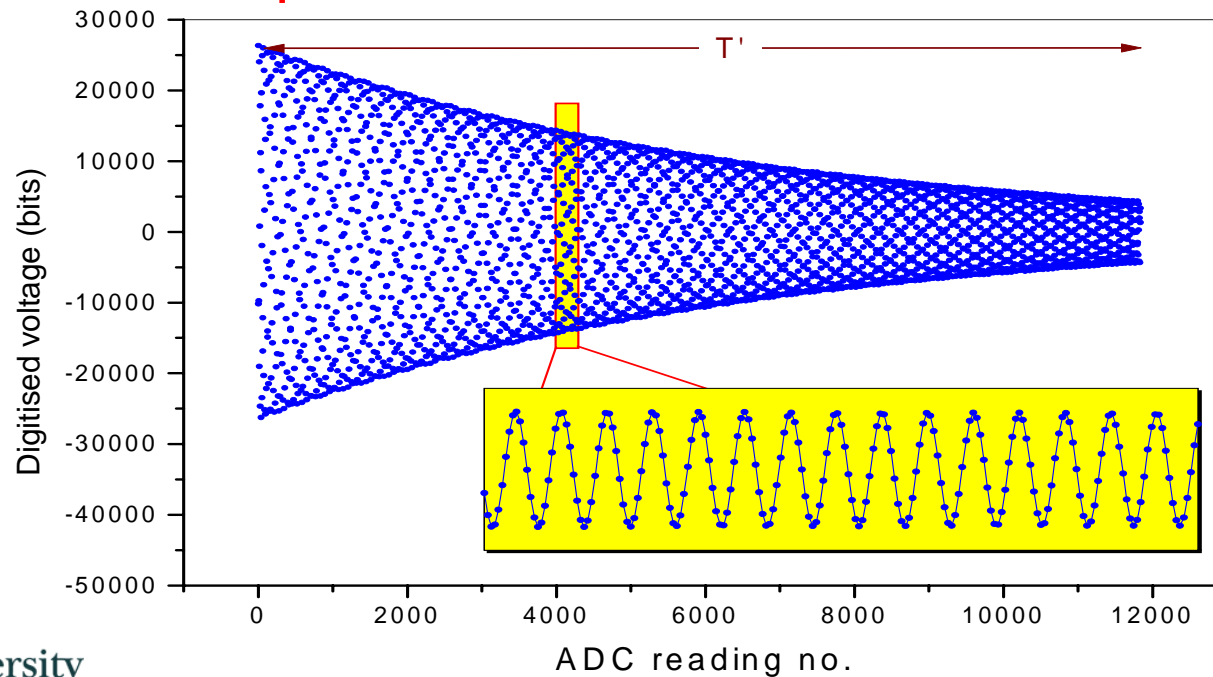

nEDM measurement

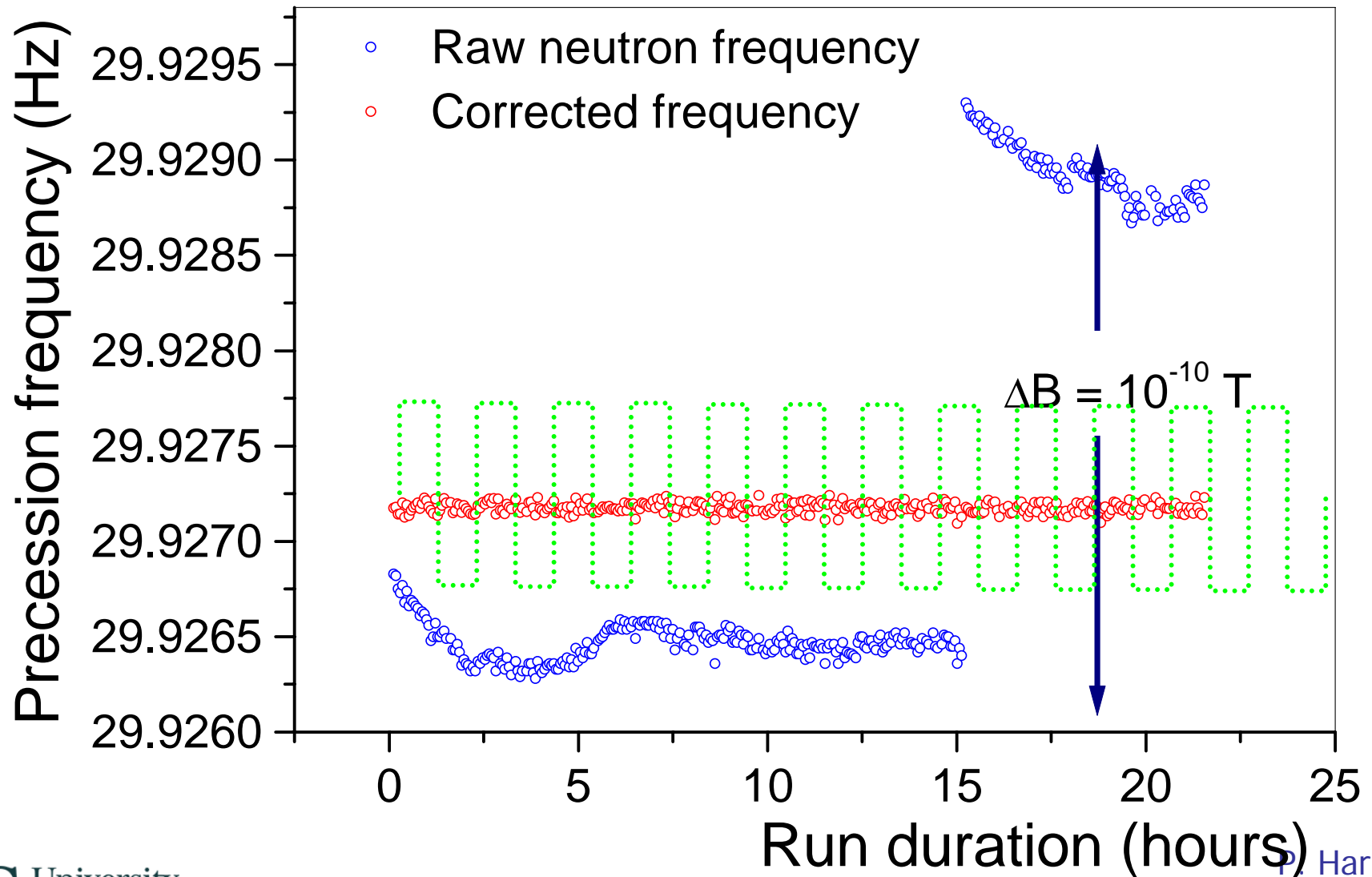

Neutron EDM results (binned)

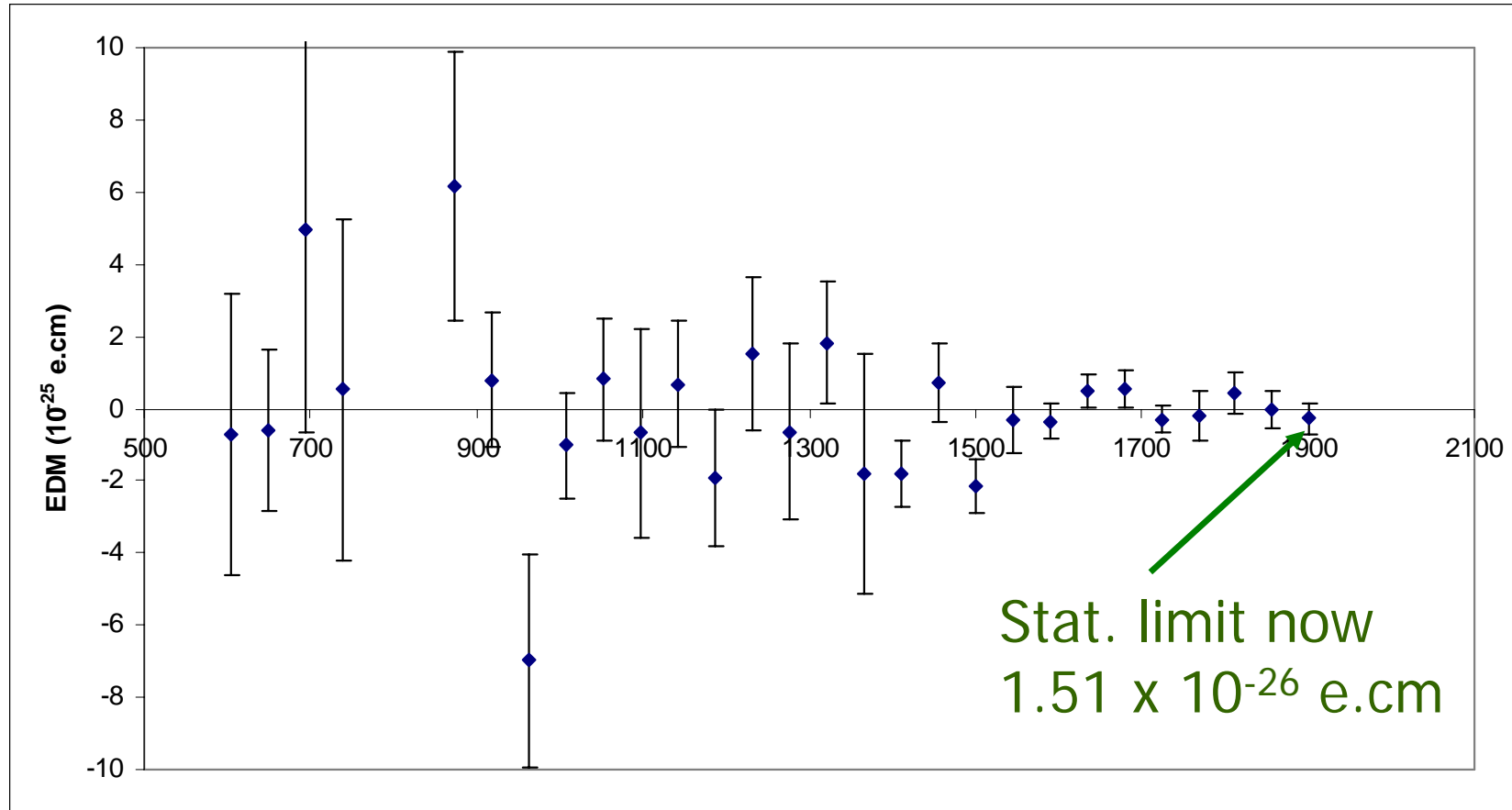

...but B up, B down disagree.

New leading systematic

Combination of two effects:

$$\frac{\partial B}{\partial z} \Rightarrow B_r \propto r$$

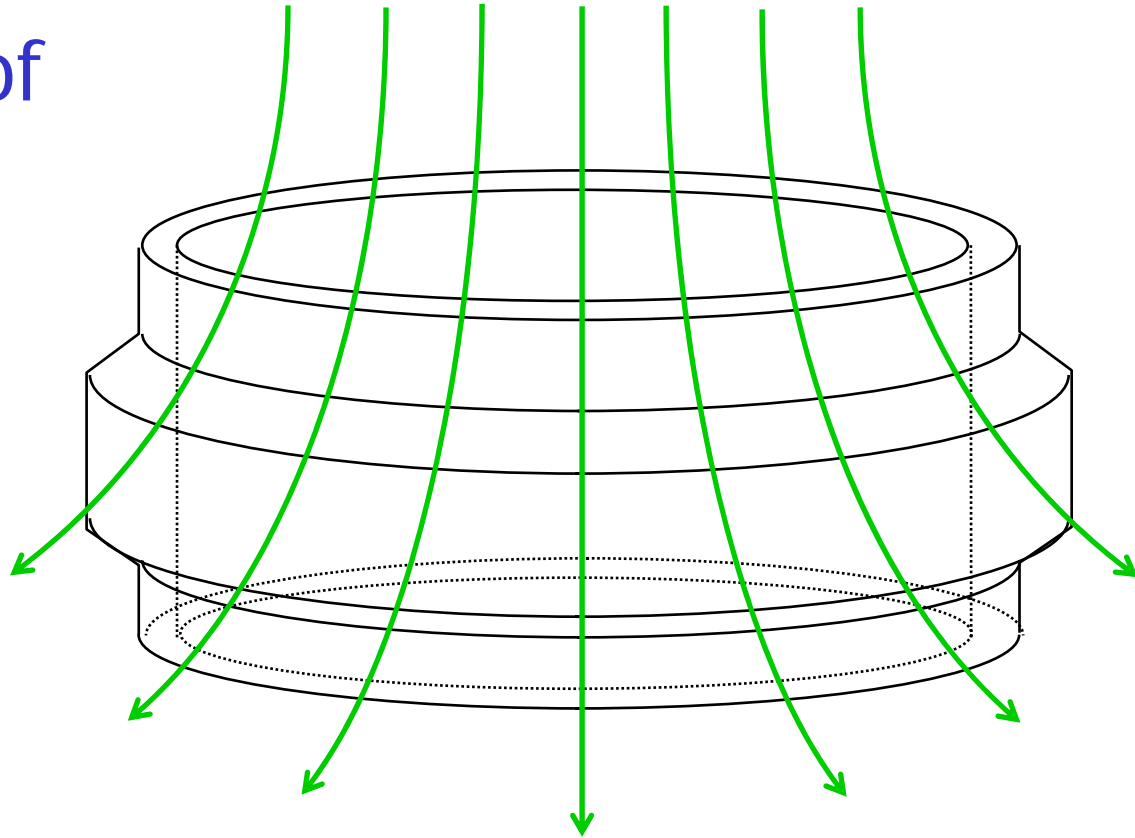

and, from Special Relativity, extra motion-induced field

$$\vec{B}' = \frac{1}{\gamma} \frac{\vec{v} \times \vec{E}}{c^2}$$

Geometric Phase

J. Pendlebury et al., PRA 70 032102 (2004)
P. Harris, J. Pendlebury, PRA 73 014101 (2006)

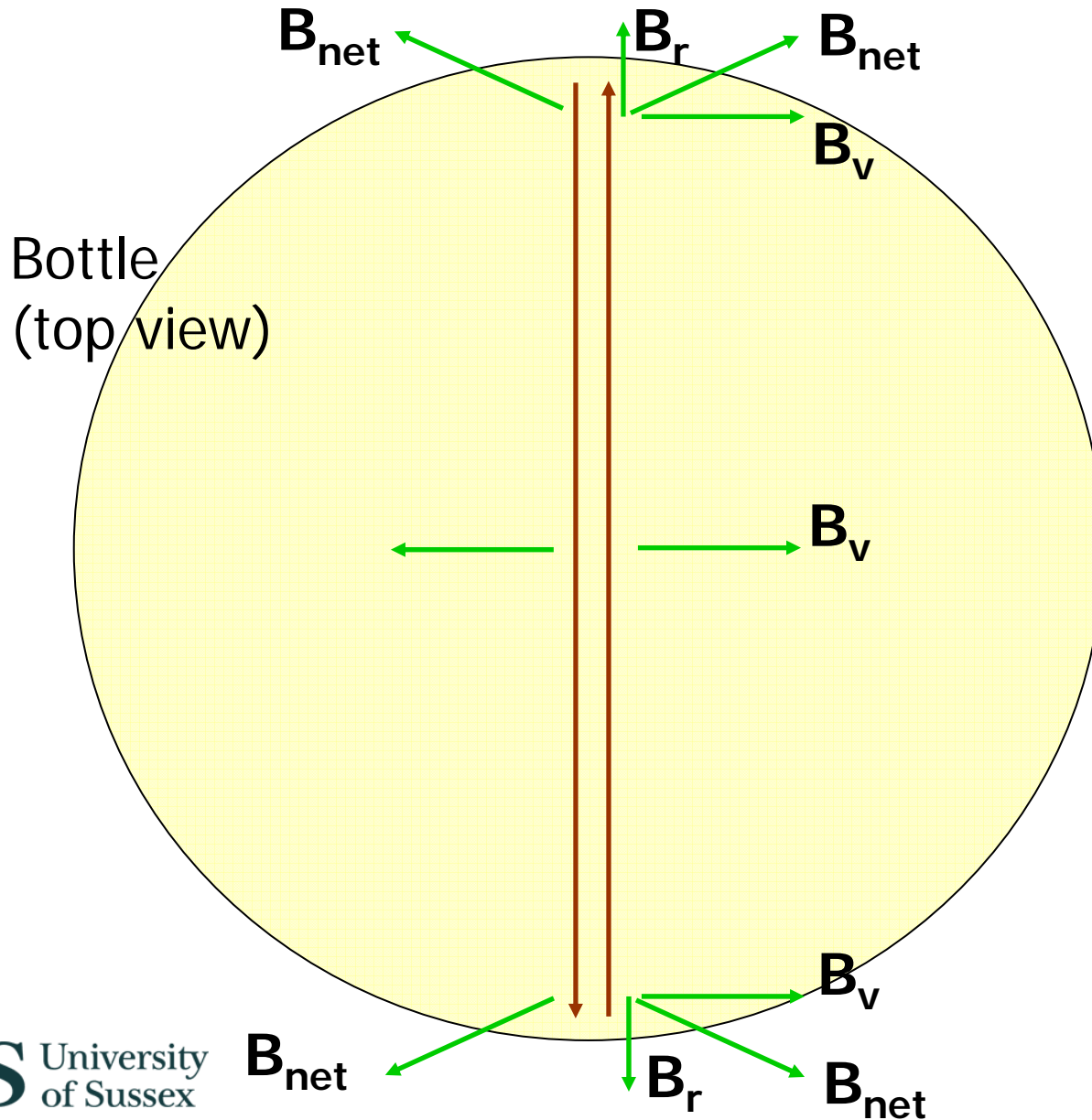

... so particle sees additional rotating field

Frequency shift $\propto E$

Looks like an EDM, but scales with dB/dz

Geometric Phase Velocity dependence

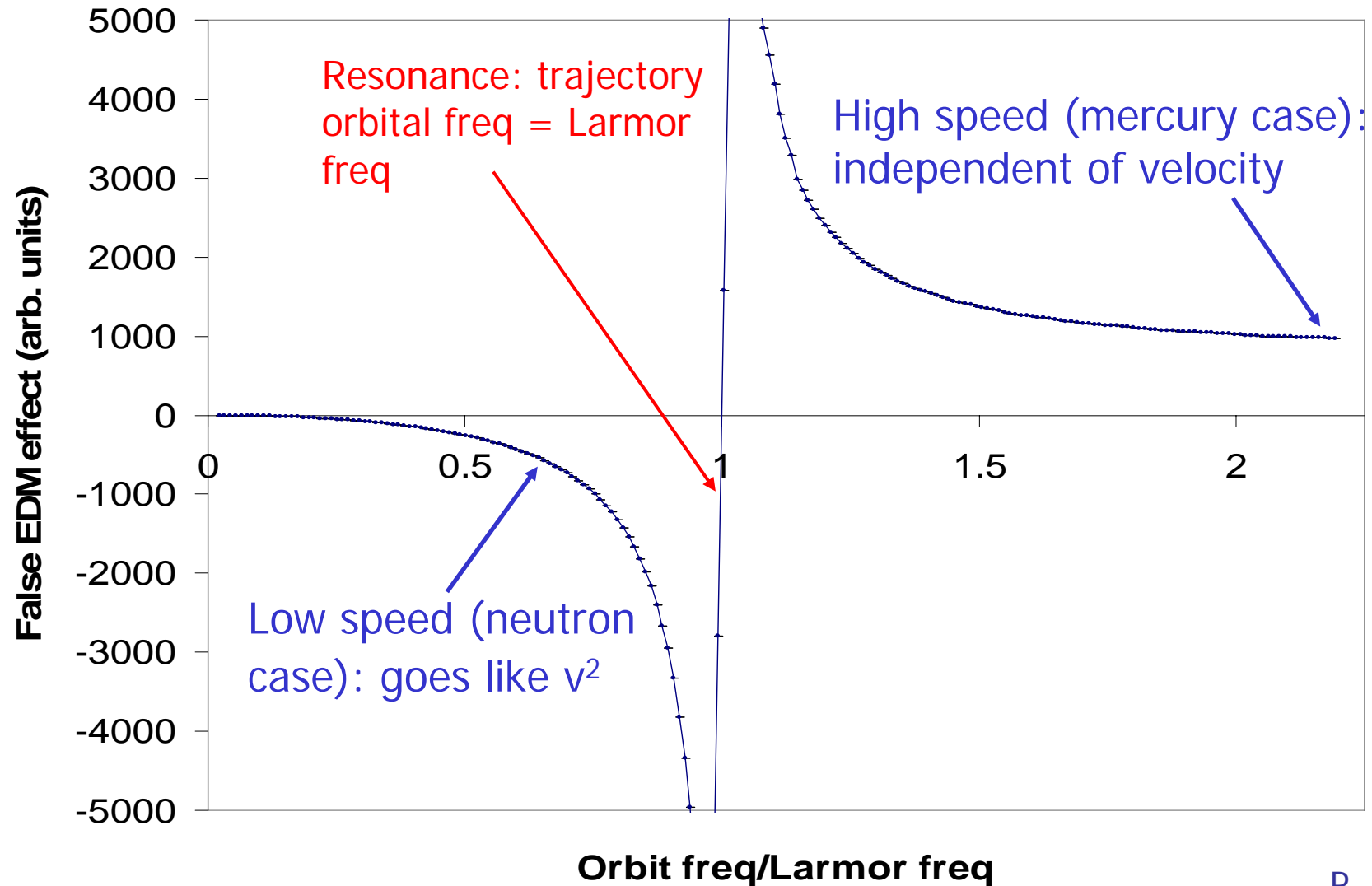

Geometric Phase How to measure it

- Consider

$$R = \frac{v_n}{v_{Hg}} \cdot \frac{\gamma_{Hg}}{\gamma_n}$$

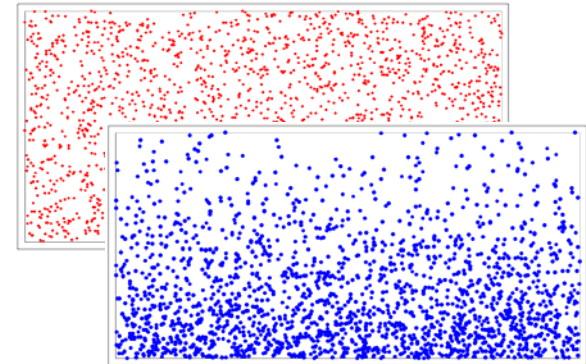

- Should have value 1
- R is shifted by magnetic field gradients
- Plot EDM vs measured R-1:

Geometric Phase

Magnetic field down

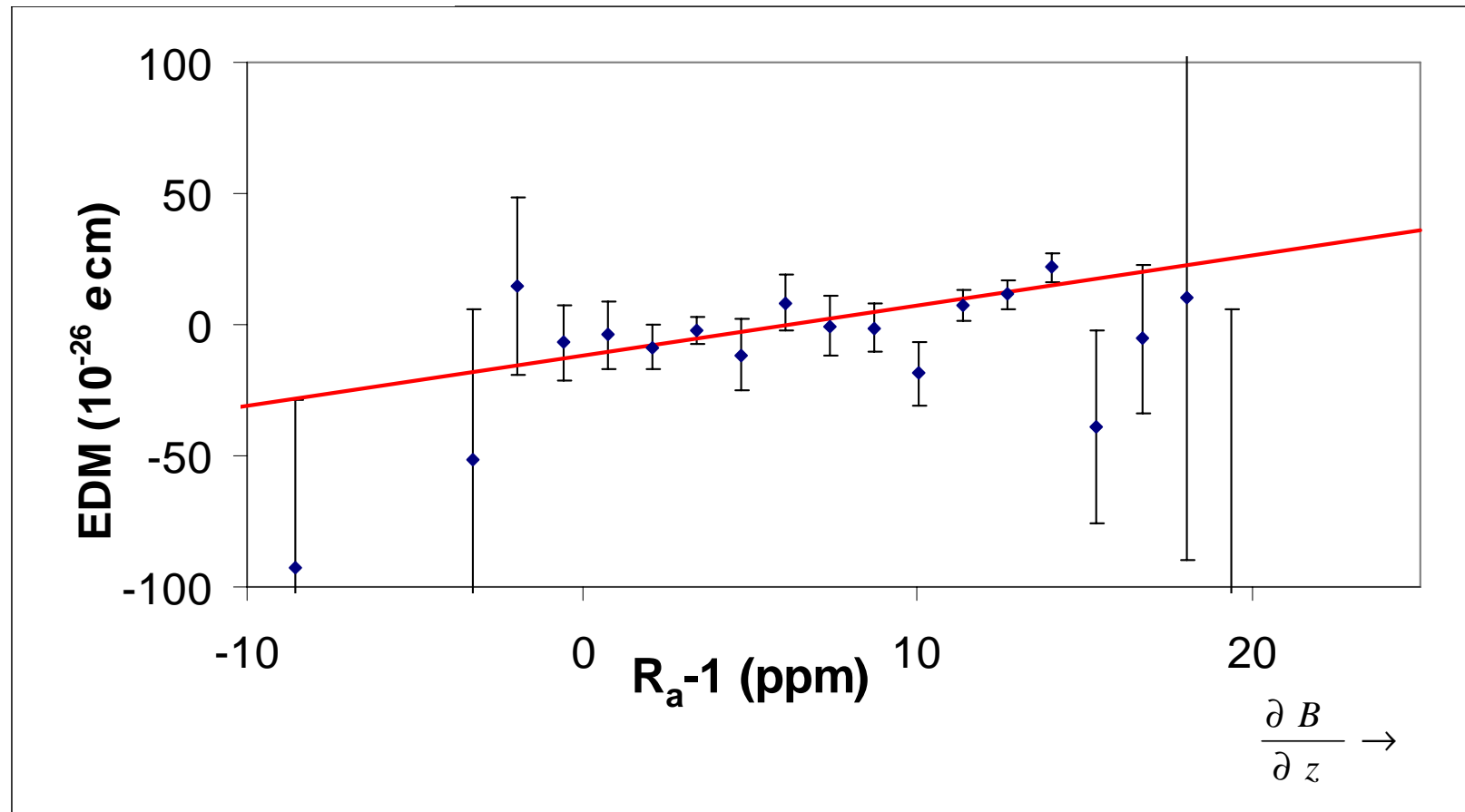

Geometric Phase

Magnetic field up

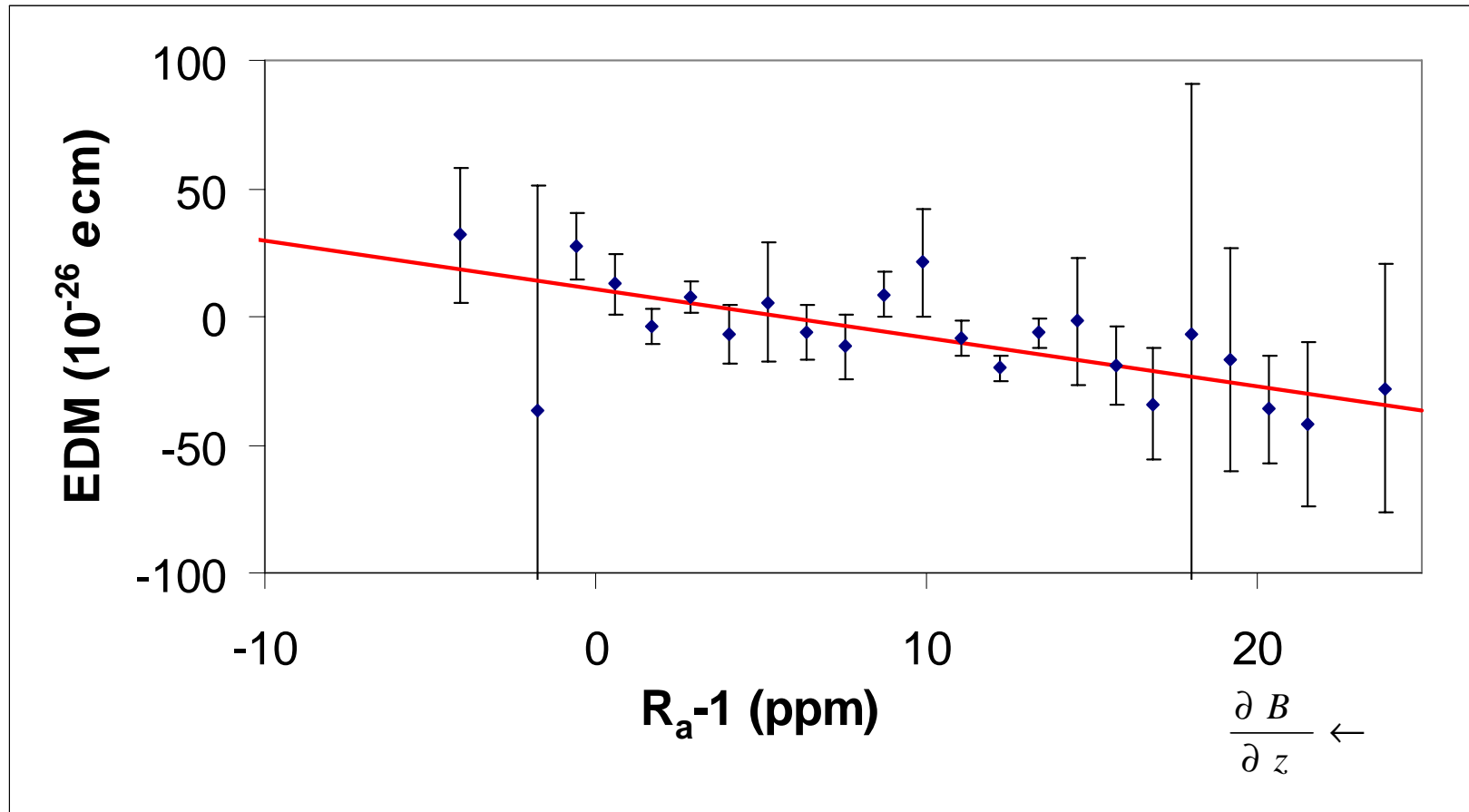

Results

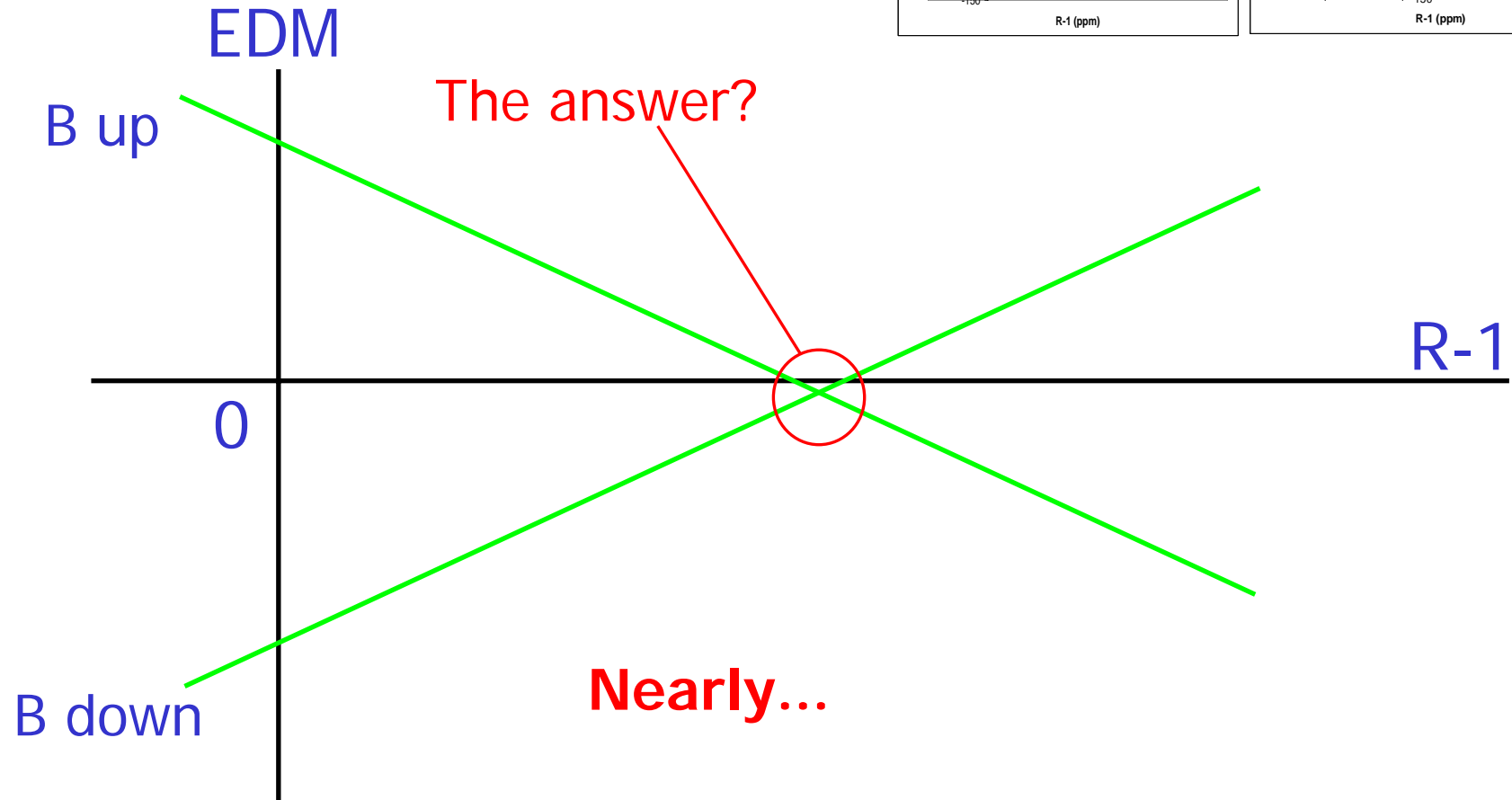
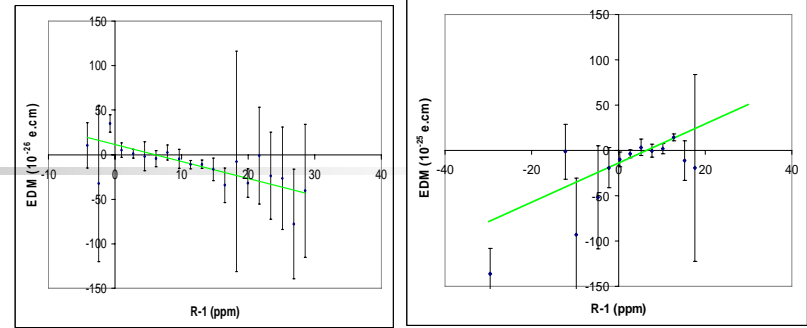

Results

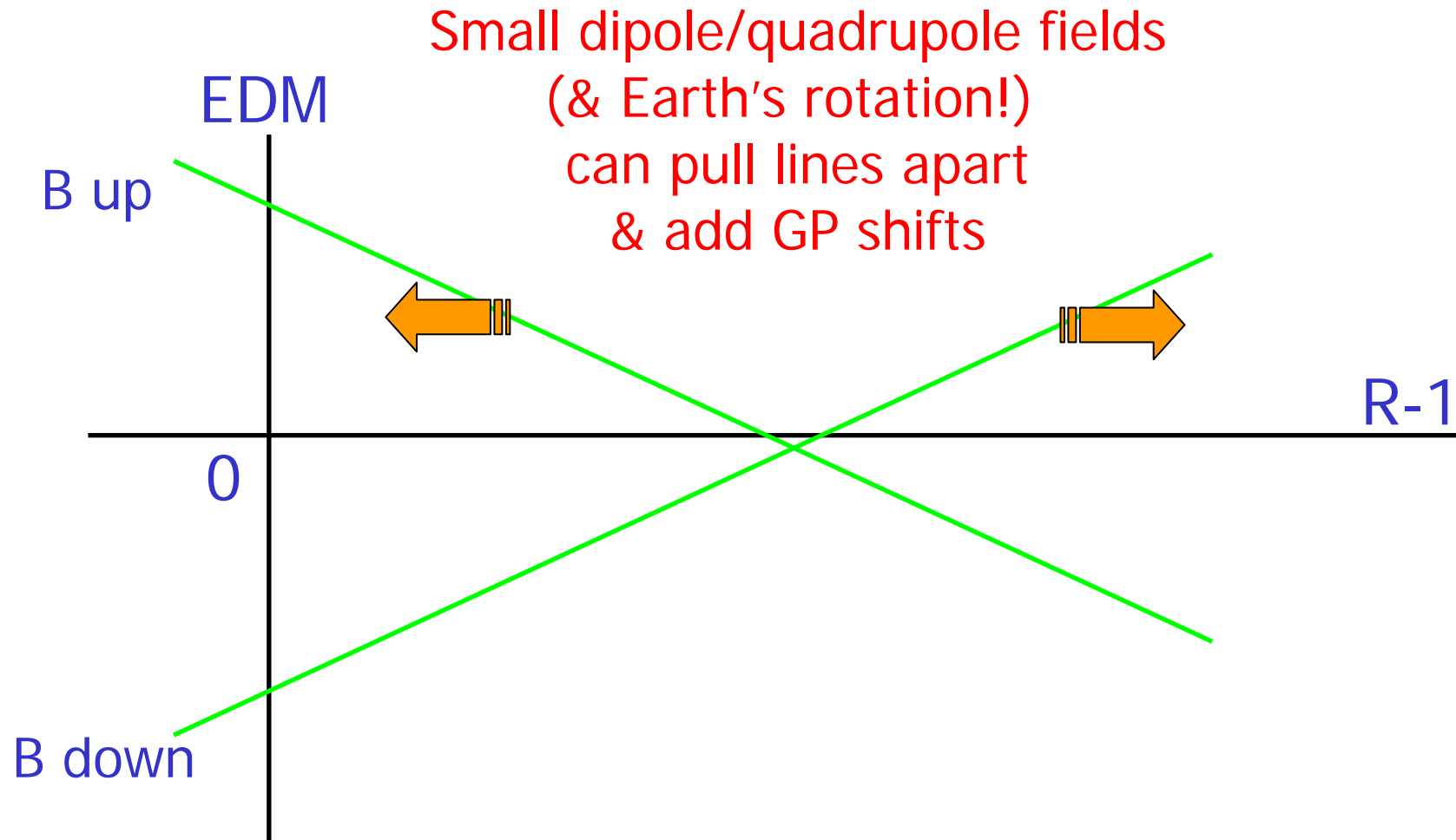

Results

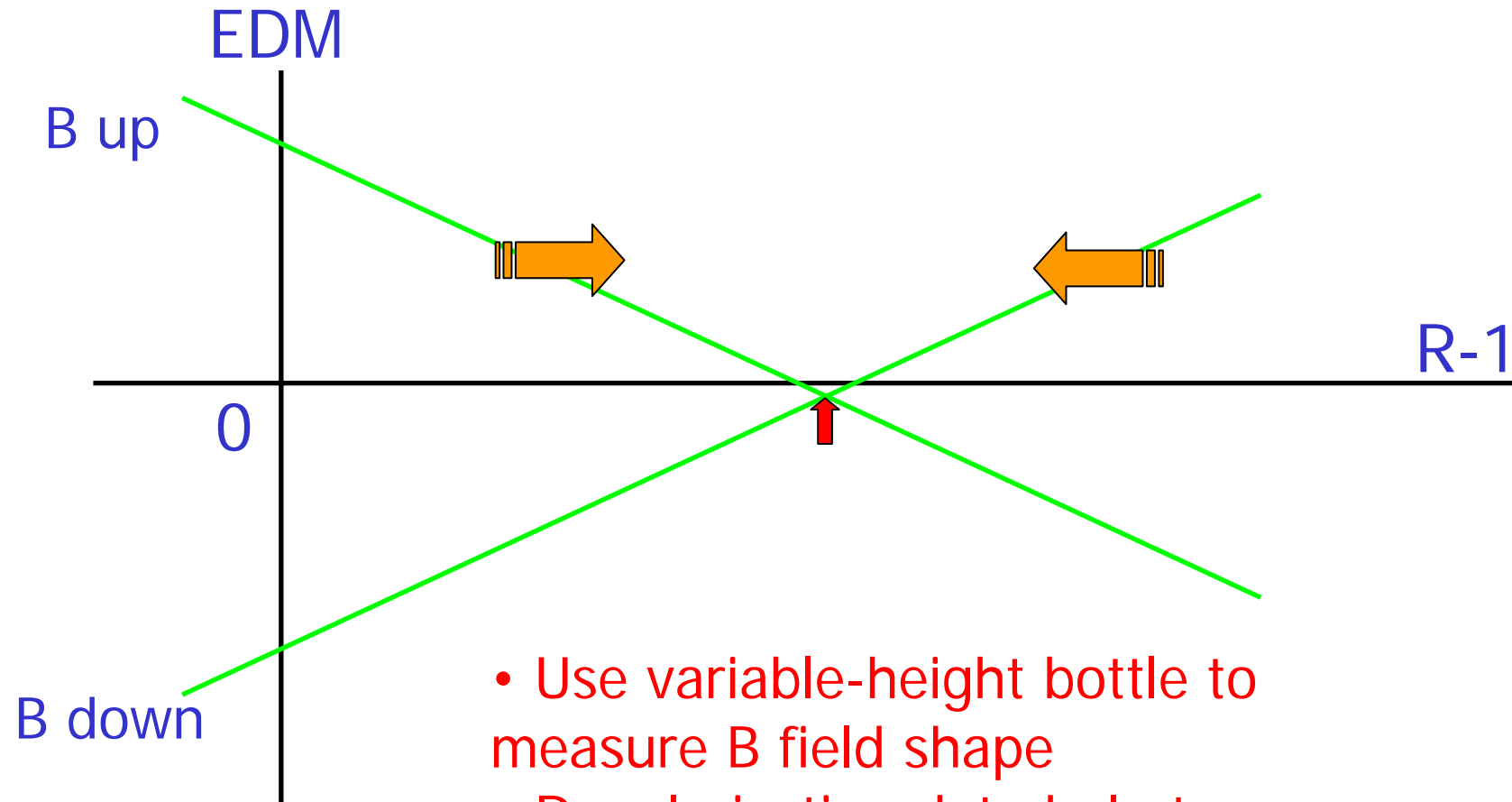

- Use variable-height bottle to measure B field shape
- Depolarization data help to establish separations
- Apply corrections

Final Result



New limit:

$$|d_n| < 2.9 \times 10^{-26} \text{ e.cm (90\% CL)}$$

Phys. Rev. Lett. 97, 131801 (2006),
hep-ex/0602020

CryoEDM: The Next Generation



New technology:

- More neutrons
- Higher E field
- Better polarisation
- Longer NMR coherence time

100-fold improvement in sensitivity

UCN production in liquid helium

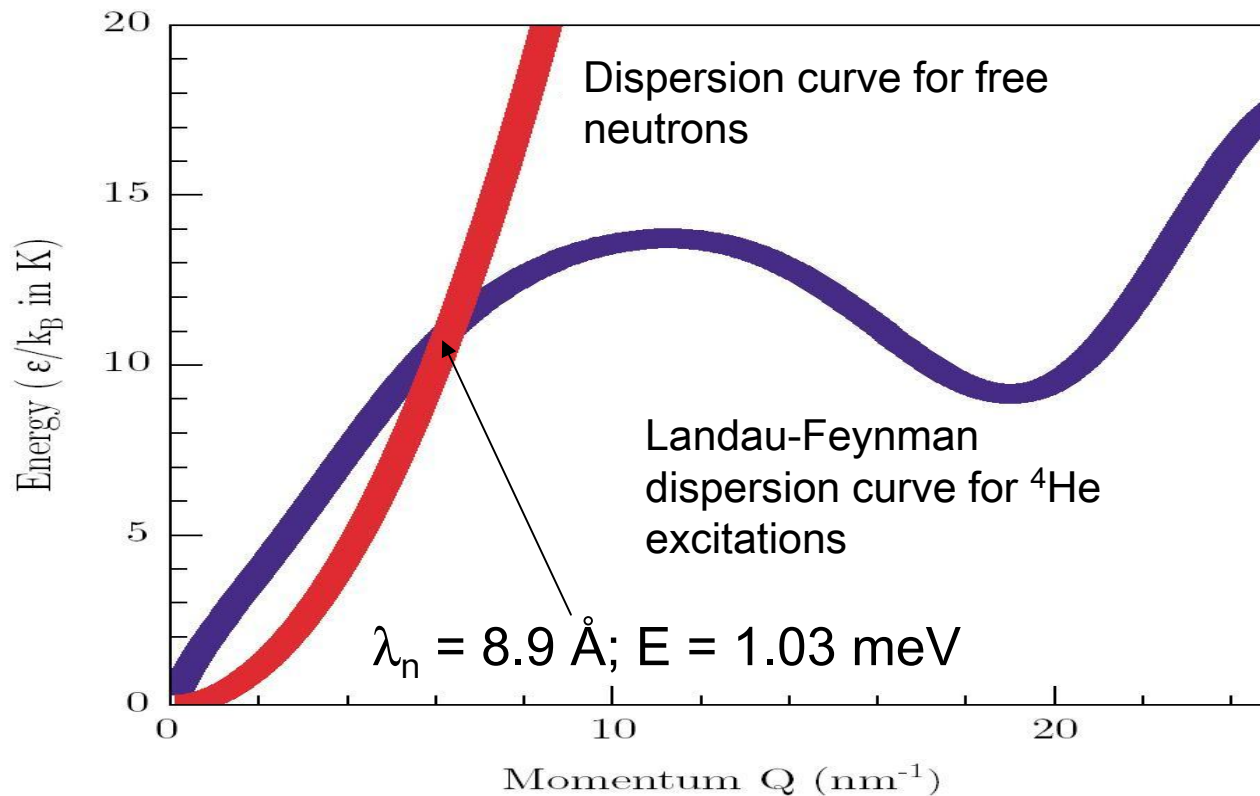

R. Golub and J.M. Pendlebury
Phys. Lett. **53A** (1975),
Phys. Lett. **62A** (1977)

- 1.03 meV (11 K) neutrons downscatter by emission of phonon in liquid helium at 0.5 K
- Upscattering suppressed: Boltzmann factor $e^{-E/kT}$ means not many 11 K phonons present

UCN production rate vs λ_n

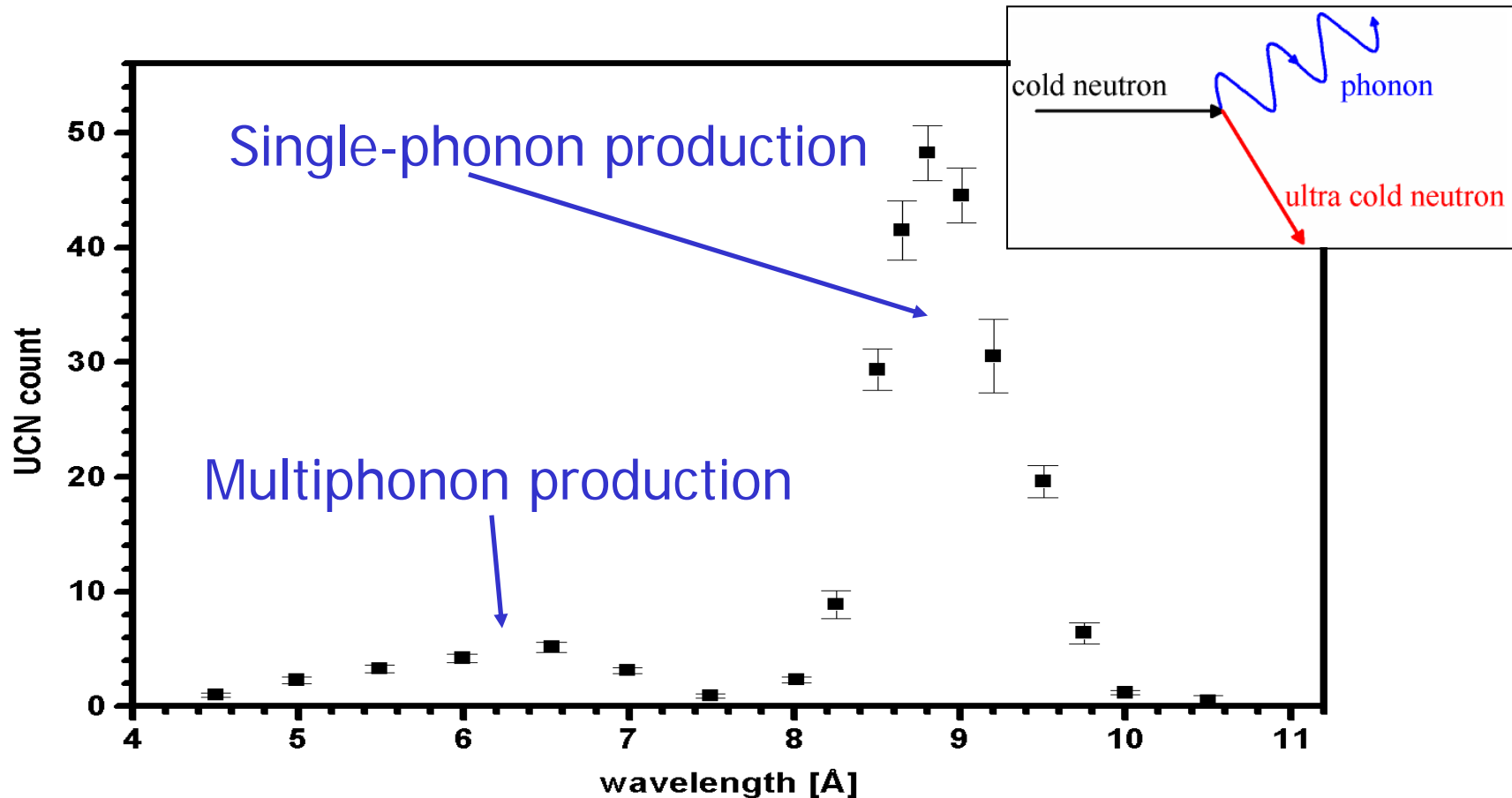

1.19±0.18 UCN cm⁻³ s⁻¹ expected, 0.91± 0.13 observed

C.A.Baker *et al.*, Phys.Lett. A308 67-74 (2002)

UCN detection in liquid helium

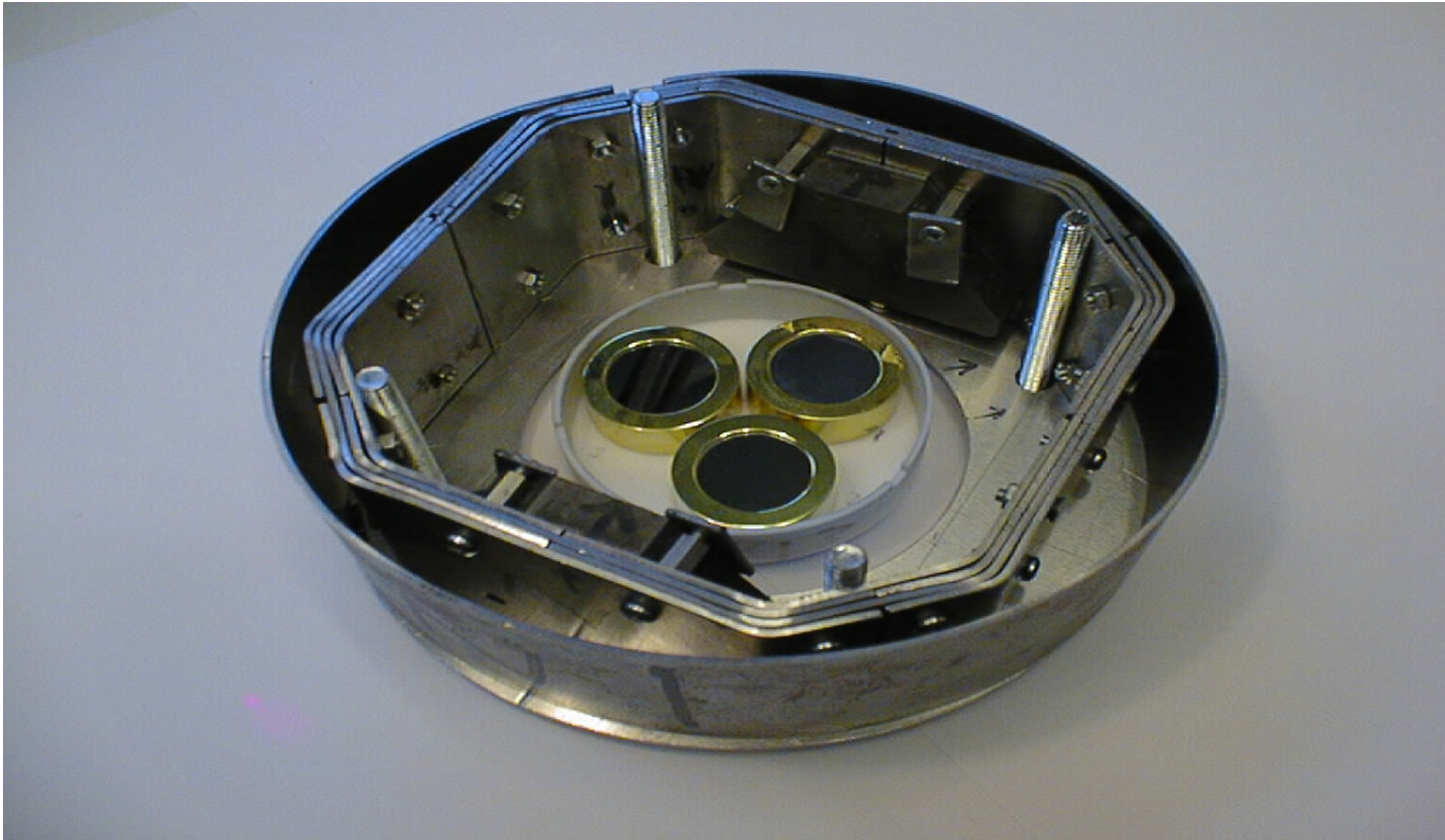

- Solid-state detectors developed for use in LHe
- Thin surface film of ${}^6\text{LiF}$: $n + {}^6\text{Li} \rightarrow \alpha + {}^3\text{H}$

UCN detection in liquid helium

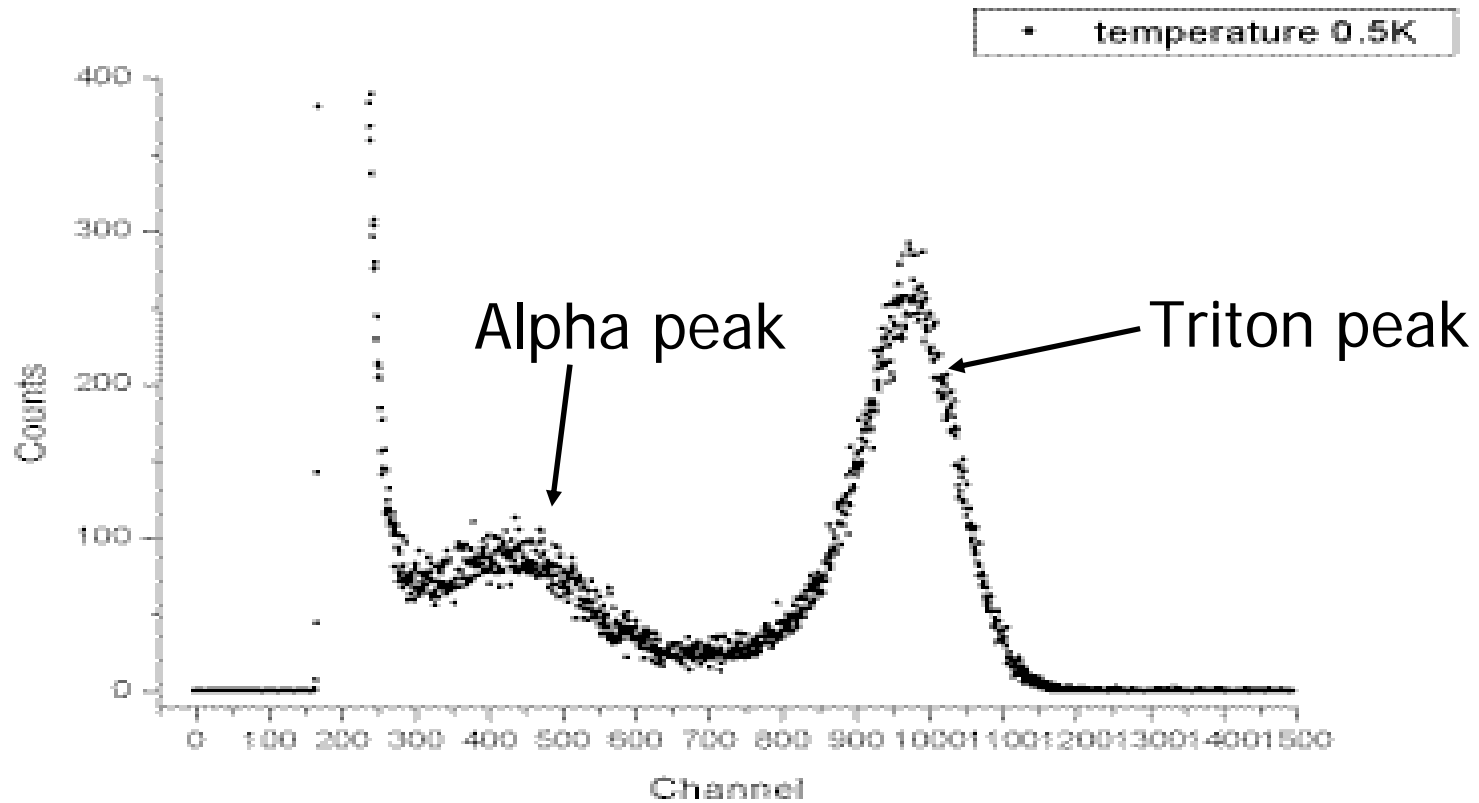

C.A.Baker *et al.*, NIM A487 511-520 (2002)

Statistical limits

$$\sigma_d = \frac{\hbar/2}{\alpha E T \sqrt{N}}$$

Parameter	Room-tmpr. expt	Sensitivity
■ Polarisation+ detection:	$\alpha = 0.75$	x 1.2
■ Electric field:	$E = 10^6$ V/m	x 4
■ Precession period:	$T = 130$ s	x 2
■ Neutrons counted:	$N = 6 \times 10^6$ /day	x 4.5
(with new beamline)		x 2.6

Total increase approx factor 100

CryoEDM overview

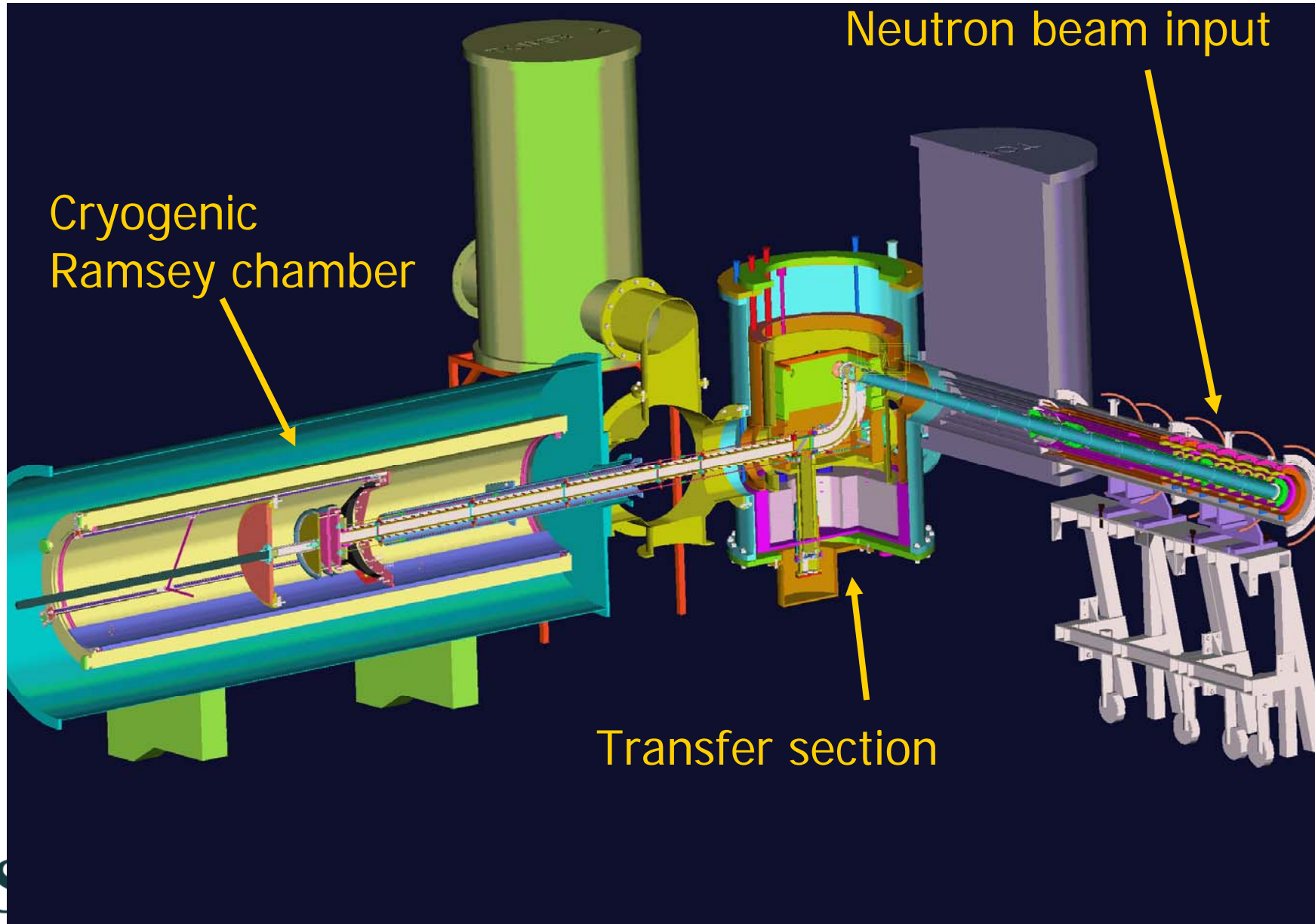

Cryogenic Ramsey chamber

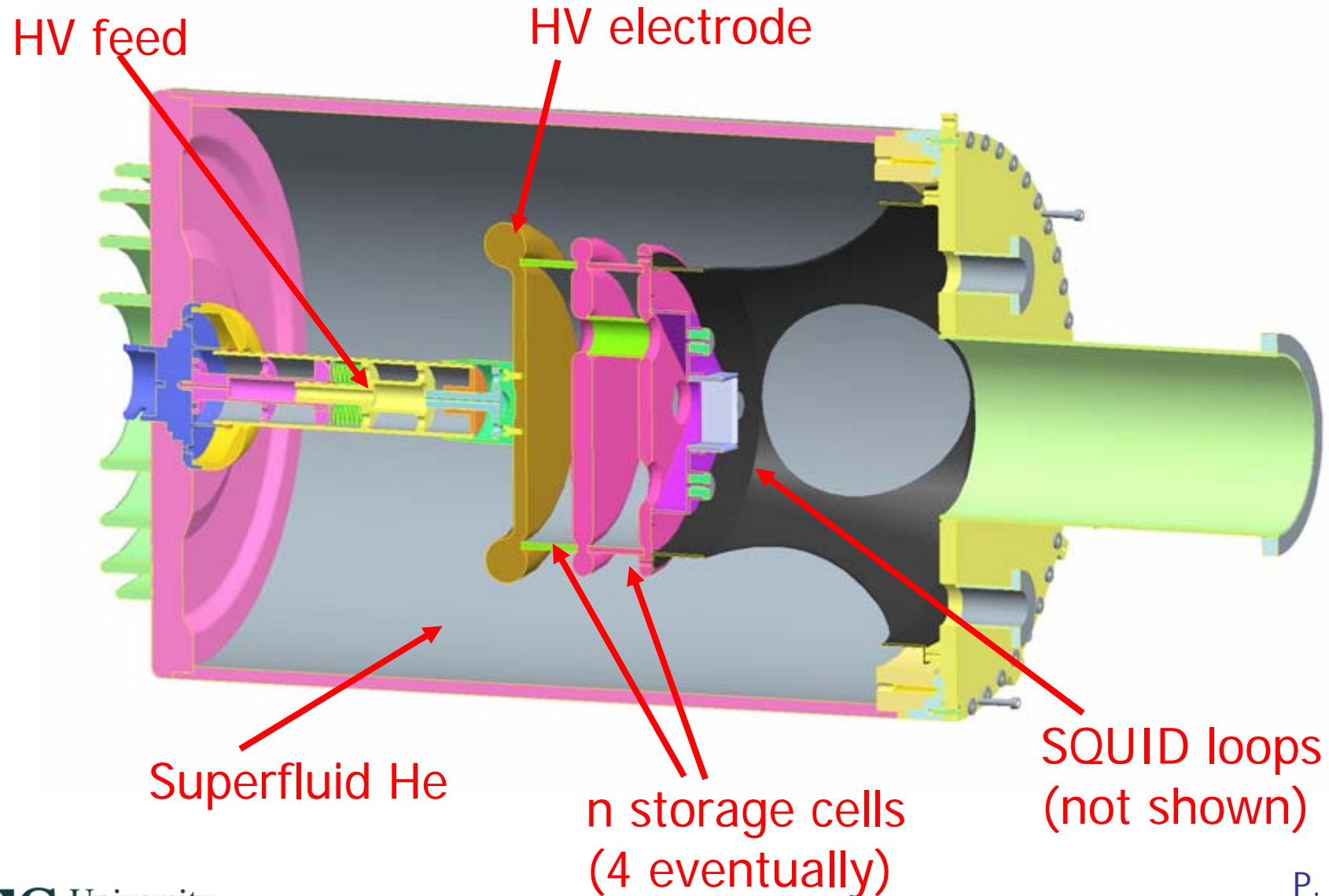

Ramsey cell and HV stack

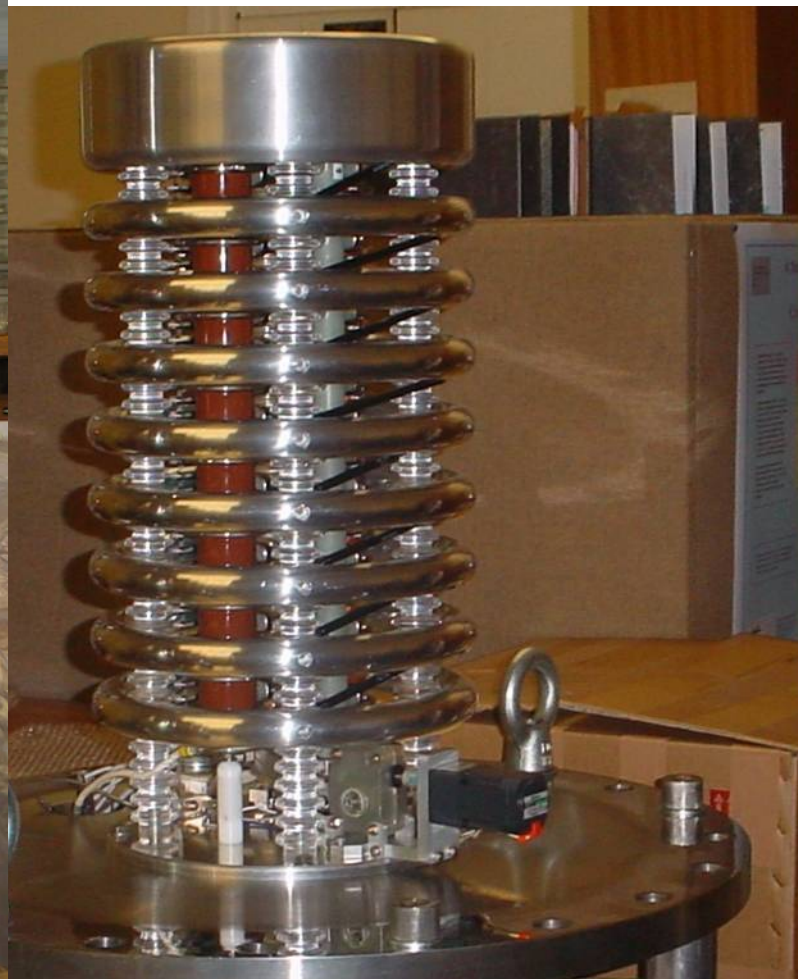

Systematics

- B-field fluctuations
 - Superconducting solenoid & shield will give much improved field shape and shielding
 - SQUIDs give temporal variation (common-mode)
 - Shielding not optimal at present: improvements foreseen
- Geometric phase
 - n are $\sim 40x$ less sensitive than Hg
 - $1/B^2$: 5 x increase in B gives 25x protection
 - overall 1000x improvement

Systematics

- Other:
 - **Exv**: $3\text{E-}29$ e.cm
 - Feedback from field coils: $< 1\text{E-}30$ e.cm
 - Electrostatic forces: $< 1\text{E-}28$ e.cm
 - Leakage currents: 1 nA $\rightarrow 5\text{E-}29$ e.cm
 - AC fields from HV: $< 1\text{E-}29$ e.cm
- Overall: no show-stoppers...

Current status



- Final assembly and testing underway
- First neutrons expected autumn 06
- B-field scanning December 06
- High voltage installation spring 07
- **Data taking begins summer 2007**
 - First results ~2009 at $\sim 1\text{E}-27$ level
 - New beamline ~2009?

CryoEDM at SNS, ORNL

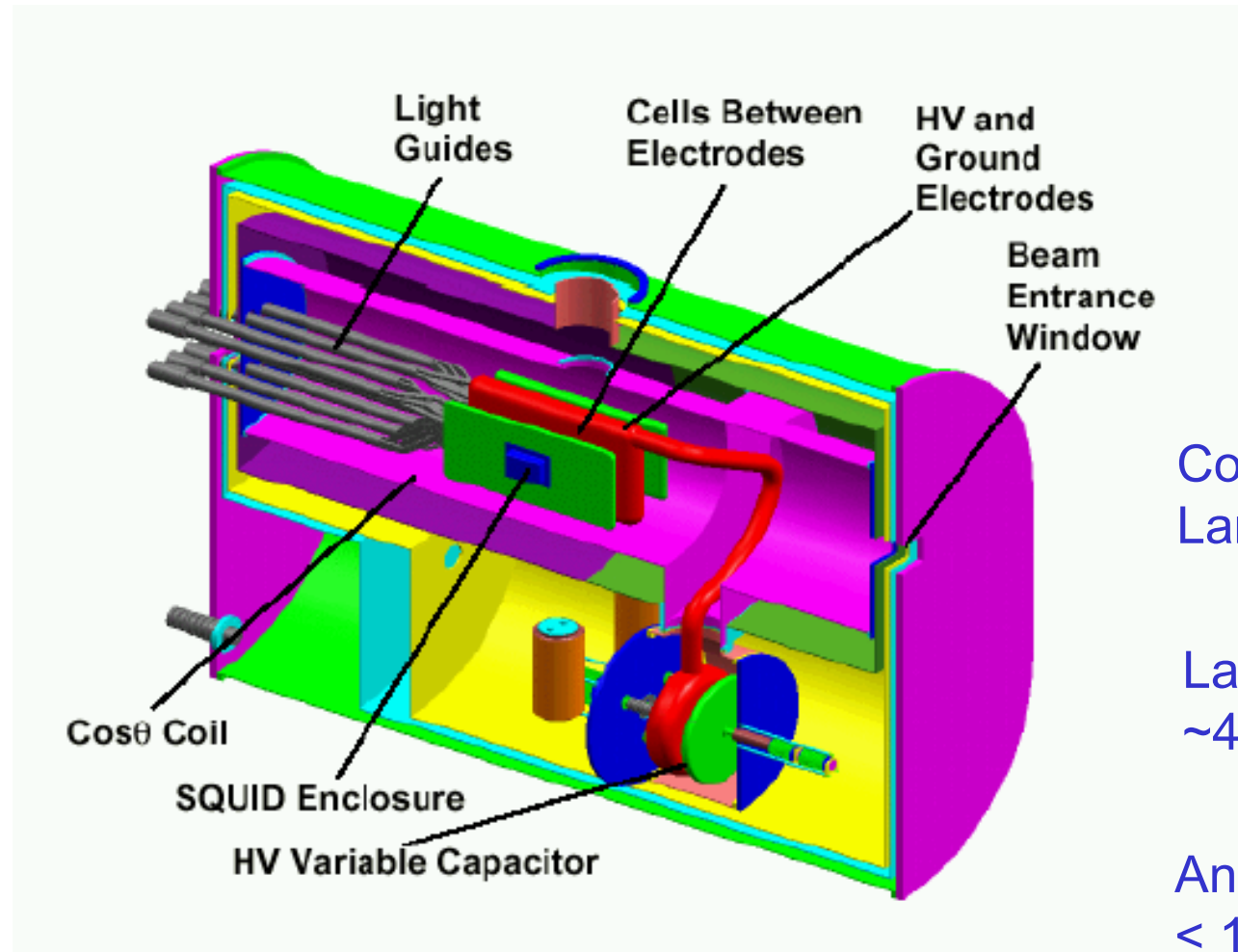

Concept by Golub & Lamoreaux, 1994

Large US collaboration:
~40 people, \$16M

Anticipated sensitivity
< 10^{-28} e.cm

CryoEDM at SNS, ORNL

1.4 MW (1 GeV proton, 1.4 A) spallation source

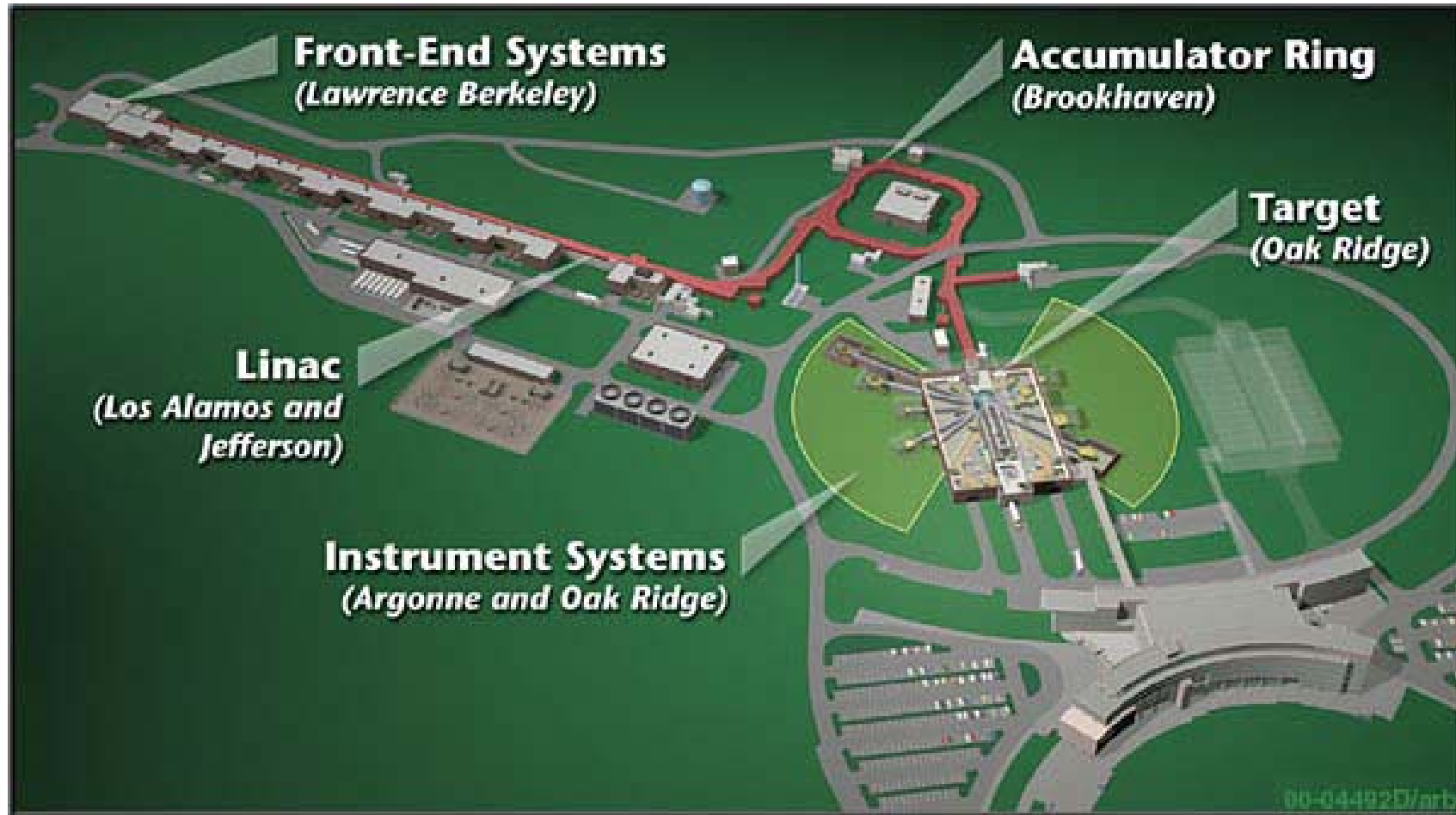

First proton beam: April 2006

FNPB beamline (2007)

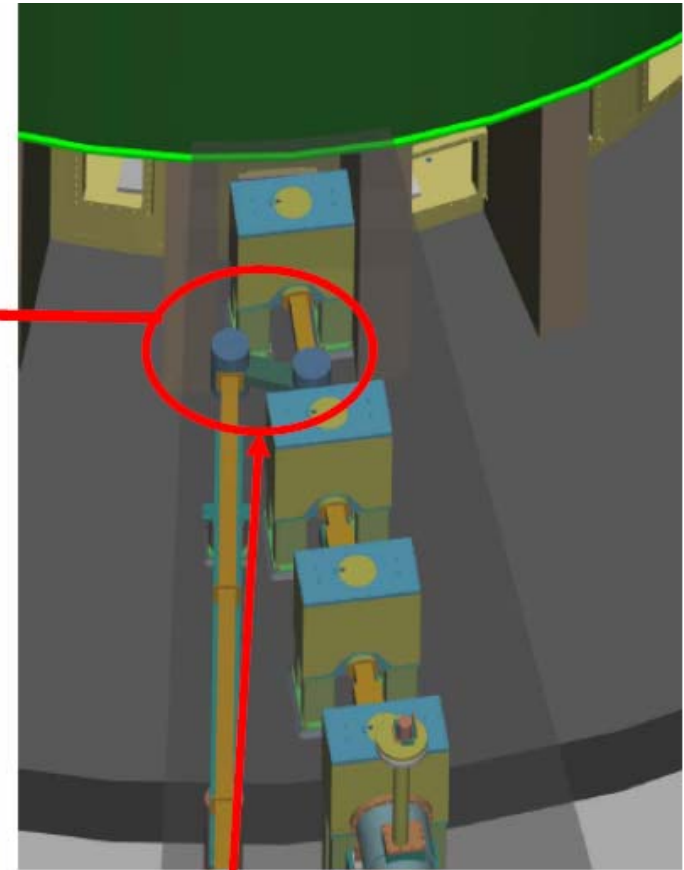
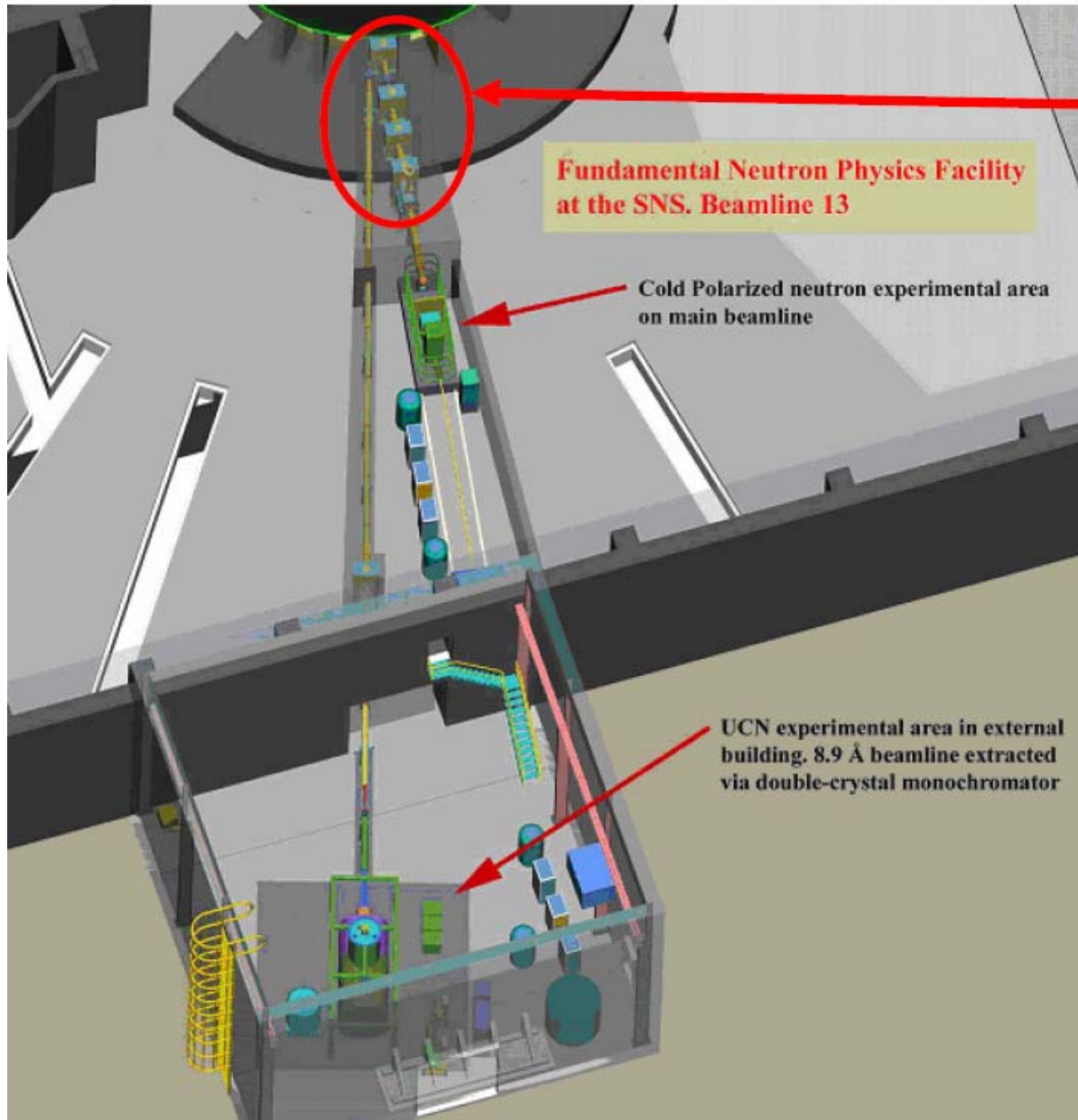

Double monochromator

Selects 8.9 \AA neutrons for UCN via LHe

Spin precession measurement

- Add polarized ^3He to the bottle
- Strongly spin-dependent n absorption

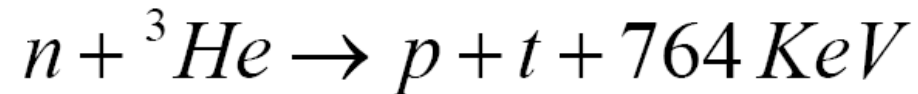

Total spin	σ_{abs} at $v = 5\text{m/sec}$
$J = 0$	$\sim 4.8 \times 10^6$ barns
$J = 1$	~ 0

- Detect scintillation light from
 $n + {}^3\text{He} \rightarrow p + t$
- “Beats” with ^3He precession

SQUID & scintillator signals

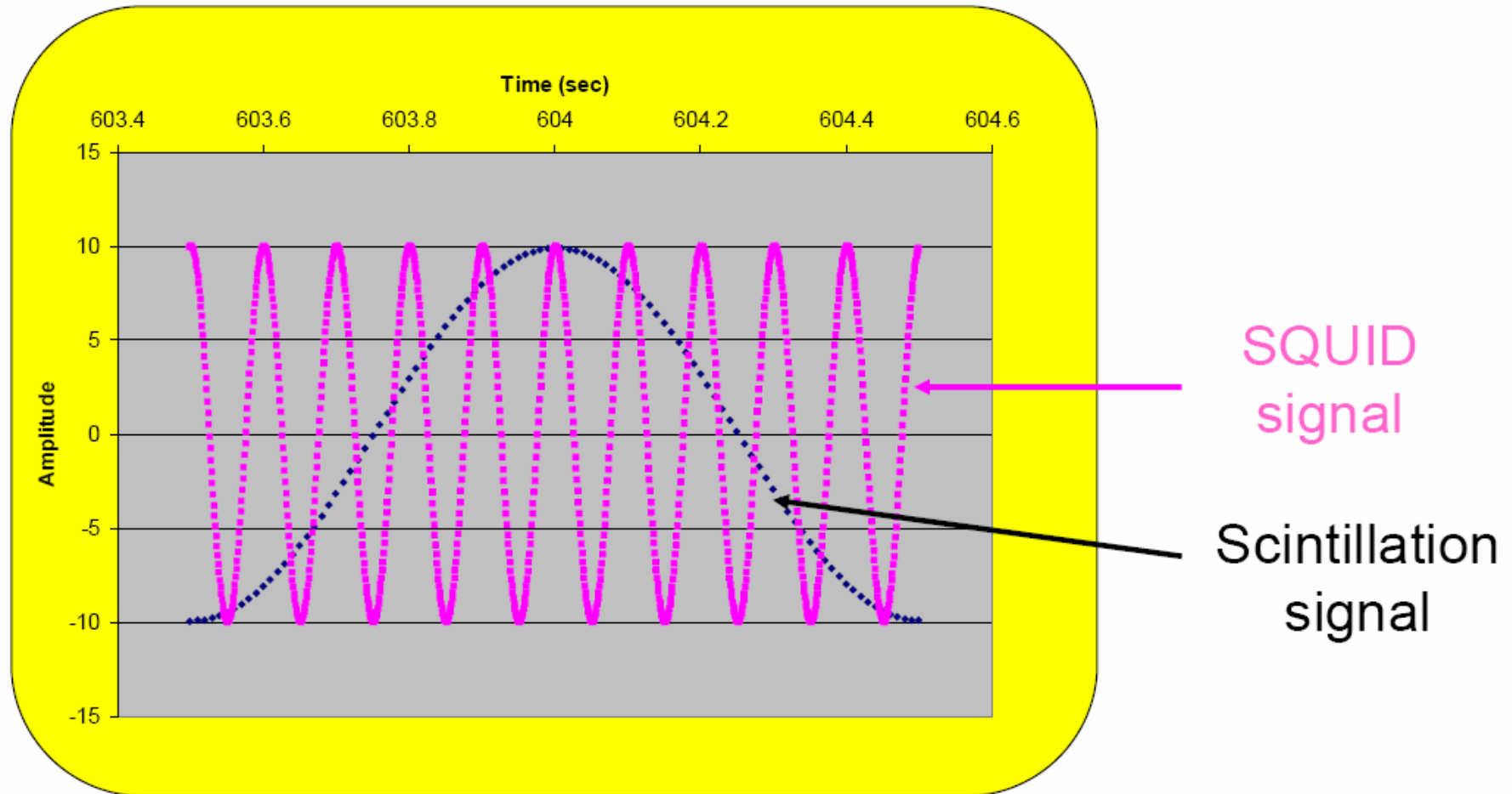

Schedule

- CD0 Nov. 05
- Various tests underway
 - HV: reached 30 kV/cm so far in He below λ pt
 - Studied ^3He diffusion in ^4He
 - ^3He relaxation time $T1 > 3000$ s in 1.9 K ^4He
- Anticipate CD1 Nov. 06
- Assuming funded, construction could begin 07
- Commissioning anticipated 2012
- Results in....?

Conclusions



- **New nEDM limit, 2.9×10^{-26} e.cm**
- Systematics understood as never before
- **CryoEDM** coming soon – **100x** more sensitive
- SNS CryoEDM: construction to start 2007?
- Watch this space!

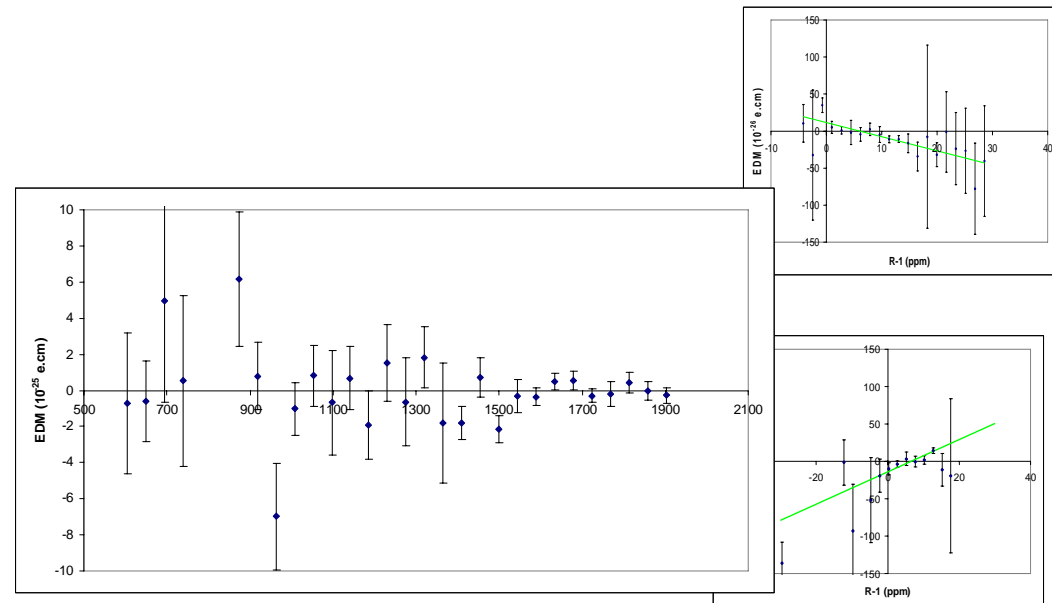
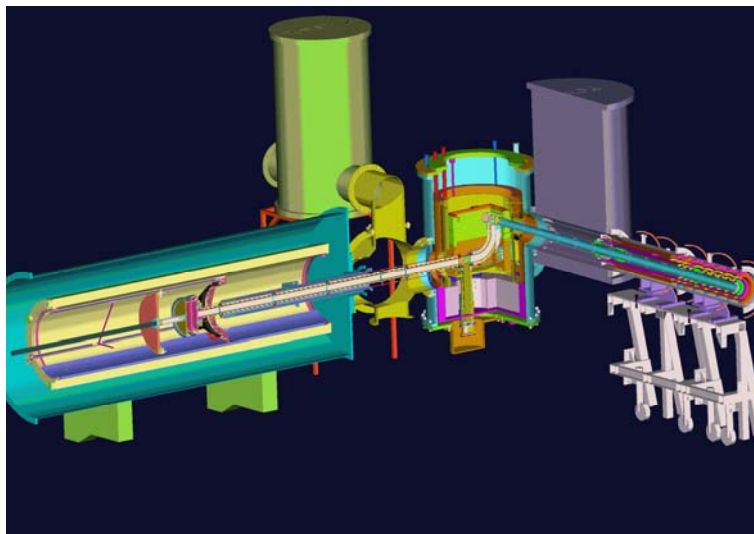

And finally...



“It may be that the next exciting thing to come along will be the discovery of a neutron or atomic or electron electric dipole moment. These electric dipole moments... seem to me to offer one of the most exciting possibilities for progress in particle physics.”

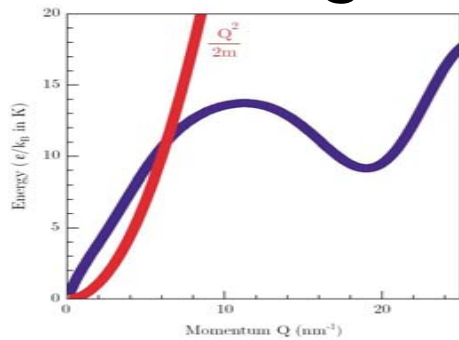

- S. Weinberg

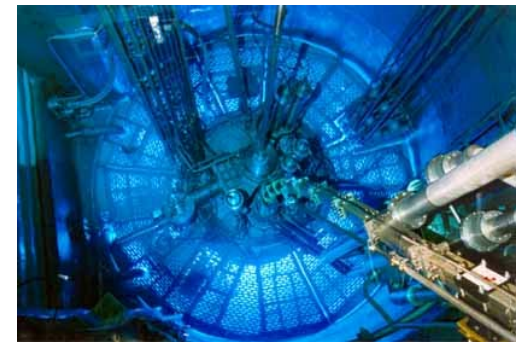
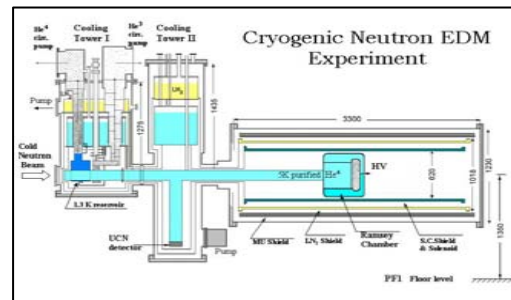
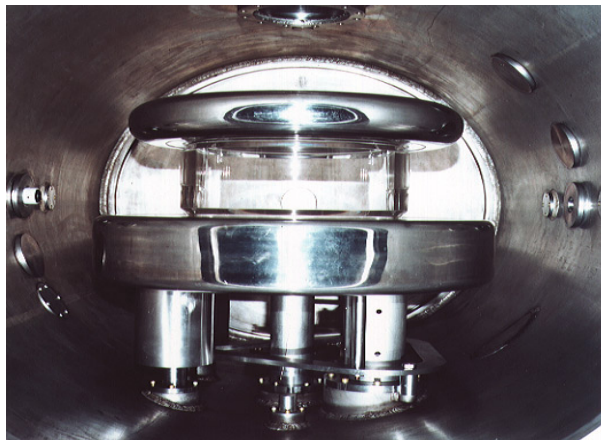

P. Harris
CERN, 9/10/2006

spare slides

Further reading

- Web site www.neutroneidm.org
- Room-temperature result: [hep-ex/0602020](#)
- Theory: see, e.g., refs in [hep-ex/0602020](#)
- Geometric phase: [J. Pendlebury et al., PRA 70 032102 \(2004\)](#); and [P. Harris, J. Pendlebury, PRA 73 014101 \(2006\)](#)
- n production in helium: [C.A.Baker et al., Phys.Lett. A308 67-74 \(2002\)](#)
- Detectors: [C.A.Baker et al., NIM A487 511-520 \(2002\)](#)

Auxiliary bottle measurements

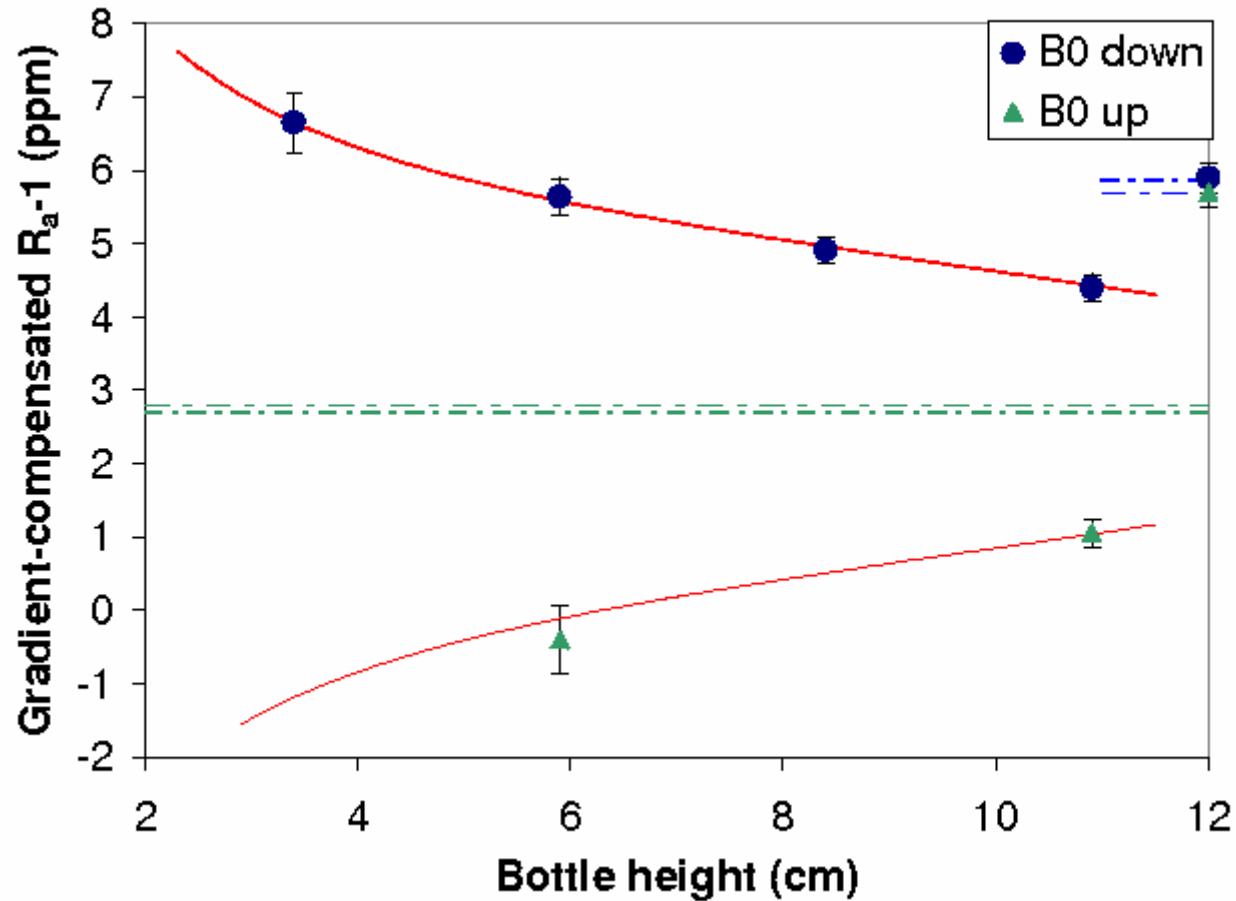

Error budget (10^{-26} e.cm)

Effect	Shift	Uncertainty
Statistical	0	1.51
Door cavity dipole; quadrupole fields	-0.69	0.28
Other GP dipole shifts	0	0.60
$(\mathbf{E} \times \mathbf{v})/c^2$ from translation	0	0.003
$(\mathbf{E} \times \mathbf{v})/c^2$ from rotation	0	0.10
Light shift: direct & GP	0.35	0.08
B fluctuations	0	0.24
E forces – distortion of bottle	0	0.04
Tangential leakage currents	0	0.01
AC B fields from HV ripple	0	0.001
Hg atom EDM	-0.04	0.03
2 nd order $\mathbf{E} \times \mathbf{v}$	0	0.002
	Total	1.51 stat, 0.72 sys

Neutron EDM results (individual runs)

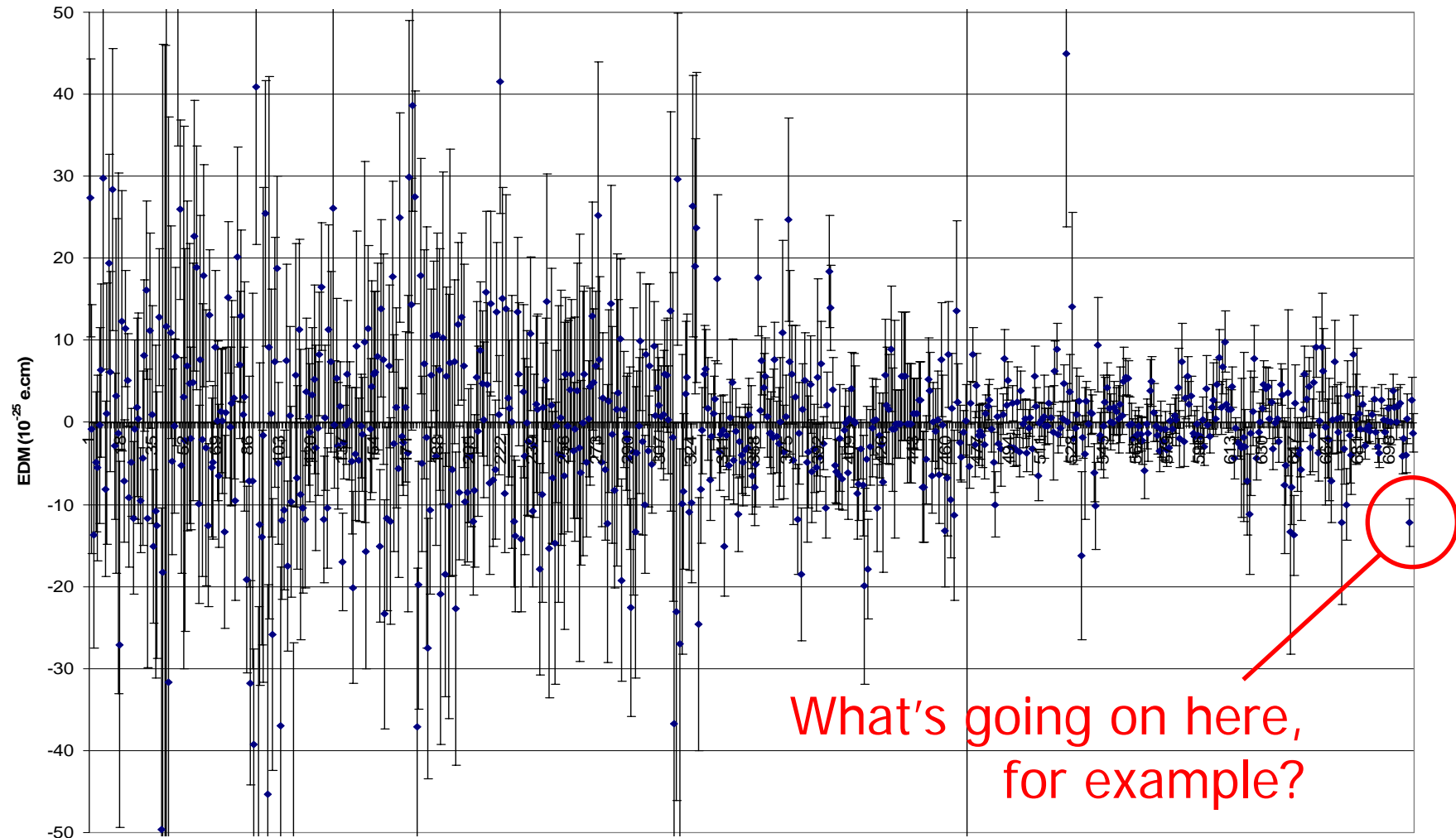

nEDM apparatus

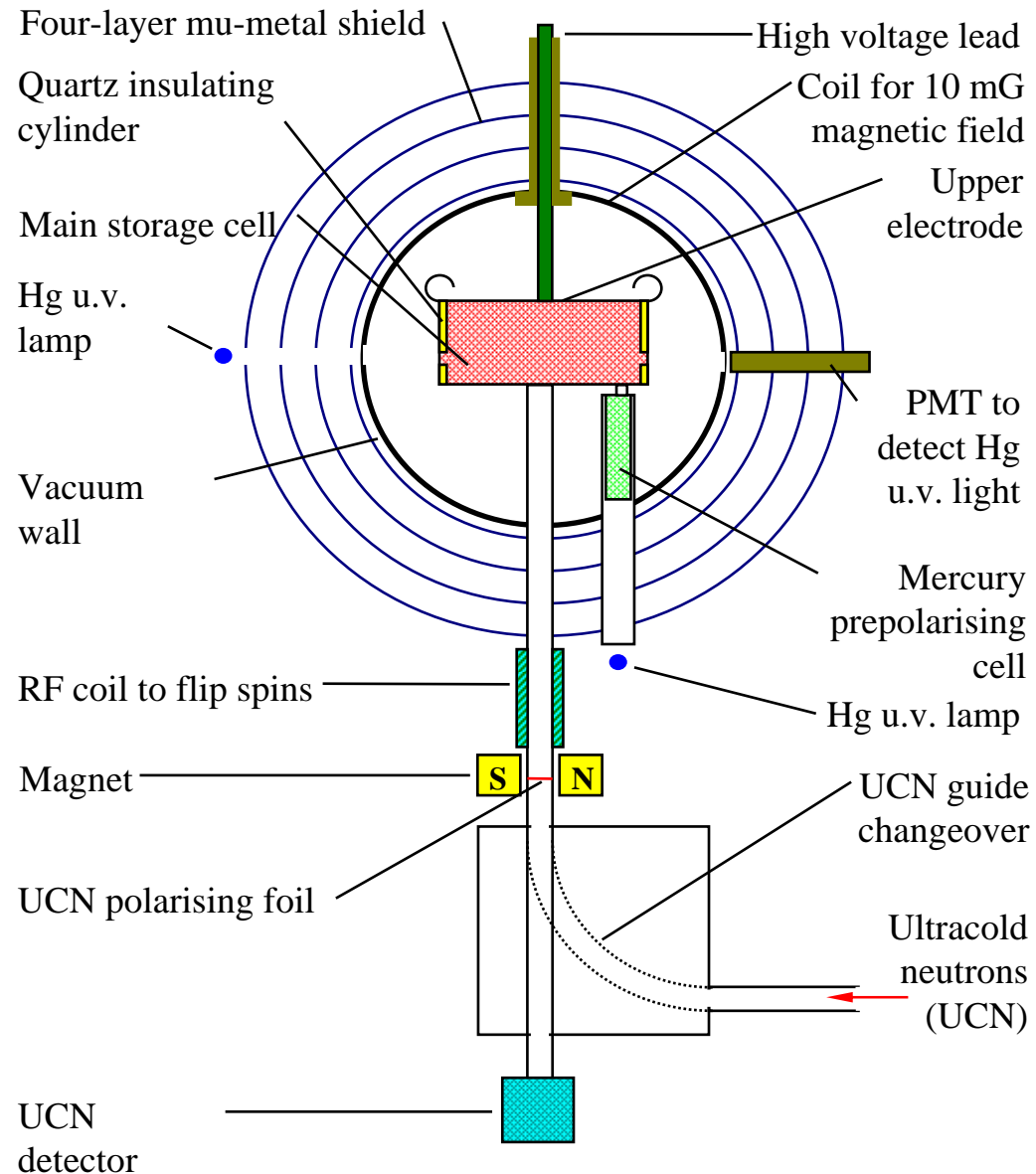

Magnetometry

- SQUID Magnetometers
 - Developed at Oxford for CRESST
 - fT sensitivity:
adequate to monitor field fluctuations

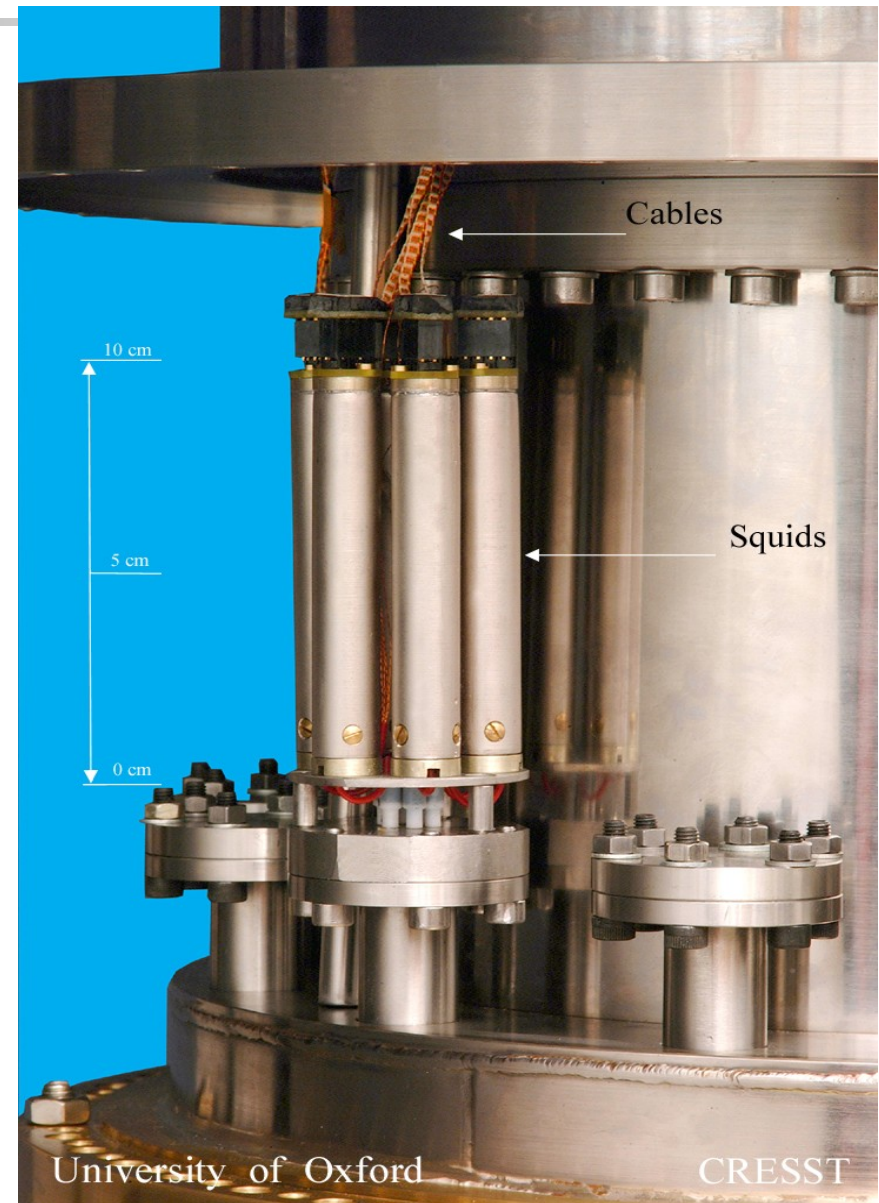

CERN, 9/10/2006

nEDM measurement

- Keep track of neutron resonant frequency
- Look for **changes correlated with changes in E**

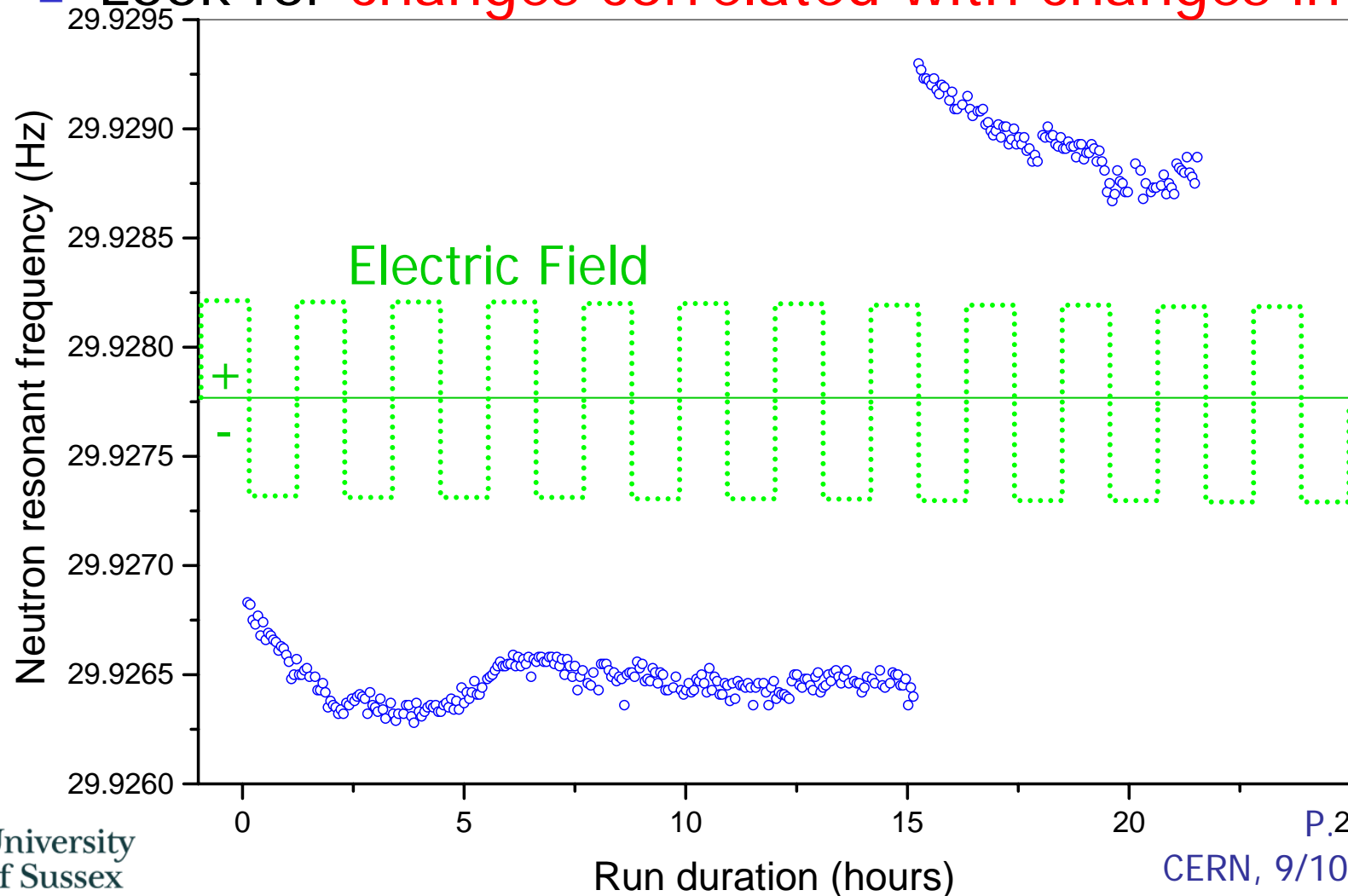

Neutron frequency (from before; 1 day)

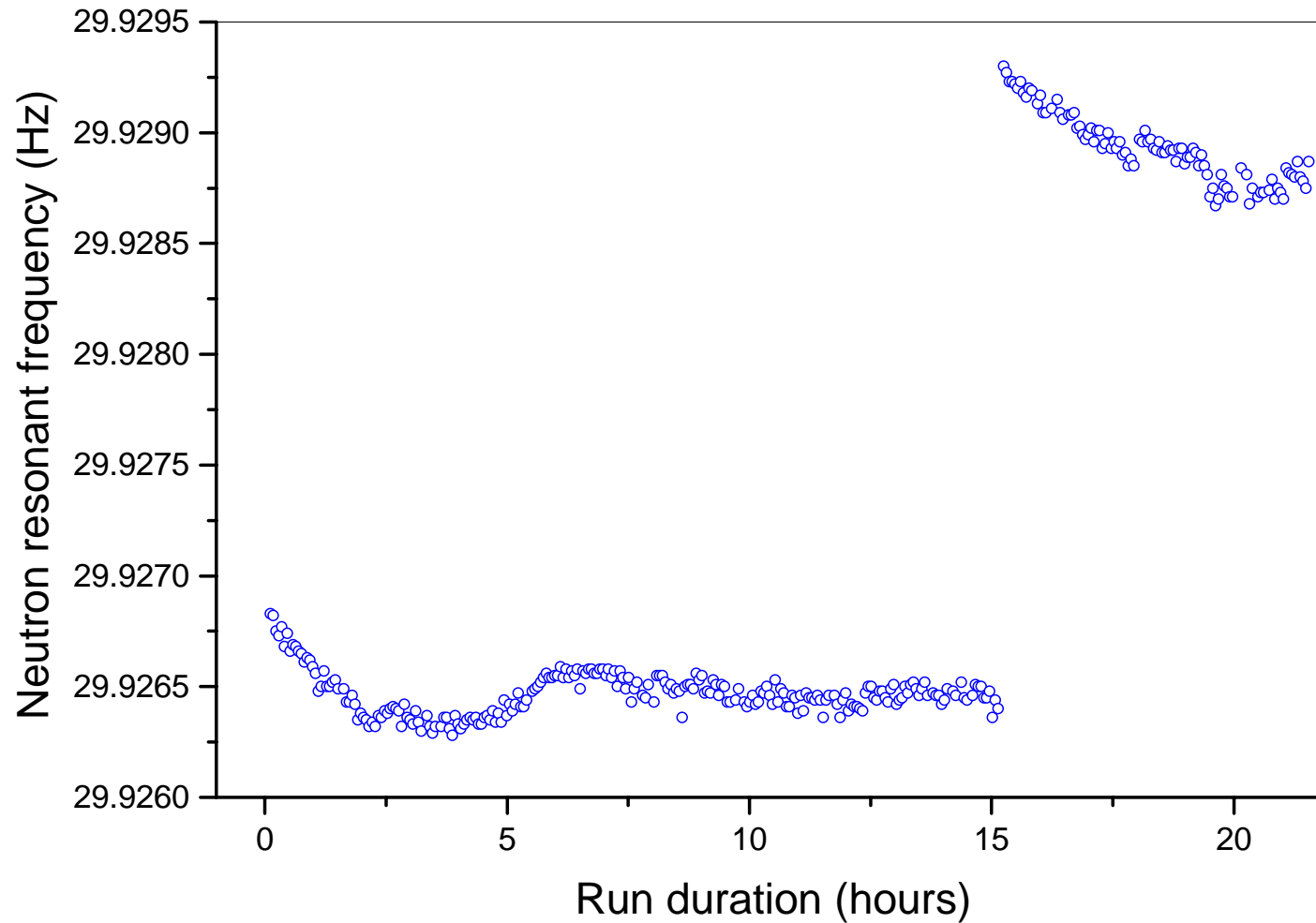

Mercury frequency

