

# Test Fundamental Symmetries via Light Meson Decays

Liping Gan  
University of North Carolina Wilmington

## Outline

1. Introduction  
→ challenges in physics
2. PrimEx experiments on  $\pi^0$ ,  $\eta$ ,  $\eta'$   
→ precision tests confinement QCD symmetries
3. Jlab Eta Factory (JEF) Program for SM forbidden or allowed  $\eta$  decays  
→ search for BSM new physics
4. Summary

# Challenges in Physics

## ➤ Confinement QCD

- QCD confinement and its relationship to the dynamical chiral symmetry breaking

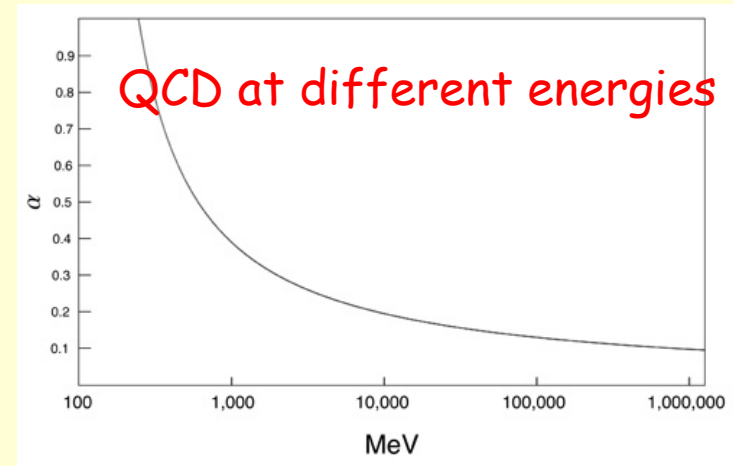

## ➤ New physics beyond the Standard Model (SM)

- Dark matter and dark energy
- New sources of CP violation

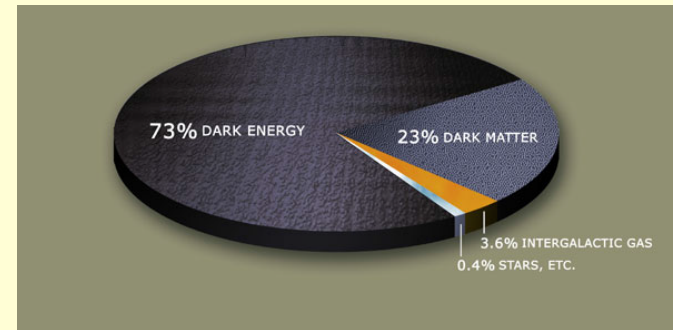

"As far as I see, all priori statements in physics have their origin in symmetry". By H. Weyl

# QCD Symmetries and Light Mesons

- QCD Lagrangian in Chiral limit ( $m_q \rightarrow 0$ ) is invariant under:

$$SU_L(3) \times SU_R(3) \times U_A(1) \times U_B(1)$$

- Chiral symmetry  $SU_L(3) \times SU_R(3)$  spontaneously breaks to  $SU(3)$

- 8 Goldstone Bosons (GB)

- $U_A(1)$  is explicitly broken: (Chiral anomalies)

- $\Gamma(\pi^0 \rightarrow \gamma\gamma)$ ,  $\Gamma(\eta \rightarrow \gamma\gamma)$ ,  $\Gamma(\eta' \rightarrow \gamma\gamma)$
  - Mass of  $\eta_0$

- $SU_L(3) \times SU_R(3)$  and  $SU(3)$  are explicitly broken:

- GB are massive
  - Mixing of  $\pi^0$ ,  $\eta$ ,  $\eta'$

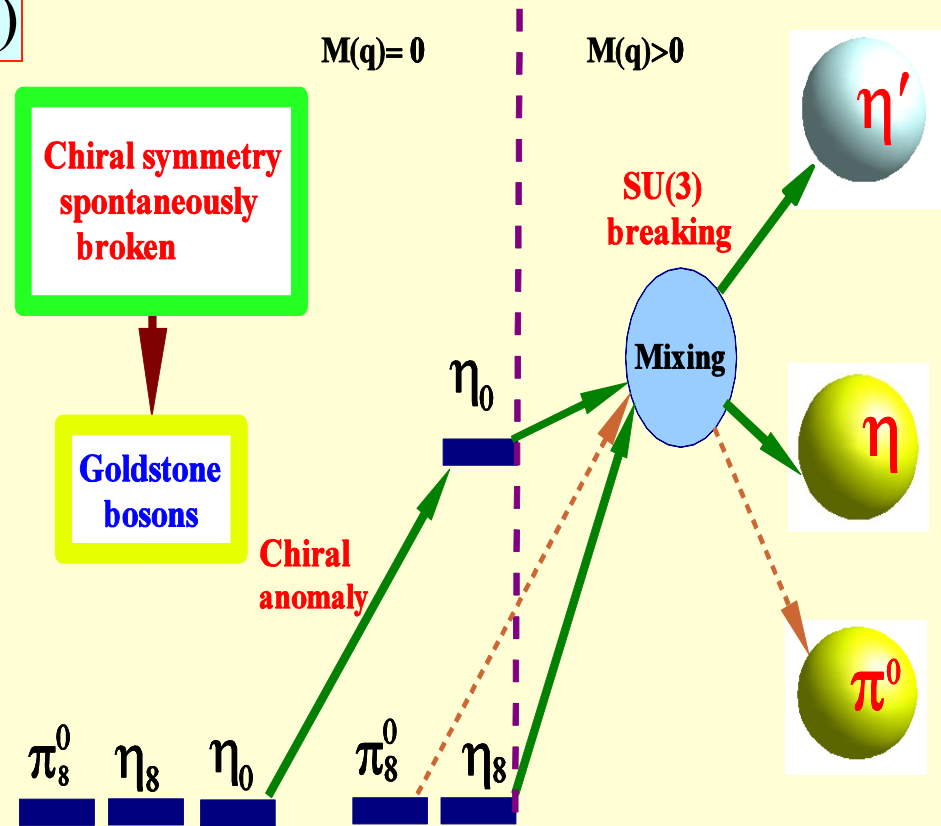

The  $\pi^0$ ,  $\eta$ ,  $\eta'$  system provides a rich laboratory to study the symmetry structure of QCD at low energies.

# Primakoff Program at Jlab 6 & 12 GeV

Precision measurements of electromagnetic properties of  $\pi^0$ ,  $\eta$ ,  $\eta'$  via Primakoff effect.

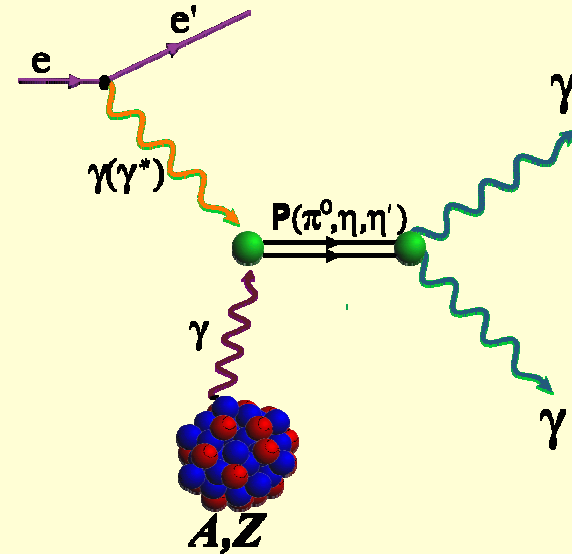

## a) Two-Photon Decay Widths:

- 1)  $\Gamma(\pi^0 \rightarrow \gamma\gamma)$  @ 6 GeV
- 2)  $\Gamma(\eta \rightarrow \gamma\gamma)$
- 3)  $\Gamma(\eta' \rightarrow \gamma\gamma)$

### Input to Physics:

- precision tests of Chiral symmetry and anomalies
- determination of light quark mass ratio
- $\eta$ - $\eta'$  mixing angle

## b) Transition Form Factors at low

$Q^2$  (0.001-0.5  $\text{GeV}^2/c^2$ ):

$F(\gamma\gamma^* \rightarrow \pi^0)$ ,  $F(\gamma\gamma^* \rightarrow \eta)$ ,  $F(\gamma\gamma^* \rightarrow \eta')$

### Input to Physics:

- $\pi^0, \eta$  and  $\eta'$  electromagnetic interaction radii
- is the  $\eta'$  an approximate Goldstone boson?
- inputs to  $a_\mu$  (HLbL) calculations

# Axial Anomaly Determines $\pi^0$ Lifetime

- ◆  $\pi^0 \rightarrow \gamma\gamma$  decay proceeds primarily via the **chiral anomaly** in QCD.
- ◆ The chiral anomaly prediction **is exact** for massless quarks:

$$\Gamma(\pi^0 \rightarrow \gamma\gamma) = \frac{\alpha^2 N_c^2 m_\pi^3}{576\pi^3 F_\pi^2} = 7.725 \text{ eV}$$

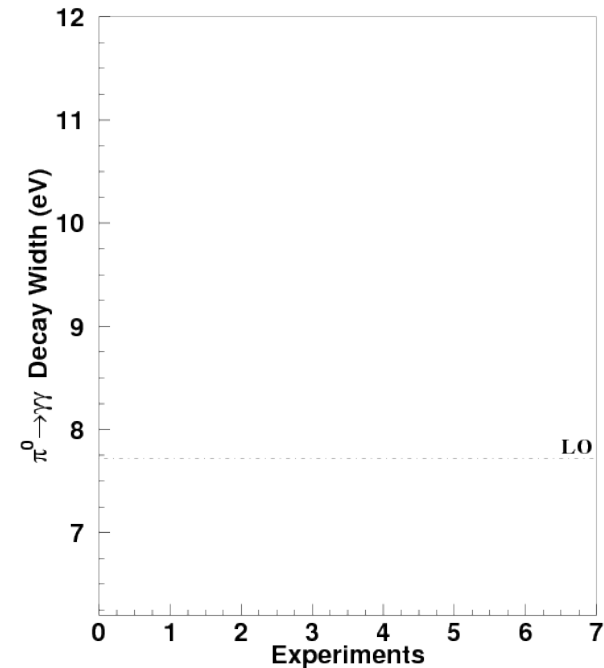
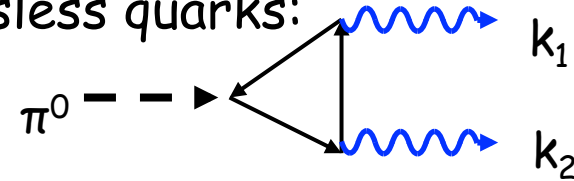

# Axial Anomaly Determines $\pi^0$ Lifetime

- ◆  $\pi^0 \rightarrow \gamma\gamma$  decay proceeds primarily via the **chiral anomaly** in QCD.
- ◆ The chiral anomaly prediction **is exact** for massless quarks:

$$\Gamma(\pi^0 \rightarrow \gamma\gamma) = \frac{\alpha^2 N_c^2 m_\pi^3}{576\pi^3 F_\pi^2} = 7.725 \text{ eV}$$

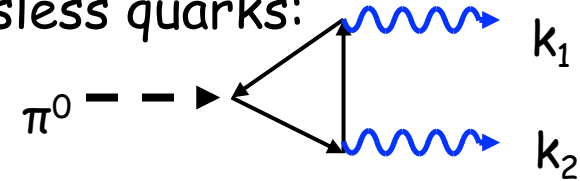

- ◆  $\Gamma(\pi^0 \rightarrow \gamma\gamma)$  is one of the few quantities in confinement region that QCD can calculate precisely at  $\sim 1\%$  level to higher orders!

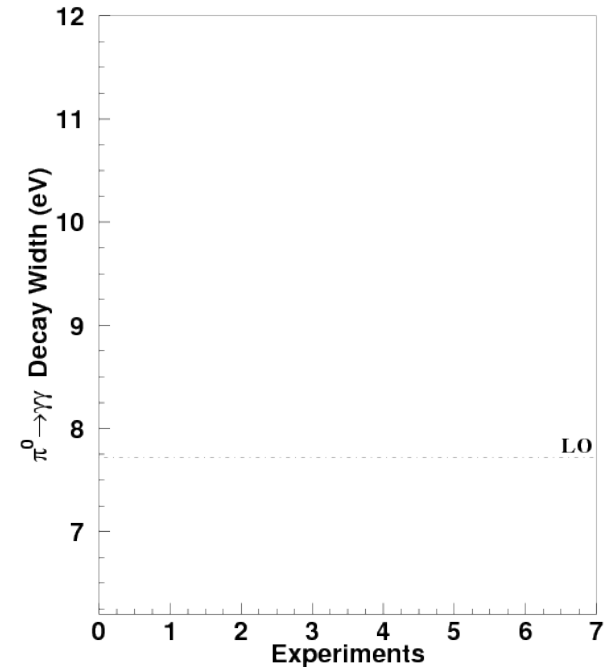

# Axial Anomaly Determines $\pi^0$ Lifetime

◆  $\pi^0 \rightarrow \gamma\gamma$  decay proceeds primarily via the **chiral anomaly** in QCD.

◆ The chiral anomaly prediction **is exact** for massless quarks:

$$\Gamma(\pi^0 \rightarrow \gamma\gamma) = \frac{\alpha^2 N_c^2 m_\pi^3}{576\pi^3 F_\pi^2} = 7.725 \text{ eV}$$

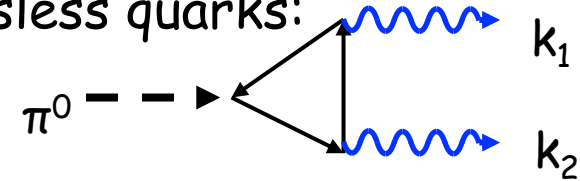

◆  $\Gamma(\pi^0 \rightarrow \gamma\gamma)$  is one of the few quantities in confinement region that QCD can calculate precisely at  $\sim 1\%$  level to higher orders!

➤ Corrections to the chiral anomaly prediction:

Calculations in NLO ChPT:

□  $\Gamma(\pi^0 \rightarrow \gamma\gamma) = 8.10 \text{ eV} \pm 1.0\%$

(J. Goity, et al. Phys. Rev. D66:076014, 2002)

□  $\Gamma(\pi^0 \rightarrow \gamma\gamma) = 8.06 \text{ eV} \pm 1.0\%$

(B. Ananthanarayan et al. JHEP 05:052, 2002)

Calculations in NNLO SU(2) ChPT:

□  $\Gamma(\pi^0 \rightarrow \gamma\gamma) = 8.09 \text{ eV} \pm 1.3\%$

(K. Kampf et al. Phys. Rev. D79:076005, 2009)

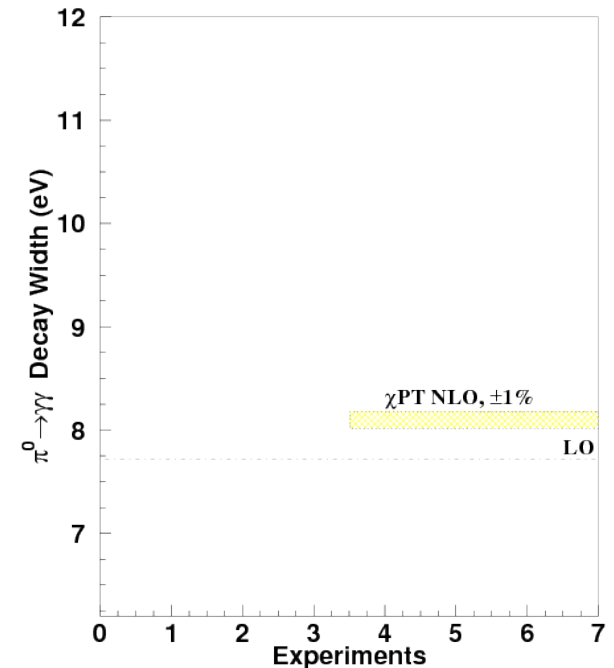

# Axial Anomaly Determines $\pi^0$ Lifetime

◆  $\pi^0 \rightarrow \gamma\gamma$  decay proceeds primarily via the **chiral anomaly** in QCD.

◆ The chiral anomaly prediction **is exact** for massless quarks:

$$\Gamma(\pi^0 \rightarrow \gamma\gamma) = \frac{\alpha^2 N_c^2 m_\pi^3}{576\pi^3 F_\pi^2} = 7.725 \text{ eV}$$

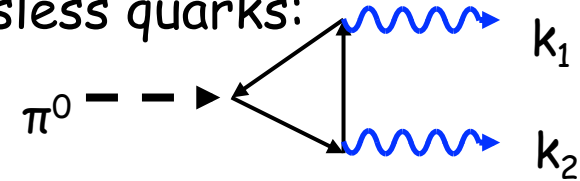

◆  $\Gamma(\pi^0 \rightarrow \gamma\gamma)$  is one of the few quantities in confinement region that QCD can calculate precisely at  $\sim 1\%$  level to higher orders!

➤ Corrections to the chiral anomaly prediction:

Calculations in NLO ChPT:

□  $\Gamma(\pi^0 \rightarrow \gamma\gamma) = 8.10 \text{ eV} \pm 1.0\%$

(J. Goity, et al. Phys. Rev. D66:076014, 2002)

□  $\Gamma(\pi^0 \rightarrow \gamma\gamma) = 8.06 \text{ eV} \pm 1.0\%$

(B. Ananthanarayan et al. JHEP 05:052, 2002)

Calculations in NNLO SU(2) ChPT:

□  $\Gamma(\pi^0 \rightarrow \gamma\gamma) = 8.09 \text{ eV} \pm 1.3\%$

(K. Kampf et al. Phys. Rev. D79:076005, 2009)

➤ Calculations in QCD sum rule:

□  $\Gamma(\pi^0 \rightarrow \gamma\gamma) = 7.93 \text{ eV} \pm 1.5\%$

(B.L. Ioffe, et al. Phys. Lett. B647, p. 389, 2007)

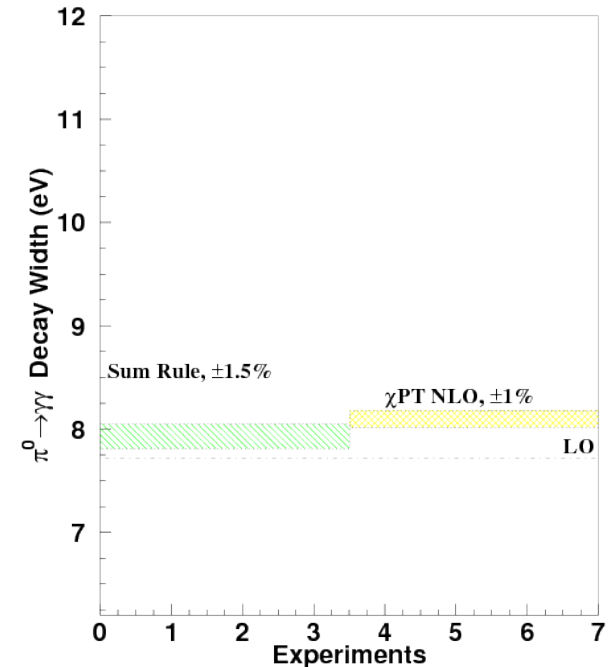



# Axial Anomaly Determines $\pi^0$ Lifetime

- ◆  $\pi^0 \rightarrow \gamma\gamma$  decay proceeds primarily via the **chiral anomaly** in QCD.

- ◆ The chiral anomaly prediction **is exact** for massless quarks:

$$\Gamma(\pi^0 \rightarrow \gamma\gamma) = \frac{\alpha^2 N_c^2 m_\pi^3}{576\pi^3 F_\pi^2} = 7.725 \text{ eV}$$

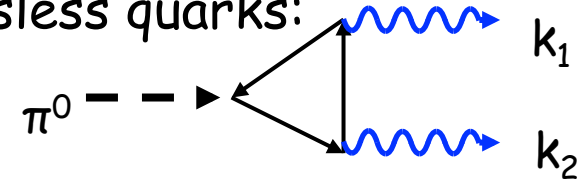

- ◆  $\Gamma(\pi^0 \rightarrow \gamma\gamma)$  is one of the few quantities in confinement region that QCD can calculate precisely at  $\sim 1\%$  level to higher orders!

- Corrections to the chiral anomaly prediction:

Calculations in NLO ChPT:

- $\Gamma(\pi^0 \rightarrow \gamma\gamma) = 8.10 \text{ eV} \pm 1.0\%$

(J. Goity, et al. Phys. Rev. D66:076014, 2002)

- $\Gamma(\pi^0 \rightarrow \gamma\gamma) = 8.06 \text{ eV} \pm 1.0\%$

(B. Ananthanarayan et al. JHEP 05:052, 2002)

Calculations in NNLO SU(2) ChPT:

- $\Gamma(\pi^0 \rightarrow \gamma\gamma) = 8.09 \text{ eV} \pm 1.3\%$

(K. Kampf et al. Phys. Rev. D79:076005, 2009)

- Calculations in QCD sum rule:

- $\Gamma(\pi^0 \rightarrow \gamma\gamma) = 7.93 \text{ eV} \pm 1.5\%$

(B.L. Ioffe, et al. Phys. Lett. B647, p. 389, 2007)

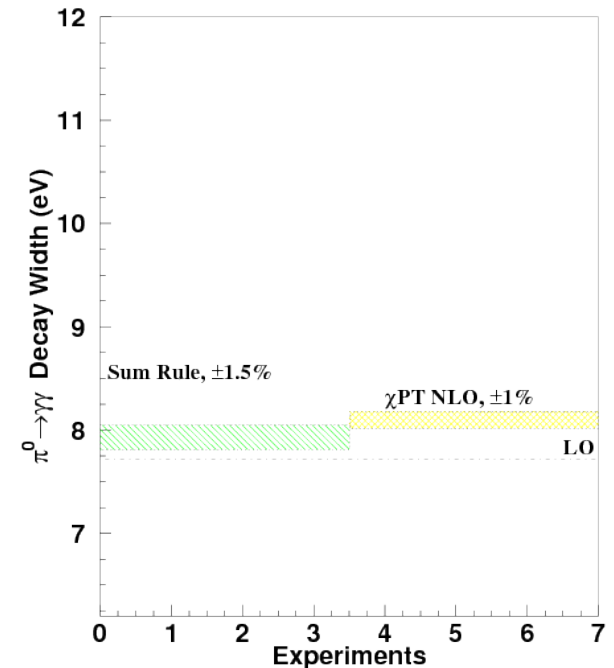

- ◆ **Precision measurement** of  $\Gamma(\pi^0 \rightarrow \gamma\gamma)$  at the percent level will provide a stringent test of low energy QCD.

# Axial Anomaly Determines $\pi^0$ Lifetime

◆  $\pi^0 \rightarrow \gamma\gamma$  decay proceeds primarily via the **chiral anomaly** in QCD.

◆ The chiral anomaly prediction **is exact** for massless quarks:

$$\Gamma(\pi^0 \rightarrow \gamma\gamma) = \frac{\alpha^2 N_c^2 m_\pi^3}{576\pi^3 F_\pi^2} = 7.725 \text{ eV}$$

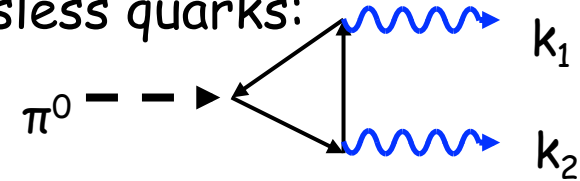

◆  $\Gamma(\pi^0 \rightarrow \gamma\gamma)$  is one of the few quantities in confinement region that QCD can calculate precisely at  $\sim 1\%$  level to higher orders!

➤ Corrections to the chiral anomaly prediction:

Calculations in NLO ChPT:

□  $\Gamma(\pi^0 \rightarrow \gamma\gamma) = 8.10 \text{ eV} \pm 1.0\%$

(J. Goity, et al. Phys. Rev. D66:076014, 2002)

□  $\Gamma(\pi^0 \rightarrow \gamma\gamma) = 8.06 \text{ eV} \pm 1.0\%$

(B. Ananthanarayan et al. JHEP 05:052, 2002)

Calculations in NNLO SU(2) ChPT:

□  $\Gamma(\pi^0 \rightarrow \gamma\gamma) = 8.09 \text{ eV} \pm 1.3\%$

(K. Kampf et al. Phys. Rev. D79:076005, 2009)

➤ Calculations in QCD sum rule:

□  $\Gamma(\pi^0 \rightarrow \gamma\gamma) = 7.93 \text{ eV} \pm 1.5\%$

(B.L. Ioffe, et al. Phys. Lett. B647, p. 389, 2007)

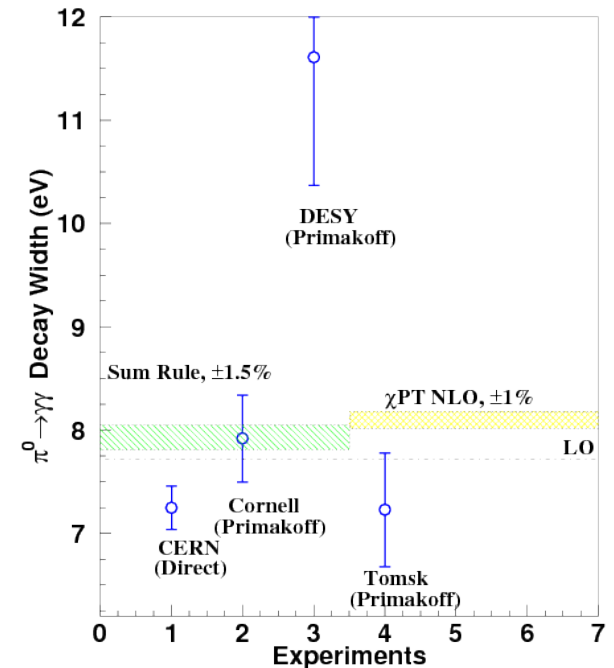

◆ **Precision measurement** of  $\Gamma(\pi^0 \rightarrow \gamma\gamma)$  at the percent level will provide a stringent test of low energy QCD.

# Primakoff Method

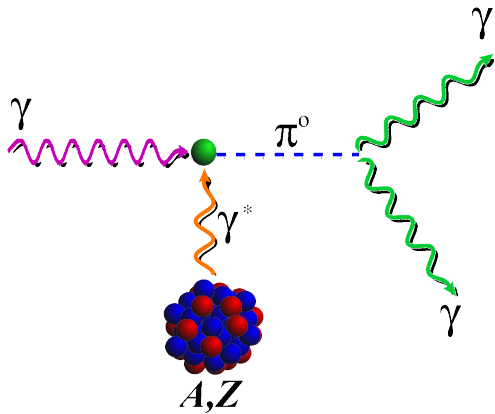

$$\frac{d\sigma_{\text{Pr}}}{d\Omega} = \Gamma_{\gamma\gamma} \frac{8\alpha Z^2}{m_\pi^3} \frac{\beta^3 E^4}{Q^4} |F_{e.m.}(Q)|^2 \sin^2 \theta_\pi$$

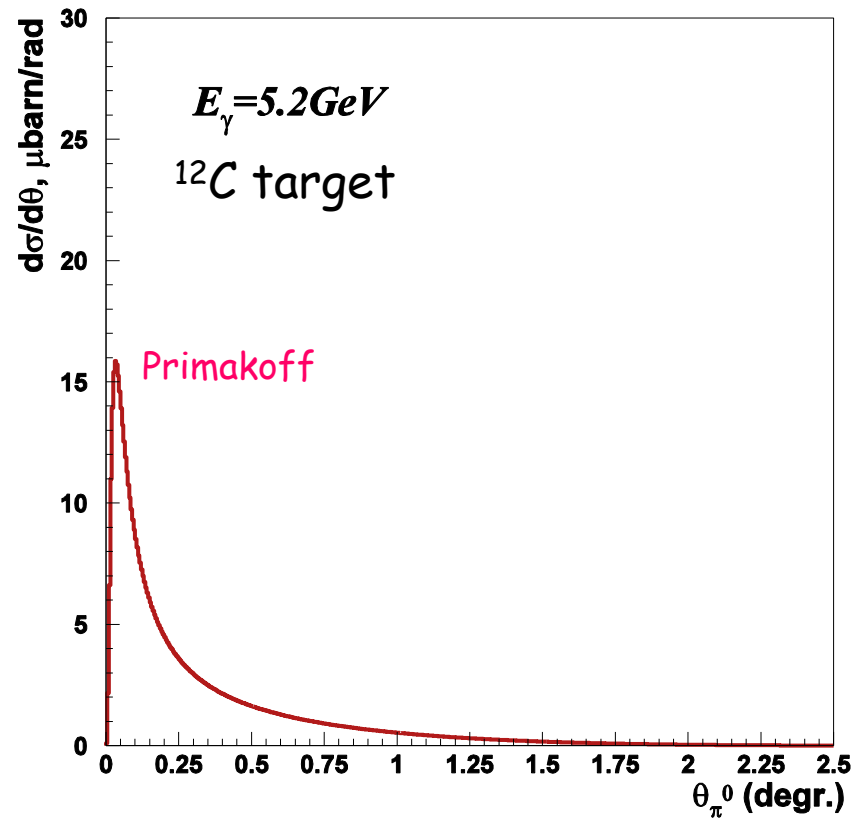

## Features of Primakoff cross section:

- Peaked at very small forward angle:

$$\langle \theta_{\text{Pr}} \rangle_{\text{peak}} \propto \frac{m^2}{2E^2}$$

- Beam energy sensitive:

$$\left\langle \frac{d\sigma_{\text{Pr}}}{d\Omega} \right\rangle_{\text{peak}} \propto E^4, \quad \int d\sigma_{\text{Pr}} \propto Z^2 \log(E)$$

- Coherent process

# Primakoff Method

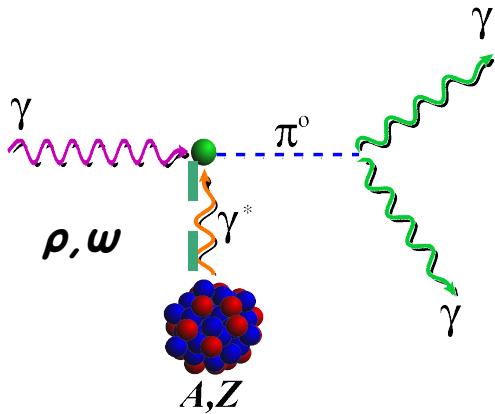

$$\frac{d\sigma_{\text{Pr}}}{d\Omega} = \Gamma_{\gamma\gamma} \frac{8\alpha Z^2}{m_\pi^3} \frac{\beta^3 E^4}{Q^4} |F_{e.m.}(Q)|^2 \sin^2 \theta_\pi$$

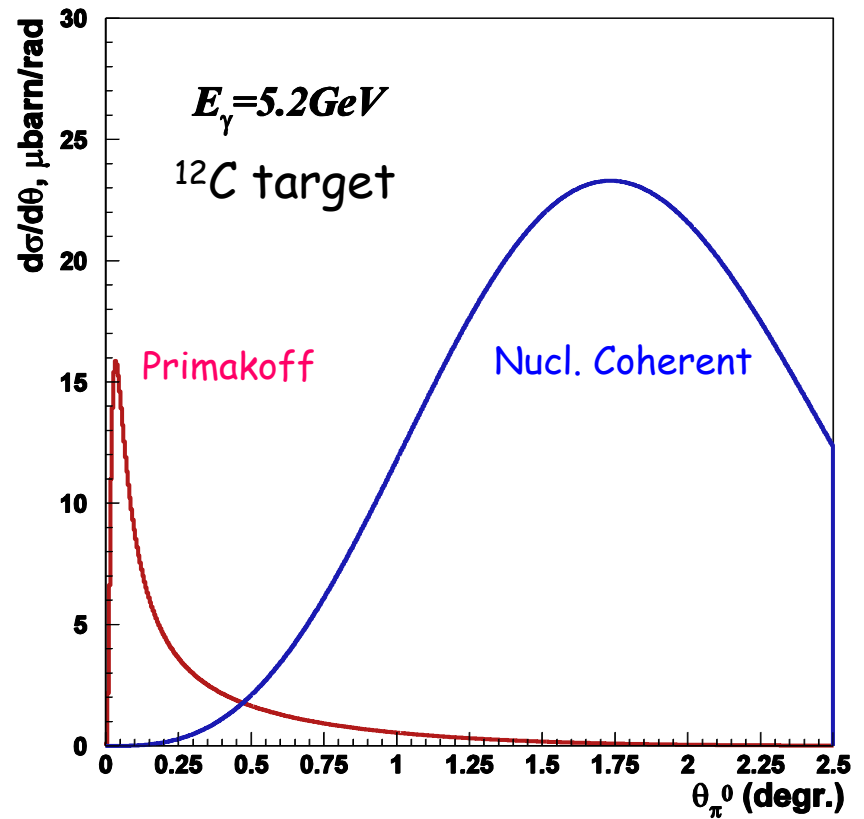

## Features of Primakoff cross section:

- Peaked at very small forward angle:

$$\langle \theta_{\text{Pr}} \rangle_{\text{peak}} \propto \frac{m^2}{2E^2}$$

- Beam energy sensitive:

$$\left\langle \frac{d\sigma_{\text{Pr}}}{d\Omega} \right\rangle_{\text{peak}} \propto E^4, \quad \int d\sigma_{\text{Pr}} \propto Z^2 \log(E)$$

- Coherent process

# Primakoff Method

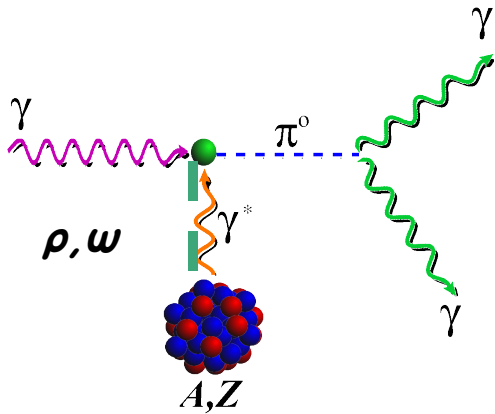

$$\frac{d\sigma_{\text{Pr}}}{d\Omega} = \Gamma_{\gamma\gamma} \frac{8\alpha Z^2}{m_\pi^3} \frac{\beta^3 E^4}{Q^4} |F_{e.m.}(Q)|^2 \sin^2 \theta_\pi$$

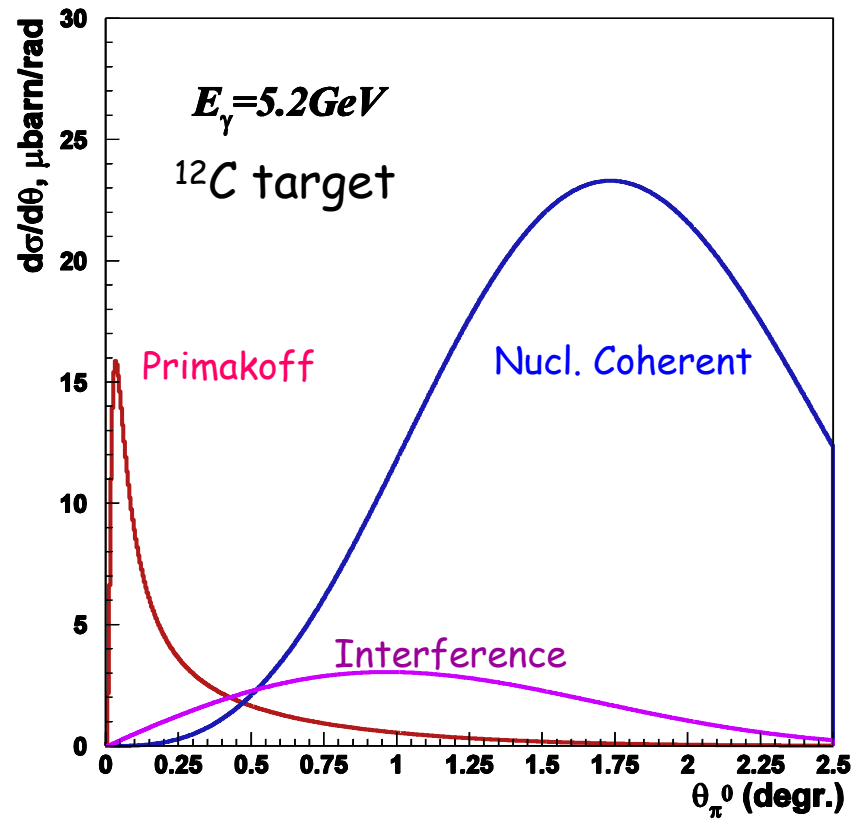

## Features of Primakoff cross section:

- Peaked at very small forward angle:

$$\langle \theta_{\text{Pr}} \rangle_{\text{peak}} \propto \frac{m^2}{2E^2}$$

- Beam energy sensitive:

$$\left\langle \frac{d\sigma_{\text{Pr}}}{d\Omega} \right\rangle_{\text{peak}} \propto E^4, \quad \int d\sigma_{\text{Pr}} \propto Z^2 \log(E)$$

- Coherent process

# Primakoff Method

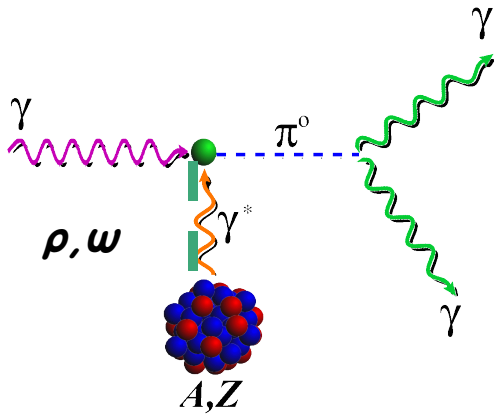

$$\frac{d\sigma_{\text{Pr}}}{d\Omega} = \Gamma_{\gamma\gamma} \frac{8\alpha Z^2}{m_\pi^3} \frac{\beta^3 E^4}{Q^4} |F_{e.m.}(Q)|^2 \sin^2 \theta_\pi$$

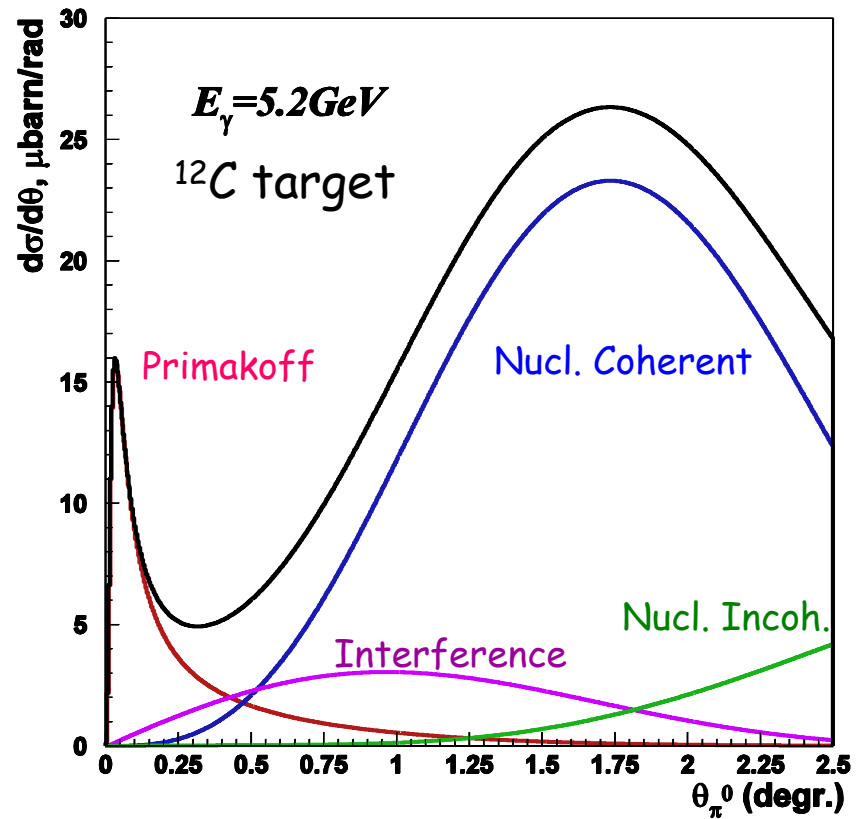

## Features of Primakoff cross section:

- Peaked at very small forward angle:

$$\langle \theta_{\text{Pr}} \rangle_{\text{peak}} \propto \frac{m^2}{2E^2}$$

- Beam energy sensitive:

$$\left\langle \frac{d\sigma_{\text{Pr}}}{d\Omega} \right\rangle_{\text{peak}} \propto E^4, \quad \int d\sigma_{\text{Pr}} \propto Z^2 \log(E)$$

- Coherent process

# Primakoff Method

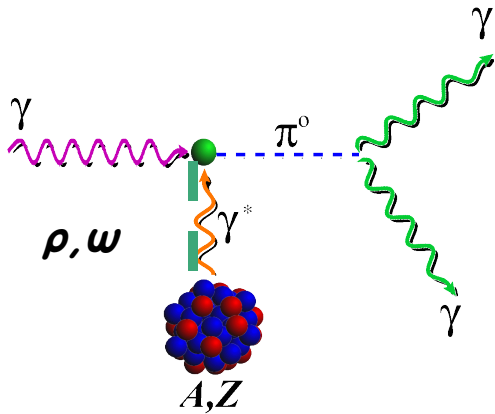

$$\frac{d\sigma_{\text{Pr}}}{d\Omega} = \boxed{\Gamma_{\gamma\gamma}} \frac{8\alpha Z^2}{m_\pi^3} \frac{\beta^3 E^4}{Q^4} |F_{e.m.}(Q)|^2 \sin^2 \theta_\pi$$

**Challenge: Extract the Primakoff amplitude**

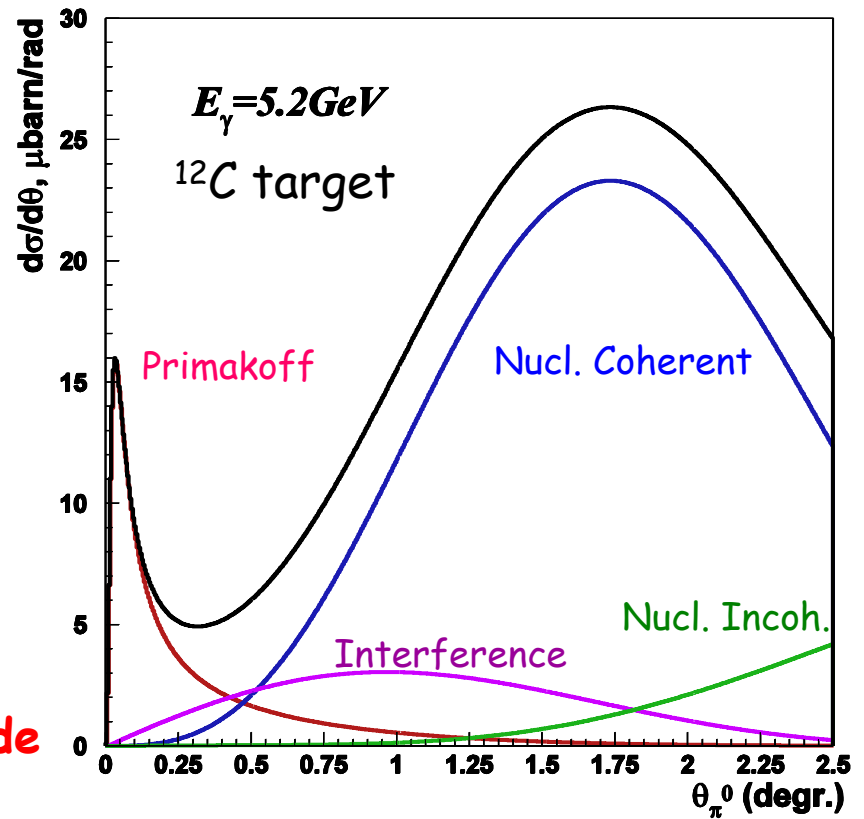

**Features of Primakoff cross section:**

- Peaked at very small forward angle:

$$\langle \theta_{\text{Pr}} \rangle_{\text{peak}} \propto \frac{m^2}{2E^2}$$

- Beam energy sensitive:

$$\left\langle \frac{d\sigma_{\text{Pr}}}{d\Omega} \right\rangle_{\text{peak}} \propto E^4, \quad \int d\sigma_{\text{Pr}} \propto Z^2 \log(E)$$

- Coherent process

# Primakoff Method

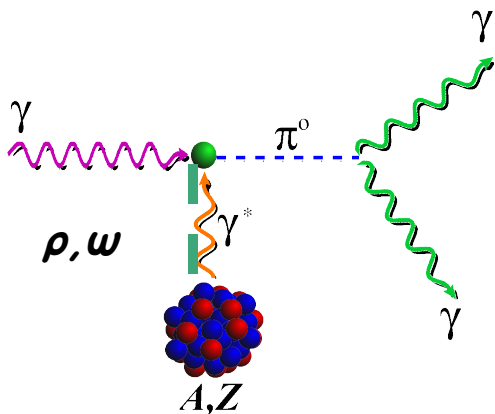

$$\frac{d\sigma_{\text{Pr}}}{d\Omega} = \Gamma_{\gamma\gamma} \frac{8\alpha Z^2}{m_\pi^3} \frac{\beta^3 E^4}{Q^4} |F_{e.m.}(Q)|^2 \sin^2 \theta_\pi$$

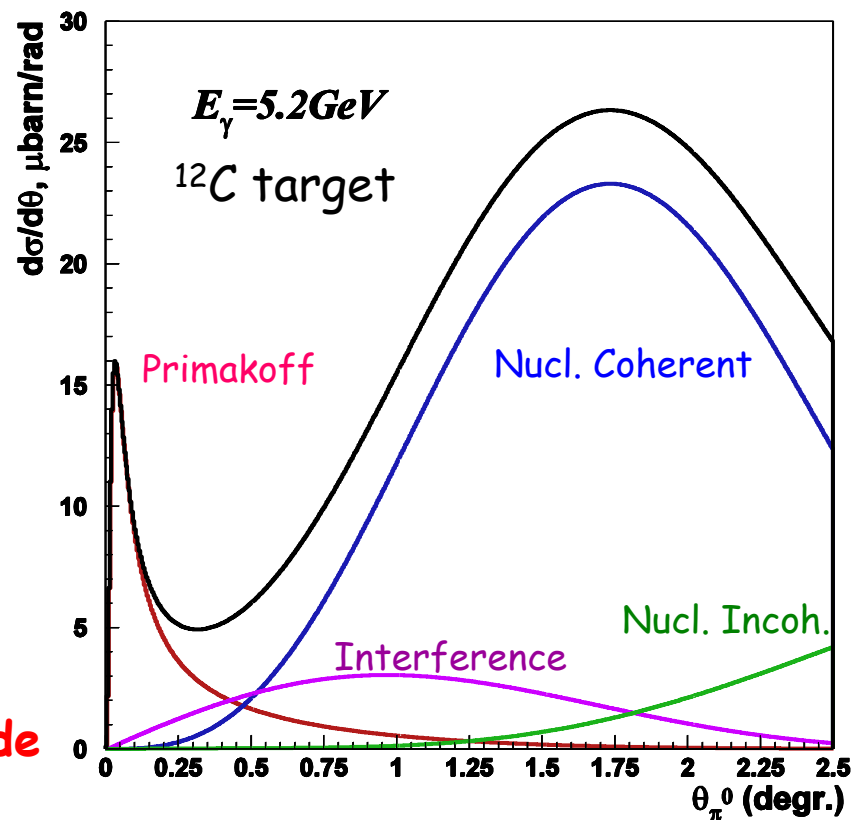

**Challenge: Extract the Primakoff amplitude**

## Requirement:

- Photon flux
- Beam energy
- $\pi^0$  production angle resolution
- Compact nuclear target

## Features of Primakoff cross section:

- Peaked at very small forward angle:

$$\langle \theta_{\text{Pr}} \rangle_{\text{peak}} \propto \frac{m^2}{2E^2}$$

- Beam energy sensitive:

$$\left\langle \frac{d\sigma_{\text{Pr}}}{d\Omega} \right\rangle_{\text{peak}} \propto E^4, \quad \int d\sigma_{\text{Pr}} \propto Z^2 \log(E)$$

- Coherent process



# PrimEx Experimental Setup

- JLab Hall B high resolution, high intensity photon tagging facility

- New pair spectrometer for photon flux control at high beam intensities

➔ 1% accuracy has been achieved

- New high resolution hybrid multi-channel calorimeter (HyCal)

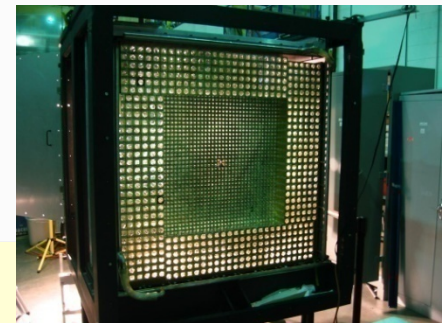
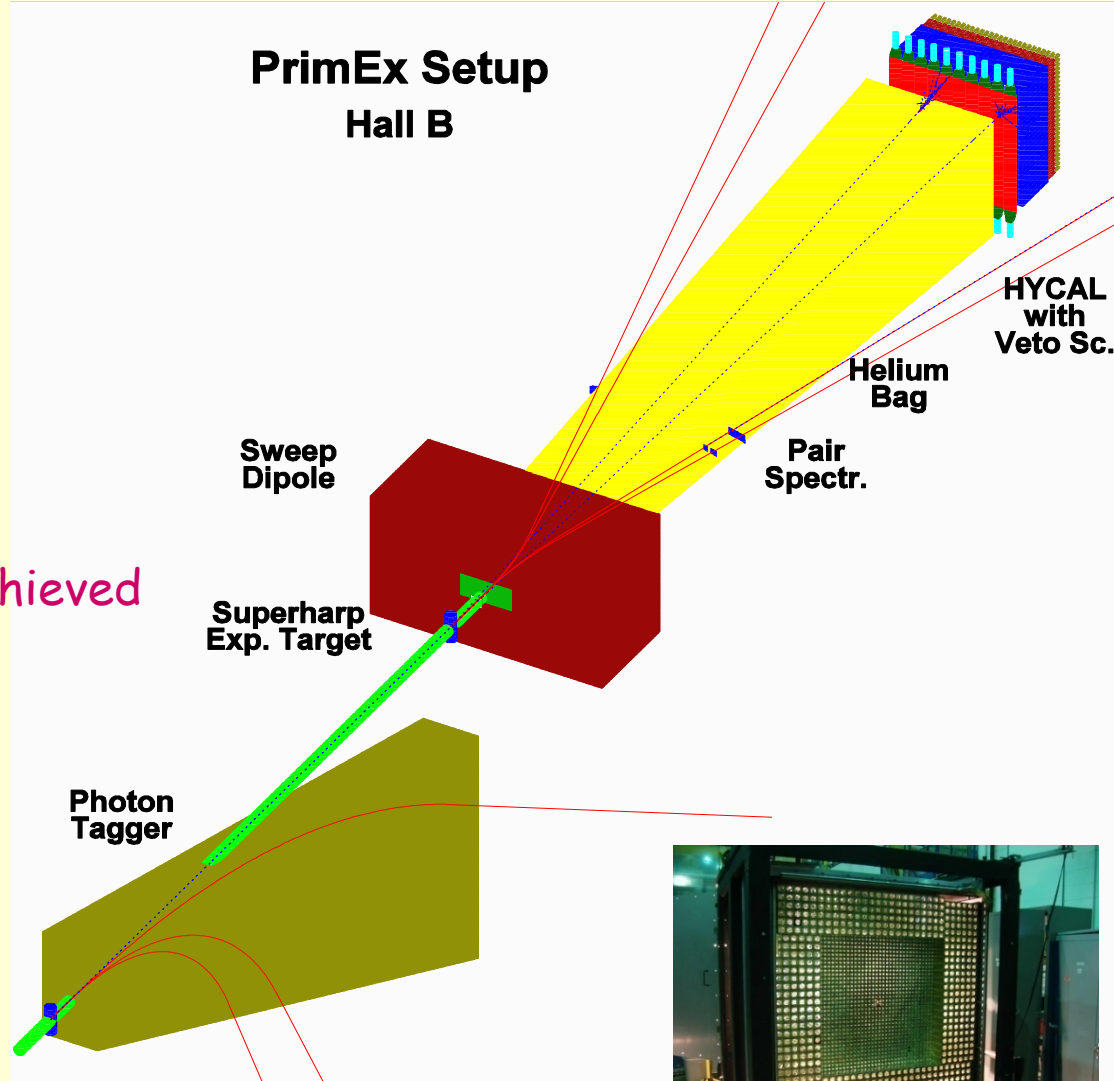

# The First Experiment: PrimEx-I (2004)

Theoretical angular distributions smeared with experimental resolutions are fit to the data on two nuclear targets to extract  $\Gamma(\pi^0 \rightarrow \gamma\gamma)$

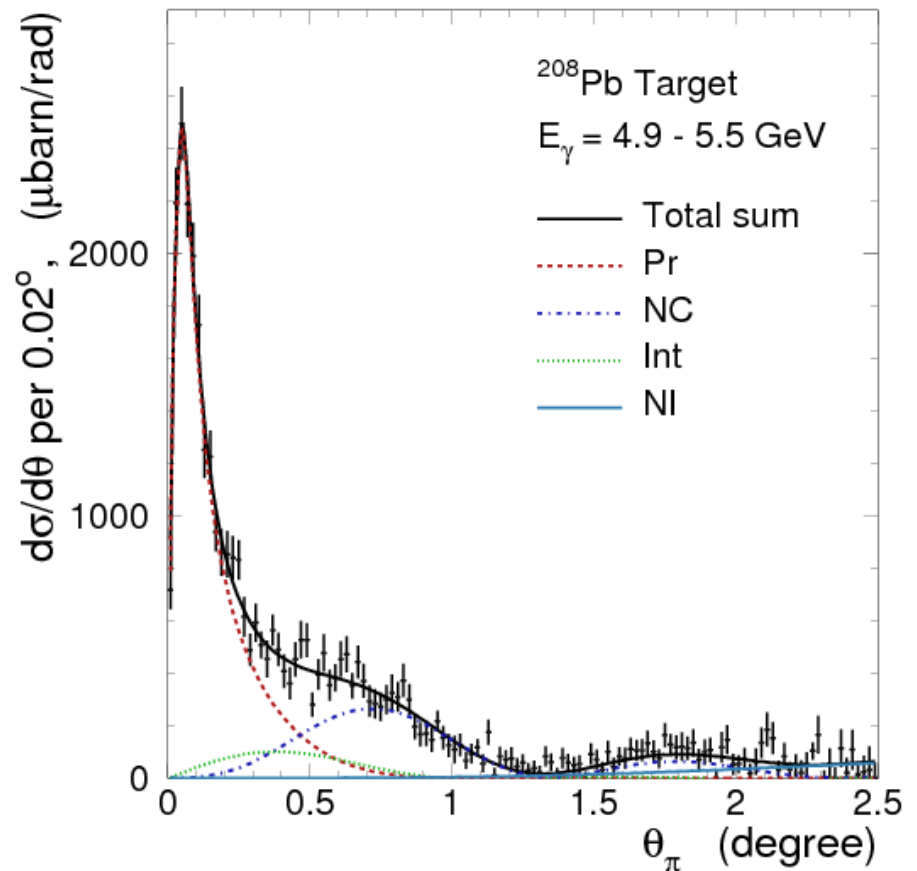
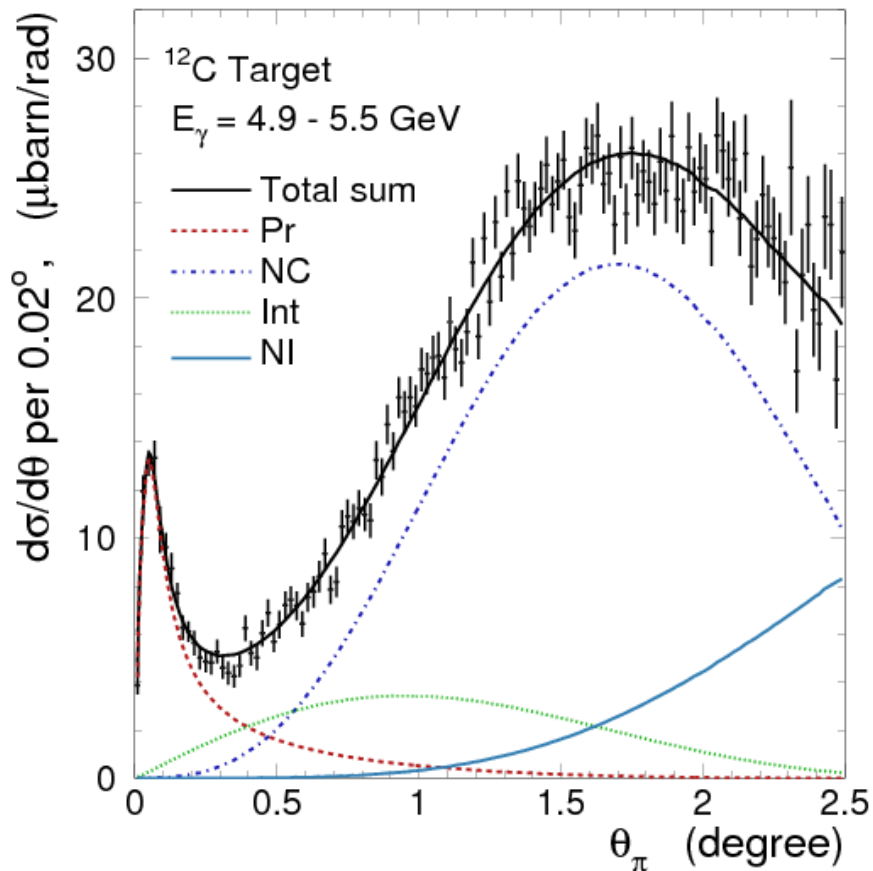

# Verification of Overall Systematical Uncertainties

□  $\gamma + e \rightarrow \gamma + e$  Compton cross section measurement

□  $e^+e^-$  pair-production cross section measurement:

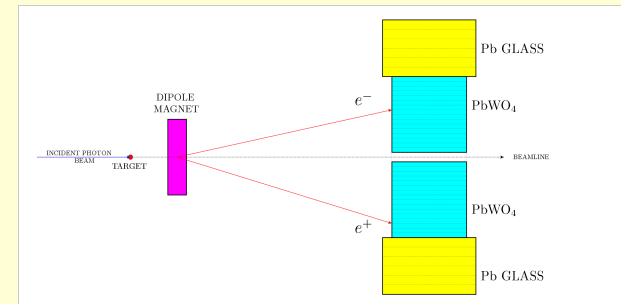
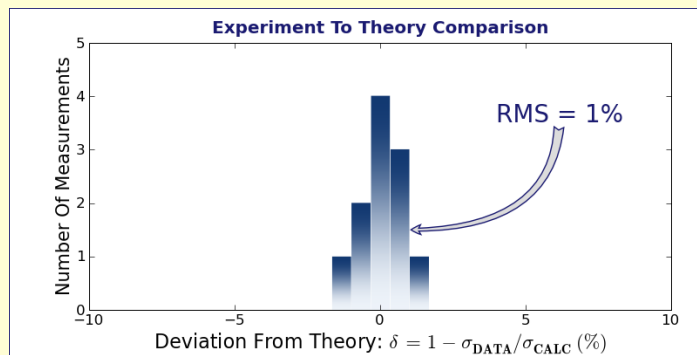
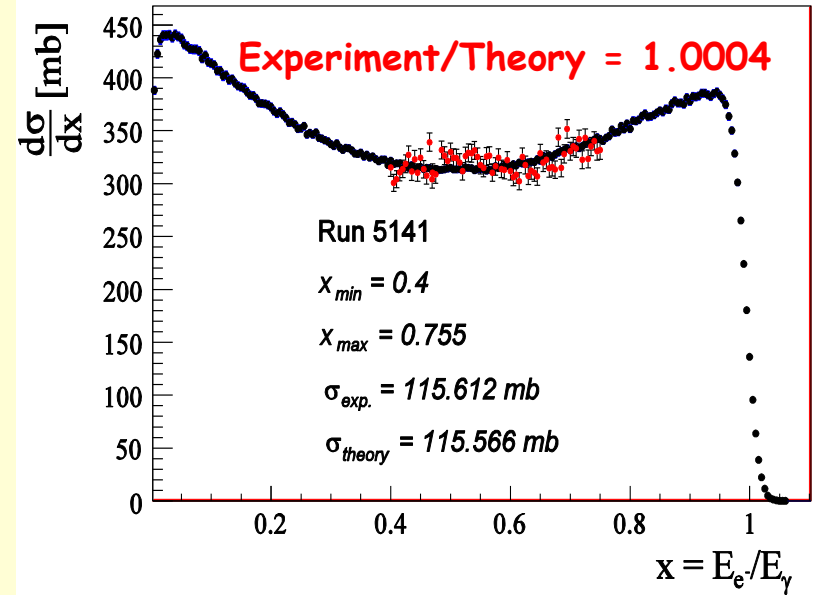
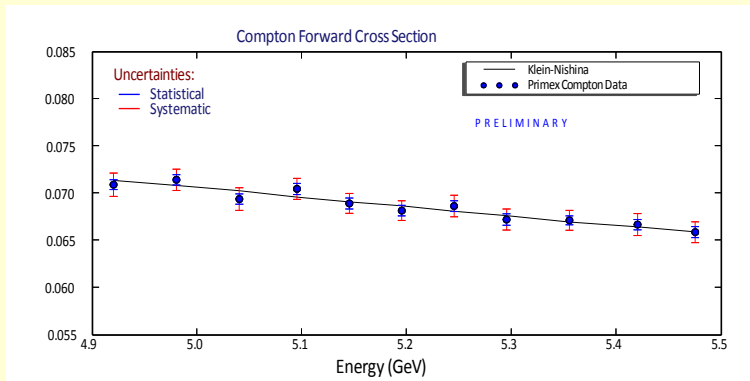

Systematic uncertainties on cross section are controlled under 1.3%

# PrimEx-I Result

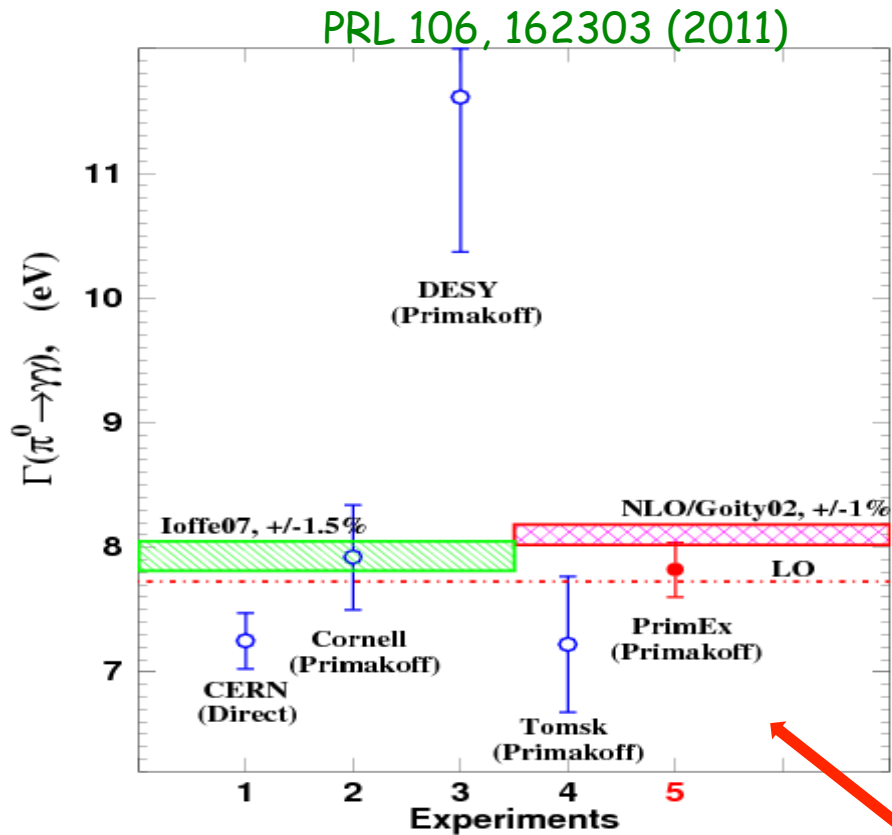

$$\Gamma(\pi^0 \rightarrow \gamma\gamma) = 7.82 \pm 0.14(\text{stat}) \pm 0.17(\text{syst}) \text{ eV}$$

2.8% total uncertainty

# The First Experiment: PrimEx-I Result

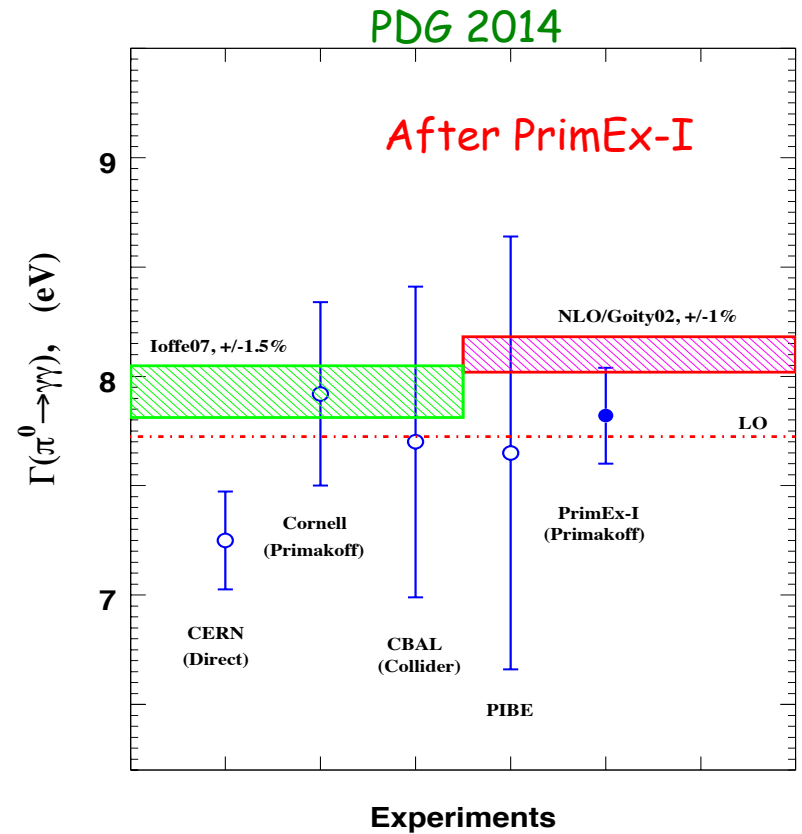
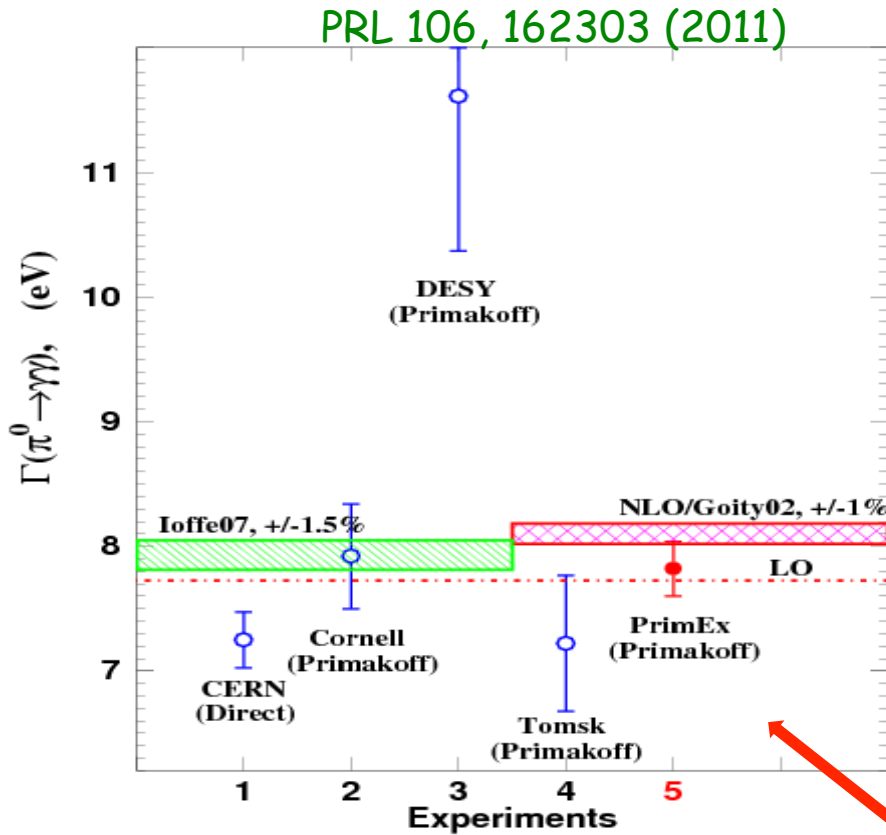

$$\Gamma(\pi^0 \rightarrow \gamma\gamma) = 7.82 \pm 0.14(\text{stat}) \pm 0.17(\text{syst}) \text{ eV}$$

2.8% total uncertainty

PrimEx-I improved the precision of PDG average by more than a factor of two

# Preliminary PrimEx-II Results from Analysis #1 (L. Ma and I. Larin)

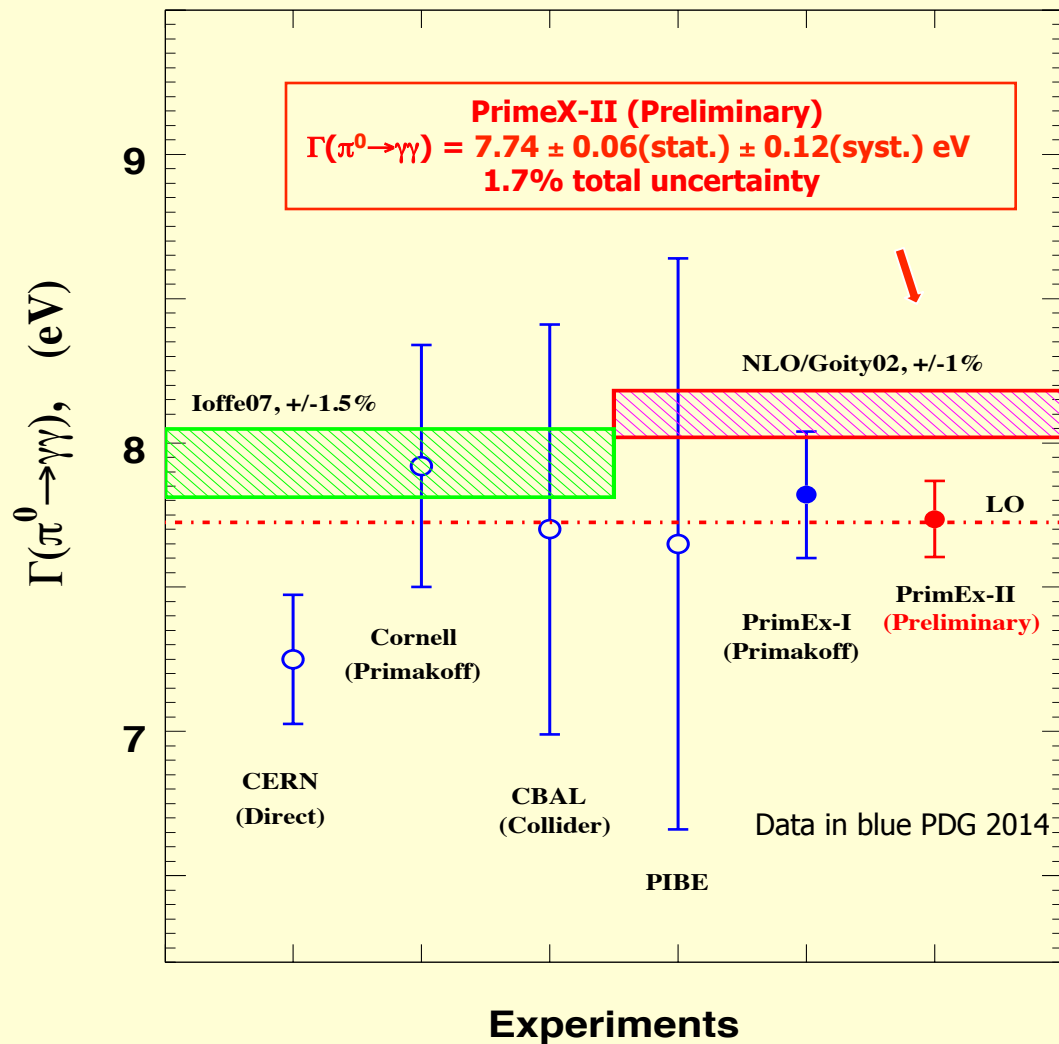
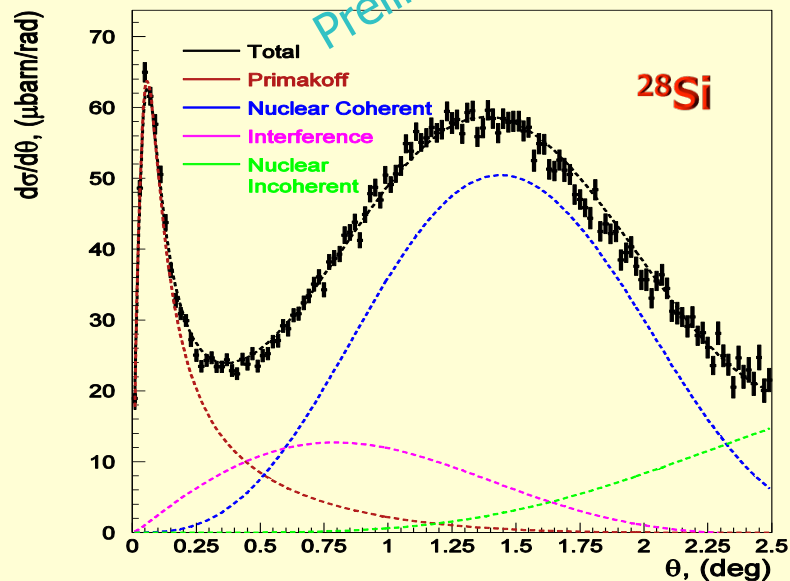
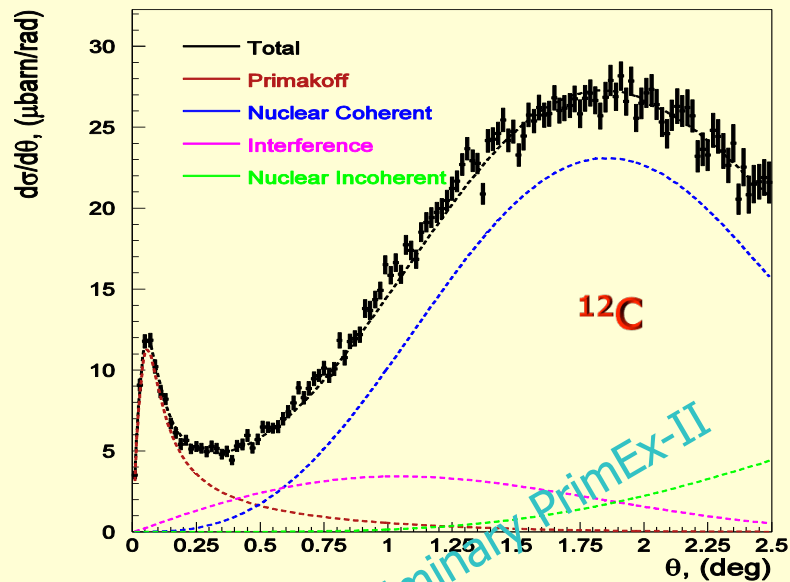

# Preliminary PrimEx-II Results from Analysis #2 (Y. Zhang and I. Larin)

✓ The second analysis group finished the preliminary results for the  $^{28}\text{Si}$  target:

- a) differential cross section have been extracted (left plot below);
- b) the  $\pi^0$  decay width is extracted (left plot below):  
 $7.82 \pm 0.06$  (stat.)  $\pm 0.13$  (sys.) eV, with 1.6% total uncertainty
- a) the  $^{28}\text{Si}$  radius has been extracted from the measured nuclear coherent process (right plot below):  
 $\sqrt{\langle r^2 \rangle} = 3.24 \pm 0.02$  fm

✓ Results for the  $^{12}\text{C}$  target will be finalized by the end of this year.

$\pi^0$  cross section

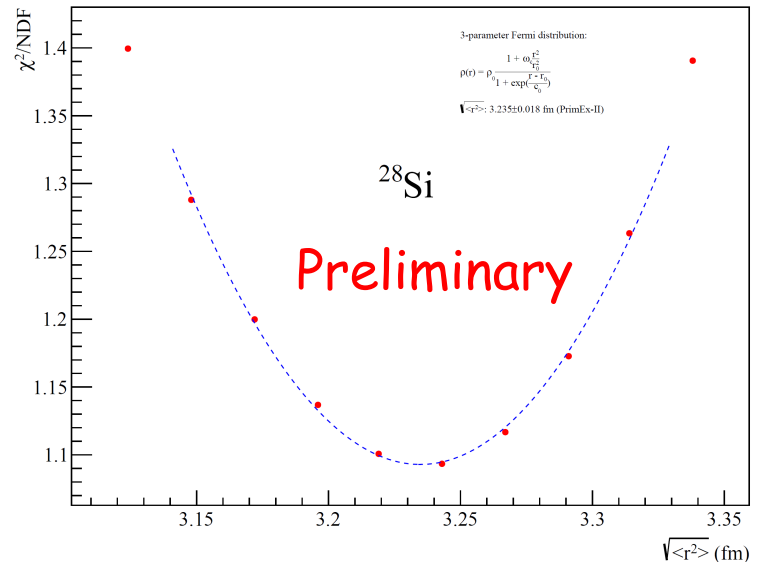
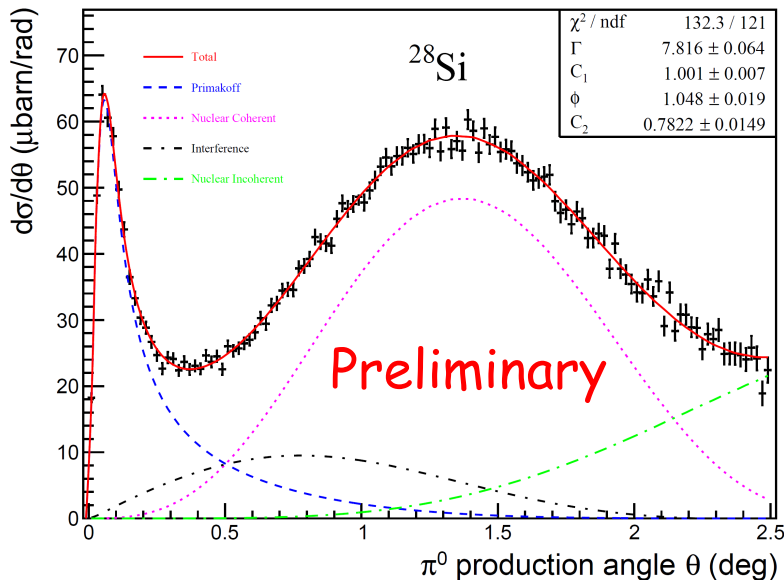

# Measurement of $\Gamma(\eta \rightarrow \gamma\gamma)$ in Hall D at 12 GeV

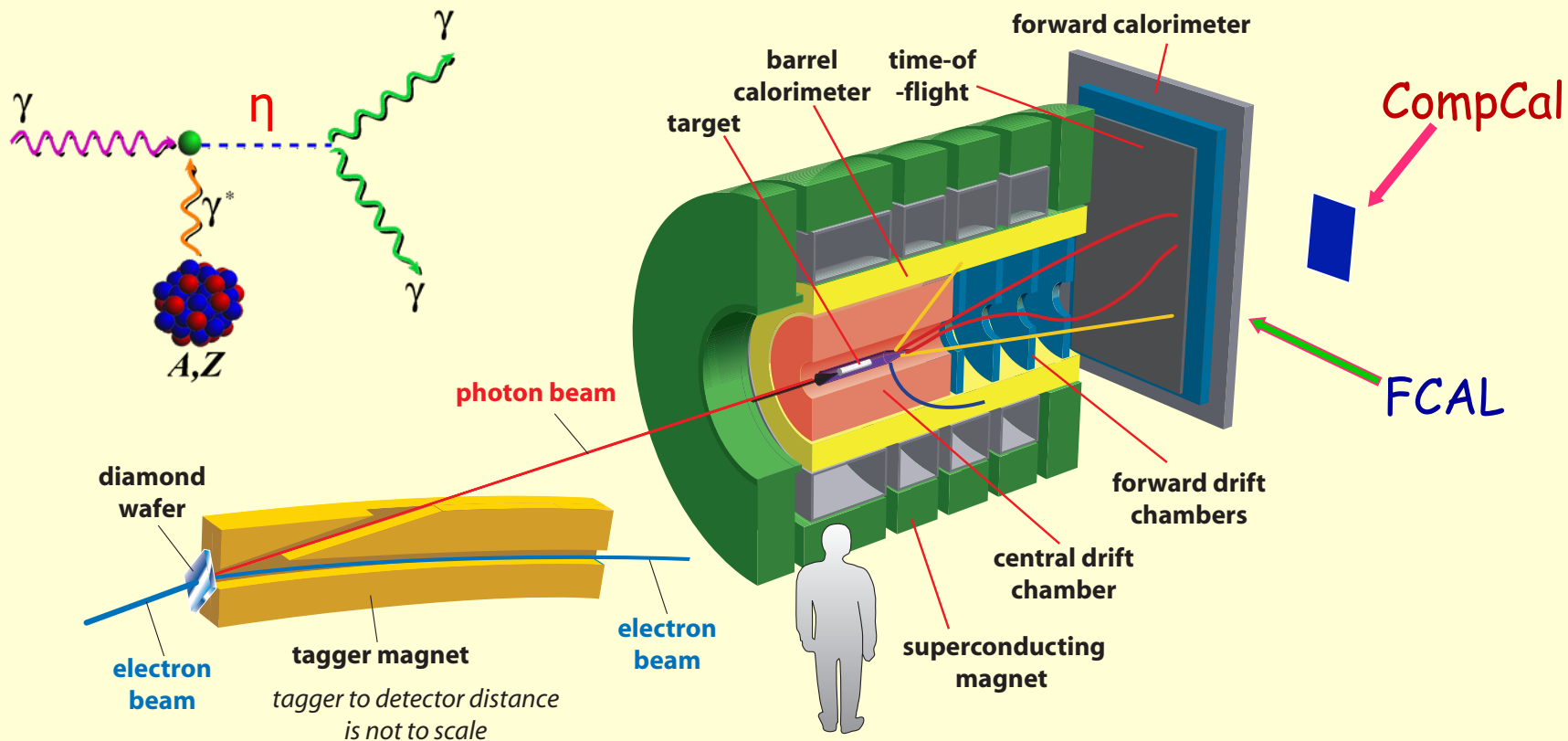

- Incoherent tagged photon beam ( $\sim 10.5$ - $11.5$  GeV)
- Pair spectrometer and a TAC detector for the photon flux control
- 30 cm liquid Hydrogen and  $^4\text{He}$  targets ( $\sim 3.6\%$  r.l.)
- Forward Calorimeter (FCAL) for  $\eta \rightarrow \gamma\gamma$  decay photons
- CompCal and FCAL to measure well-known Compton scattering for control of overall systematic uncertainties.
- Solenoid detectors and forward tracking detectors (for background rejection)



# Challenges in the $\Gamma(\eta \rightarrow \gamma\gamma)$ Experiment

Compared to  $\pi^0$ :

- $\eta$  mass is a factor of 4 larger than  $\pi^0$  and has a smaller cross section

$$\left( \frac{d\sigma_{\text{Pr}}}{d\Omega} \right)_{\text{peak}} \propto \frac{E^4}{m^3}$$

- larger overlap between Primakoff and hadronic processes:

$$\langle \theta_{\text{Pr}} \rangle_{\text{peak}} \propto \frac{m^2}{2E^2} \quad \theta_{\text{NC}} \propto \frac{2}{E \cdot A^{1/3}}$$

- larger momentum transfer (coherency, form factors, FSI,...)

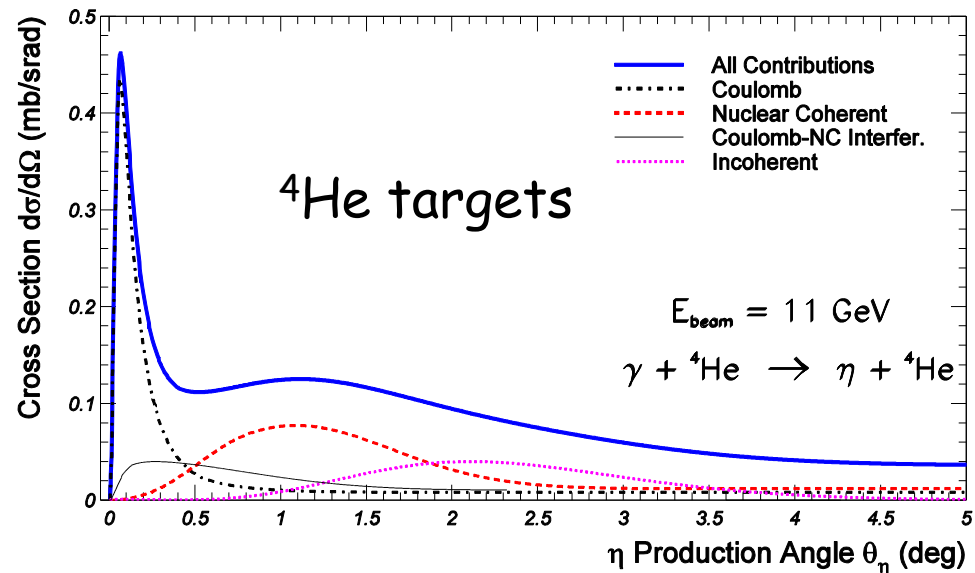
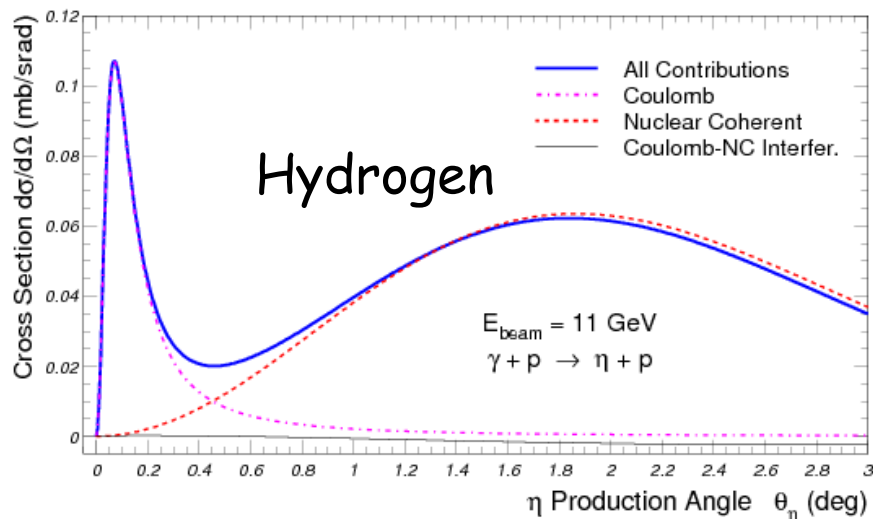

# Physics Impact of $\Gamma(\eta \rightarrow \gamma\gamma)$ Measurement

1. Resolve long standing discrepancy between collider and Primakoff measurements:

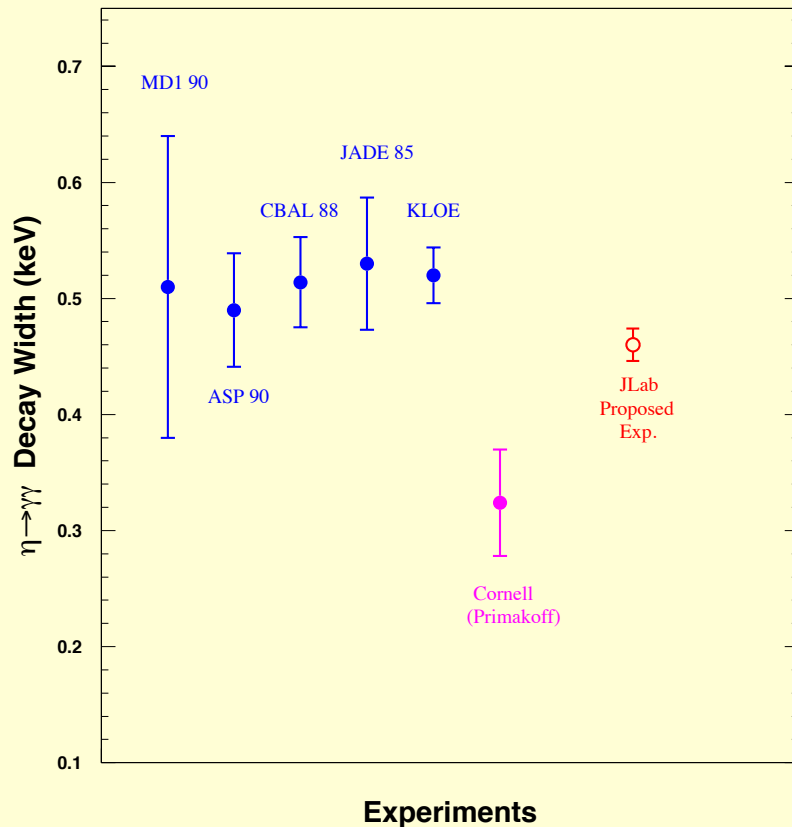

2. Extract  $\eta$ - $\eta'$  mixing angle:

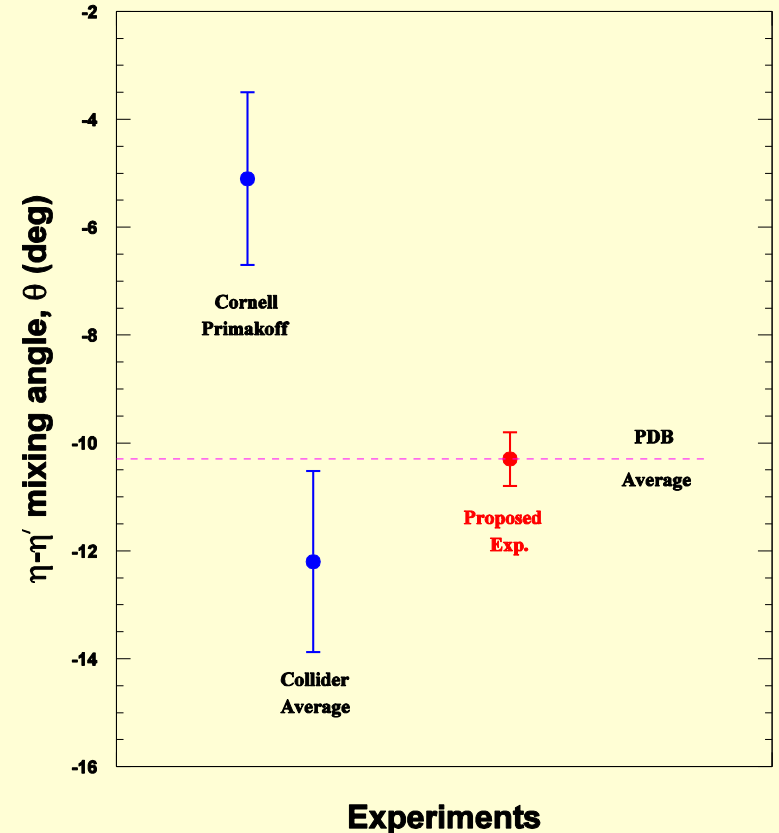

3. Improve all partial decay widths in the  $\eta$ -sector

# Precision Determination Light Quark Mass Ratio

A clean probe for quark mass ratio: 
$$Q^2 = \frac{m_s^2 - \hat{m}^2}{m_d^2 - m_u^2}, \quad \text{where } \hat{m} = \frac{1}{2}(m_u + m_d)$$

➤  $\eta \rightarrow 3\pi$  decays through isospin violation:  $A = (m_u - m_d)A_1 + \alpha_{em}A_2$

➤  $\alpha_{em}$  is small

➤ Amplitude: 
$$A(\eta \rightarrow 3\pi) = \frac{1}{Q^2} \frac{m_K^2}{m_\pi^2} (m_\pi^2 - m_K^2) \frac{M(s, t, u)}{3\sqrt{3}F_\pi^2}$$

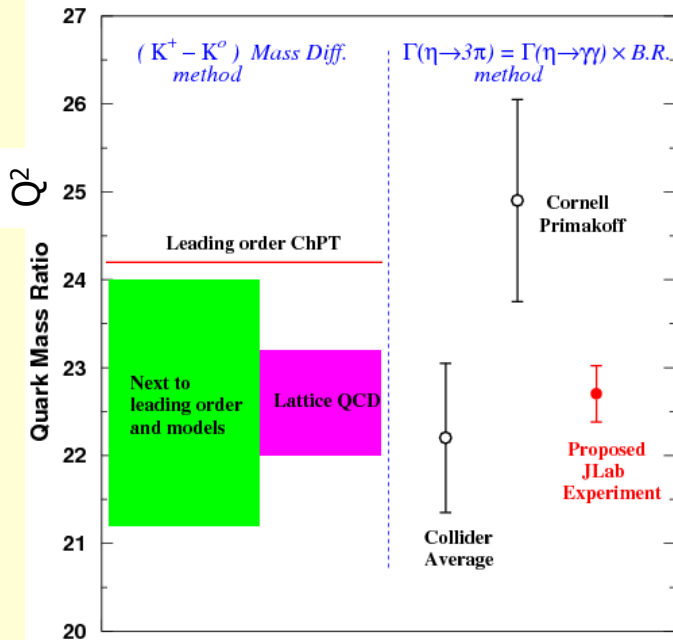

H. Leutwyler Phys. Lett., B378, 313 (1996)

# Precision Determination Light Quark Mass Ratio

A clean probe for quark mass ratio: 
$$Q^2 = \frac{m_s^2 - \hat{m}^2}{m_d^2 - m_u^2}, \quad \text{where } \hat{m} = \frac{1}{2}(m_u + m_d)$$

➤  $\eta \rightarrow 3\pi$  decays through isospin violation:  $A = (m_u - m_d)A_1 + \alpha_{em}A_2$

➤  $\alpha_{em}$  is small

➤ Amplitude: 
$$A(\eta \rightarrow 3\pi) = \frac{1}{Q^2} \frac{m_K^2}{m_\pi^2} (m_\pi^2 - m_K^2) \frac{M(s, t, u)}{3\sqrt{3}F_\pi^2}$$

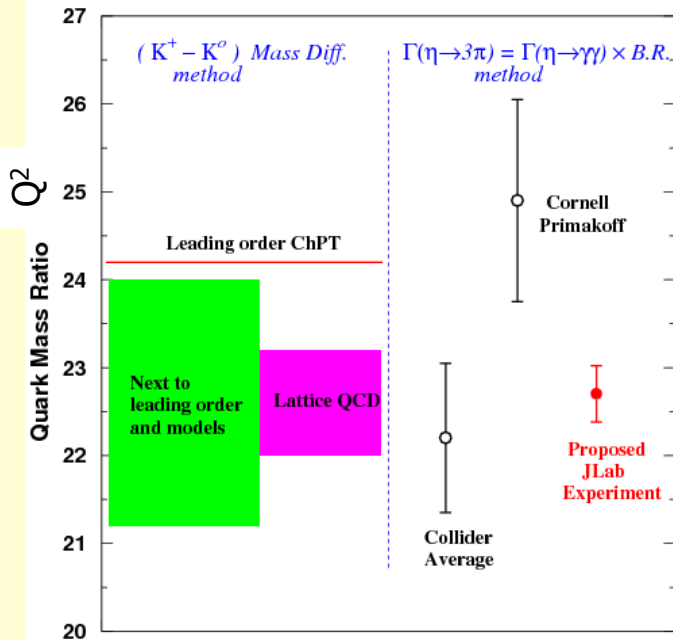

H. Leutwyler Phys. Lett., B378, 313 (1996)

# Precision Determination Light Quark Mass Ratio

A clean probe for quark mass ratio:  $Q^2 = \frac{m_s^2 - \hat{m}^2}{m_d^2 - m_u^2}$ , where  $\hat{m} = \frac{1}{2}(m_u + m_d)$

➤  $\eta \rightarrow 3\pi$  decays through isospin violation:  $A = (m_u - m_d)A_1 + \alpha_{em}A_2$

➤  $\alpha_{em}$  is small

➤ Amplitude:  $A(\eta \rightarrow 3\pi) = \frac{1}{Q^2} \frac{m_K^2}{m_\pi^2} (m_\pi^2 - m_K^2) \frac{M(s, t, u)}{3\sqrt{3}F_\pi^2}$

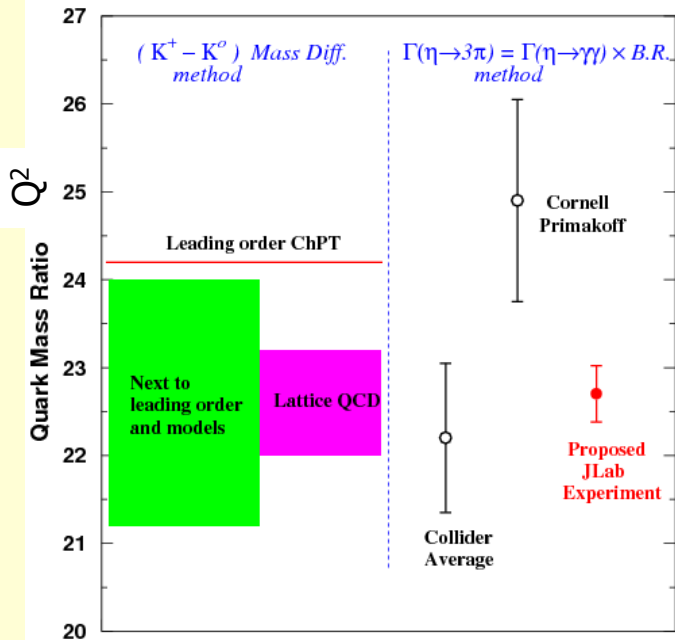

- Critical input to extract Cabibbo Angle,  $V_{us} = \sin(\theta_c)$  from kaon or hyperon decays.

- $V_{us}$  is a cornerstone for test of CKM unitarity:

$$|V_{ud}|^2 + |V_{us}|^2 + |V_{ub}|^2 = 1$$

H. Leutwyler Phys. Lett., B378, 313 (1996)

# Transition Form Factors $F(\gamma\gamma^* \rightarrow p)$ (at low $Q^2$ : 0.001-0.5 $\text{GeV}^2/c^2$ )

- Direct measurement of slopes

- Interaction radii:  
 $F_{\gamma\gamma^*p}(Q^2) \approx 1 - 1/6 \langle r^2 \rangle_p Q^2$
- ChPT for large  $N_c$  predicts relation between the three slopes. Extraction of  $O(p^6)$  low-energy constant in the chiral Lagrangian

- Input for hadronic light-by-light calculations in muon ( $g-2$ )

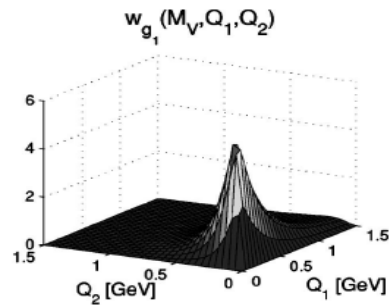
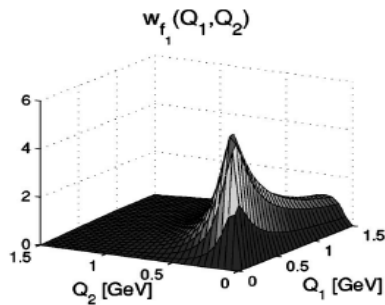

M. Knecht and A. Nyffeler, Phys.Rev.D65,073034

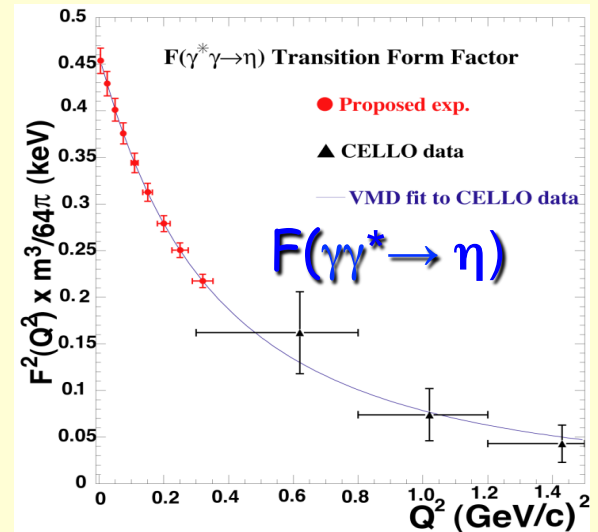
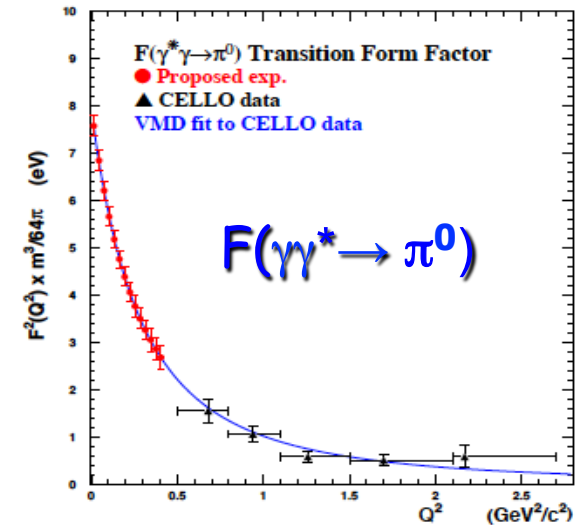

# $\eta$ is a unique probe for fundamental symmetries

- ◆ The most massive member in the octet of pseudoscalar Goldstone mesons (547.9 MeV/c<sup>2</sup>)
  - ➡ Many open decay channels
  - ➡ Sensitive to symmetry breakings

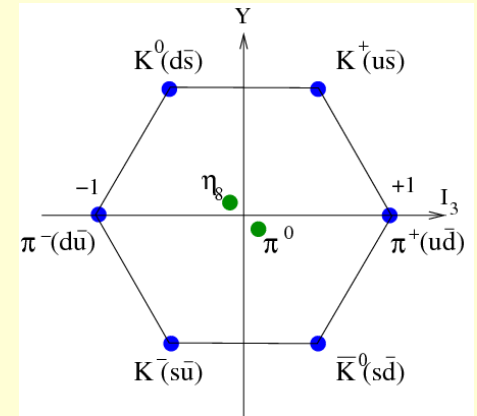

- ◆  $\eta$  decay width  $\Gamma_\eta = 1.3\text{KeV}$  is **narrow** (relative to  $\Gamma_\omega = 8.5\text{ MeV}$ )
  - ➡ The lowest orders of  $\eta$  decays are filtered out, enhancing the contributions from higher orders (by a factor of  $\sim 7000$  compared to  $\omega$  decays).
- ◆ Eigenstate of  $P$ ,  $C$ ,  $CP$ , and  $G$ :  $I^G J^{PC} = 0^+ 0^{-+}$ 
  - ➡ Study violations of **discrete symmetries**
- ◆ The  $\eta$  decays are **flavor-conserving** reactions effectively free of SM backgrounds for new physics search.

# Overview of the Jlab Eta Factory (JEF) Project

Mode	Branching Ratio	Physics Highlight	Photons
priority:			
$\pi^0 2\gamma$	$(2.7 \pm 0.5) \times 10^{-4}$	$\chi$ PTh at $\mathcal{O}(p^6)$	4
$\gamma + B$	beyond SM	leptophobic dark boson	4
$3\pi^0$	$(32.6 \pm 0.2)\%$	$m_u - m_d$	6
$\pi^+ \pi^- \pi^0$	$(22.7 \pm 0.3)\%$	$m_u - m_d, CV$	2
$3\gamma$	$< 1.6 \times 10^{-5}$	CV, CPV	3
ancillary:			
$4\gamma$	$< 2.8 \times 10^{-4}$	$< 10^{-11}$ [112]	4
$2\pi^0$	$< 3.5 \times 10^{-4}$	CPV, PV	4
$2\pi^0 \gamma$	$< 5 \times 10^{-4}$	CV, CPV	5
$3\pi^0 \gamma$	$< 6 \times 10^{-5}$	CV, CPV	6
$4\pi^0$	$< 6.9 \times 10^{-7}$	CPV, PV	8
$\pi^0 \gamma$	$< 9 \times 10^{-5}$	CV, Ang. Mom. viol.	3
normalization:			
$2\gamma$	$(39.3 \pm 0.2)\%$	anomaly, $\eta$ - $\eta'$ mixing PR12-10-011	2

## Main physics goals:

1. Search for a leptophobic dark boson (B).
2. Directly constrain CVPC new physics
3. Improve the light quark mass ratio
4. Probe interplay of VMD & scalar resonances in ChPT.

FCAL-II is required for the rare decays



# Jlab Eta Factory (JEF) Experiment

GLUE  $X$  

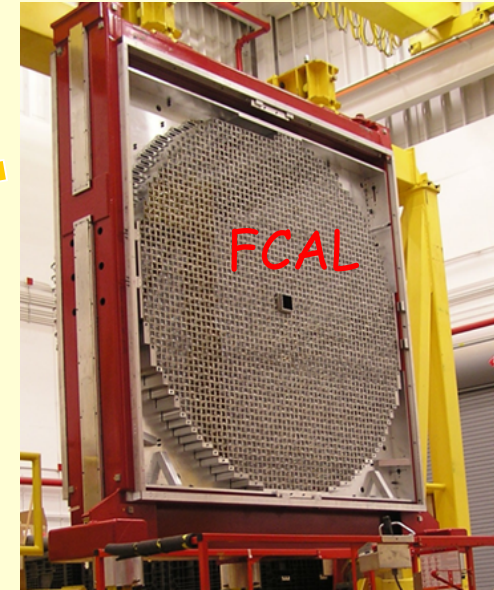
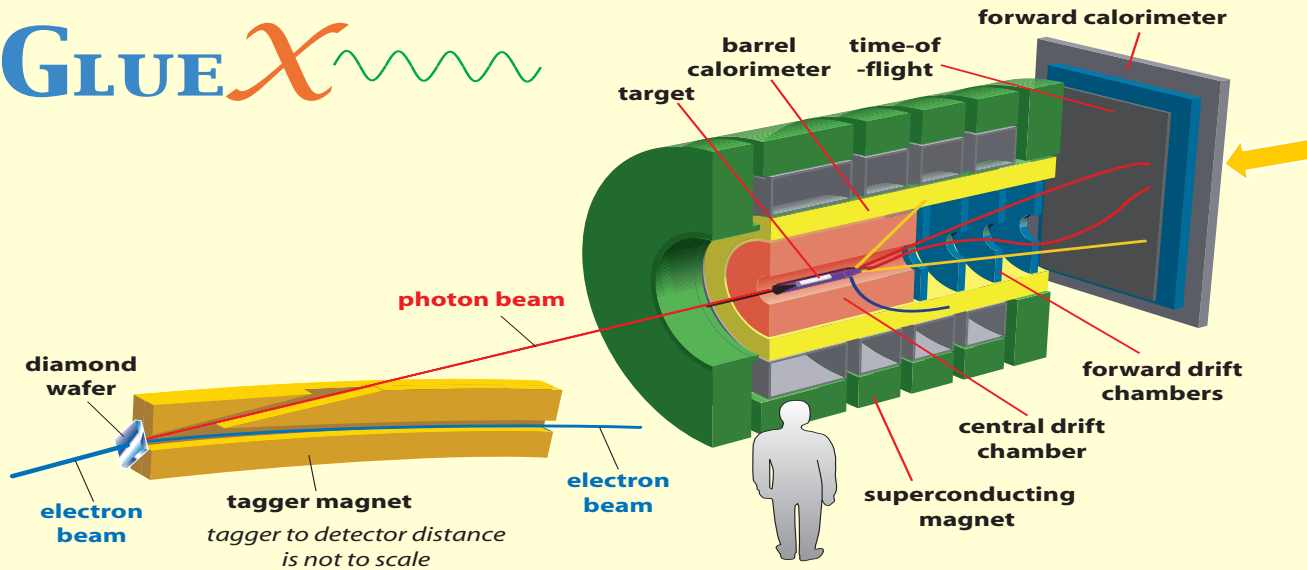

Simultaneously measure  $\eta$  decays:  $\eta \rightarrow \pi^0 \gamma \gamma$ ,  $\eta \rightarrow 3\gamma$ , and ...

- ◆  $\eta$  produced on  $\text{LH}_2$  target with **9-11.7 GeV tagged photon beam**:  
 $\gamma + p \rightarrow \eta + p$
- ◆ Reduce non-coplanar backgrounds by **detecting recoil  $p$ 's** with GlueX detector ( $\epsilon \sim 75\%$ )
- ◆ Upgraded Forward Calorimeter with **High resolution, high granularity  $\text{PbWO}_4$  insertion (FCAL-II)** to detect multi-photons from rare  $\eta$  decays

# World competition in $\eta$ decays

$e^+e^-$   
Collider

KLOE-2 at DAΦNE



BESIII at BEPCII

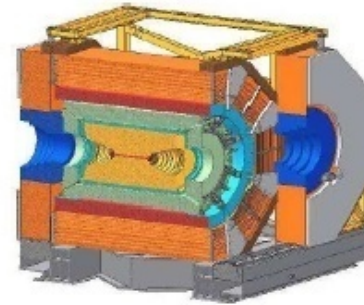

Fixed-target

WASA at COSY

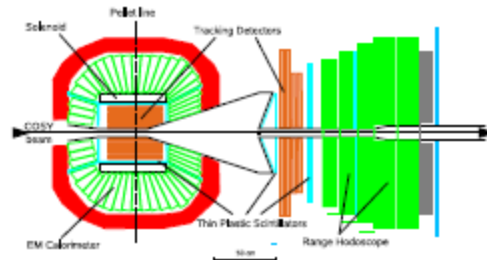

hadroproduction

Crystall Ball at MAMI

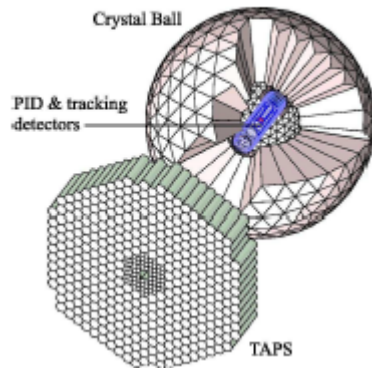

photoproduction

CBELSA/TAPS at ELSA

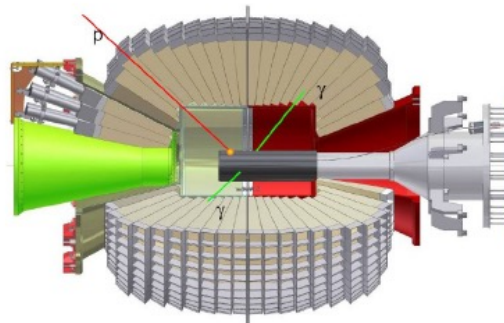

JEF at Jlab

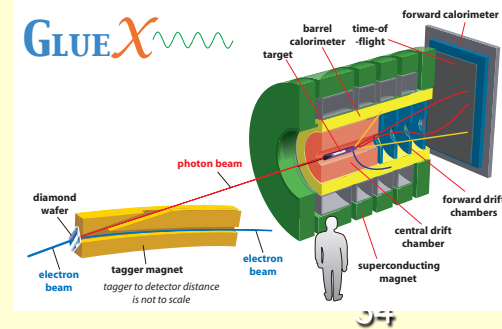

# World competition in $\eta$ decays

$e^+e^-$   
Collider

KLOE-2 at DAΦNE

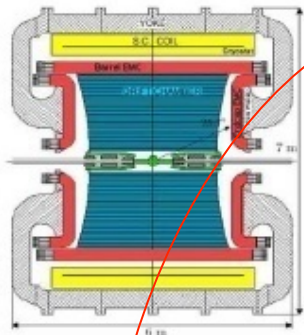

BESIII at BEPCII

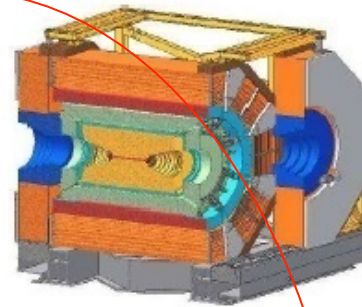

Low energy  
 $\eta$ -facilities

Fixed-target

WASA at COSY

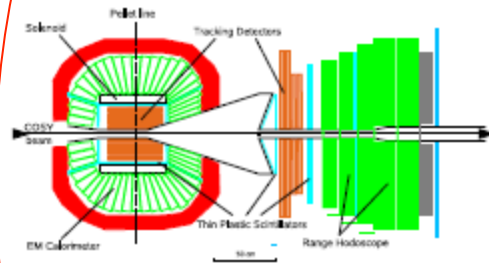

hadroproduction

Crystall Ball at MAMI

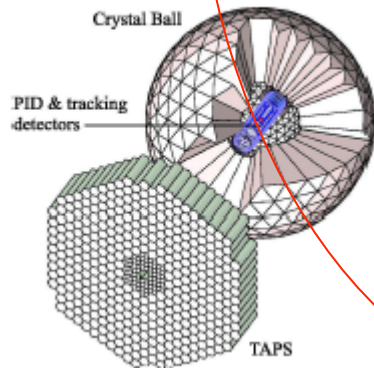

photoproduction

CBELSA/TAPS at ELSA

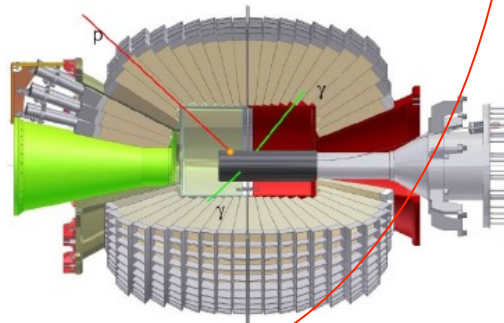

JEF at Jlab

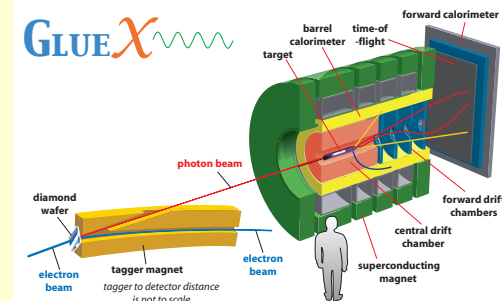

# World Competition in $\eta$ Decays

$e^+e^-$   
Collider

KLOE-2 at DAΦNE

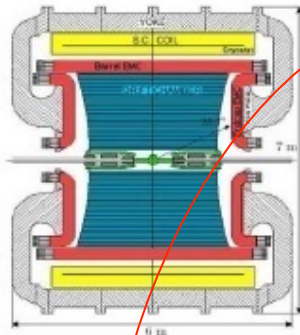

BESIII at BEPCII

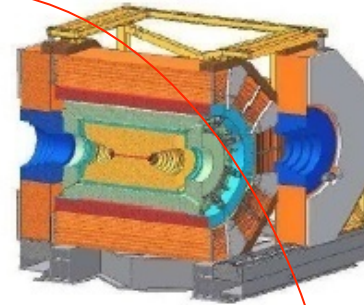

Low energy  
 $\eta$ -facilities

Fixed-target

WASA at COSY

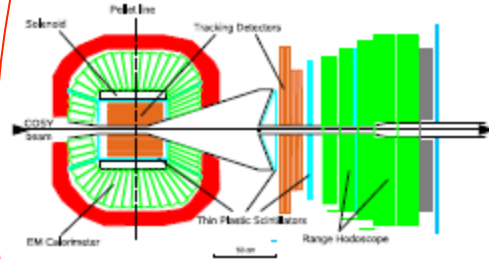

hadroproduction

High energy  
 $\eta$ -facility

Crystall Ball at MAMI

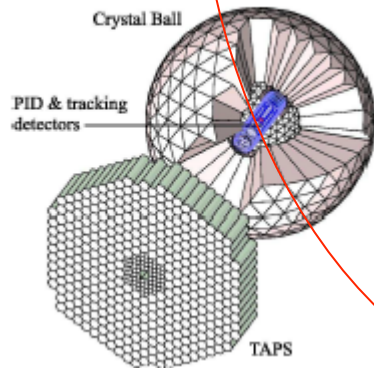

photoproduction

CBELSA/TAPS at ELSA

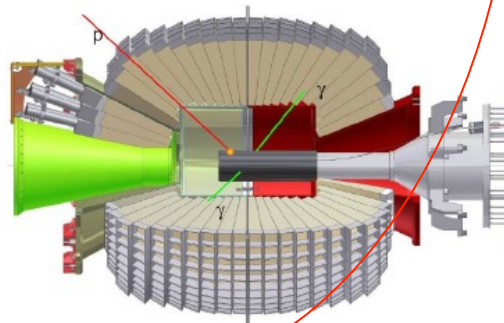

JEF at Jlab

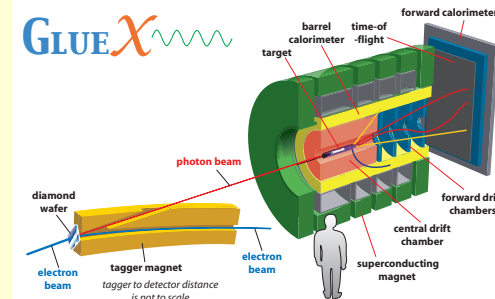

# Filter Background with $\eta$ Energy Boost ( $\eta \rightarrow \pi^0 \gamma \gamma$ )

A2 at MAMI (Phys.Rev. C90 (2014) 025206):  $\gamma p \rightarrow \eta p$  ( $E_\gamma = 1.5$  GeV)

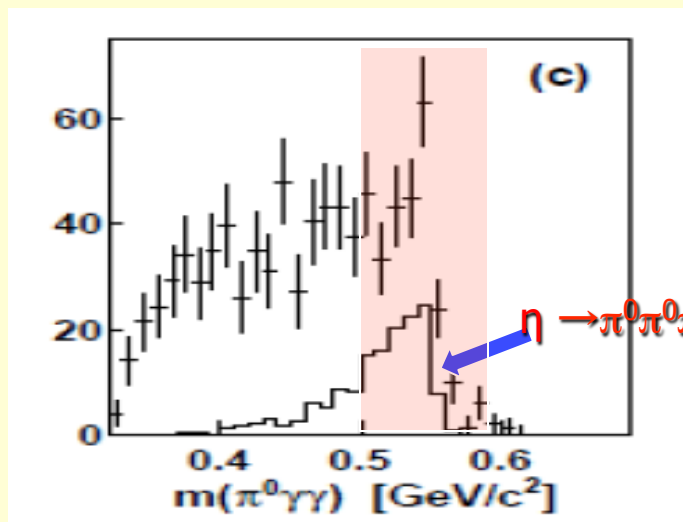

$\gamma p \rightarrow \pi^0 \pi^0 + p$

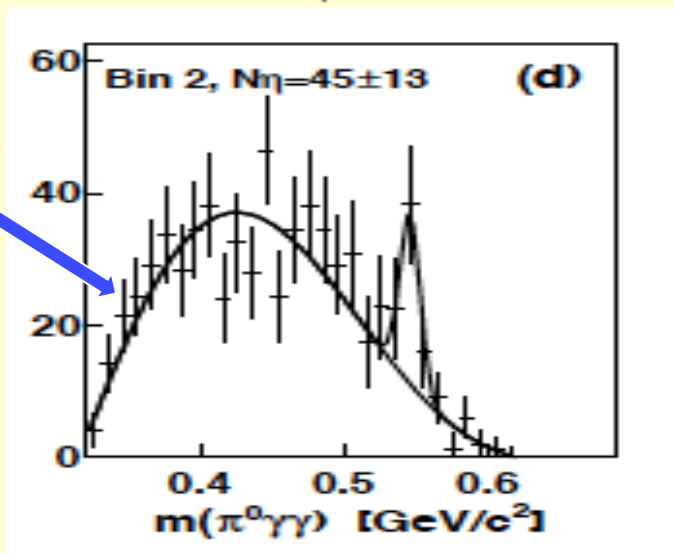

# Filter Background with $\eta$ Energy Boost ( $\eta \rightarrow \pi^0 \gamma \gamma$ )

A2 at MAMI (Phys.Rev. C90 (2014) 025206):  $\gamma p \rightarrow \eta p$  ( $E_\gamma = 1.5$  GeV)

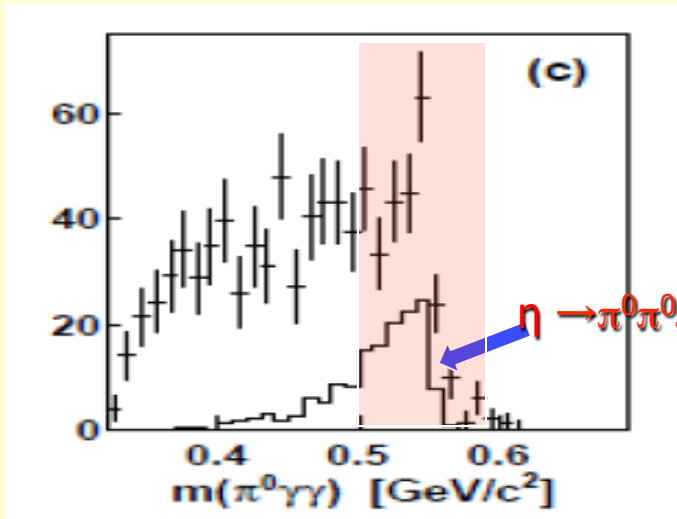

$\gamma p \rightarrow \pi^0 \pi^0 + p$

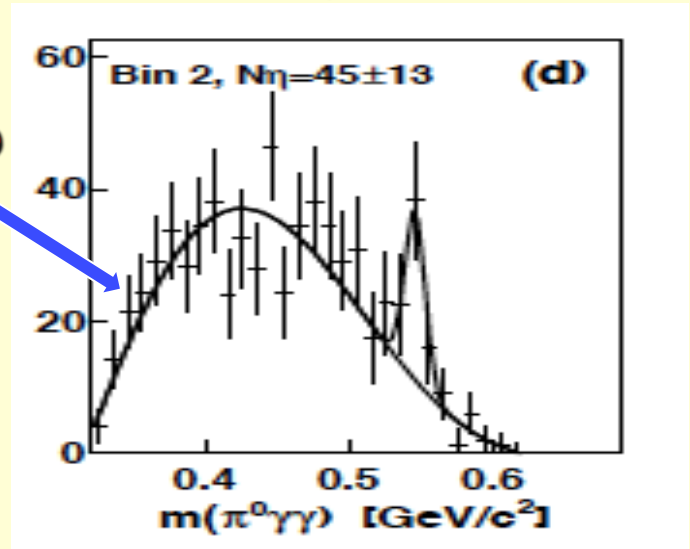

Jlab:

$\gamma p \rightarrow \eta p$  ( $E_\gamma = 9-11.7$  GeV)

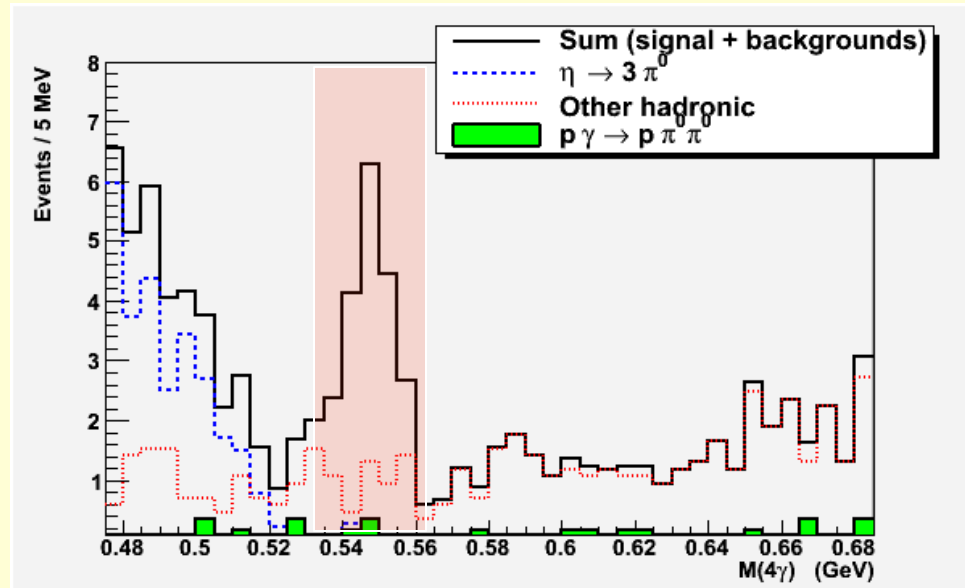

# Search for Dark Forces

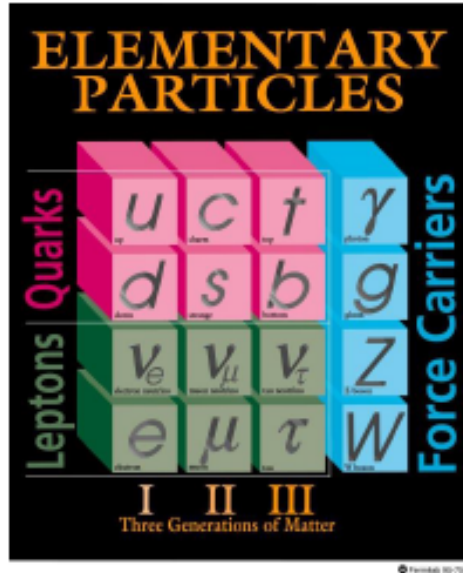

SM based on  $SU(3)_C \times SU(2)_L \times U(1)_Y$  gauge symmetry. Are there any additional gauge symmetries? Look for new gauge bosons.

Motivations:

1. **Grand unified theories:** Generically have additional gauge bosons, but typically very heavy ( $10^{16}$  GeV).
2. **Dark matter:** Stability of dark matter related to new gauge symmetry?  
Can also give the right relic density.

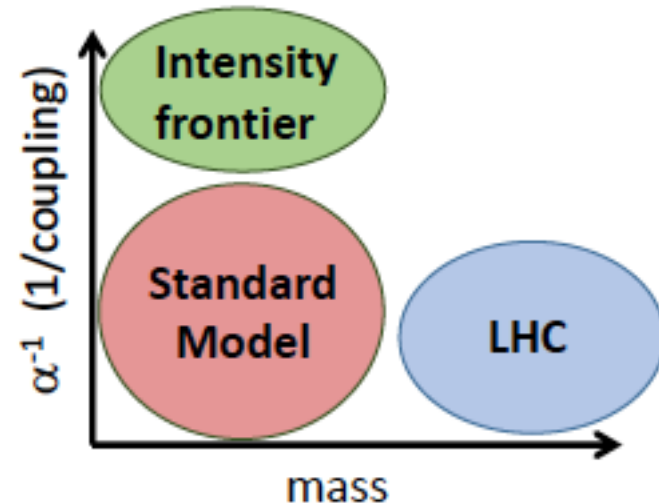

# "Vector Portal" to Dark Sector

## 1. Dark photon $A'$

$$-\frac{1}{2}\epsilon F^{\mu\nu}F'_{\mu\nu} \text{ Kinetic mixing and } U(1)'$$

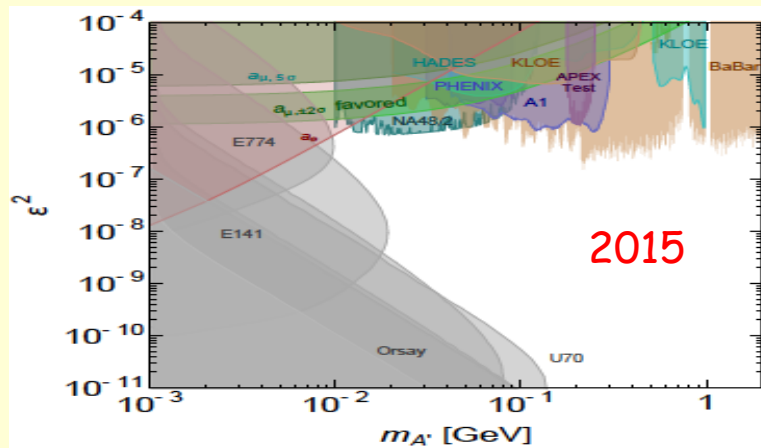
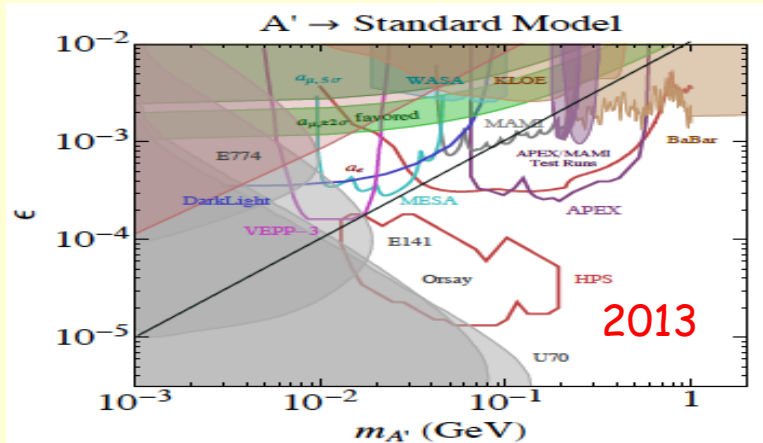

## 2. Dark leptophobic B-boson (dark $\omega$ , $\gamma_B$ , or $Z'$ ):

$$\frac{1}{3}g_B\bar{q}\gamma^\mu q B_\mu$$

Gauged baryon symmetry  $U(1)_B$

T.D. Lee and C.N. Yang, *Phys.Rev.*,98, 1501 (1955)

- ◆ the stability of baryonic and dark matter
- ◆ a unified genesis of baryonic and dark matter *M.Graesser, I. Shoemaker and L. Vecchi, arXiv:1107.2666*
- ◆ a natural framework for resolving "Strong CP problem" in QCD

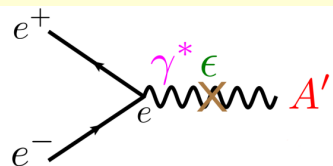

Most  $A'$  searches look for  $A' \rightarrow l^+l^-$ , relying on the leptonic coupling of new force



# Experimental Probes for B-boson

Discovery signals depend on the B mass:

- ◆ the  $m_B < m_\pi$  region is strongly constrained by long-range forces search and nuclear scattering experiments.
- ◆ the  $m_B > 50\text{GeV}$  region has been investigated by the collider experiments.
- ◆ **GeV-scale domain is nearly untouched.**

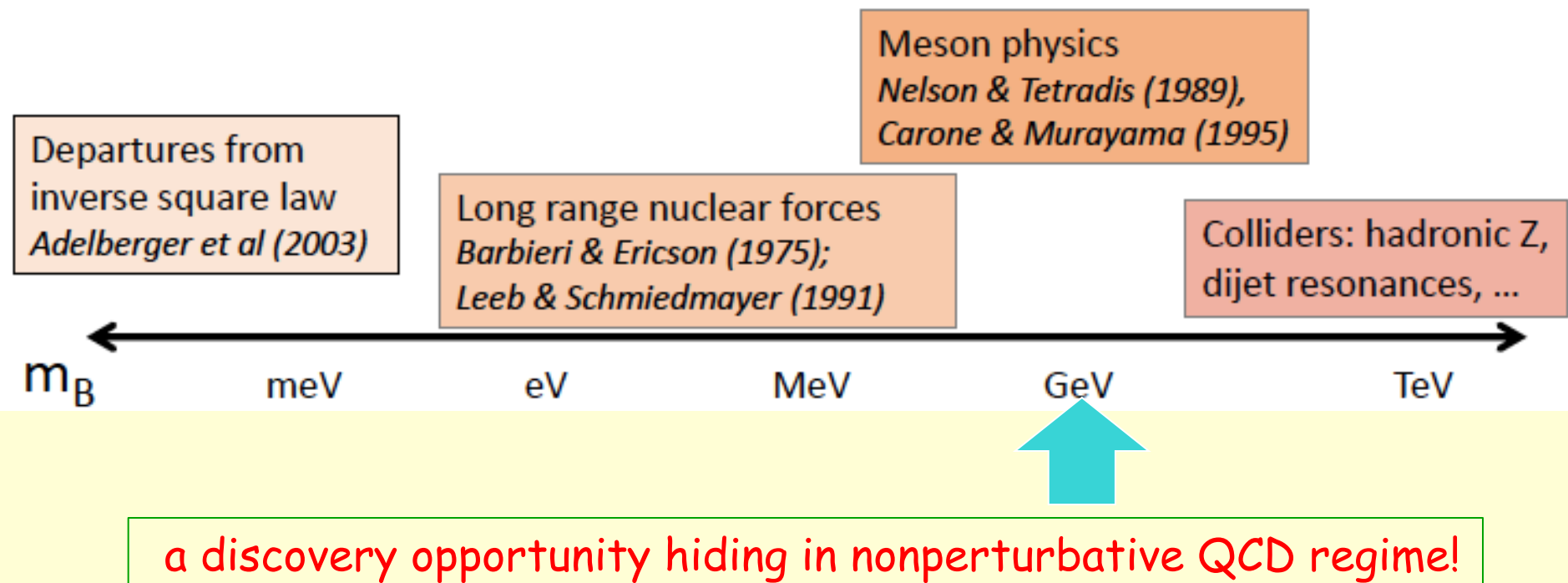

# Striking Signature for B-boson in $\eta \rightarrow \pi^0 \gamma \gamma$

- ◆ B production: A.E. Nelson, N. Tetradis, Phys. Lett., B221, 80 (1989)

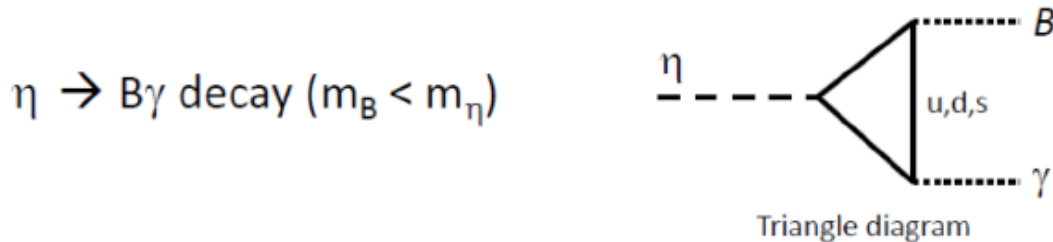

- ◆ B decays:  $B \rightarrow \pi^0 \gamma$  in 140-620 MeV mass range

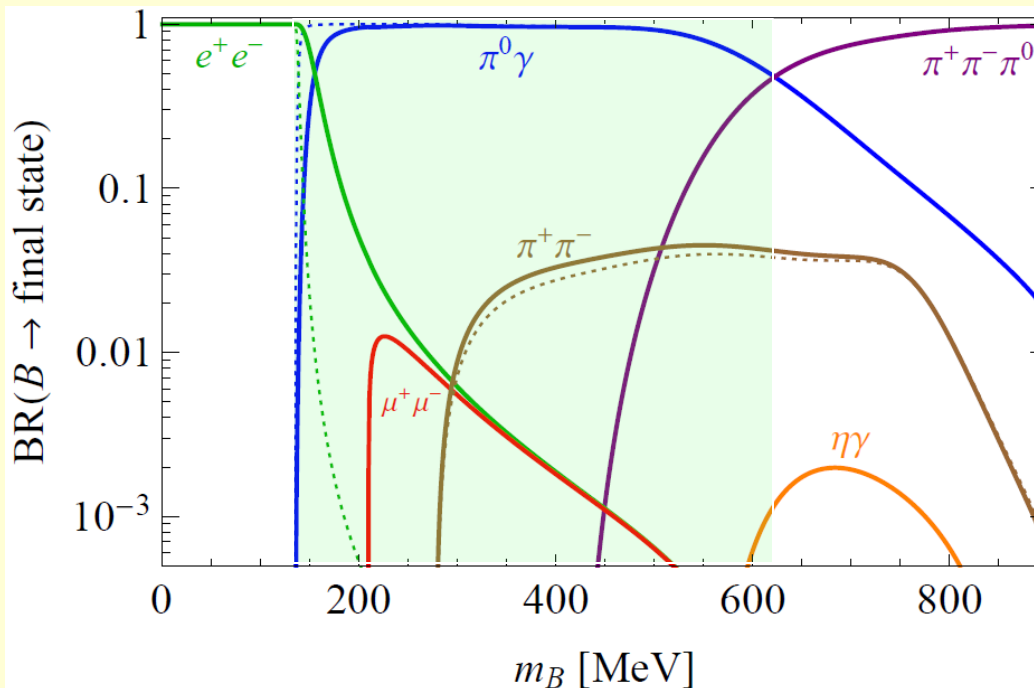

$$\eta \rightarrow \gamma B \rightarrow \gamma + \pi^0 \gamma$$

Search for a resonance peak of  $\pi^0 \gamma$  for  $m_B \sim 140-550$  MeV

S. Tulin, Phys.Rev., D89, 14008 (2014)

- ◆  $\Gamma(\eta \rightarrow \pi^0 \gamma \gamma) \sim 0.3 eV \rightarrow$  highly suppressed SM background

# JEF Experimental Reach ( $\eta \rightarrow B\gamma \rightarrow \pi^0\gamma\gamma$ )

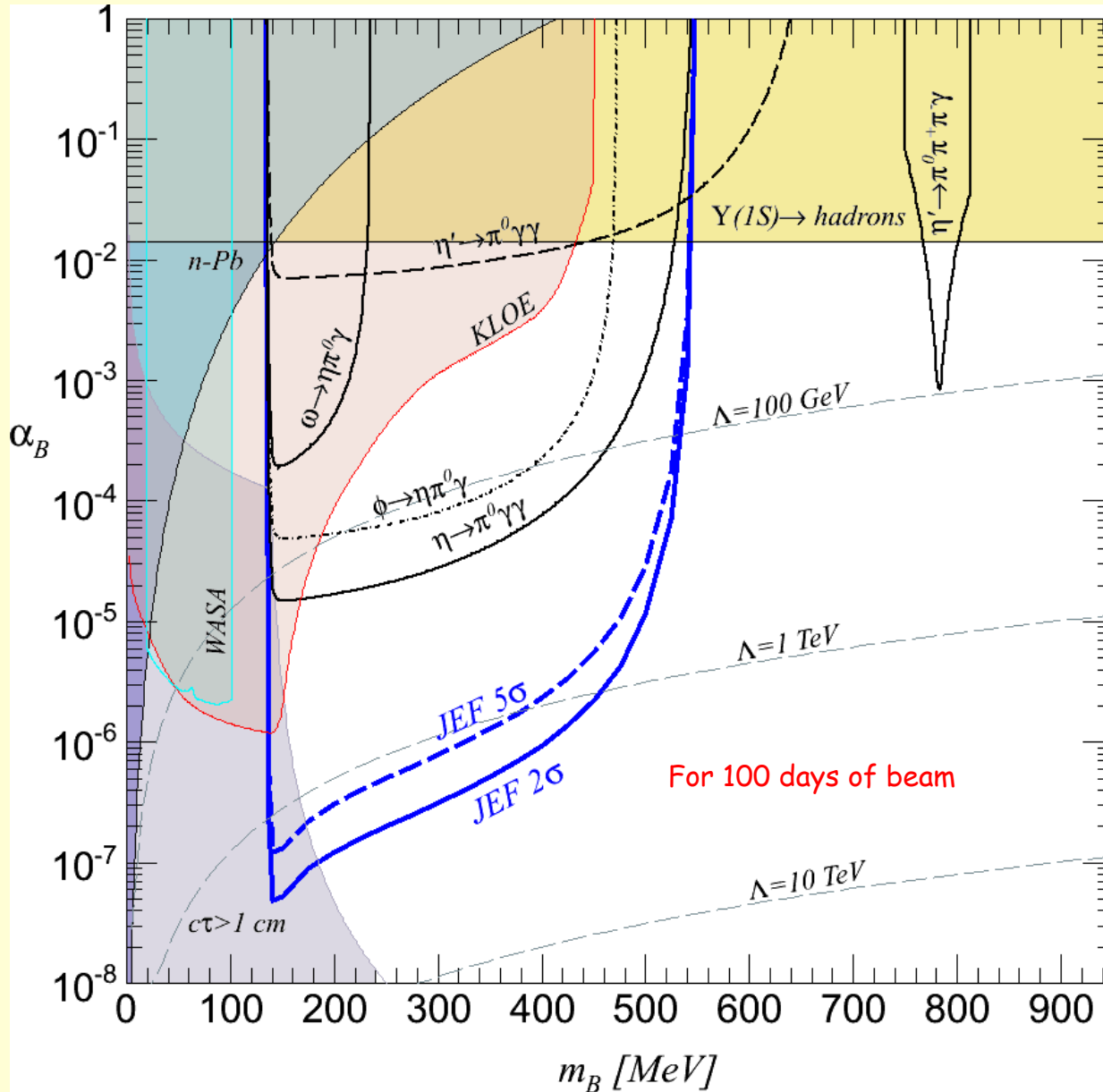

- ◆ A stringent constraint on the leptophobic B-boson in 140-550 MeV range.
- ◆ A positive signal of B in JEF will **imply a new fermion with a mass up to a few TeV** due to electro-weak anomaly cancellation.
- ◆ Future  $\eta'$  experiment will extend the experimental reach up to 1 GeV

Constraints from  $A'$  search (KLOE and WASA) assumed:  
 $\varepsilon \sim 0.1 \times e g_B / (4\pi)^2$

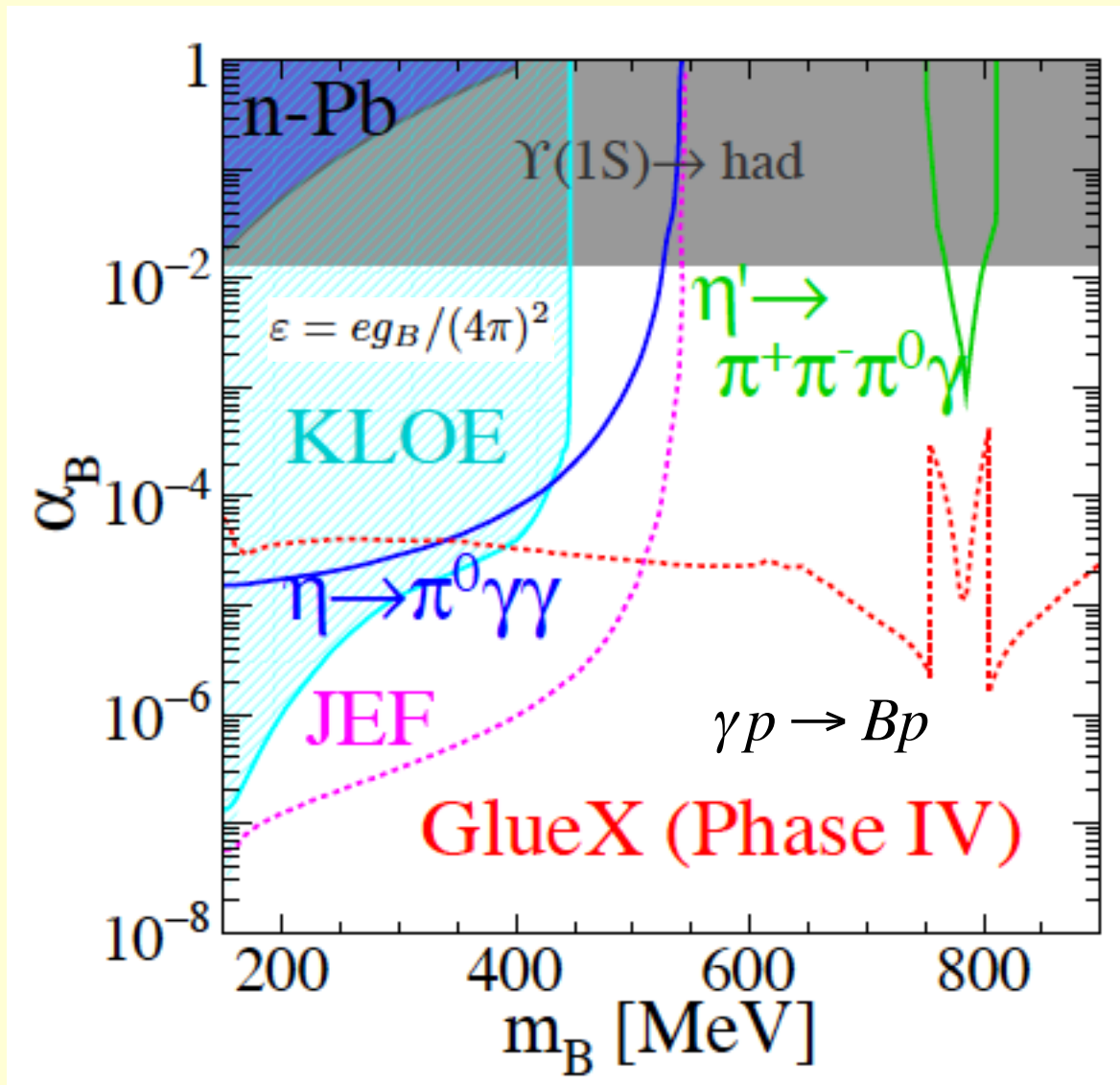

© C. Fanelli and M. Williams, arXiv:1606.07161

# The Four Classes of $C$ , $P$ , and $T$ Violations Assuming $CPT$ Invariance

B. Nefkens and J. Price, Phys. Scrip., T99, 114 (2002)

Class	Violated	Valid
1	$C, P, CT, PT$	$T, CP$
2	$C, P, T, CP, CT, PT$	
3	$P, T, CP, CT$	$C, PT$
4	$C, T, CP, PT$	$P, CT$

# The Four Classes of $C$ , $P$ , and $T$ Violations Assuming $CPT$ Invariance

B. Nefkens and J. Price, Phys. Scrip., T99, 114 (2002)

**Experimental tests**

Class	Violated	Valid
1	$C, P, CT, PT$	$T, CP$
2	$C, P, T, CP, CT, PT$	
3	$P, T, CP, CT$	$C, PT$
4	$C, T, CP, PT$	$P, CT$

# The Four Classes of C, P, and T Violations Assuming CPT Invariance

B. Nefkens and J. Price, Phys. Scrip., T99, 114 (2002)

## Experimental tests

Class	Violated	Valid
1	$C, P, CT, PT$	$T, CP$
2	$C, P, T, CP, CT, PT$	
3	$P, T, CP, CT$	$C, PT$
4	$C, T, CP, PT$	$P, CT$

EDM,  $\eta \rightarrow$  even  $\pi$ 's

# The Four Classes of C, P, and T Violations Assuming CPT Invariance

B. Nefkens and J. Price, Phys. Scrip., T99, 114 (2002)

## Experimental tests

Class	Violated	Valid
1	$C, P, CT, PT$	$T, CP$
2	$C, P, T, CP, CT, PT$	
3	$P, T, CP, CT$	$C, PT$
4	$C, T, CP, PT$	$P, CT$

P-violating exp.,  
 $\beta$ -decays,  
 K-, B-, D-meson decays  
 EDM,  $\eta \rightarrow$  even  $\pi$ 's



# The Four Classes of C, P, and T Violations Assuming CPT Invariance

B. Nefkens and J. Price, Phys. Scrip., T99, 114 (2002)

## Experimental tests

Class	Violated	Valid
1	$C, P, CT, PT$	$T, CP$
2	$C, P, T, CP, CT, PT$	
3	$P, T, CP, CT$	$C, PT$
4	$C, T, CP, PT$	$P, CT$

P-violating exp.,  
 $\beta$ -decays,  
 K-, B-, D-meson decays  
 EDM,  $\eta \rightarrow$  even  $\pi$ 's

17 C-tests involving  
 $\eta, \eta', \pi, \omega, J/\psi$  decays

# The Four Classes of C, P, and T Violations Assuming CPT Invariance

B. Nefkens and J. Price, Phys. Scrip., T99, 114 (2002)

## Experimental tests

Class	Violated	Valid
1	$C, P, CT, PT$	$T, CP$
2	$C, P, T, CP, CT, PT$	
3	$P, T, CP, CT$	$C, PT$
4	$C, T, CP, PT$	$P, CT$

P-violating exp.,  
 $\beta$ -decays,  
 K-, B-, D-meson decays  
 EDM,  $\eta \rightarrow$  even  $\pi$ 's

17 C-tests involving  $\eta$ ,  
 $\eta'$ ,  $\pi$ ,  $\omega$ , J/ $\psi$  decays

### For class 4:

- ❖ a few tests available
- ❖ not well tested experimentally in EM and strong interactions
- ❖ less constrained by nEDM and parity-violating experiments.
- ❖ offer a golden opportunity for new physics search.

# C Invariance

- ◆ Maximally violated in the weak force and is well tested.
- ◆ Assumed in SM for electromagnetic and strong forces, but **it is not experimentally well tested (The current constraint:  $\Lambda \geq 1 \text{ GeV}$ )**
- ◆ EDMs place no constraint on CVPC in the presence of a conspiracy or new symmetry; **only the direct searches are unambiguous.**

(M. Ramsey-Musolf, *phys. Rev.*, D63, 076007 (2001); [talk at the AFCI workshop](#) )

## C Violating $\eta$ neutral decays

Final State	Branching Ratio (upper limit)	Gammas in Final State
$3\gamma$	$< 1.6 \cdot 10^{-5}$	3
$\pi^0\gamma$	$< 9 \cdot 10^{-5}$	
$2\pi^0\gamma$	$< 5 \cdot 10^{-4}$	5
$3\gamma\pi^0$	Nothing published	
$3\pi^0\gamma$	$< 6 \cdot 10^{-5}$	7
$3\gamma 2\pi^0$	Nothing published	

# C Invariance

- ◆ Maximally violated in the weak force and is well tested.
- ◆ Assumed in SM for electromagnetic and strong forces, but **it is not experimentally well tested (The current constraint:  $\Lambda \geq 1 \text{ GeV}$ )**
- ◆ EDMs place no constraint on CVPC in the presence of a conspiracy or new symmetry; **only the direct searches are unambiguous.**

(M. Ramsey-Musolf, *phys. Rev.*, D63, 076007 (2001); [talk at the AFCI workshop](#) )

## C Violating $\eta$ neutral decays

Final State	Branching Ratio (upper limit)	Gammas in Final State
$3\gamma$	$< 1.6 \cdot 10^{-5}$	3
$\pi^0\gamma$	$< 9 \cdot 10^{-5}$	
$2\pi^0\gamma$	$< 5 \cdot 10^{-4}$	5
$3\gamma\pi^0$	Nothing published	
$3\pi^0\gamma$	$< 6 \cdot 10^{-5}$	7
$3\gamma 2\pi^0$	Nothing published	

# Experimental Improvement in $\eta \rightarrow 3\gamma$

- ◆ SM contribution:  
 $BR(\eta \rightarrow 3\gamma) < 10^{-19}$  via P-violating weak interaction.
- ◆ A new C- and T-violating, and P-conserving interaction was proposed by Bernstein, Feinberg and Lee *Phys. Rev.*,139, B1965 (1965)
- ◆ A calculation due to such new physics by Tarasov suggests:  
 $BR(\eta \rightarrow 3\gamma) < 10^{-2}$   
*Sov.J.Nucl.Phys.*,5,445 (1967)
- ◆ A new investigation by M. Ramsey-Musolf and two Ph.D. students is in progress

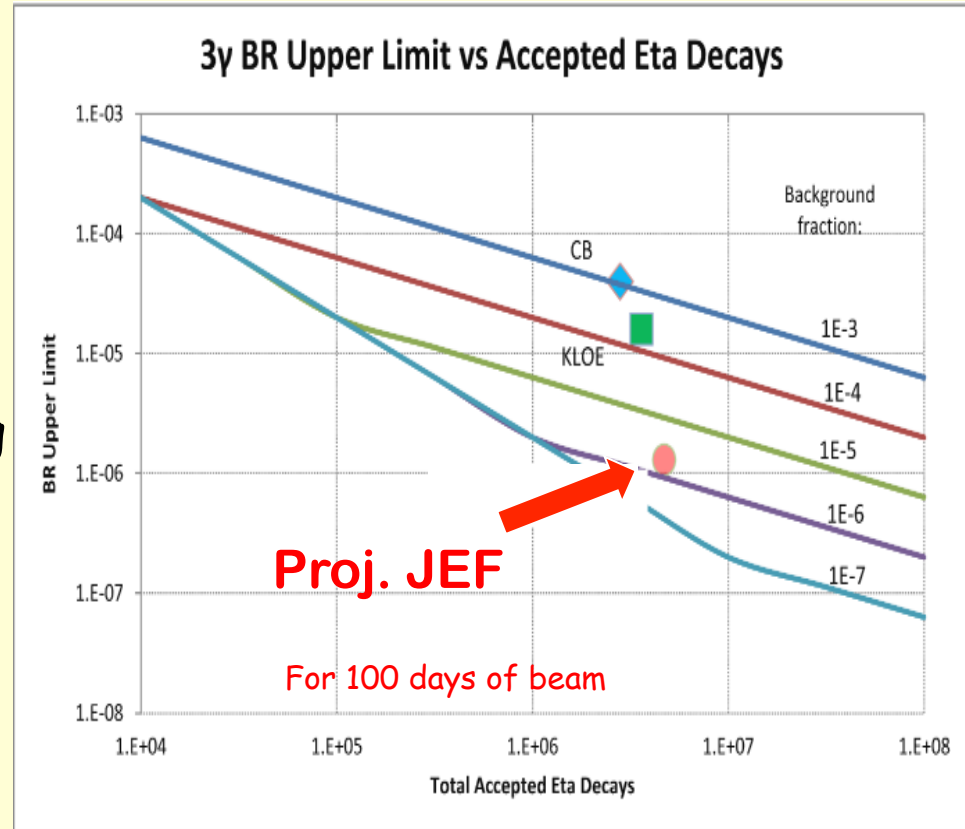

Improve BR upper limit by one order of magnitude to directly tighten the constraint on CVPC new physics

# Measurement of $\eta \rightarrow 3\pi$ Dalitz Distribution

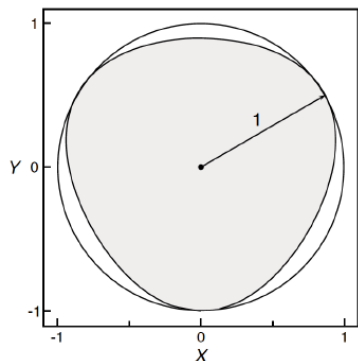

$$X = \frac{\sqrt{3}}{2M_\eta Q_c} (u - t)$$

$$Y = \frac{3}{2M_\eta Q_c} \left( (M_\eta - M_{\pi^0})^2 - s \right) - 1$$

$$Z = X^2 + Y^2$$

$$Q_c \equiv M_\eta - 2M_{\pi^+} - M_{\pi^0}$$

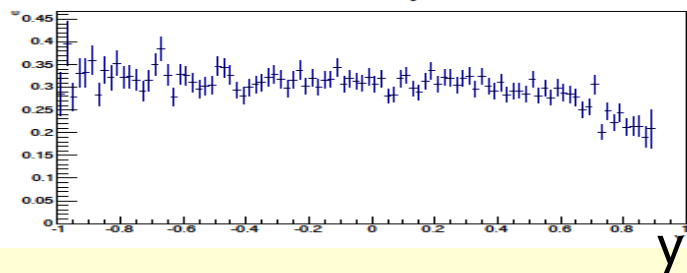
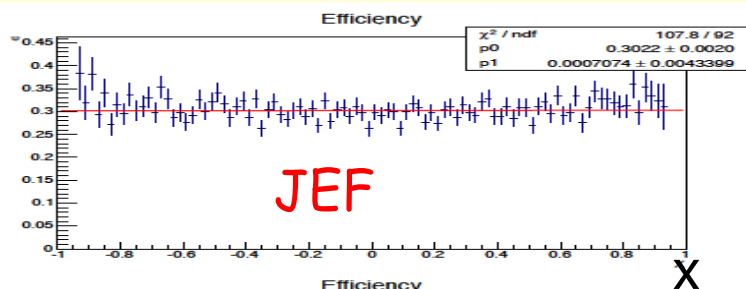
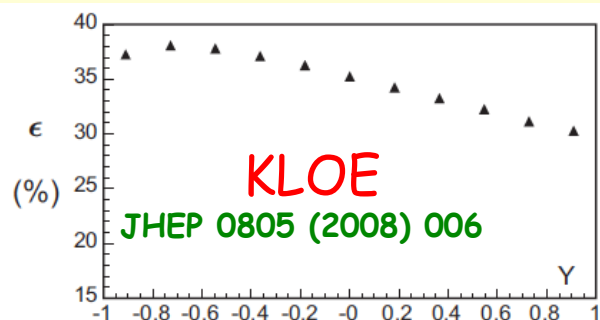

Exp.	$3\pi^0$ Events ( $10^6$ )	$\pi^+ \pi^- \pi^0$ Events ( $10^6$ )
Total world data (include prel. WASA and prel. KLOE)	6.5	6.0
GlueX+PrimEx- $\eta$ +JEF	20	19.6

- ◆ Existing data from the **low energy** facilities are sensitive to the detection threshold effects
- ◆ JEF at **high energy** has uniform detection efficiency over Dalitz phase space
- ◆ JEF will offer large statistics and improved systematics

## Anatomy of CP Violation in $\Gamma(M_{C=+} \rightarrow \pi^+ \pi^- \pi^0)$

C-odd, P-even

This can be generated by  $s - p$  interference of  $\left| [\pi^+(\mathbf{p}) \pi^-(-\mathbf{p})]_I \pi^0(\mathbf{p}')_I \right\rangle$  final states of  $0^-$  meson decay.

It is linear in a CP-violating parameter.

This contribution **cannot** be generated by  $\bar{\theta}_{\text{QCD}}$ !

“C violation” [Lee and Wolfenstein, 1965; Lee, 1965; Nauenberg, 1965; Bernstein, Feinberg, and Lee, 1965]

C-even, P-odd

This can be generated by the interference of amplitudes which distinguish  $\left| [\pi^-(\mathbf{p}) \pi^0(-\mathbf{p})]_I \pi^+(\mathbf{p}')_I \right\rangle$  from  $\left| [\pi^+(\mathbf{p}) \pi^0(-\mathbf{p})]_I \pi^-(\mathbf{p}')_I \right\rangle$  as in, e.g.,  $B \rightarrow \rho^+ \pi^-$  vs.  $B \rightarrow \rho^- \pi^+$ . “CP-enantiomers” [SG, 2003]

This possibility is not accessible in  $\eta \rightarrow \pi^+ \pi^- \pi^0$  decay (but in  $\eta'$  decay, yes). Thus a “left-right” asymmetry in  $\eta \rightarrow \pi^+ \pi^- \pi^0$  decay tests C-invariance, too.

# Constrain Light Quark Mass Ratio via $\eta \rightarrow 3\pi$ Dalitz Distribution

- ◆ **A clean probe for quark mass ratio:**  $Q^2 = \frac{m_s^2 - \hat{m}^2}{m_d^2 - m_u^2} \quad \hat{m} = \frac{m_u + m_d}{2}$

$$A(\eta \rightarrow 3\pi) = \frac{1}{Q^2} \frac{m_K^2}{m_\pi^2} (m_\pi^2 - m_K^2) \frac{M(s, t, u)}{3\sqrt{3}F_\pi^2}$$

- ◆ Uncertainties in quark mass ratio (E. Passemar, [talk at AFCI workshop](#))

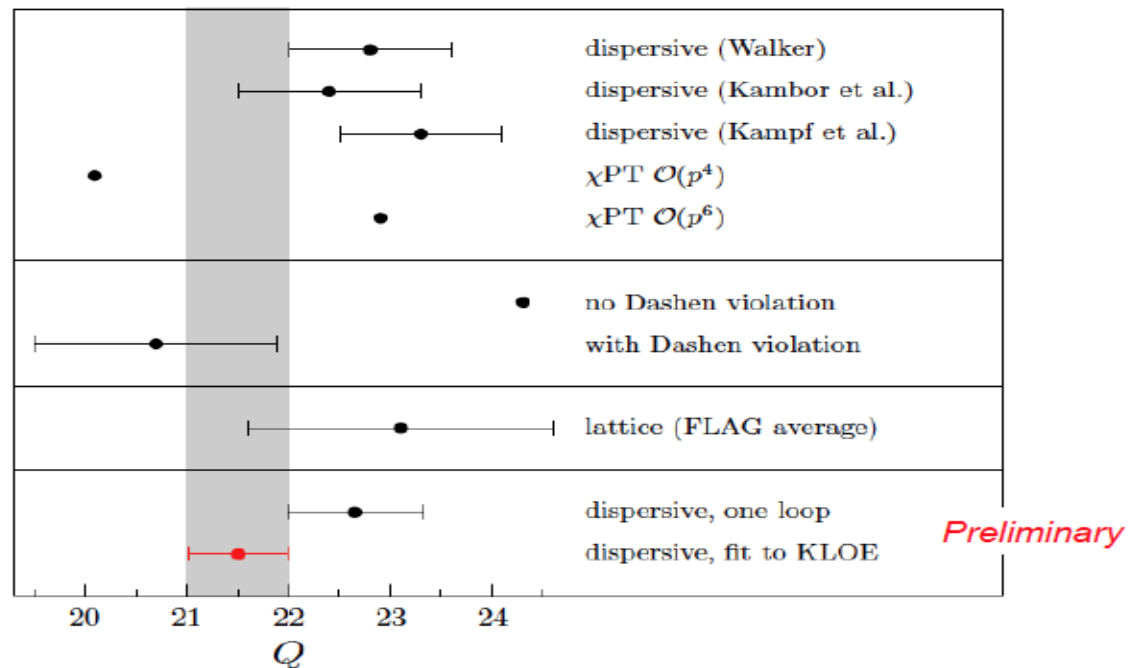
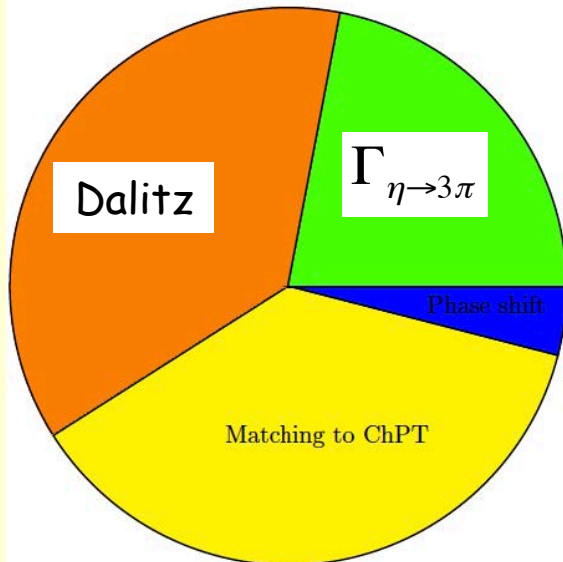



# Constrain Light Quark Mass Ratio via $\eta \rightarrow 3\pi$ Dalitz Distribution

- ◆ **A clean probe for quark mass ratio:**  $Q^2 = \frac{m_s^2 - \hat{m}^2}{m_d^2 - m_u^2}$       $\hat{m} = \frac{m_u + m_d}{2}$

$$A(\eta \rightarrow 3\pi) = \frac{1}{Q^2} \frac{m_K^2}{m_\pi^2} (m_\pi^2 - m_K^2) \frac{M(s, t, u)}{3\sqrt{3}F_\pi^2}$$

- ◆ Uncertainties in quark mass ratio (E. Passemar, [talk at AFCI workshop](#))

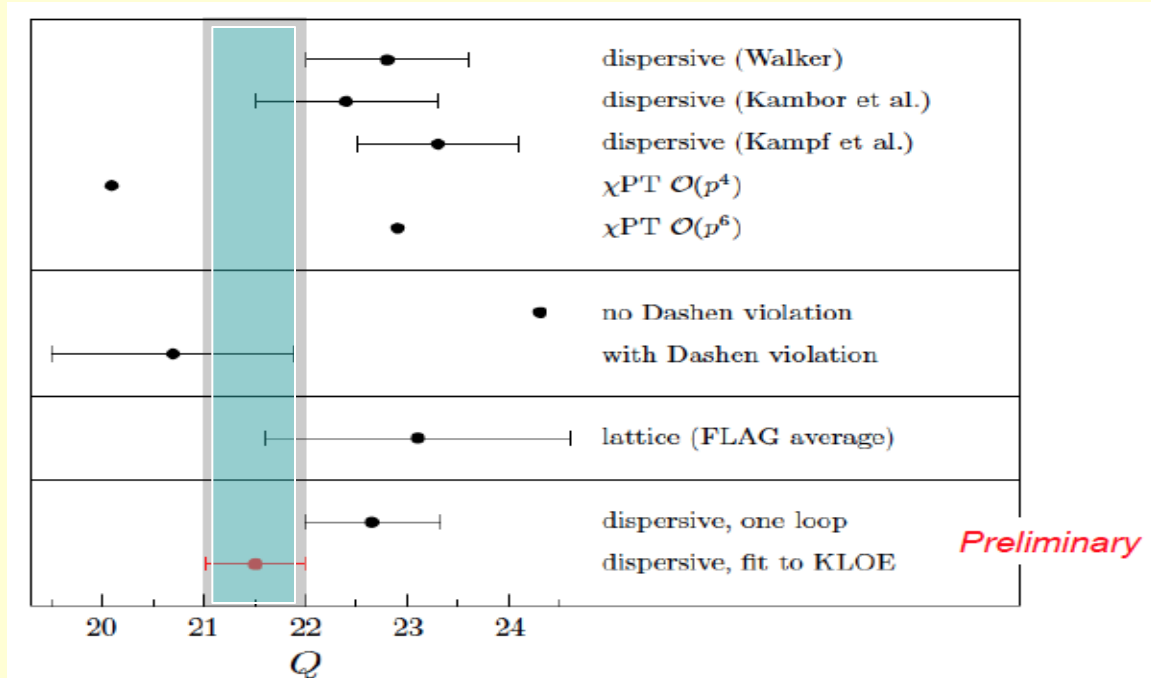
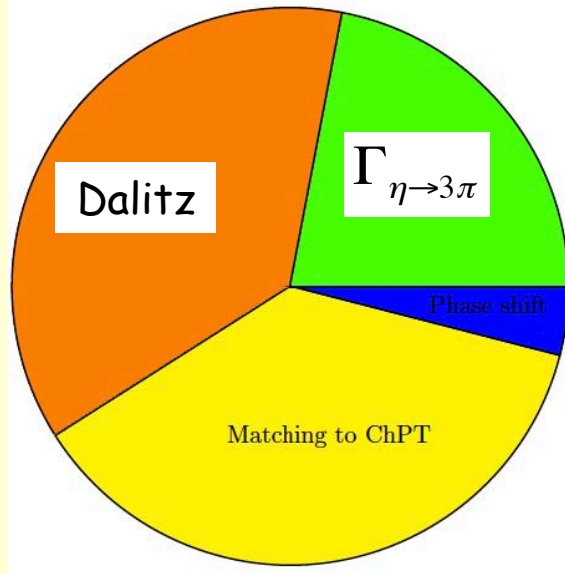

# SM Allowed $\eta \rightarrow \pi^0 \gamma \gamma$

→ A rare window to probe interplay of VMD & scalar resonances in ChPT to calculate  $O(p^6)$  LEC's in the chiral Lagrangian  
 (J. Bijnens, [talk at AFCT workshop](#))

◆ The major contributions to  $\eta \rightarrow \pi^0 \gamma \gamma$  are **two  $O(p^6)$  counter-terms** in the chiral Lagrangian → an unique probe for the high order ChPT.

L. Ametller, J. Bijnens, and F. Cornet, Phys. Lett., B276, 185 (1992)

◆ Shape of Dalitz distribution is sensitive to the role of scalar resonances.

LEC's are dominated by meson resonances

Gasser, Leutwyler 84; Ecker, Gasser, Pich, de Rafael 1989; Donoghue, Ramirez, Valencia 1989

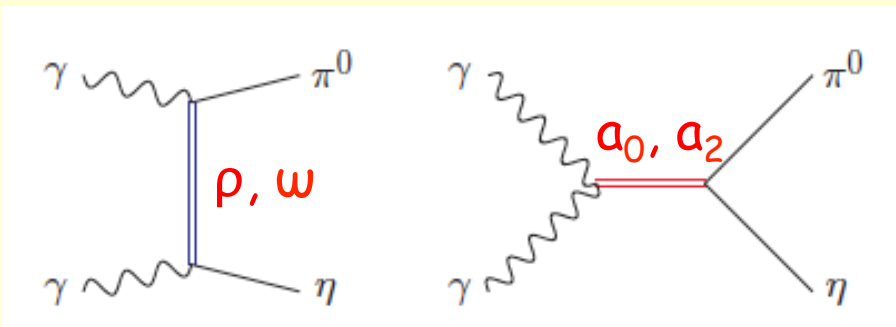

Oset, Pelaez, Roca., Phys. Rev. D 77 (2008) 073001 [0801.2633]

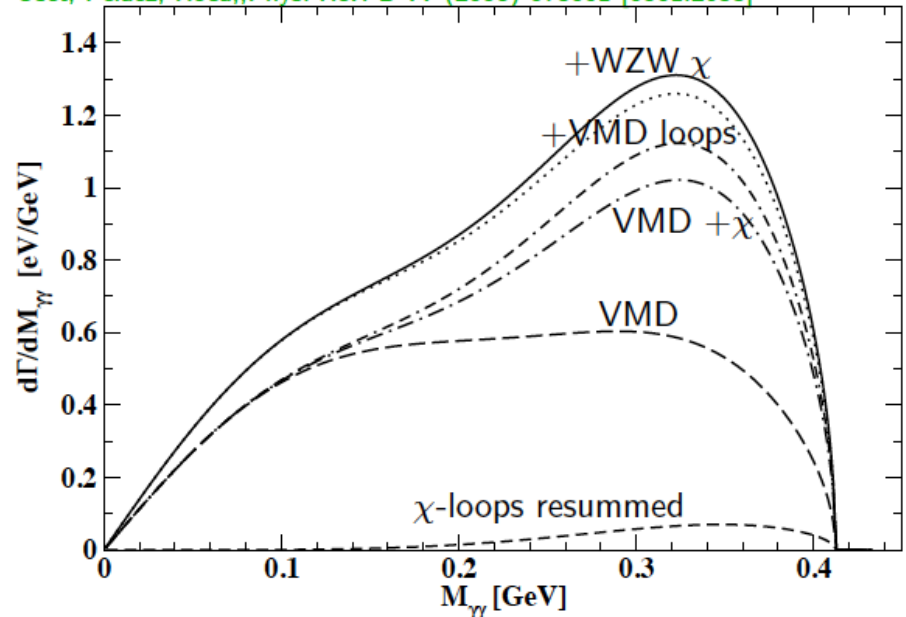

# Projected JEF Results on $\eta \rightarrow \pi^0 \gamma \gamma$

J.N. Ng and D.J. Peters, Phys. Rev. D47, 4939

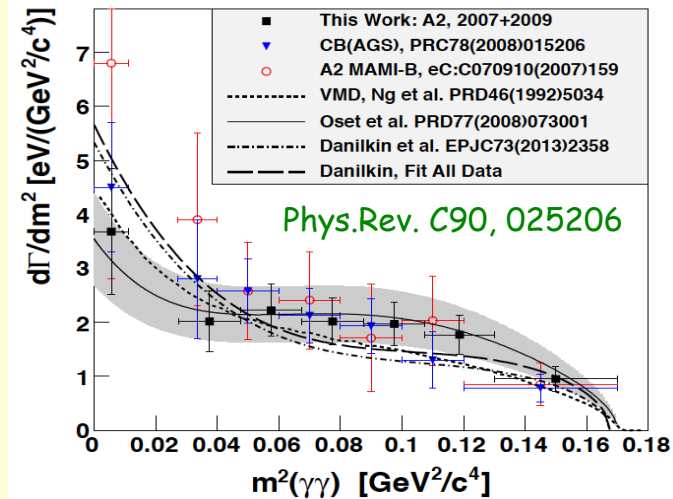
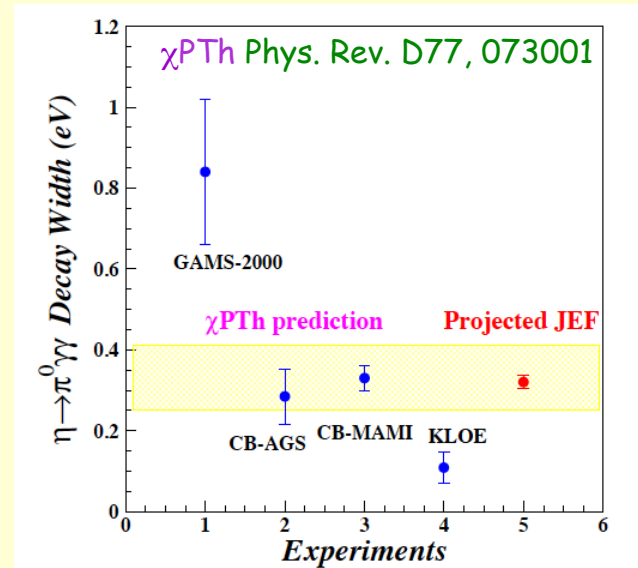
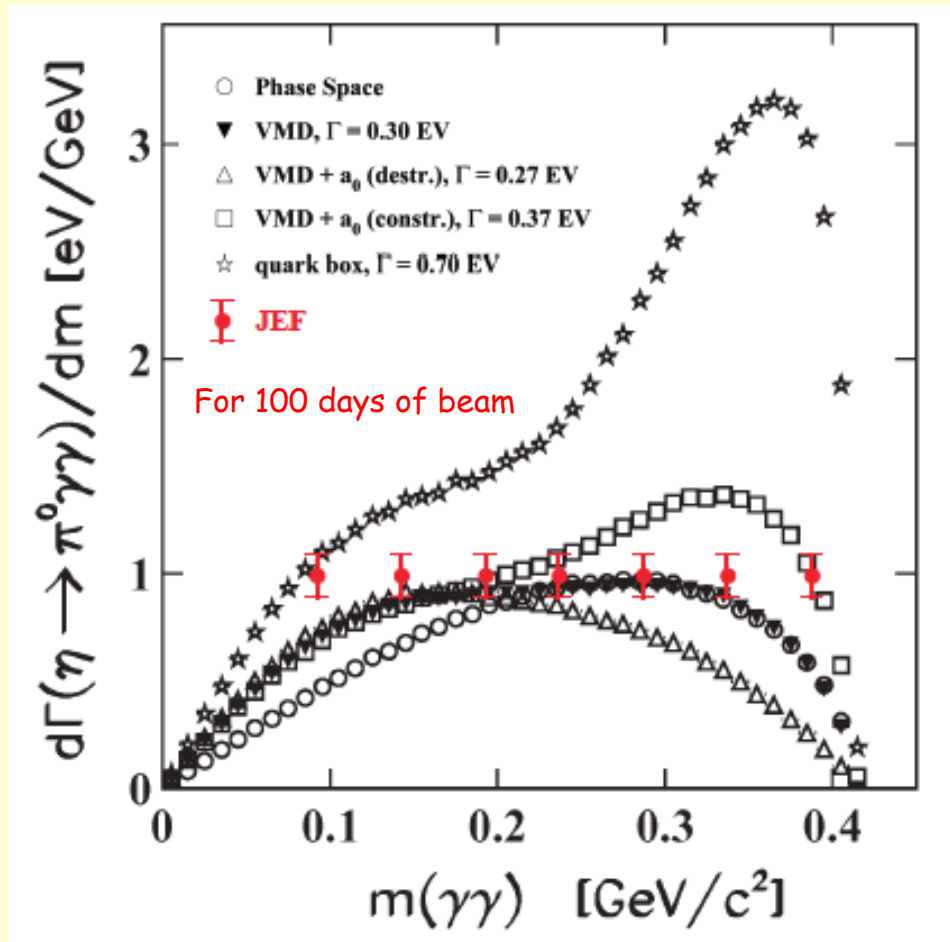

We measure both BR and Dalitz distribution

- ◆ model-independent determination of two LEC's of the  $O(p^6)$  counter-terms
- ◆ probe the role of scalar resonances to calculate other unknown  $O(p^6)$  LEC's

J. Bijmans, talk at AFCI workshop

# 12 GeV Jlab and GlueX

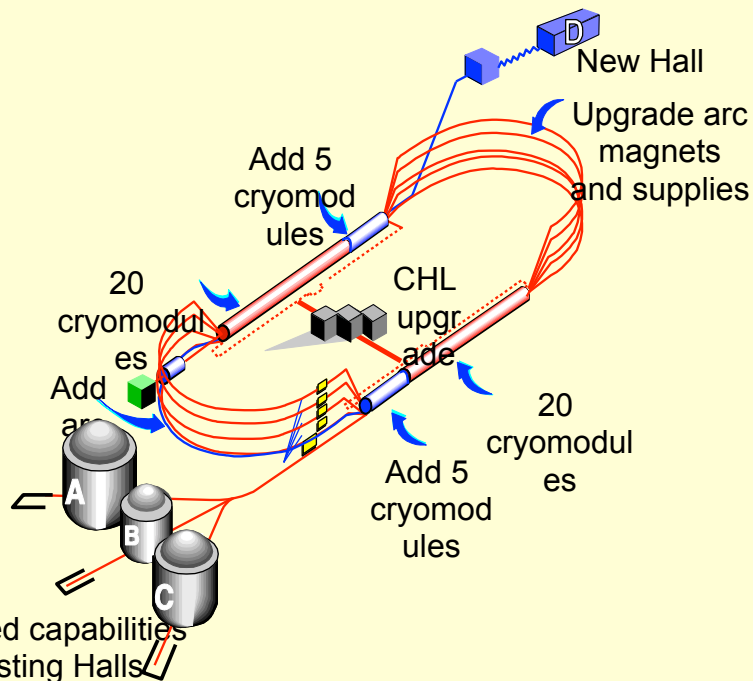

Preliminary result from commissioning runs  
 $M(2\gamma)$

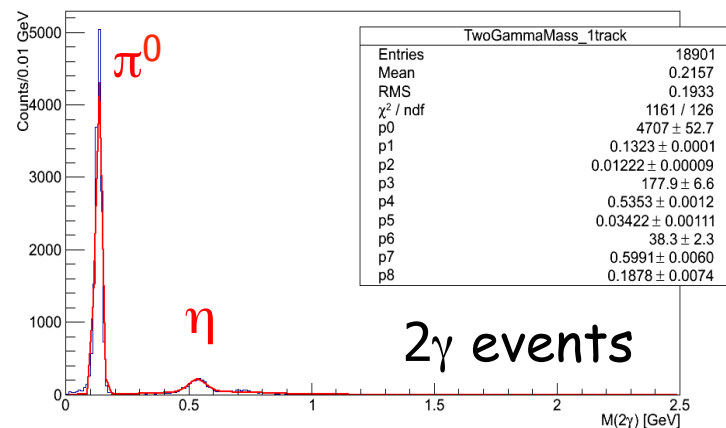

# Summary

- A comprehensive Primakoff program has been developed at Jlab to measure  $\Gamma(p \rightarrow \gamma\gamma)$  and  $F(\gamma\gamma^* \rightarrow p)$  of  $\pi^0$ ,  $\eta$  and  $\eta'$ . These results will provide rich data sets to test the fundamental symmetries of QCD at low energy.
  - tests of chiral symmetry and anomalies
  - light quark mass ratio
  - $\eta$ - $\eta'$  mixing angle
  - $\pi^0, \eta$  and  $\eta'$  electromagnetic interaction radii
  - inputs for  $a_\mu$ (HLbL) calculations
  
- 12 GeV tagged photon beam with GlueX setup offers a unique  $\eta$  facility with two orders of magnitude in background reduction in the neutral rare  $\eta$  decays compared to other facilities in the world.
  - Probe a leptophobic dark B-boson in 140-550 MeV range via  $\eta \rightarrow B\gamma \rightarrow \pi^0\gamma\gamma$
  - Directly constrain CVPC new physics via  $\eta \rightarrow 3\gamma$  and other C-violating channels
  - A clean determination of the light quark mass ratio via  $\eta \rightarrow 3\pi$
  - Test the role of scalar dynamics in ChPT through  $\eta \rightarrow \pi^0\gamma\gamma$