

The ALICE DAQ and DDL

LHC experiments

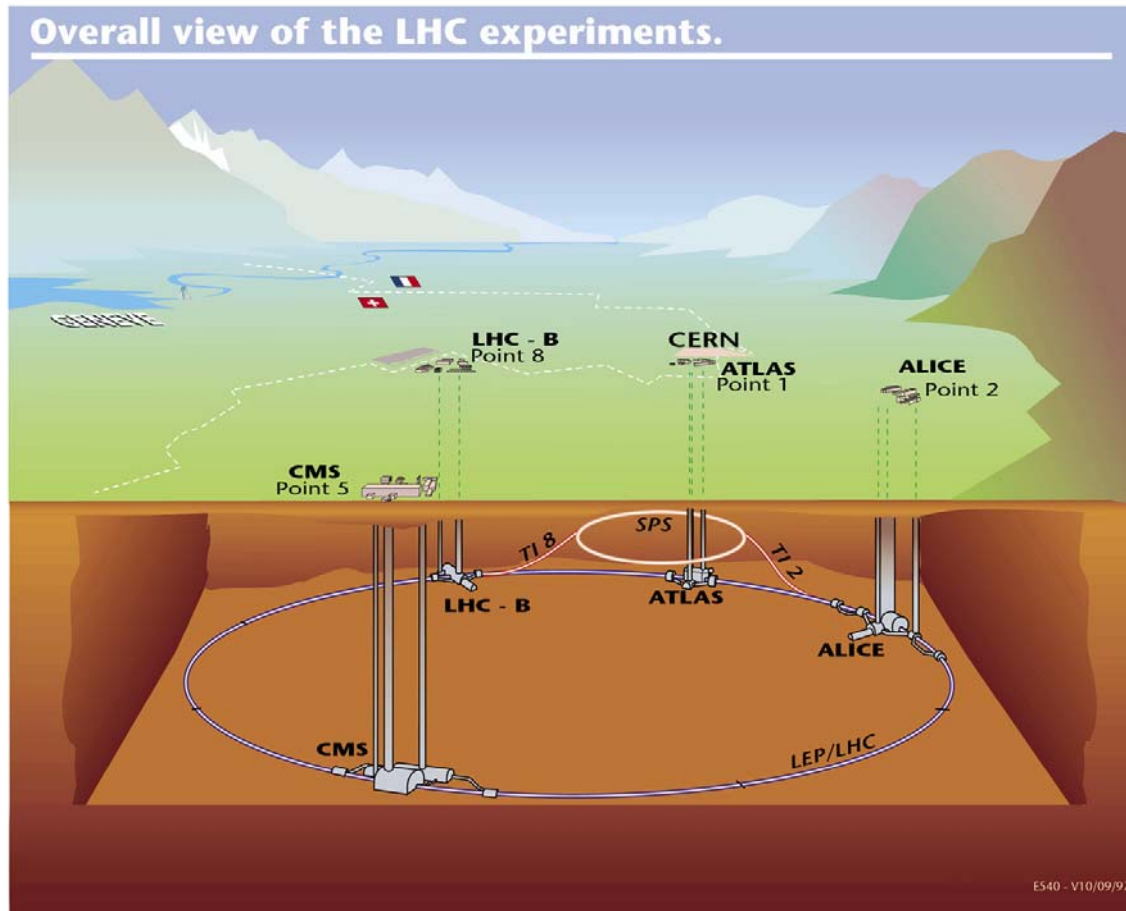

ALICE experiment

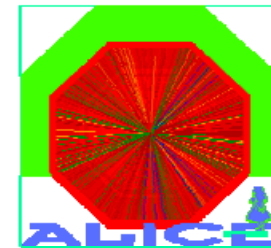

<http://aliceinfo.cern.ch>

- ALICE = A Large Ion Collider Experiment @ CERN LHC
 - 17 sub-detectors: SPD, SSD, SDD, TPC, TDR, TOF, MUON TRK, MUON TRG, HMPID, PHOS, FMD, T0, V0, ZDC, PMD, ACORDE, EMCAL
 - Designed for Pb-Pb collisions (1 month/year)
 - Study as well p-p collisions

ALICE data-acquisition system

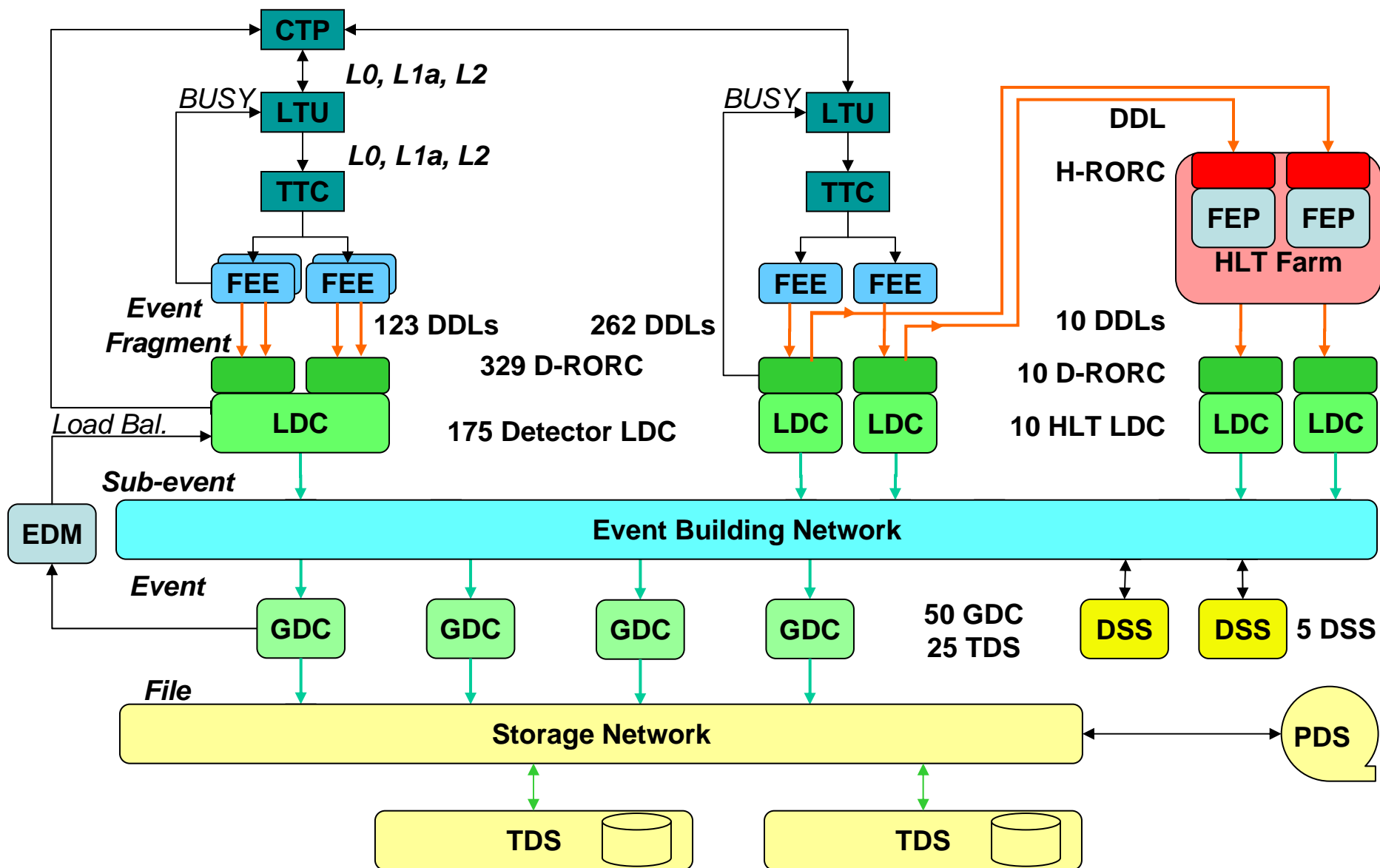

DDL architecture

- Source Interface Unit (SIU) (1)
 - Interface to the Front-end Electronics (2)
- Read-out Receiver Card (D-RORC) (3)
 - With integrated Destination Interface Unit (DIU)
- Full duplex optical link (4)
 - Multimode optical cable of up to 200 m

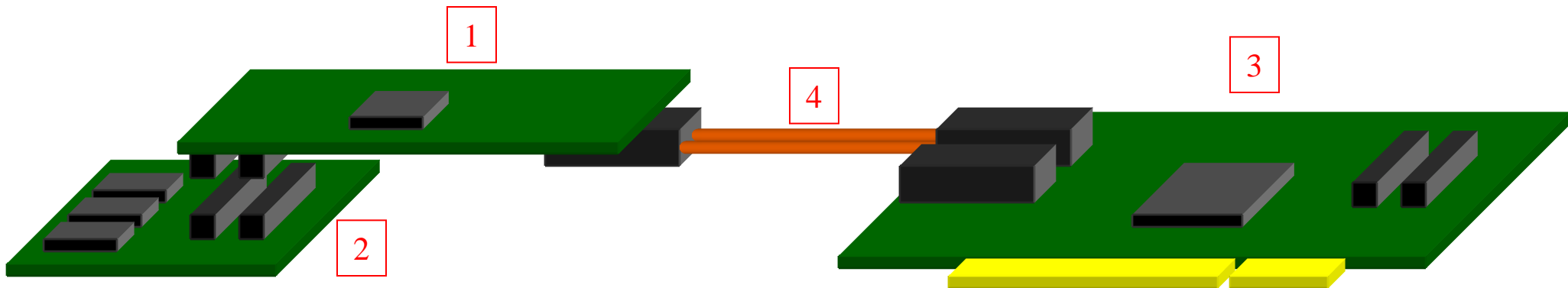

DAQ Read-out Receiver Card (D-RORC)

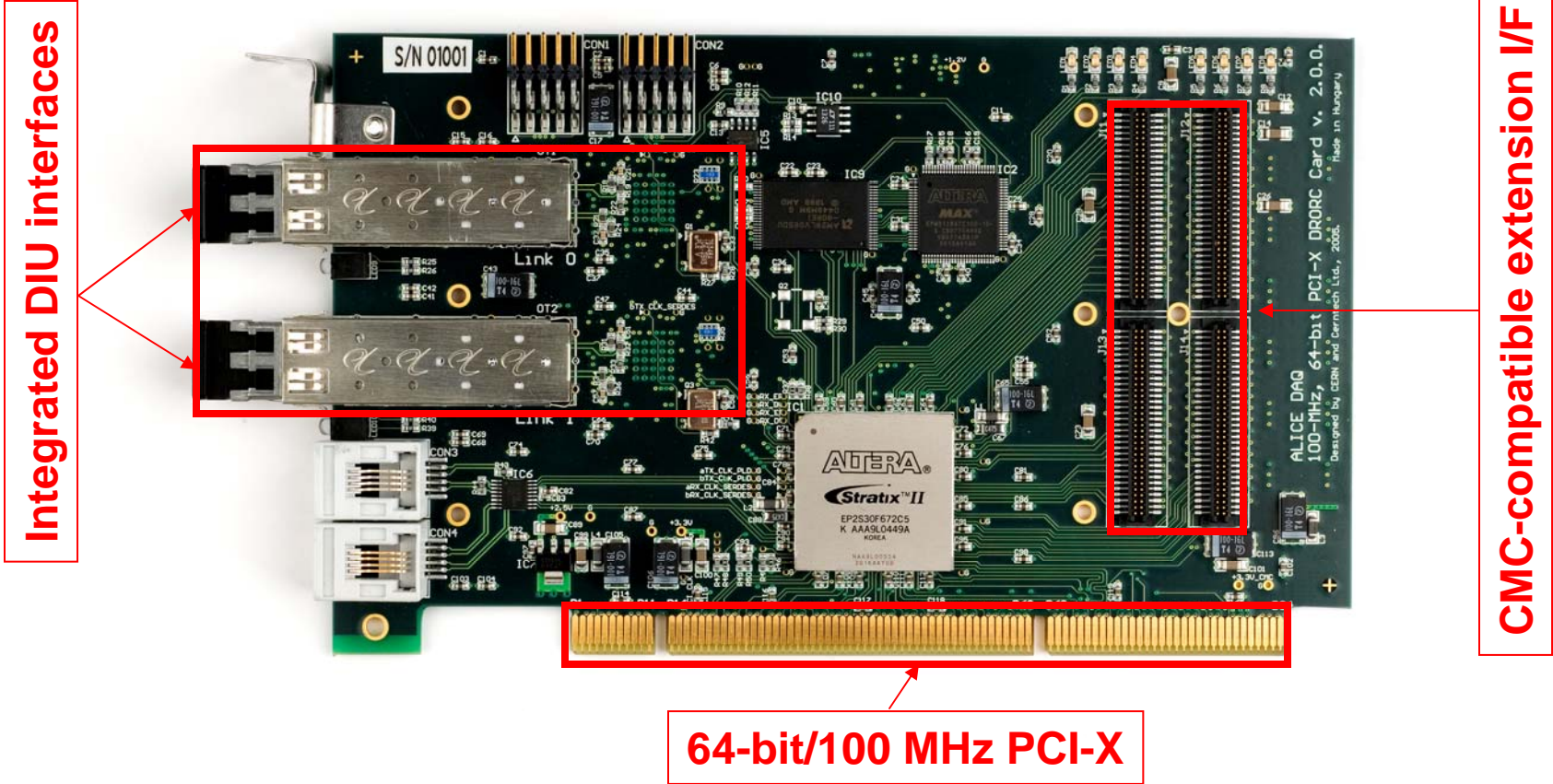

RORC features

- Interface between the DDL and PCI local bus
 - D-RORC: 64 bit/100 MHz PCI-X version, max. throughput 800 MB/s
- PCI master capability, data push architecture
 - Autonomous operation with little software assistance
 - Supports multi-paged memory management
- Direct data transfer to the PC memory
 - No local memory on the board
 - Small elasticity buffers between different clock domains
- Built-in test capability
 - Internal pattern generator can produce formatted data

Memory allocation

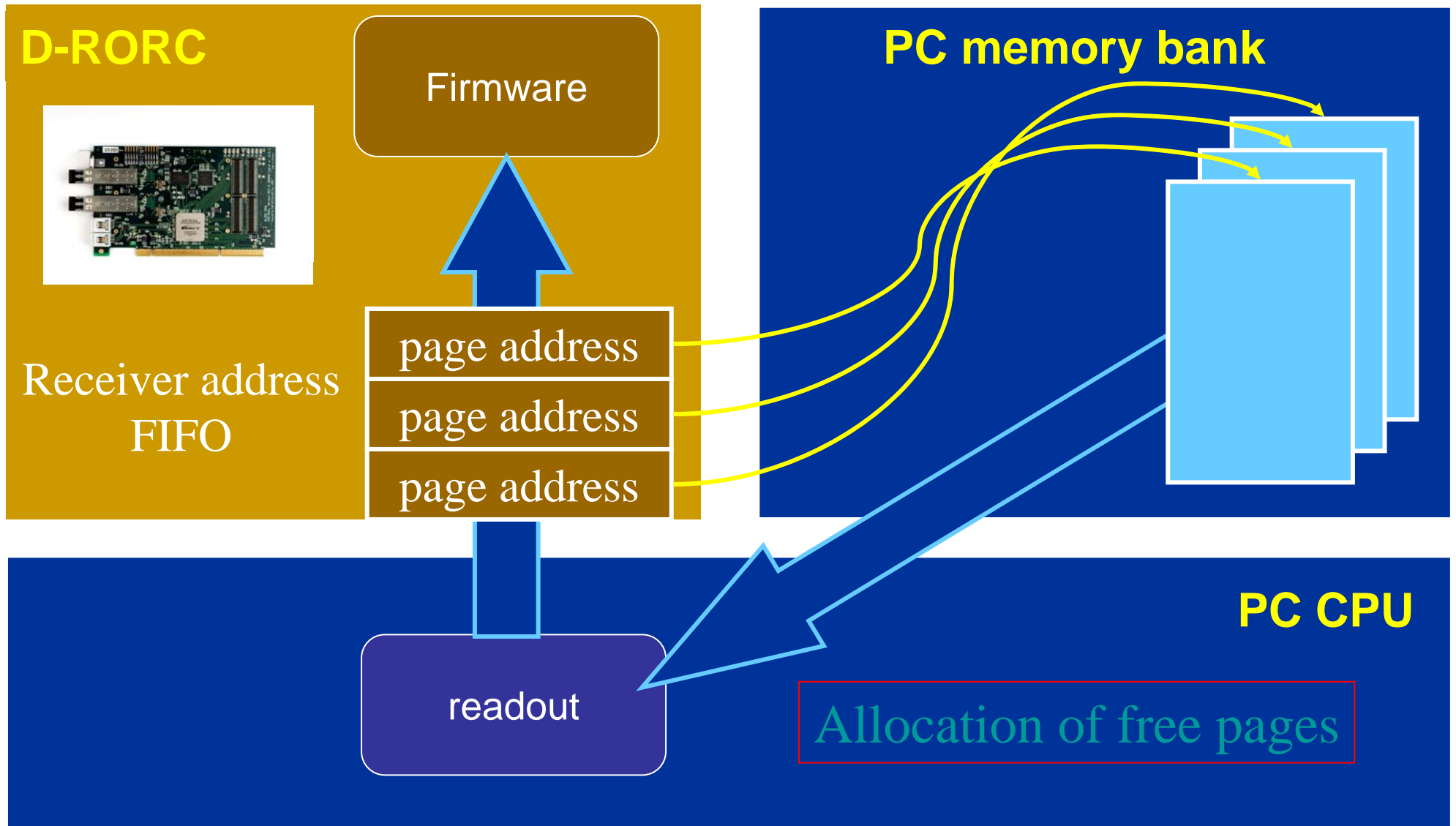

Direct Memory Access

DDL

PRORC



Firmware

PC memory bank

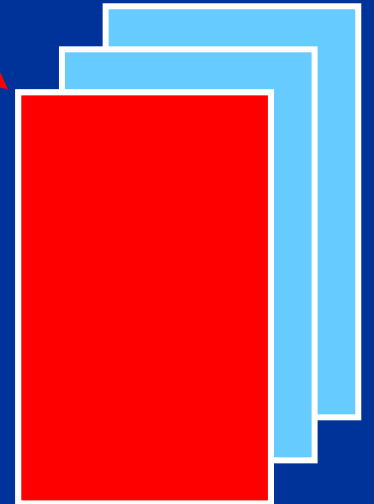

PC CPU

No involvement

Transfer report

DDL

