

# Future upgrades to the LHC

Alex Tapper

**IOP** Institute of Physics

**Joint annual HEPP and APP conference**

21–23 March 2016, University of Sussex, Brighton, UK



- Physics motivation
- Accelerator overview
- Detector upgrades
- Summary



Great success in Run 1...

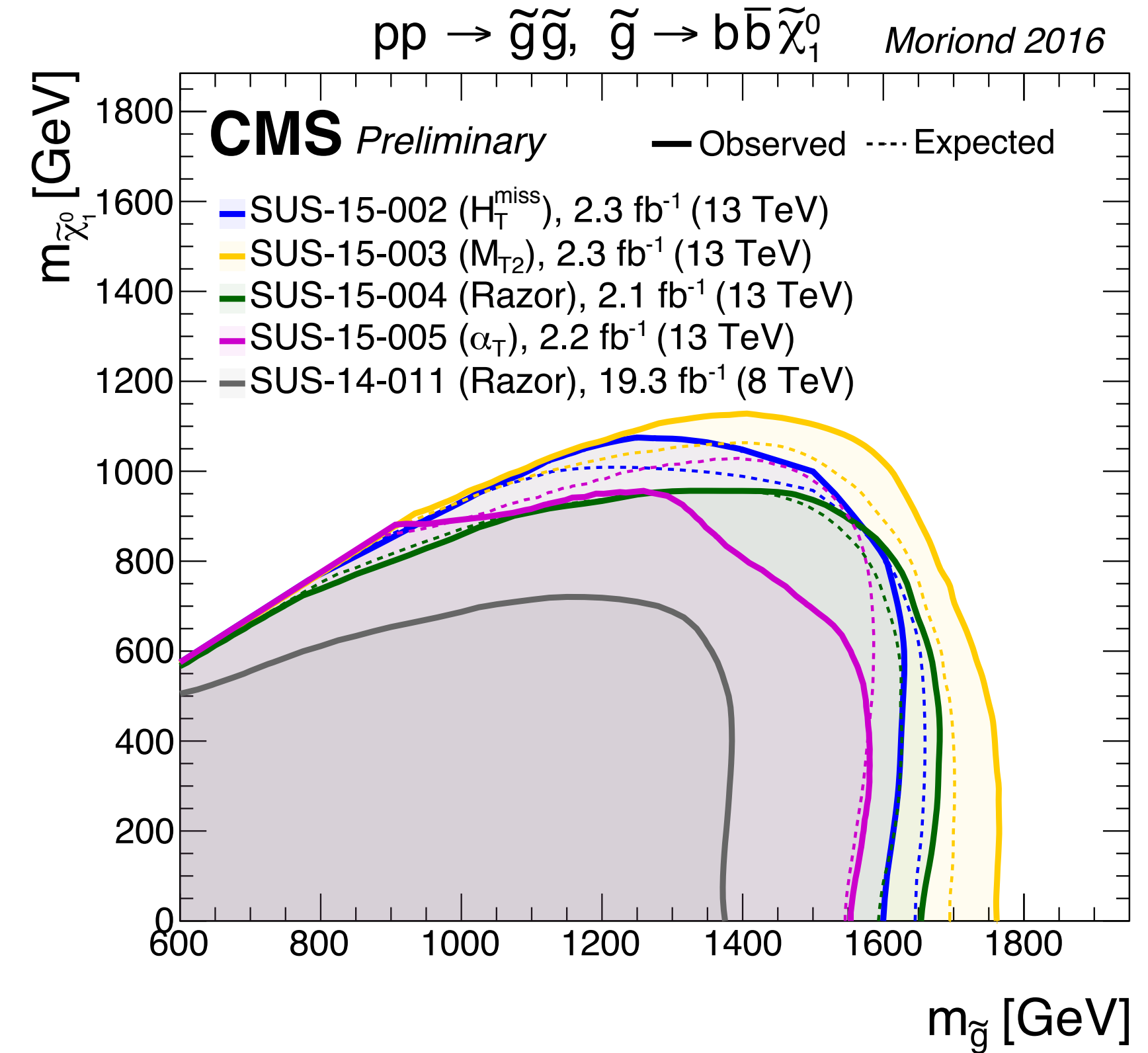
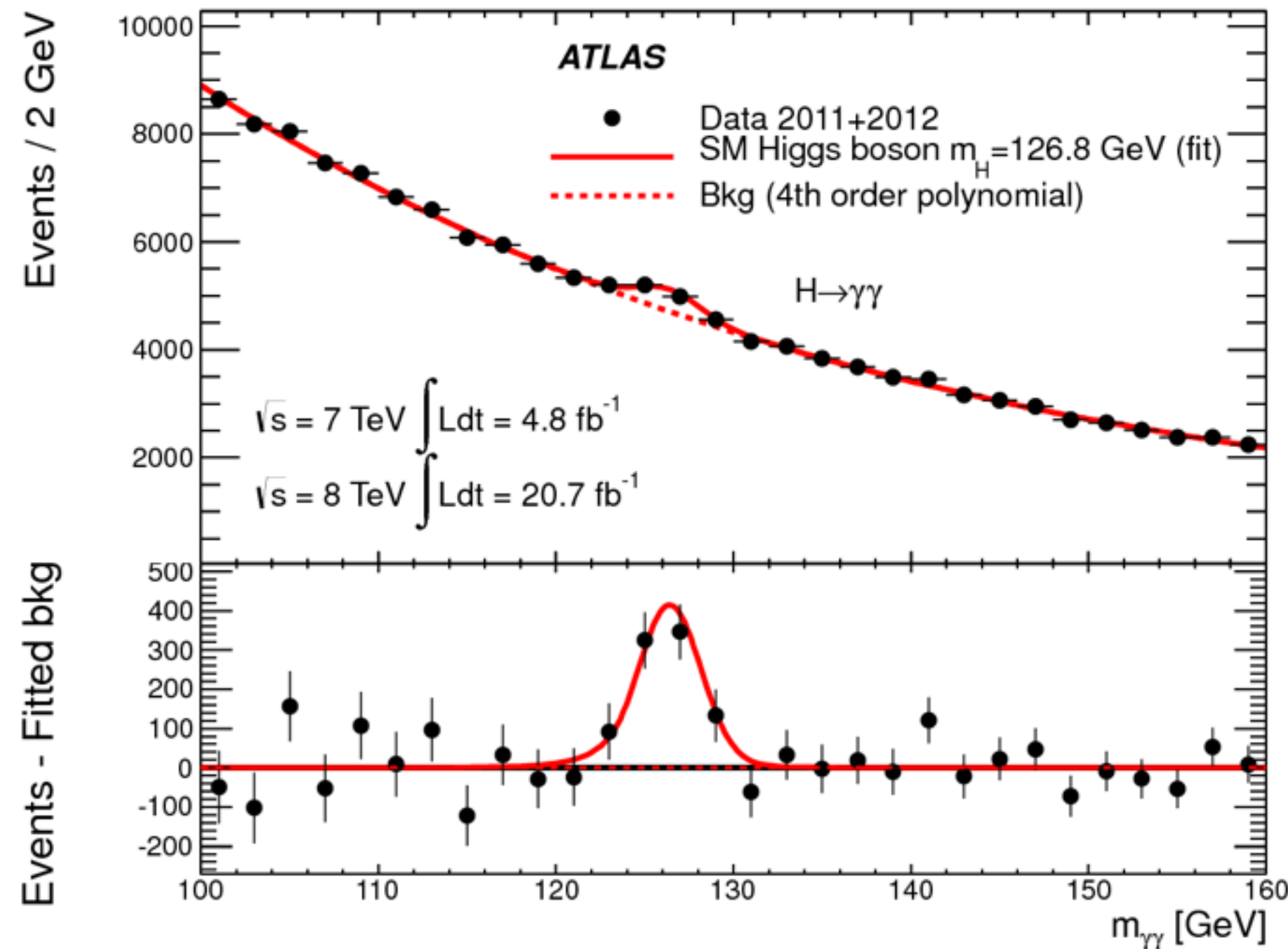

... and a strong start to Run 2

- Measurements of Higgs will play a big role in future
- Upgraded LHC is a *Higgs factory*
  - ▶ Run 1  $\mathcal{O}(1000)$  Higgs bosons at LHC
  - ▶ Upgrade factor 4-10 better measurements than today
  - ▶ Millions of events in all production modes
  - ▶ Access to rare decays of Higgs

	Total Higgs Bosons
LHC Run 1	<b>660k</b>
HL-LHC, 3000 fb <sup>-1</sup>	<b>170M</b>
VBF (all decays)	13M
ttH (all decays)	1.8M
H → $\gamma\gamma$	390k
H → Z $\gamma$	230k
H → $\mu\mu$	37k
H → J/ $\psi\gamma$	400
HH (all)	121K
HH → WWWW	9200
HH → bb $\gamma\gamma$	320
HH → $\gamma\gamma\gamma\gamma$	1

- Measurements of Higgs couplings

- ▶ Answering the question, *is this the SM Higgs?*
- ▶ Express the production and decay of the Higgs in terms of deviation from SM coupling

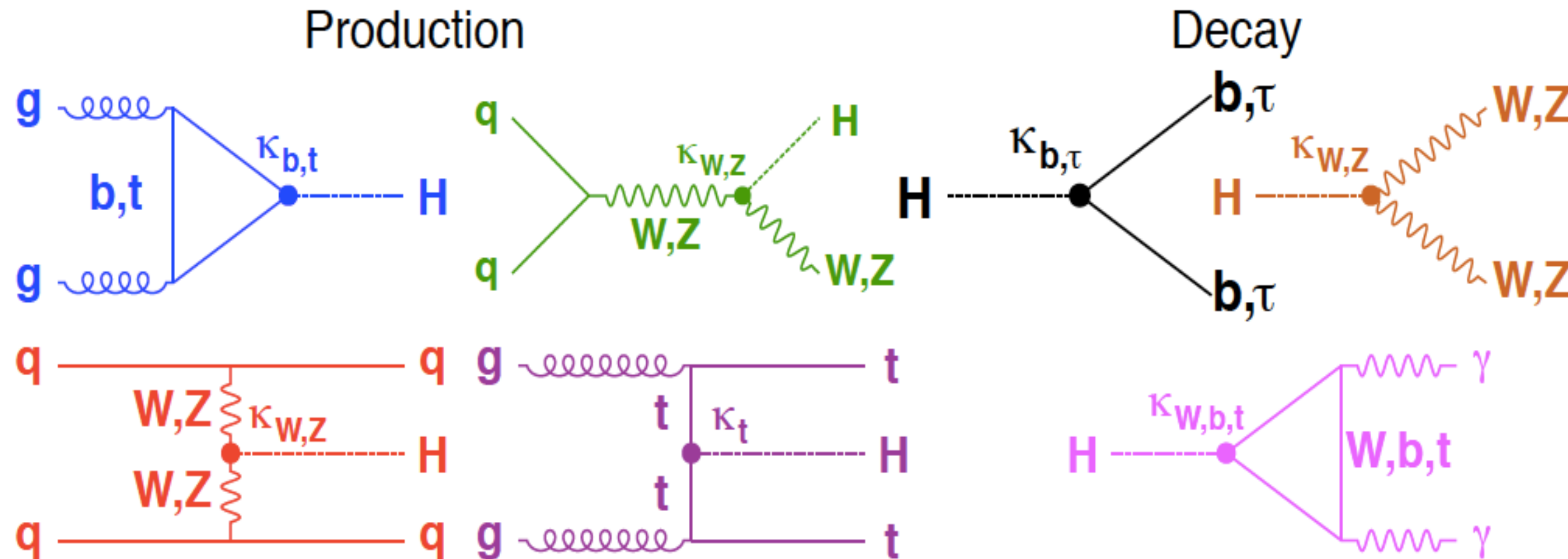

- ▶ Requires great performance across the board
  - Electrons, muons, taus, forward jets, b-tagging, trigger, MET....

- Scaling of signal and background yields as:
  - **Scenario 1** - systematic uncertainties remain the same: conservative
  - **Scenario 2** - theoretical uncertainties scaled by  $1/2$ : expt. systematic uncertainties scaled by  $1/\sqrt{L}$

CMS Projection (Prelim.)

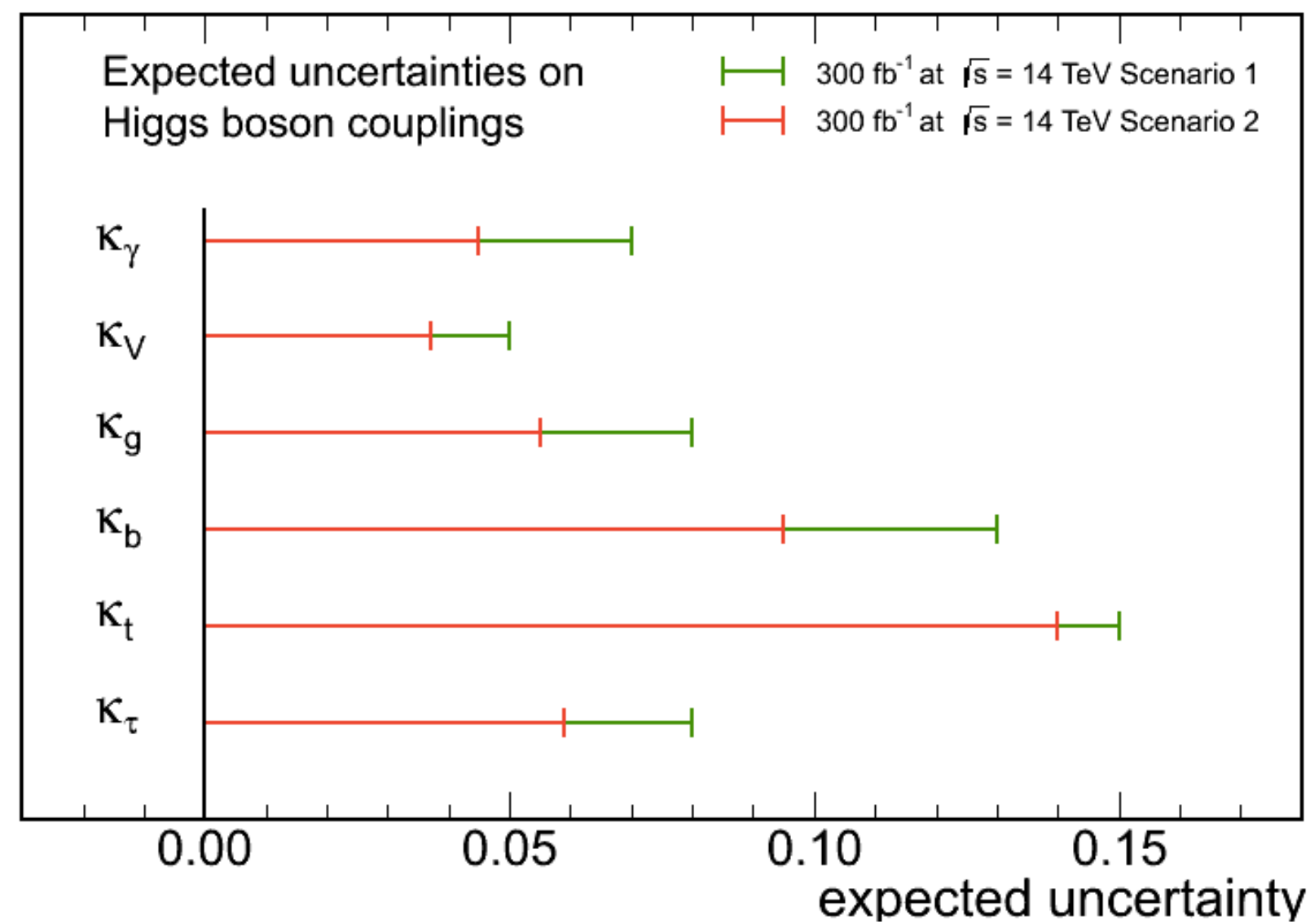

CMS Projection (Prelim.)

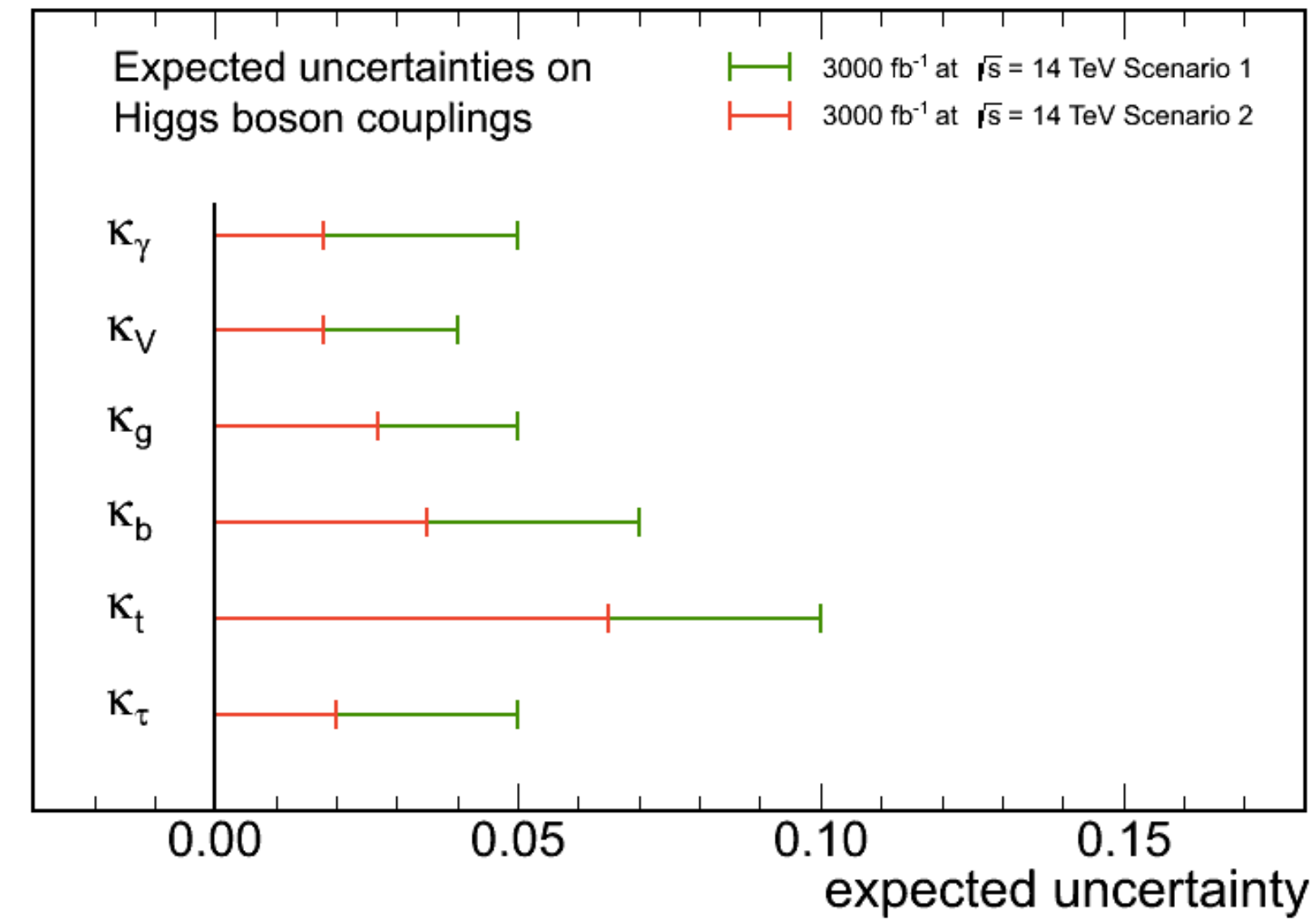

- Example beyond the Standard Model theories predict up to  $\sim 5\%$  deviation

- Without the Higgs  $VV$  scattering would violate unitarity
  - ▶ Complementary probe of EWSB to direct Higgs measurements
  - ▶ Example  $ZZ$  scattering to 4 leptons
    - Low cross section but cleanest channel
    - 30% with  $300 \text{ fb}^{-1}$
    - 10% with  $3000 \text{ fb}^{-1}$
  - ▶ Requires excellent detector performance
    - VBF signature (forward jets), pile up control
    - Boosted decay of  $V$  to leptons or jets (substructure)
    - ...

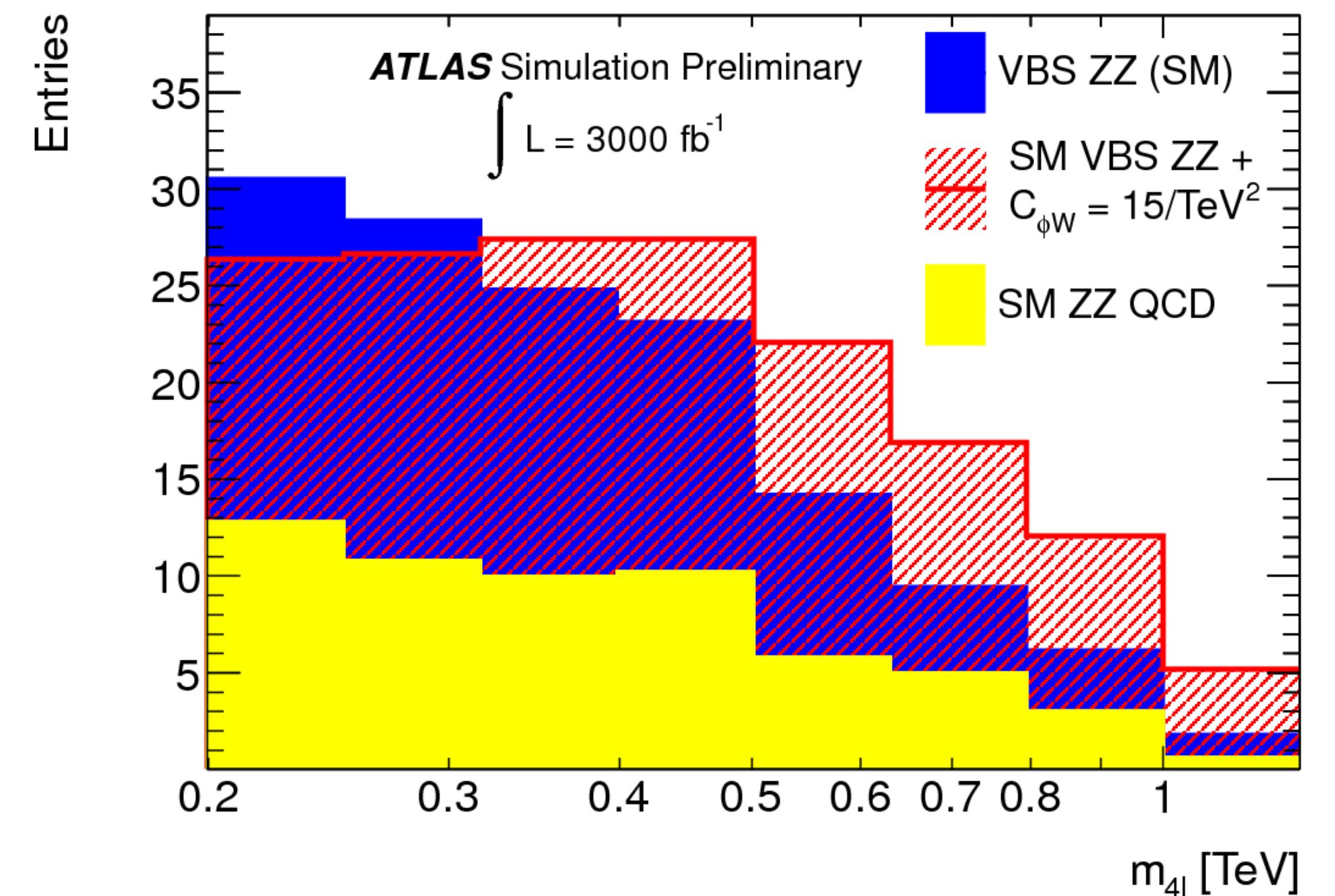

## Dark Matter

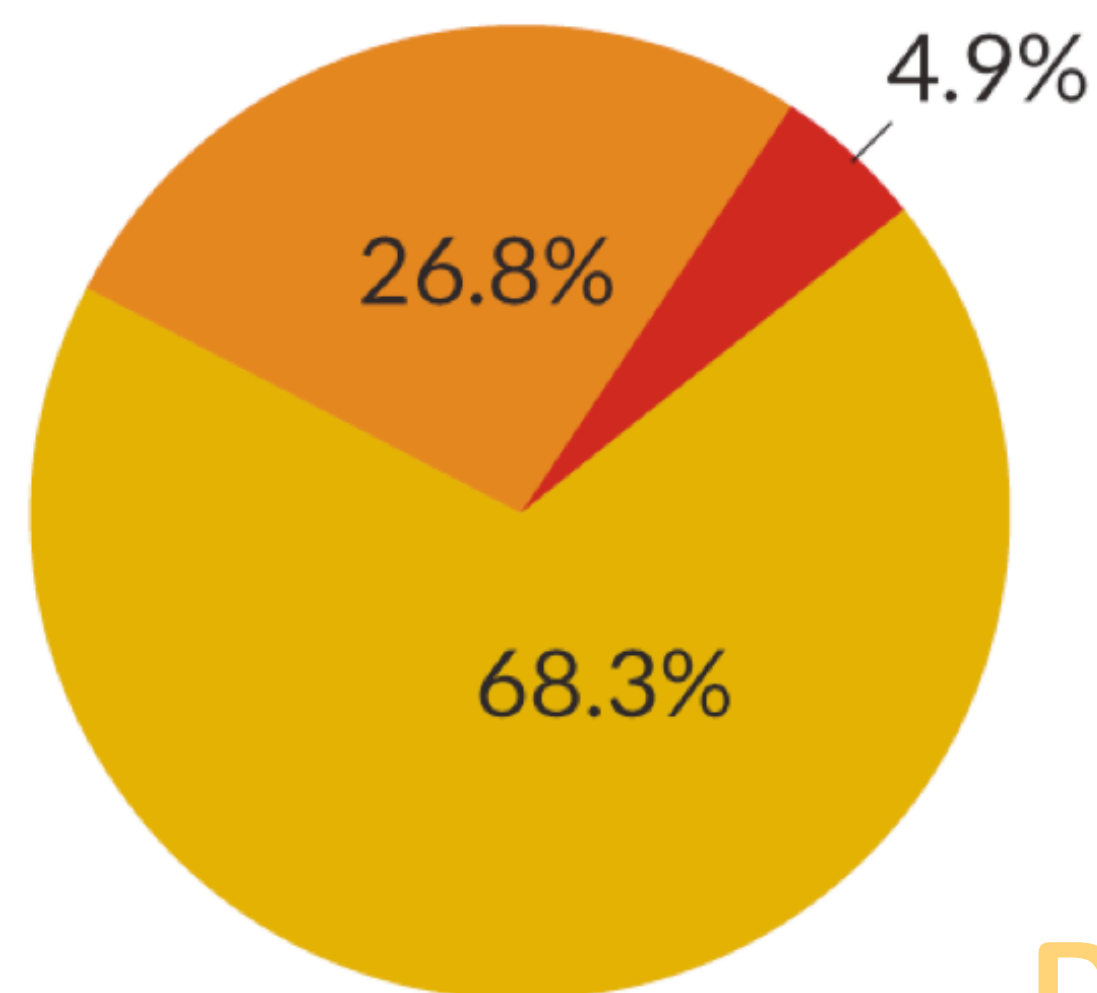

## SM matter

## Dark Energy

More than 95% of the matter-energy in the Universe is of unknown origin!

- What can the LHC contribute?
  - ▶ Complementary to direct detection experiments and observations

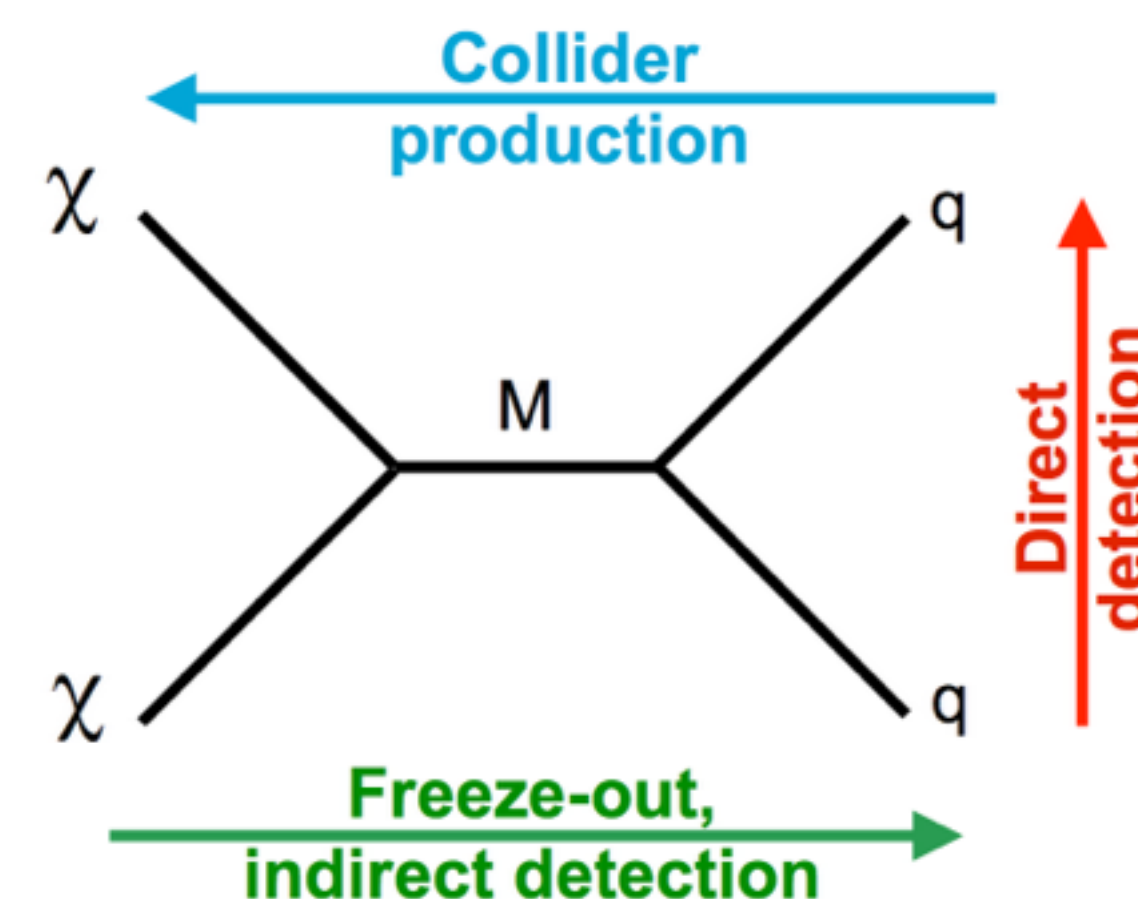



- How do you observe something invisible?

- ▶ Monojet (and other) events

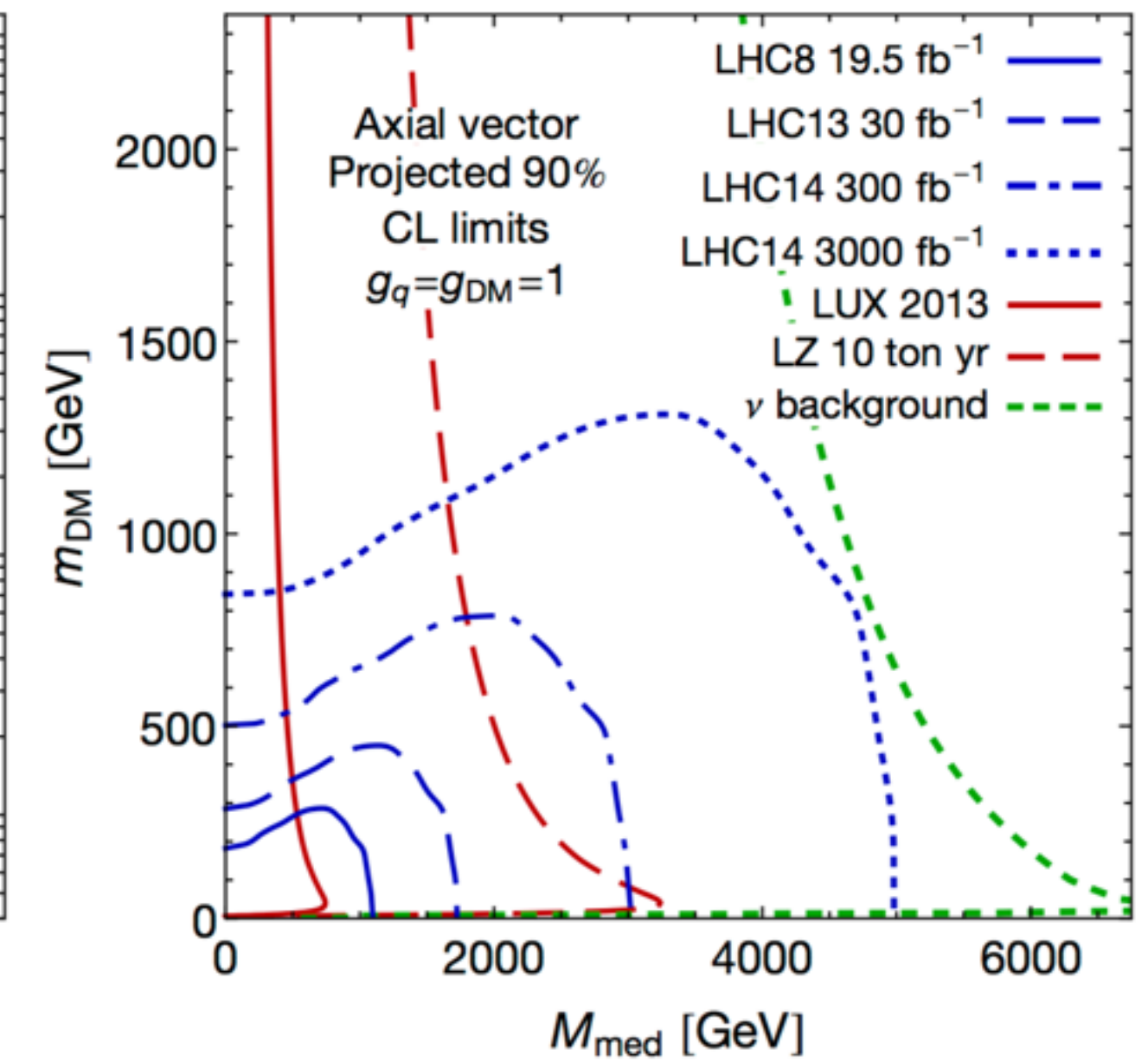
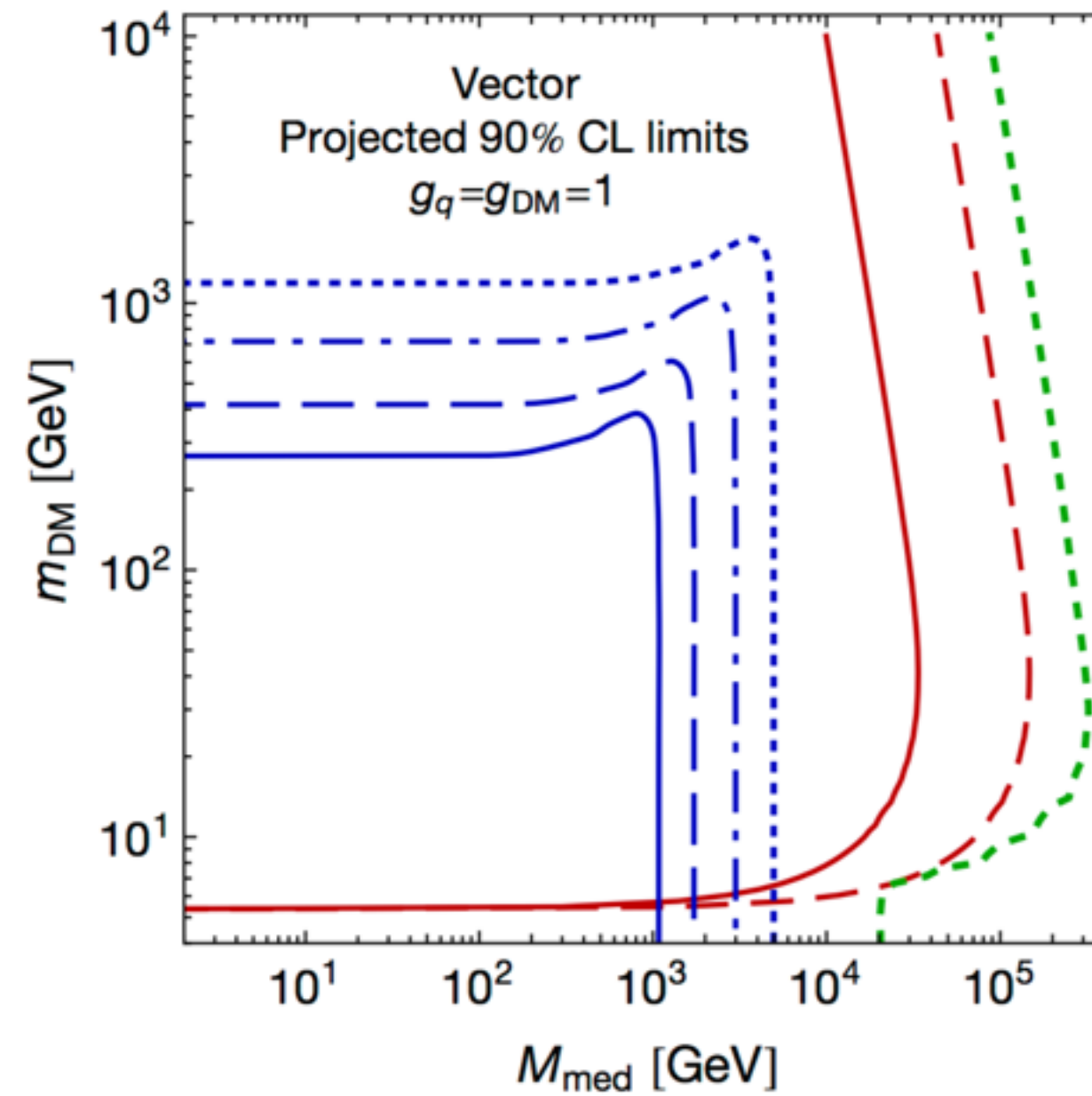
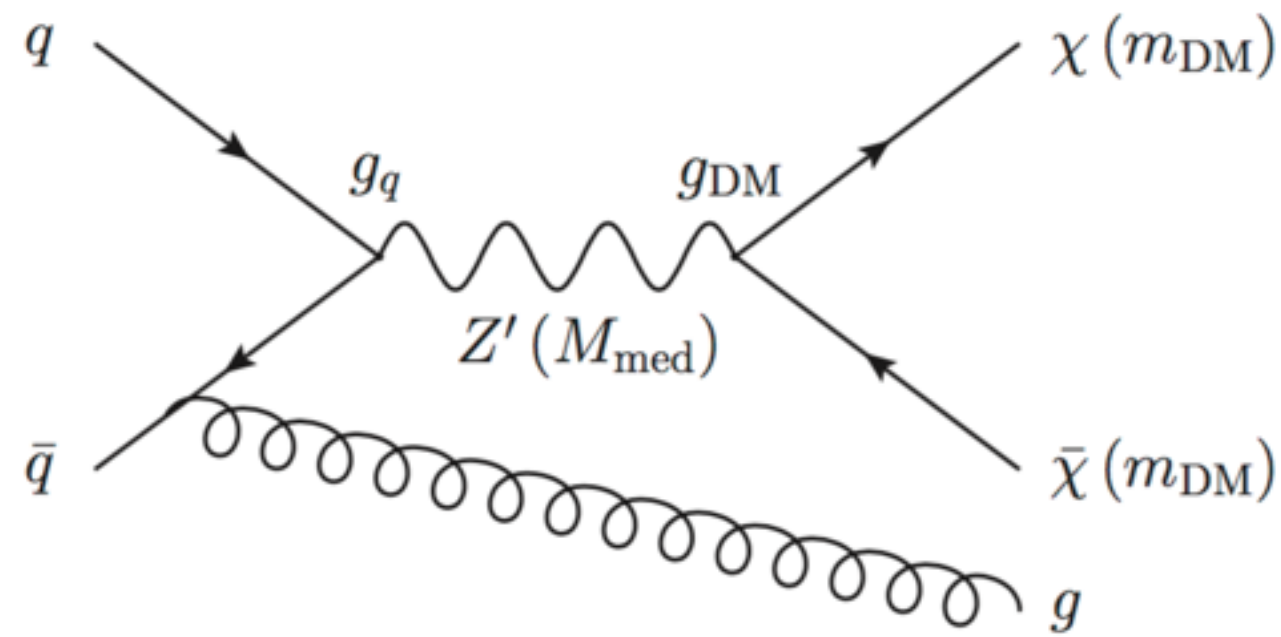

- ▶ Large gains with 300 fb<sup>-1</sup> to 3000 fb<sup>-1</sup>
- ▶ Requires excellent performance for jets and missing energy

Buchmüller et al.  
arXiv:1407.8257

- Why we love supersymmetry...

- ▶ Hierarchy problem

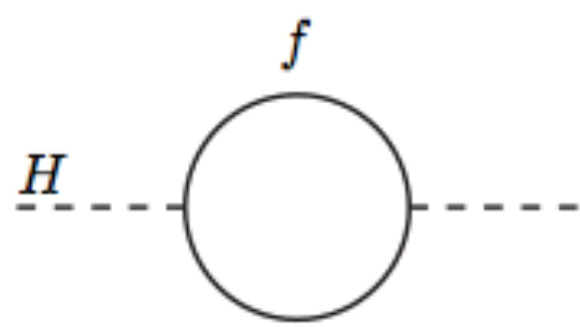

$$\Delta m_H^2 = \frac{\lambda_f^2}{8\pi^2} \left[ -\Lambda^2 + 6m_f^2 \ln \frac{\Lambda}{m_f} \right]$$

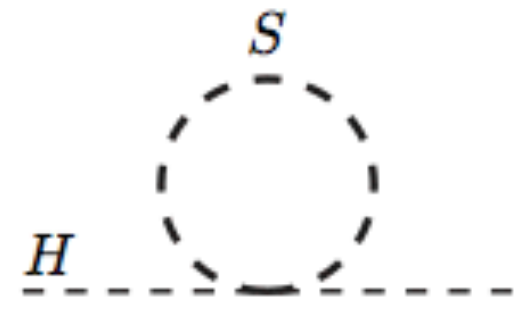

$$\Delta m_H^2 = \frac{\lambda_S}{16\pi^2} \left[ \Lambda^2 - 2m_S^2 \ln \frac{\Lambda}{m_S} \right]$$

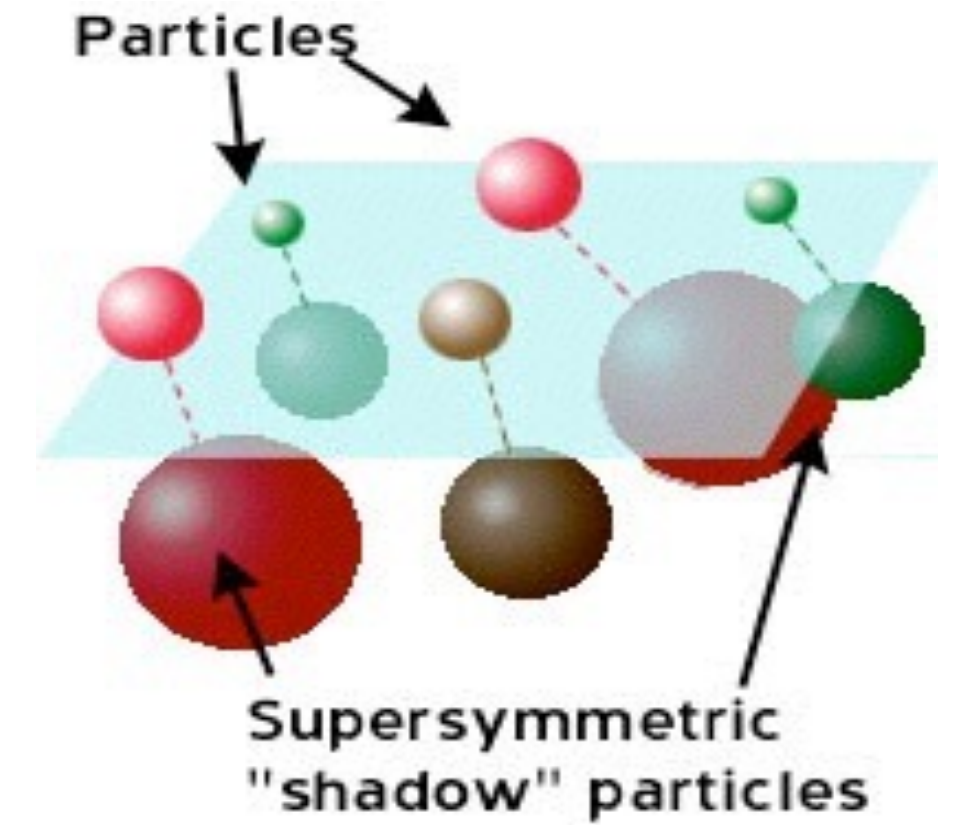

- ▶ Dark Matter candidate

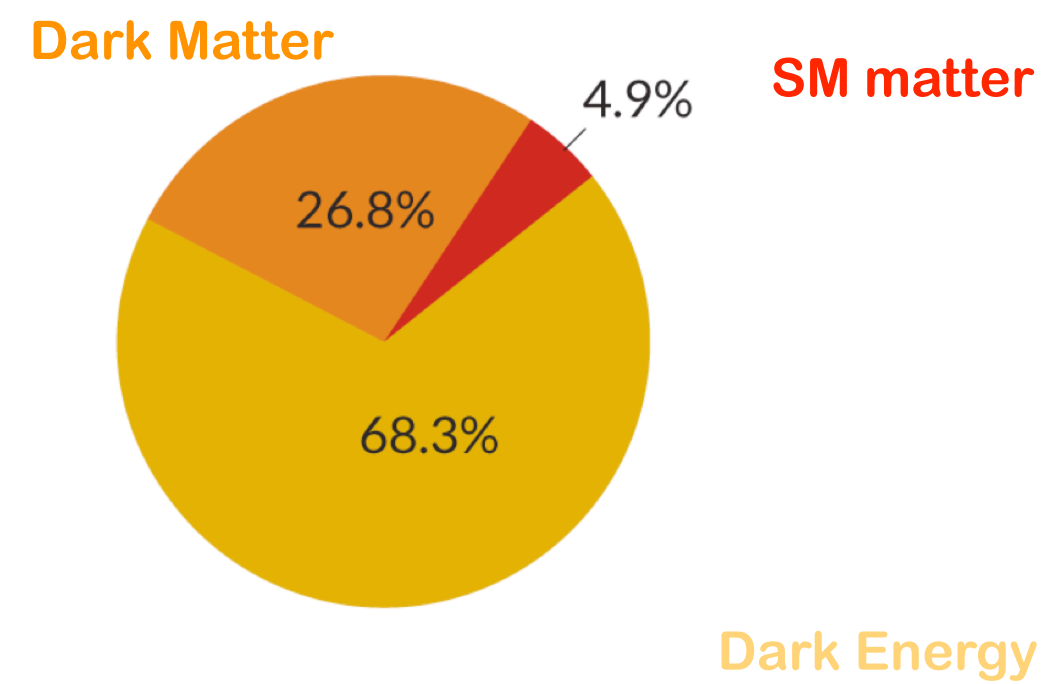

- ▶ Unification

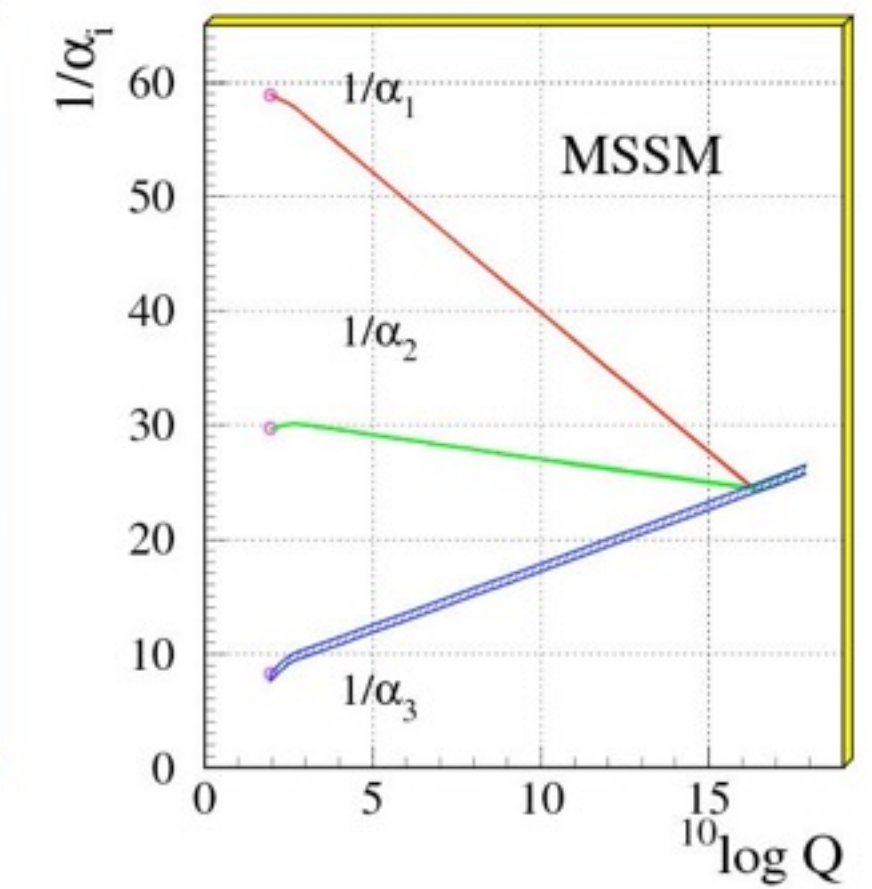
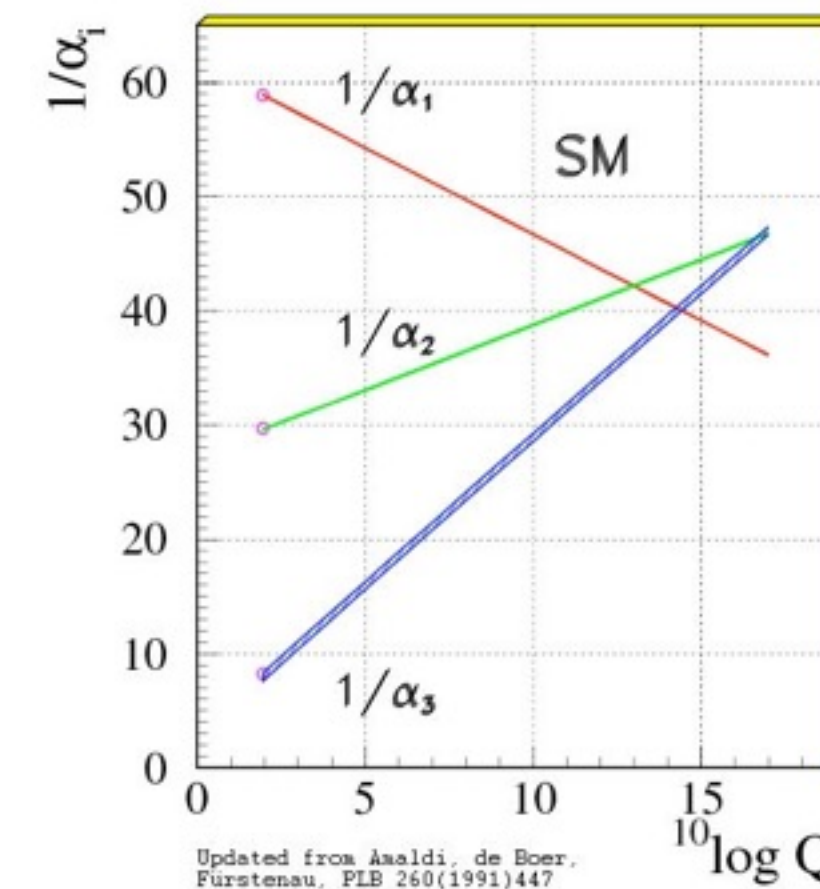

- Natural SUSY

- ▶  $M_{\text{stop}} < \sim 1 \text{ TeV}$
- ▶ Constraints on sbottom and gluino
- ▶ Maybe still alive with  $300 \text{ fb}^{-1}$ ?

- Electroweak production of SUSY

- ▶ Lower cross sections than strong production  $\rightarrow$  needs higher luminosity
- ▶ Also shows effect of detector degradation
- ▶ WH channel: lepton, MET and 2 b-tags

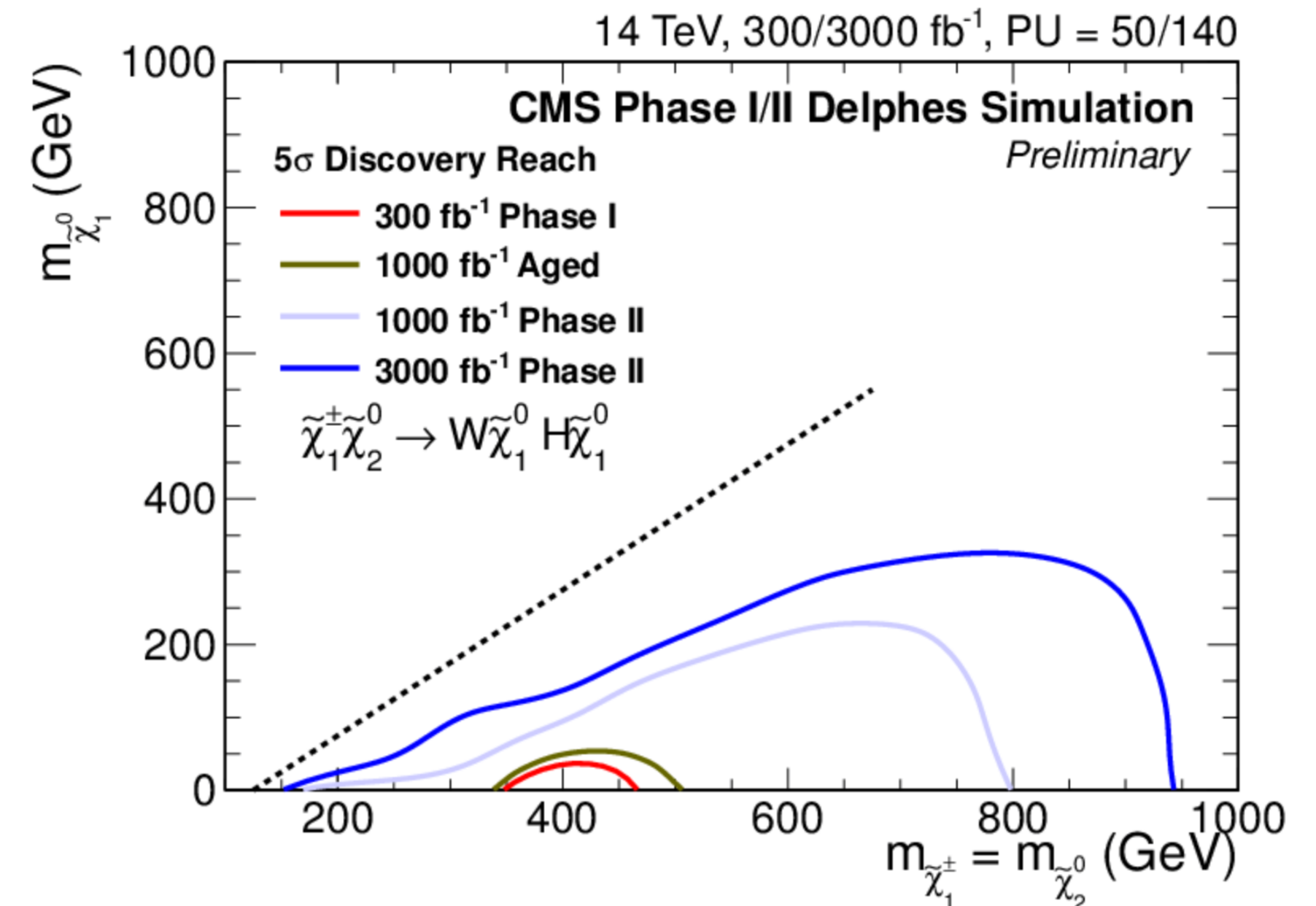
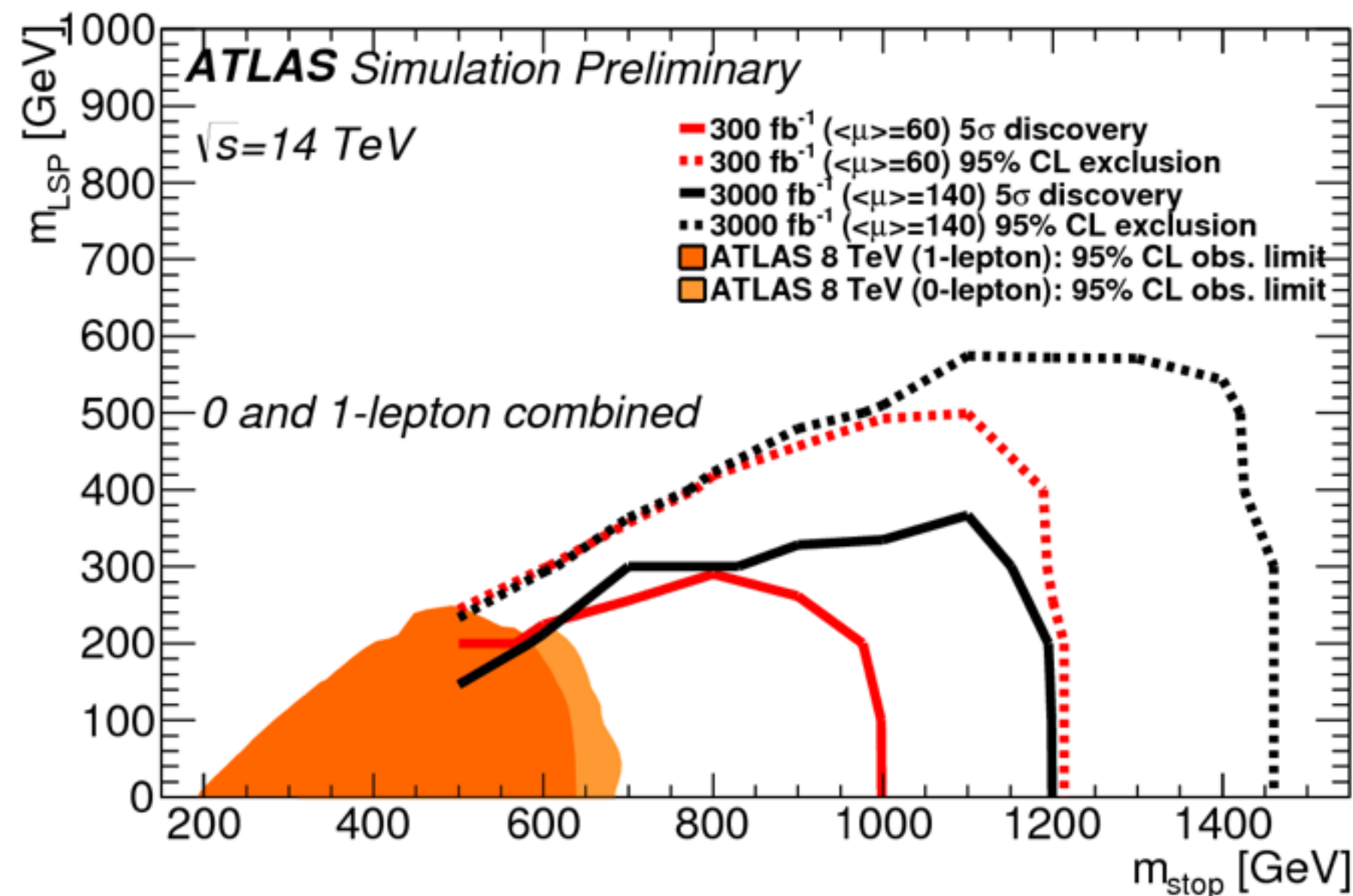

- Broad physics programme
  - ▶ Precision SM (including Higgs) measurements
  - ▶ Searches for new physics
- Complementary to other (potential) colliders
- Highlighted key areas for detector performance
- **Bottom line:** will need to maintain current high level of detector performance

# LHC: Introduction

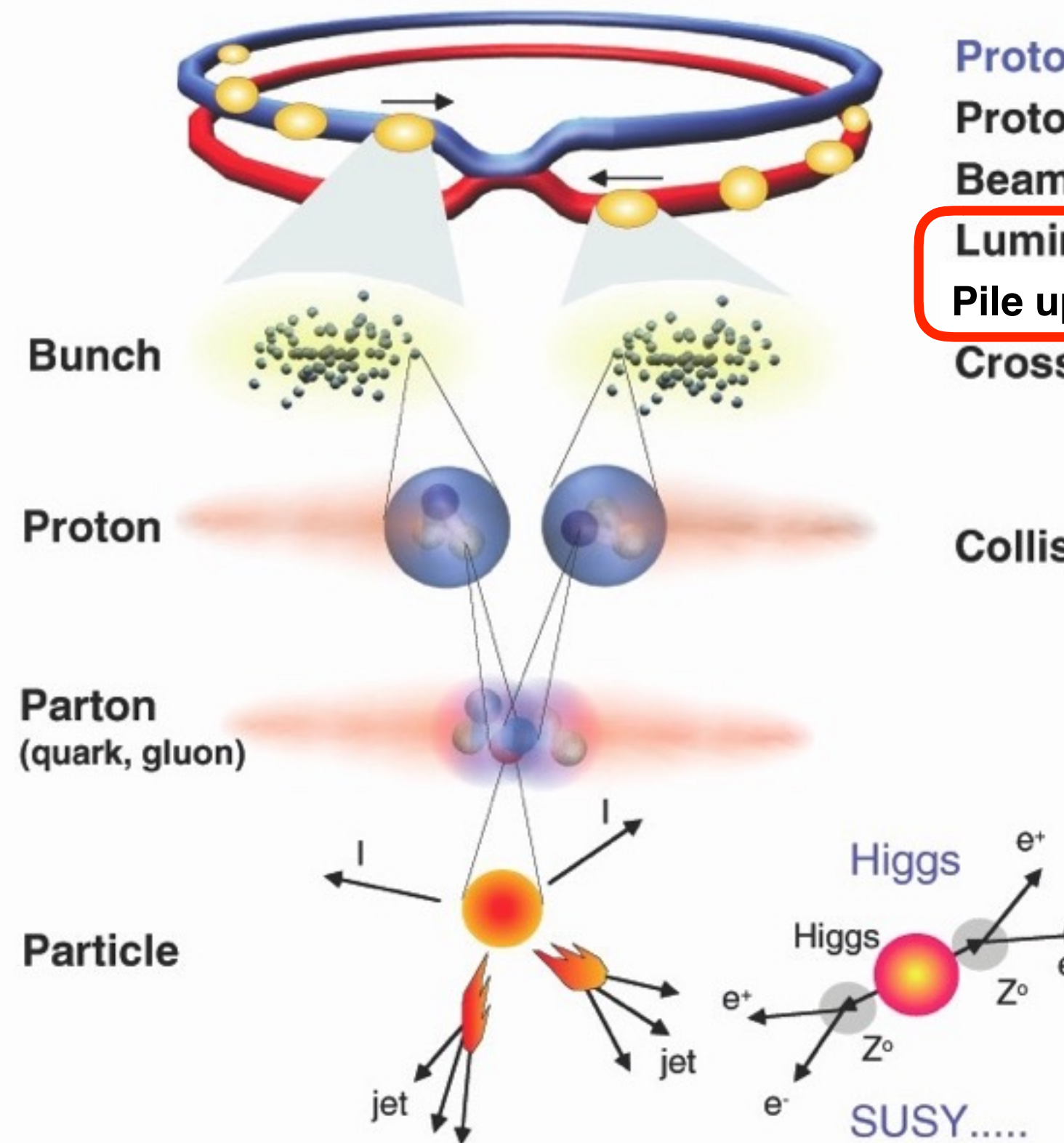
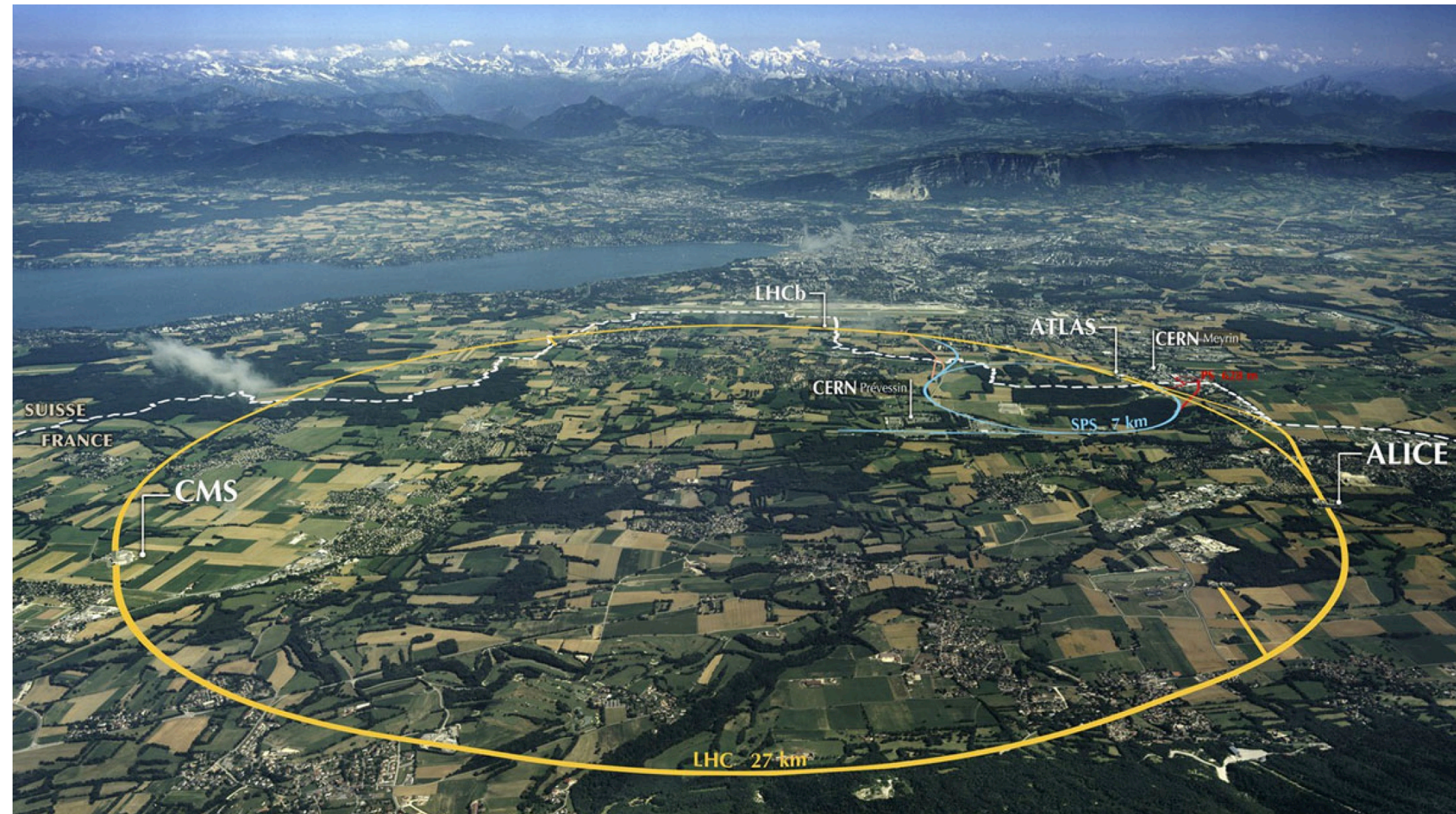

<b>Proton-Proton</b>	2835 bunch/beam
<b>Protons/bunch</b>	$10^{11}$
<b>Beam energy</b>	7 TeV ( $7 \times 10^{12}$ eV)
<b>Luminosity</b>	$10^{34} \text{ cm}^{-2} \text{ s}^{-1}$
<b>Pile up <math>\approx</math></b>	20 events
<b>Crossing rate</b>	40 MHz

**Collisions  $\approx$**   $10^7 - 10^9 \text{ Hz}$

# LHC: Running conditions

- Close to design luminosity reached already

- ▶  $7 \times 10^{33} \text{ cm}^{-2} \text{ s}^{-1}$  vs  $1 \times 10^{34} \text{ cm}^{-2} \text{ s}^{-1}$
- ▶ With 50 ns bunch spacing vs nominal 25 ns
- ▶ Higher than design pile up already
- ▶ Integrated luminosities up to  $0.3 \text{ fb}^{-1} / \text{day}$

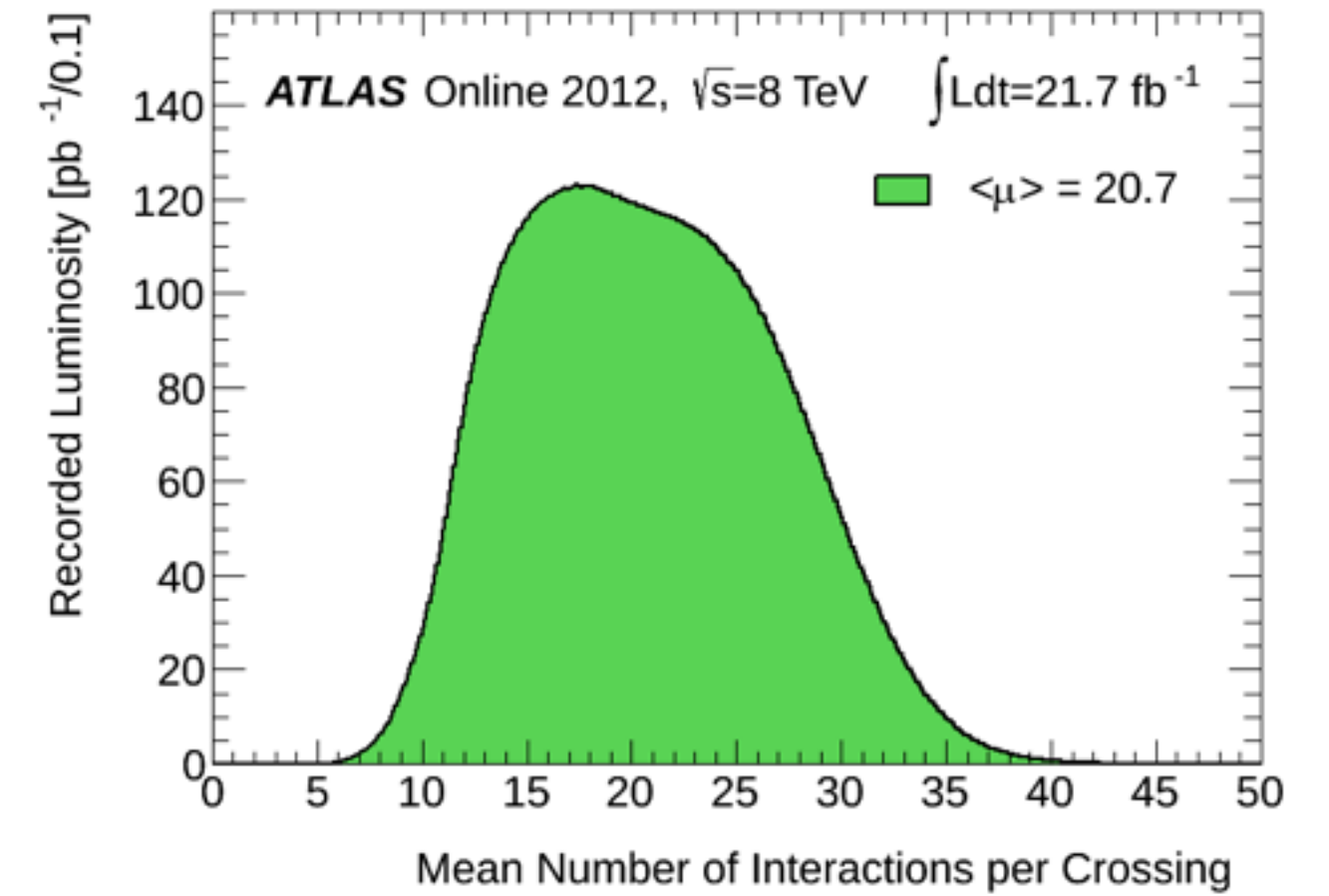

- So why upgrade?

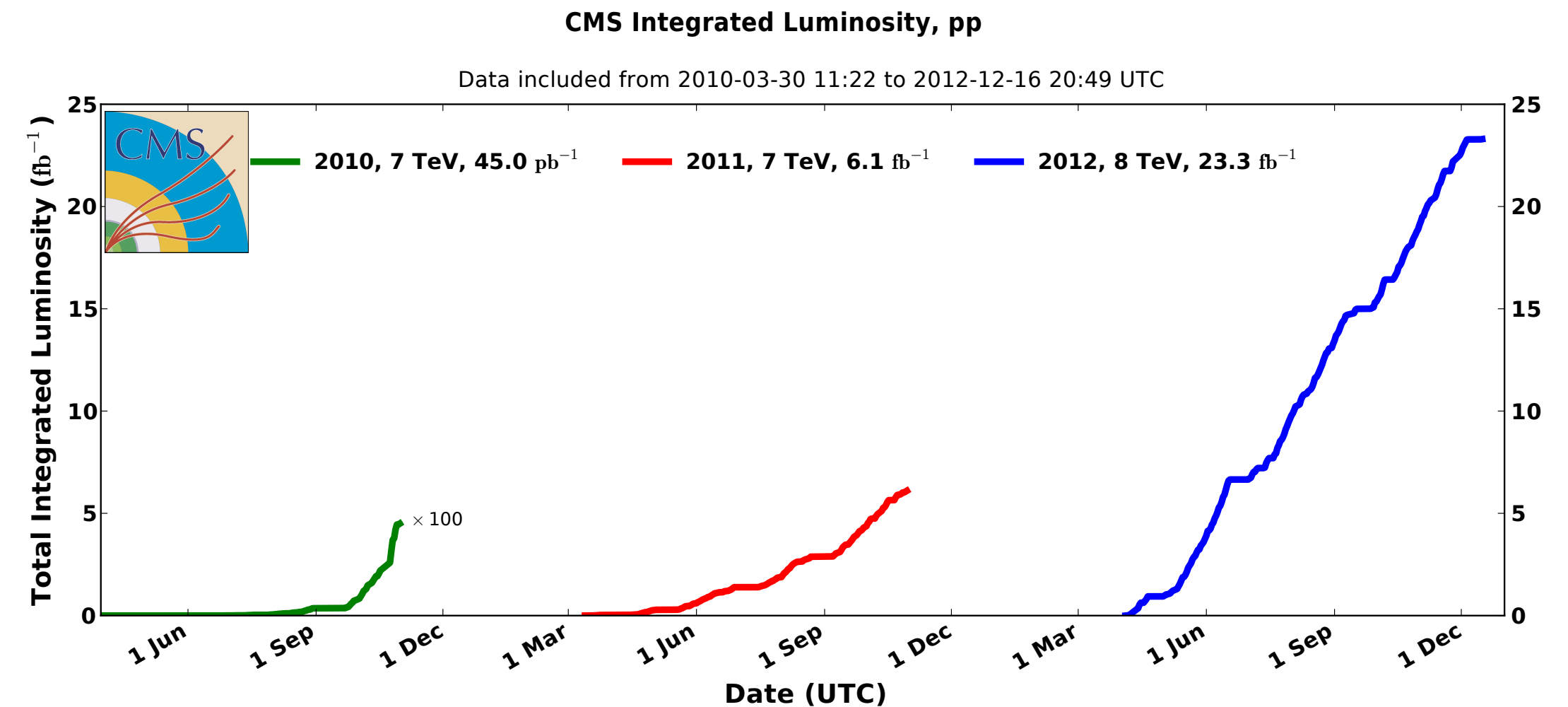
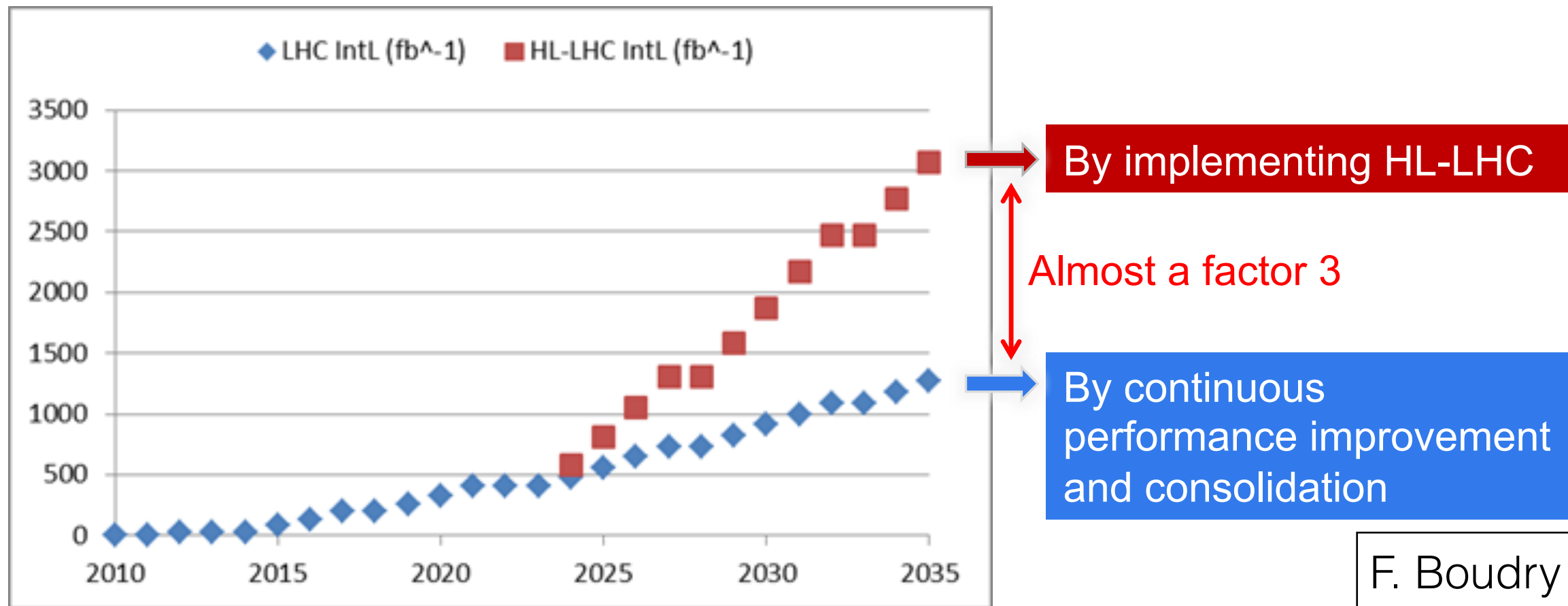

# LHC: Future plans

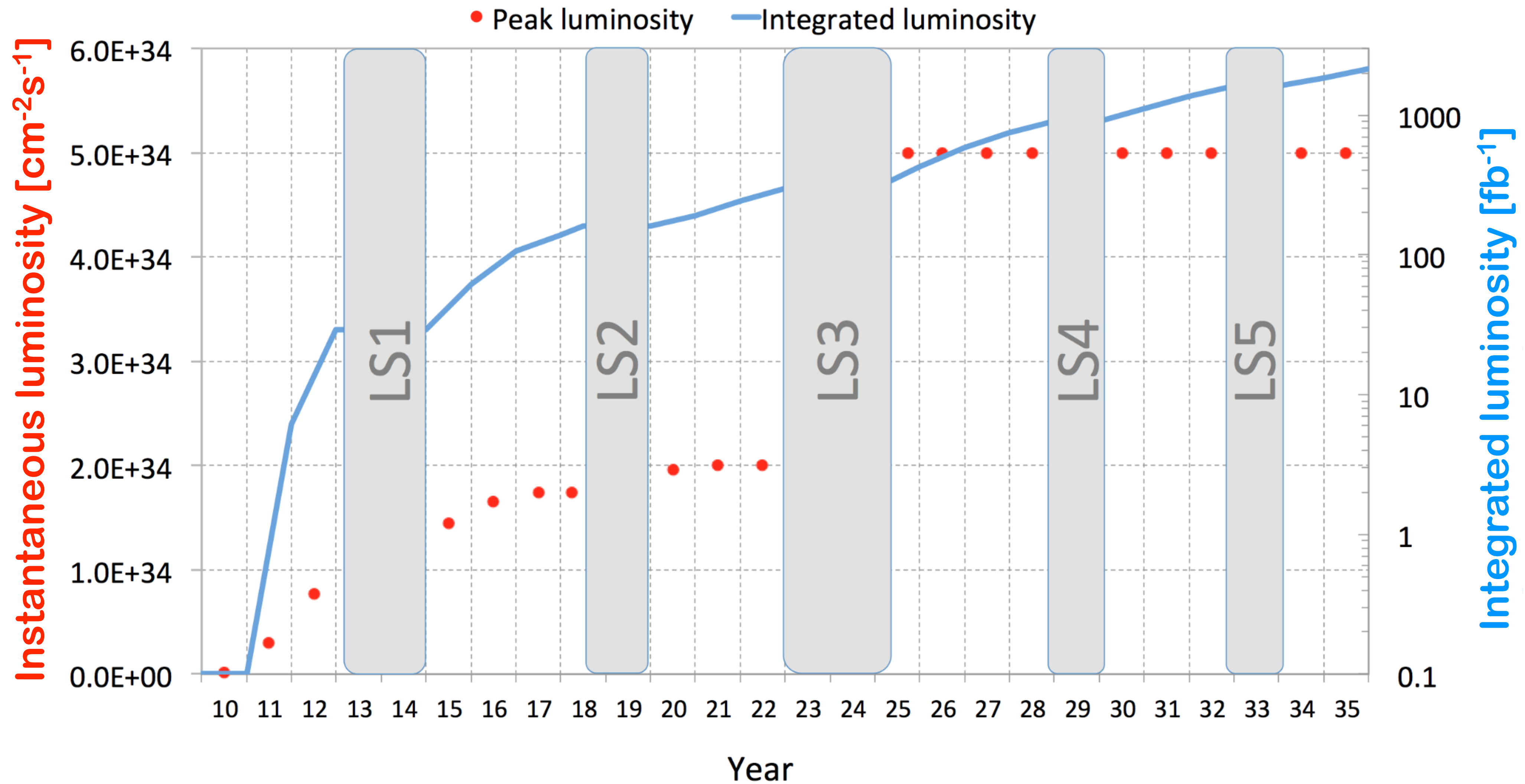

# LHC: Future plans

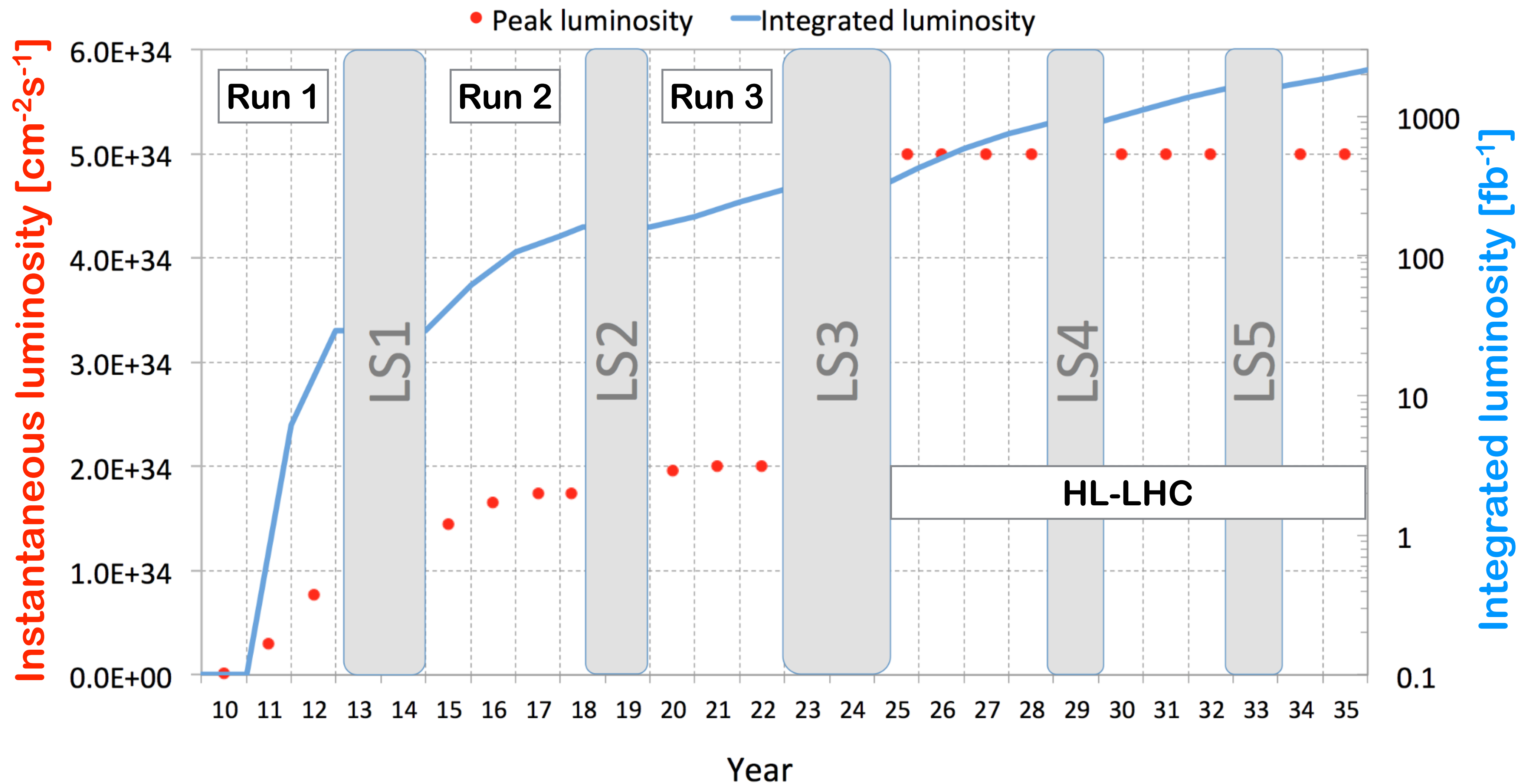



# LHC: Future plans

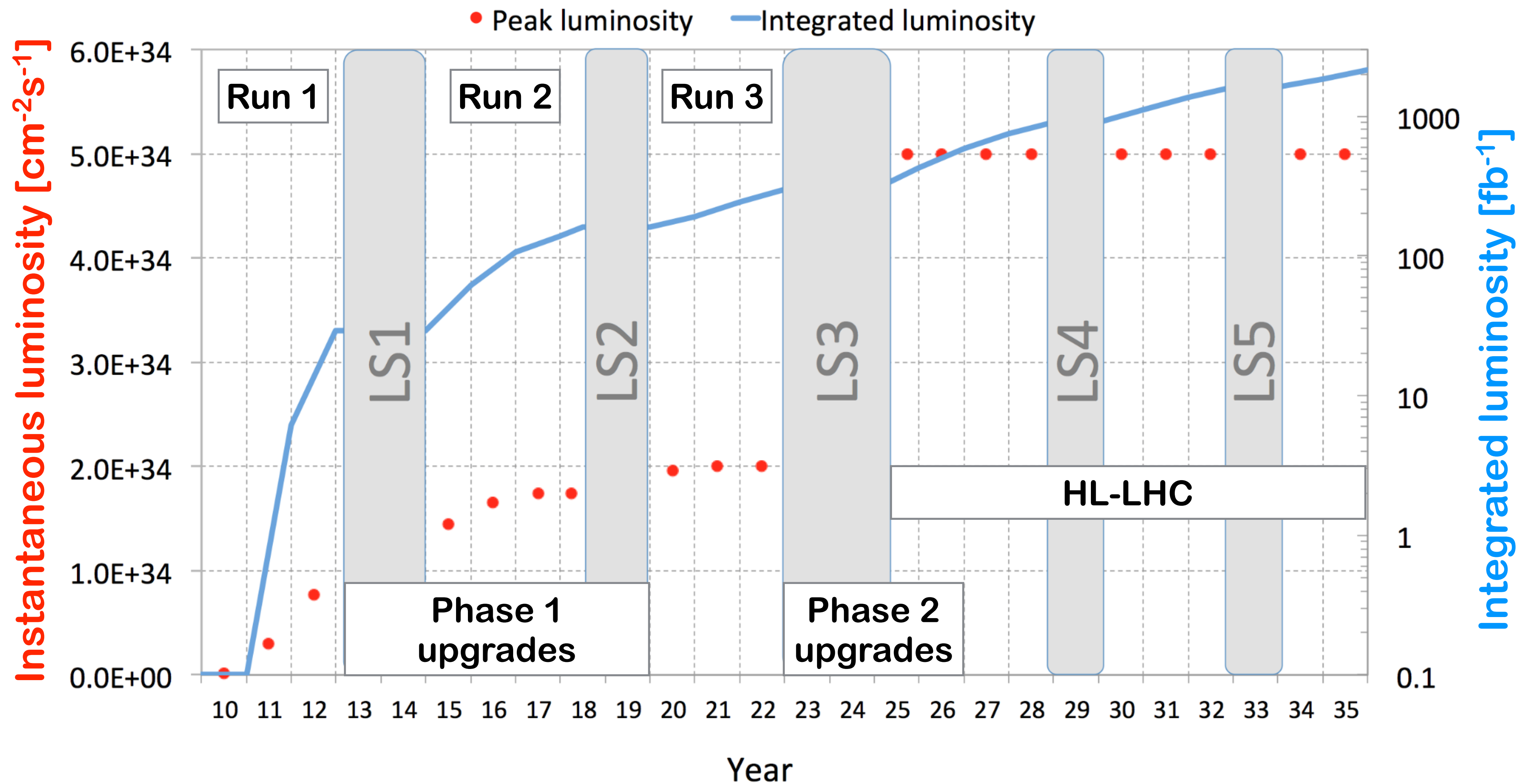

# LHC: Future plans

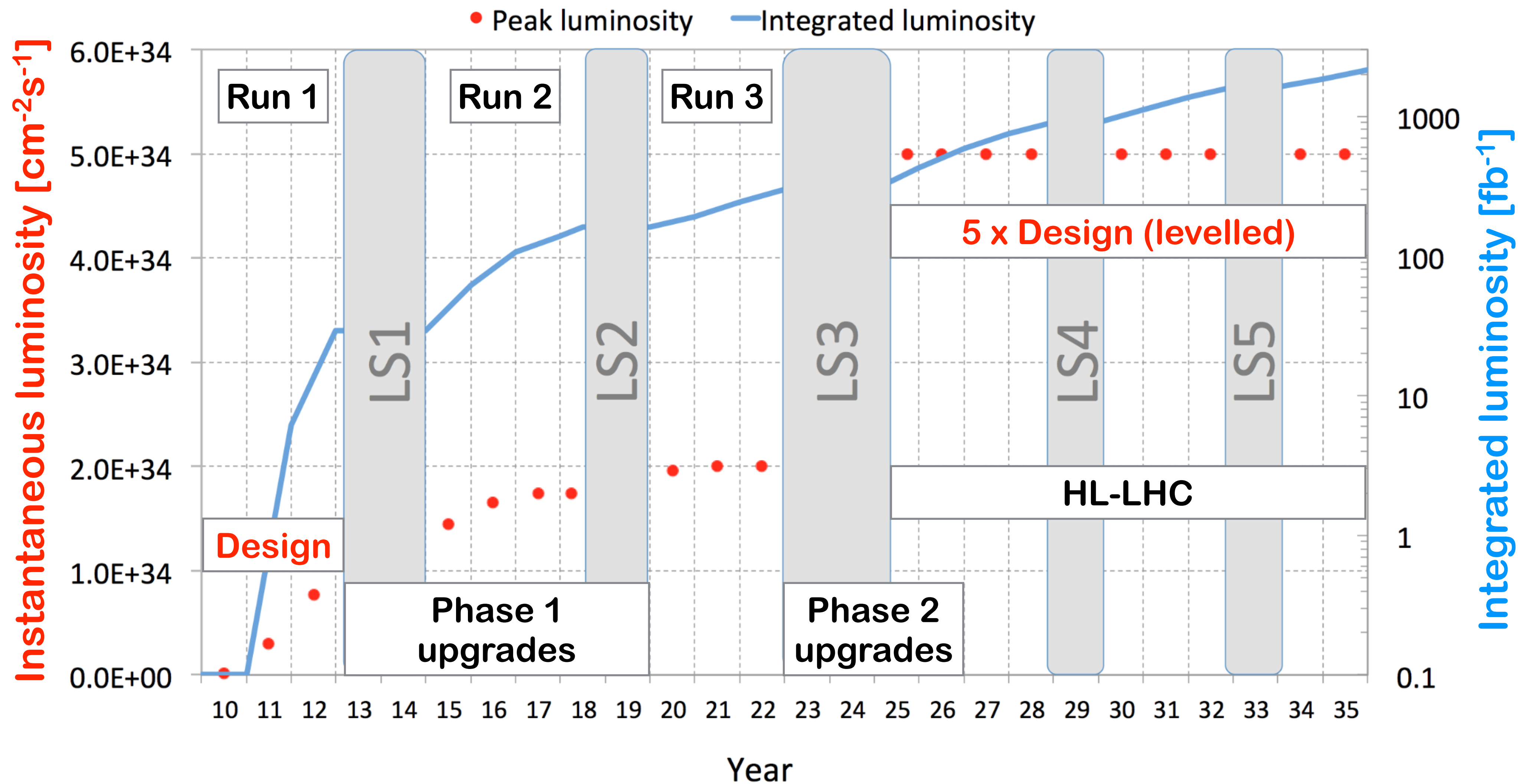

# LHC: Future plans

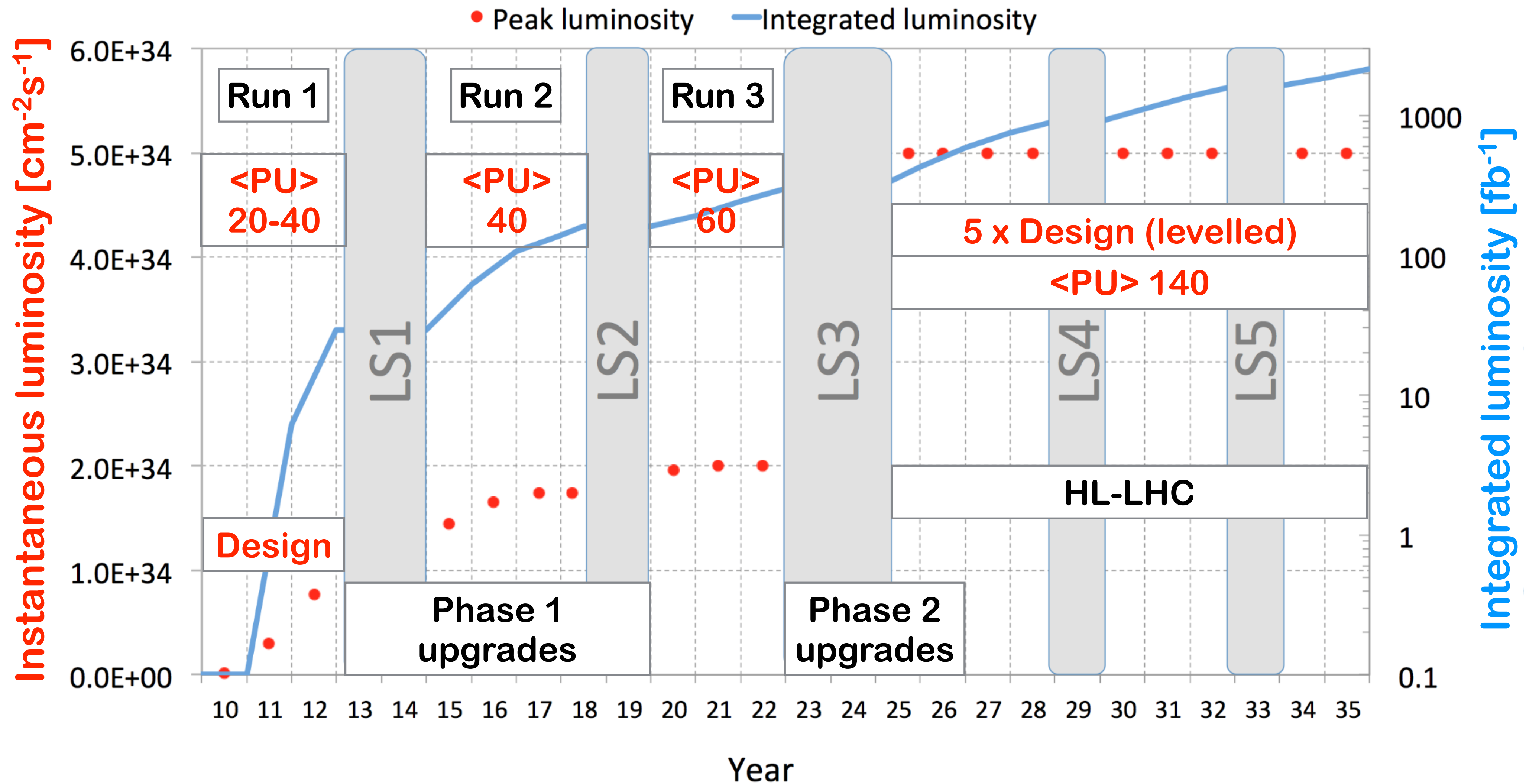

# LHC: Future plans

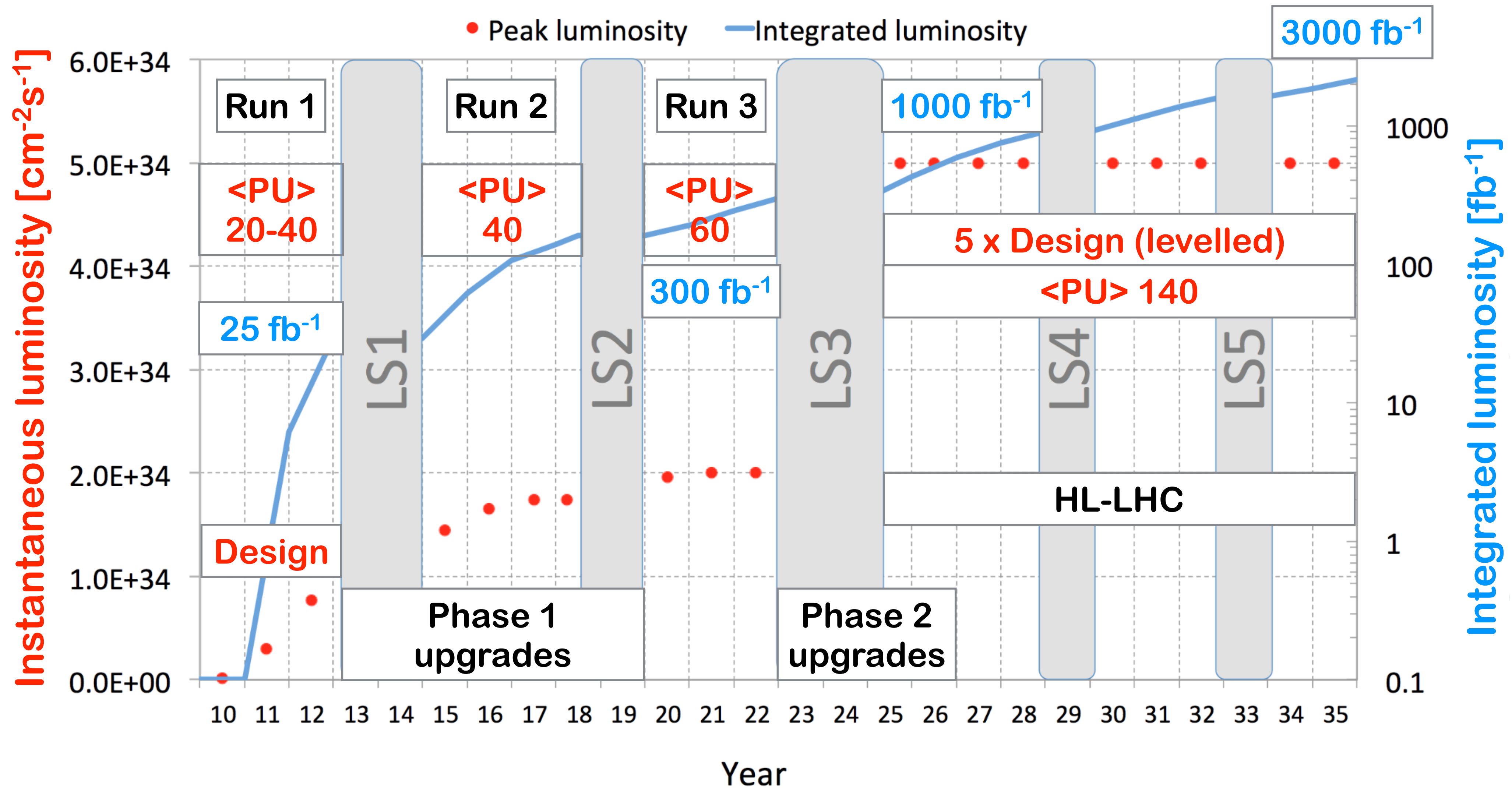

- Pile up

- ▶ Detector performance degraded (e.g. pattern recognition)
- ▶ Offline reconstruction complexity

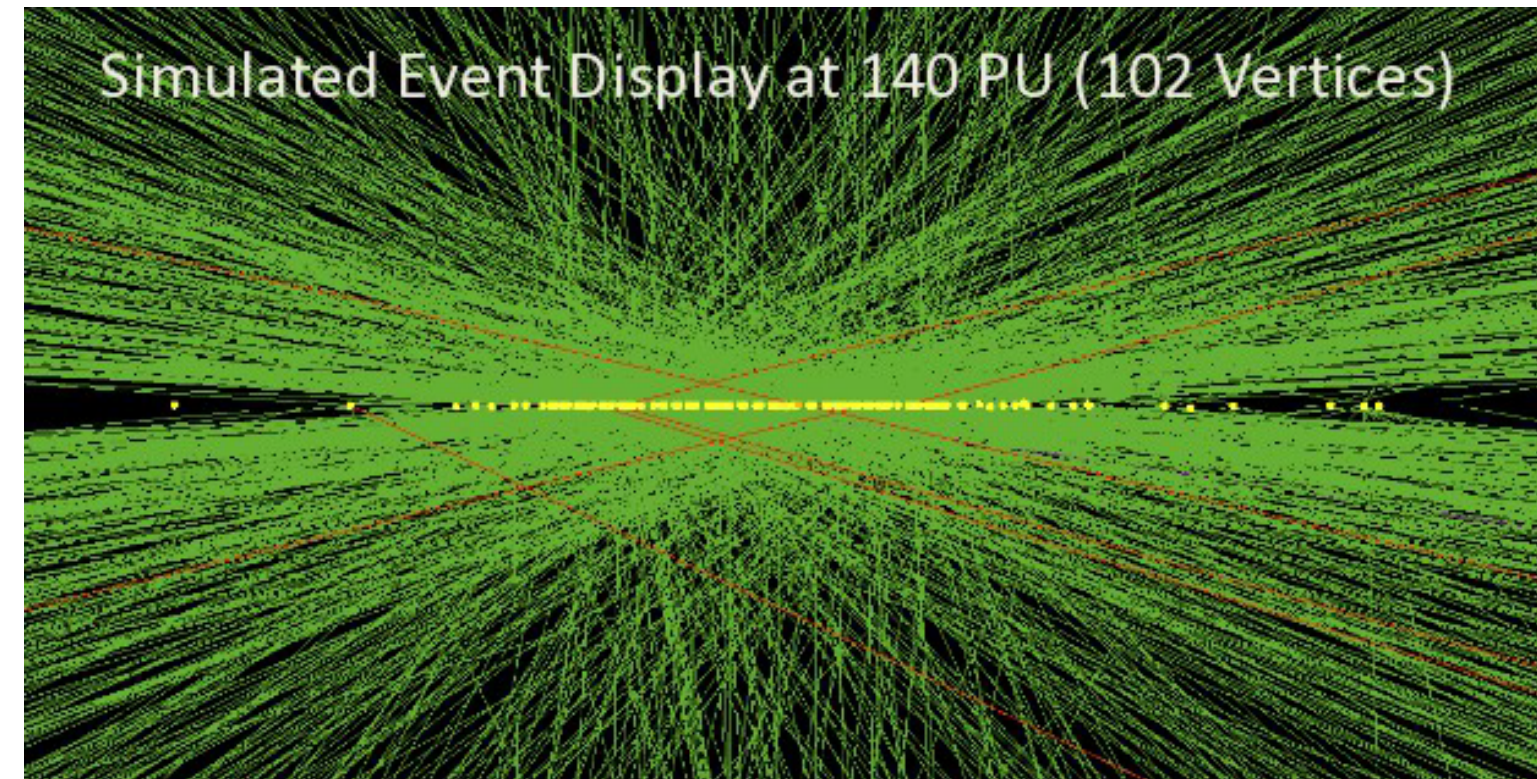

- Radiation

- ▶ High fluencies and high doses for trackers and endcap calorimeters
- ▶ Degraded performance

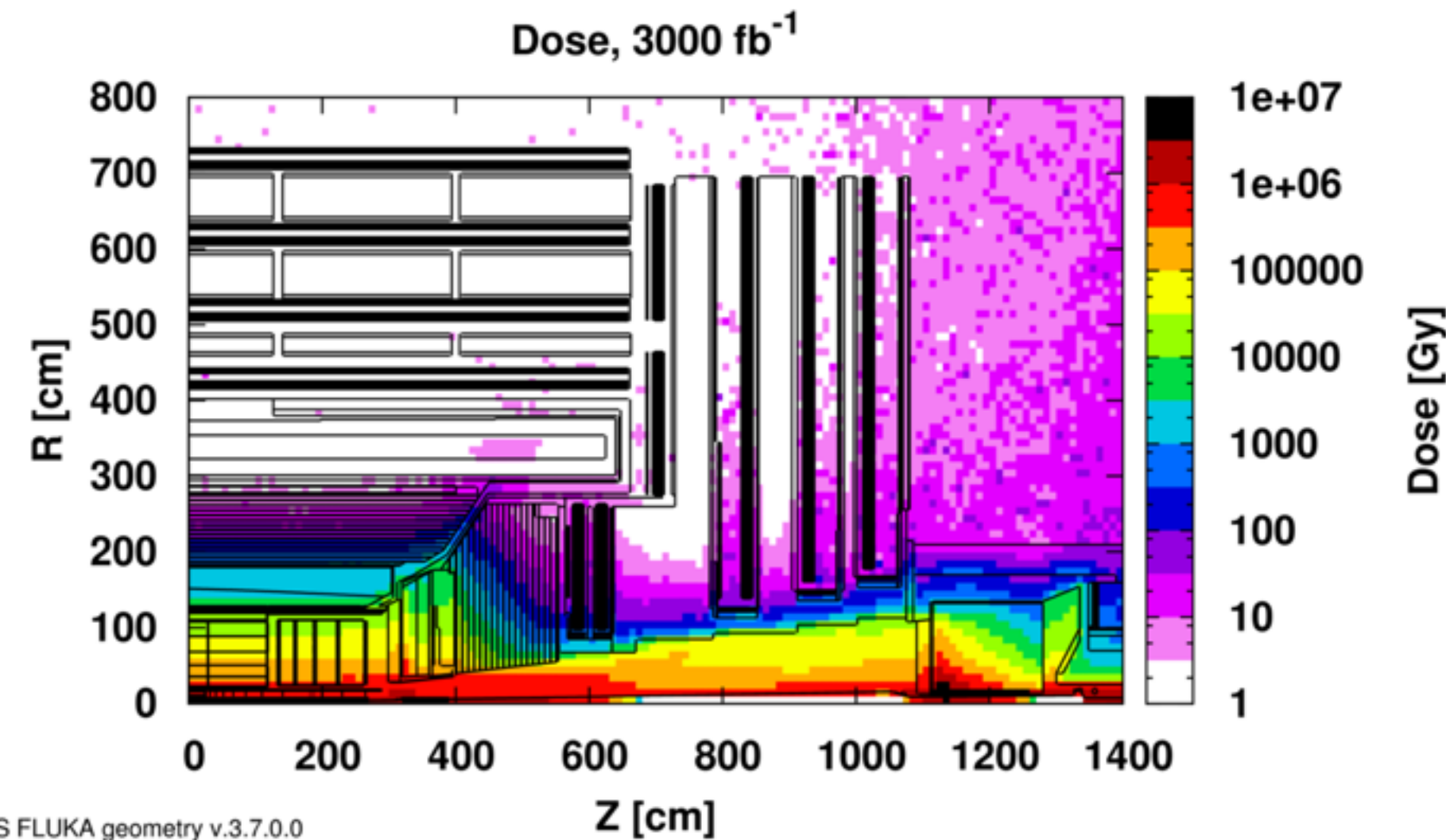

- Rates

- ▶ Trigger rates increase with instantaneous luminosity and performance degrades with pile up (e.g. isolation)

Run	$W \rightarrow l\nu$ rate
Run1	80 Hz
Run 2	200 Hz
Run 3	400-600
HL-LHC	1KHz

- Fast Track Trigger

- ▶ Hardware (Associative Memory) based track finder (pattern matching)
- ▶ FPGA-based track fitting

- Trigger and DAQ

- ▶ Level-1 Calorimeter Trigger (UK)
- ▶ New electronics
- ▶ Finer granularity

- Forward muon detectors

- ▶ Muon “small wheels” improve tracking and trigger in forward regions

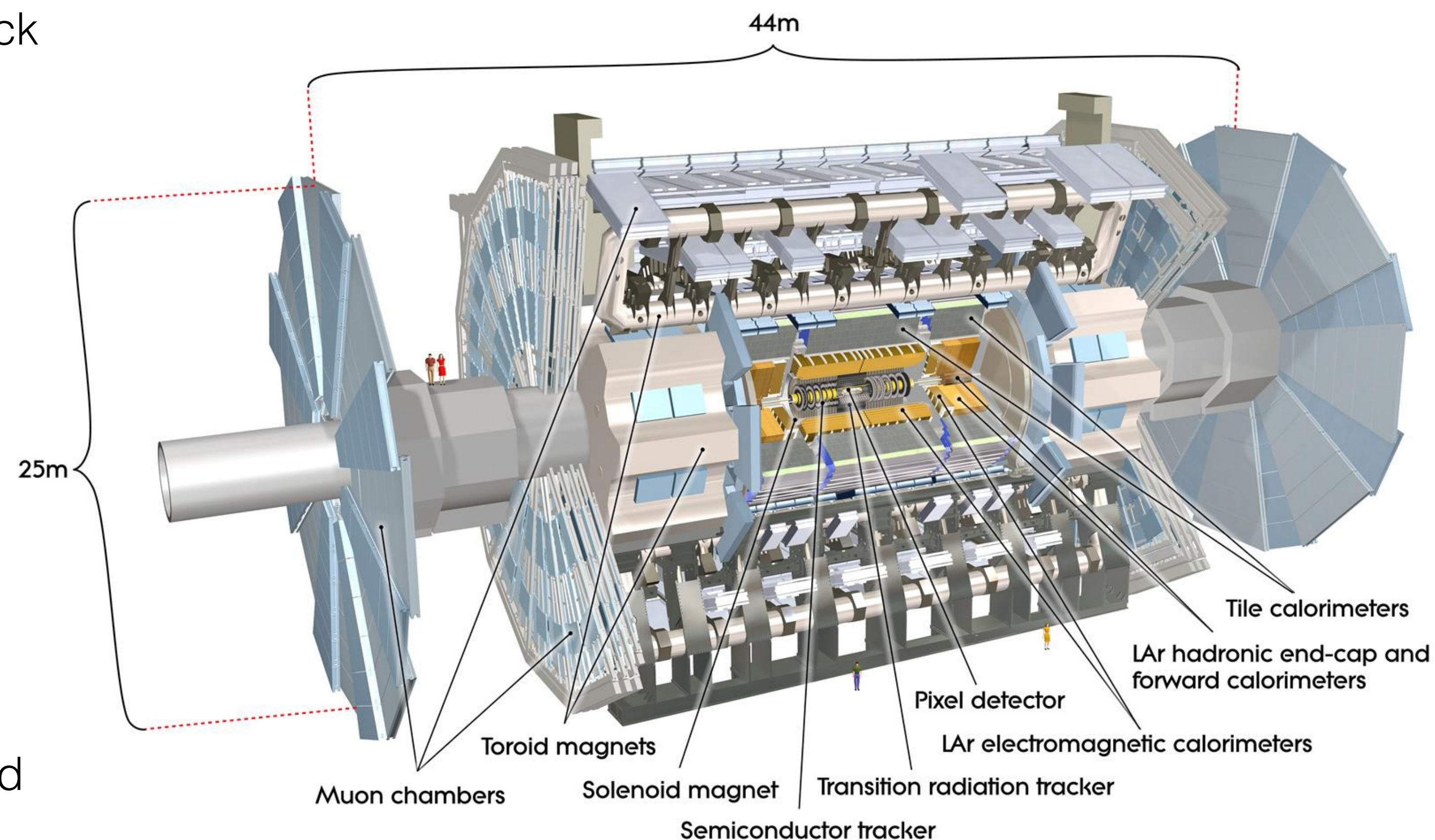

- Level-1 Calorimeter Trigger

- ▶ Upgrade calorimeter electronics will provide finer granularity data to Level-1 trigger in  $\eta$  and depth information
- ▶ Preserve thresholds for single electron trigger at  $p_T \sim 25$  GeV for LHC luminosity increasing to  $\sim 2-3x$  nominal
- ▶ **UK** developing electron feature extractor and associated readout (ATCA and high speed optical links)

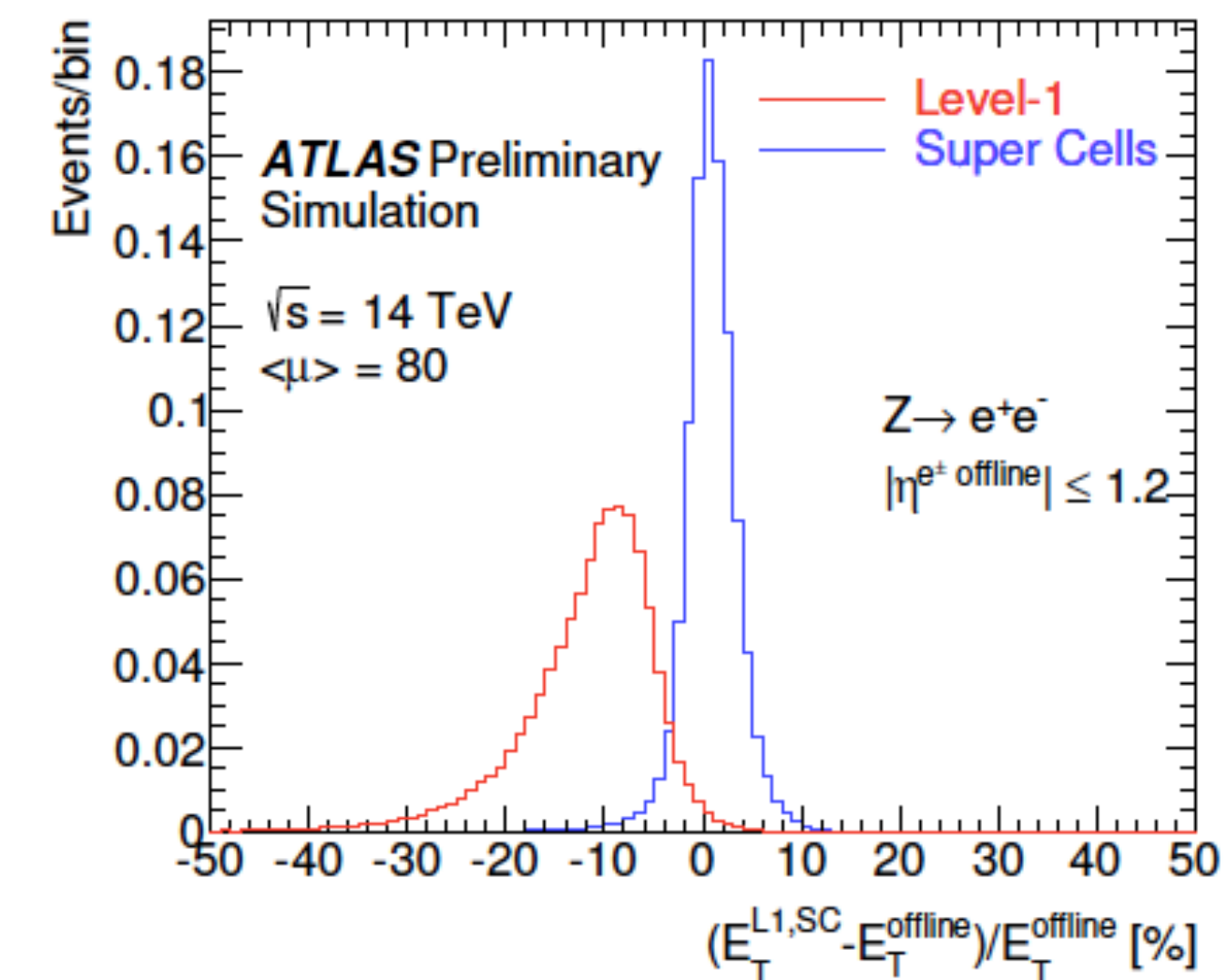
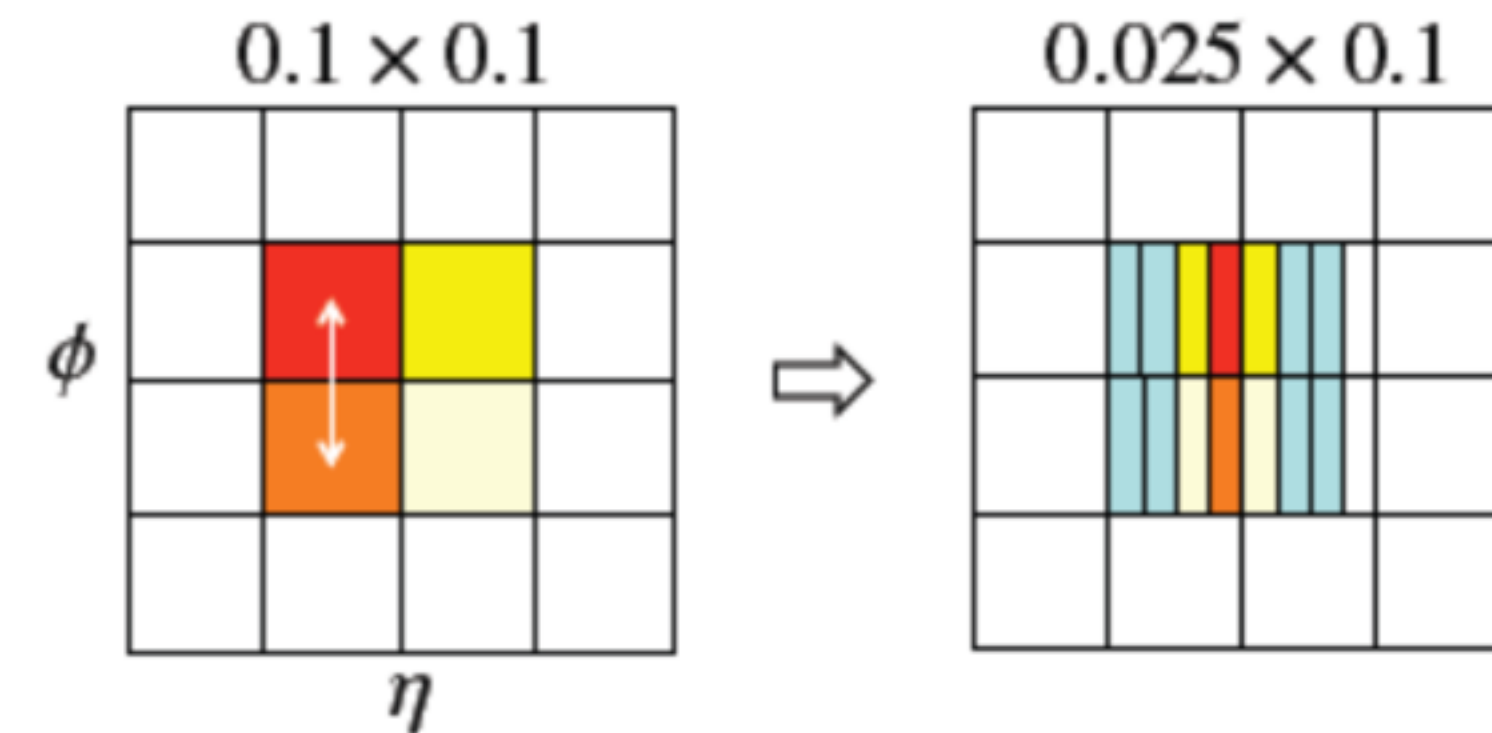

- Full replacement of Inner Tracker (UK)
  - ▶ Existing Inner Detector performance degraded by radiation damage and high occupancy in Phase 2
  - ▶ Replace with all silicon tracker
    - pixels and microstrips
  - ▶ Significantly increase granularity
    - Pixel system (LOI layout) 4 barrel layers and 6 disks ( $\sim 8 \text{ m}^2$ )
    - Strip system 5 barrel layers plus 7 disks ( $\sim 190 \text{ m}^2$ )
    - Robust tracking with 14 layers  $\rightarrow$
  - ▶ Minimise material budget within tracking acceptance

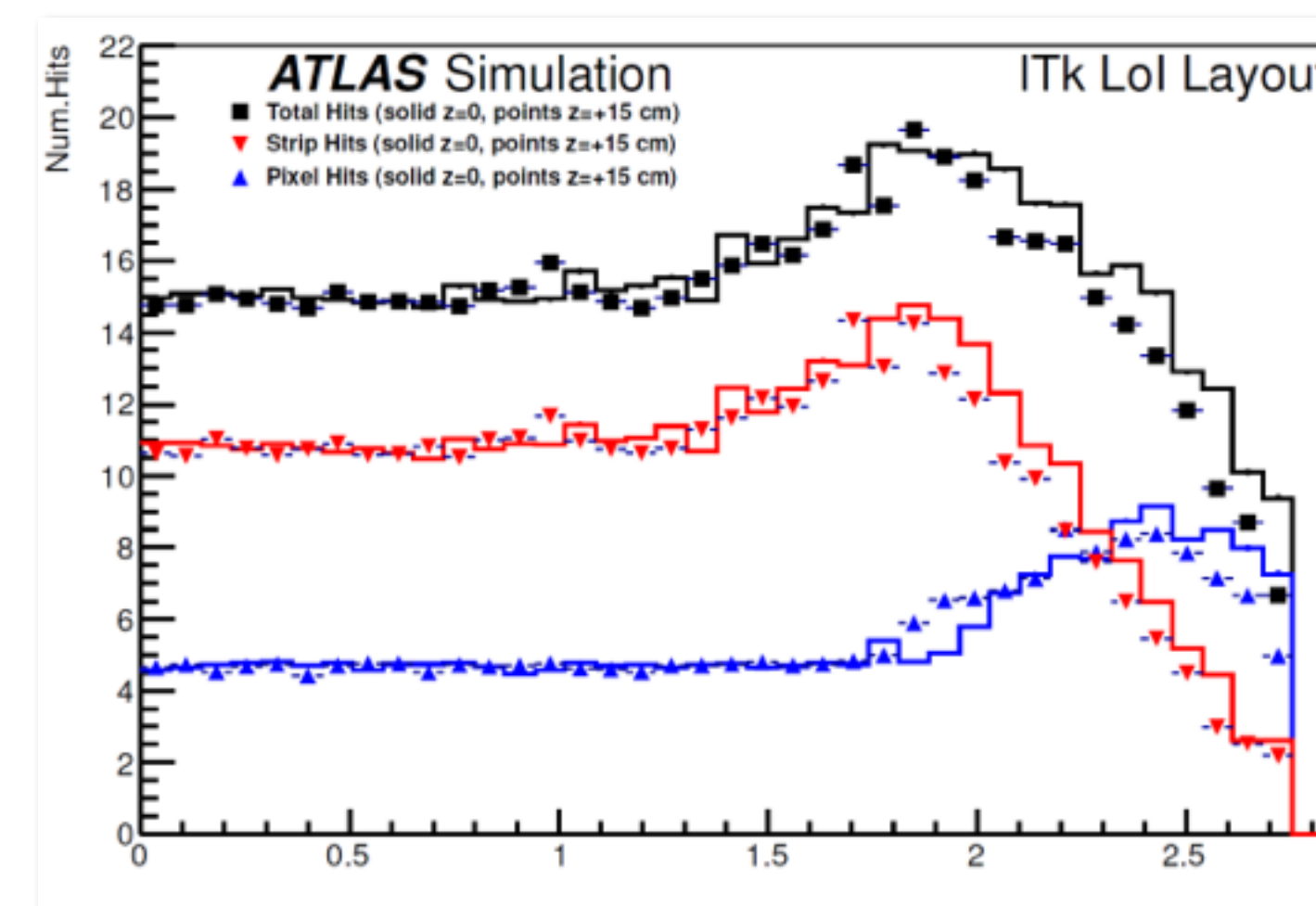
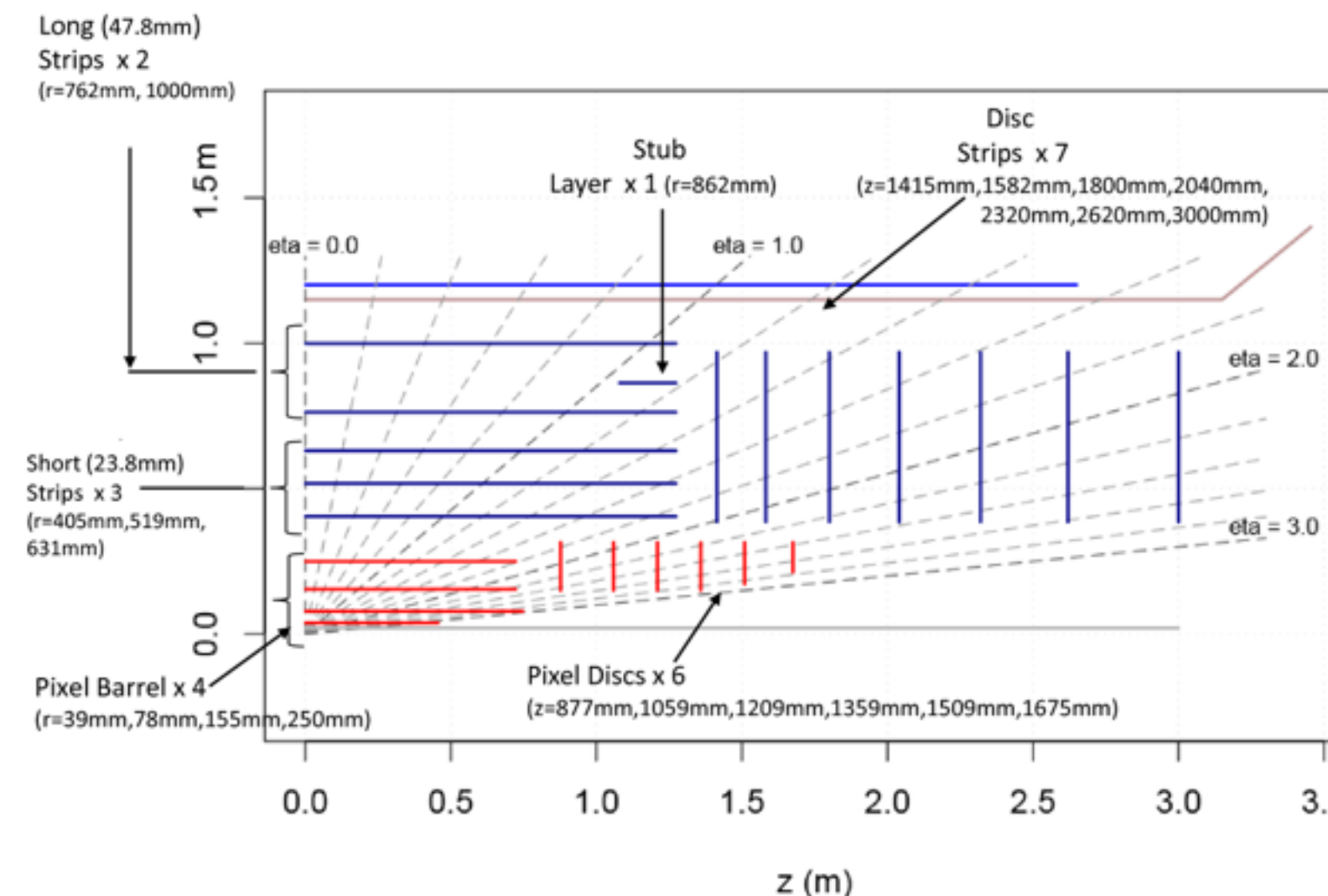

Other layouts with extended  $\eta$  under study



- ▶ Sufficient hits on track to maintain high efficiency and combat combinatorics at high pile up
  - Excellent tracking efficiency →
- ▶ UK interest in large contribution to new tracker
- ▶ Extensive R&D underway for several years

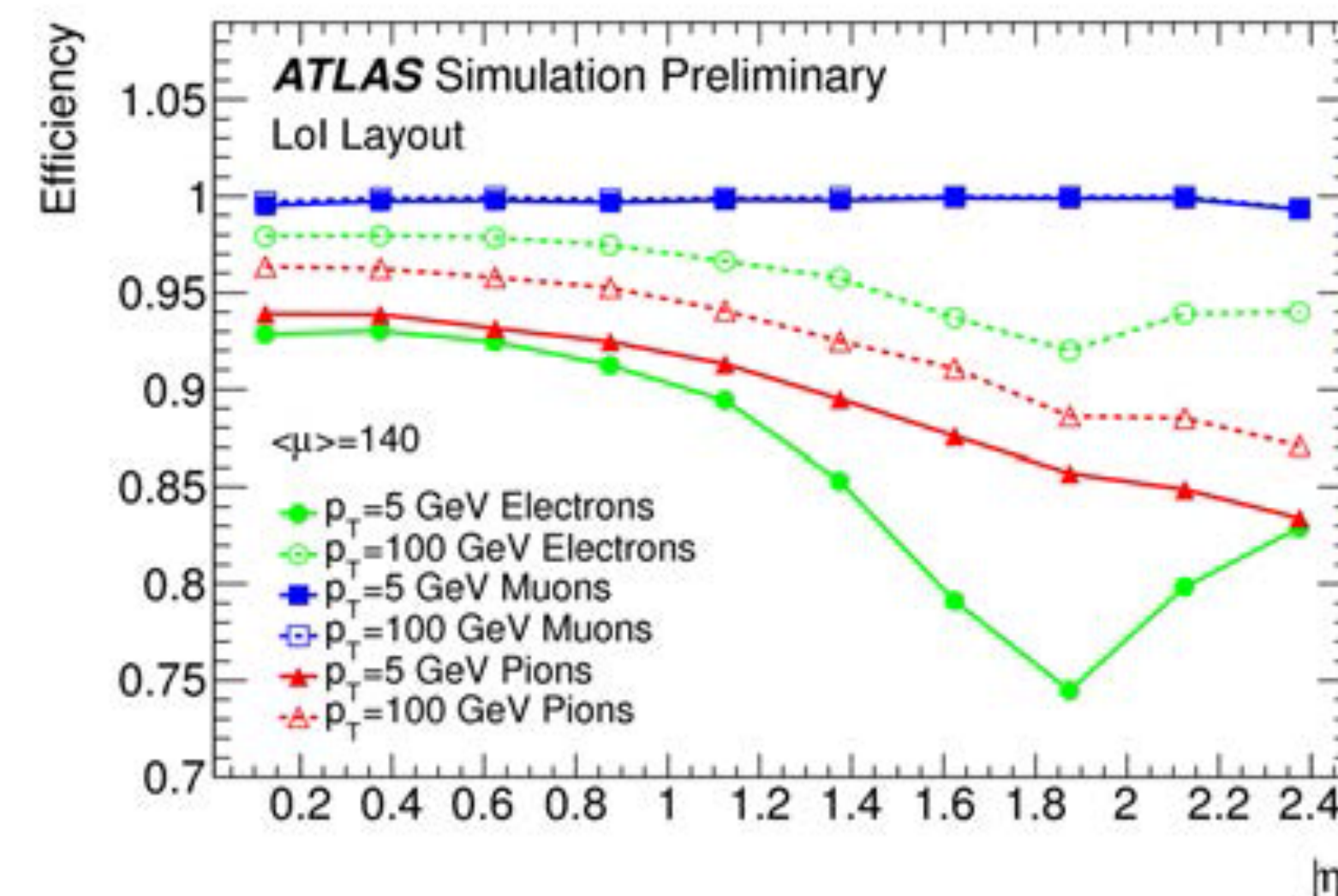

Microstrip Stave Prototype

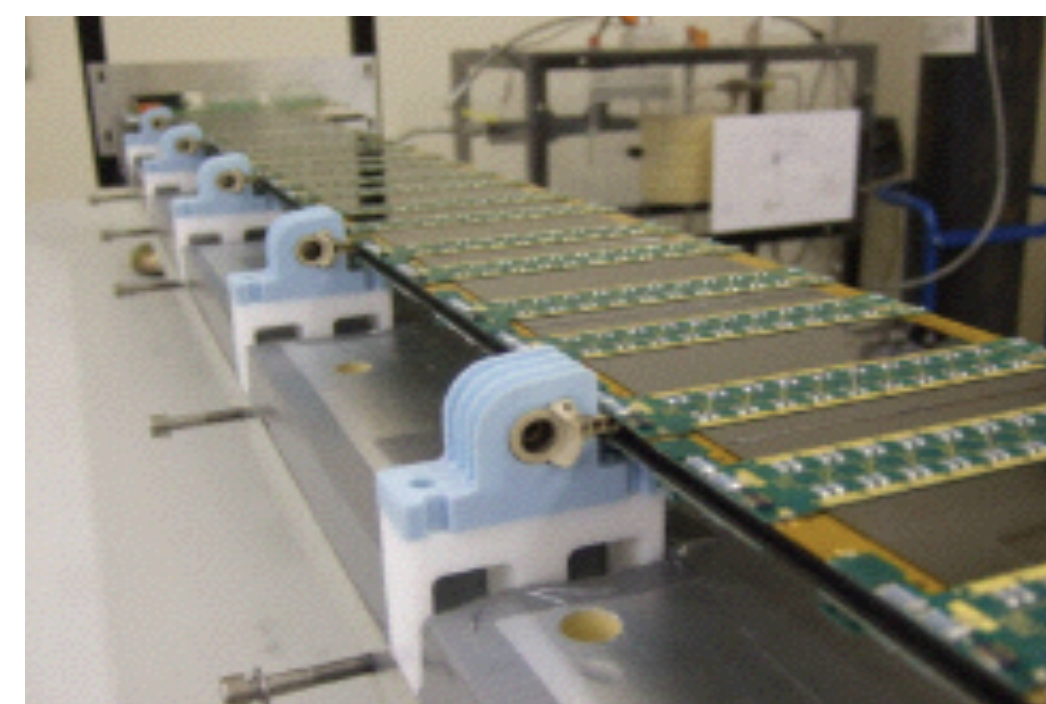

Quad Pixel Module Prototype

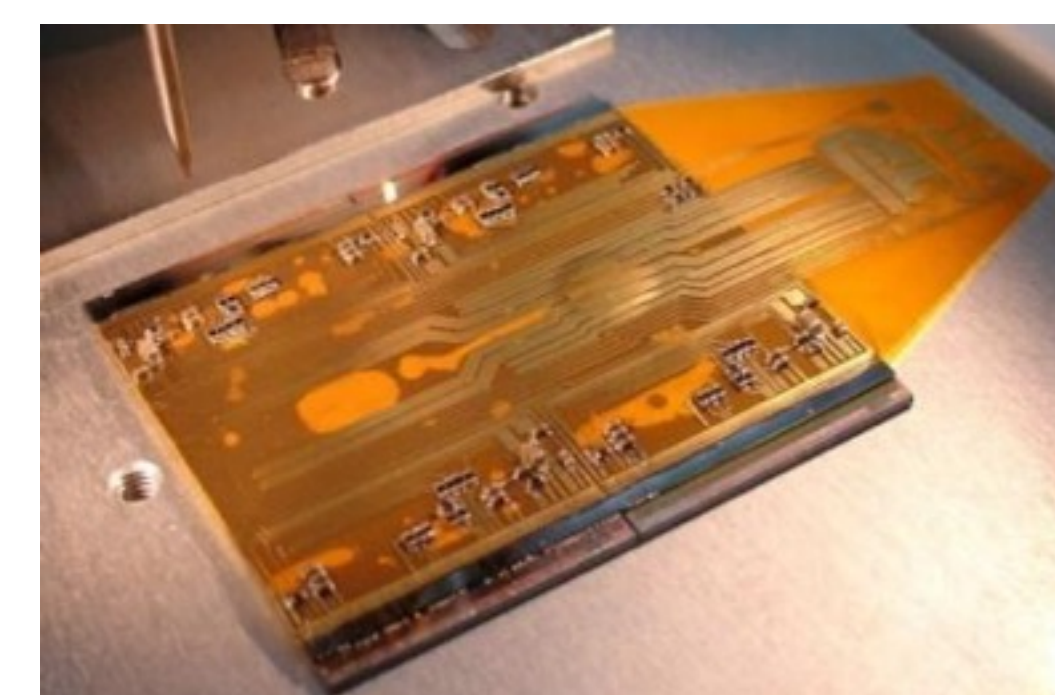

- Trigger upgrade

- ▶ New Trigger Architecture

- ▶ Two Level Hardware trigger

- L0: 1 MHz, 6 $\mu$ s latency (calorimeter and muons)
- L1: 300-400 kHz 24 $\mu$ s latency

- ▶ L1Track: Use tracking information earlier in trigger processing

- Regional information from ITk
- Associative Memory ASICs for track finding and FPGAs for track fitting (similar to FTK)

- ▶ Phase 1 L1 calorimeter trigger becomes Phase 2 L0

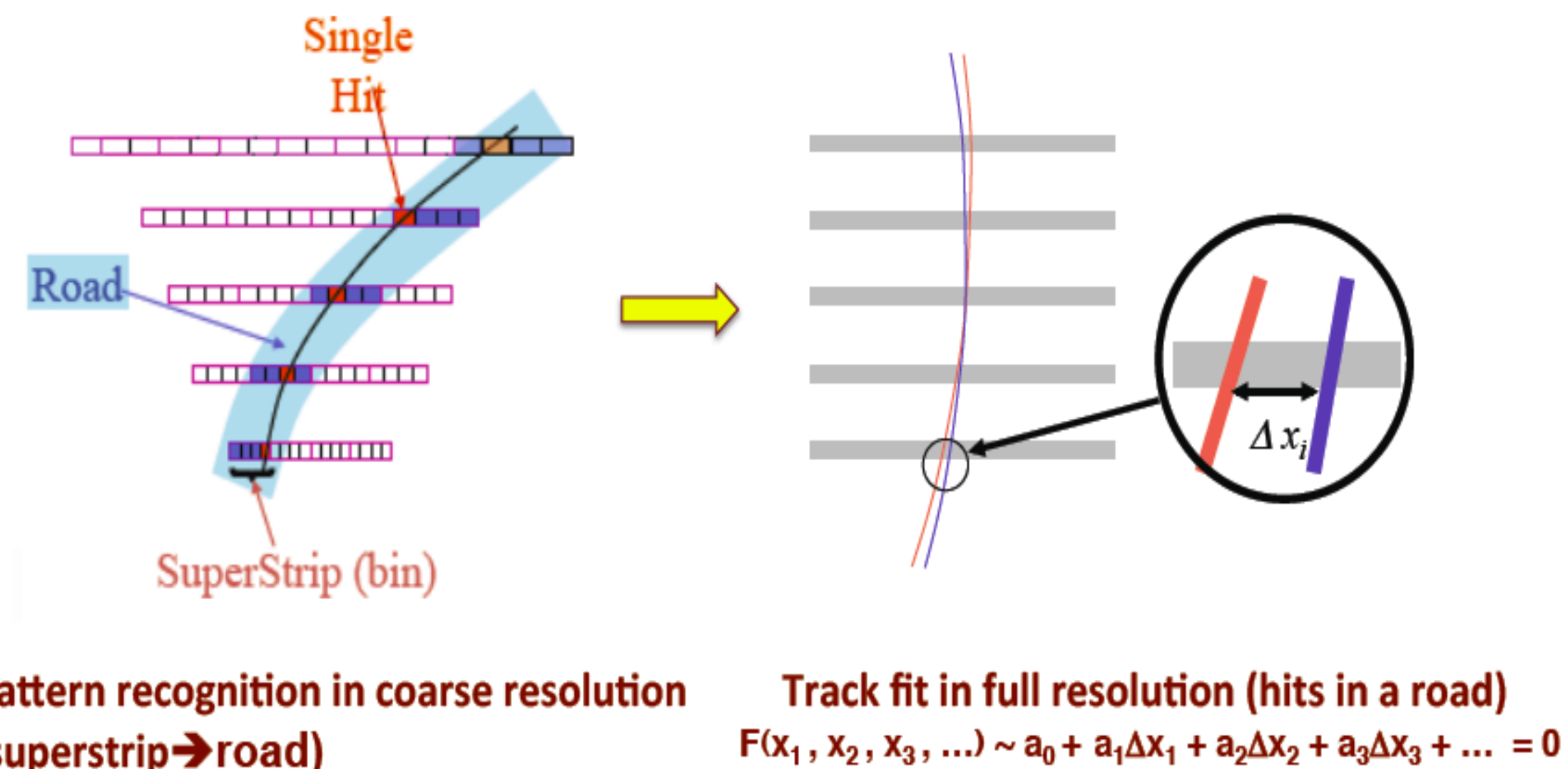

- Hadron calorimeter
  - ▶ Replace photodetectors and electronics between LS1 and LS2 → add depth information and improved noise performance
- Level-1 Trigger (UK)
  - ▶ New system with latest electronics runs from 2016 → **now running in cosmic-ray runs!**
- Pixel detector
  - ▶ New detector to be installed 2016/17
- Forward muon detectors
  - ▶ New GEM detectors to be installed in LS2

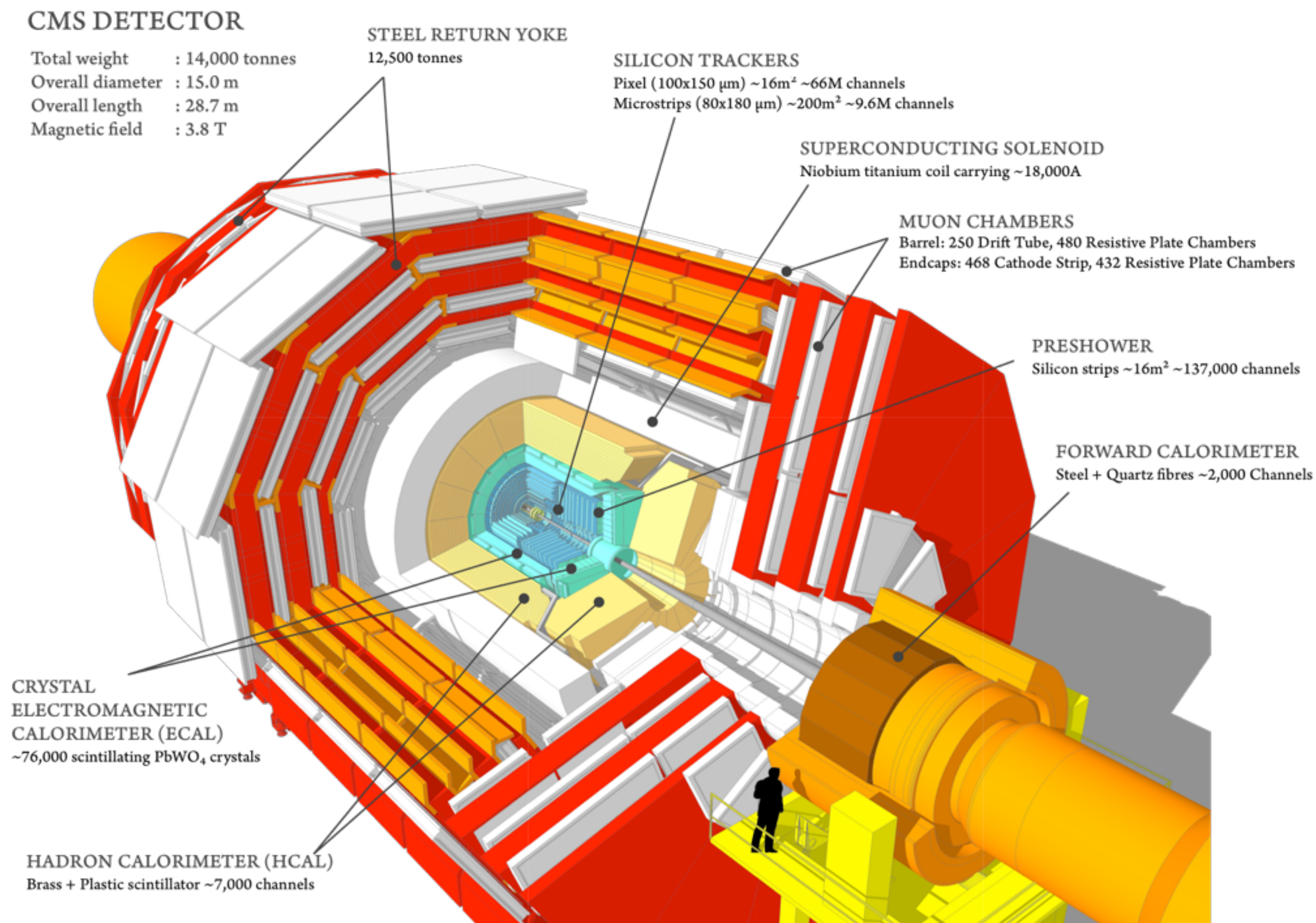

- ▶ Replace older VME electronics with latest  $\mu$ TCA (telecoms standard) electronics  $\rightarrow$  latest, powerful processing (FPGAs) and high speed serial links
- ▶ Replace copper links with optical fibres almost everywhere
- ▶ Earlier merging of detector data in muon system  $\rightarrow$  better reconstruction
- ▶ Pile up subtraction in calorimeter system for object energies and isolation energies

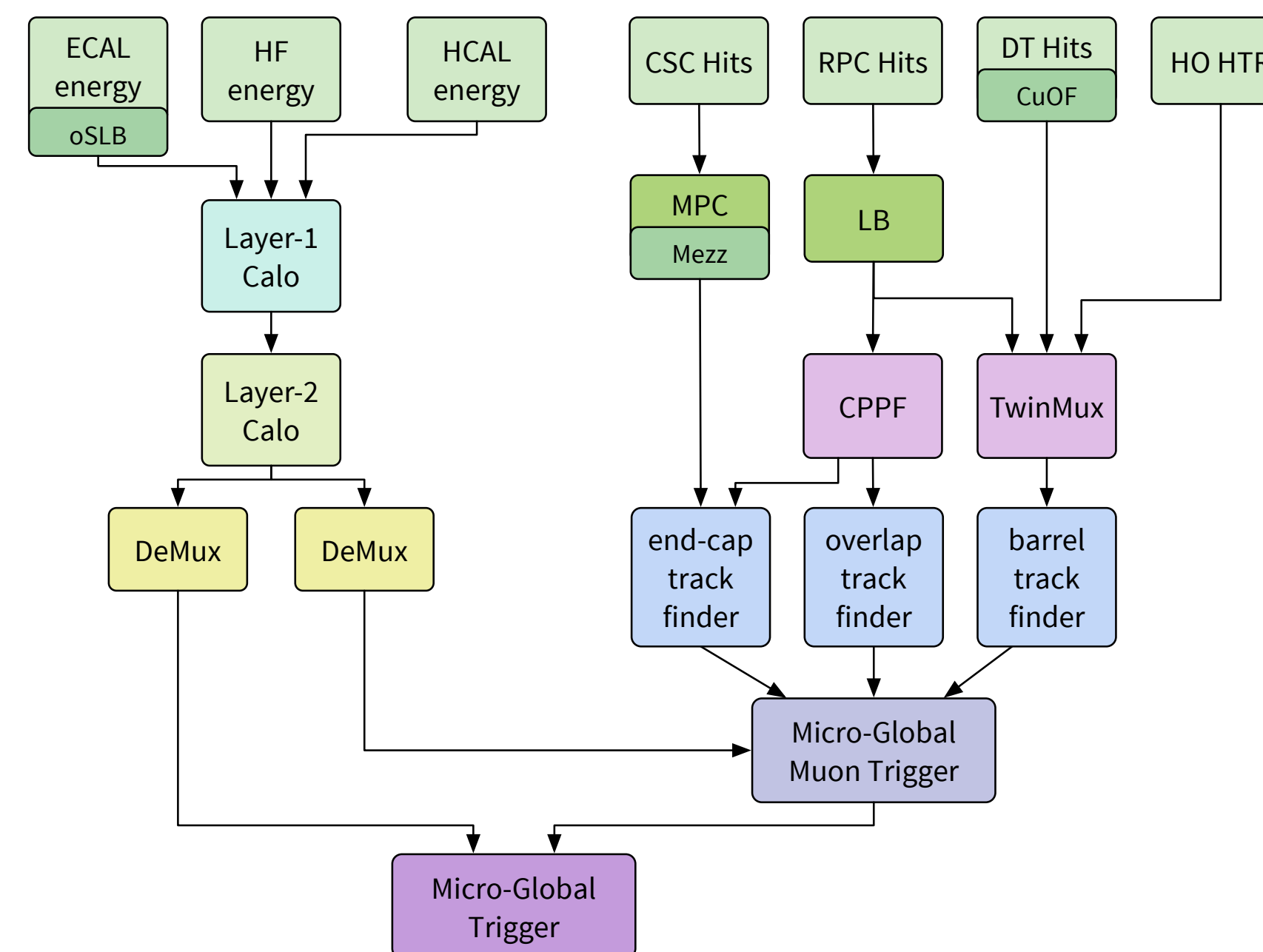
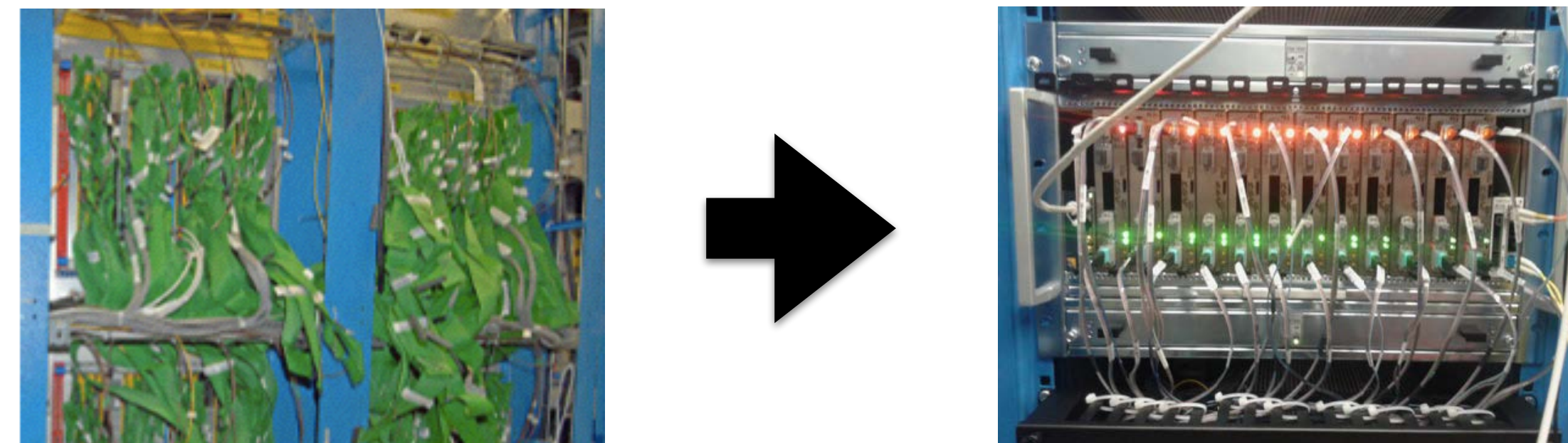

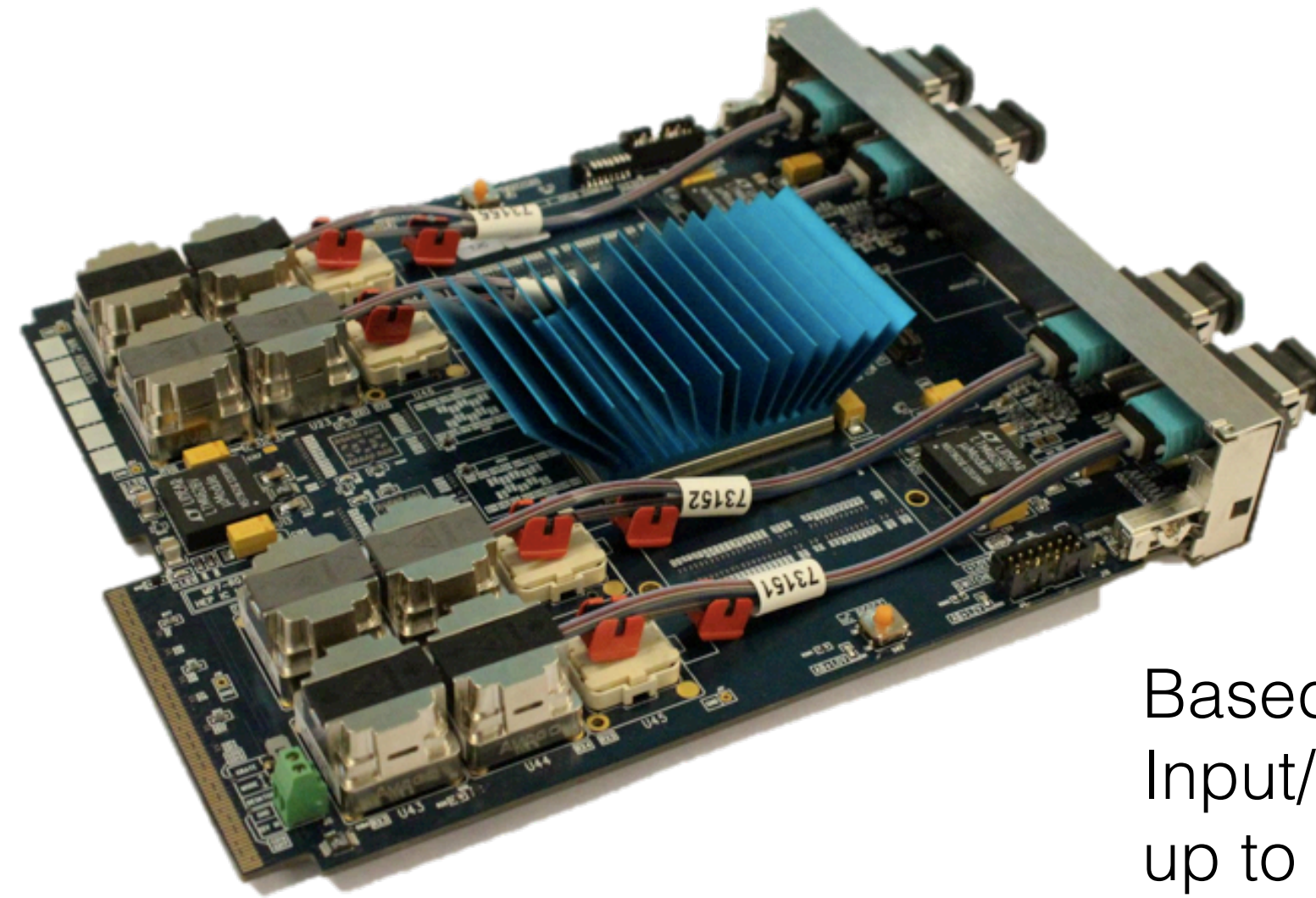
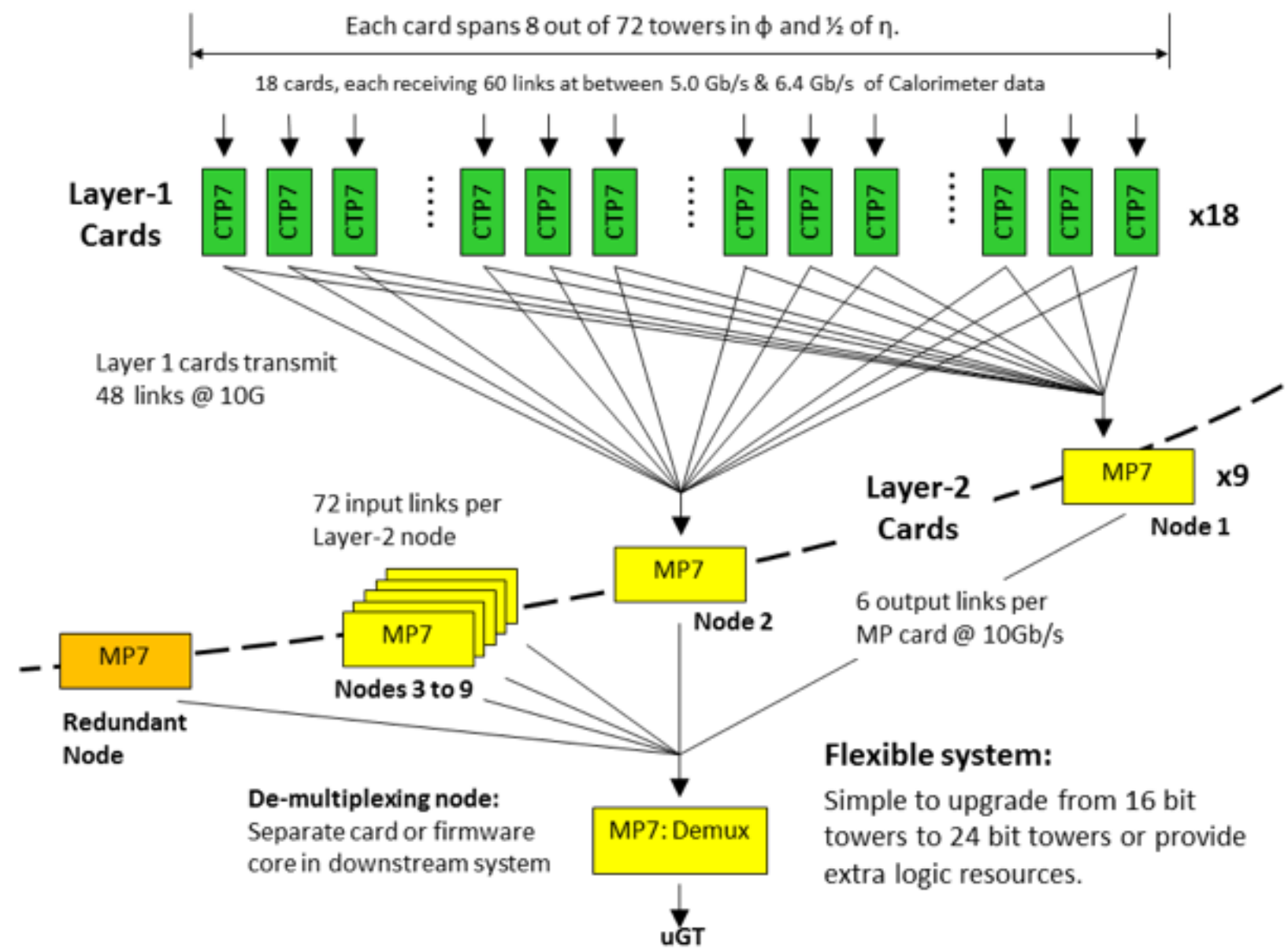

Based on  $\mu$ TCA telecoms standard  
Input/output 72 optical links running  
up to 12.5 Gb/s  $\rightarrow$  0.9 Tb/s

- ▶ Higher granularity (tower level)
- ▶ One processing FPGA sees the entire detector for one event
  - Seamless coverage of detector
  - Sophisticated algorithms (closer to offline)

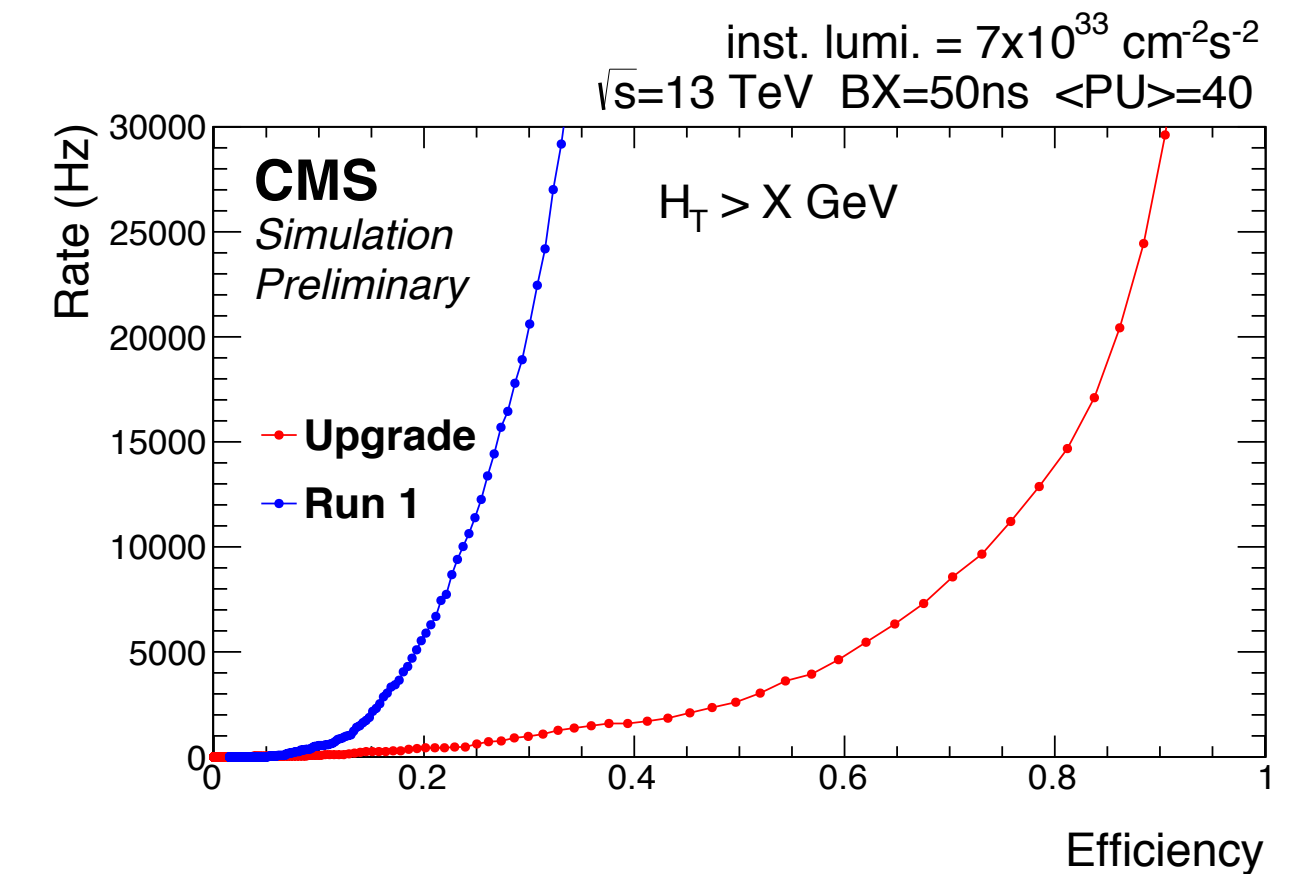
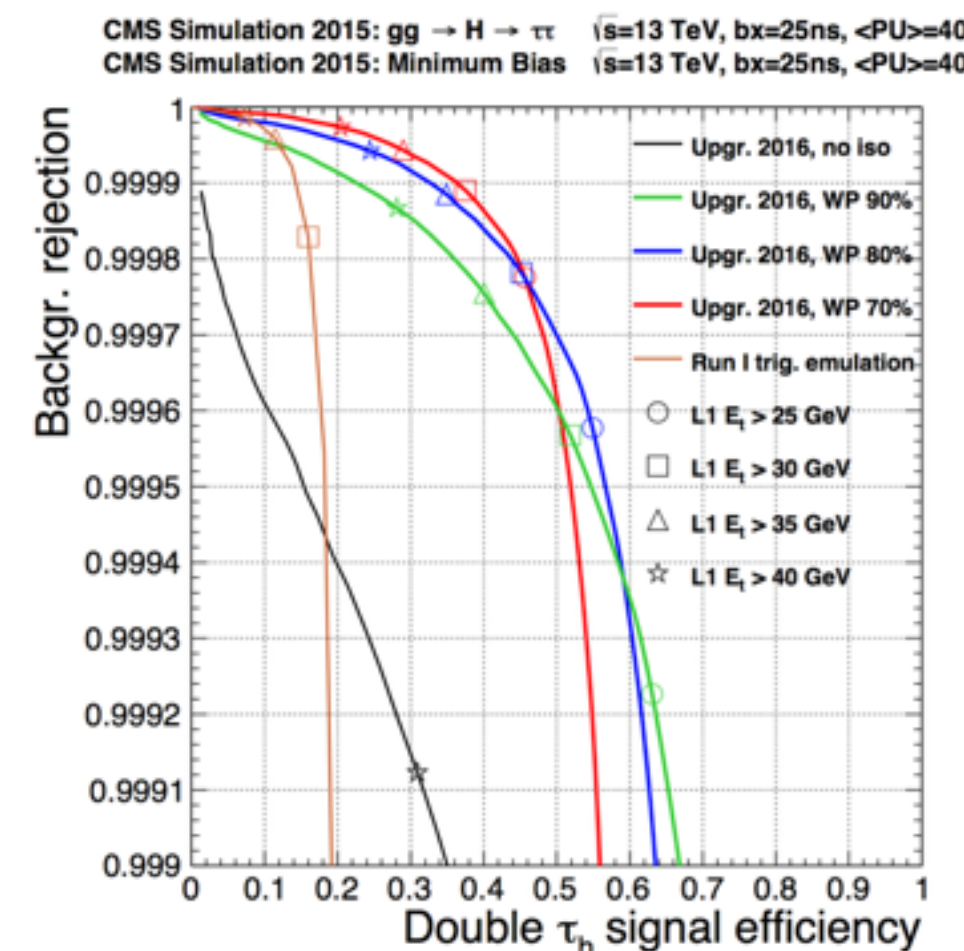

- ▶ Pixel detector
  - Similar configuration as Phase 1
    - 4 layers and 10 disks to cover up to  $|\eta|=4$
    - Thin sensors  $100\ \mu\text{m}$
    - Smaller pixels  $30 \times 100\ \mu\text{m}$
  
- ▶ Outer tracker (UK)
  - High granularity for efficient track reconstruction beyond 140 PU
  - Improved material budget
  - $P_T$ -modules to provide trigger for tracks with  $P_T \geq 2\ \text{GeV}$

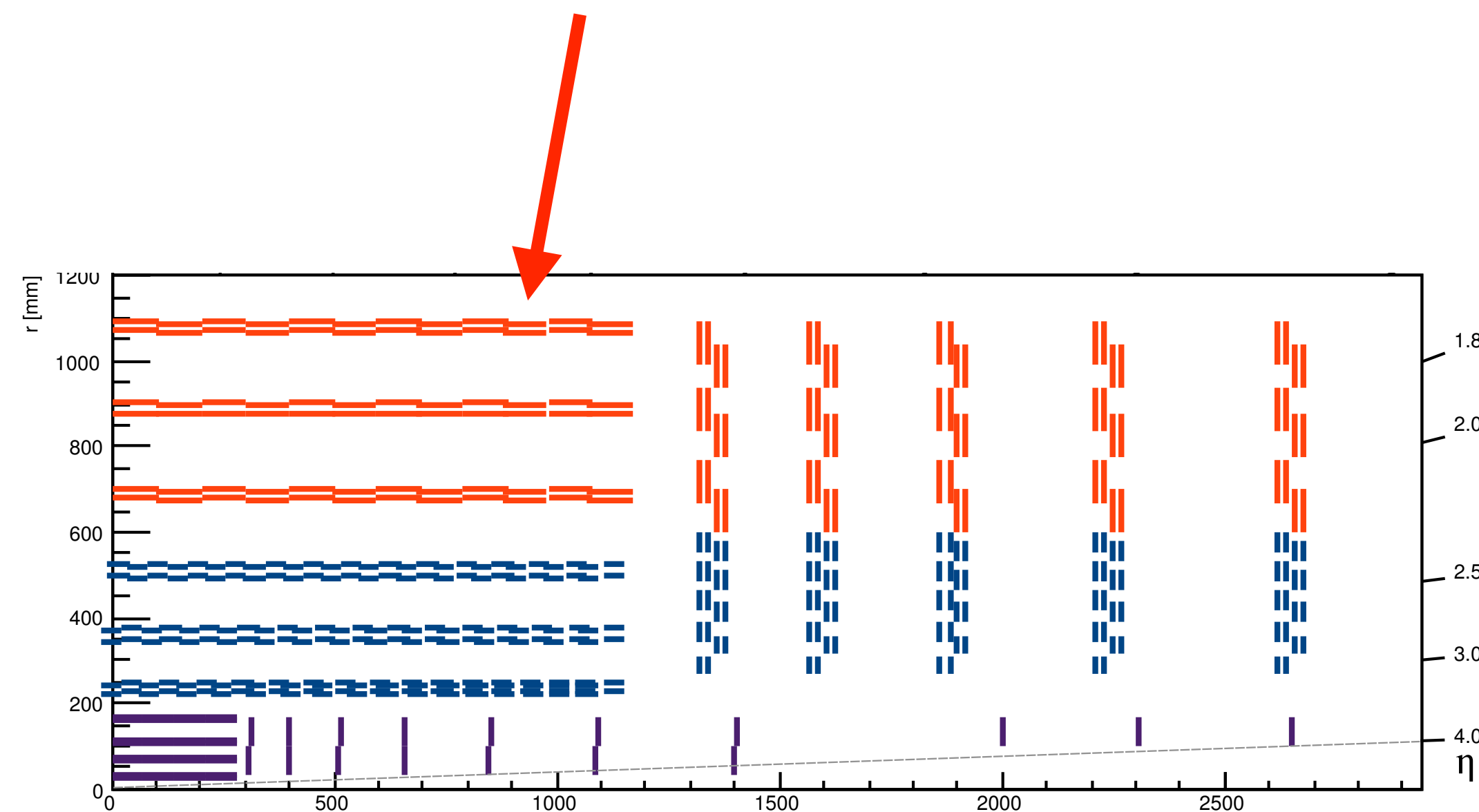
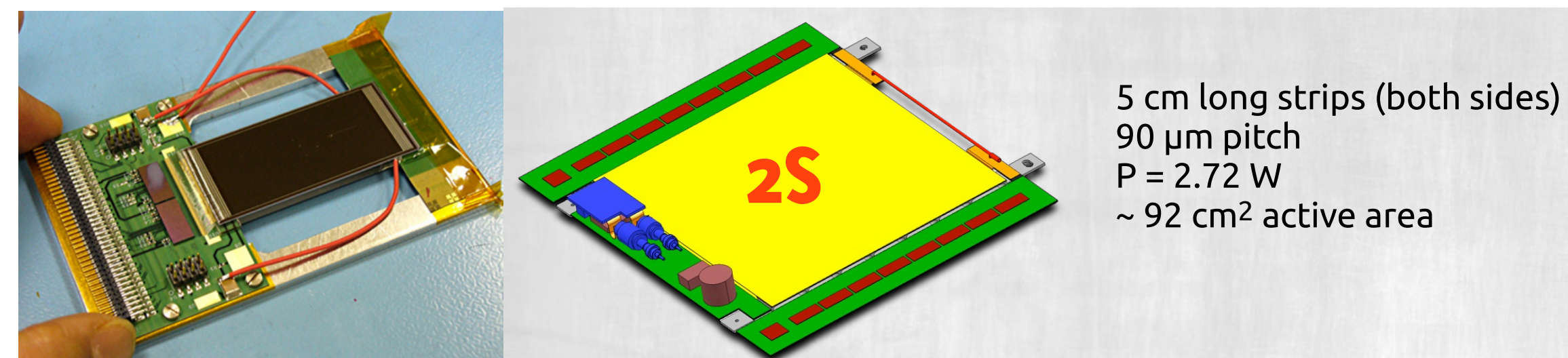

- Outer tracker

- $P_T$ -modules  $\rightarrow$  doublet sensors with common electronics to correlate hits and form stubs for trigger
- Distance between sensors give track  $p_T$  lower cut

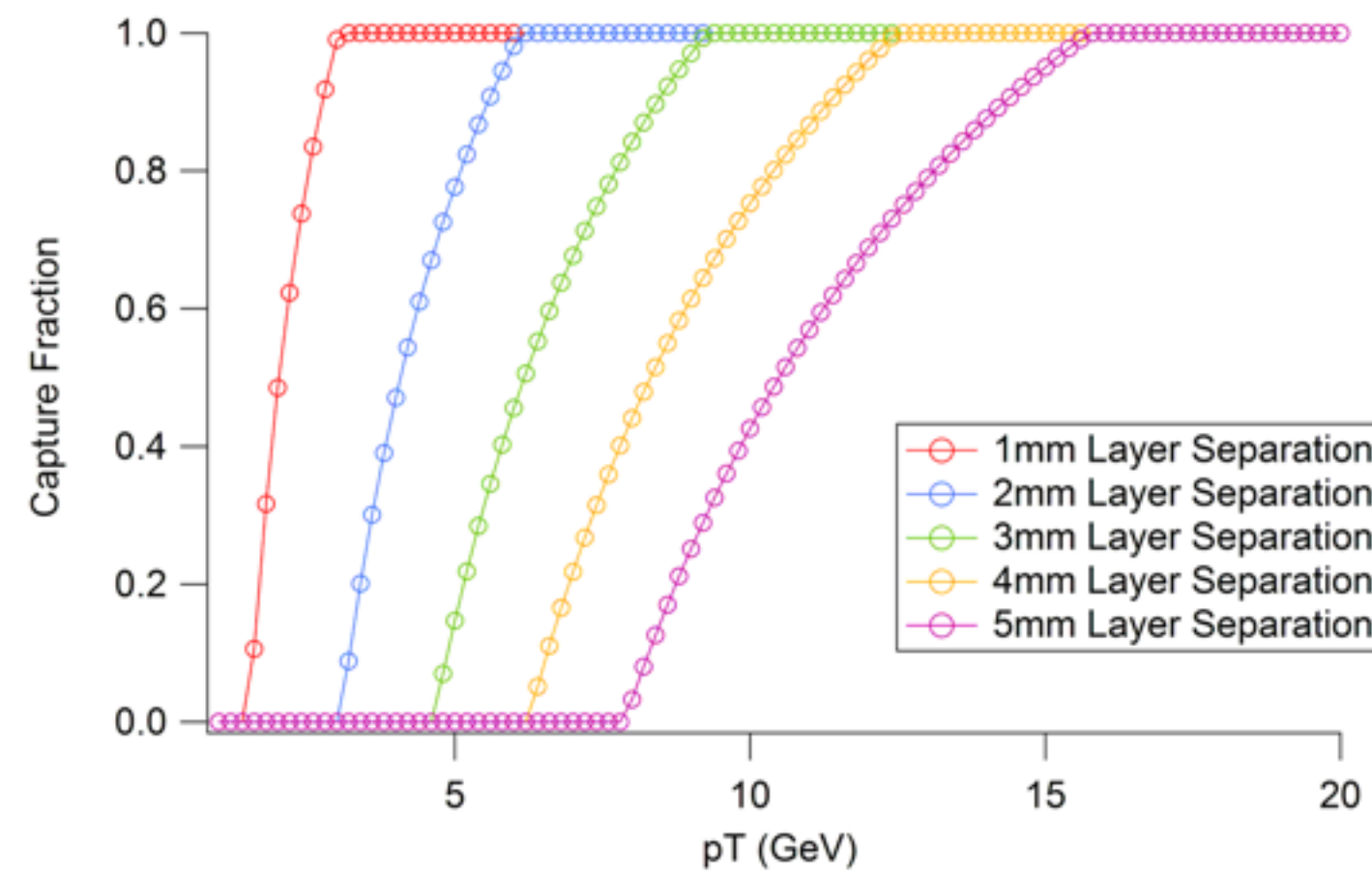
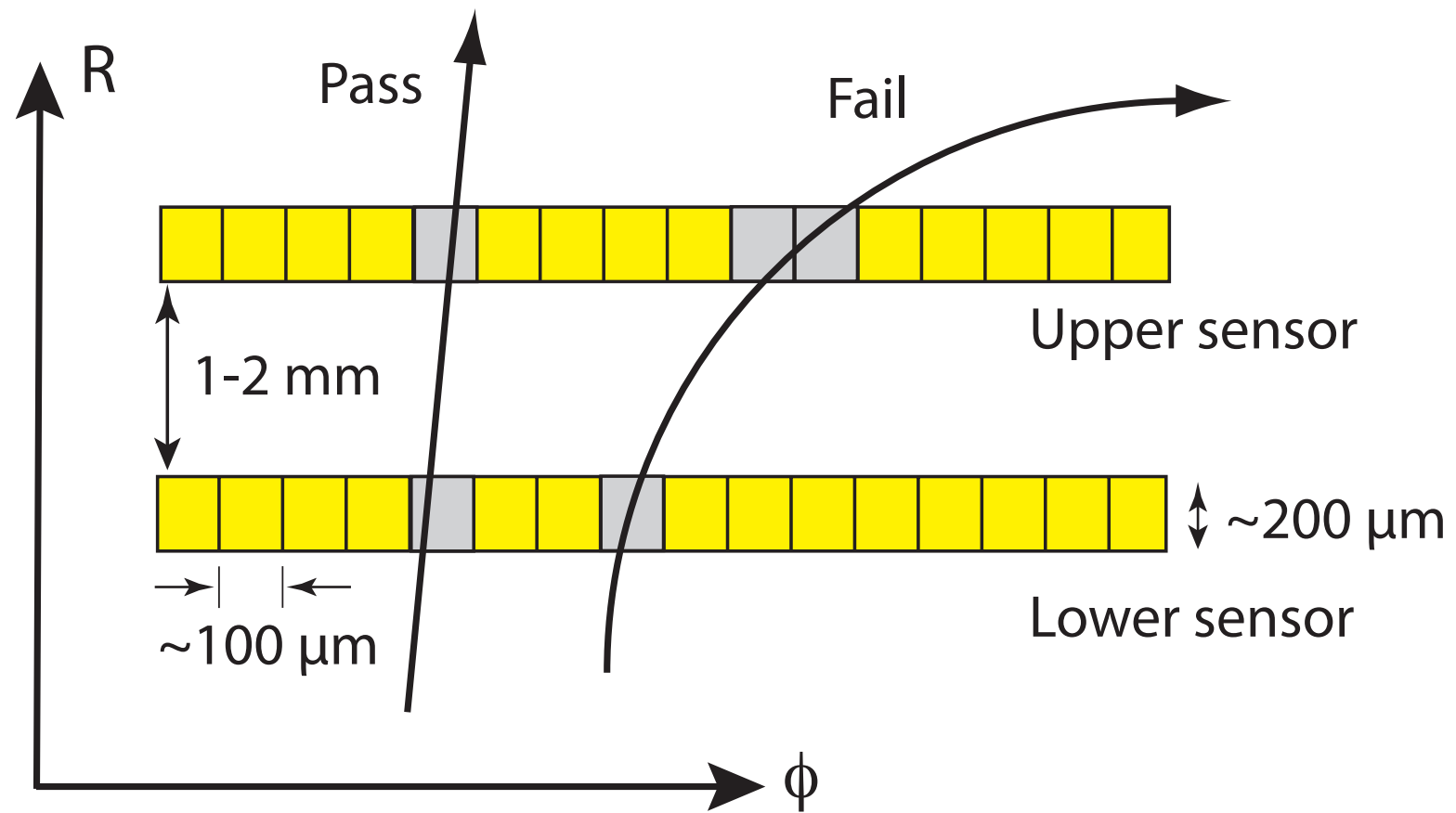

- Allows control of trigger rates and hugely improved  $p_T$  resolution
- FPGA and AM based track finding under study

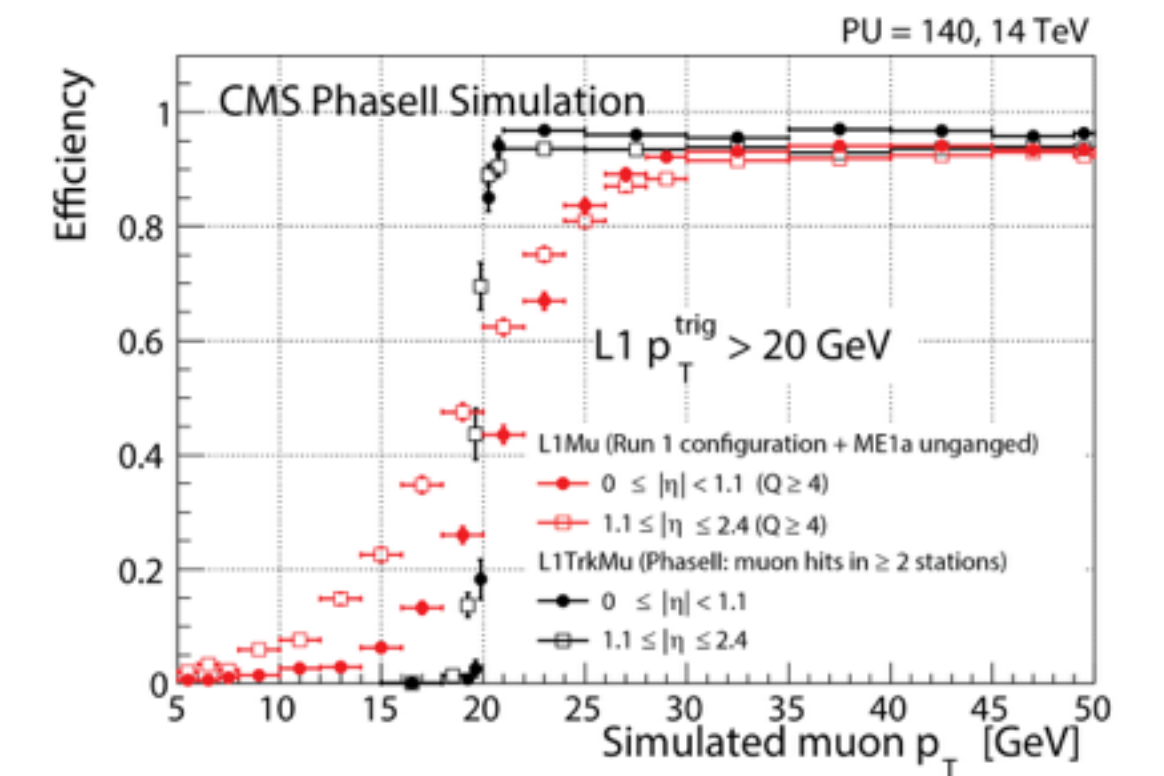
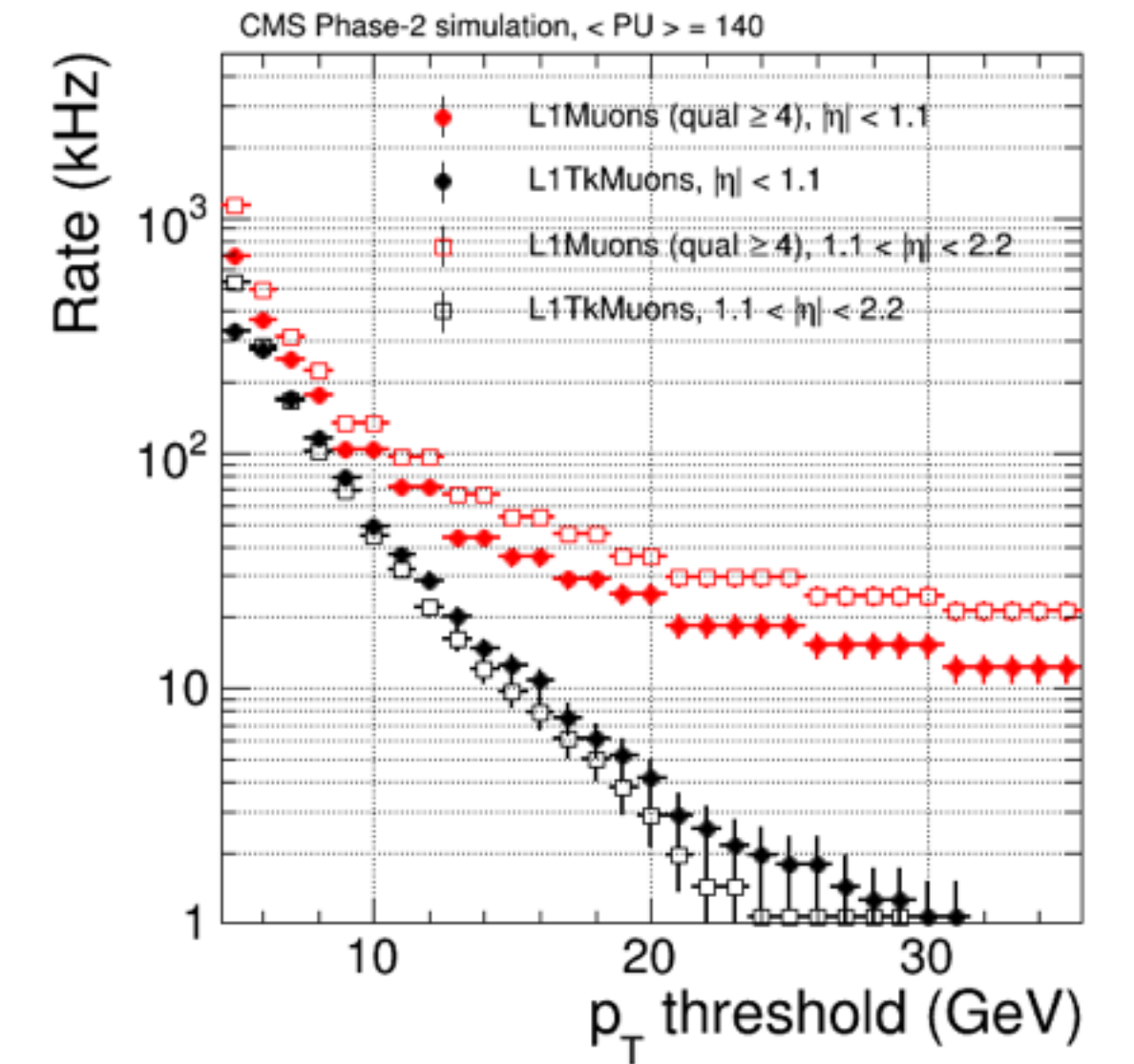

- Current endcap calorimetry will not remain performant after LS3
  - ▶ Combination of radiation damage and high pile up conditions
- Plan to replace by integrated high-granularity calorimeter
  - ▶ Sampling calorimeter with silicon sensors, optimised for high pile up
  - ▶ High granularity readout ( $\sim 1\text{cm}^2$ ) and precision timing capability ( $<50\text{ps}$ )

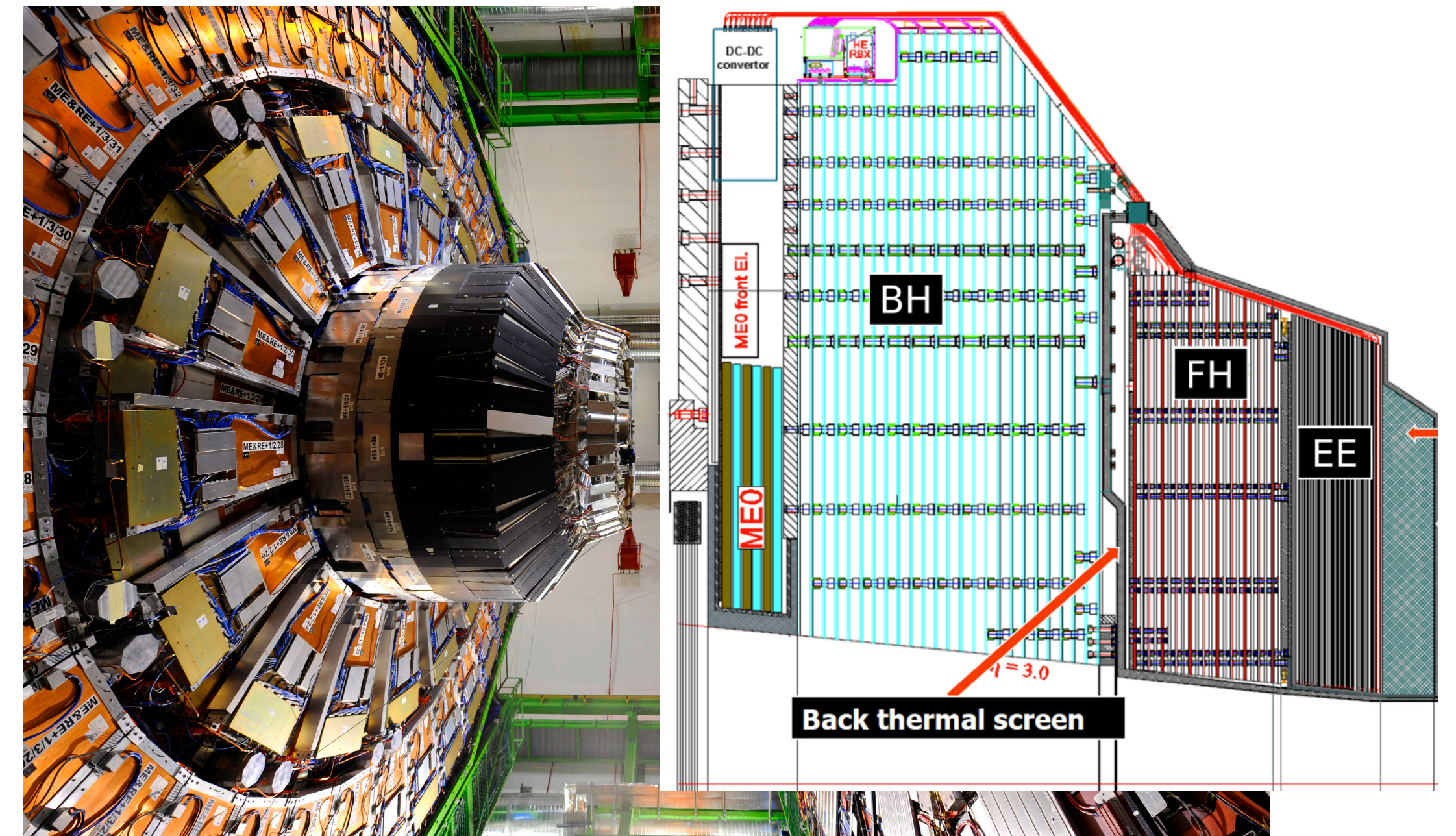



- High Granularity Calorimeter with 4D (space-time) shower measurement

- ▶ Electromagnetic section ( $26 X_0$ ,  $1.5\lambda$ ): 28 layers of Silicon-W/Cu absorber
- ▶ Front Hadronic section ( $3.5 \lambda$ ): 12 layers of Silicon/Brass or Stainless Steel
- ▶ Back Hadronic Calo. (BH) - radiation tol. - granularity
- ▶ BH ( $5 \lambda$ ): 12 layers of Scintillator/Brass or Stainless Steel (2 depth readout)

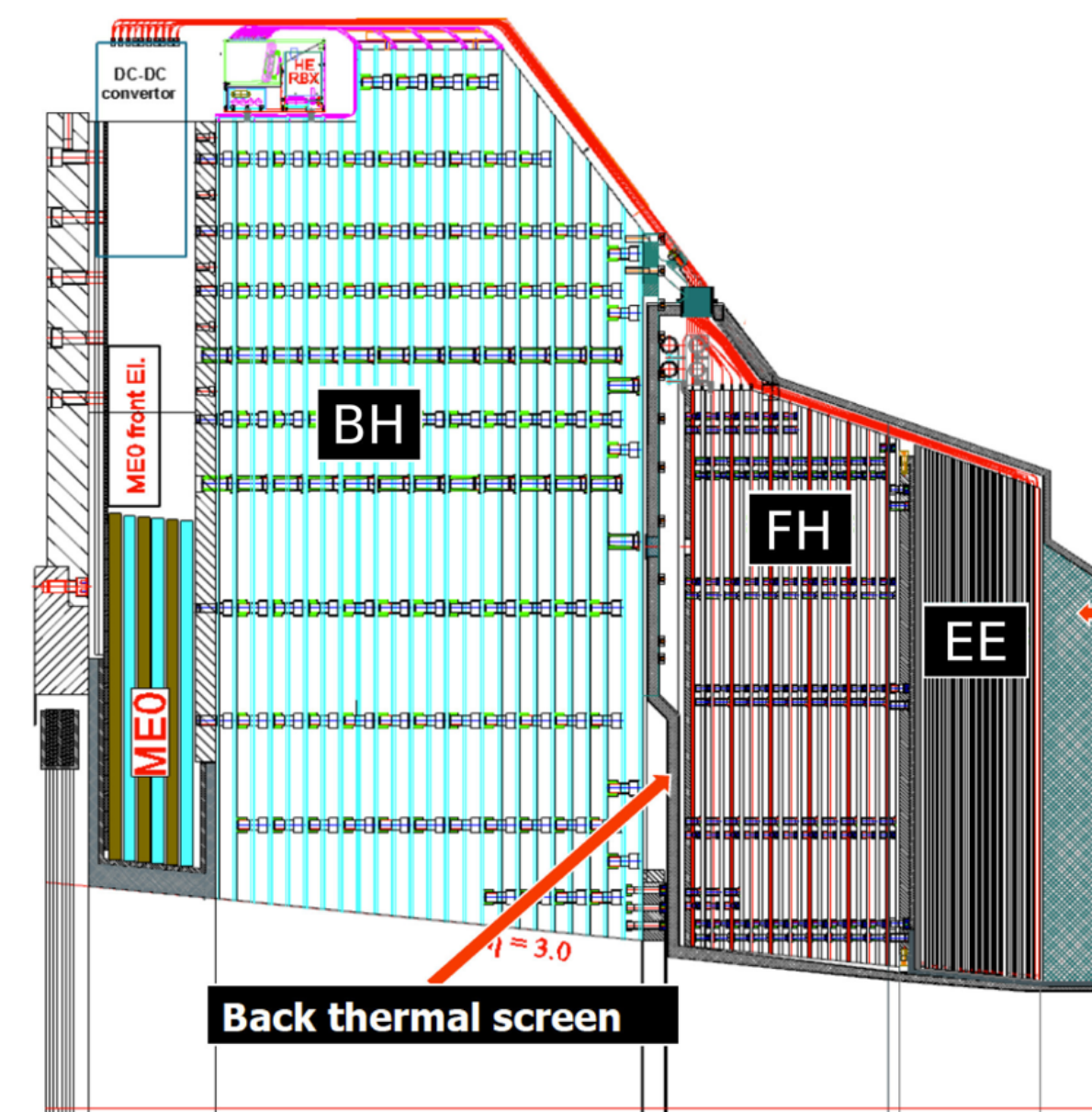

- Major new areas of R&D (UK)

- ▶ Level-1 Trigger, reconstructions algorithms, analogue and digital electronics...

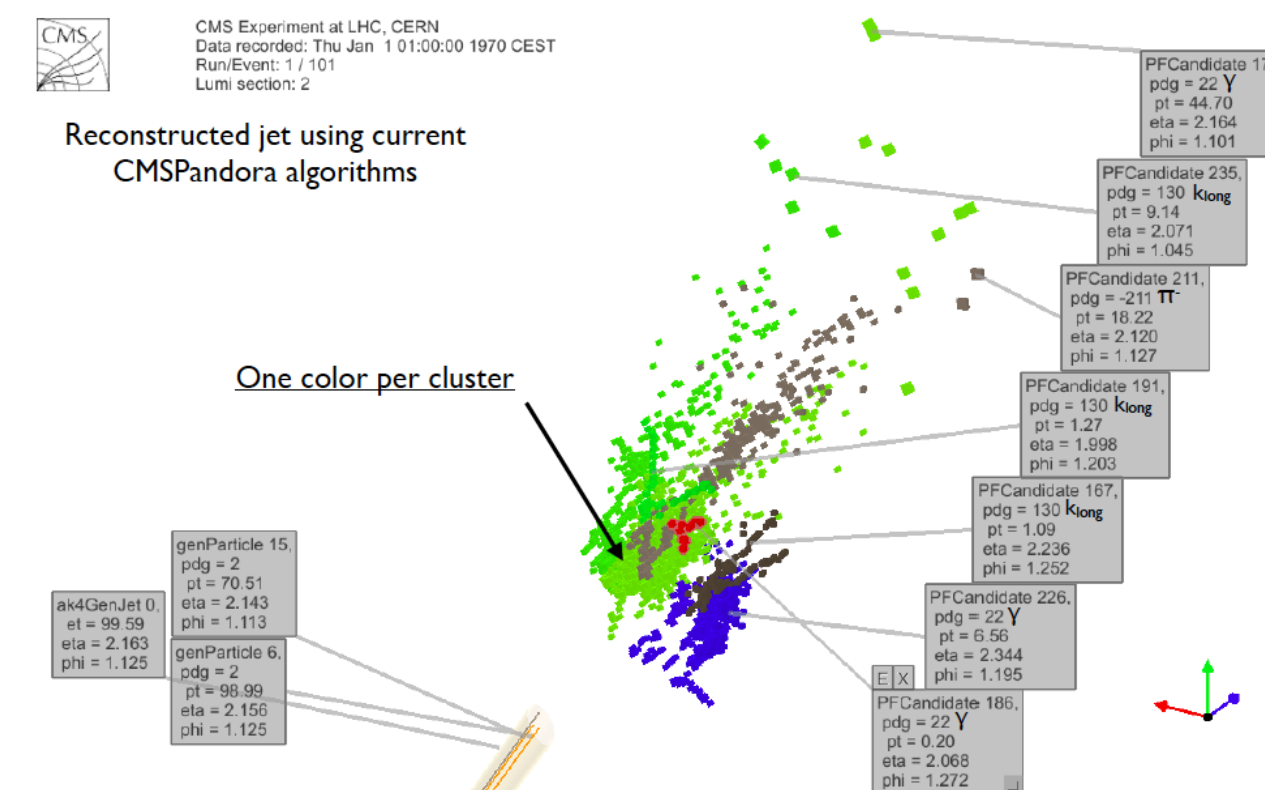

# LHCb upgrade (Run 3)

- Trigger

- ▶ Upgrade readout to 40 MHz → fully software-based trigger
- ▶ New electronics and DAQ

- VELO (UK)

- ▶ New detector and electronics

- RICH (UK)

- ▶ New detector and electronics

- More tomorrow morning...

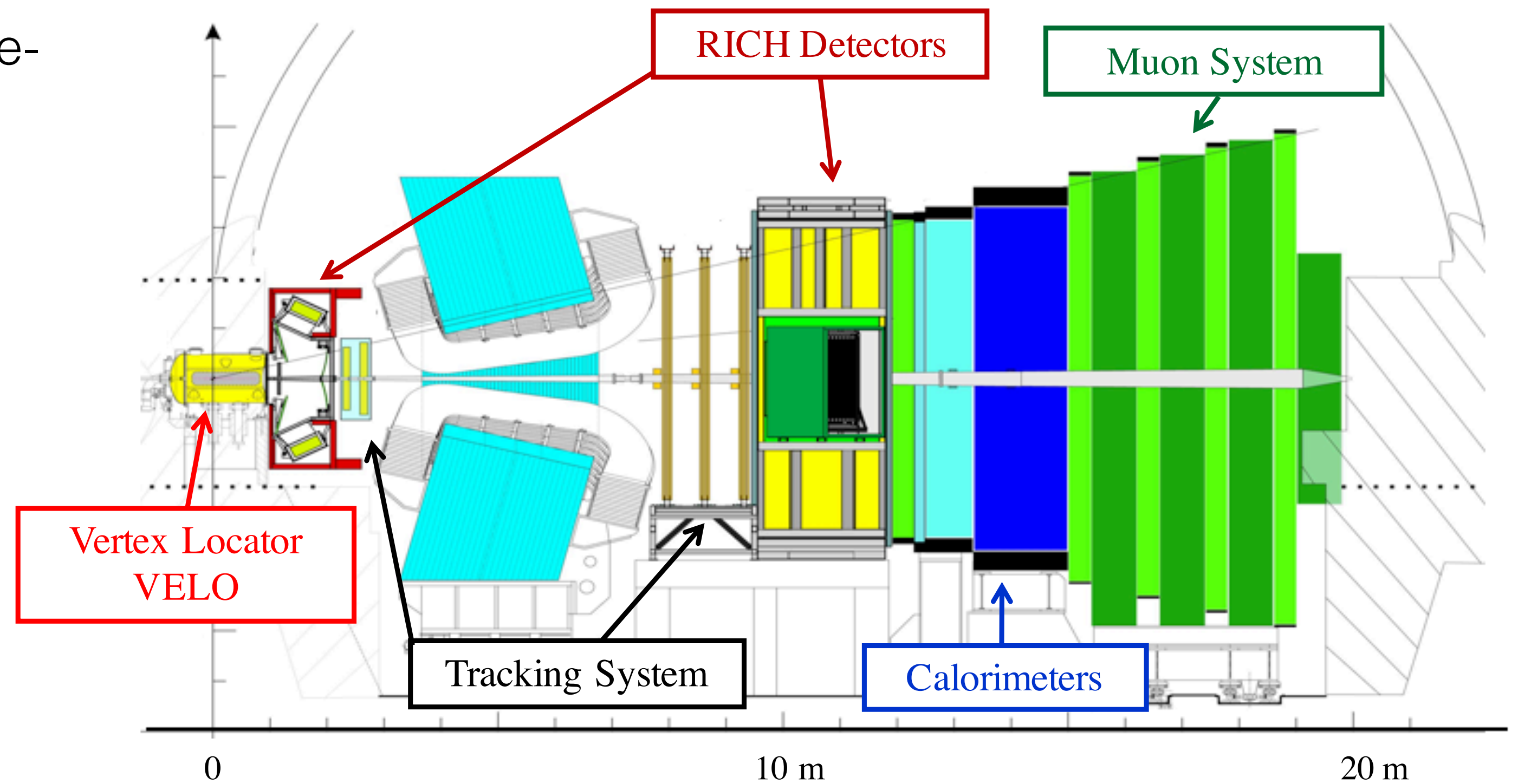

- LHC Run 1 a great success!
  - ▶ Discovery of Higgs boson
  - ▶ Key measurements and searches for beyond the Standard Model physics
- LHC Run 2 underway
  - ▶ Hoping for even more excitement than Run 1
- Beyond Run 2
  - ▶ HL-LHC has a well motivated physics programme
  - ▶ Very significant upgrades to detector → almost new experiments
  - ▶ Great opportunities to shape the future of our field

- ▶ ATLAS Upgrade Physics projections
  - <https://twiki.cern.ch/twiki/bin/view/AtlasPublic/UpgradePhysicsStudies>
  
- ▶ CMS Upgrade Physics projections
  - <https://twiki.cern.ch/twiki/bin/view/CMSPublic/PhysicsResultsFP>
  
- ▶ ATLAS LOI and LHCC Scoping Document
  - <https://atlas.web.cern.ch/Atlas/GROUPS/PHYSICS/UPGRADE/CERN-LHCC-2012-022/index.html>
  - <https://atlas.web.cern.ch/Atlas/GROUPS/PHYSICS/UPGRADE/CERN-LHCC-2015-020/index.html>
  
- ▶ CMS Technical Proposal and LHCC Scoping Document
  - <http://cms-results.web.cern.ch/cms-results/public-results/preliminary-results/TDR-15-002/index.html>
  - <http://cms-results.web.cern.ch/cms-results/public-results/preliminary-results/phase2sd/index.html>

- Readout systems
  - ▶ Readout Pb - Pb collisions up to 50 KHz (currently 0.5-1 KHz)
- New, high-resolution, low-material Inner Tracking System (ITS)
  - ▶ Improve tracking at low  $p_T$
  - ▶ 7 layers of pixels
  - ▶ 25G pixels based on MAPS

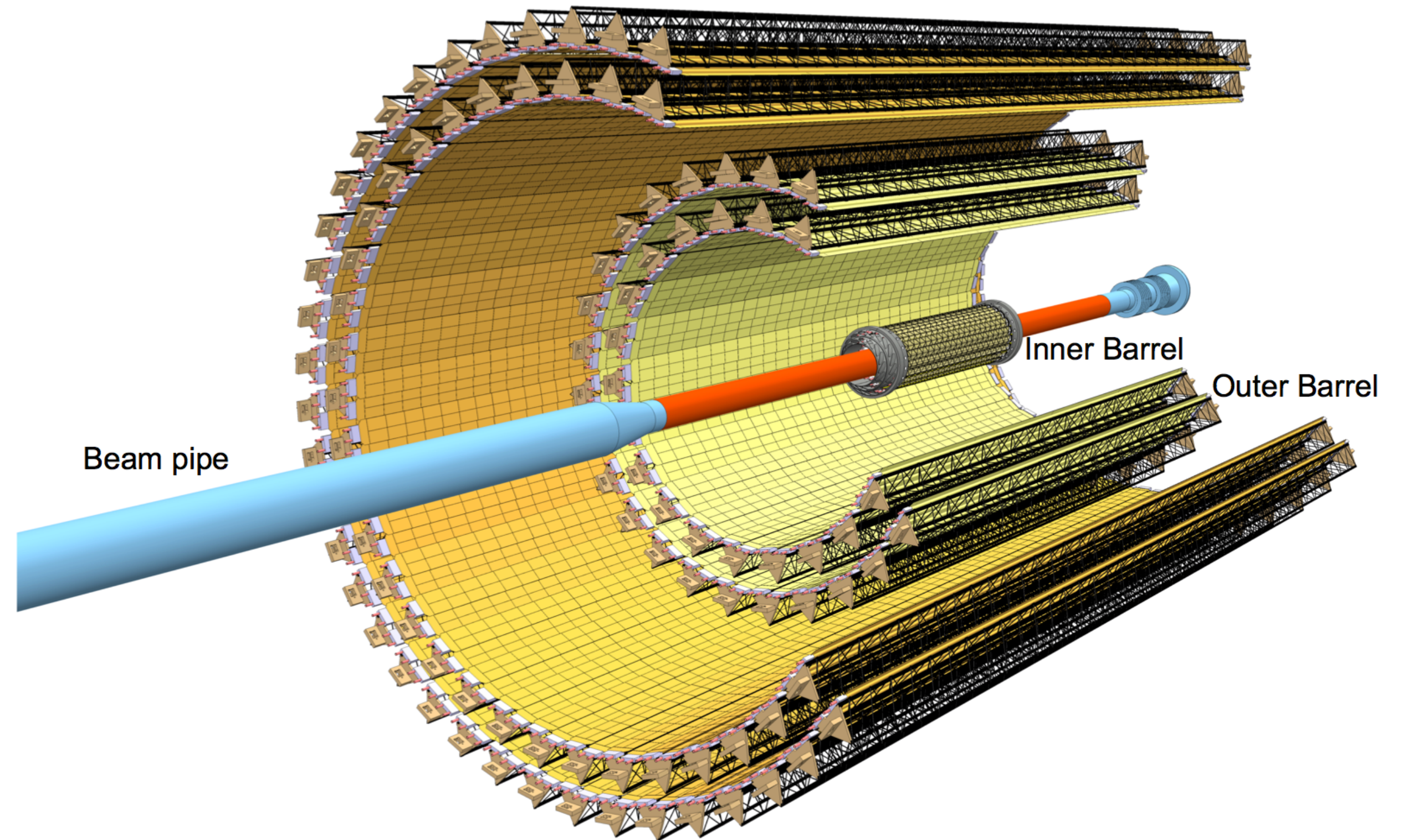

# Higgs couplings

