

FROM RAW DATA TO PHYSICS

LECTURE 2

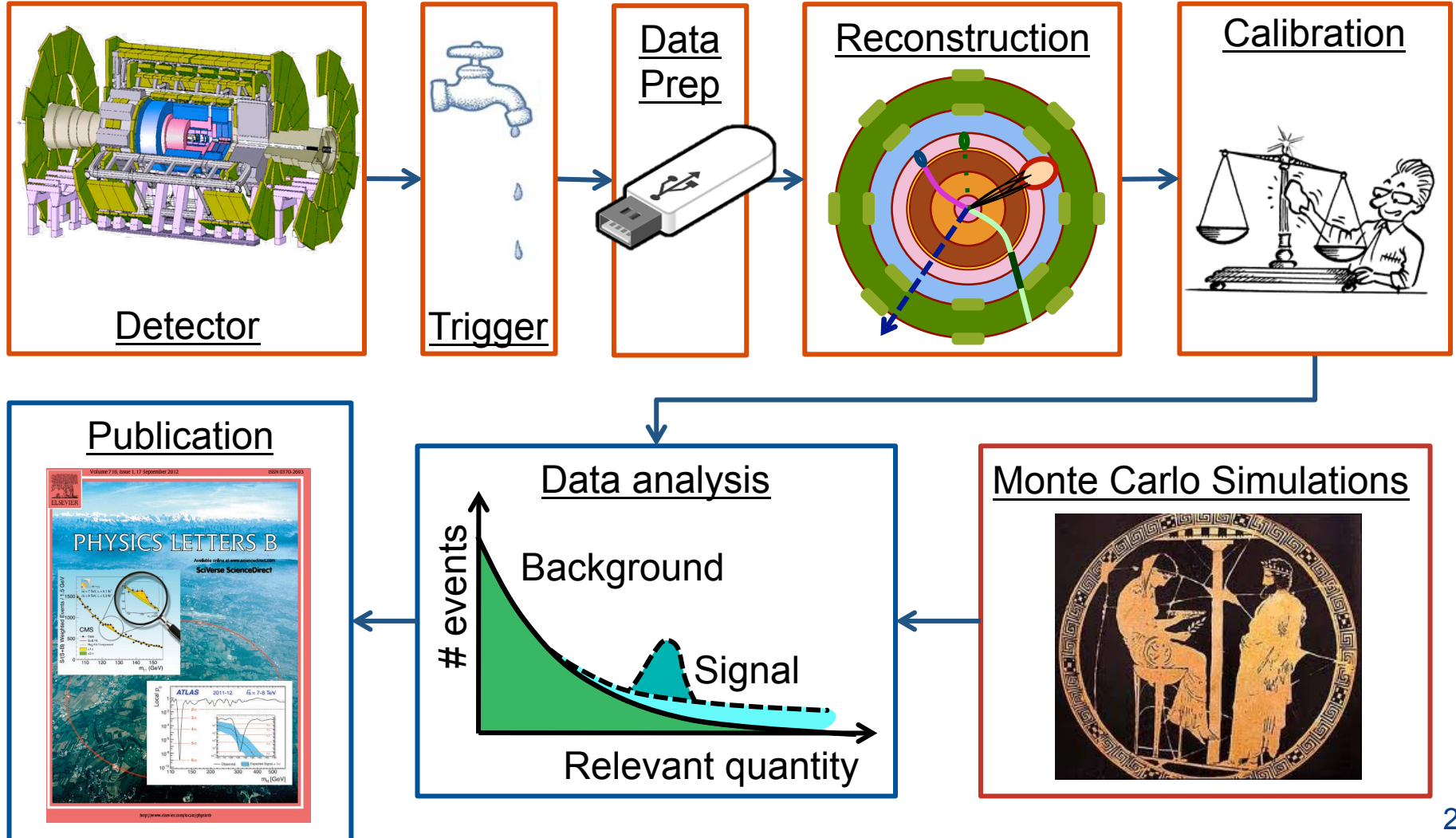

LECTURE 2



LECTURE 2

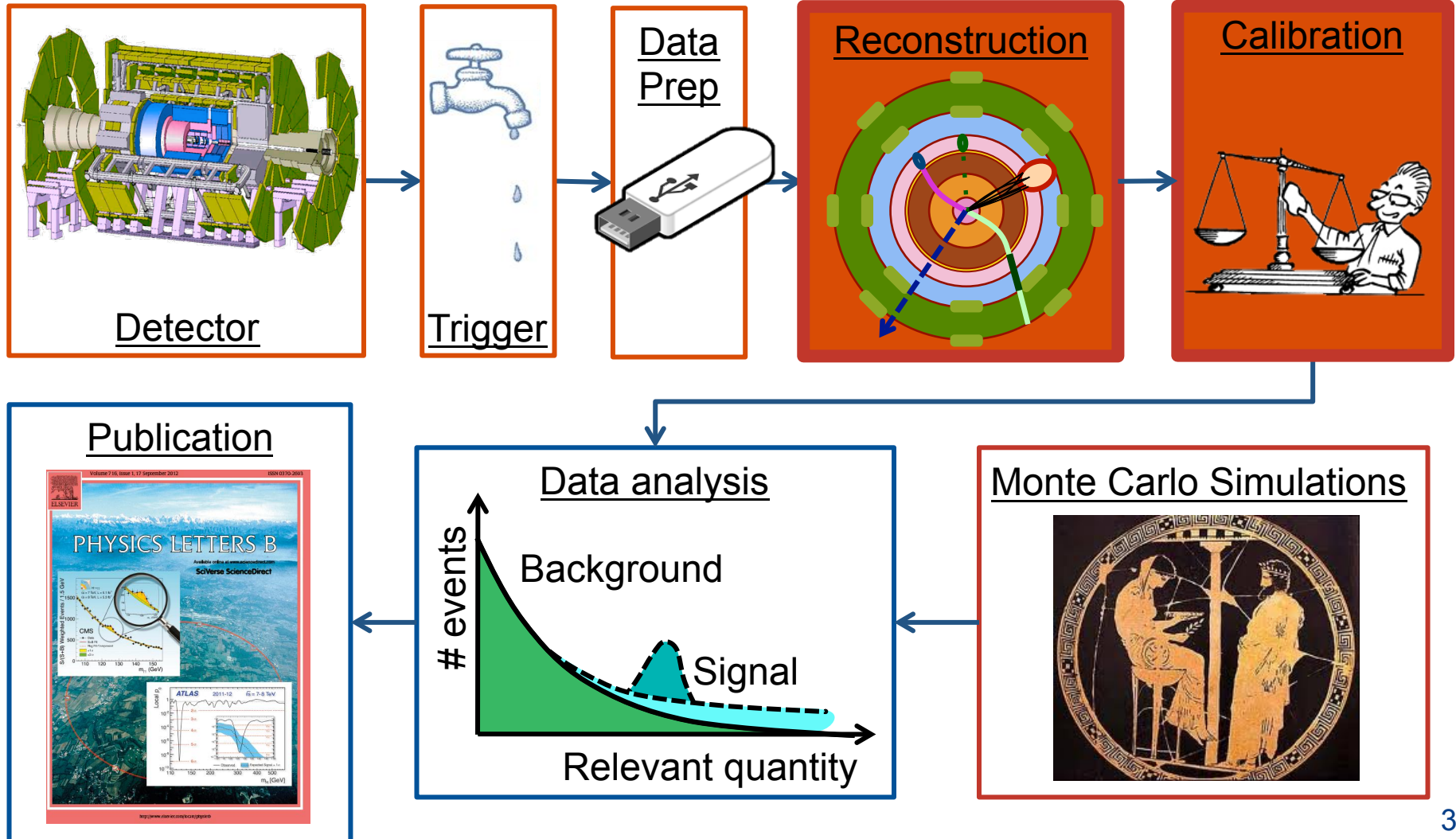

WHAT DO WE RECONSTRUCT

Simplified Detector Transverse View

Tracks and Clusters

Combining those:
“objects”
 (“particles”)

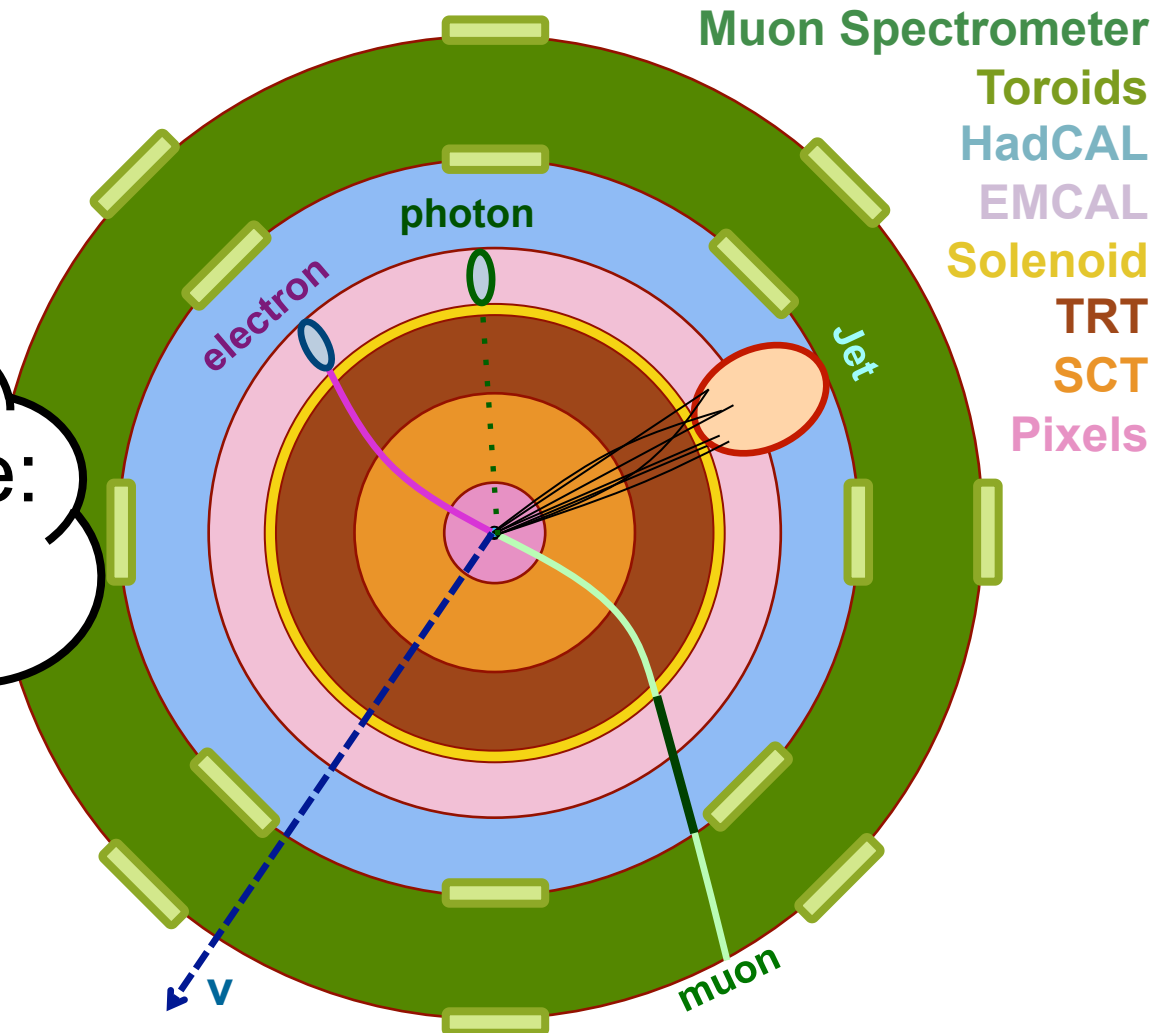

RECONSTRUCTION – FIGURES OF MERIT

“true” quantity:
quantity at MC generator level.

	Definition	Example		Needs be:
Efficiency	how often do we reconstruct the object	tracking efficiency = (number of reconstructed tracks) / (number of true tracks)		High
Resolution	how accurately do we reconstruct the quantity	energy resolution = (measured energy – true energy) / (true energy)		Good
Fake rate	how often we reconstruct a different object as the object we are interested in	a jet faking an electron, fake rate = (Number of jets reconstructed as an electron) / (Number of jets)		Low

RECONSTRUCTION – GOALS

- ⊙ High efficiency.
- ⊙ Good resolution.
- ⊙ Low fake rate.
- ⊙ Robust against detector problems and data-taking conditions.
 - ⊙ Noise.
 - ⊙ Dead regions of the detector.
 - ⊙ Increased pile-up.
- ⊙ Computing-friendly. →
 - ⊙ CPU time per event.
 - ⊙ Memory use.

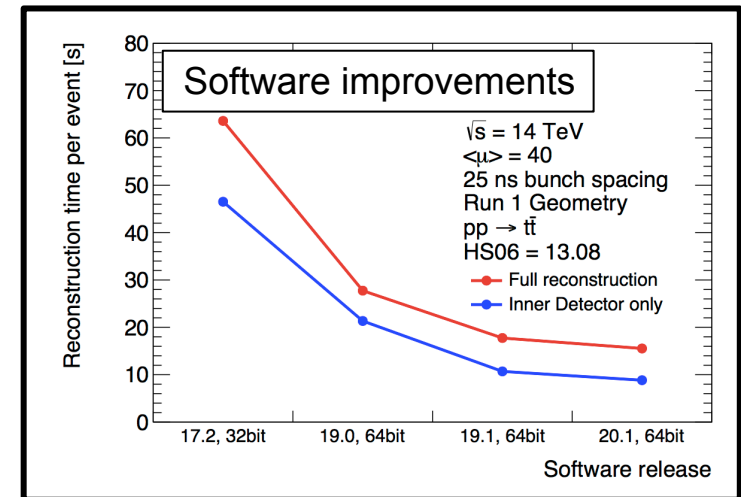
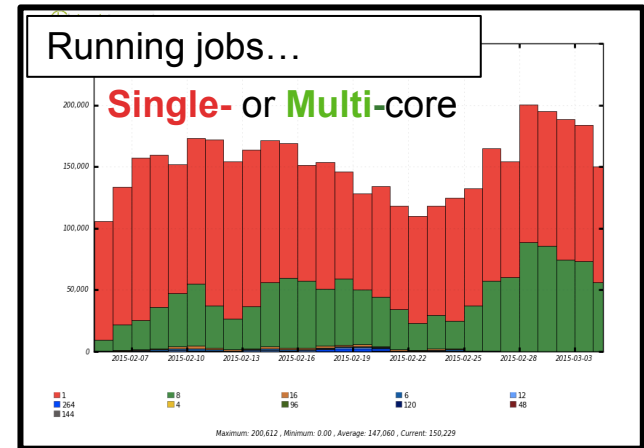
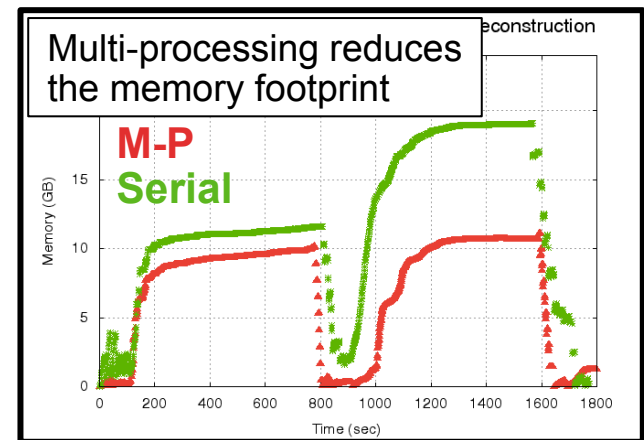

WHY DO WE NEED THE MAGNETIC FIELD?

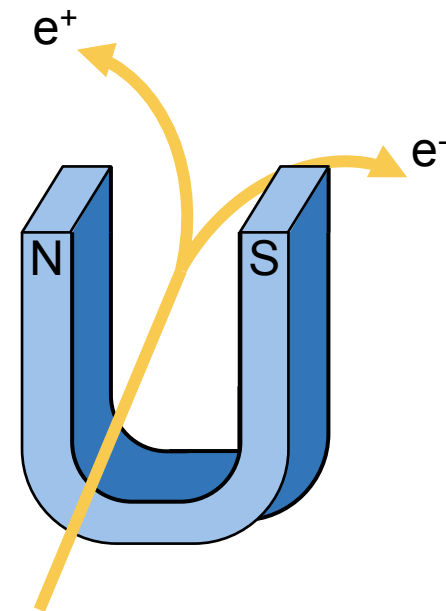
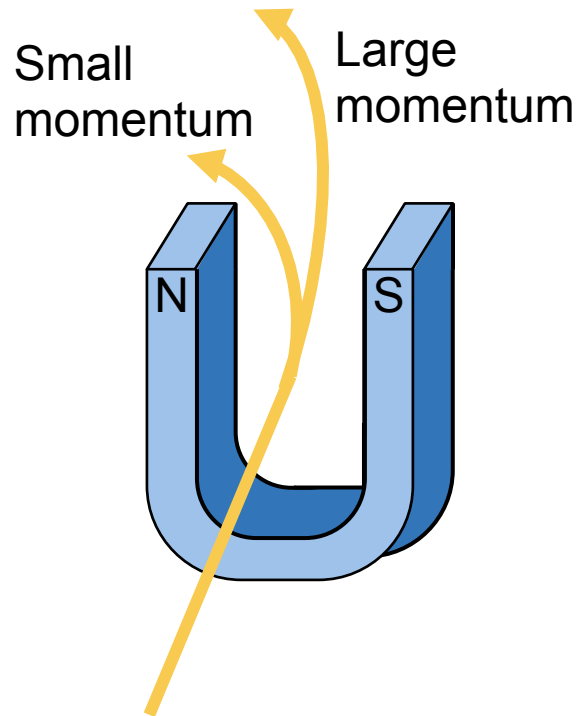

WHAT DO WE RECONSTRUCT

Tracks and Clusters

Simplified Detector Transverse View

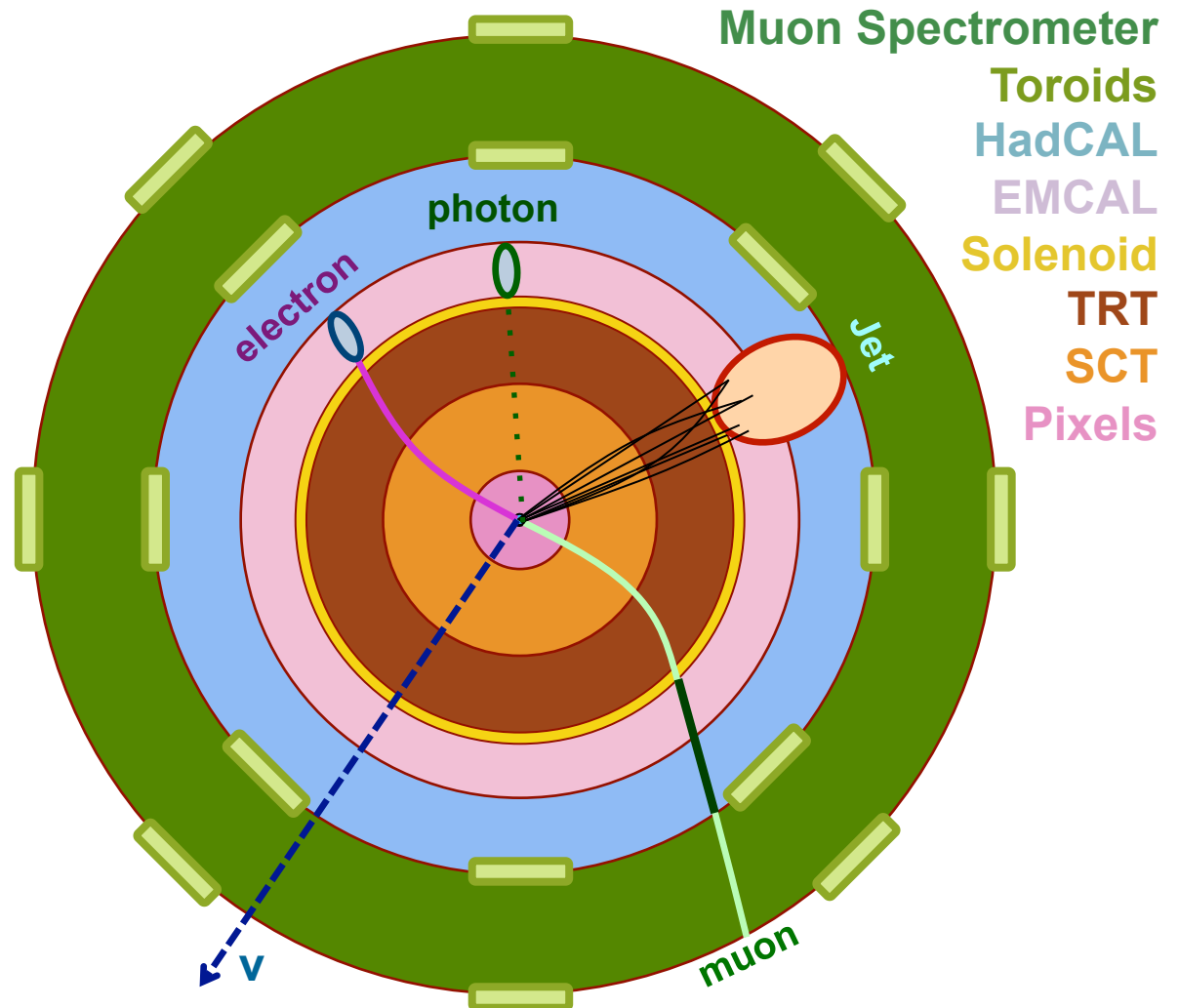

TRACKING IN A NUTSHELL

⊙ A track represents a measurement of a charged particle that leaves a trajectory as it passes through the detector.

⊙ For a track we measure:

- ⊙ Its momentum;
- ⊙ It's direction;
- ⊙ Its charge;
- ⊙ Its “perigee”: the closest point to a reference line, transverse (d_0) or longitudinal (z_0).

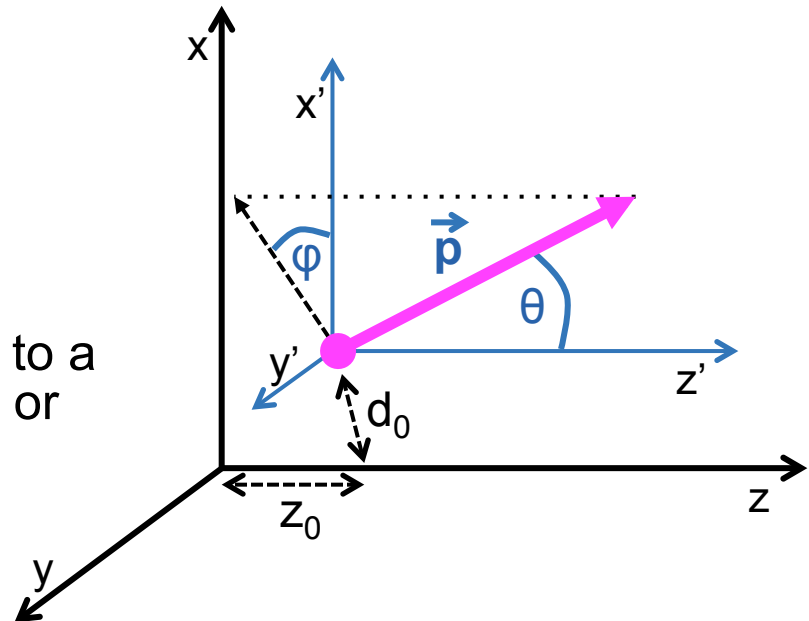

⊙ Tracks are key ingredients of most of particle reconstruction.

TRACKING IN A NUTSHELL – TRACK FITTING

© Perfect measurement – ideal

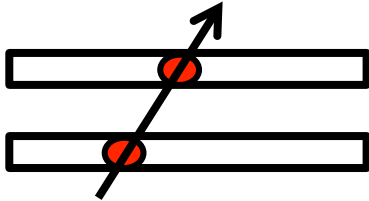

TRACKING IN A NUTSHELL – TRACK FITTING

© Perfect measurement – ideal

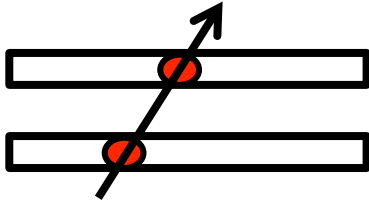

© Imperfect measurement – reality

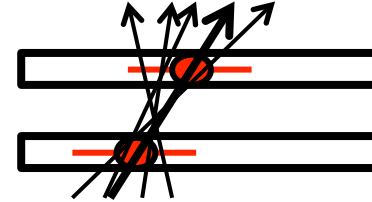

TRACKING IN A NUTSHELL – TRACK FITTING

⊙ Perfect measurement – ideal

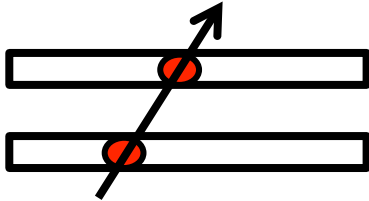

⊙ Imperfect measurement – reality

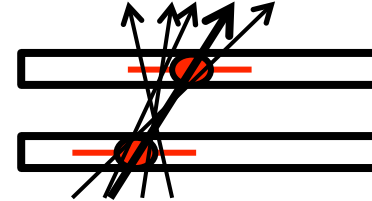

⊙ Small errors and more points help to constrain the possibilities

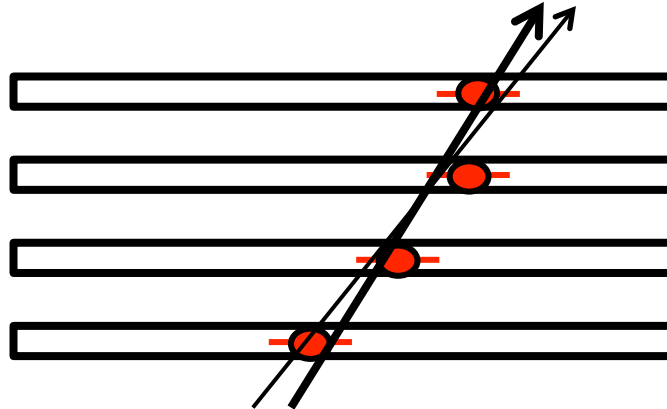

TRACKING IN A NUTSHELL – TRACK FITTING

⊙ Perfect measurement – ideal

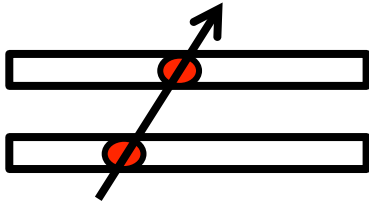

⊙ Imperfect measurement – reality

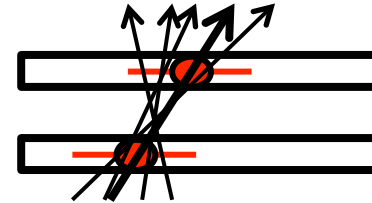

⊙ Small errors and more points help to constrain the possibilities

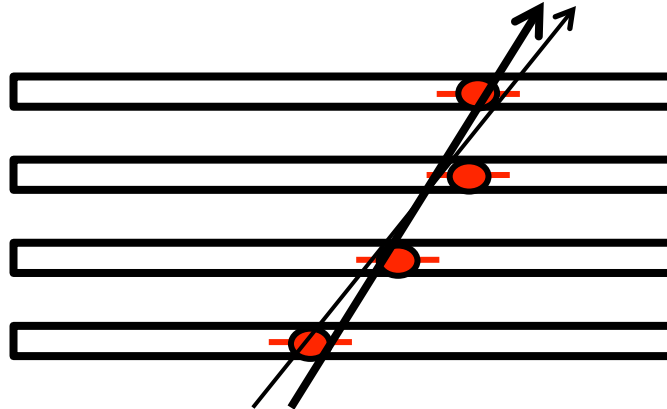

⊙ Quantitatively:

- ⊙ Parameterize the track;
- ⊙ Find parameters by Least-Squares-Minimization;
- ⊙ Obtain also uncertainties on the track parameters.

TRACKING IN A NUTSHELL – TRACK FITTING

⊙ For a track we measure:

- ⊙ Its momentum;
- ⊙ It's direction;
- ⊙ Its charge;
- ⊙ Its “perigee”: the closest point to a reference line, transverse (d_0) or longitudinal (z_0).

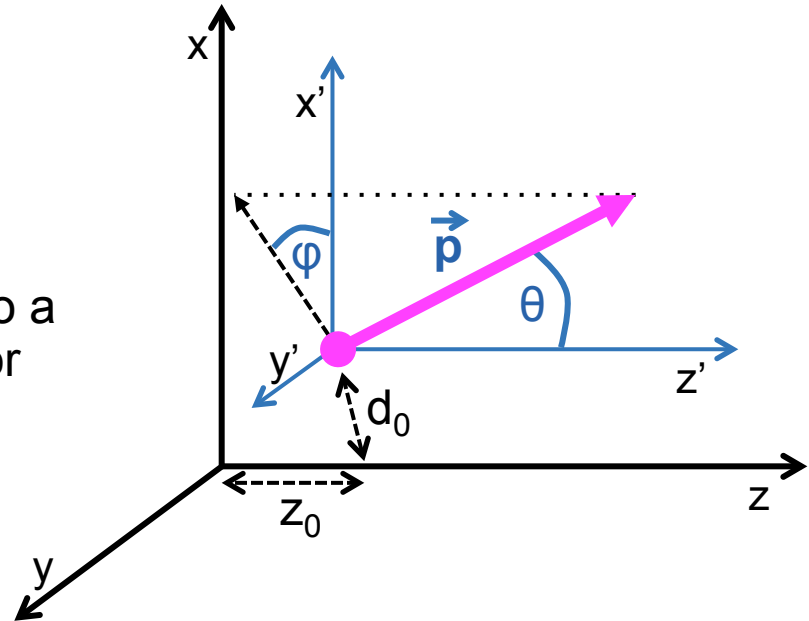

TRACKING IN A NUTSHELL – TRACK FITTING

⊙ For a track we measure:

- ⊙ Its momentum;
- ⊙ It's direction;
- ⊙ Its charge;
- ⊙ Its “perigee”: the closest point to a reference line, transverse (d_0) or longitudinal (z_0).
- ⊙ **And their uncertainties!**

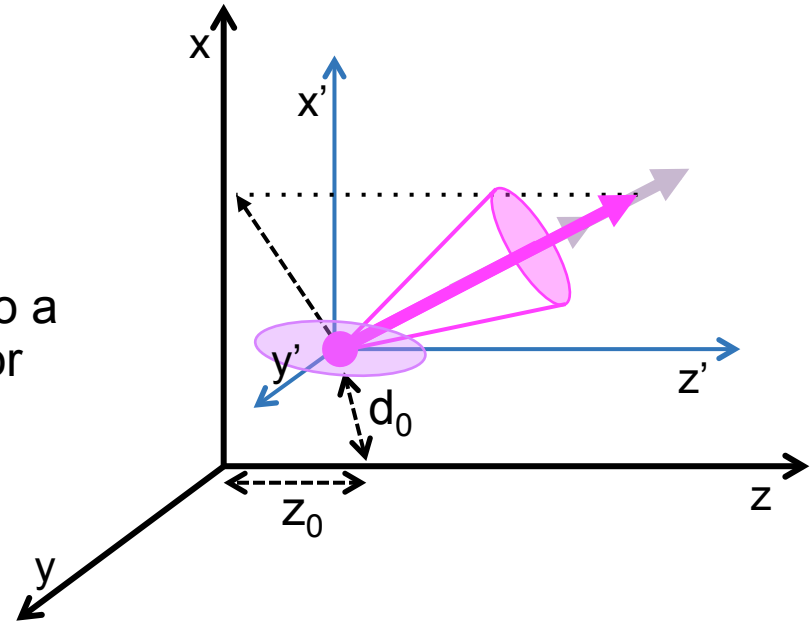

⊙ Small uncertainties are required.

- ⊙ δd_0 is $O(10\mu\text{m})$ and $\delta\theta$ $O(0.1\text{mrad})$.
- ⊙ Allows separation of tracks that come from different particle decays (which can be separated at the order of mm).

TRACKING – THE UNCERTAINTIES

⊙ Presence of Material

- ⊙ Coulomb scattering off the core of atoms
- ⊙ Energy loss due to ionization
- ⊙ Bremsstrahlung
- ⊙ Hadronic interaction

TRACKING – THE UNCERTAINTIES

⊙ Presence of Material

- ⊙ Coulomb scattering off the core of atoms
- ⊙ Energy loss due to ionization
- ⊙ Bremsstrahlung
- ⊙ Hadronic interaction

⊙ Misalignment

- ⊙ Detector elements not positioned in space with perfect accuracy.
- ⊙ Alignment corrections derived from data and applied in track reconstruction.

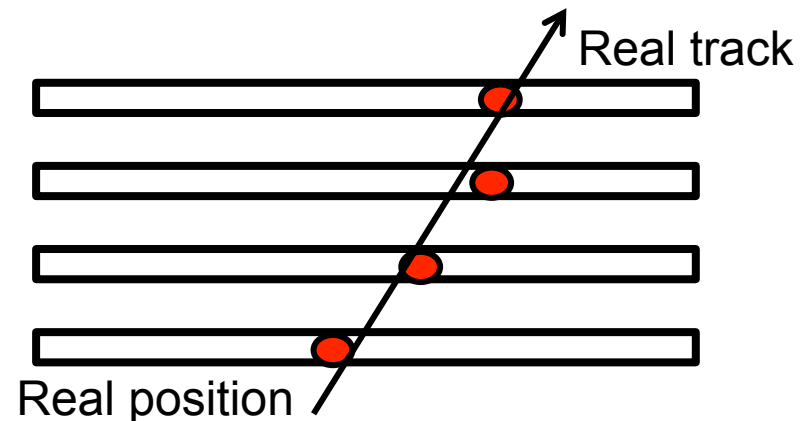

TRACKING – THE UNCERTAINTIES

⊙ Presence of Material

- ⊙ Coulomb scattering off the core of atoms
- ⊙ Energy loss due to ionization
- ⊙ Bremsstrahlung
- ⊙ Hadronic interaction

⊙ Misalignment

- ⊙ Detector elements not positioned in space with perfect accuracy.
- ⊙ Alignment corrections derived from data and applied in track reconstruction.

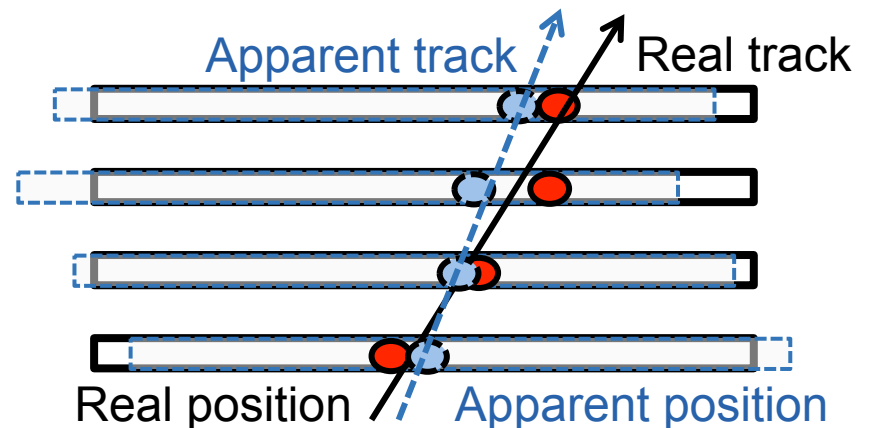

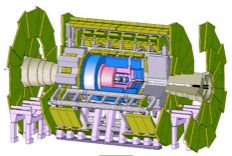

DAQ

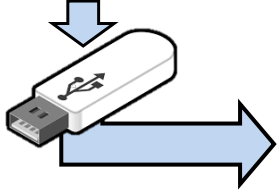

THE EVENT AT TIER0

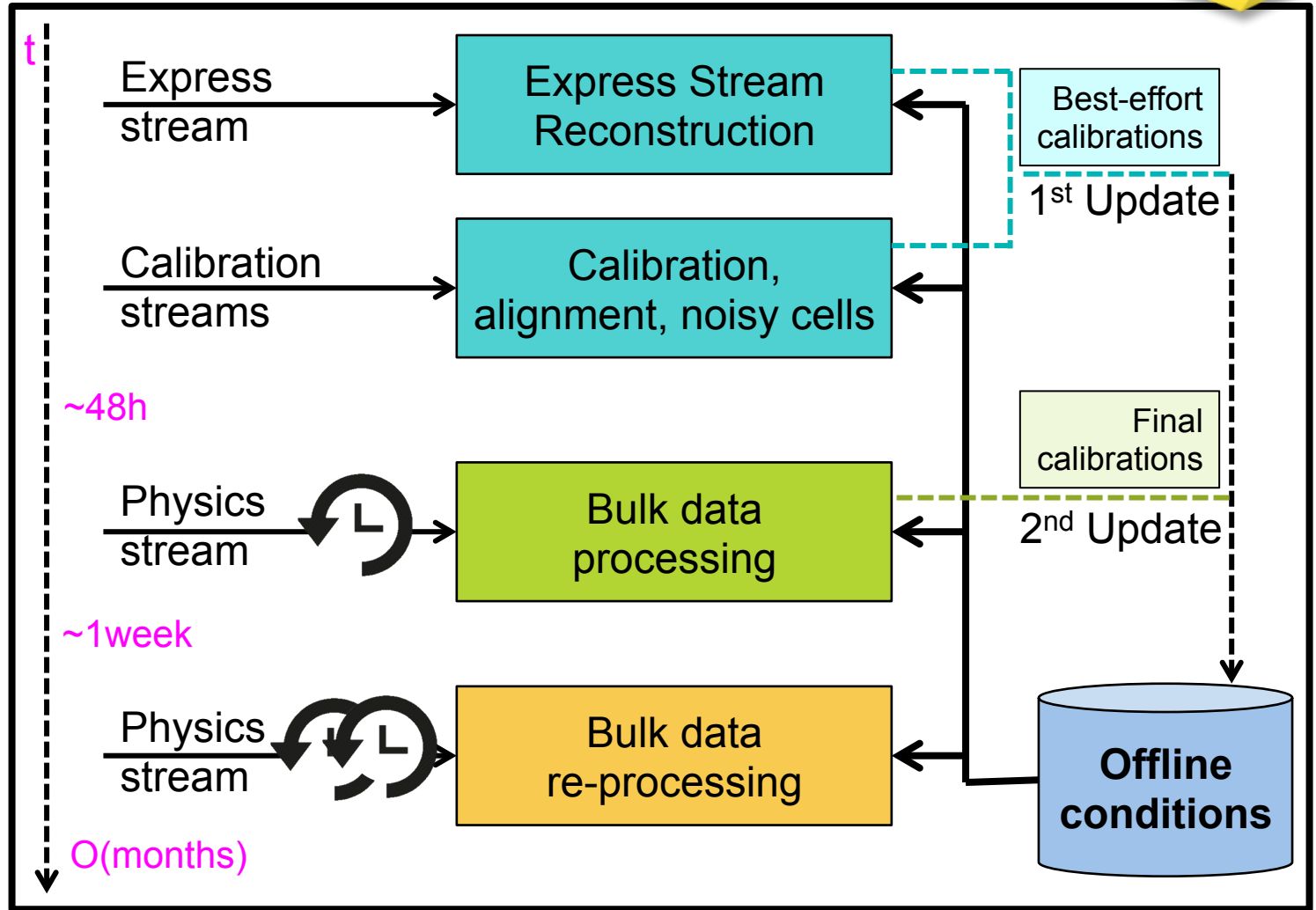

IMPACT OF GOOD ALIGNMENT

- © Improving the tracker alignment description in the reconstruction gives better track momentum resolution which leads to better mass resolution.

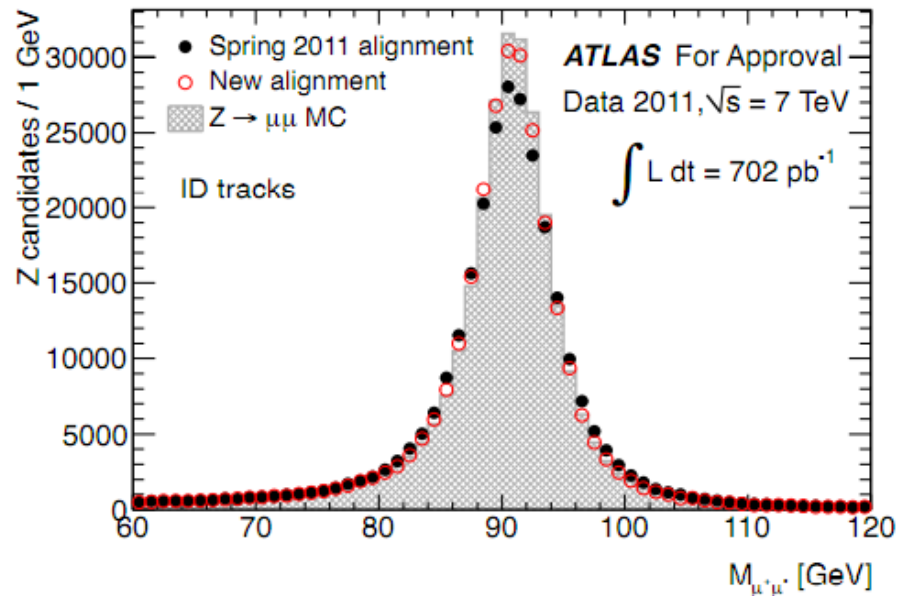

- © Can see the reconstructed Z width gets narrower if we use better alignment constants. Very important for physics analysis to have good alignment.
- © Alignment of detector elements can change with time, for example when the detector is opened for repair, or when the magnetic field is turned on and off.

IMPACT OF GOOD ALIGNMENT

- © Improving the tracker alignment description in the reconstruction gives better track momentum resolution which leads to better mass resolution.

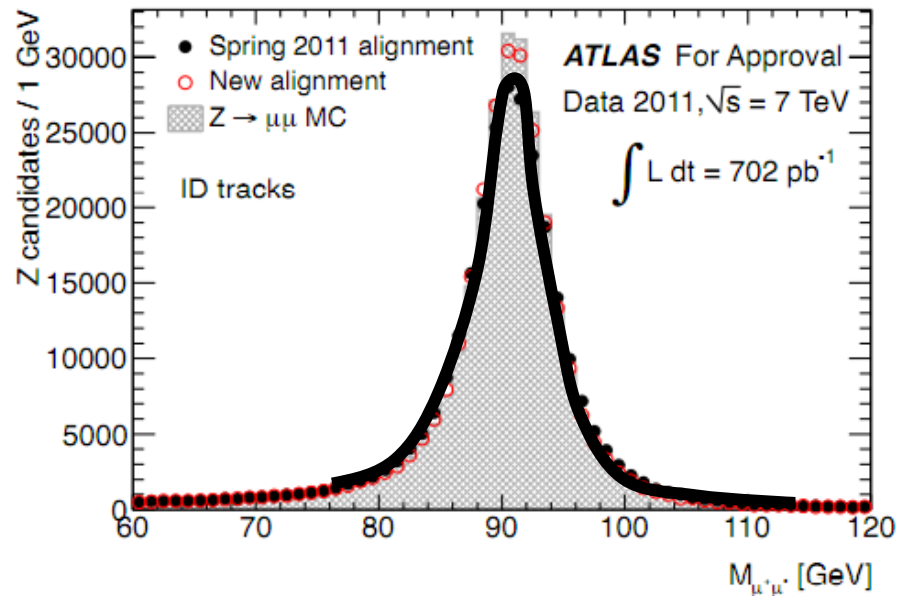

- © Can see the reconstructed Z width gets narrower if we use better alignment constants. Very important for physics analysis to have good alignment.
- © Alignment of detector elements can change with time, for example when the detector is opened for repair, or when the magnetic field is turned on and off.

IMPACT OF GOOD ALIGNMENT

- © Improving the tracker alignment description in the reconstruction gives better track momentum resolution which leads to better mass resolution.

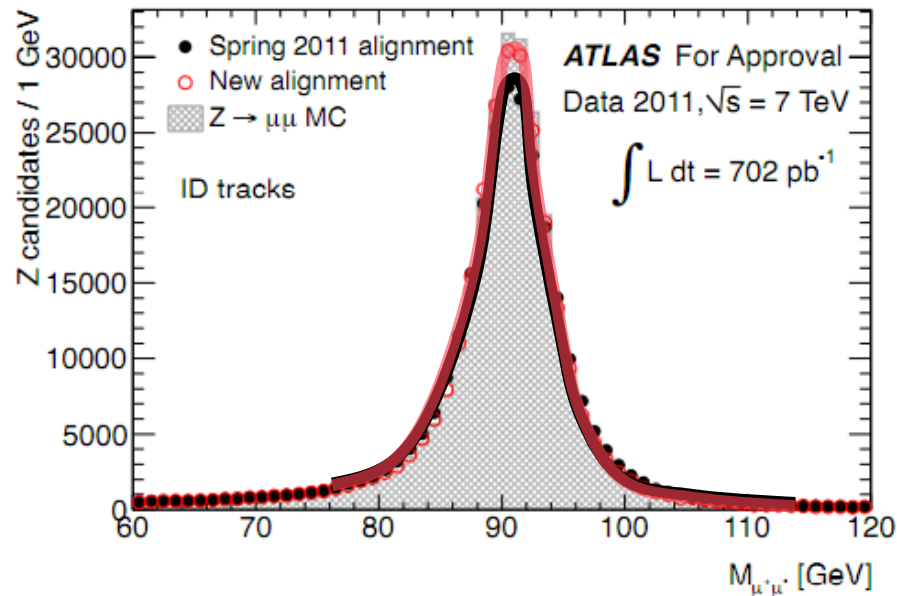

- © Can see the reconstructed Z width gets narrower if we use better alignment constants. Very important for physics analysis to have good alignment.
- © Alignment of detector elements can change with time, for example when the detector is opened for repair, or when the magnetic field is turned on and off.

WHAT DO WE RECONSTRUCT

Tracks and
Clusters

Simplified Detector Transverse View

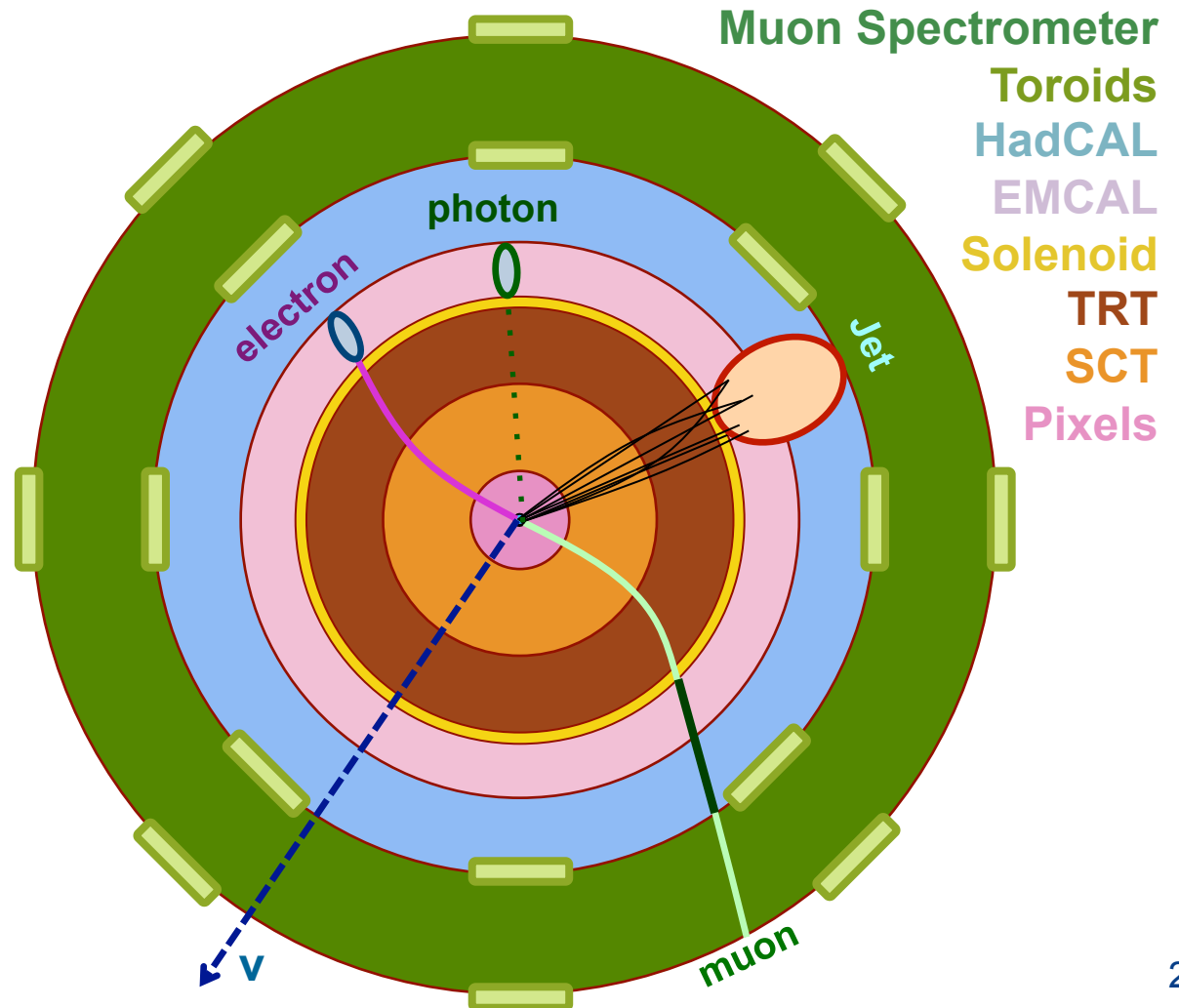

A CALORIMETER VIEW

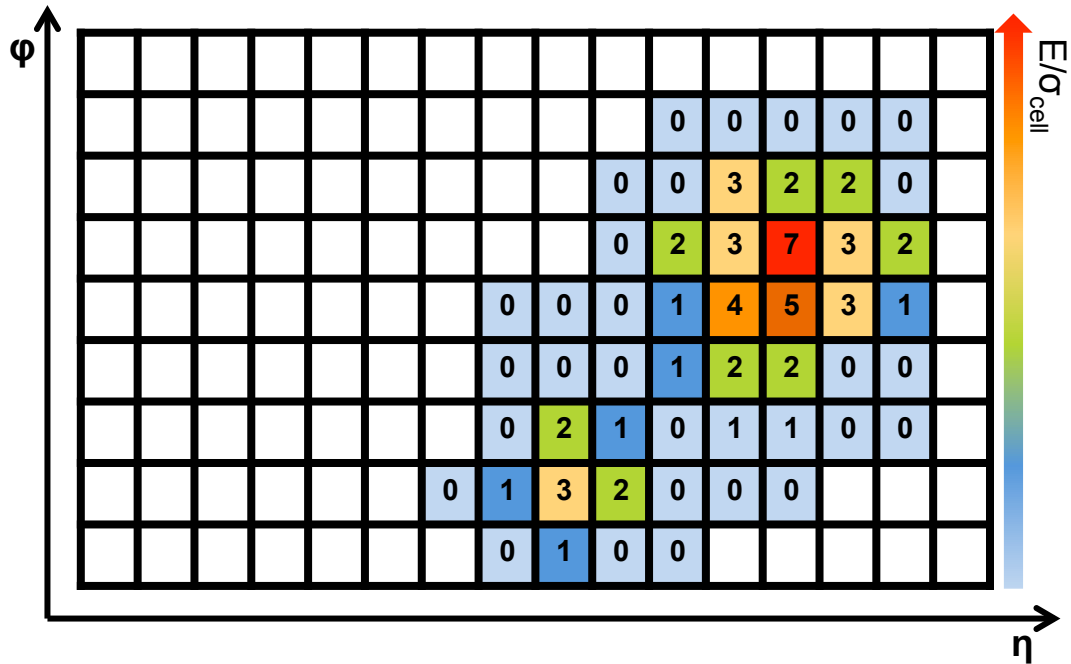

CLUSTERING IN A NUTSHELL

- ⊙ **Reconstruct energy deposited in the calorimeter by charged or neutral particles; electrons, photons and jets.**
- ⊙ **For a cluster we measure:**
 - ⊙ The energy;
 - ⊙ The position of the deposit;
 - ⊙ The direction of the incident particles;
- ⊙ **Calorimeters are segmented in cells.**
 - ⊙ Typically a shower created by a particle interacting with the matter extends over several cells.
- ⊙ **Various clustering algorithms, e.g.:**
 - ⊙ **Sliding window.** Sum cells within a fixed-size rectangular window.
 - ⊙ **Topo-clustering.** Start with a seed cell and iteratively add to the cluster the neighbor of a cell already in the cluster.

CLUSTER FINDING – AN EXAMPLE

CMS crystal calorimeter – ECAL clusters

© electron energy in central crystal ~80%,
in 5x5 matrix around it ~96%.

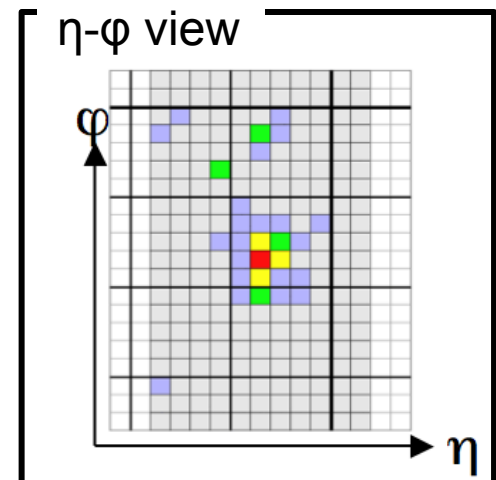
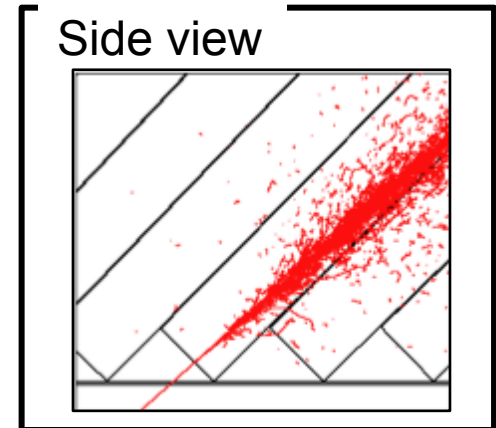
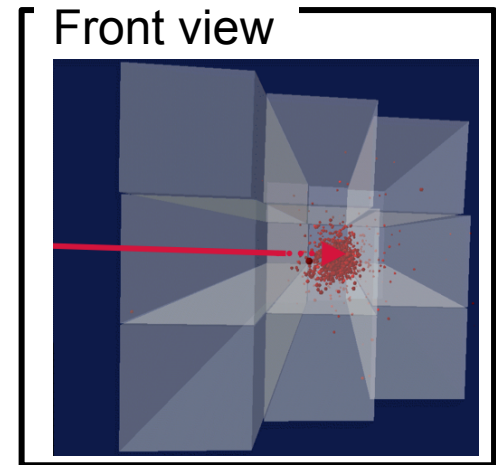
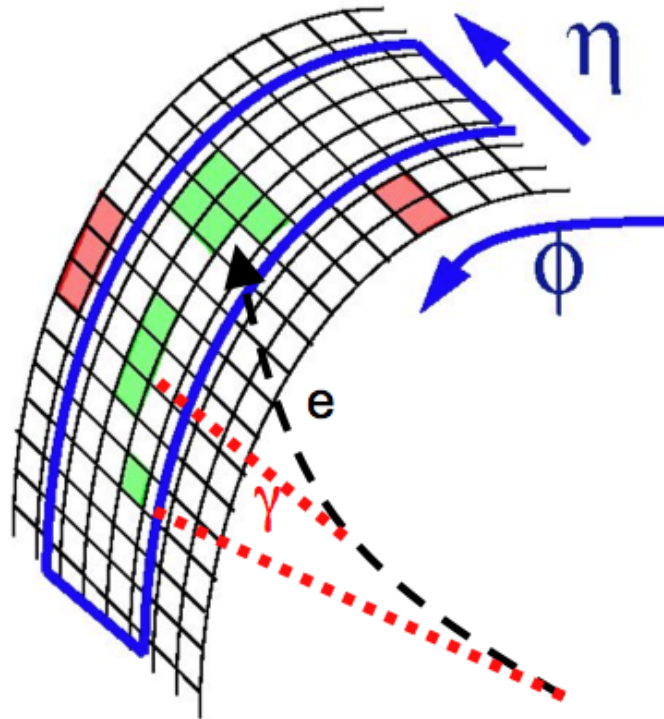

CLUSTER FINDING

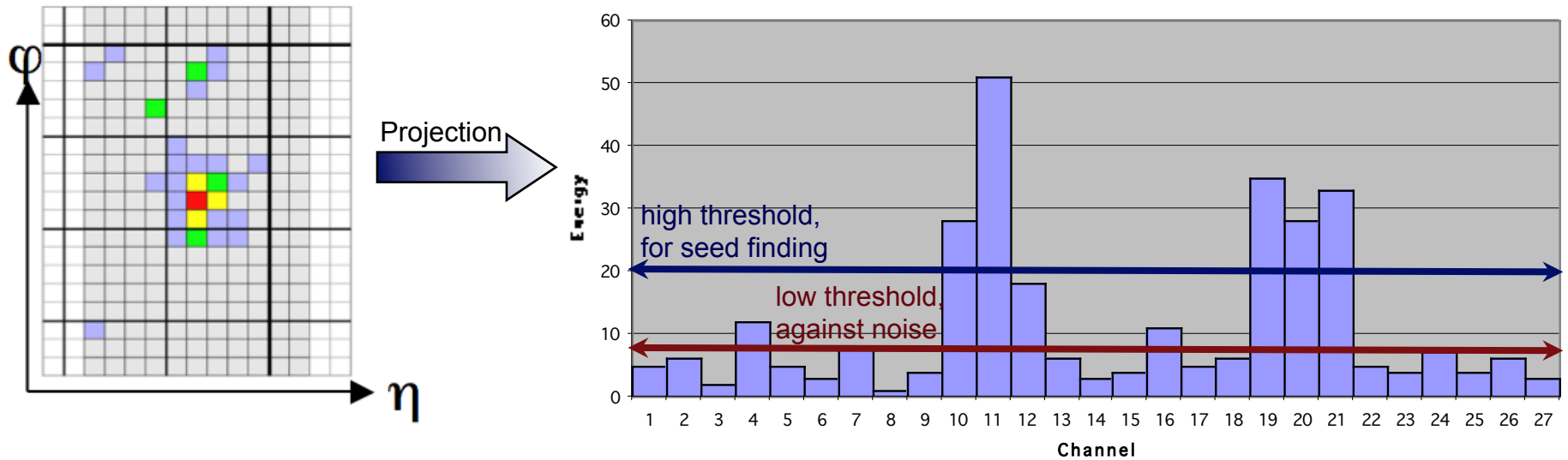

Simple example of an algorithm

- Scan for **seed** crystals = local energy maximum above a defined **seed threshold**
- Starting from the seed position, adjacent crystals are examined, scanning first in φ and then in η
- Along each scan line, crystals are added to the cluster if
 1. The crystal's energy is above the **noise level (lower threshold)**
 2. The crystal has not been assigned to another cluster already

DIFFICULTIES

- Careful **tuning of thresholds** needed.
 - needs usually learning phase;
 - adapt to noise conditions;
 - **too low** : pick up too much unwanted energy;
 - **too high** : loose too much of “real” energy. Corrections/Calibrations will be larger.

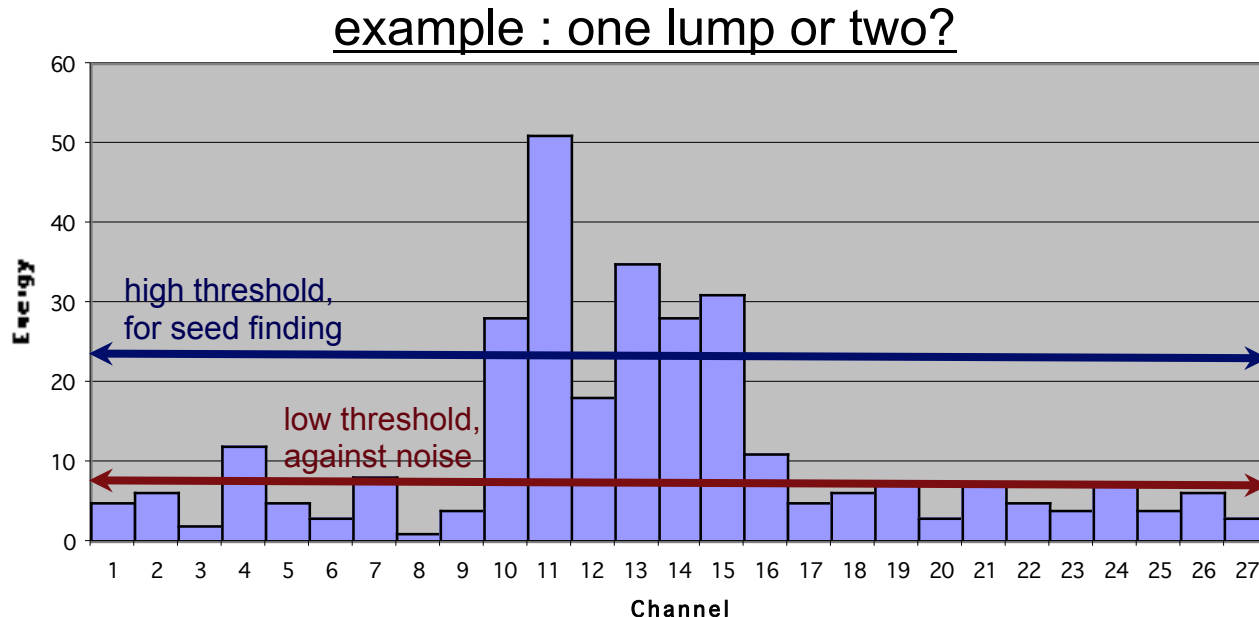

WHAT DO WE RECONSTRUCT

Simplified Detector Transverse View

Tracks and Clusters

Combining those:
“objects”
 (“particles”)

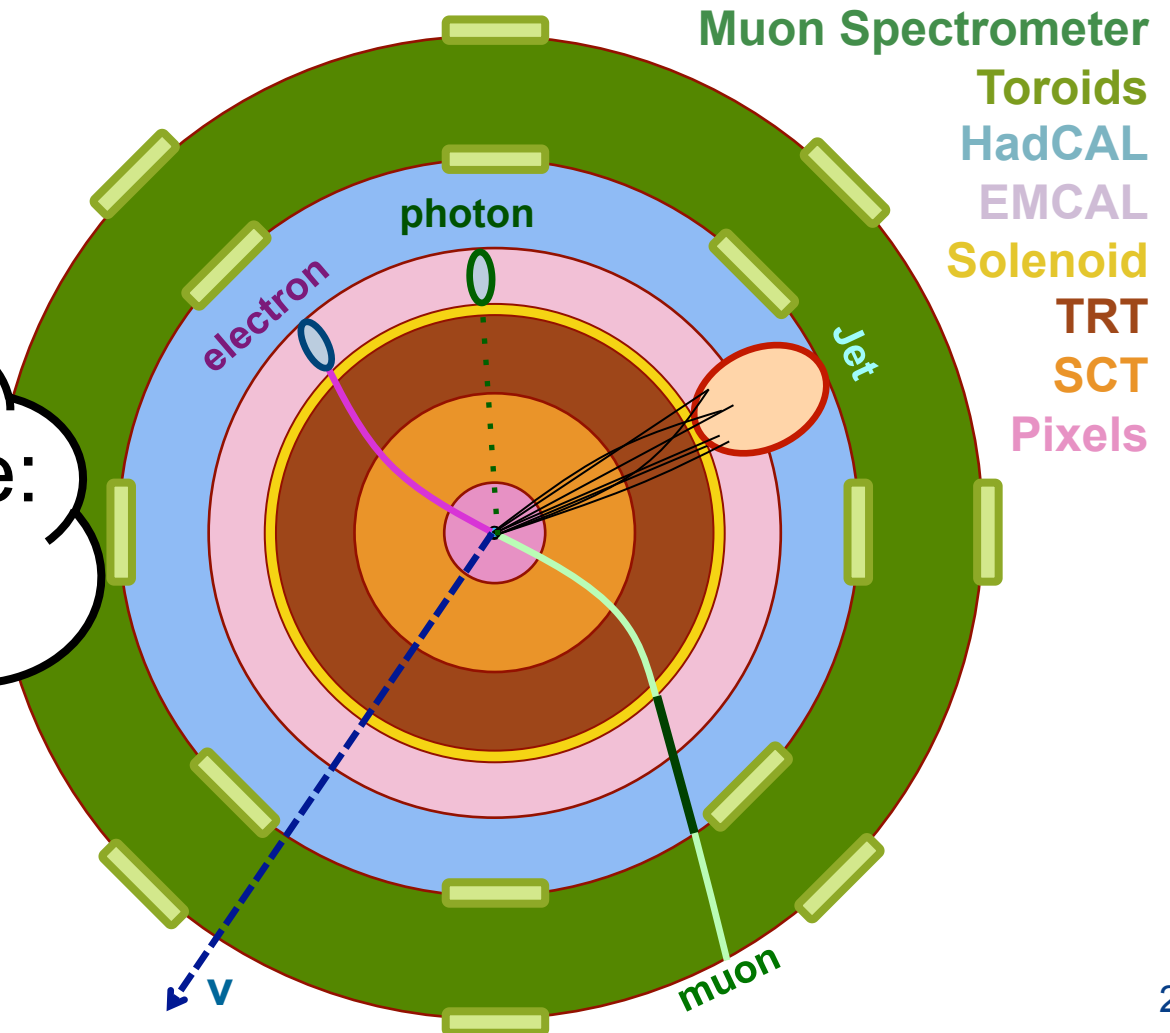

WHAT DO WE RECONSTRUCT

Simplified Detector Transverse View

Tracks and Clusters

Combining those:
“objects”
 (“particles”)

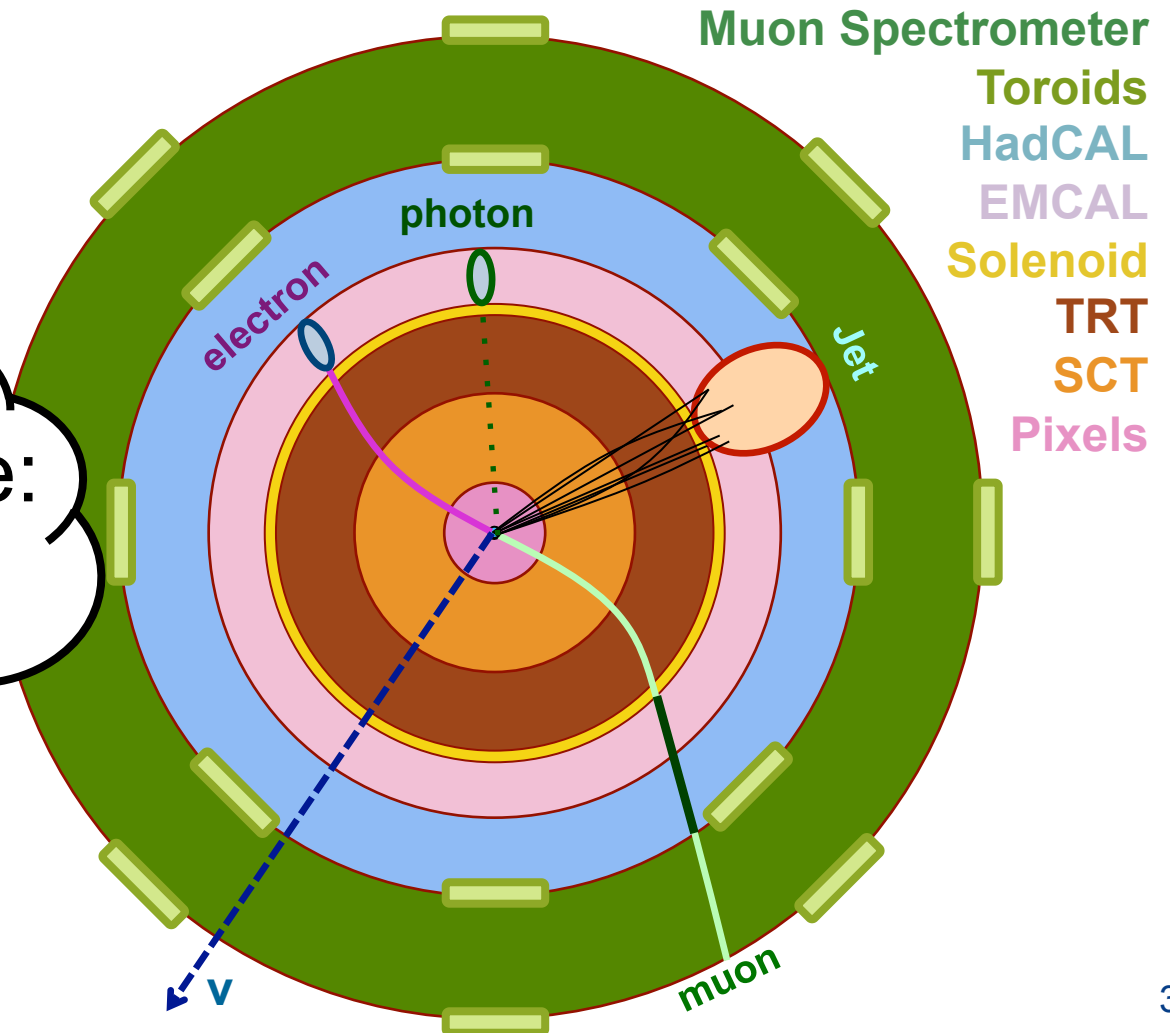

	I	II	III	
Quarks	2.4 MeV u	1.3 GeV c	170 GeV t	0 γ
	4.8 MeV d	104 MeV s	4.2 GeV b	0 g
	< 2 eV ν_1	< 2 eV ν_2	< 2 eV ν_3	91 GeV Z
Leptons	0.5 MeV e	16 MeV μ	1.8 GeV τ	80 GeV W
				126 GeV H
				Bosons

ELECTRONS / PHOTONS

- ⊙ Final Electron momentum measurement can come from tracking or calorimeter information (or a combination of both).
 - ⊙ Often have a final calibration to give the best electron energy.
- ⊙ Often want “isolated electrons”.
 - ⊙ Require little calorimeter energy or tracks in the region around the electron.

Simplified Detector Transverse View

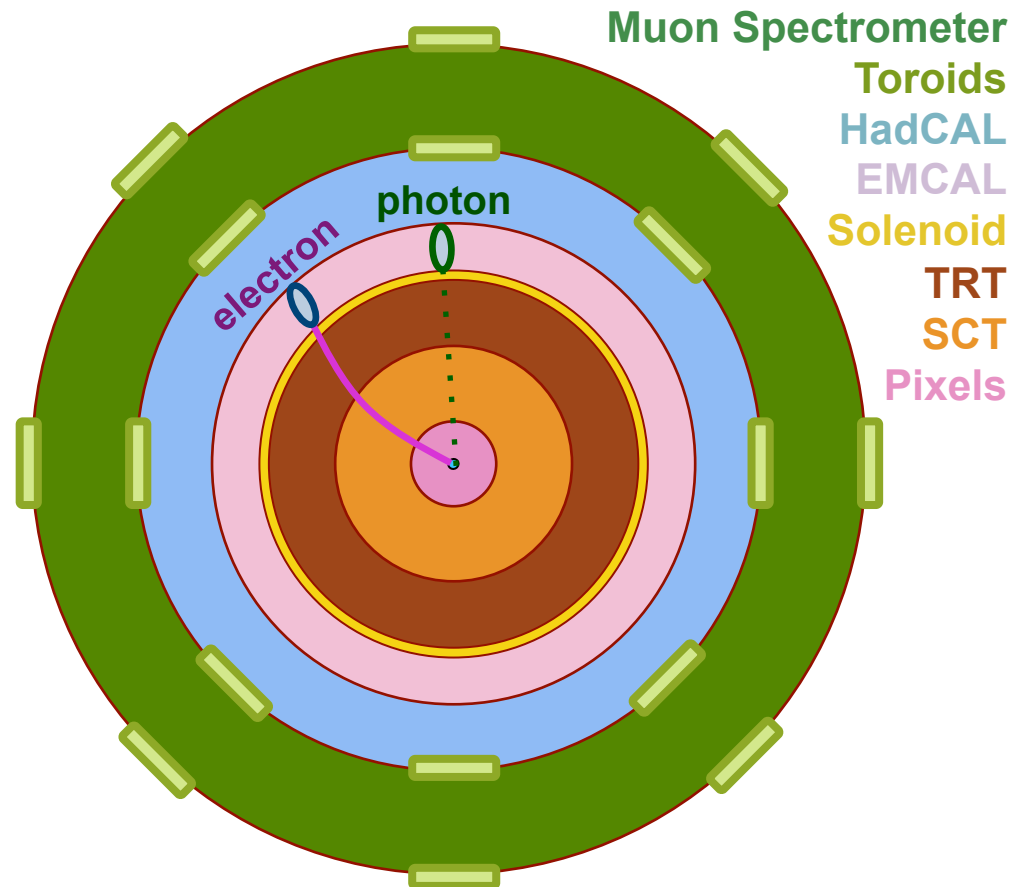

ELECTRONS / PHOTONS

- ⊙ Final Electron momentum measurement can come from tracking or calorimeter information (or a combination of both).
 - ⊙ Often have a final calibration to give the best electron energy.
- ⊙ Often want “isolated electrons”.
 - ⊙ Require little calorimeter energy or tracks in the region around the electron.

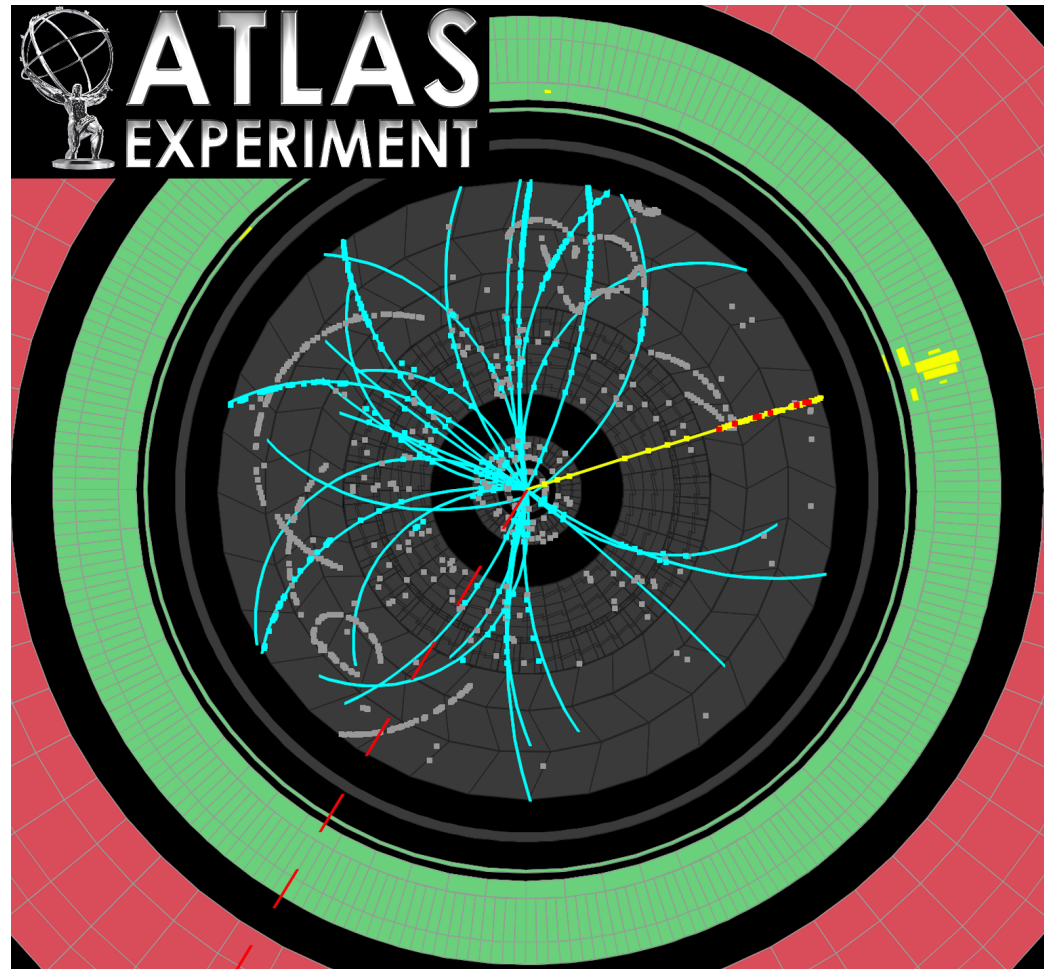

ELECTRONS / PHOTONS (BGRS)

- ⊙ Hadronic jets leave energy in the calorimeter which can fake electrons or photons.
- ⊙ Usually a Jet produces energy in the hadronic calorimeter as well as the electromagnetic calorimeter.
- ⊙ Usually the calorimeter cluster is much wider for jets than for electrons/photons.
- ⊙ So it should be “easy” to separate electrons from jets.
- ⊙ However have many thousands more jets than electrons, so need the rate of jets faking an electron to be very small $\sim 10^{-4}$.
- ⊙ Need complex identification algorithms to give the rejection whilst keeping a high efficiency.

ELECTRONS / PHOTONS (BGRS)

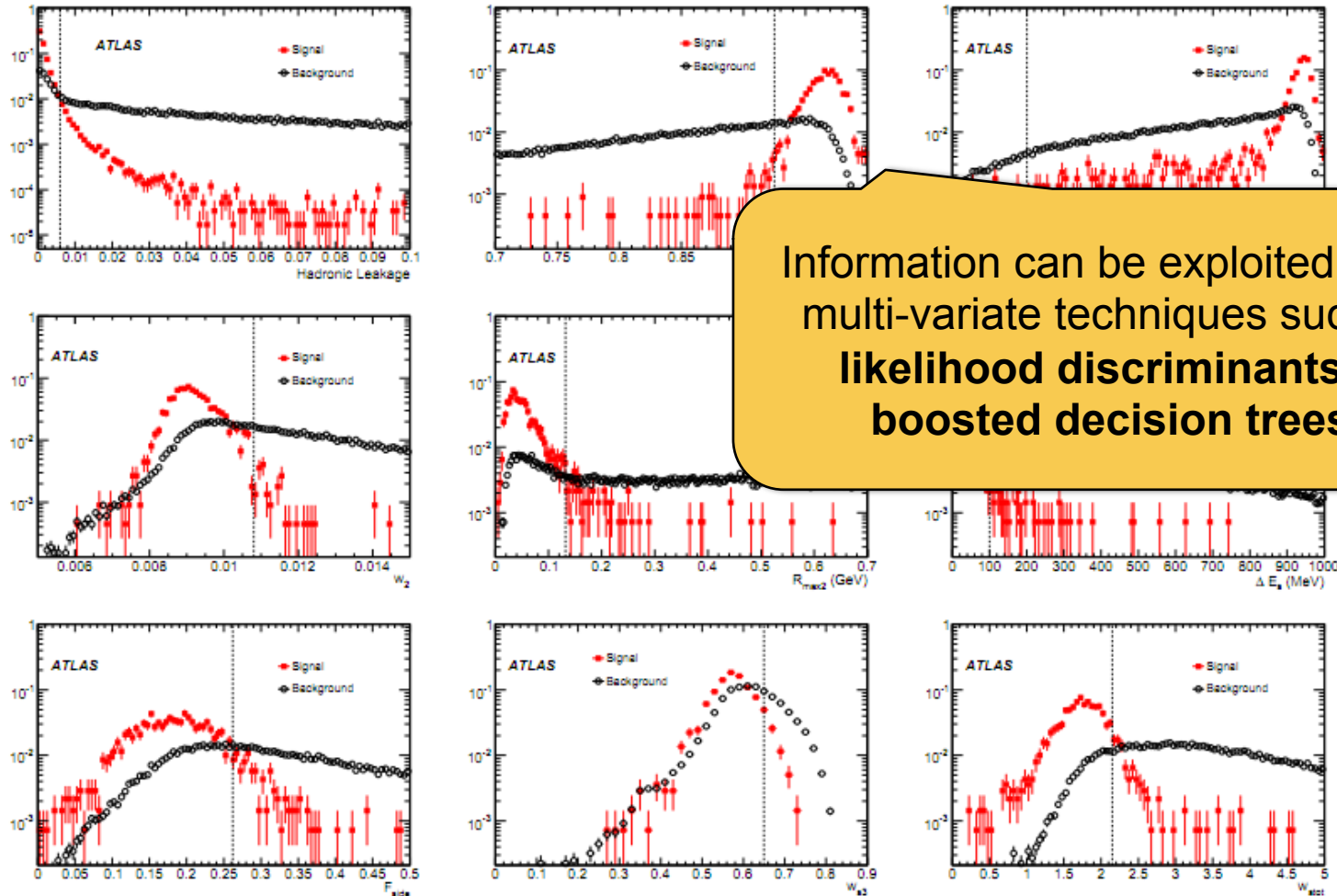

Information can be exploited using multi-variate techniques such as **likelihood discriminants** or **boosted decision trees**.

Example of different calorimeter shower shape variables used to distinguish electron showers from jets in ATLAS

MUONS

- **Combine the muon segments found in the muon detector with tracks from the tracking detector**
- **Momentum of muon determined from bending due to magnetic field in tracker and in muon system**
 - Combine measurements to get best resolution
 - Need an accurate map of the magnetic field in the reconstruction software
 - Alignment of the muon detectors also very important to get best momentum resolution

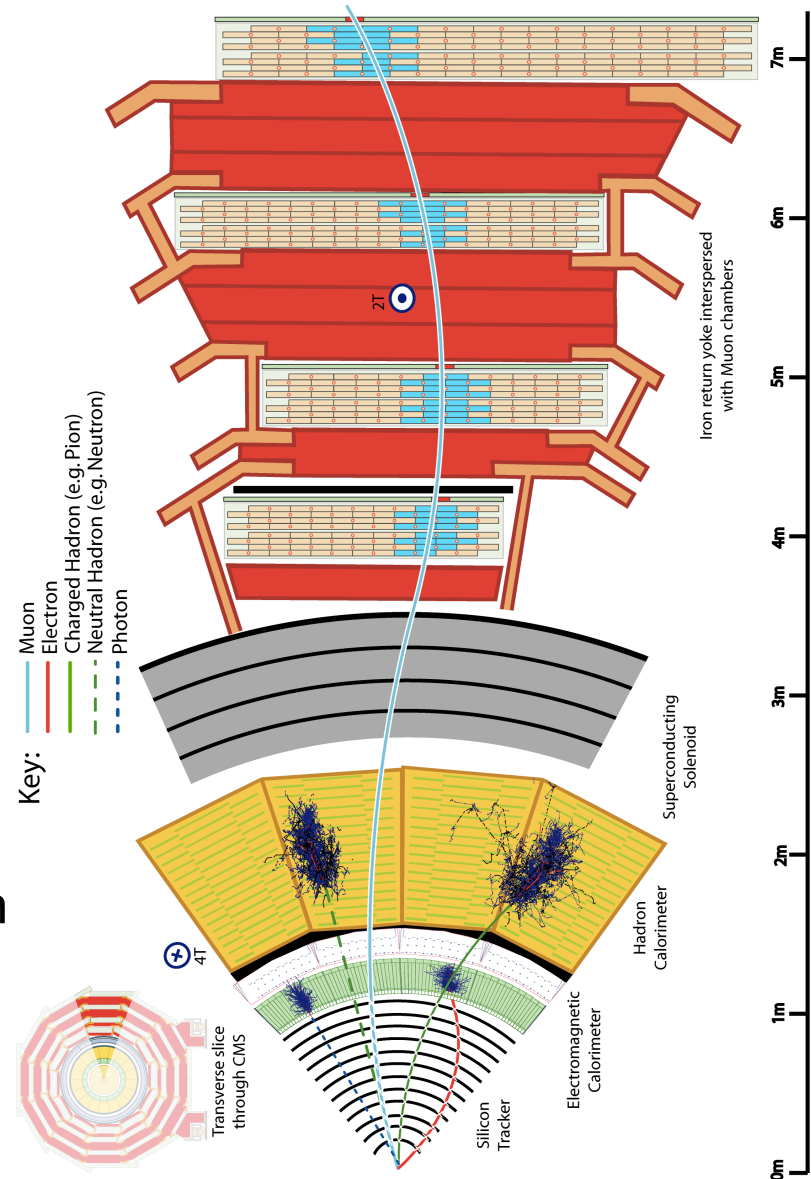

MUONS

- **Combine the muon segments found in the muon detector with tracks from the tracking detector**
- **Momentum of muon determined from bending due to magnetic field in tracker and in muon system**
 - Combine measurements to get best resolution
 - Need an accurate map of the magnetic field in the reconstruction software
 - Alignment of the muon detector also very important to get best momentum resolution

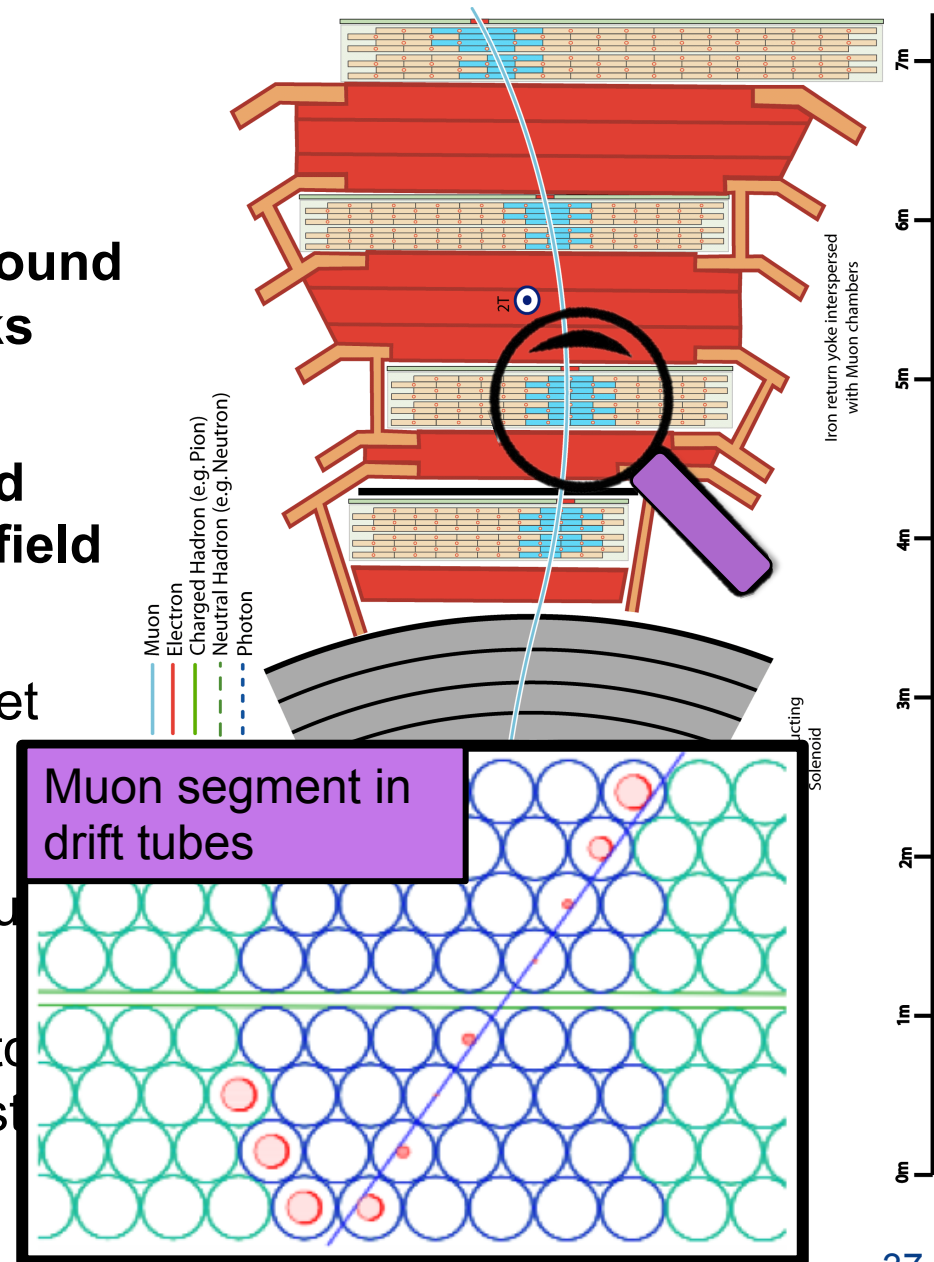

MUONS ON ATLAS

Simplified Detector Transverse View

“MS” { Muon Spectrometer

Toroids

“Calo” { HadCAL
EMCAL

Solenoid

“ID” { TRT
SCT
Pixels

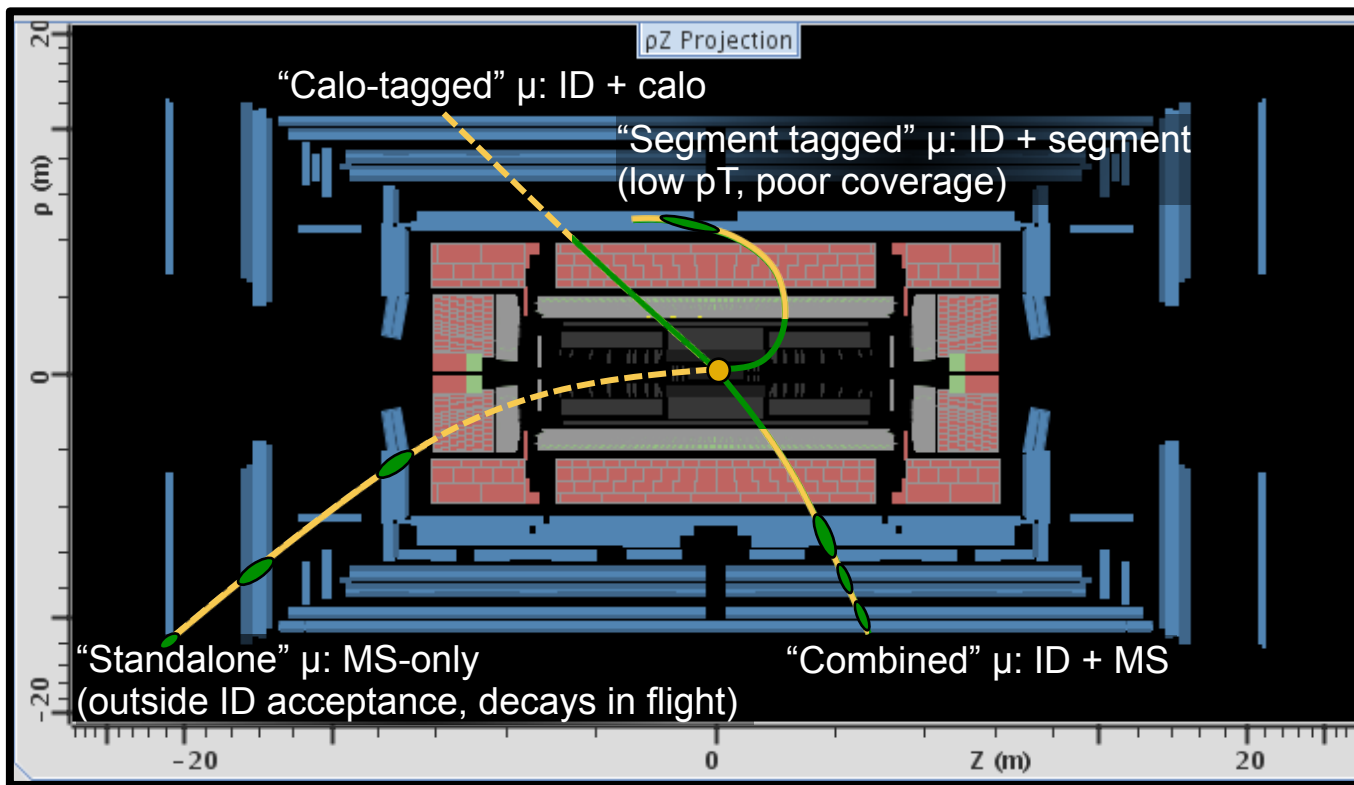

JETS

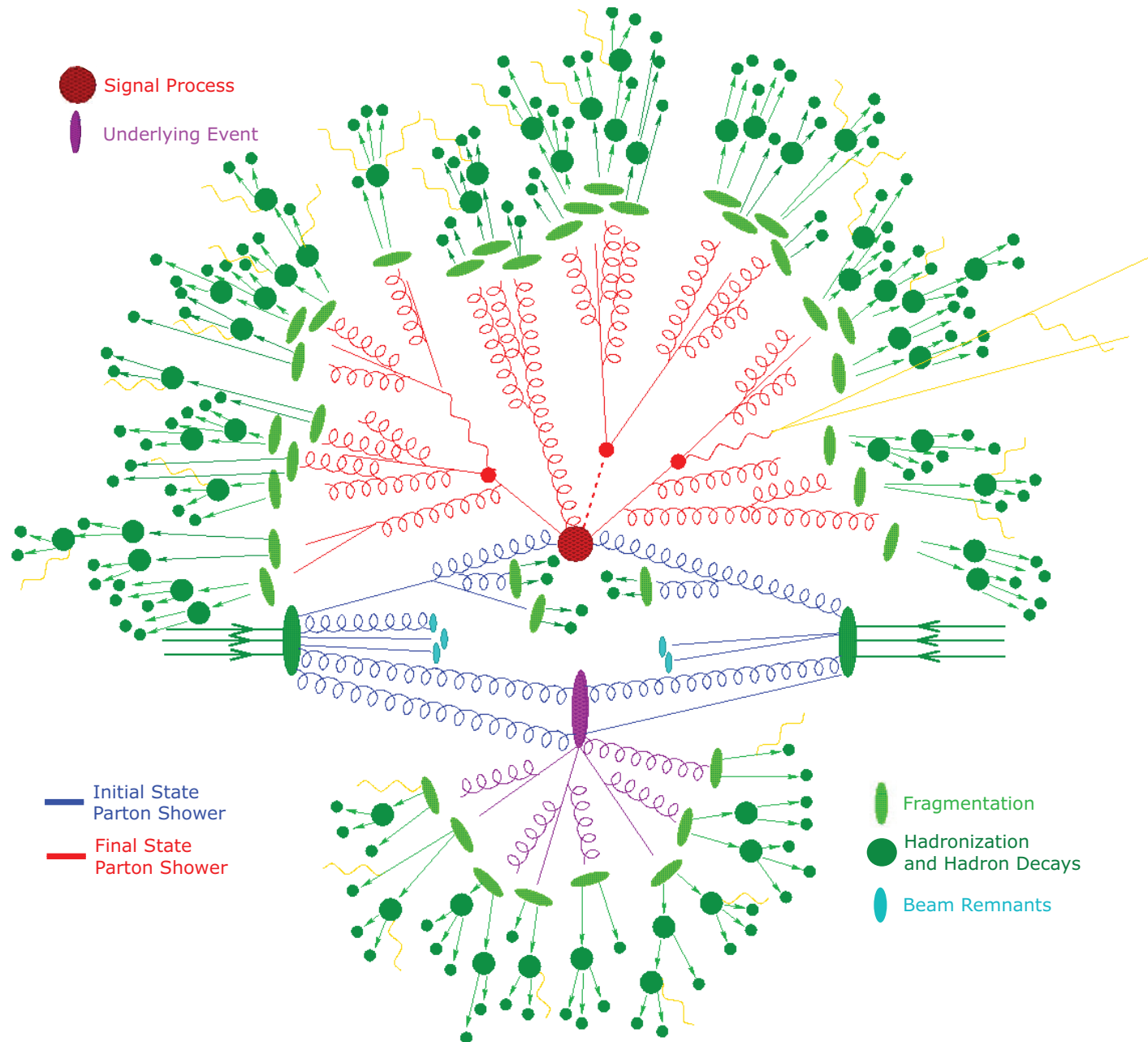

STANDARD MODEL PROCESSES

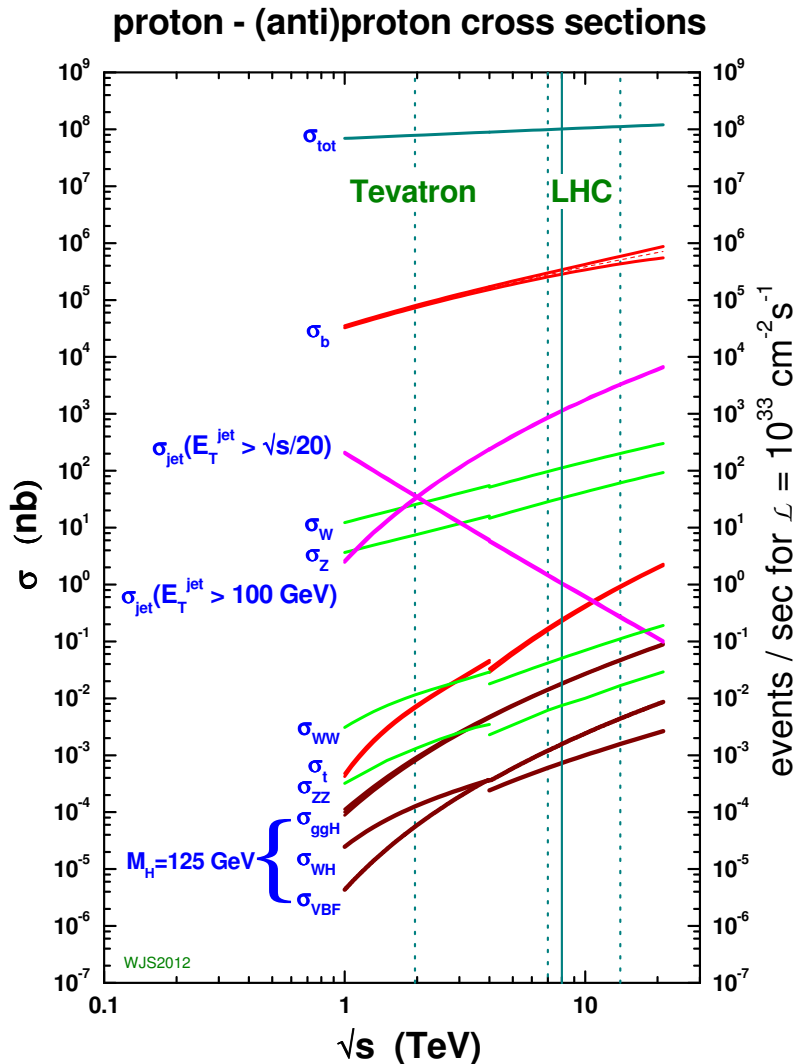

Jets are produced:

- ⊙ by fragmentation of gluons and (light) quarks in QCD scattering.
- ⊙ by decays of heavy Standard Model particles, e.g. W & Z.
- ⊙ in association with particle production in Vector Boson Fusion, e.g. Higgs.
- ⊙ in decays of beyond the Standard Model particles, e.g. in SUSY.

JETS

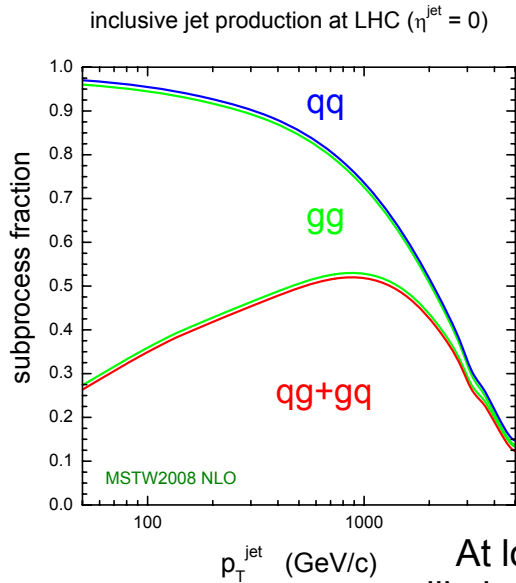

At low energy, jets are more likely produced by gluon fusion.

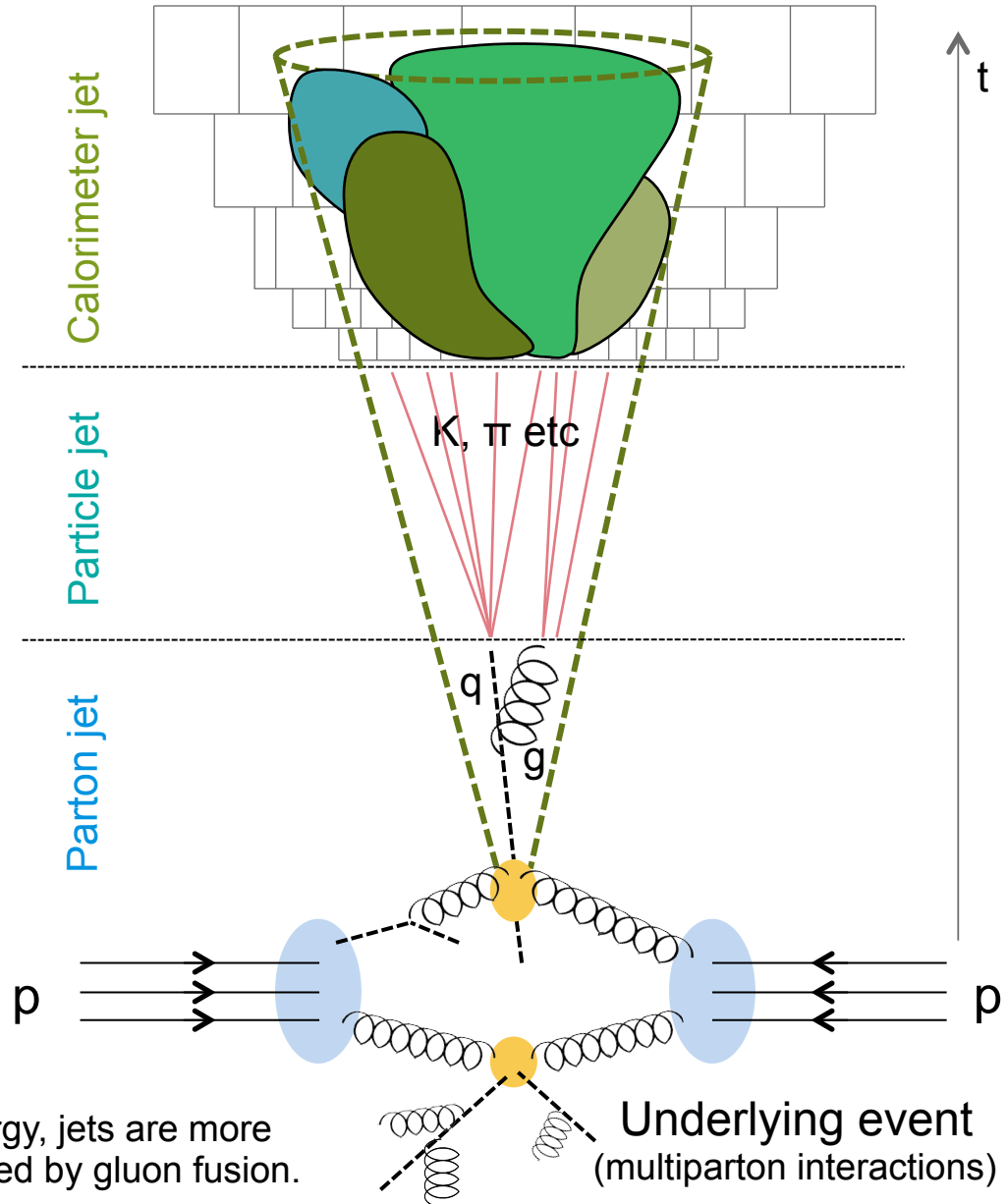

JET ALGORITHMS

Theoretical requirements: **infrared** and **collinear** safe.

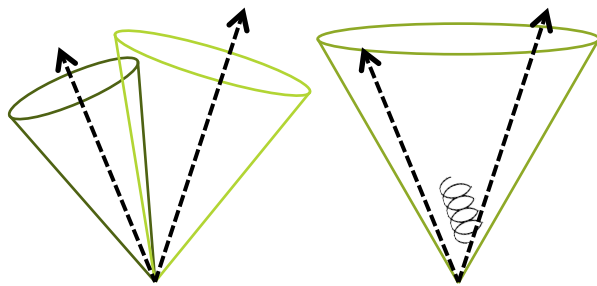

Soft gluon radiation
should not merge jets

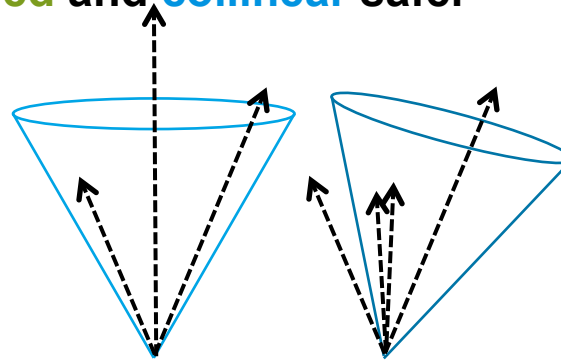

Final jet should not depend on
the ordering of the seeds...

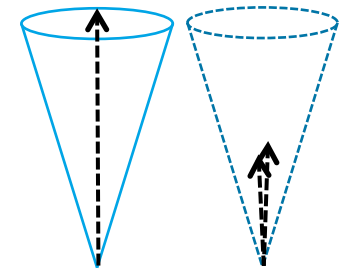

...and on signal split in two
possibly below threshold

Experimental requirements: **detector technology** & **environment** independent,
easily implementable.

Insignificant effects of detector

- Noise
- Dead material
- Cracks

Stability with

- Luminosity
- Pile-up
- Physics process

Fully specified

Fast

Jet algorithm commonly used at the LHC: **'anti- k_r '**. A 'recursive recombination' algorithm. Starts from (topo-)clusters. Hard stuff clusters with nearest neighbor. Various cone sizes (standard $R=0.4/0.5$, "fat" $R=1.0$).

JET CALIBRATION



Correct the energy and position measurement and the resolution.

Account for:

Instrumental effects

Detector inefficiencies

'Pile-up'

Electronic noise

Clustering, noise suppression

Dead material losses

Detector response

Algorithm efficiency

Physics effects

Algorithm efficiency

'Pile-up'

'Underlying event'

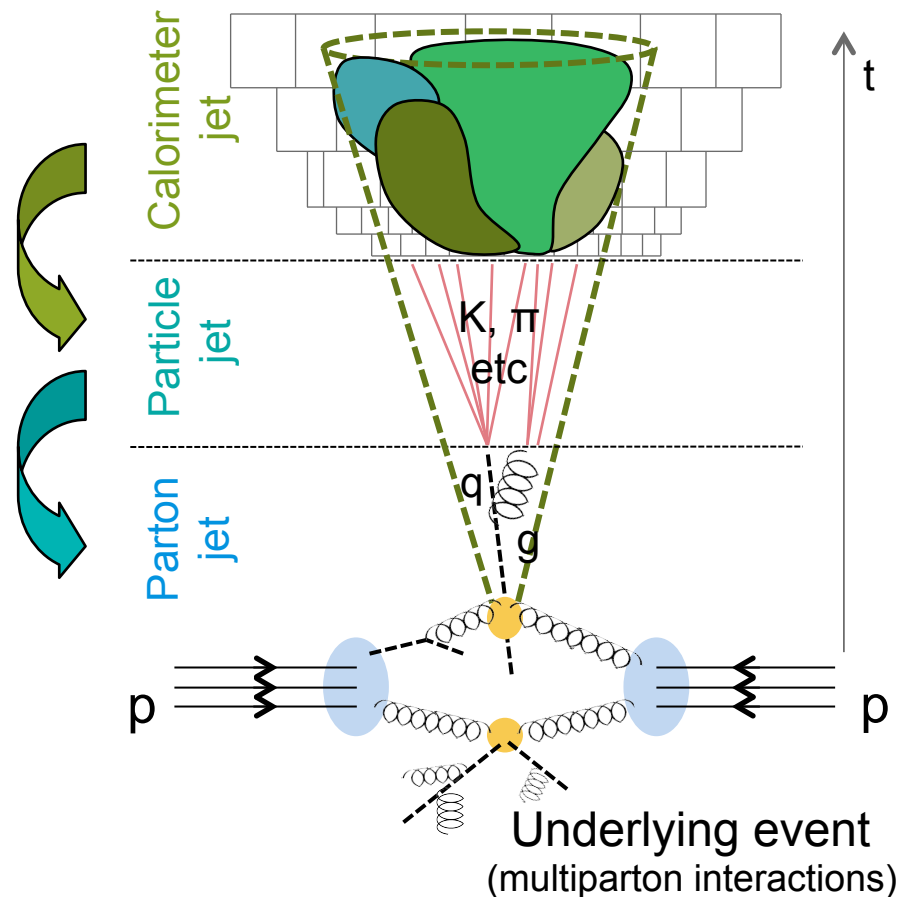

JETS & PILE-UP

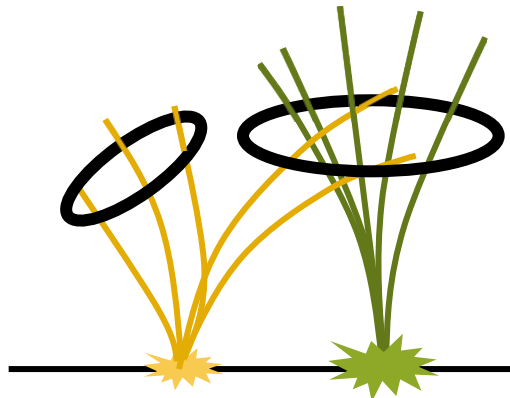
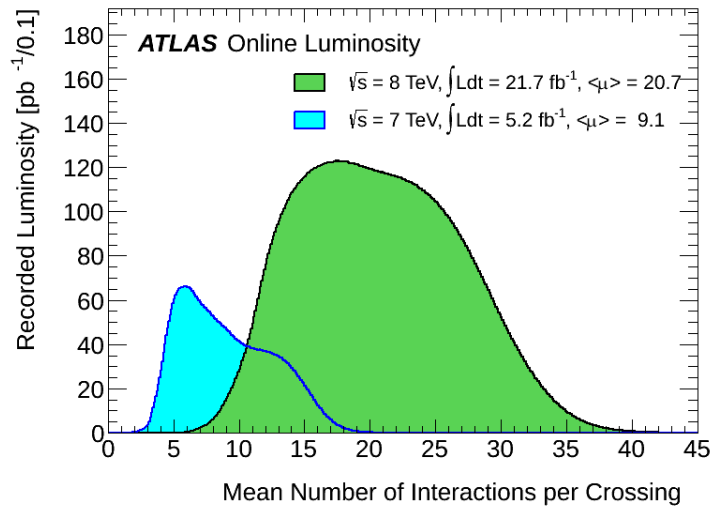

Multiple interactions from pile-up

'Jet-areas' corrections

Inspired by arXiv:0707.1378

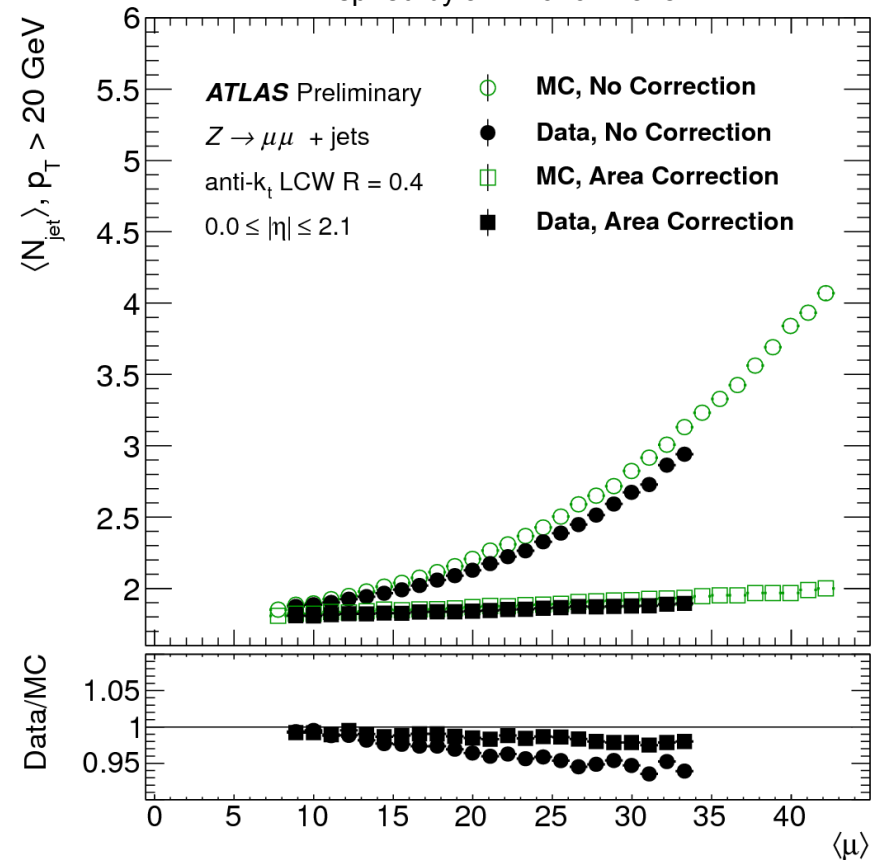

BJETS

- ⊙ b-quarks have a lifetime of $\sim 10^{-12}$ s.
- ⊙ They travel a small distance (fraction of mm) before decaying.
- ⊙ A “**displaced vertex**” creates a distinct jet, so b-jets can be tagged (**b-tagged**).
- ⊙ b-tagging uses sophisticated algorithms, mostly **multi-variate**.

- ⊙ b-jets create distinct final states, important for both **Standard Model measurements** and **searches for New Physics**.

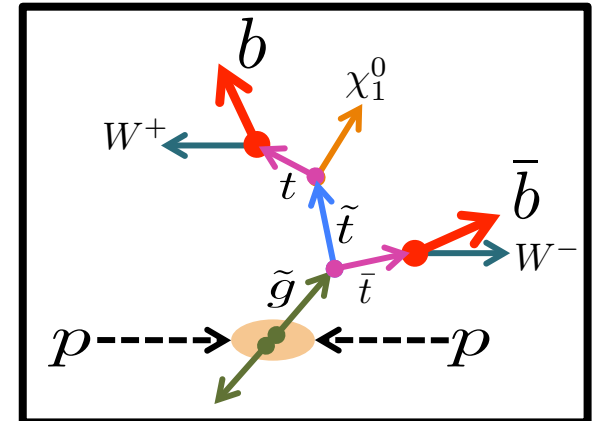
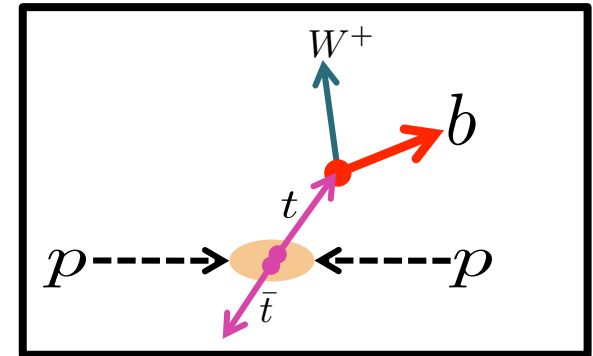
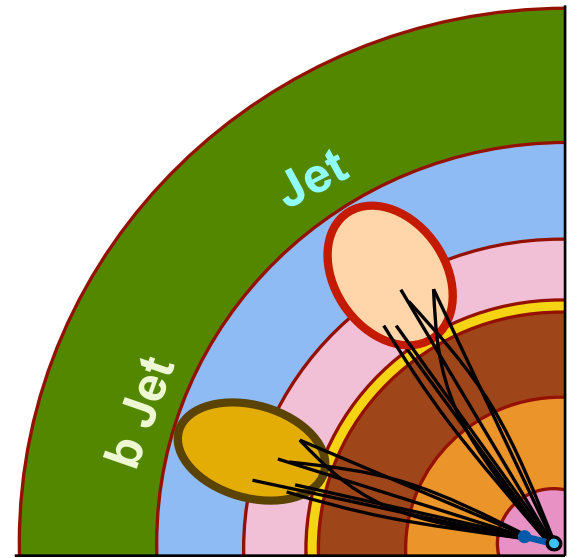

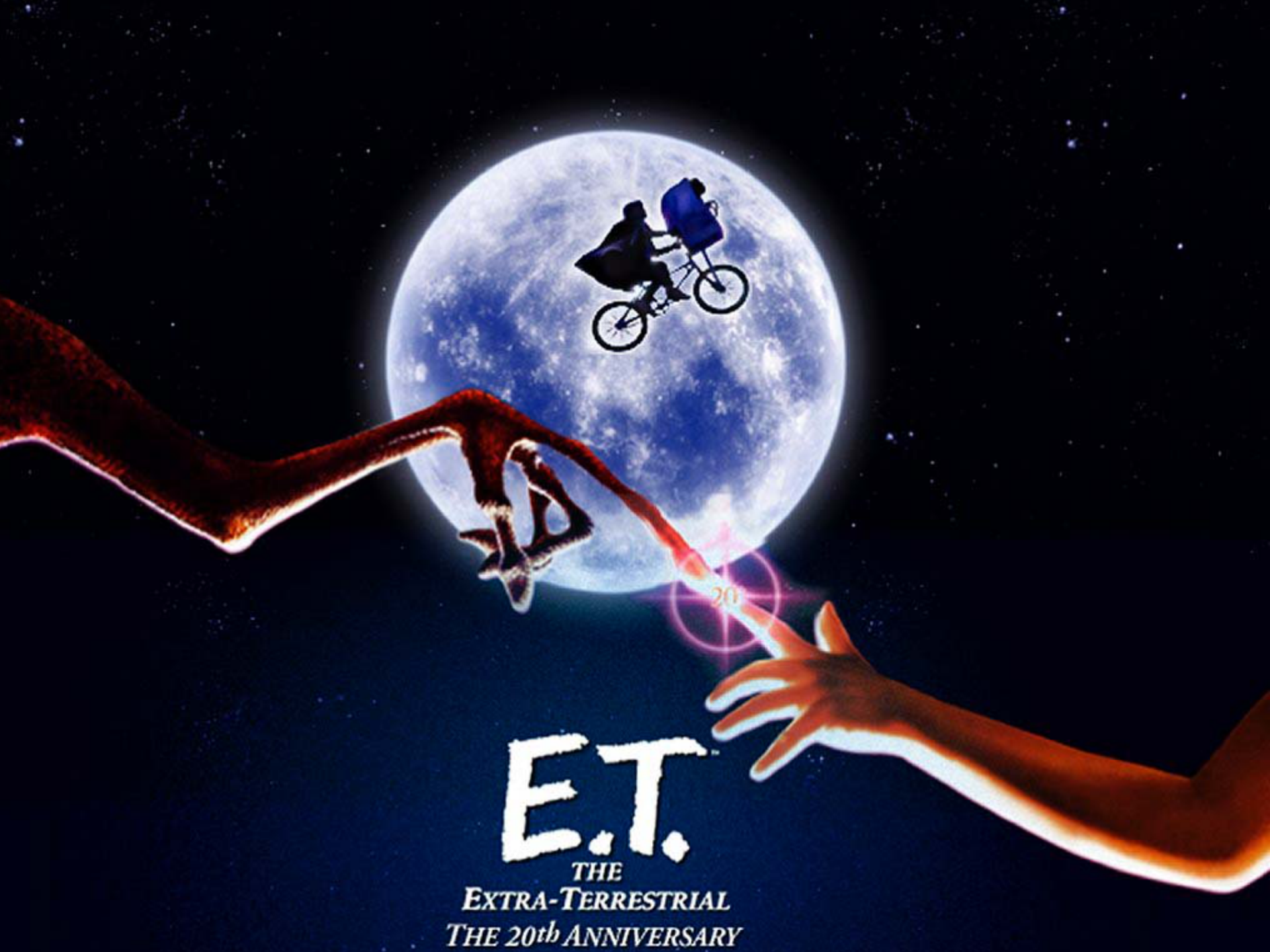

E.T.
THE
EXTRA-TERRESTRIAL
THE 20th ANNIVERSARY



M.E.T.
THE
EXTRA-TERRESTRIAL
THE 20th ANNIVERSARY

MISSING TRANSVERSE MOMENTUM – “ME_T”

	I	II	III	
Quarks	2.4 MeV u	1.3 GeV c	170 GeV t	0 γ
	4.8 MeV d	104 MeV s	4.2 GeV b	0 g
	<2 eV v _e	<2 eV v _μ	<2 eV v _τ	91 GeV Z
Leptons	0.5 MeV e	16 MeV μ	1.8 GeV τ	80 GeV W
				126 GeV H

Bosons

Simplified Detector Transverse View

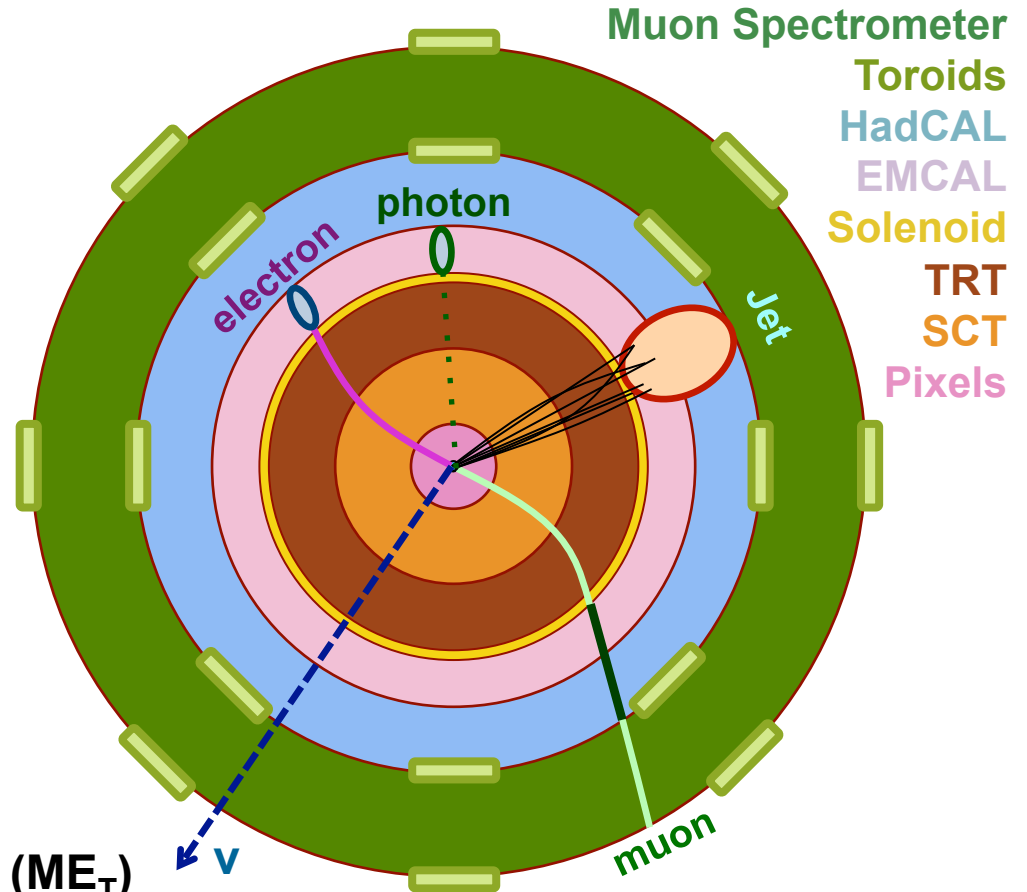

In the transverse plane:

$$\sum \vec{p}_T = 0$$

Missing Transverse Momentum (ME_T)

MISSING TRANSVERSE MOMENTUM – “ME_T”



Simplified Detector Transverse View

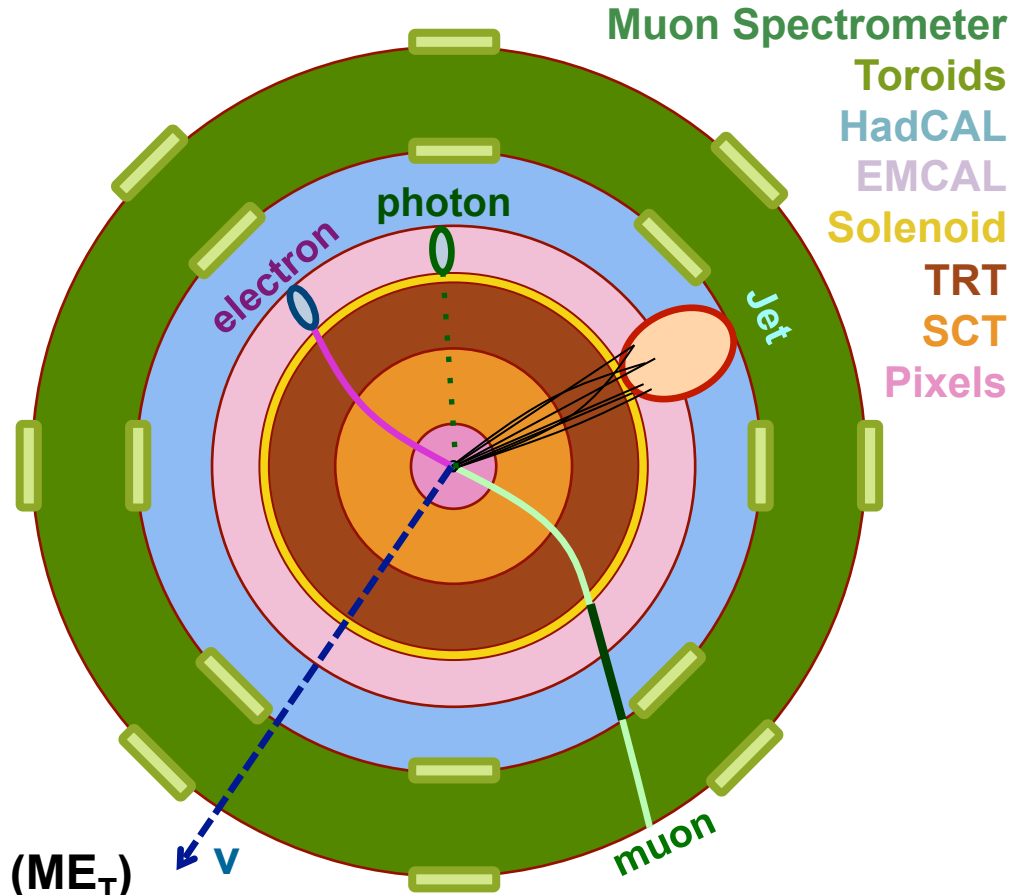

In the transverse plane:

$$\sum \vec{p}_T = 0$$

Missing Transverse Momentum (ME_T)

The background of the slide is a light blue gradient filled with numerous water droplets and bubbles of various sizes, creating a dynamic, fluid-like texture. The droplets are rendered with soft shadows and highlights, giving them a three-dimensional appearance. The bubbles are also depicted with realistic shading, suggesting light refraction and reflection. The overall effect is clean, fresh, and evocative of liquid motion.

PARTICLE FLOW FOR HADRONIC RECONSTRUCTION

PARTICLE FLOW

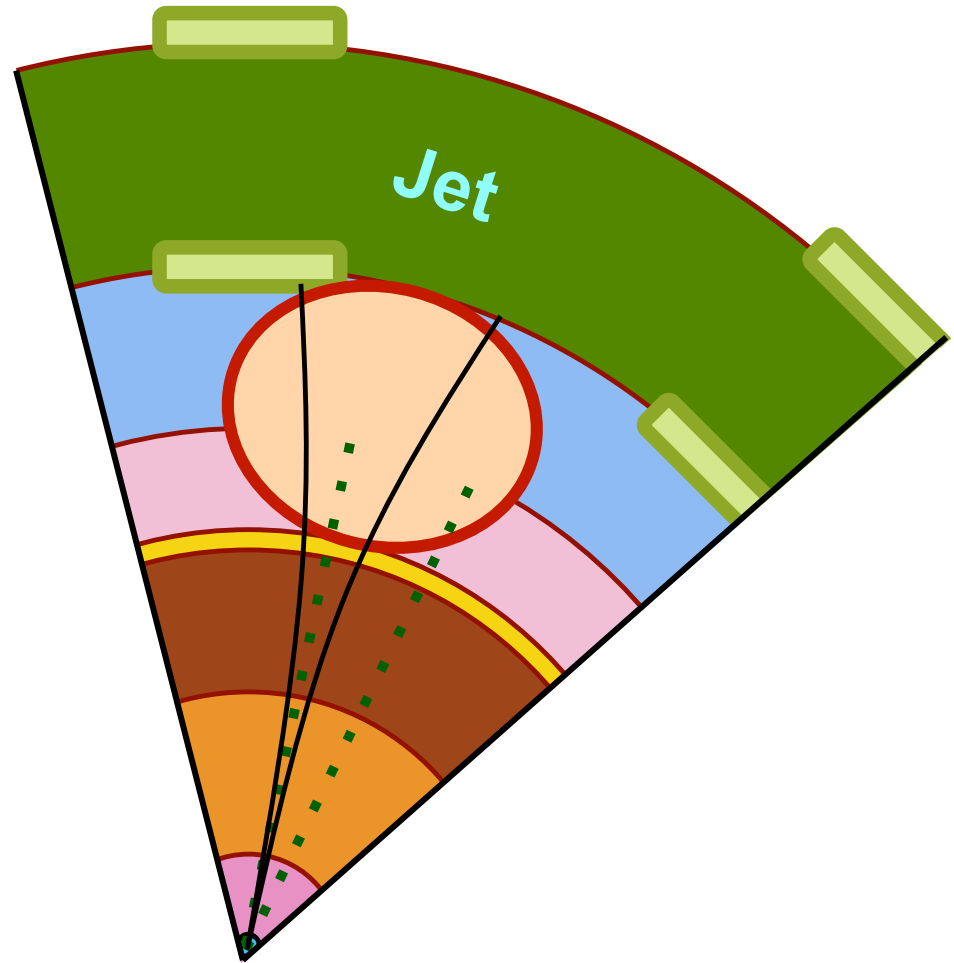

PARTICLE FLOW

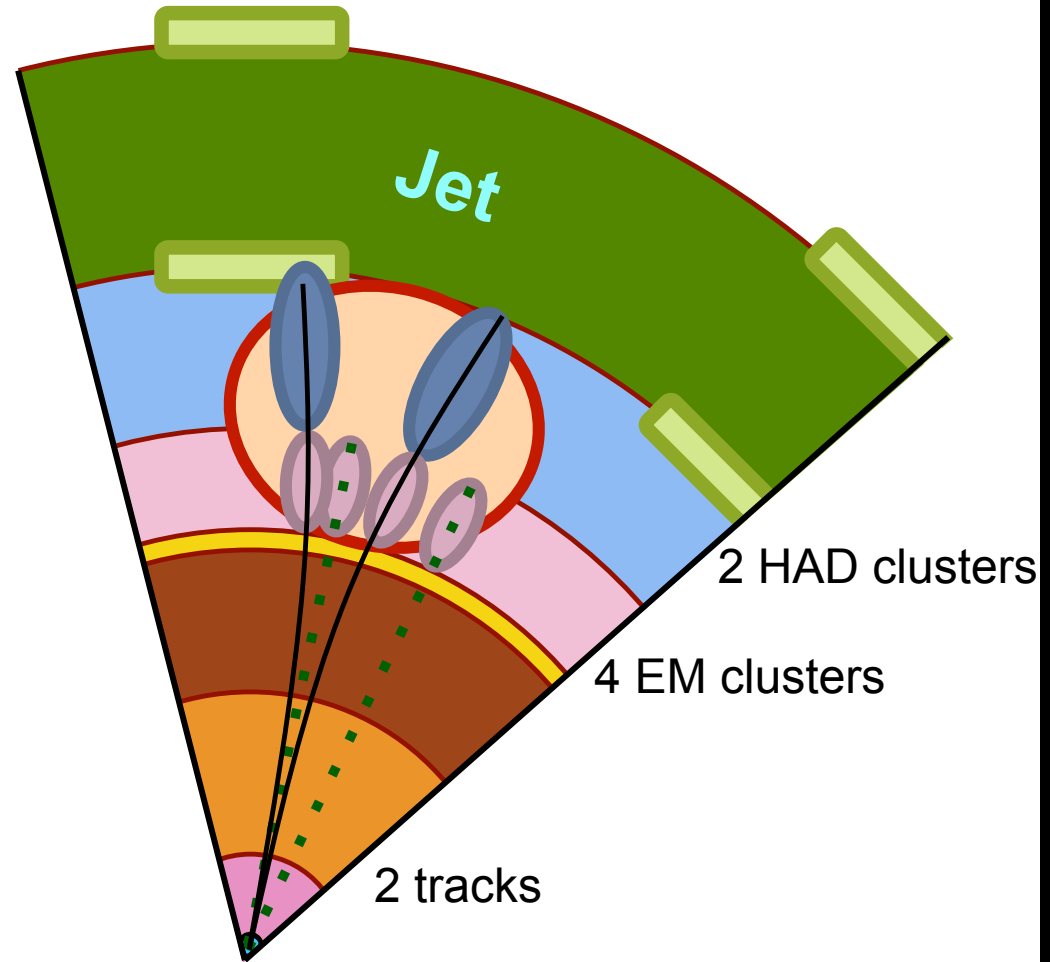

PARTICLE FLOW

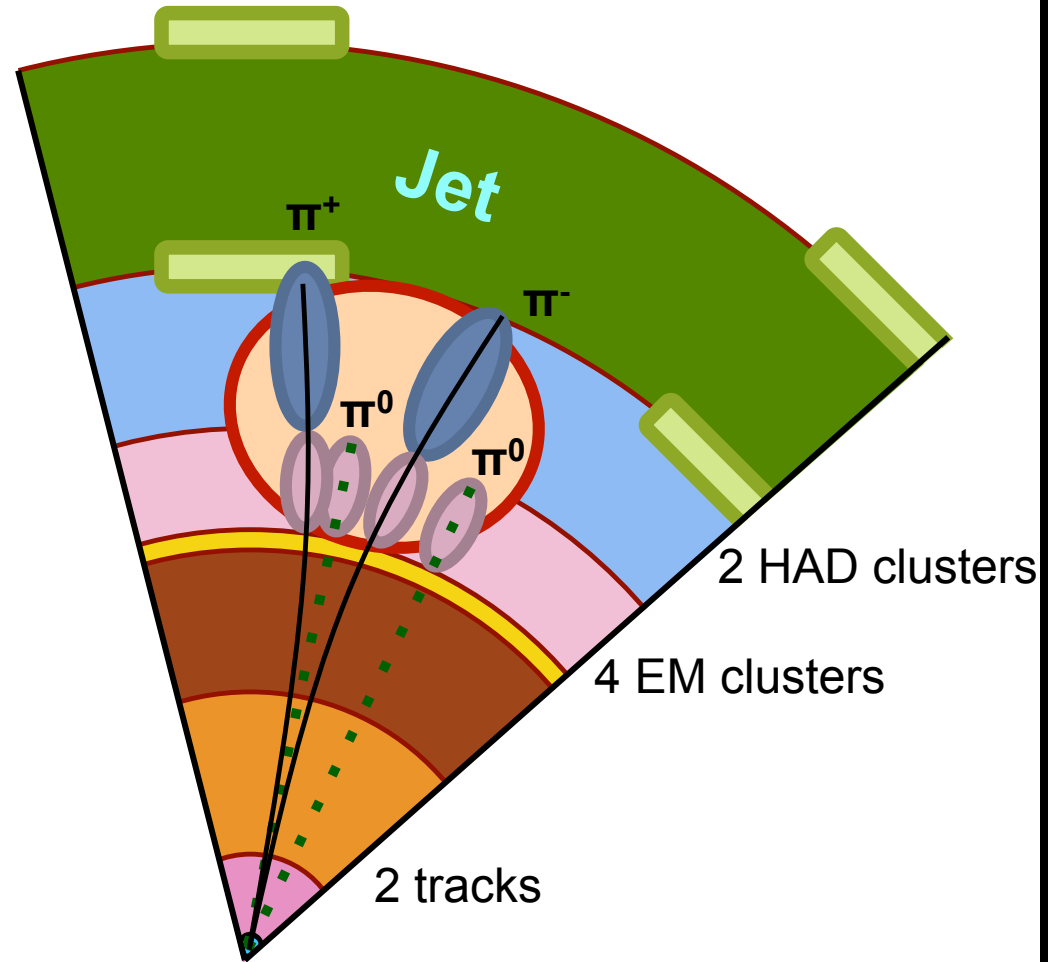

PARTICLE FLOW

- © “Flow of particles” through the detector.
- © Reconstruct and identify all particles, photons, electrons, pions, ...
- © Use best combination of all sub-detectors for measuring the properties of the particles.
- © First used at LEP (ALEPH) and then at the LHC (CMS).

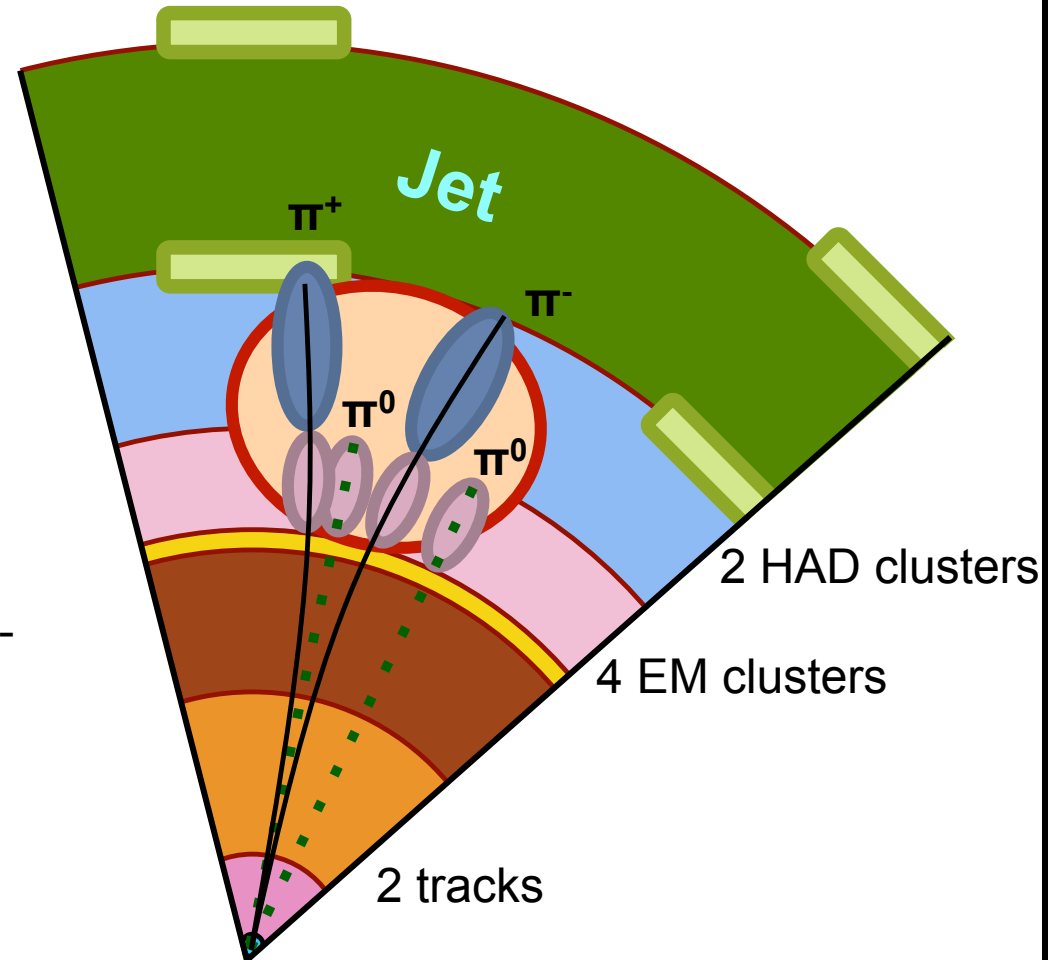

PARTICLE FLOW

- © “Flow of particles” through the detector.
- © Reconstruct and identify all particles, photons, electrons, pions, ...
- © Use best combination of all sub-detectors for measuring the properties of the particles.
- © First used at LEP (ALEPH) and then at the LHC (CMS).

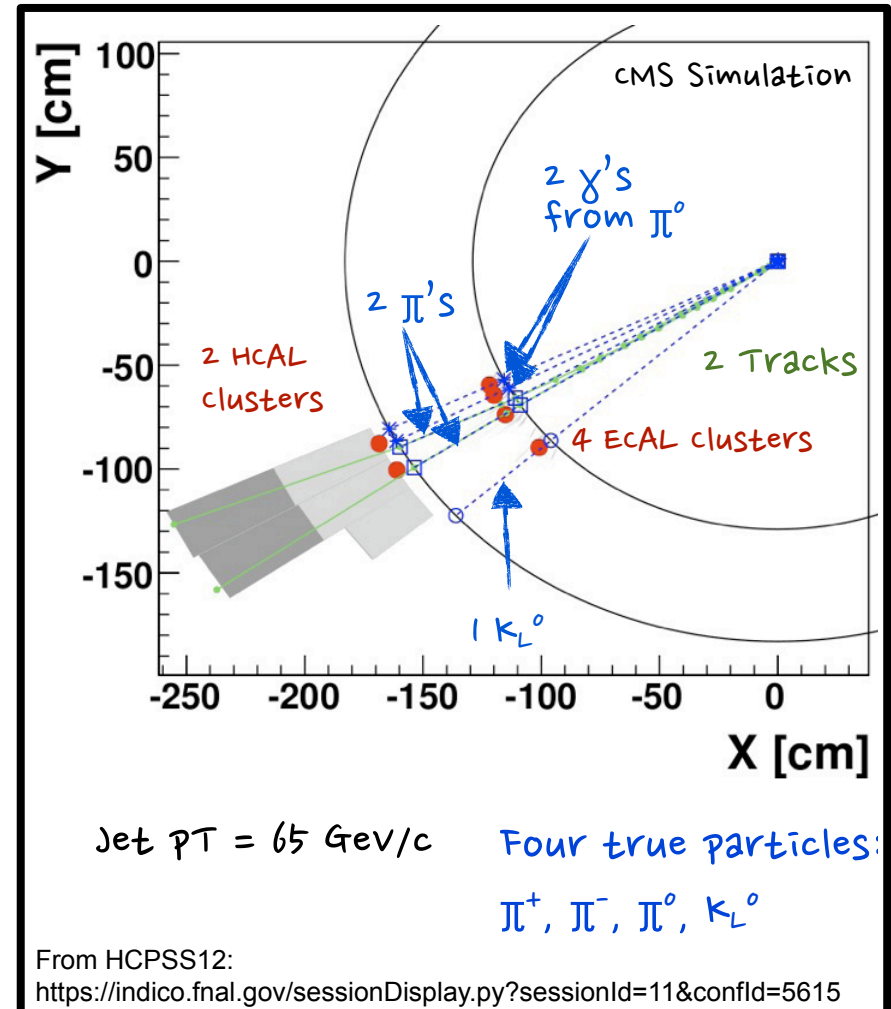

PARTICLE FLOW

1. Associate hits within each detector.
2. Link across detectors.
3. Apply particle-ID and separation.

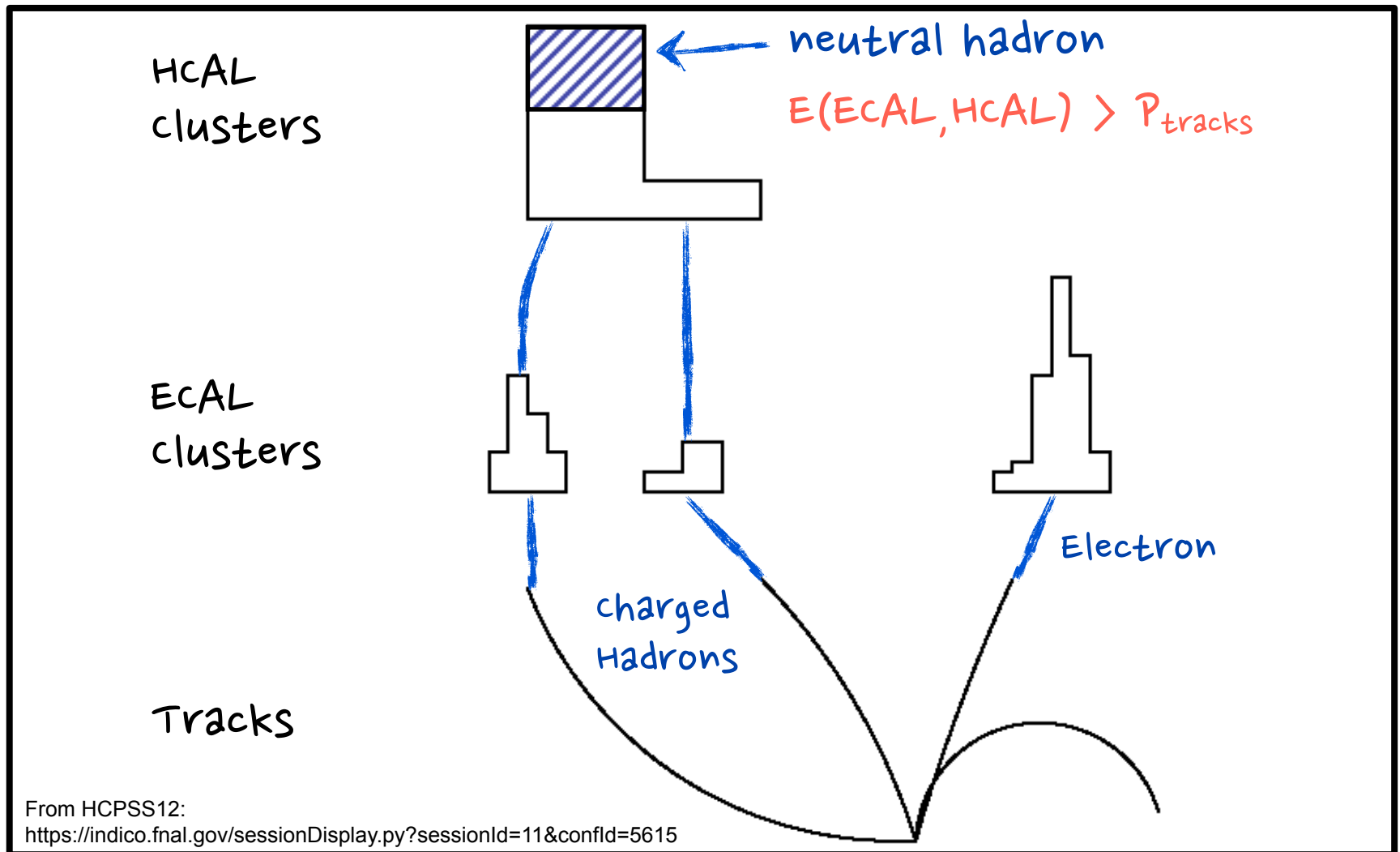

JETS IN PILE-UP

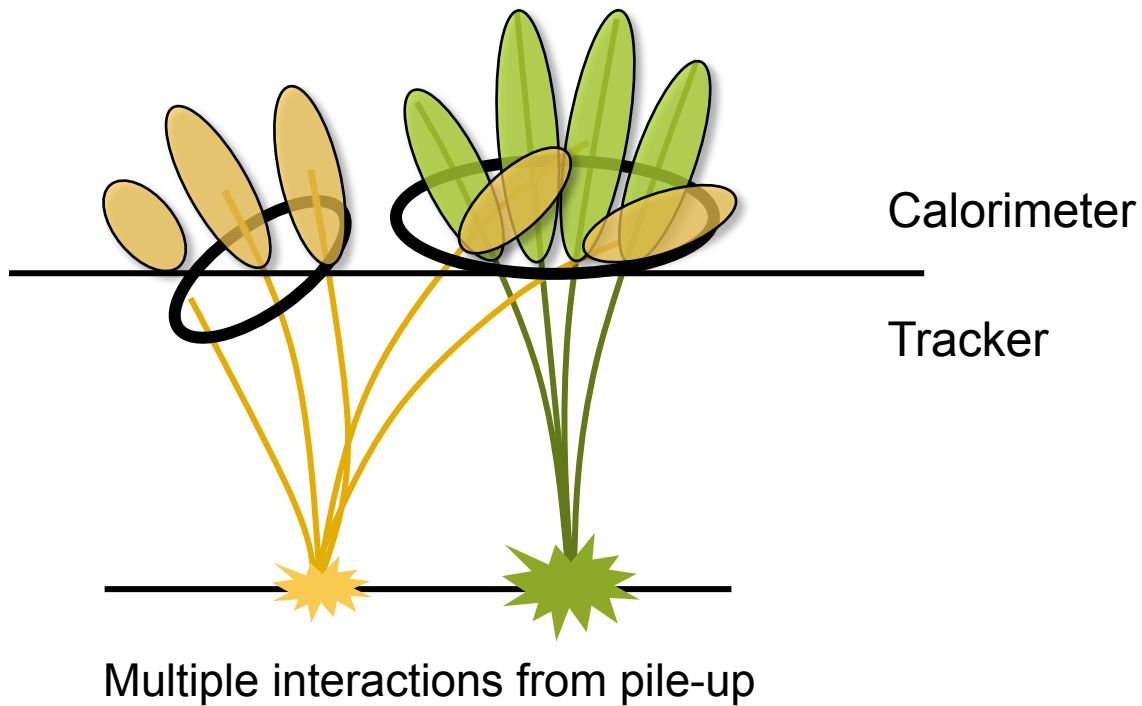

PARTICLE FLOW JETS IN PILE-UP

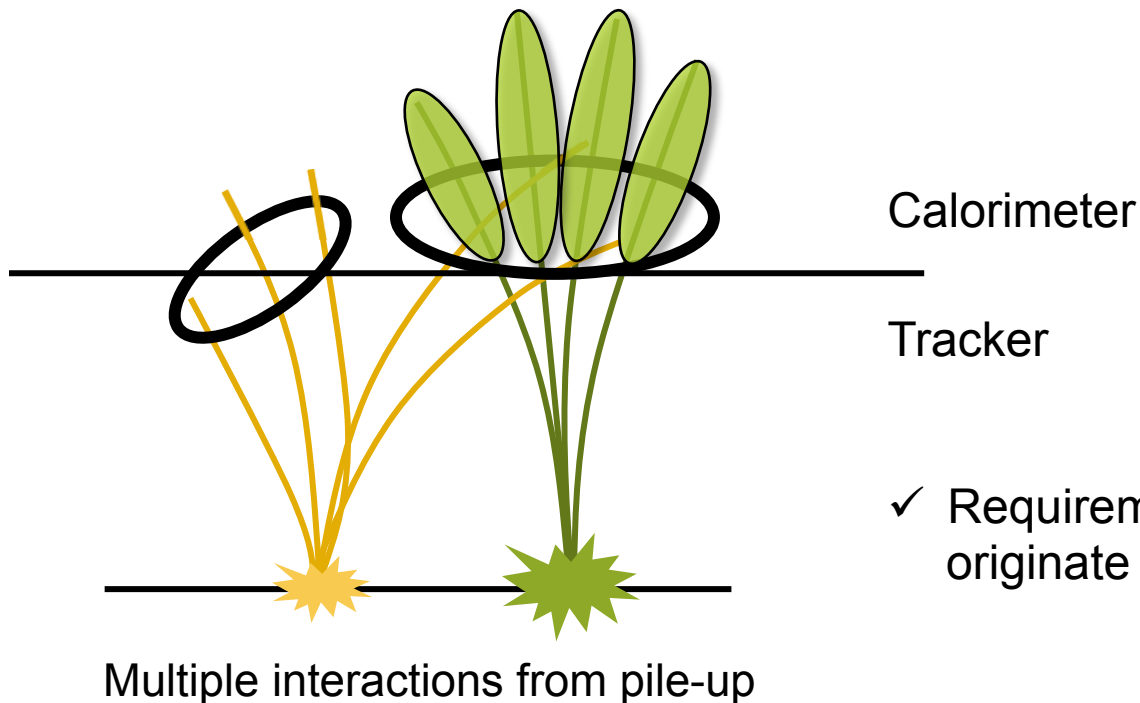

- ✓ Requirement that particles originate from the primary vertex.

MOMENTUM RESOLUTION

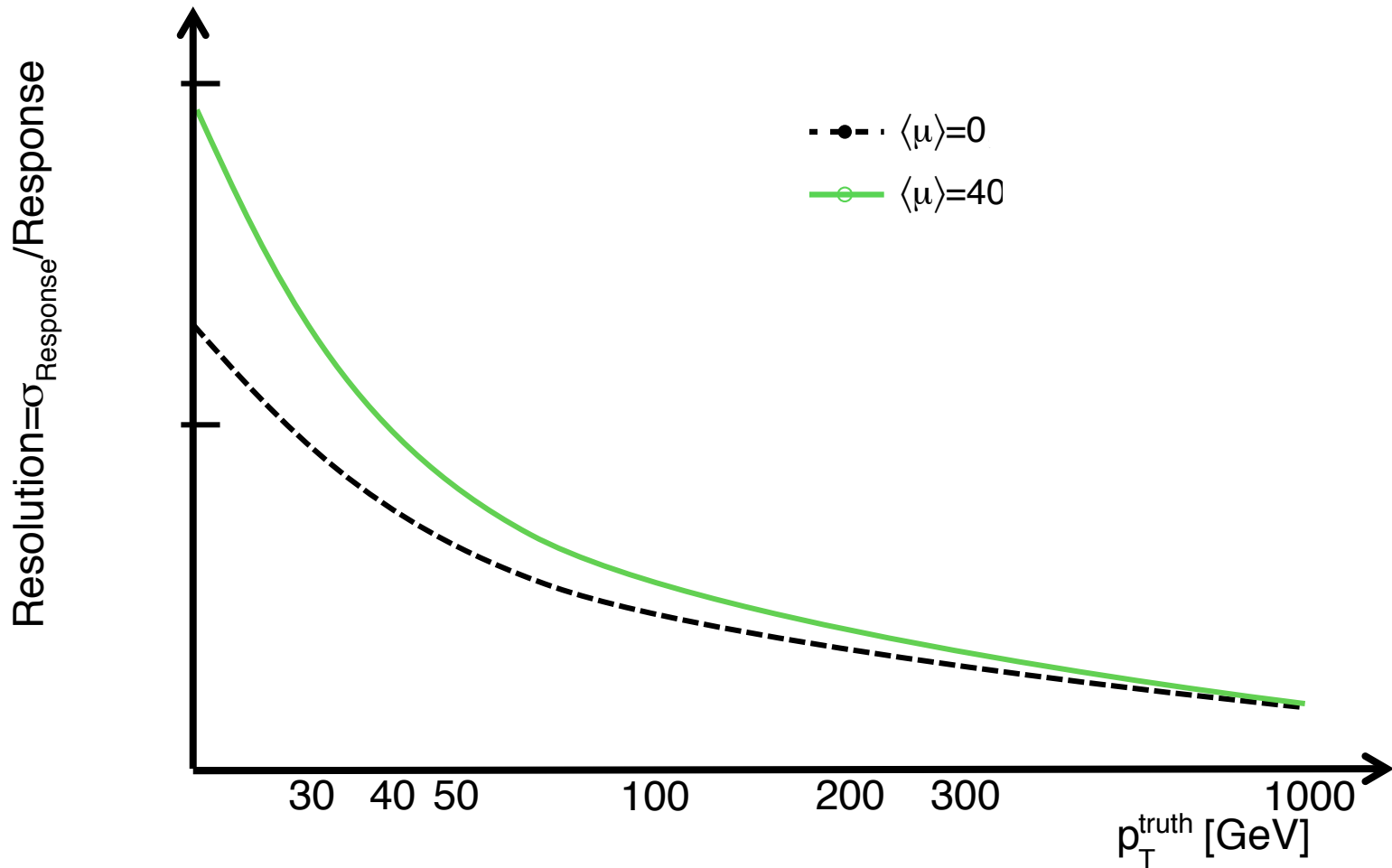

Resolution: the quality with which we measure the jet momentum.

MOMENTUM RESOLUTION

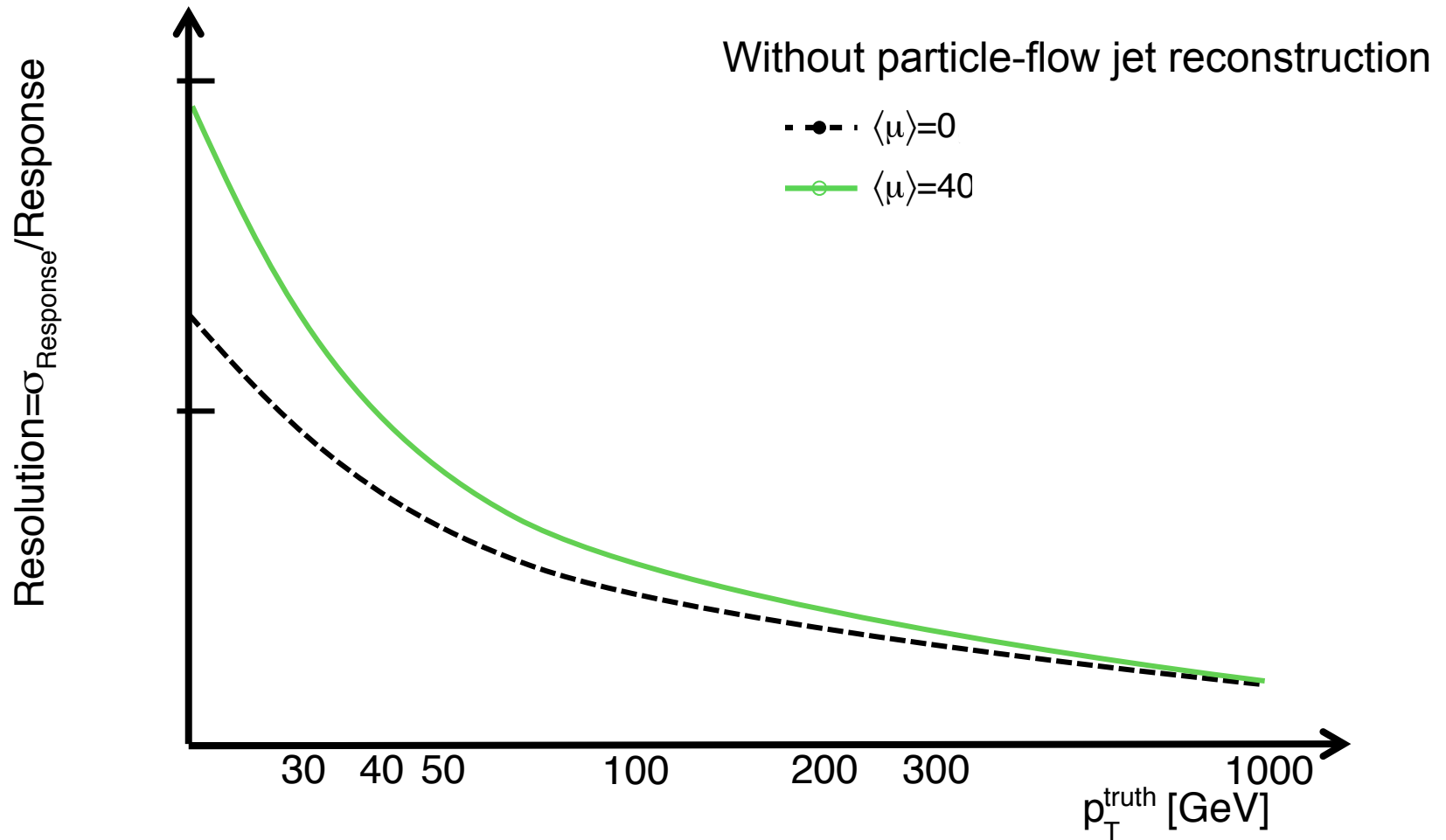

Resolution: the quality with which we measure the jet momentum.

MOMENTUM RESOLUTION

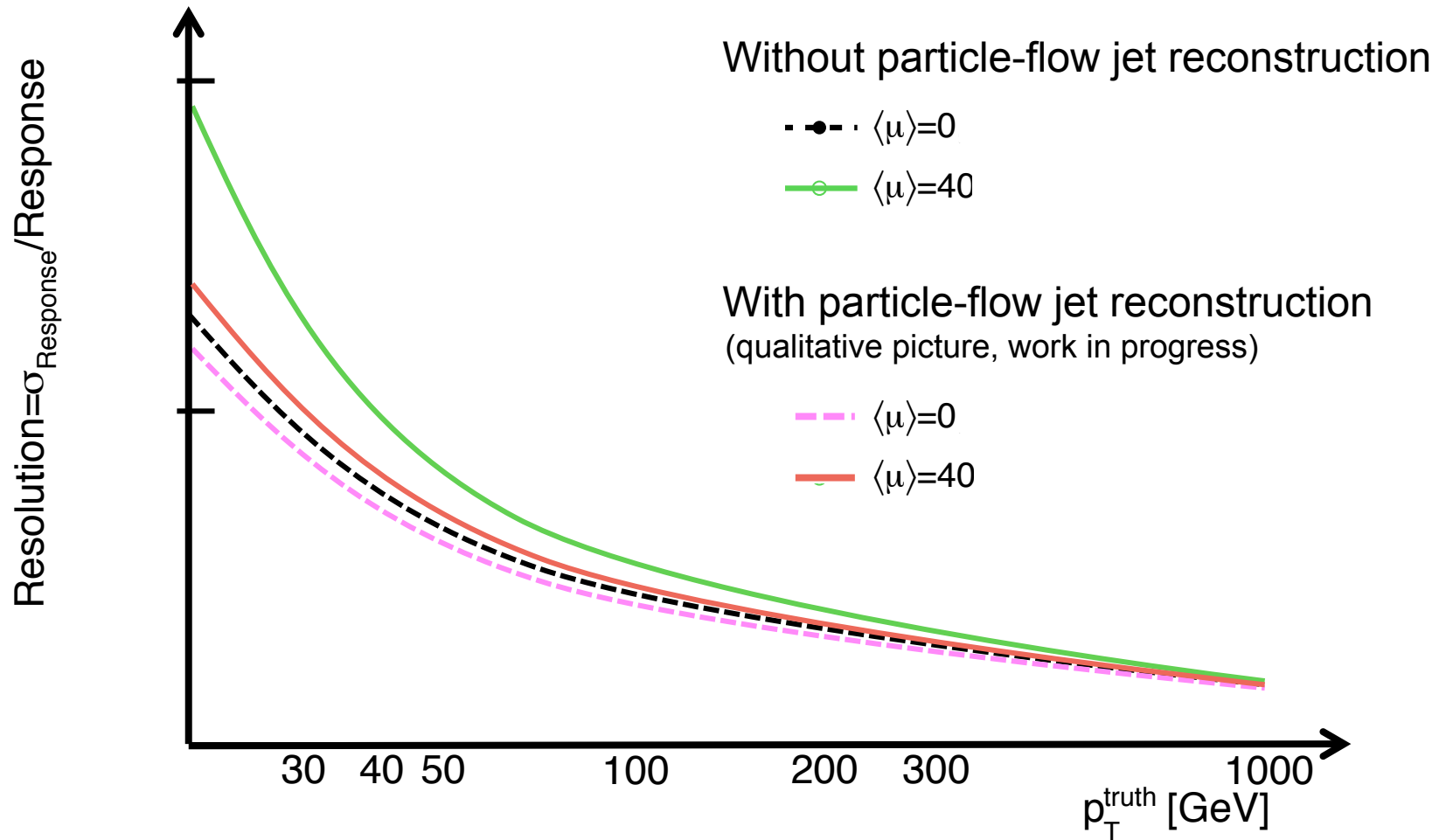

Resolution: the quality with which we measure the jet momentum.

MOMENTUM RESOLUTION

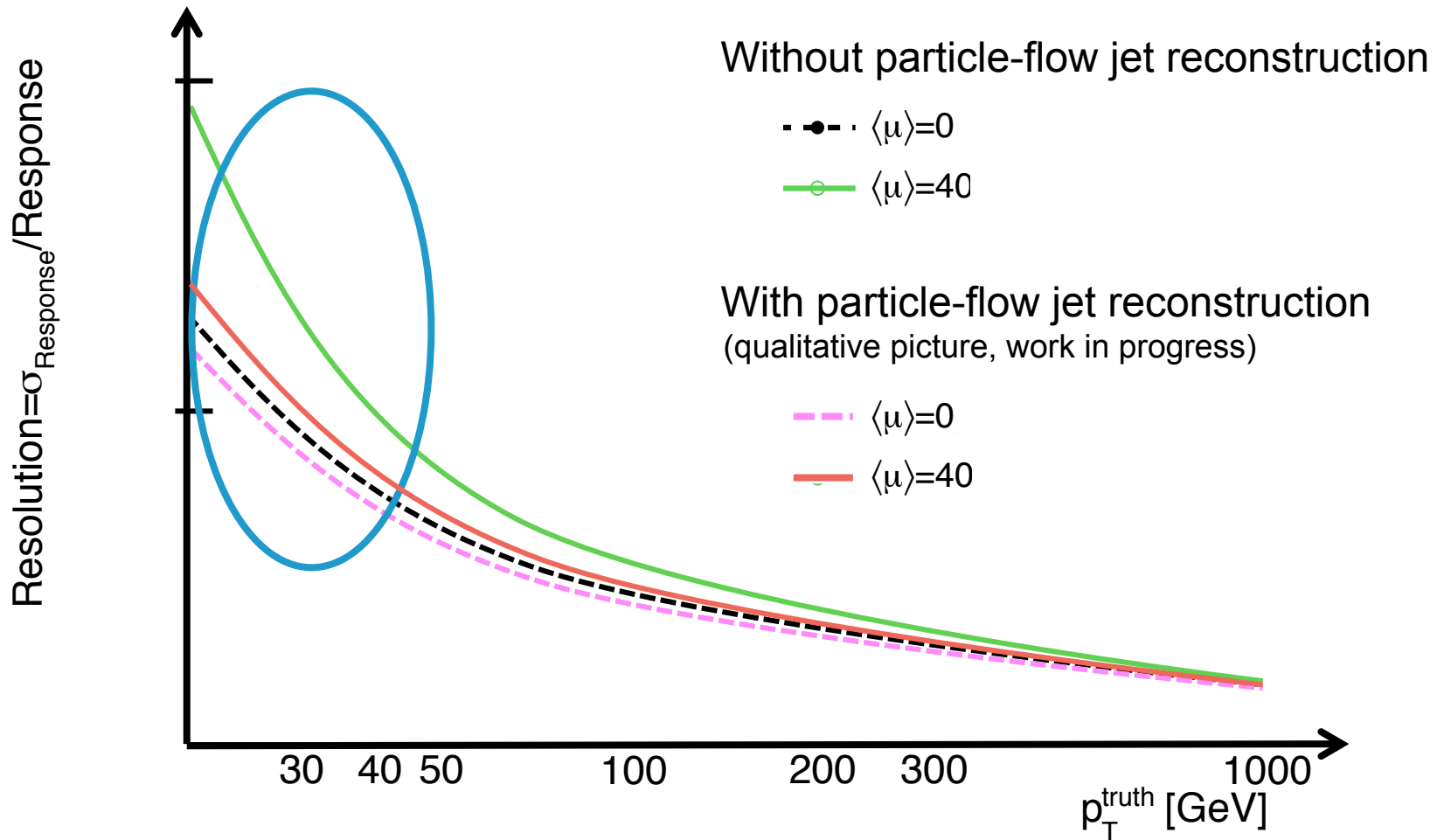

Significant improvement for low- p_T jets. Similar for MET.

MOMENTUM RESOLUTION

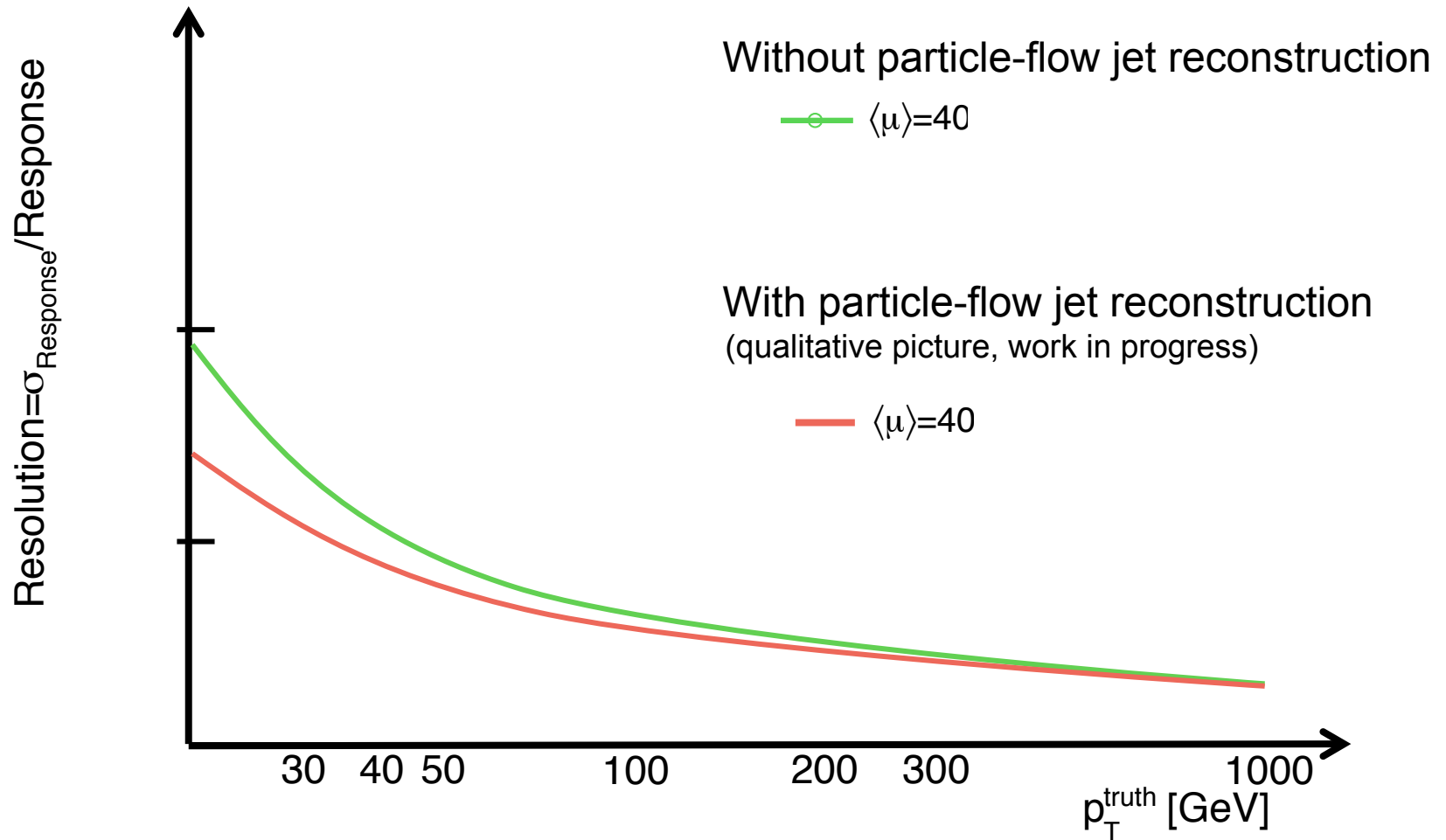

Significant improvement for low- p_T jets. Similar for MET.

MOMENTUM RESOLUTION

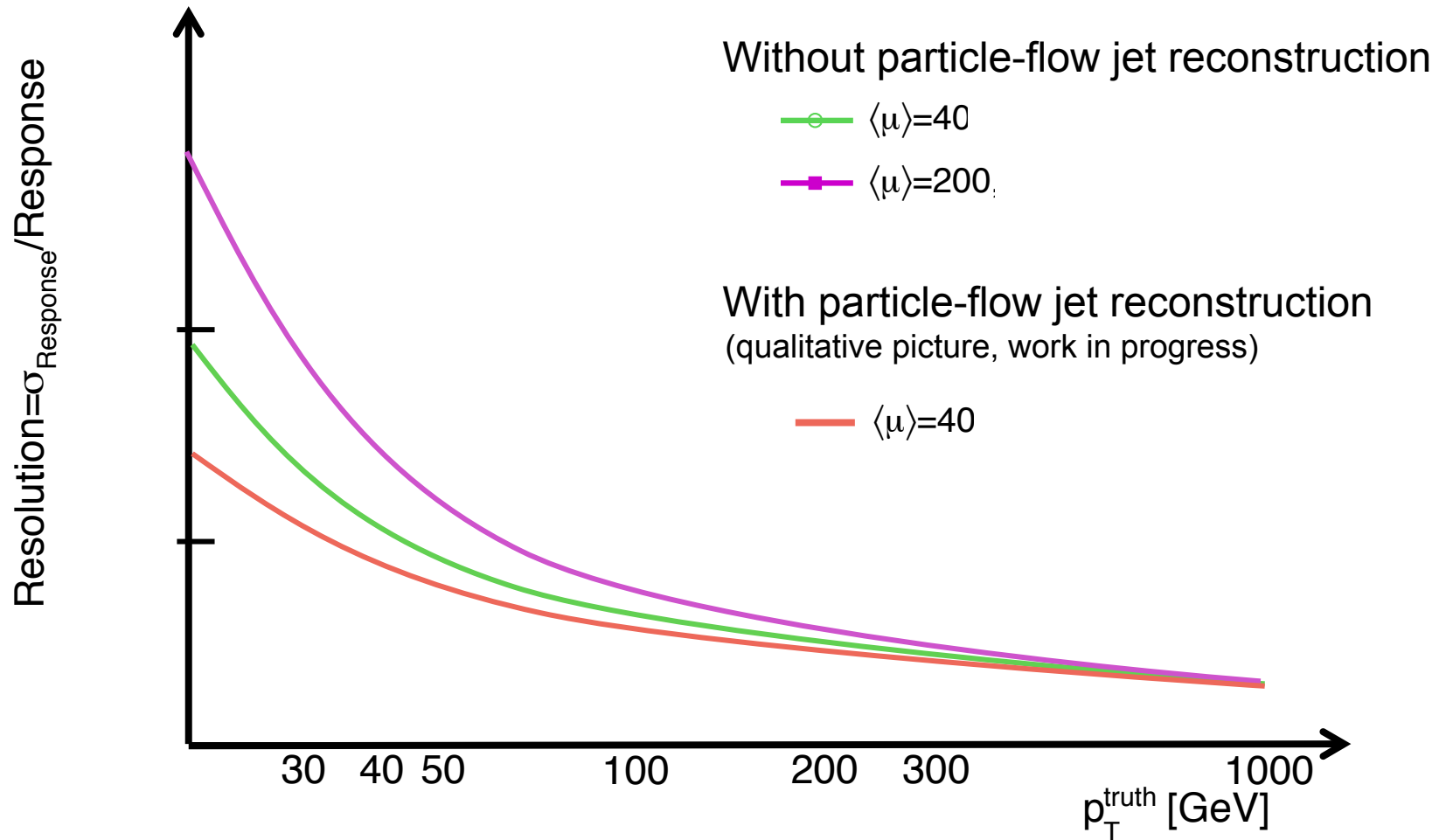

Significant improvement for low- p_T jets. Similar for MET.

MOMENTUM RESOLUTION

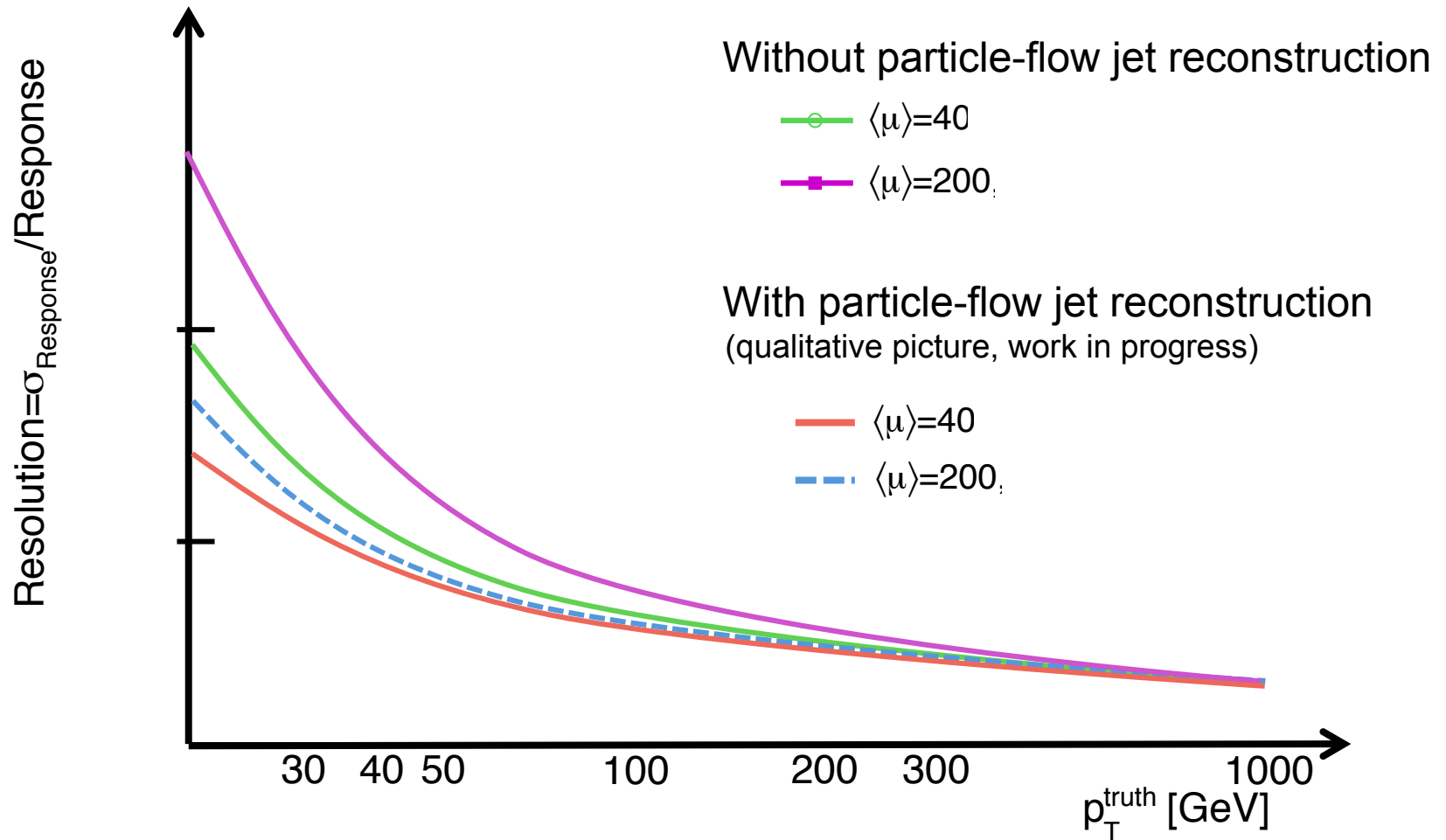

Significant improvement for low- p_T jets. Similar for MET.

MET RESOLUTION IN SUSY

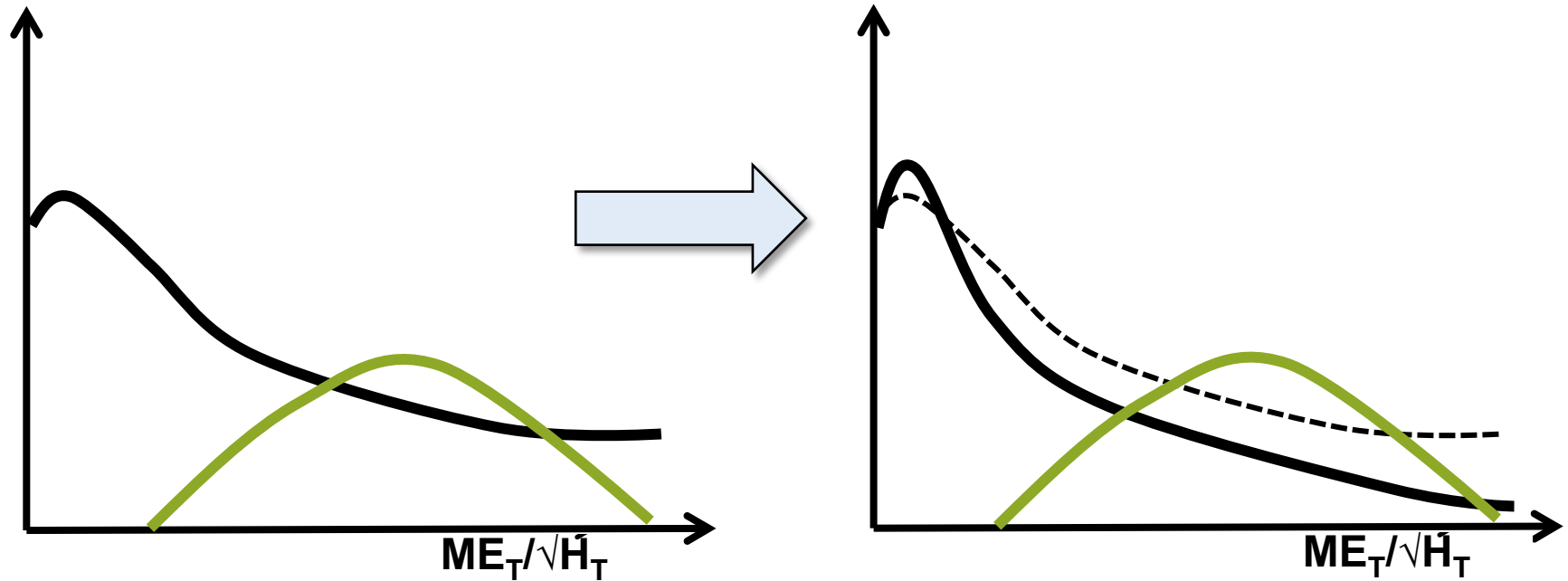

- © Improved resolution will affect the background shape significantly but not so much the signal shape.
- © Signal-to-background discrimination significantly improved!

PARTICLE FLOW - PERFORMANCE

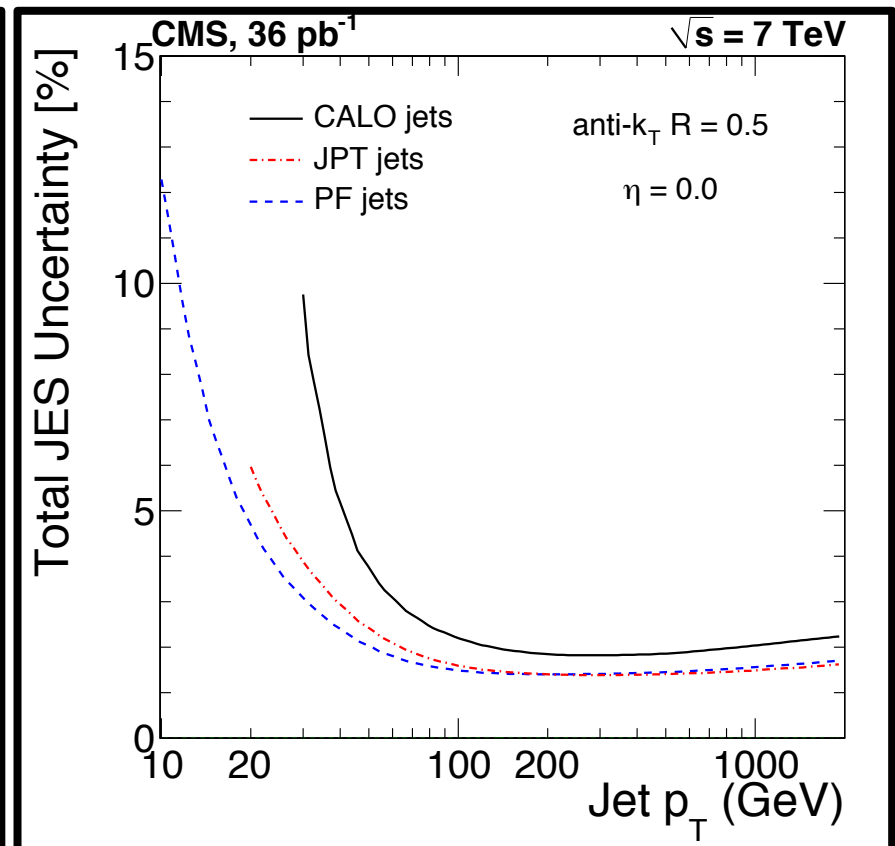
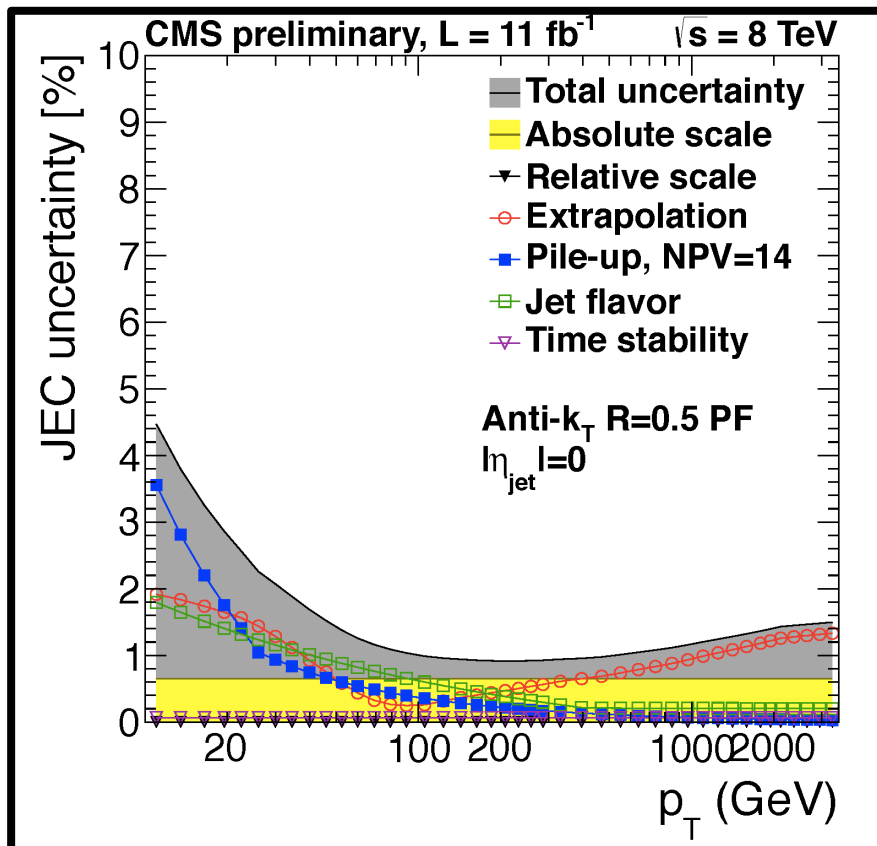

In Jet Energy Scale uncertainty, large improvements with respect to calo jets!

A COMPARISON

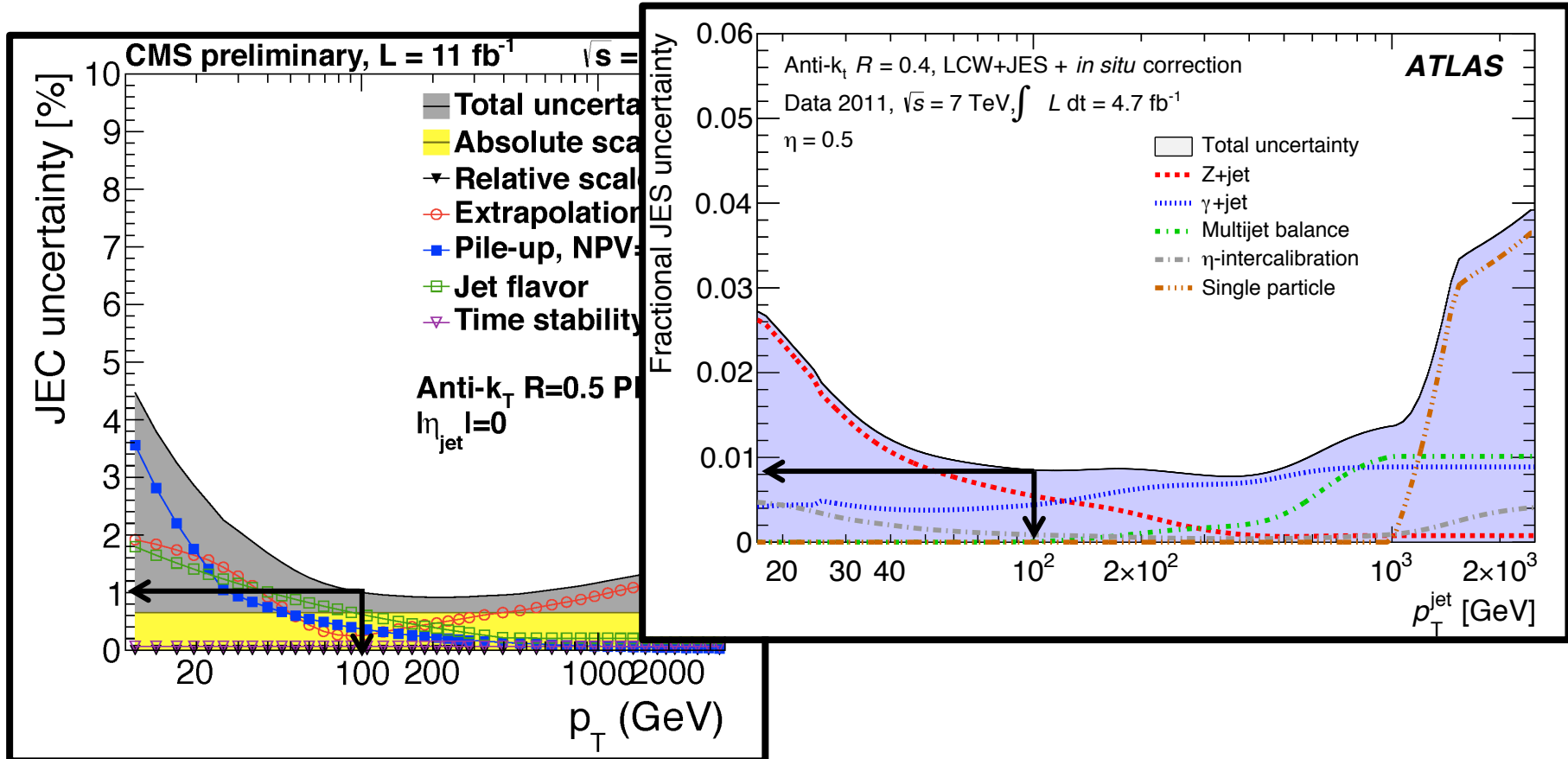

- © At $\sim 100 \text{ GeV}$ jets, PF jets (CMS) and calo jets (ATLAS) have similar performance.
- © Particle reconstruction always needs to be optimized depending on the detector technologies and experimental requirements.

ONLINE RECONSTRUCTION

Objective: Trigger (“online”) reconstruction same as “offline”.

Problem: Time. Trigger decision needs to be taken fast.

Solution: Simplification.

Challenge: Clever simplification = good performance.

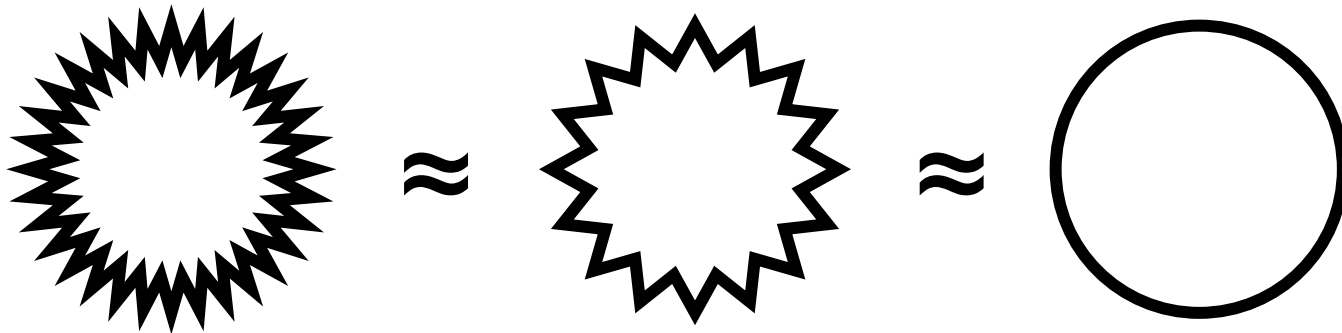

E.g. track reconstruction in regions of interest and simplified MET calculation.

ONLINE RECONSTRUCTION

$$\text{trigger efficiency} = \frac{\# \text{ events passing offline selection \& trigger}}{\# \text{ events passing offline selection}}$$

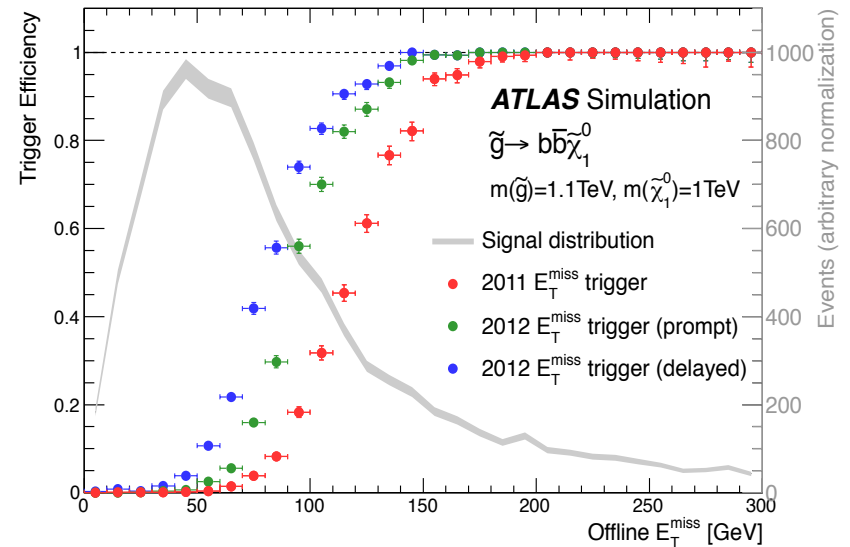
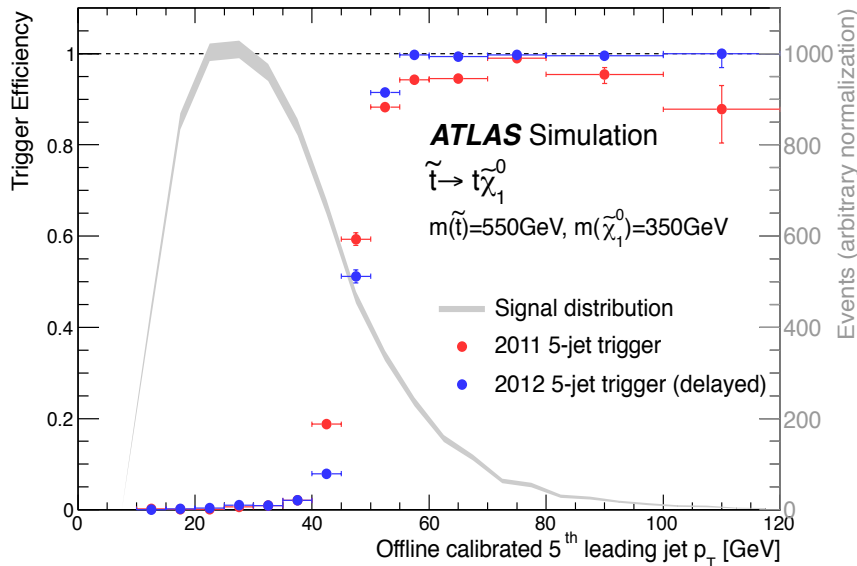

Clever ideas need to be deployed to bring online closer to offline, making efficiency curves **sharper** and **plateau closer to 1**.

TRIGGER

To profit fully from an improvement in reconstruction, the relevant algorithm has to be used at the relevant trigger selections to provide optimal online-to-offline correlation.

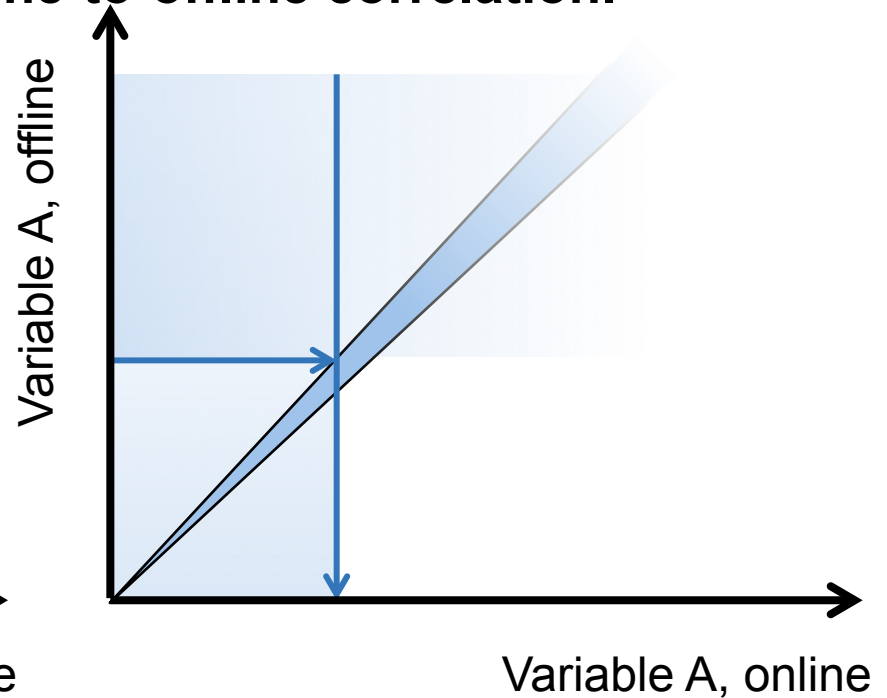
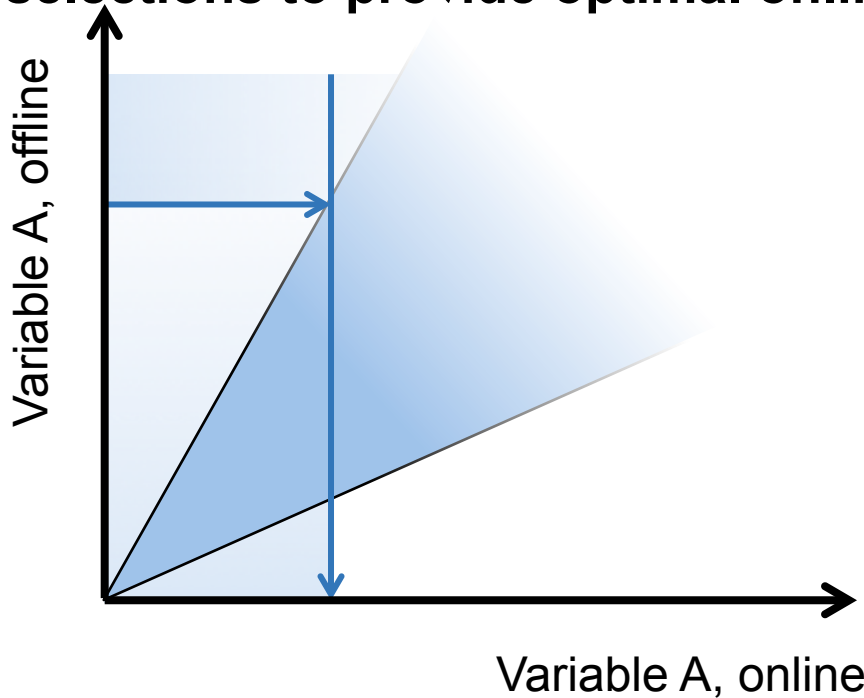

Variable A: e.g. leading jet pT

EFFICIENCY MEASUREMENTS

Relevant beyond the trigger...

Tag and Probe

Select events based on requirements on one object (tag) and study the response of the second object (probe), not used in the event selection, using some constraint such as the Z mass.

- e.g. $Z \rightarrow \tau\tau$ events.
- Typically used for measurement of the identification efficiency.

Orthogonal sample

Measure directly the efficiency on an independent, orthogonal sample.

- e.g. jet trigger efficiency on a sample triggered by muons,

Bootstrap method

The efficiency, ϵ_B , of a selection B, inclusive compared to a selection A, can be determined in a sample of events passing selection A (provided that ϵ_A is measurable): $\epsilon_B = \epsilon_{B|A} \times \epsilon_A$.

- e.g. trigger efficiencies,
say B: tau50_loose & A: tau16_loose

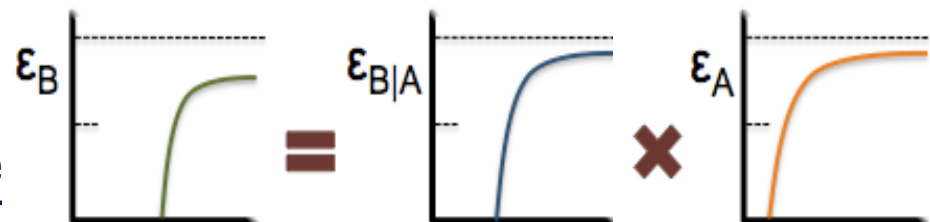

RECONSTRUCTING PARTICLES

	I	II	III	
Quarks	2.4 MeV u	1.3 GeV c	170 GeV t	0 Υ
	4.8 MeV d	104 MeV s	4.2 GeV b	0 g
	<2 eV ν_e	<2 eV ν_μ	<2 eV ν_τ	91 GeV Z
Leptons	0.5 MeV e	16 MeV μ	1.8 GeV τ	80 GeV W
				126 GeV H

Bosons

Simplified Detector Transverse View

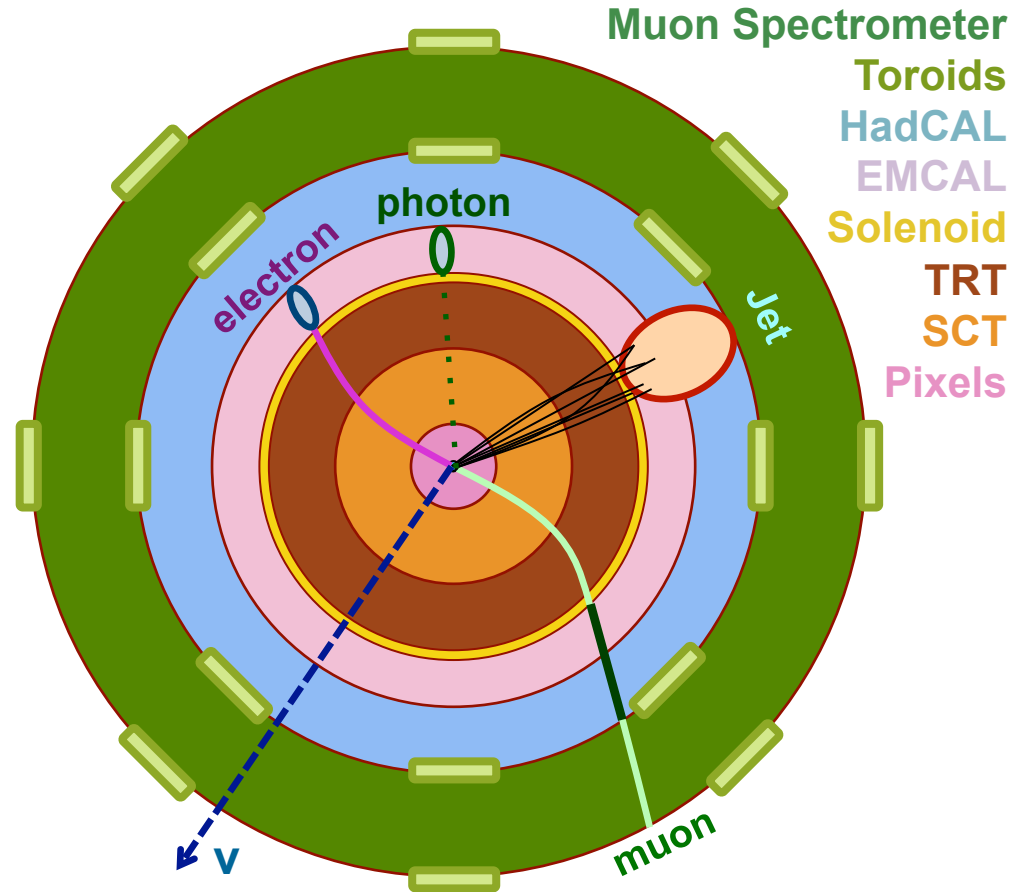

TAUS

Tau Decay Mode			B.R.
Leptonic		$\tau^\pm \rightarrow e^\pm + \nu + \nu$	17.8%
		$\tau^\pm \rightarrow \mu^\pm + \nu + \nu$	17.4%
Hadronic	1-prong	$\tau^\pm \rightarrow \pi^\pm + \nu$	11%
		$\tau^\pm \rightarrow \pi^\pm + \nu + n\pi^0$	35%
	3-prong	$\tau^\pm \rightarrow 3\pi^\pm + \nu$	9%
		$\tau^\pm \rightarrow 3\pi^\pm + \nu + n\pi^0$	5%
Other		~5%	

- © Hadronic tau reconstruction extremely challenging.
- © Using **multi-variate** techniques based on track multiplicity and shower shapes.

A tau jet (signal)...

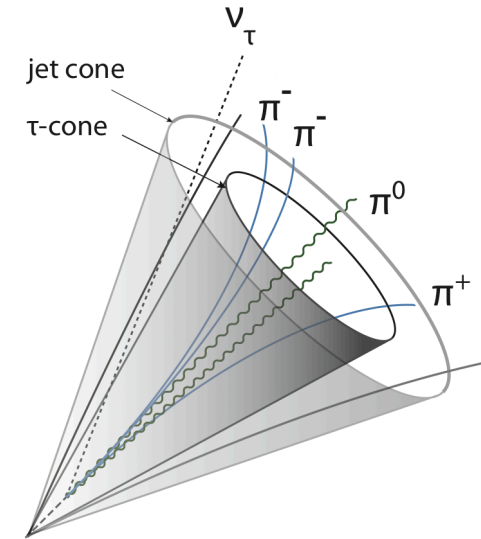

...vs. a QCD jet (background)

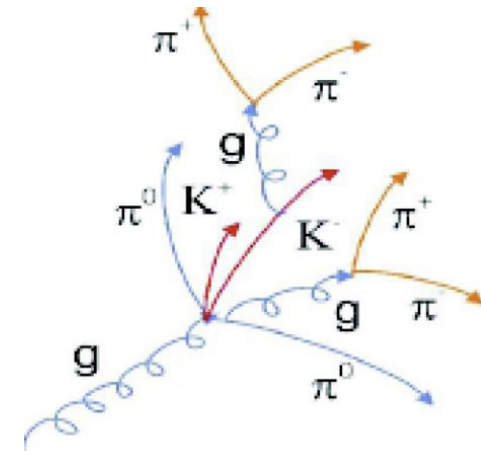

t, W, Z

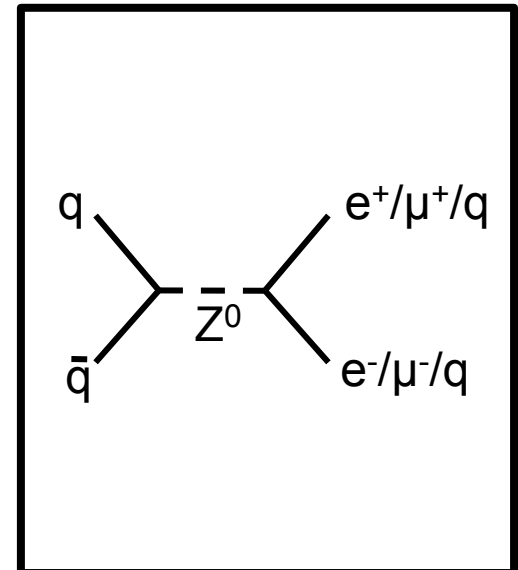
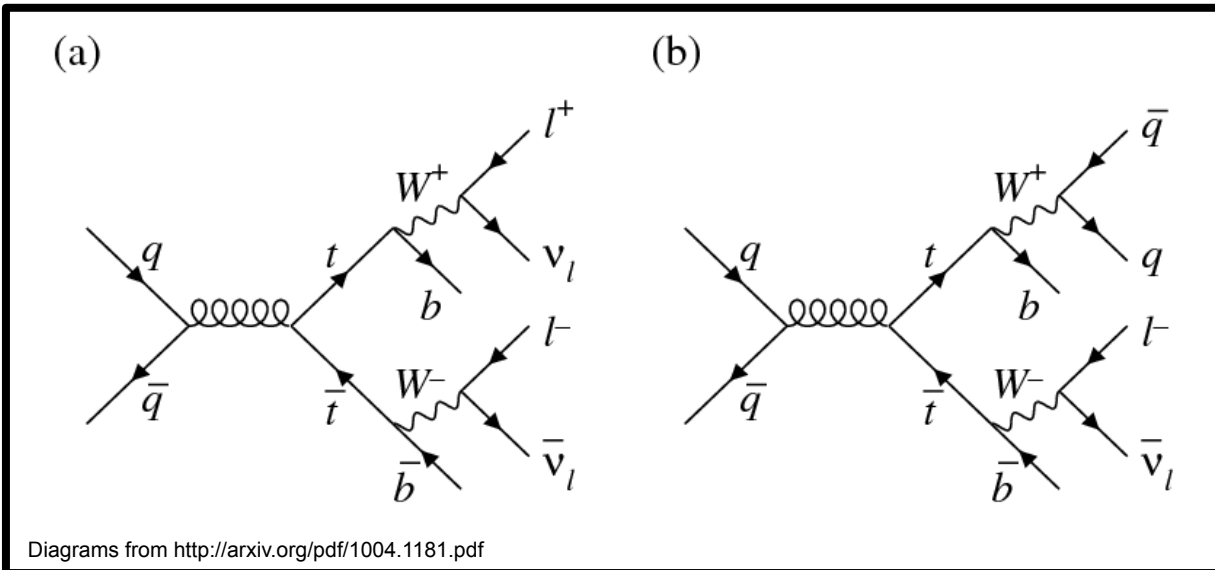
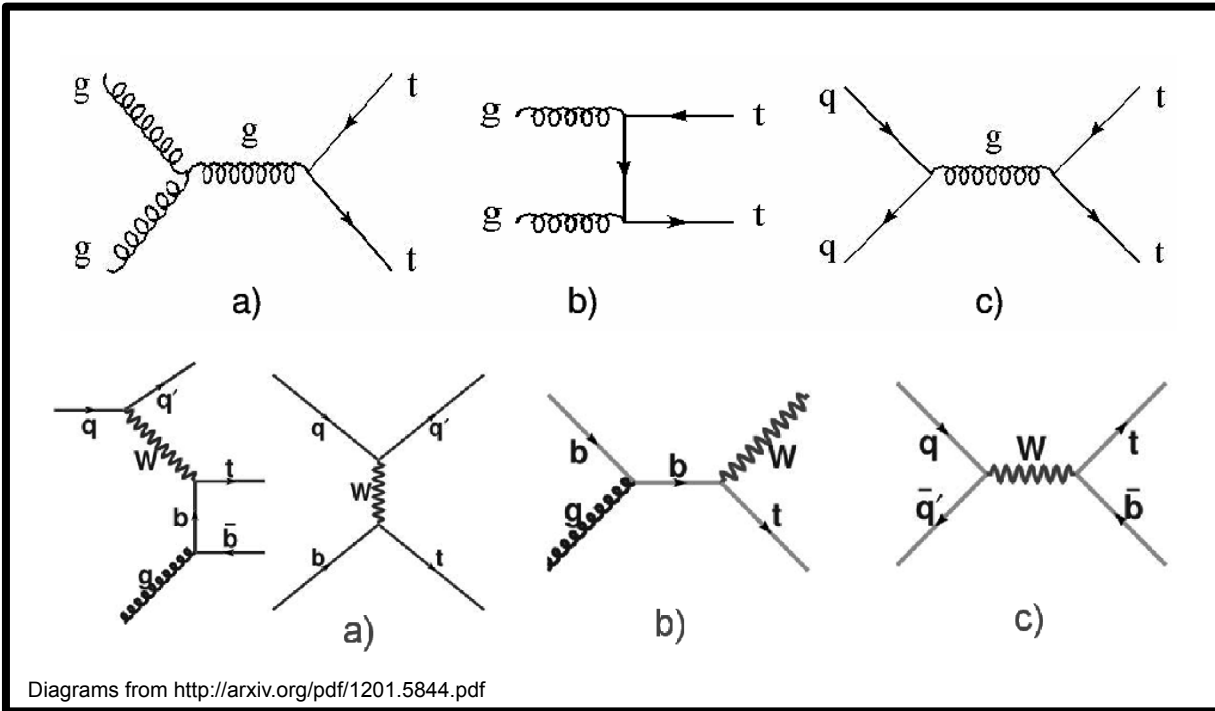

AND THE HIGGS!

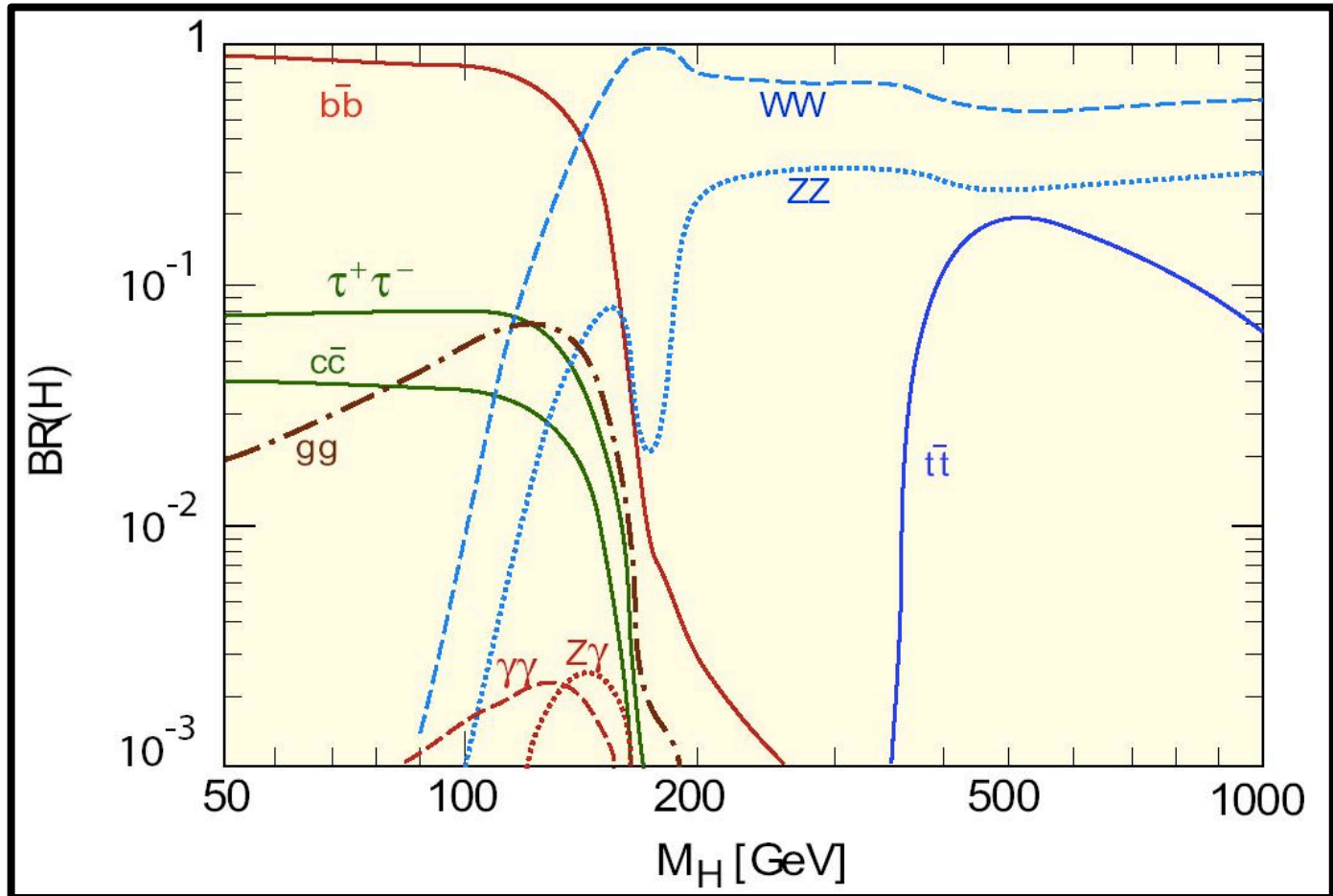

HOW ABOUT NEW PARTICLES?

These decay to Standard Model particles or create Missing Energy...

E.g.

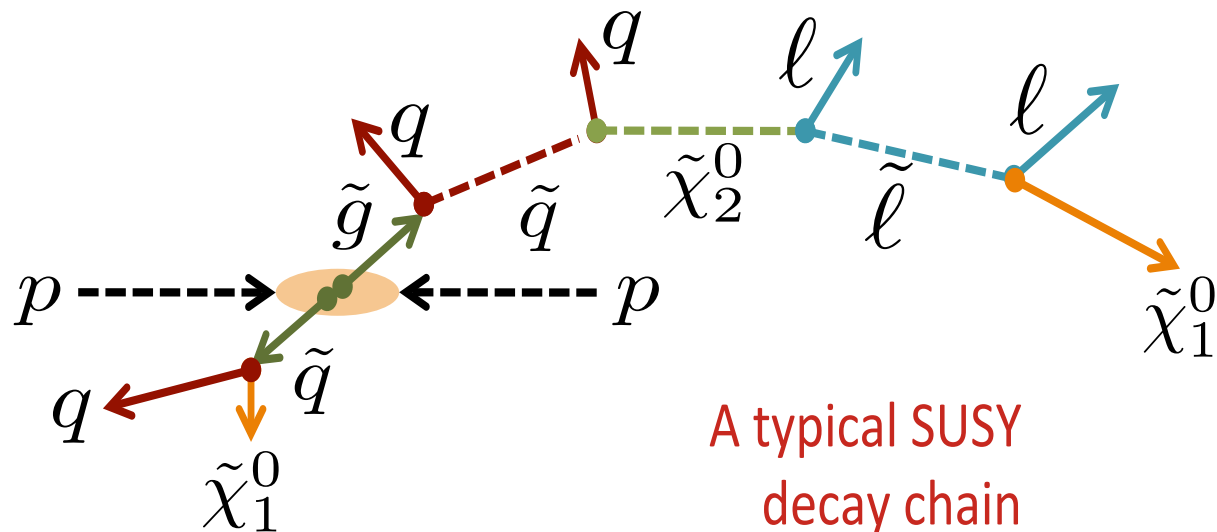

PHYSICS ANALYSES

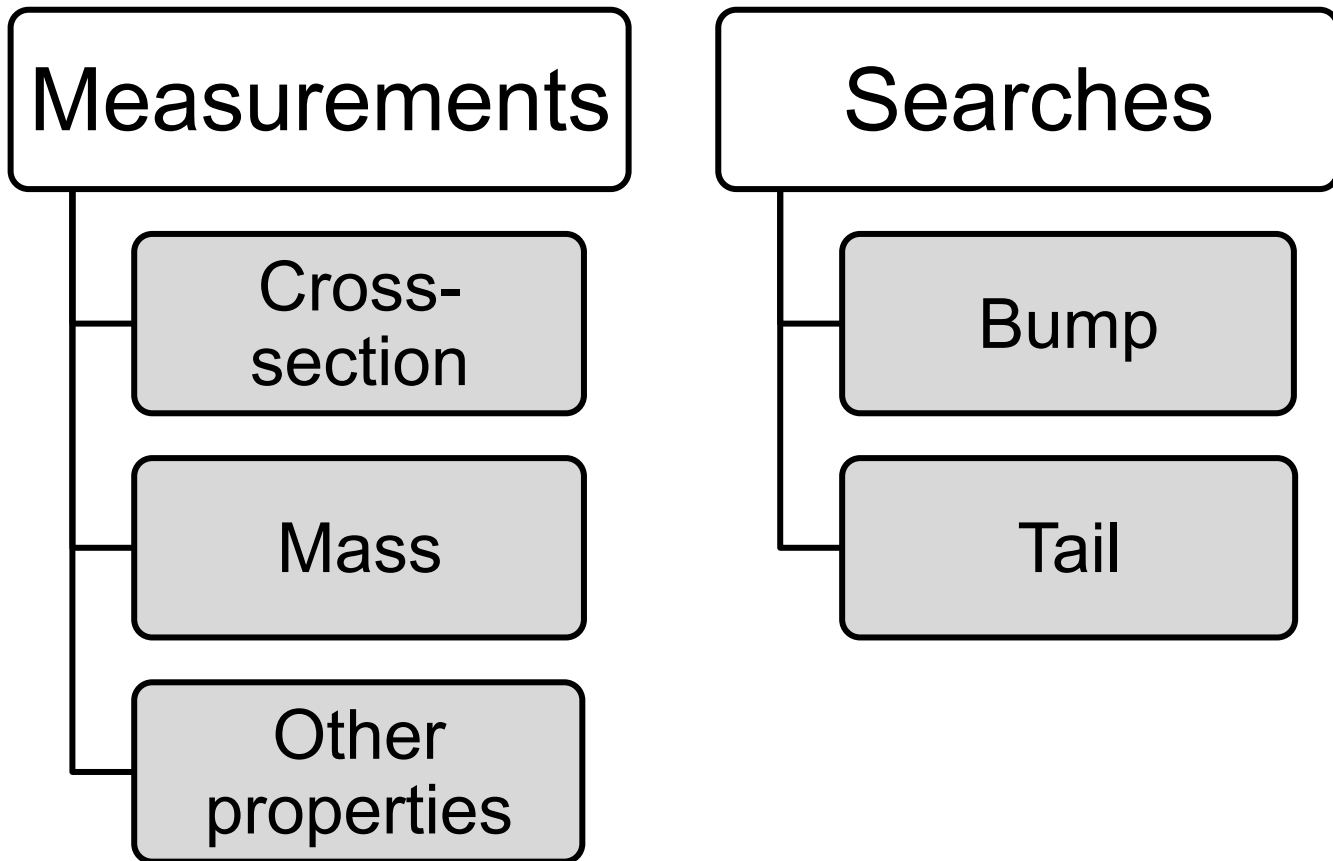

END OF LECTURE 2

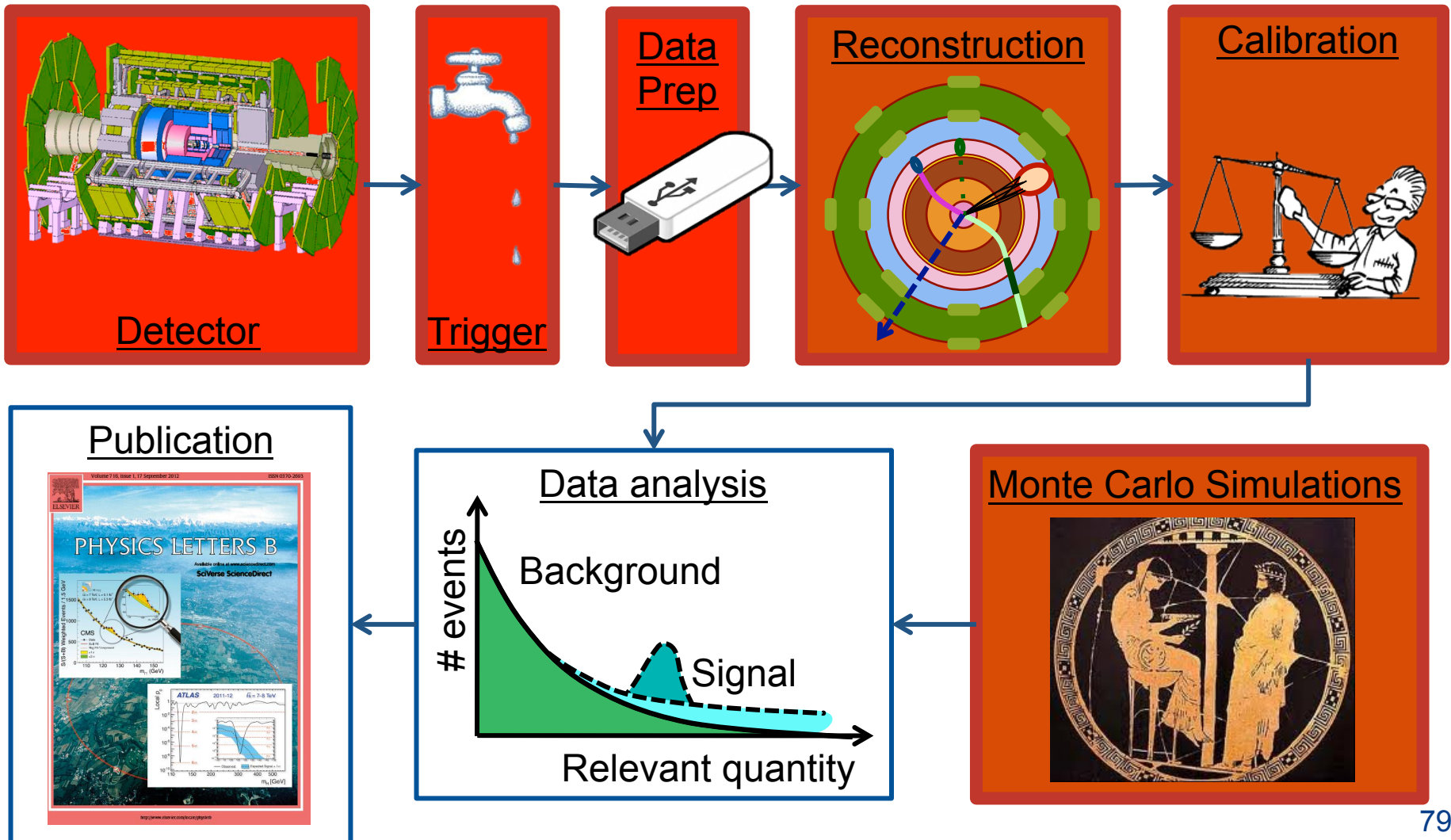

LECTURE 3

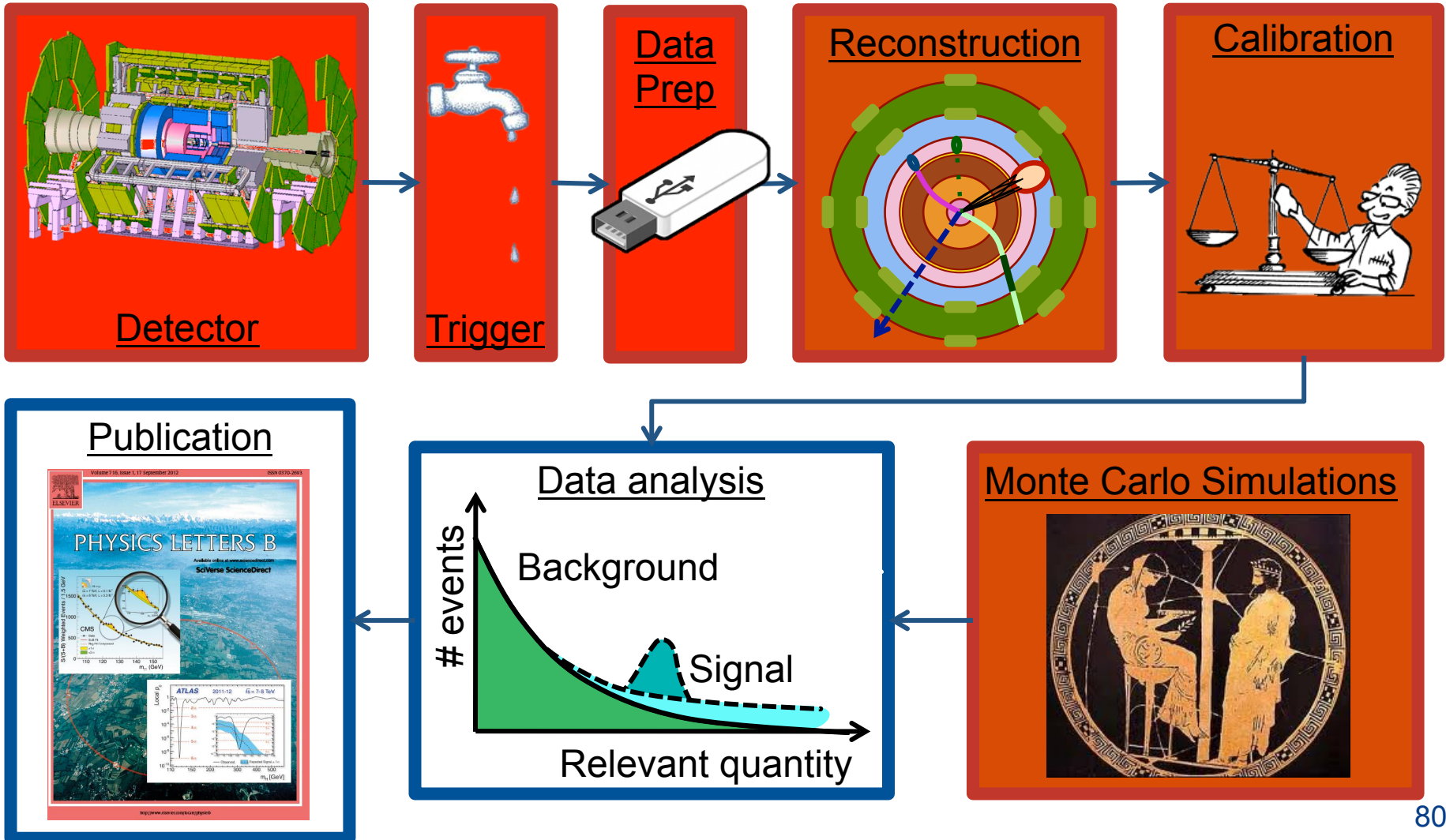

BACKUP

BJETS

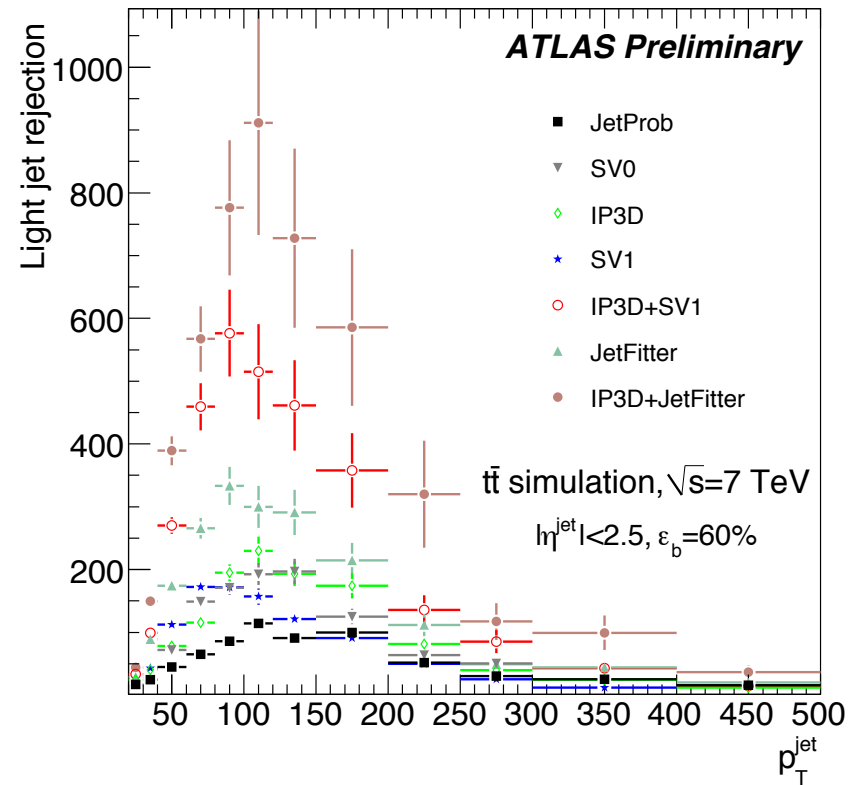
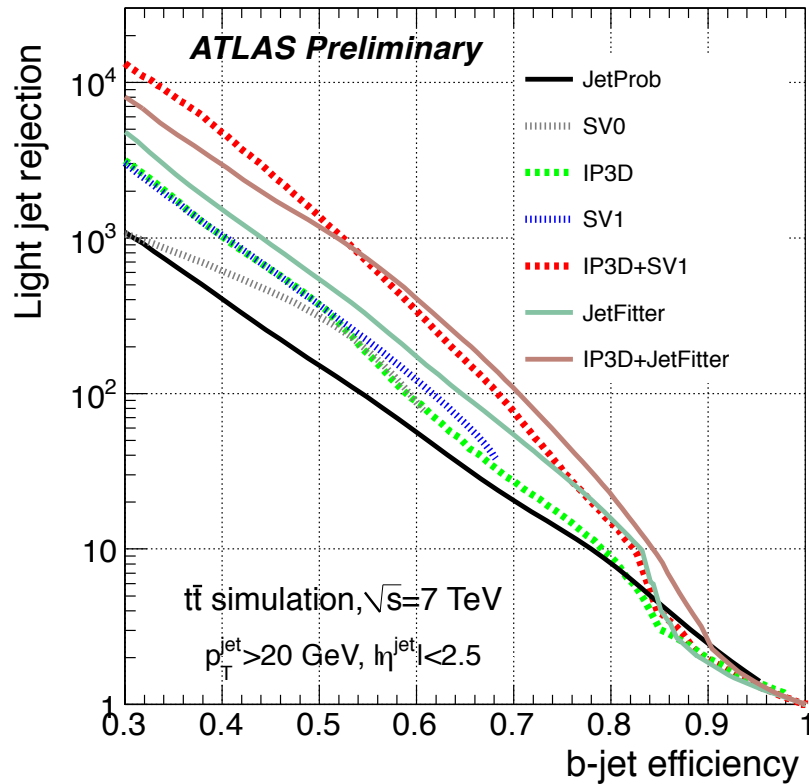

MISSING TRANSVERSE MOMENTUM

Impossible to measure particles that don't interact in the detector.

➤ Instead, measure everything else & require momentum conservation in the transverse plane.

⊙ Sensitive to pile-up and detector problems.

Only as good as its inputs.

⊙ Use calibrated physics objects: electrons, photons, muons, taus, jets.

⊙ Add remaining soft energy.

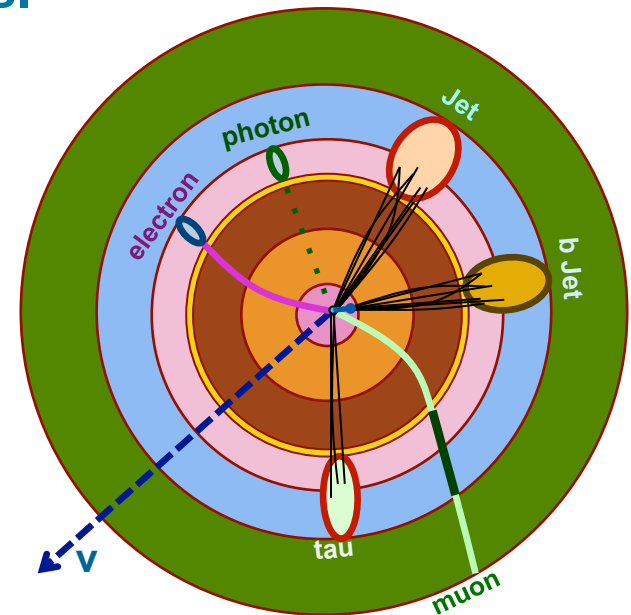

MISSING ET – PILEUP & TAILS

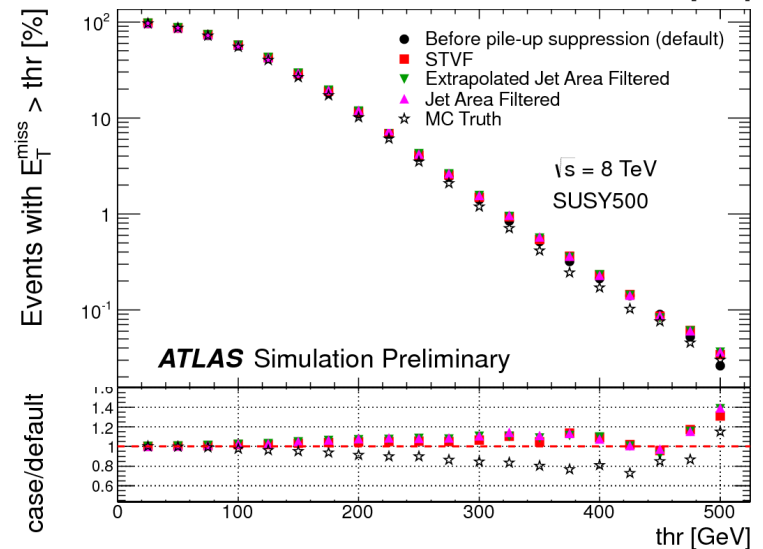
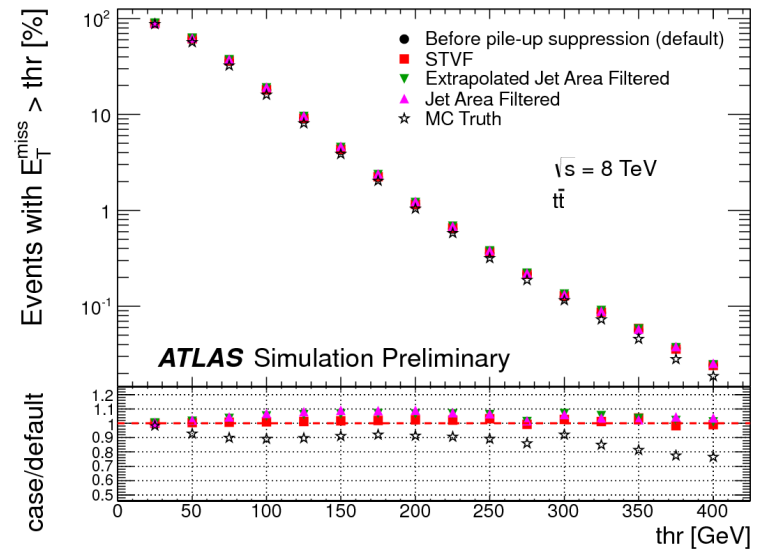
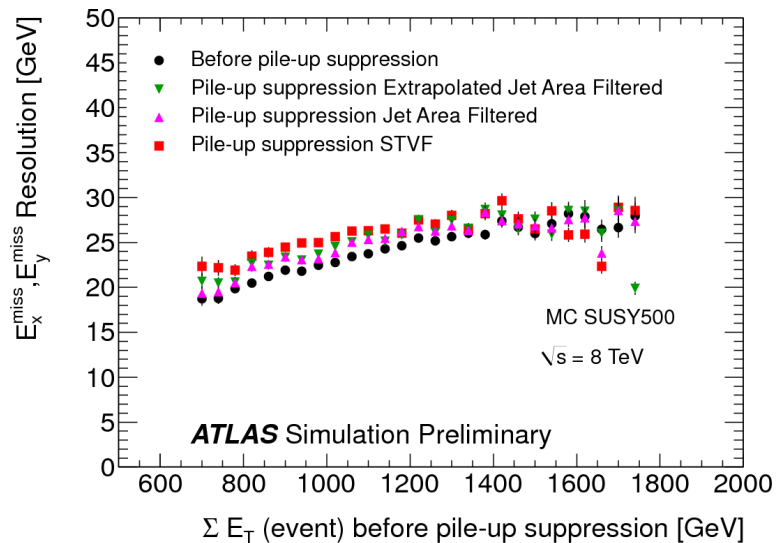
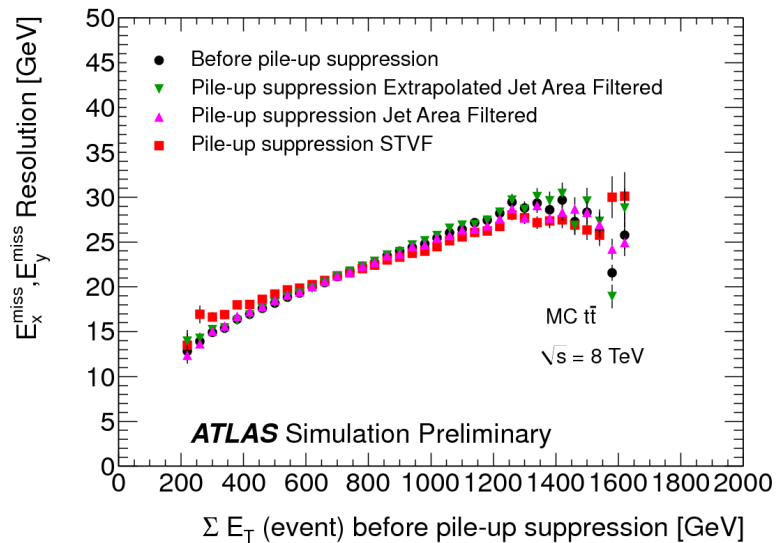

GRAND ATLAS (non-BSM) PHYSICS SUMMARY

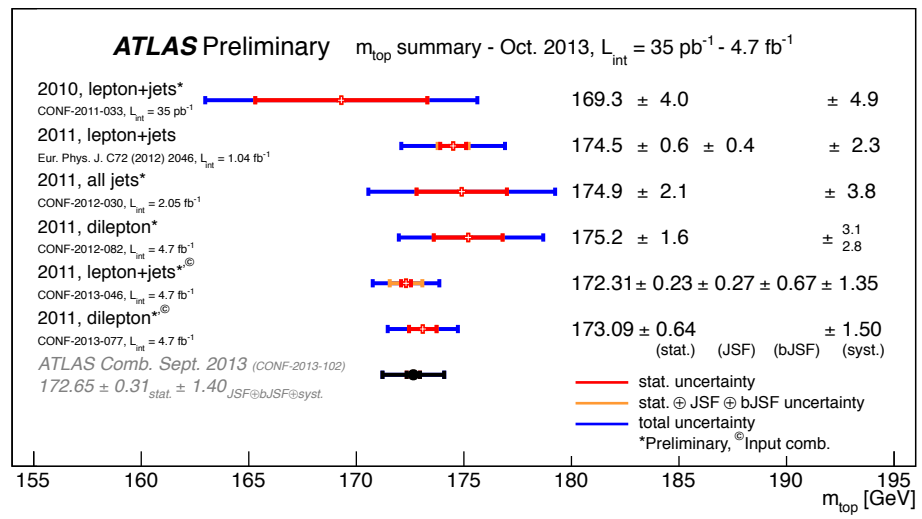
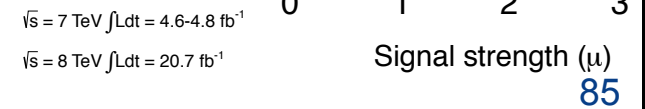
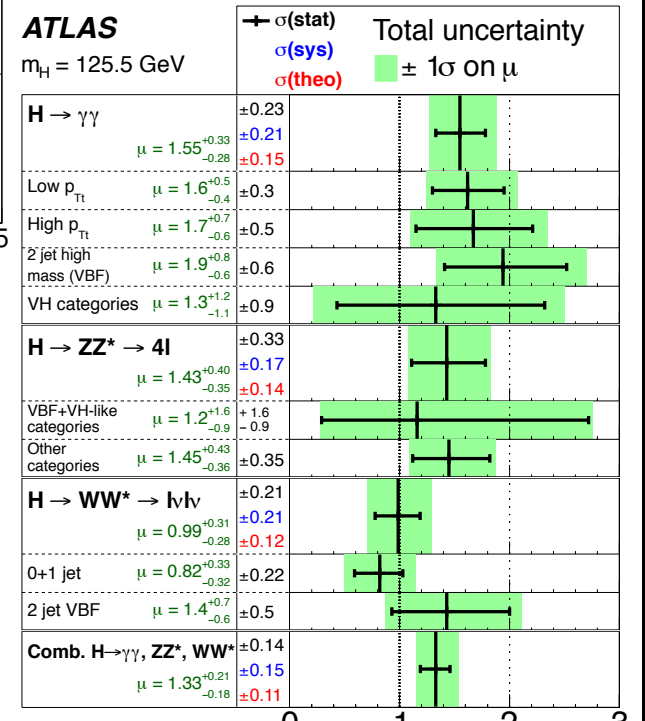
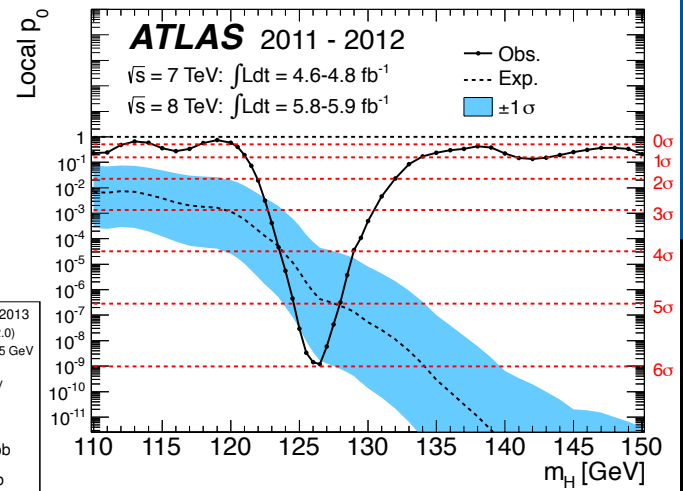
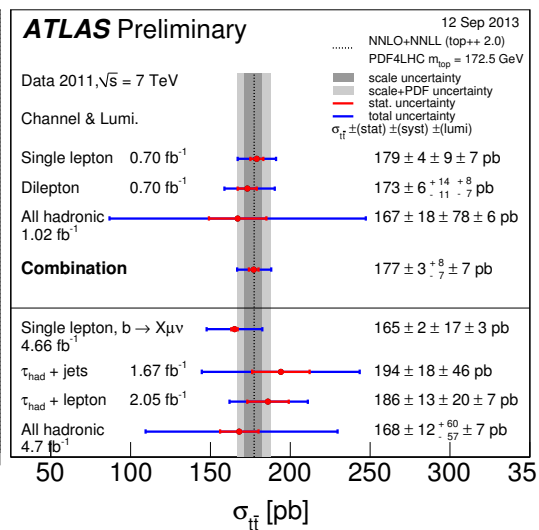
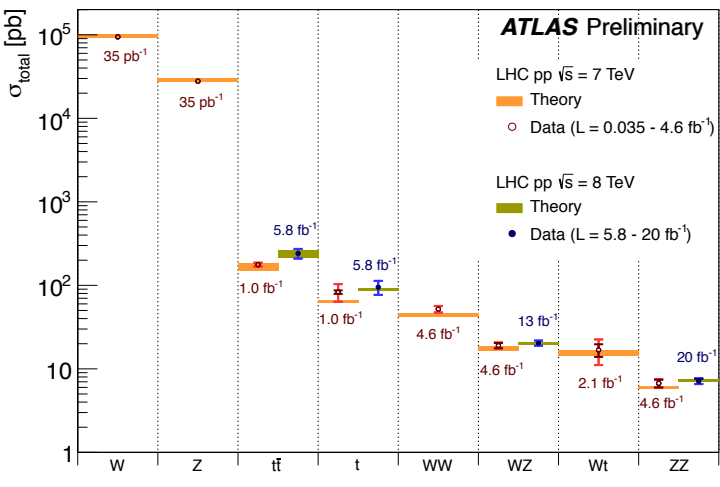

B-JET

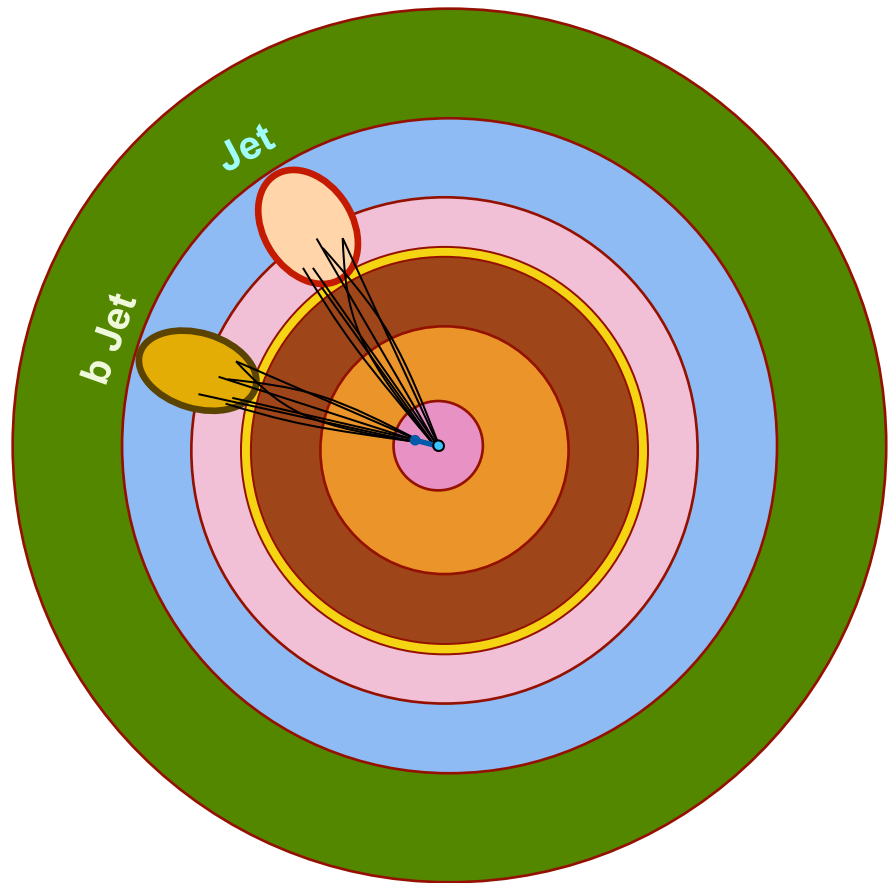

STANDARD MODEL SUMMARY

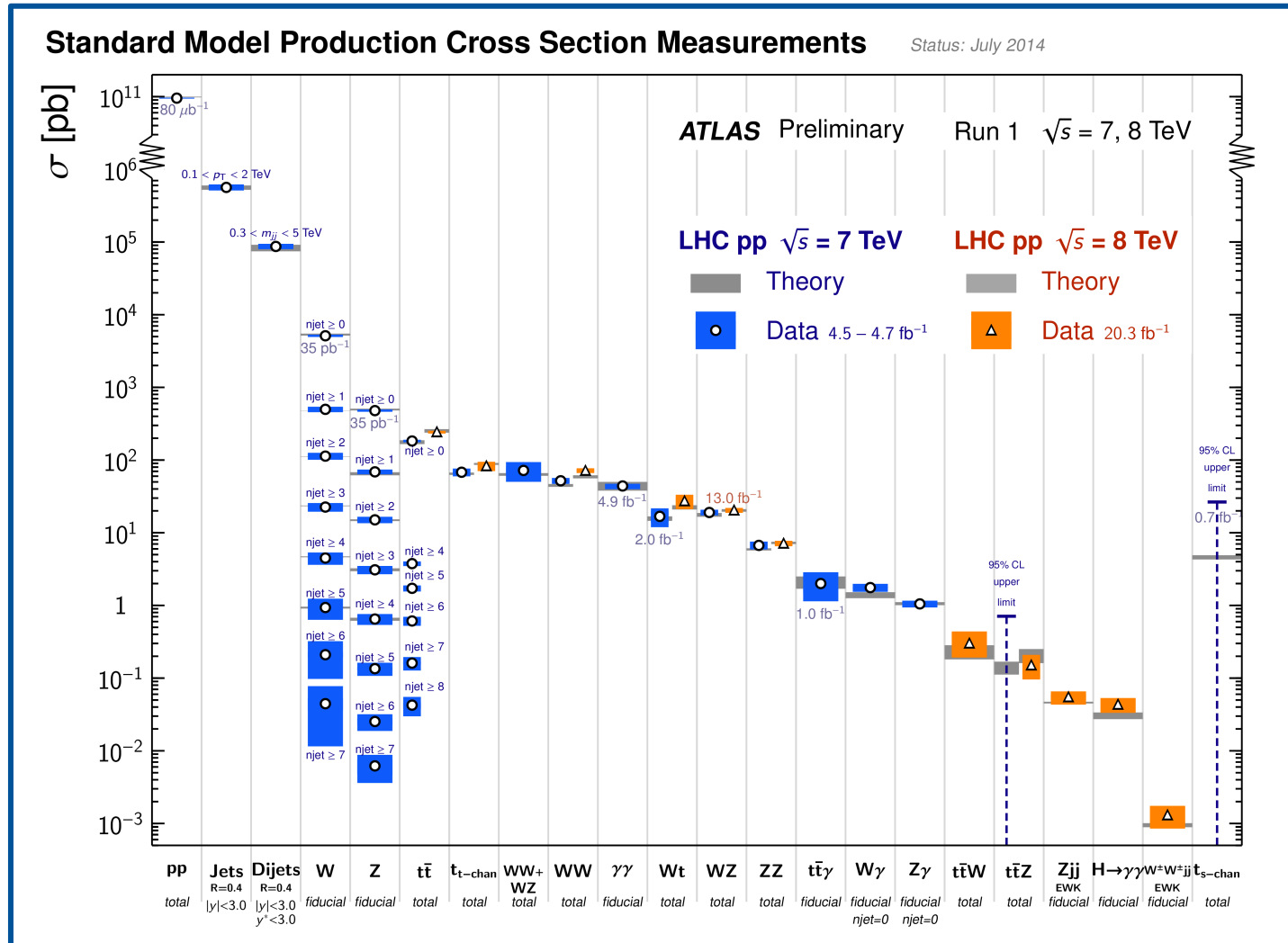

THE SUSY MULTIJET SEARCH

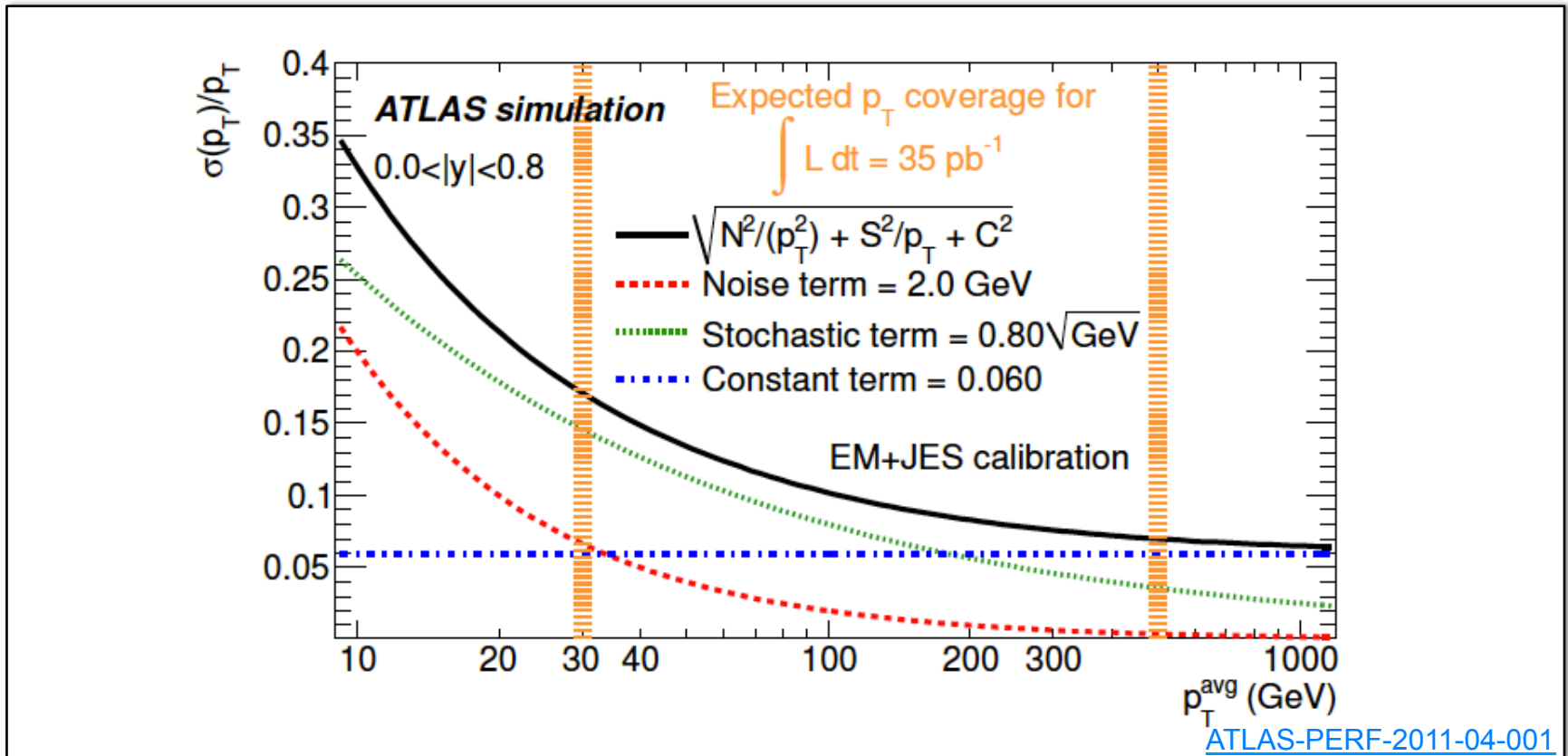

Why $ME_T/\sqrt{H_T}$?

\Rightarrow a measure of ME_T in units of standard deviations of the fake ME_T

$$\frac{\sigma_{p_T}}{p_T} = \frac{N}{p_T} \oplus \frac{S}{\sqrt{p_T}} \oplus C$$

MULTI-JET BACKGROUND

Flavour stream

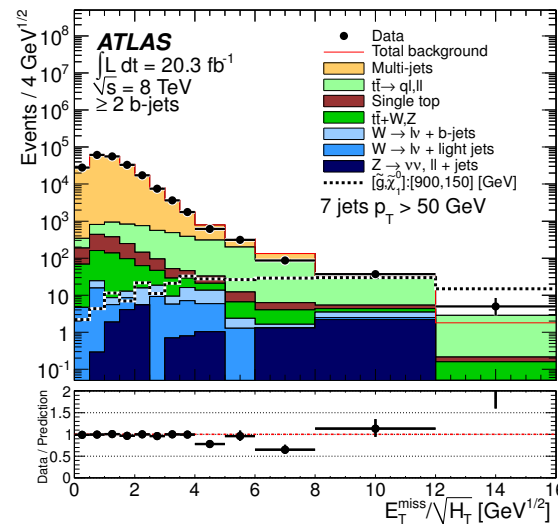
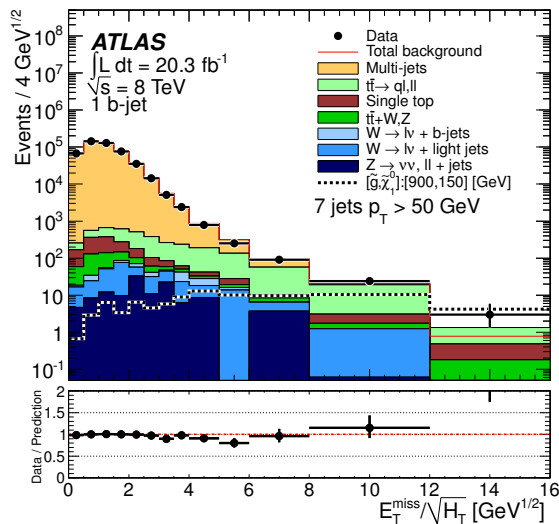
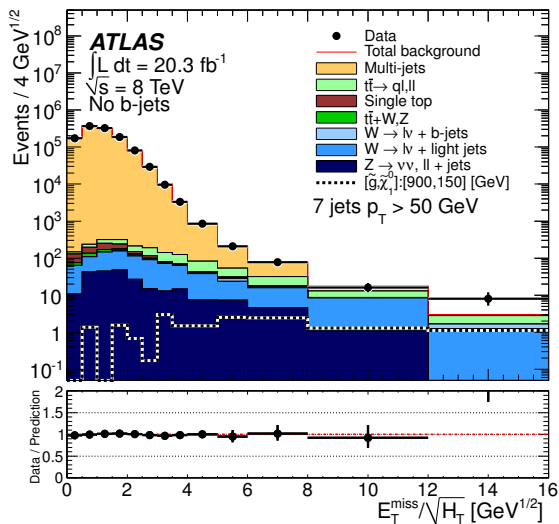

MJ stream

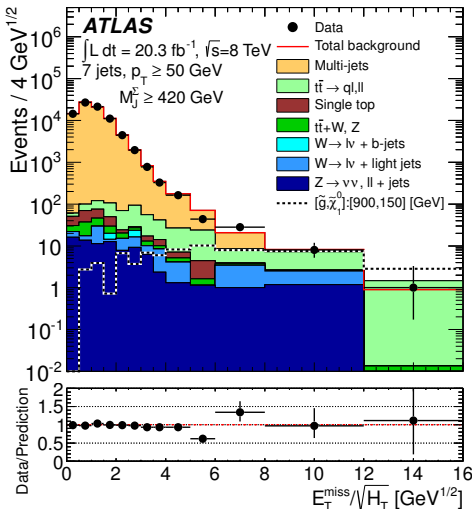
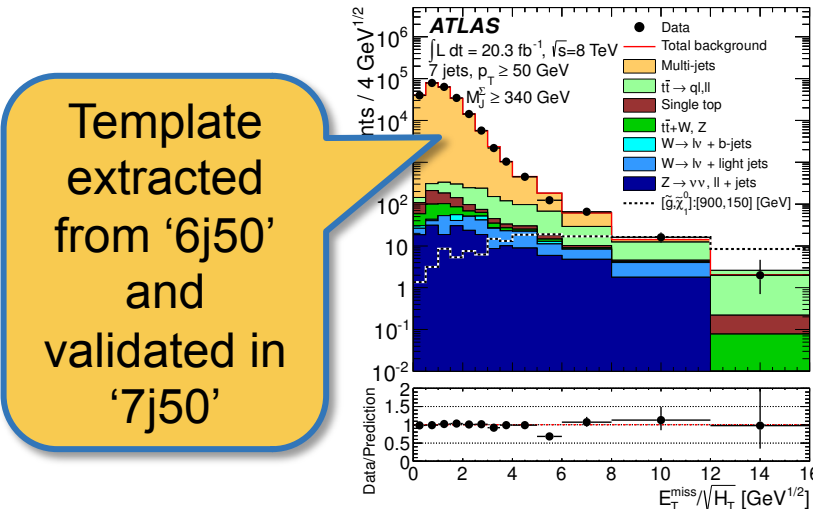

Template extracted from '6j50' and validated in '7j50'

Discrepancies in control regions become uncertainties – dominant, on top of heavy flavour and 'leptonic' backgrounds.

LEPTONIC BACKGROUNDS

- © ttbar (non-full-hadronic) + jets and W/Z + jets.
- © Scale MC in control regions in data (through a multi-bin fit).

Single-lepton validation region	
Lepton p_T	$> 25 \text{ GeV}$
Lepton multiplicity	Exactly one, $\ell \in \{e, \mu\}$
E_T^{miss}	$> 30 \text{ GeV}$
$E_T^{\text{miss}}/\sqrt{H_T}$	$> 2.0 \text{ GeV}^{1/2}$
m_T	$< 120 \text{ GeV}$
Jet p_T	As for signal regions (table 1)
Jet multiplicity	
b -jet multiplicity	
M_J^Σ	
Control region (additional criteria)	
Jet multiplicity	Unit increment if $p_T^\ell > p_T^{\text{min}}$
$E_T^{\text{miss}}/\sqrt{H_T (+p_T^\ell)}$	$> 4.0 \text{ GeV}^{1/2}$

Two-lepton validation region	
Lepton p_T	$> 25 \text{ GeV}$
Lepton multiplicity	Exactly two, ee or $\mu\mu$
$m_{\ell\ell}$	80 GeV to 100 GeV
Jet p_T	As for signal regions (table 1)
Jet multiplicity	
b -jet multiplicity	
M_J^Σ	
Control region (additional criteria)	
$ \mathbf{p}_T^{\text{miss}} + \mathbf{p}_T^{\ell_1} + \mathbf{p}_T^{\ell_2} /\sqrt{H_T}$	$> 4.0 \text{ GeV}^{1/2}$

- © Uncertainties dominating the leptonic background determination: JES/JER, b -tagging, pile-up and theory.

LEPTONIC BACKGROUND

Flavour stream

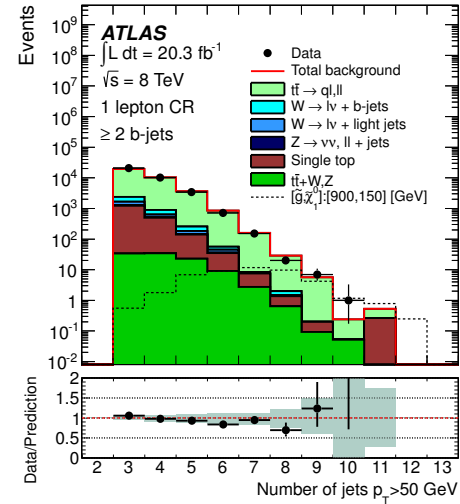
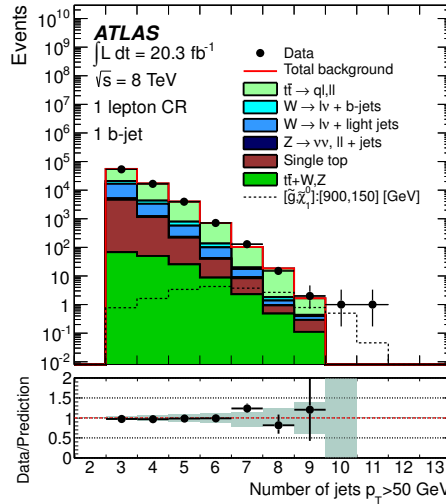
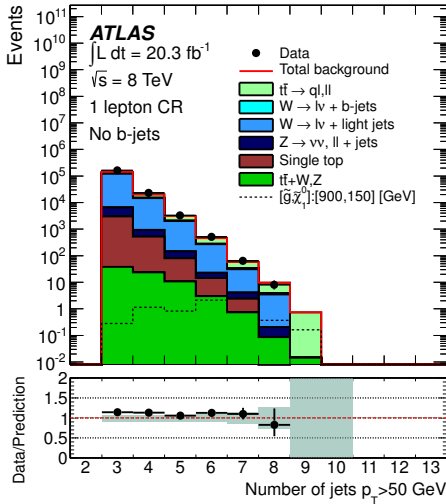

MJ stream

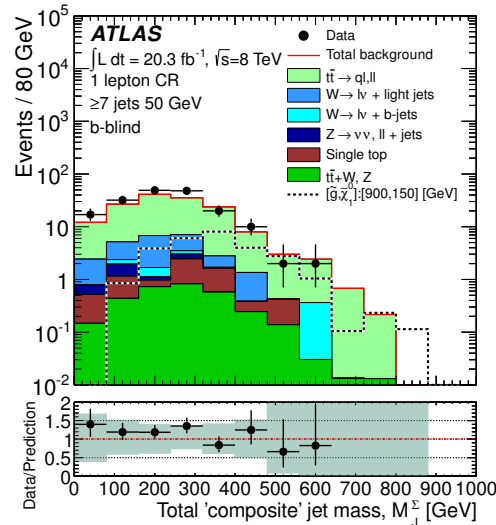
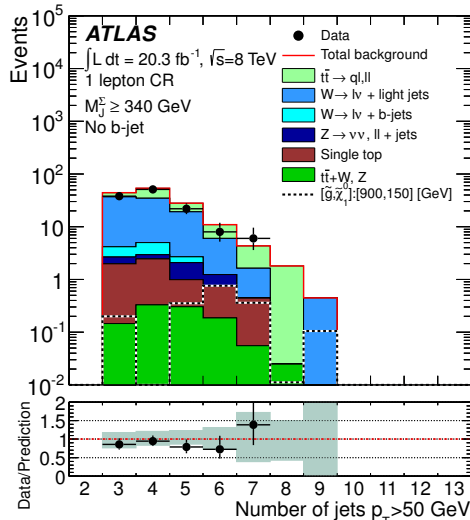

Uncertainties dominating the leptonic background determination: JES/JER, b-tagging, pile-up and theory.

THE STATISTICAL TREATMENT

Flavour stream

Simultaneous fit in the 'j50' and 'j80' signal regions separately.

- ⊙ **ttbar & W+jets:** one control region per signal region.
Normalization allowed to vary freely in the fit.
- ⊙ **Other less significant backgrounds;** determined using MC.
Constrained by their uncertainties.
- ⊙ **Multijet background;** not constrained by control regions.
Constrained by its uncertainties.

MJ stream

A fit performed in each signal region to adjust the normalization of ttbar and W backgrounds.

INTERPRETATIONS

'Real models'

© A minimal model, **Constraint Minimal SUSY (CMSSM)** (mSugra, i.e. gravity-mediated, based) only has 5 free parameters:

- Scalar mass parameter, m_0
- Gaugino mass parameter, $m_{1/2}$
- Trilinear Higgs-sfermion-sfermion coupling, A_0
- Ratio of Higgs vacuum expectation values, $\tan\beta$
- Sign of SUSY Higgs parameter, $\text{sign}(\mu)$

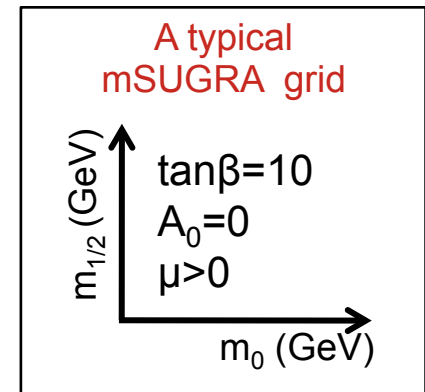

'Simplified models'

© **Simplified topologies with typically one production and one decay process. Provide useful information for theorists.**

INTERPRETATIONS

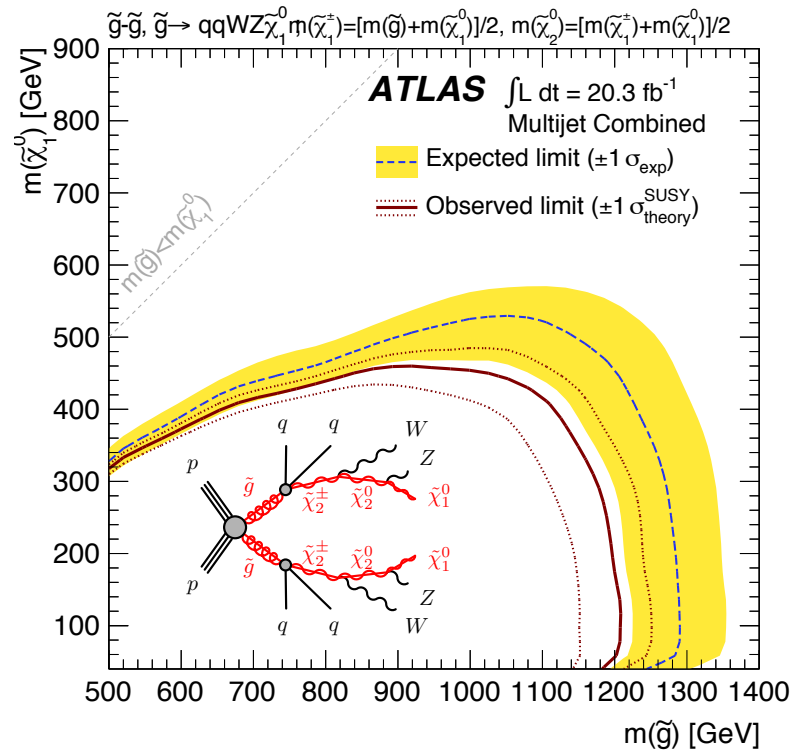
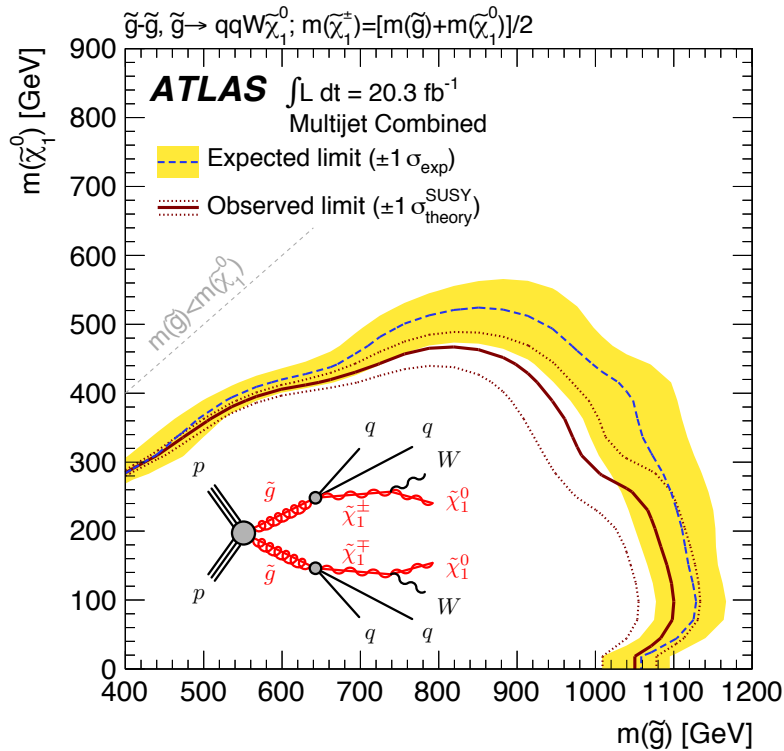

INTERPRETATIONS

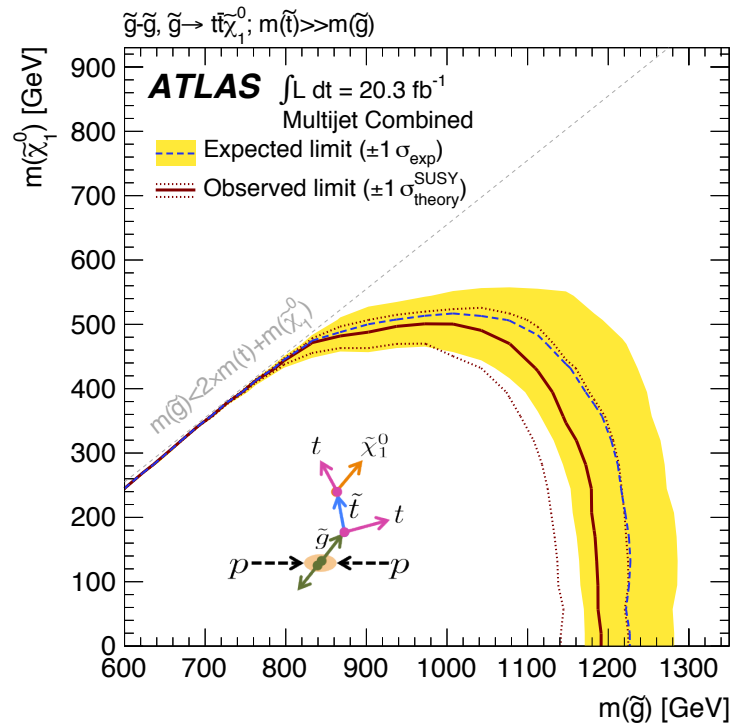
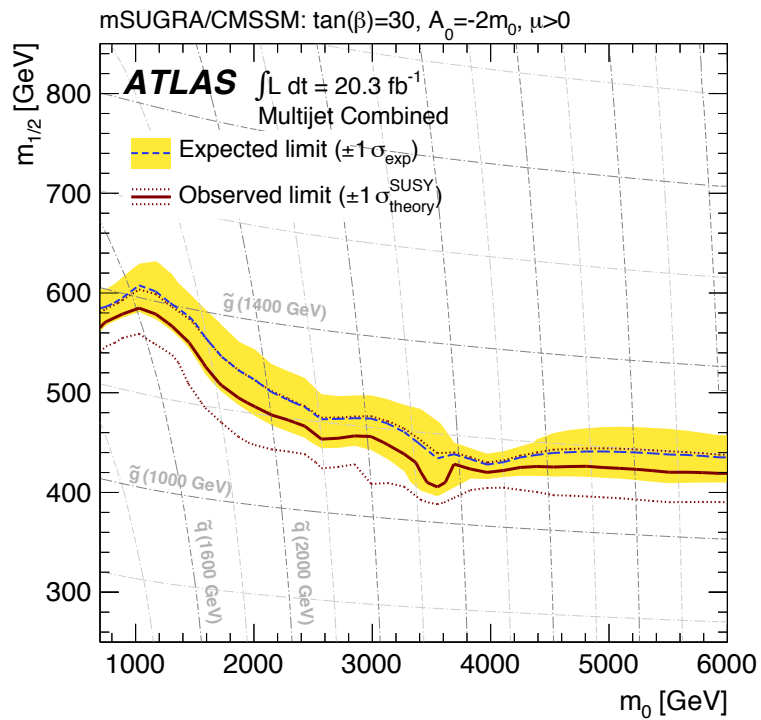

INTERPRETATIONS

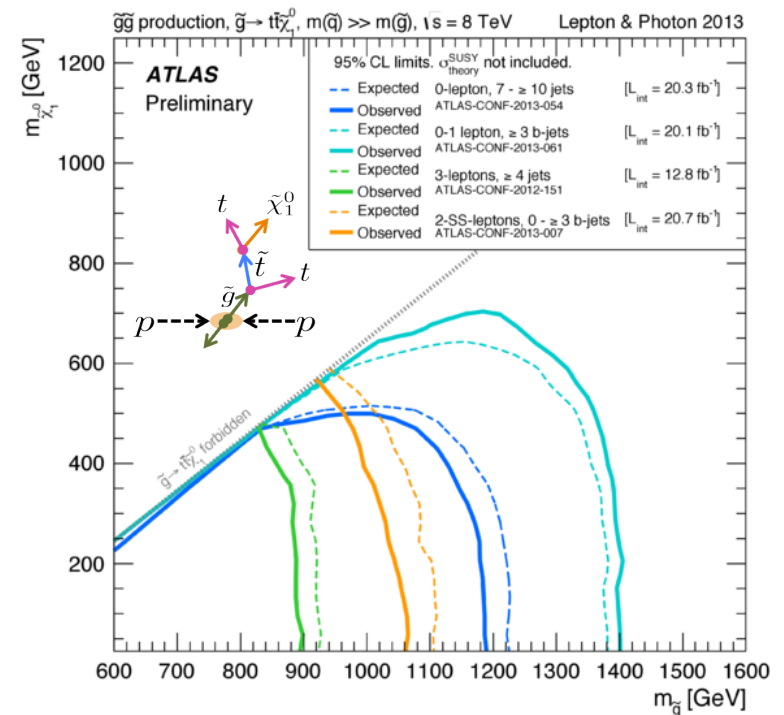
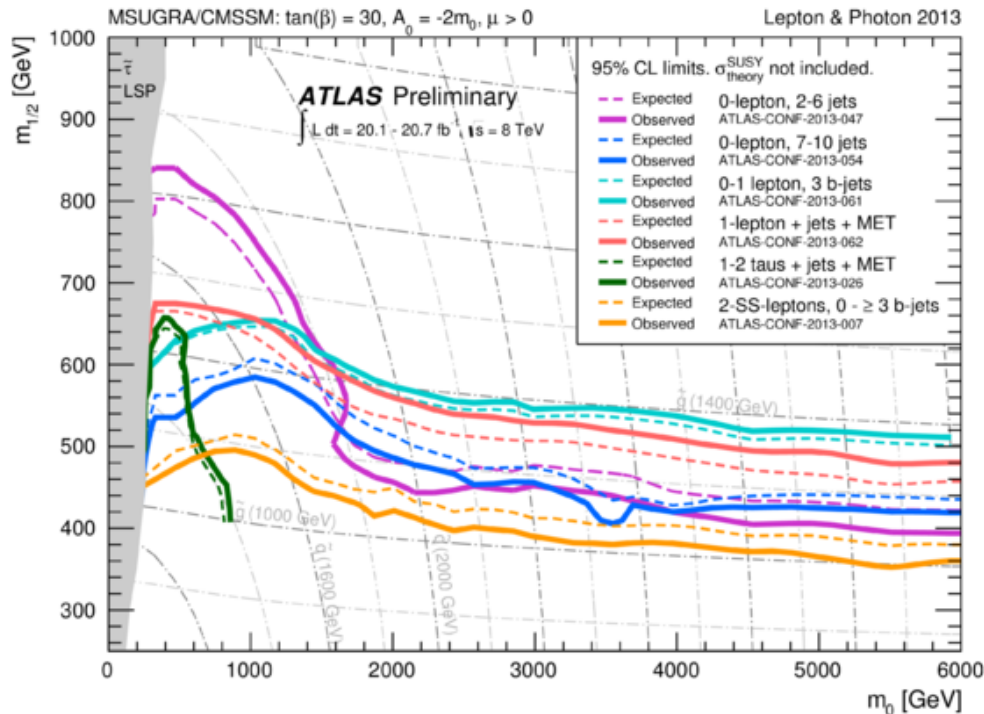

- ⊙ Note that the multijet analysis is not optimized for a specific model, it is built to be as model-independent as possible.
- ⊙ Multijet analysis is strong in other simplified models, e.g. gluino pair production via 2-step decay to 12 jets.

QCD BACKGROUNDS IN SUSY

All (SUSY) analyses use data-driven methods for assessing multi-jet SM production.

Monte Carlo can not be used when large multiplicities are involved:

- ⊙ Inclusive multi-jet / multi-parton samples provided by Monte Carlo generators recently only.
 - ⊙ E.g. only very latest Sherpa release provides NLO calculations up to four jets.
- ⊙ Monte Carlo predictions have not yet been validated with multi-jet data.
- ⊙ **Detailed comparisons between data and various Monte Carlo generators and theoretical predictions would provide extremely useful input to the theory community in understanding QCD.**
 - ⊙ They would also provide a great understanding of a dominant SUSY background in view of run2.

E.G. FOUR-JET TOPOLOGIES & OBSERVABLES

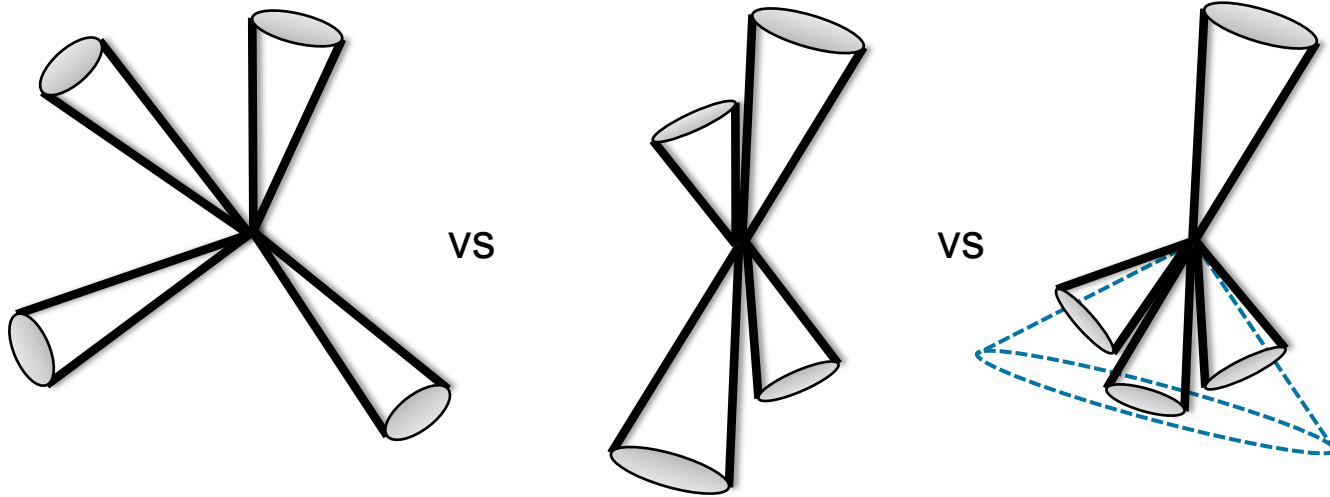

Category	Variable
Simple kinematic & ratios	$p_T, \eta, \phi, HT, p_{T_i}/p_{T_j}$
Angles	$\Delta\eta_{ij}, \Delta\phi_{ij}, \Delta R_{ij}$
Masses & ratios	$m_{ij}, m_{ijk}, m_4, m_i/m_{ij}, m_i/m_{ijk}, m_i/m_4$
Event shapes	$\Sigma p_T^2 / \Sigma p^2$

E.G. FOUR-JET TOPOLOGIES & OBSERVABLES

Name	Definition	Comment
p_{Ti}	Transverse momentum of the i th jet	} Sorted descending in p_T
Y_i	Rapidity of the i th jet	
H_T	$\sum_{i=1}^4 p_{Ti}$	Scalar sum of the p_T of the four jets
M_{jjjj}	$\left(\sum_{i=1}^4 E_i\right)^2 - \left(\sum_{i=1}^4 \mathbf{p}_i\right)^2$	Invariant mass of the four jets
M_{jj}^{\min}	$\min_{\substack{i,j \in [1,4] \\ i \neq j}} \left((E_i + E_j)^2 - (\mathbf{p}_i + \mathbf{p}_j)^2 \right)$	Minimum invariant mass of any two jets
$\Delta\phi_{ij}^{\min}$	$\min_{\substack{i,j \in [1,4] \\ i \neq j}} (\phi_i - \phi_j)$	Min azimuthal separation of two jets
ΔY_{ij}^{\min}	$\min_{\substack{i,j \in [1,4] \\ i \neq j}} (Y_i - Y_j)$	Min rapidity separation of two jets
$\Delta\phi_{ijk}^{\min}$	$\min_{\substack{i,j,k \in [1,4] \\ i < j < k}} (\Delta\phi_{ij} + \Delta\phi_{jk})$	Min azimuthal separation between three jets
ΔY_{ijk}^{\min}	$\min_{\substack{i,j,k \in [1,4] \\ i < j < k}} (\Delta Y_{ij} + \Delta Y_{jk})$	Min rapidity separation between three jets
ΔY_{ij}^{\max}	$\Delta Y_{ij}^{\max} = \max_{i,j \in [1,4]} (Y_i - Y_j)$	Max rapidity difference between two jets
$\Sigma p_T^{\text{central}}$	Sum of p_T of the two central-rapidity jets	Excludes jets having ΔY_{ij}^{\max}

E.G. FOUR-JET MONTE CARLO SAMPLES

Name	Hard process	PDF	Parton shower	Underlying event	Tune
Pythia8-CT10	PYTHIA 8	CT10	PYTHIA 8	PYTHIA 8	AU2-CT10
Pythia8-CTEQ6L1	PYTHIA 8	CTEQ6L1(†)	PYTHIA 8	PYTHIA 8	AU2-CTEQ6L1
Herwig++	Herwig++	CTEQ6L1	Herwig++	Herwig++	UE-EE-3-CTEQ6L1
Alpgen+Herwig	Alpgen	CTEQ6L1	HERWIG 6	JIMMY	AUET2-CTEQ6L1
Alpgen+Pythia	Alpgen	CTEQ6L1	PYTHIA 6	PYTHIA 6	Perugia 2011C
Madgraph+Pythia	Madgraph	CTEQ6L1	PYTHIA 6	PYTHIA 6	AUET2B-CTEQ6L1
Sherpa	Sherpa		Sherpa	Sherpa	

Table 2: The different Monte Carlo generators used for comparison against the data are listed, together with the parton distribution functions, parton shower algorithms, underlying event and parameter tunes. (†) The Pythia8-CT6L1 sample uses CT10 when calculating the Matrix Element but CTEQ6L1 when simulating the parton shower and underlying event. The first listed sample (Pythia8-CT10) is used for the deconvolution of detector effects.

THE ATLAS TRIGGER SYSTEM

Rate (2012 conditions)

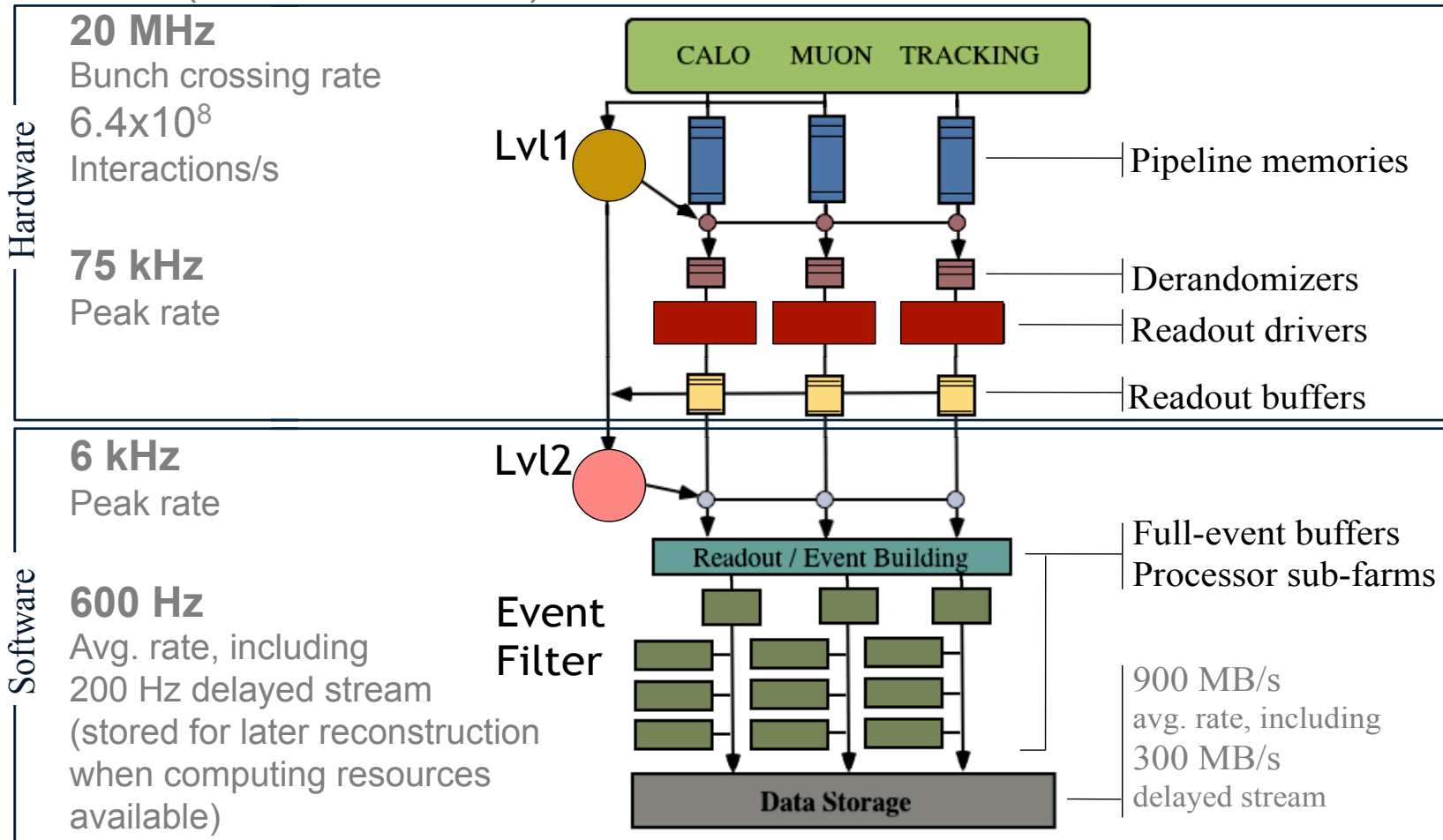

TRIGGER

Signal triggers		
Jet Multiplicity	pT cut	$ \eta $
6	45	3.2
5	55	

Background/support triggers	
Type	Purpose
Multijet (prescaled)	Efficiencies & Control regions
Single lepton	Control regions

Multijet trigger improvements in 2012

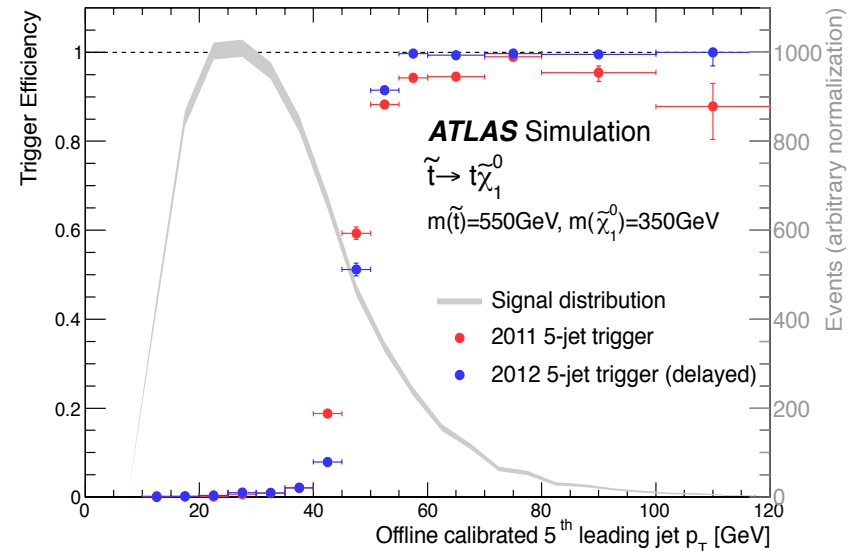
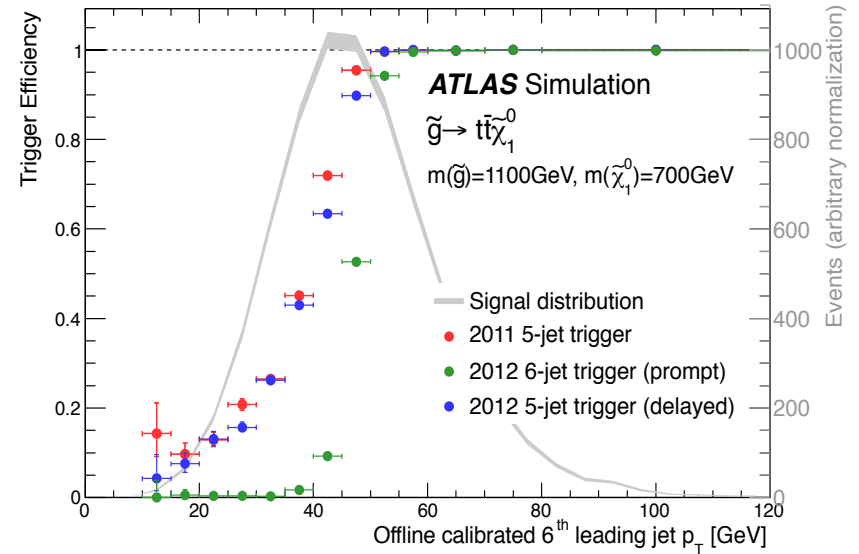

THE BENEFITS

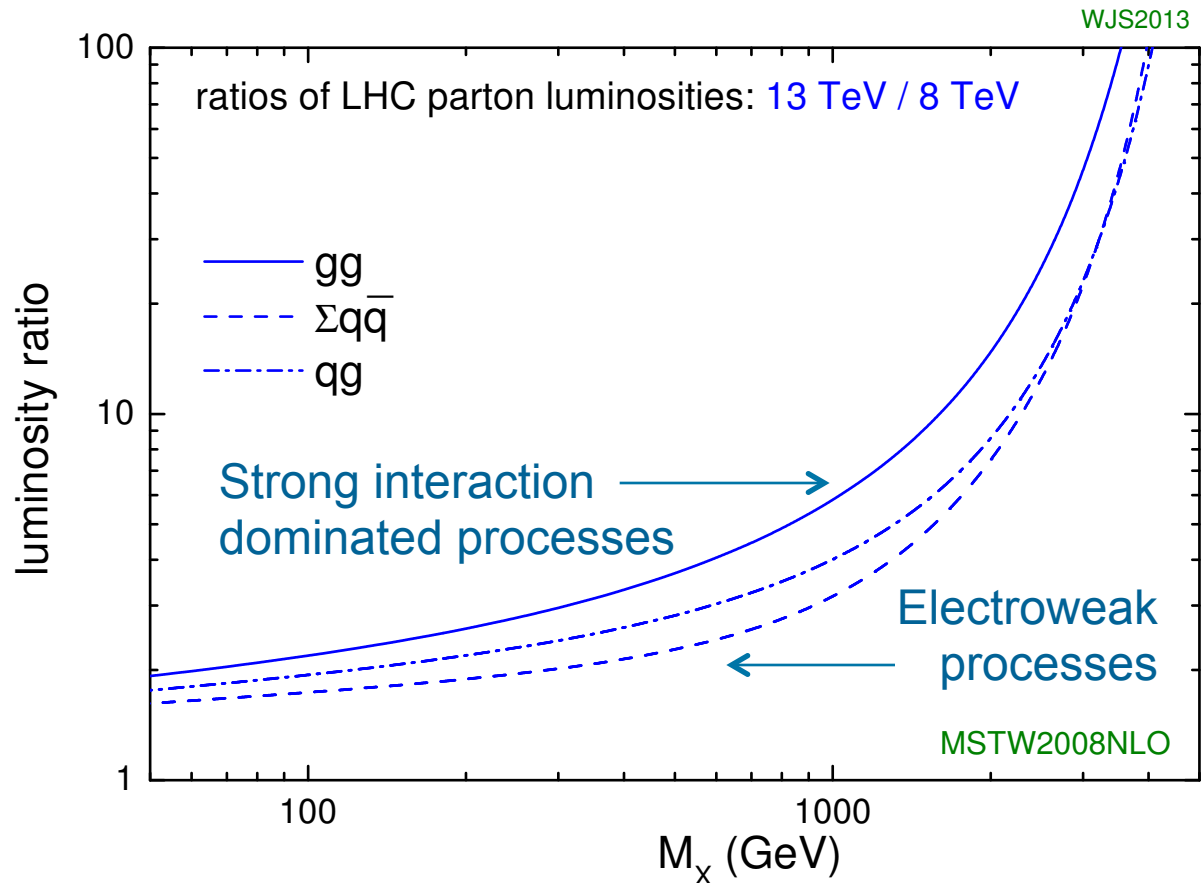

THE CHALLENGES

The calorimeter

Simulated noise in the Liquid Argon and Tile calorimeters at the electron scale

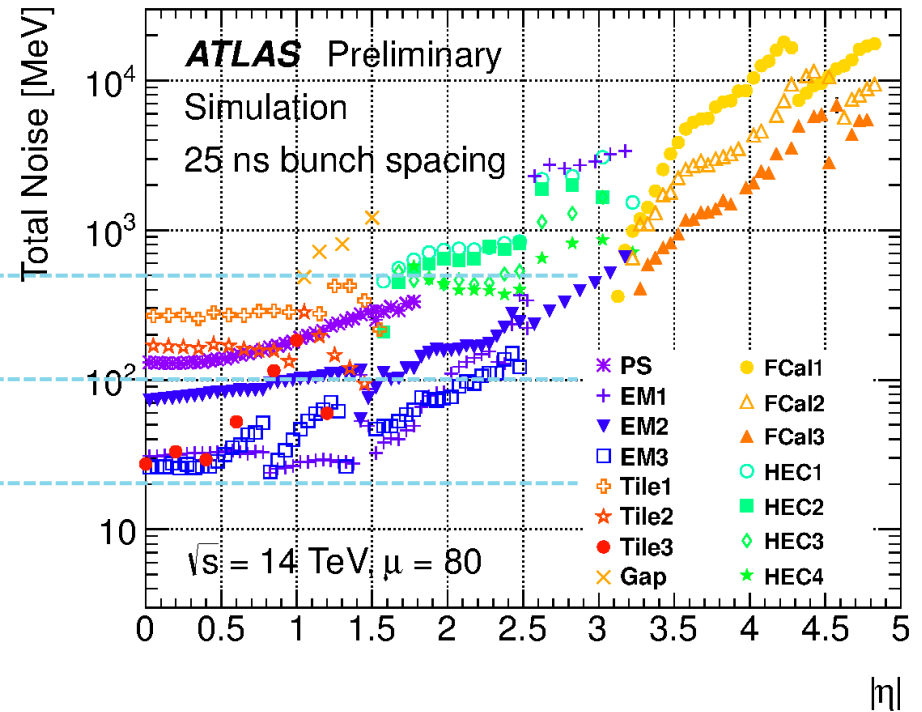
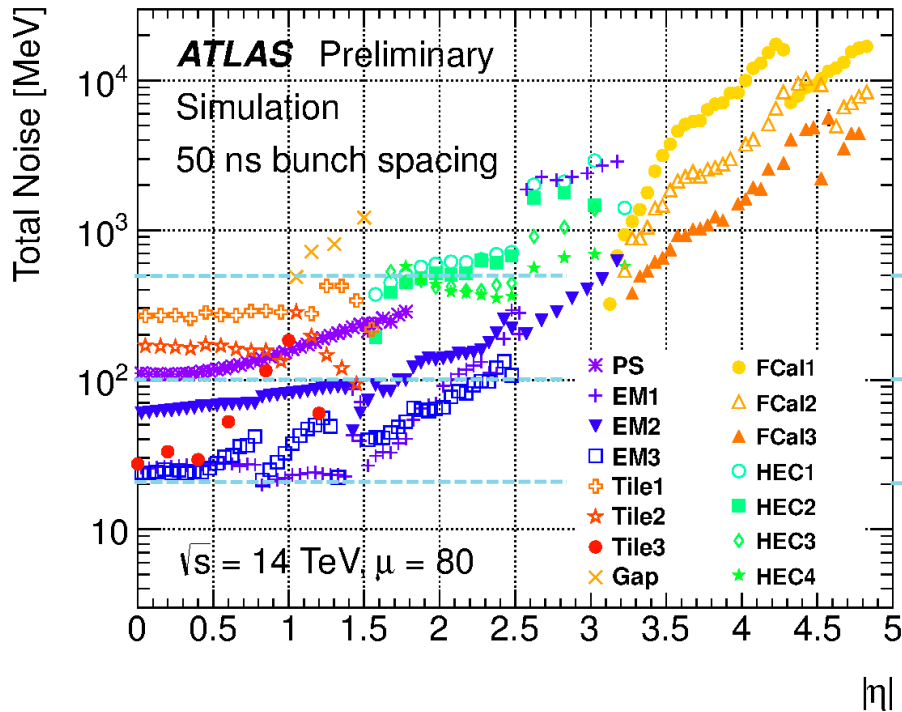

THE 'SOLUTIONS'

Detector extensions, e.g. extra muon chambers at $1.0 < |\eta| < 1.3$.

Ongoing trigger upgrade that will:

- ⊙ Increase the peak L1 rate to 100kHz.
- ⊙ Provide possibility to select on combined L1 quantities (angles, masses, etc).
- ⊙ Provide tracks at the input of the HLT for better object ID.
- ⊙ Ensure more efficient and flexible HLT reconstruction with a merged (L2 & EF) HLT.

Clever ideas for better & more robust object reconstruction.

THE PROSPECTS

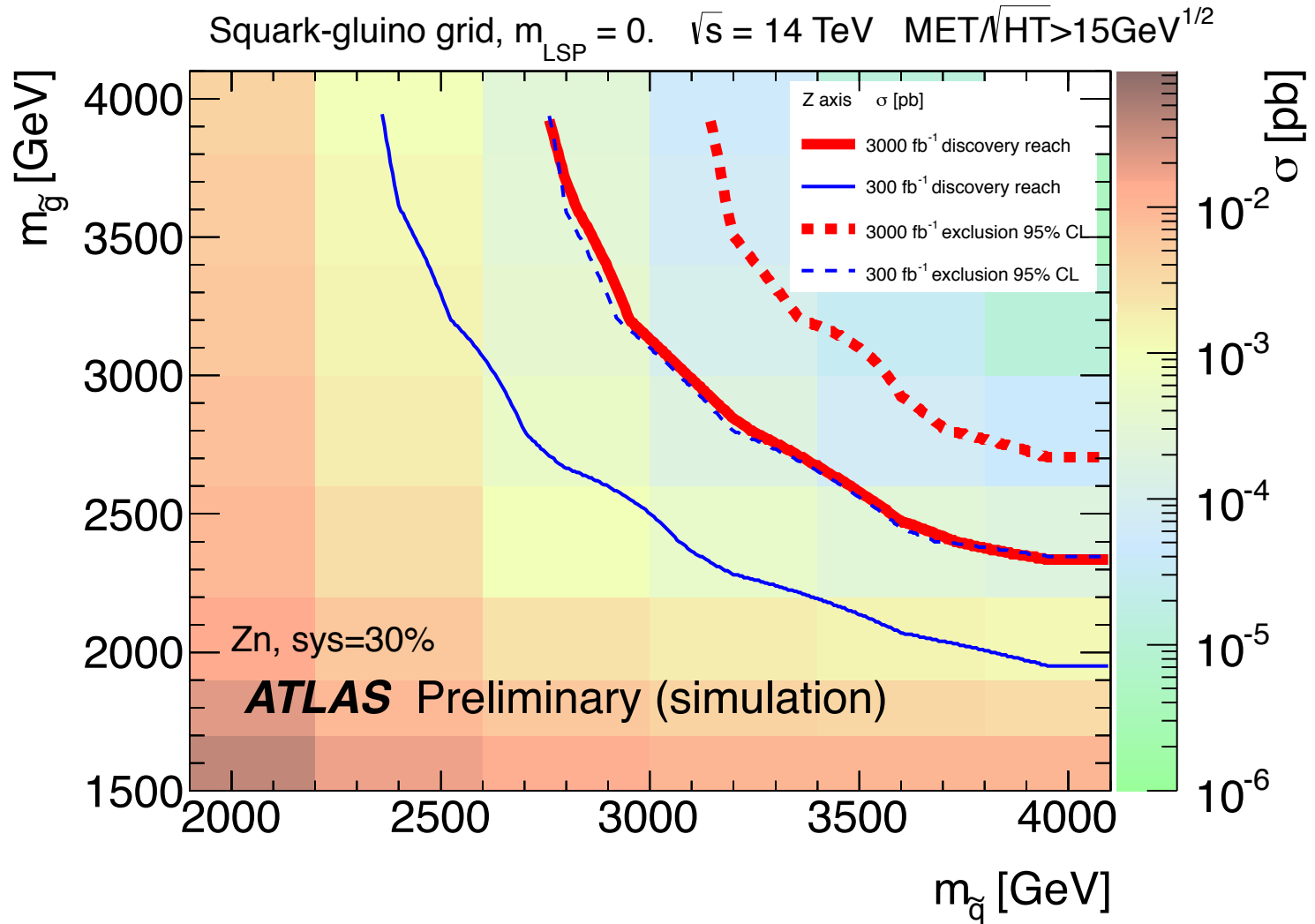

THE PROSPECTS

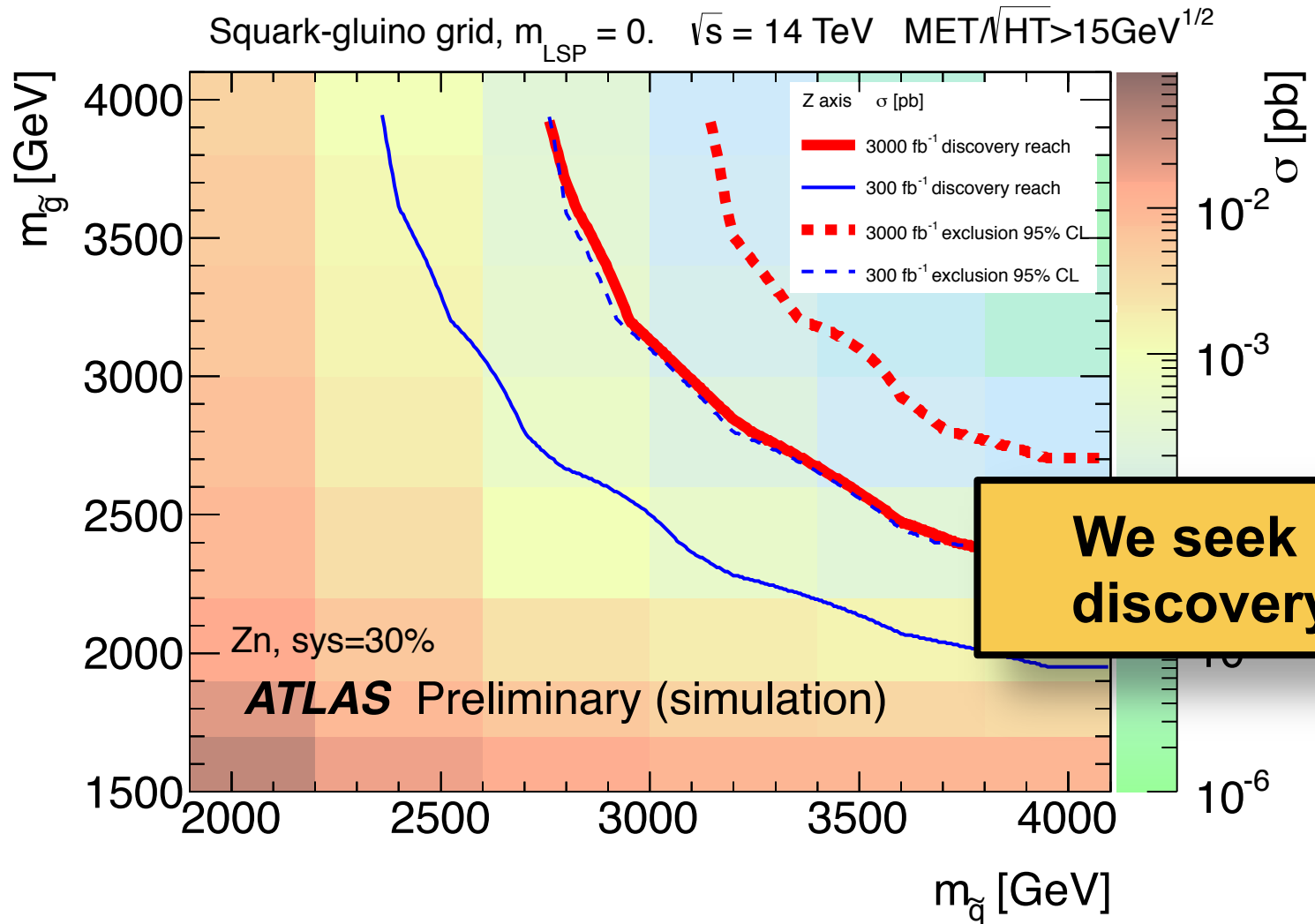

JETS

Detector inefficiencies
'Pile-up'
Electronic noise
Clustering, noise suppression
Dead material losses
Detector response
Algorithm efficiency

Algorithm efficiency
'Pile-up'
'Underlying event'

Physics process of interest

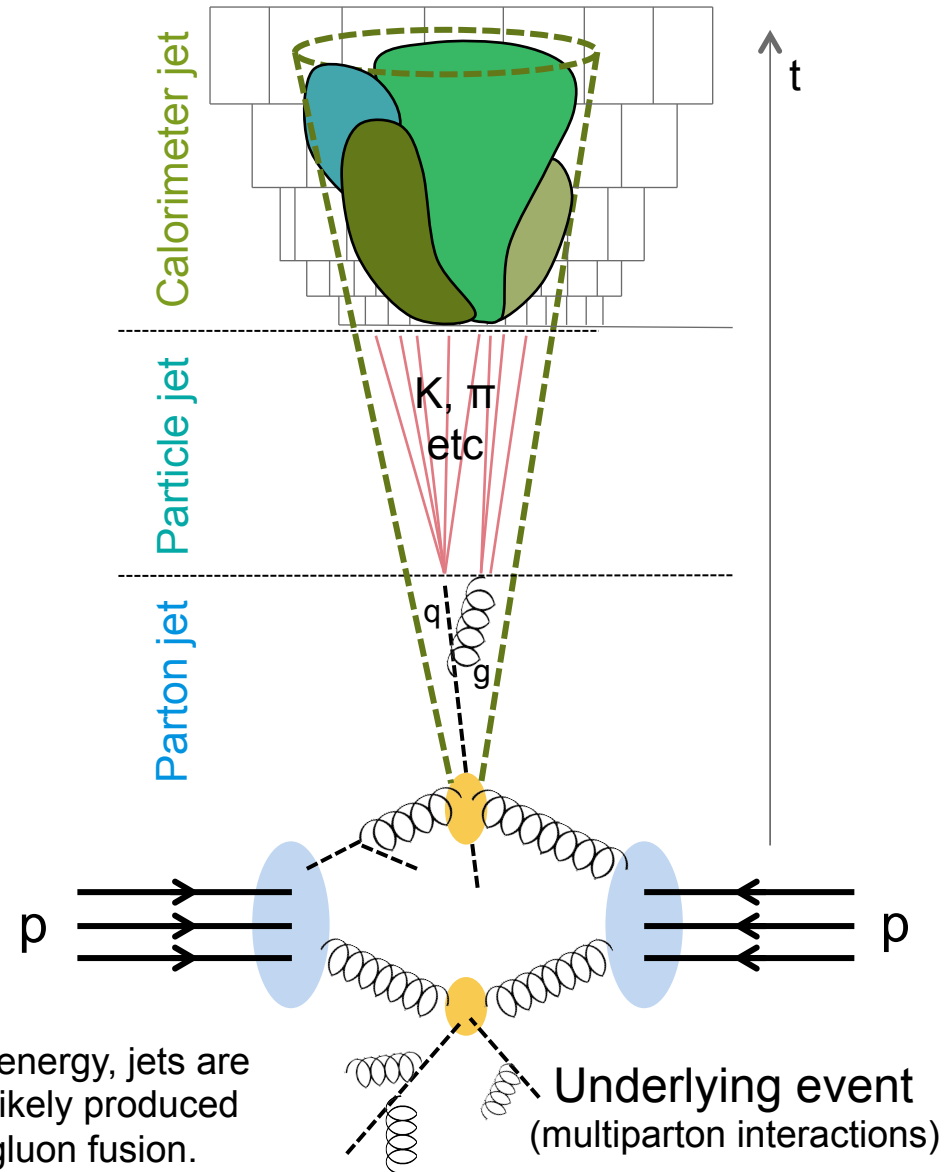

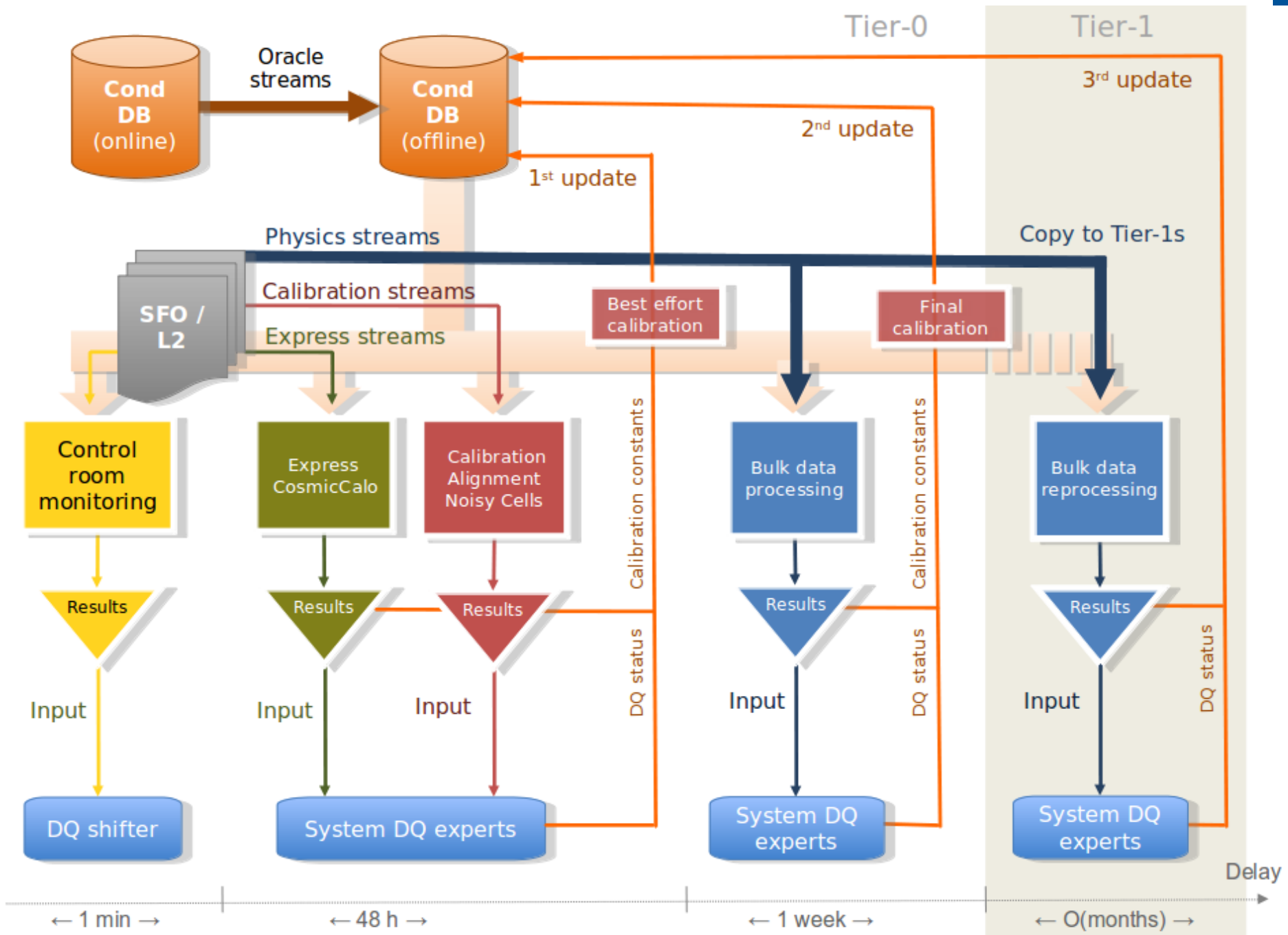

ANOTHER EXAMPLE – FROM ATLAS

“Topological” clusters, i.e. “blobs” of energy inside the detector.

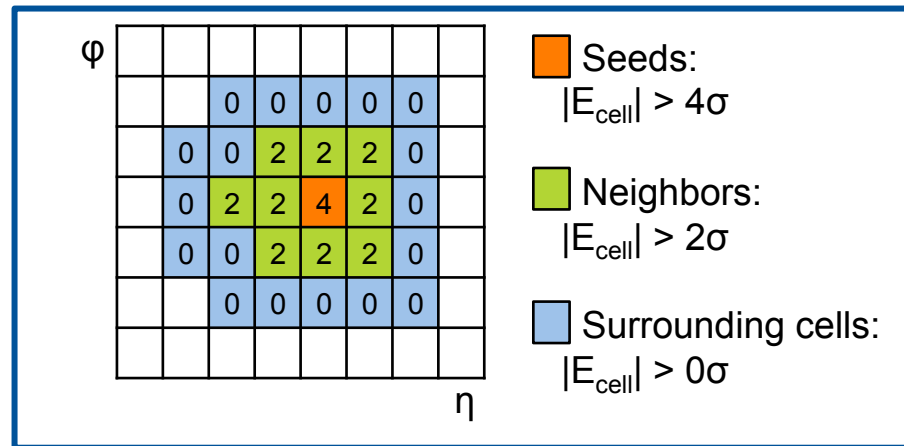

ANOTHER EXAMPLE – FROM ATLAS

“Topological” clusters, i.e. “blobs” of energy inside the detector.

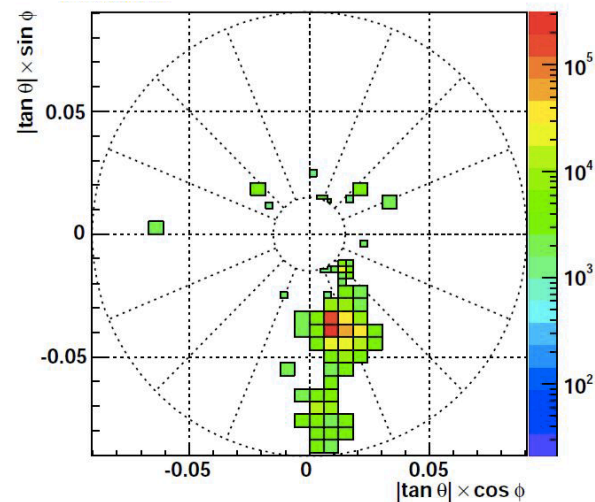
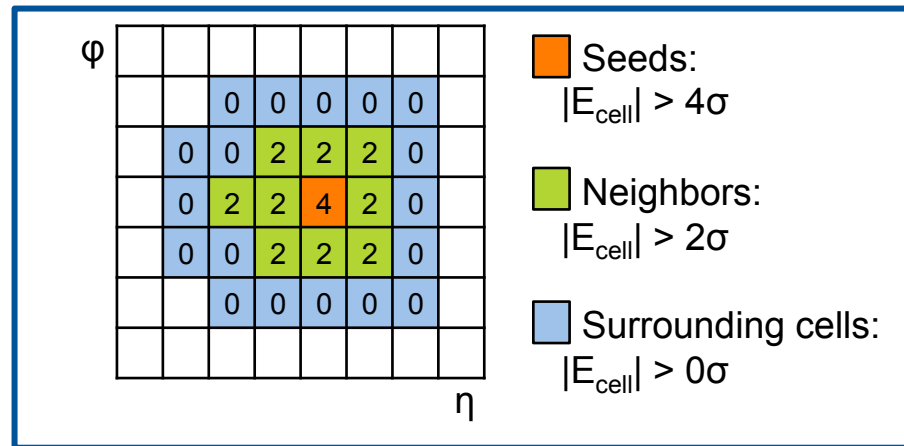

ANOTHER EXAMPLE – FROM ATLAS

“Topological” clusters, i.e. “blobs” of energy inside the detector.

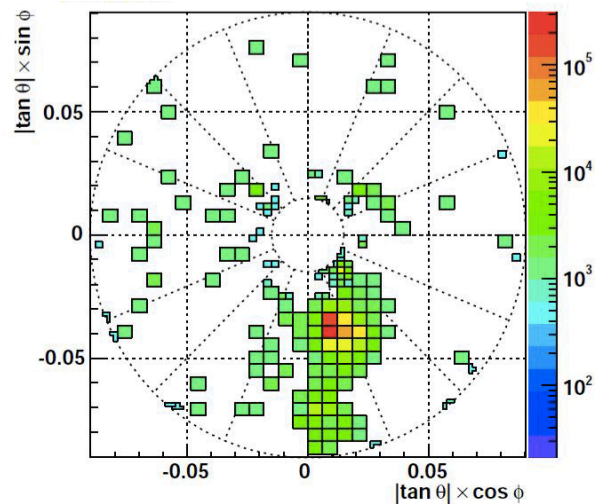
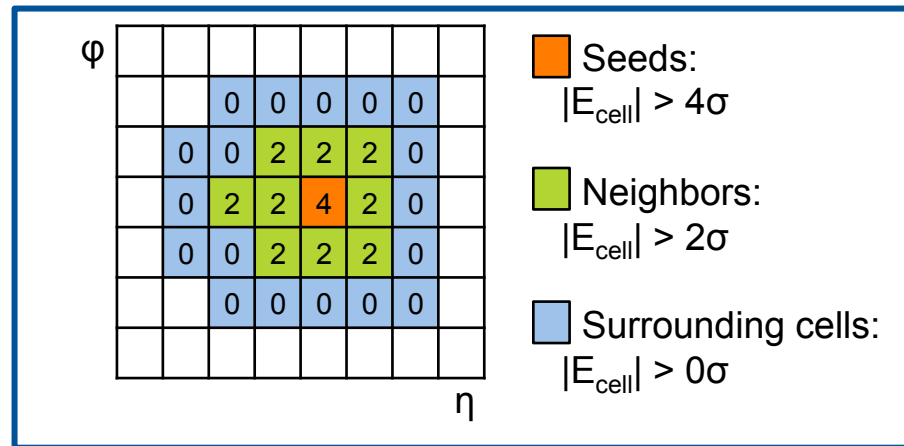

ANOTHER EXAMPLE – FROM ATLAS

“Topological” clusters, i.e. “blobs” of energy inside the detector.

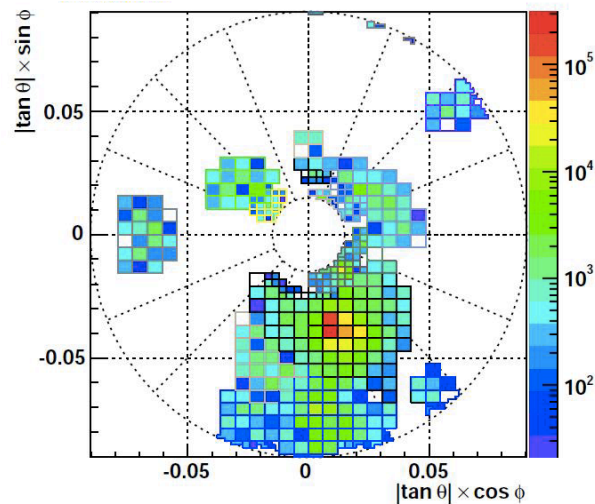
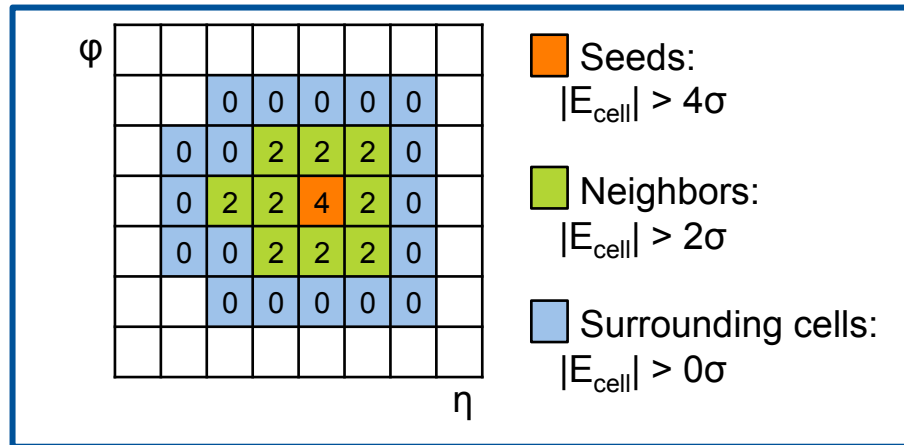

CLUSTER MERGING AND SPLITTING

⊙ If clusters have common neighboring cells, they are merged according to the basic algorithm.

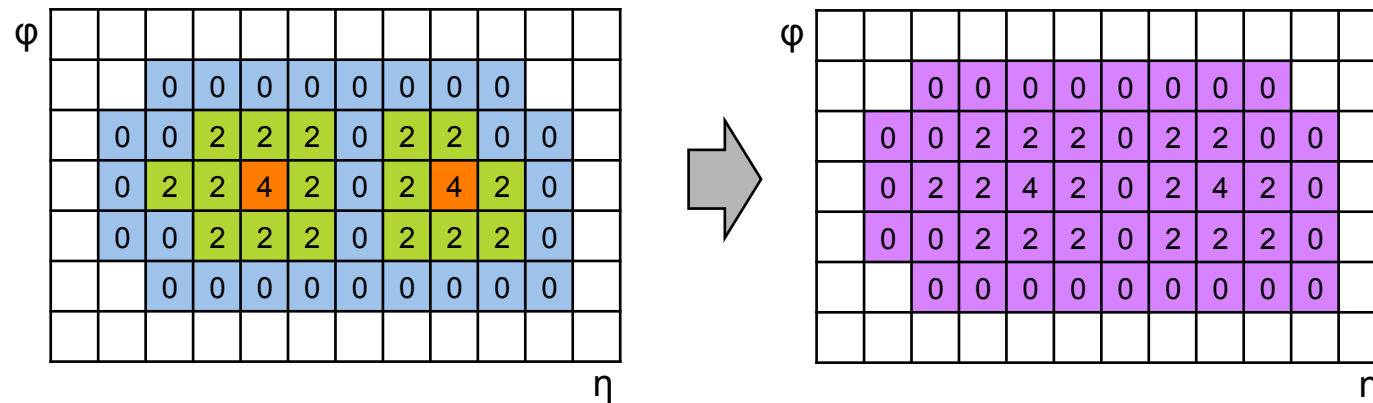

⊙ Clusters are split if more than one local maxima.

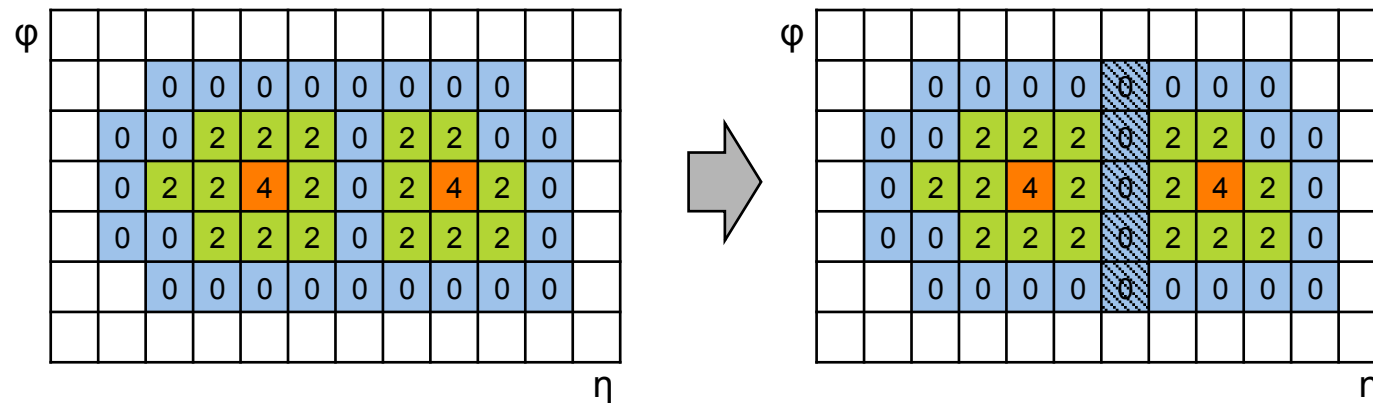

For common cells, a weight is applied to share them (shaded cells).

CLUSTER MERGING AND SPLITTING

© If clusters have common neighboring cells, they are merged according to the basic algorithm.

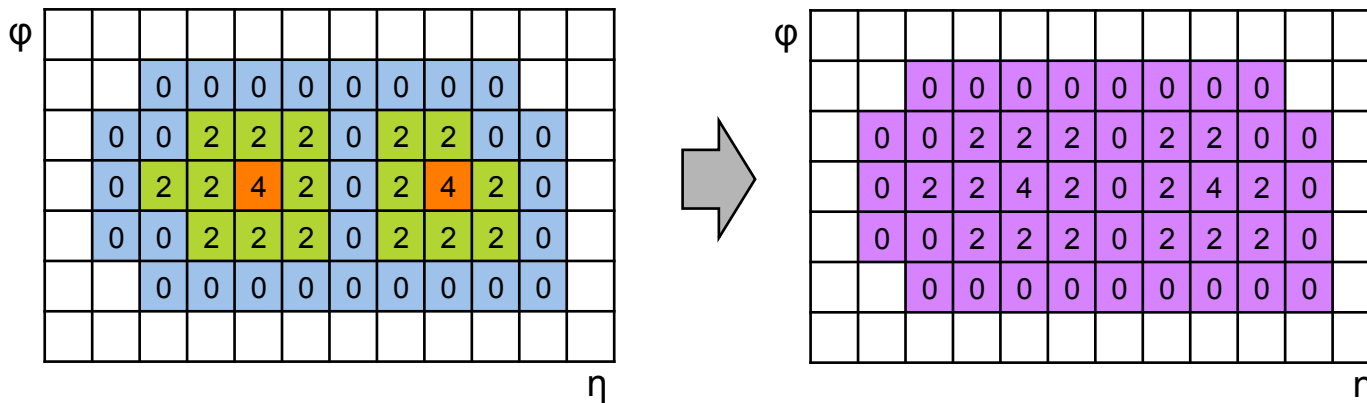

© Split clusters with more than one local maxima.

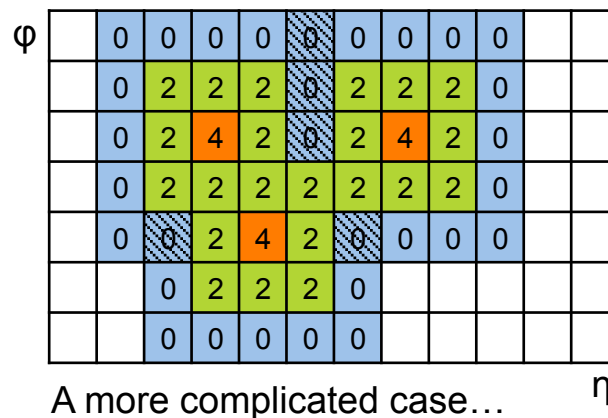

CLUSTER CALIBRATION

Possible energy measurements:

- ⊙ **Non-calibrated clusters: sum energy using baseline cell-level detector calibration.**
 - ⊙ That's NOT the true energy of the particle that originated the cluster.
- ⊙ **Local calibration: apply weights to correct for:**
 - ⊙ the different **calorimeter response** on an EM (e.g. π^0) or a hadronic (e.g. π^\pm) deposition.
 - ⊙ the low energetic deposits, lost in the tails of the shower (“**out-of-cluster**” corrections, derived from simulation).
 - ⊙ the presence of **dead material**, i.e. material without a read-out device, where energy is lost.
- ⊙ **Corrections are complex functions of the energy and the position of the cluster and other parameters defining the cluster shapes.**

MUONS ON ATLAS

Simplified Detector Transverse View

