

OK

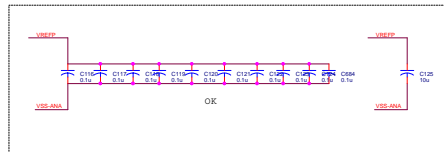

OK

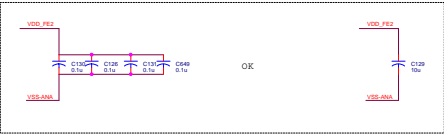

OK

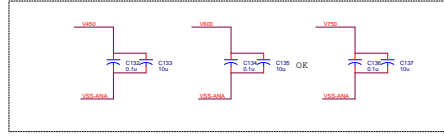

OK

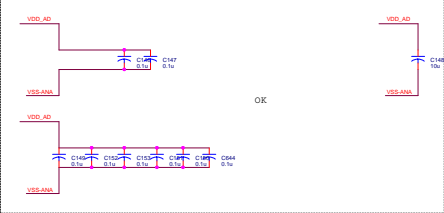

OK

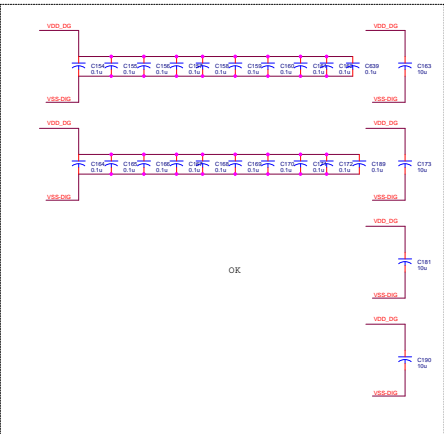

OK



OK

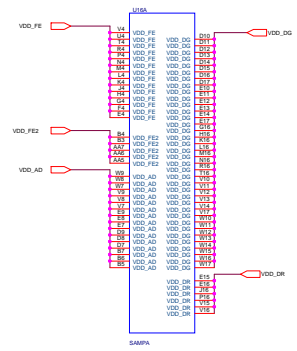
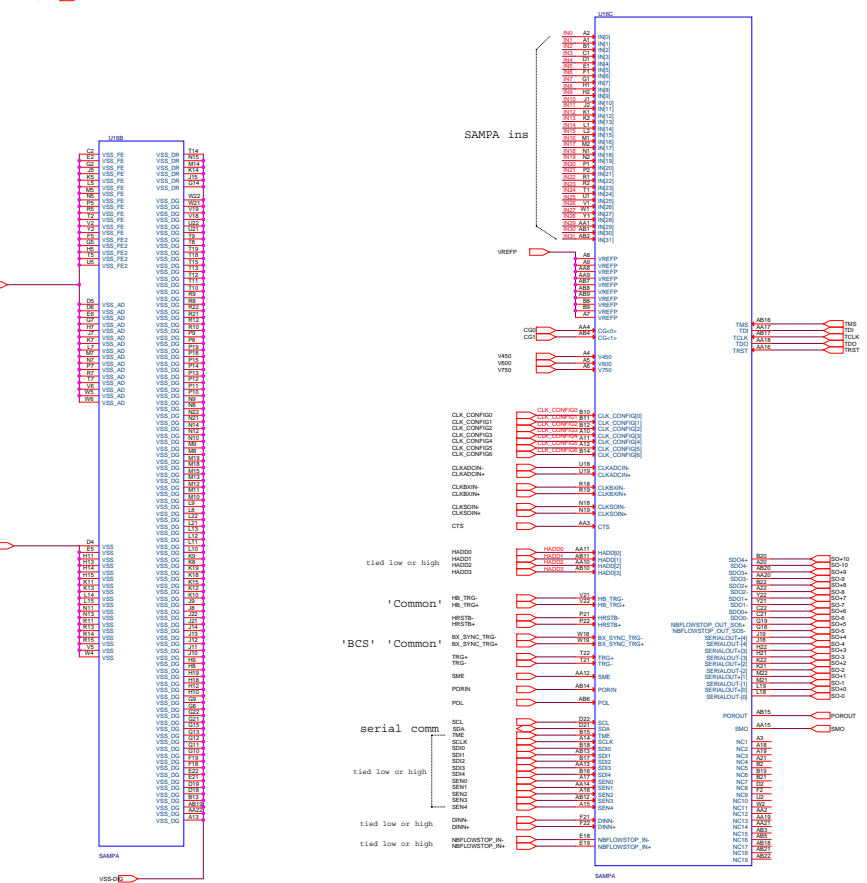
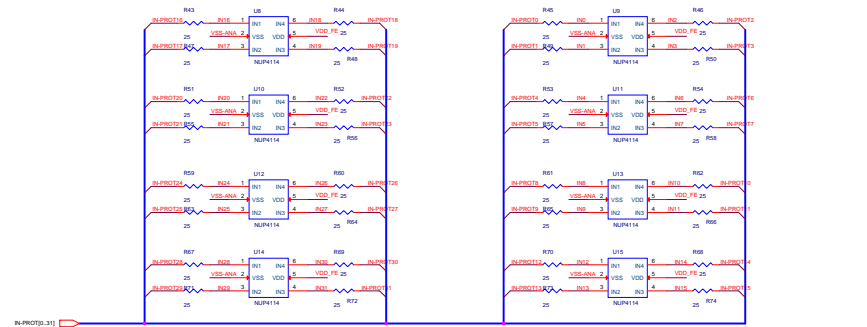

Doc No.	Doc Name	Doc Rev	Doc Date
SAMP4	SAMP4	1.0	2014-03-05