

- Introduction:
primary / secondary beam
ISOL method,
in-Flight (fragment) separators
- Secondary beams at FAIR:
Radioactive Isotope Beams: SuperFRS
Antiprotons: Target, Magnetic Horn and pbar Separator
Target handling, Radiation Protection
- “Ternary” Beams:
Muon Beams
Neutrino Beams (CNGS, NuMi...)

Primary / Secondary Beams

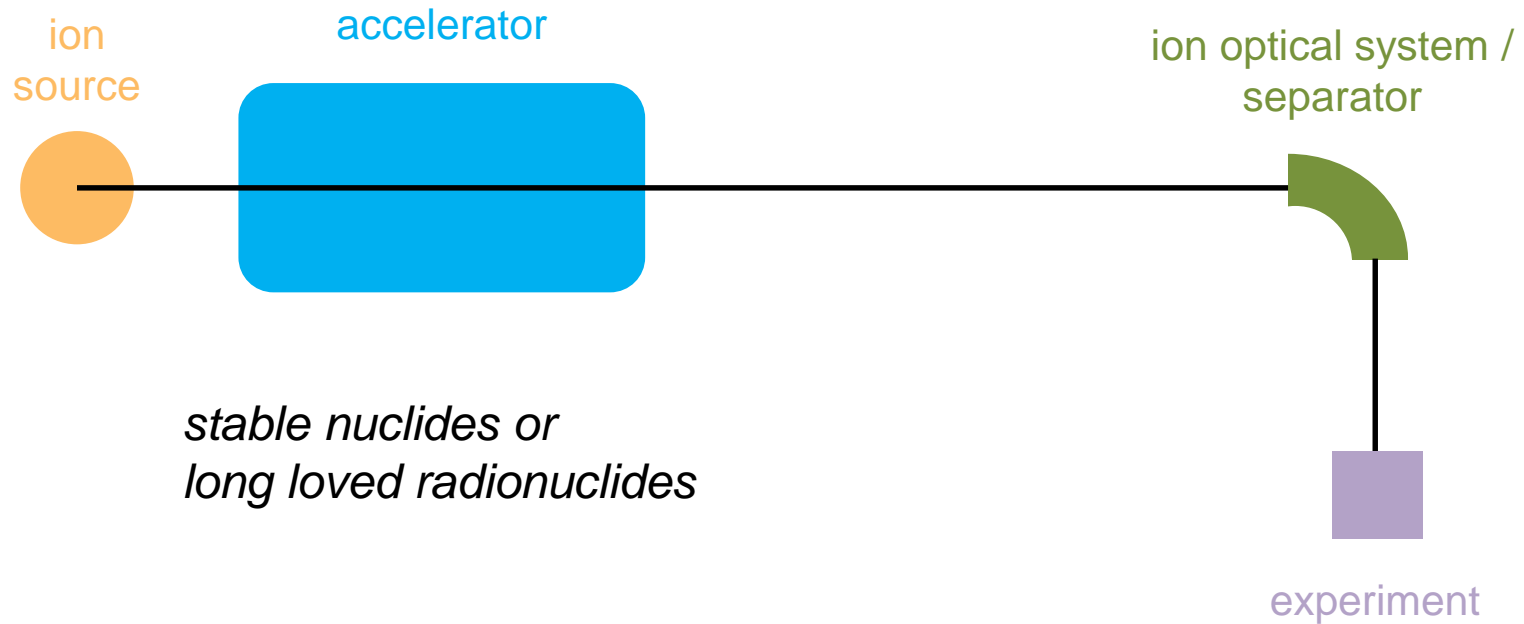

Primary / Secondary Beams (ISOL)

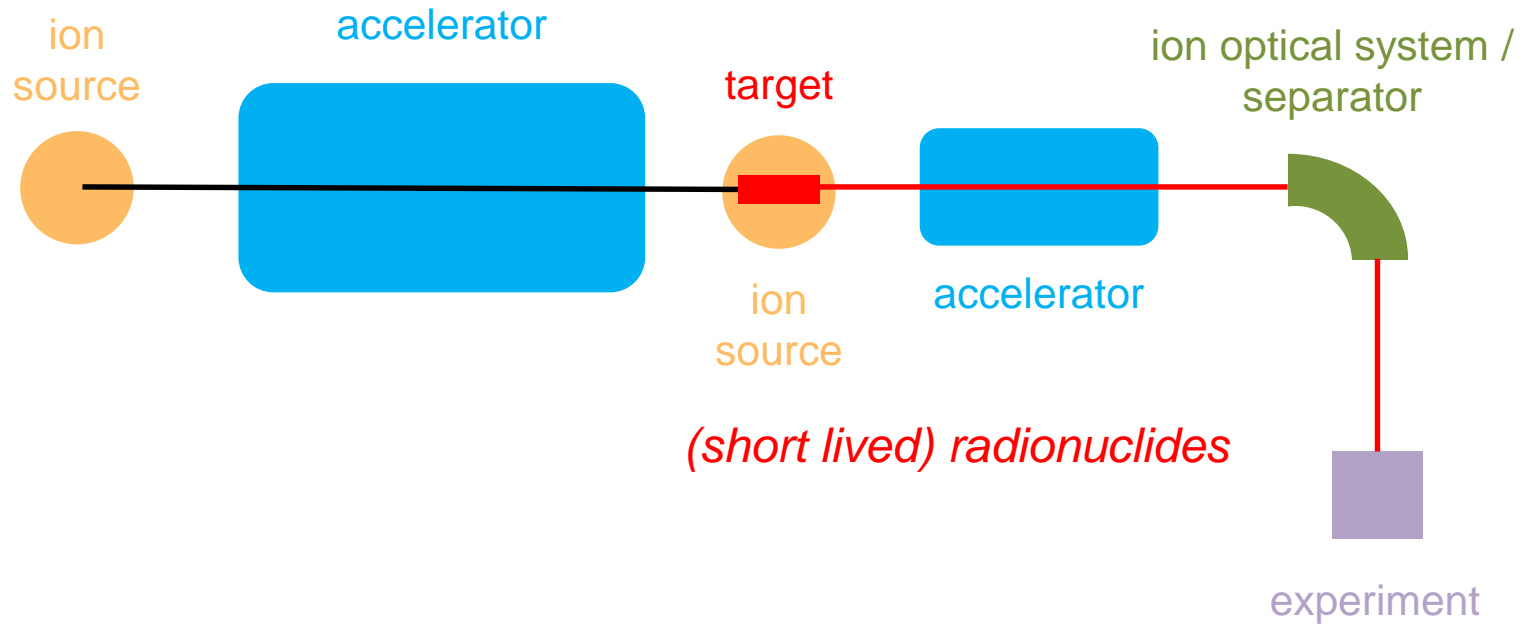

Primary / **Secondary** Beams: In-Flight

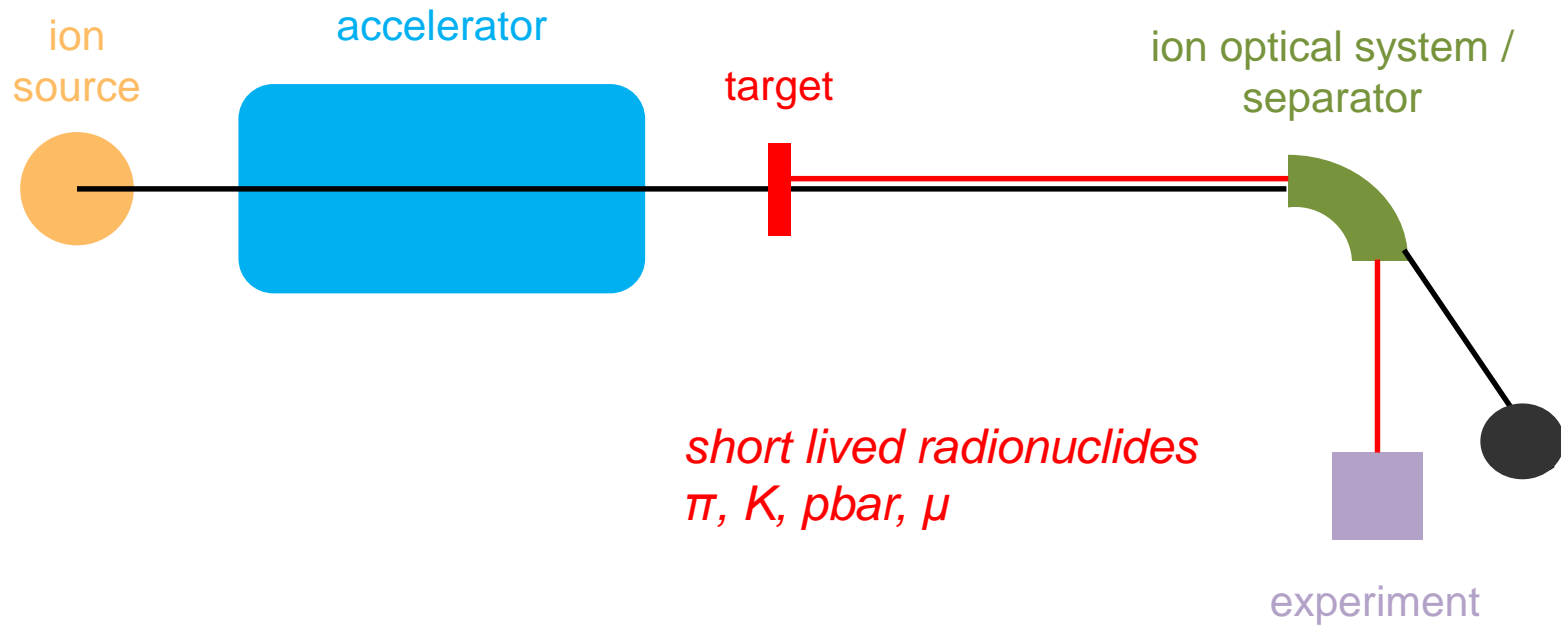

Production Mechanism

Spallation (ISOL only):
few nucleons lighter than target

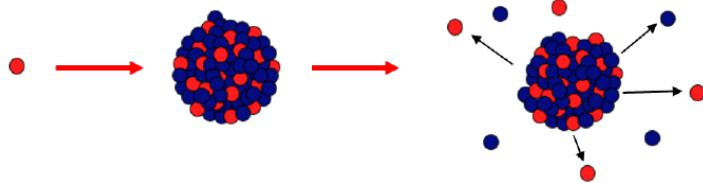

Projectile fragmentation:
neutron deficient (evaporation of neutrons after collision)

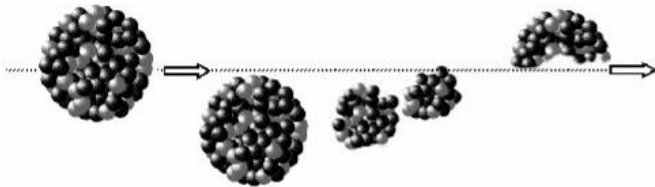

Projectile fission:
neutron rich (N/Z similar heavy projectile)

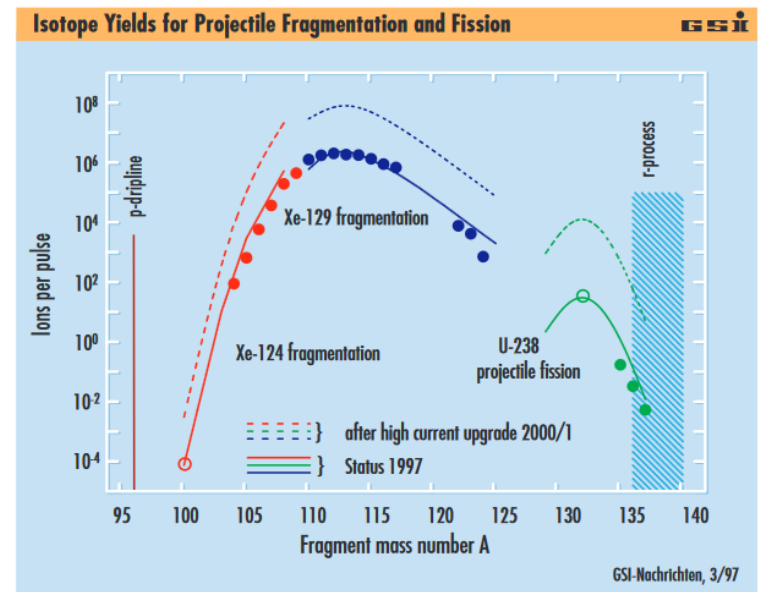
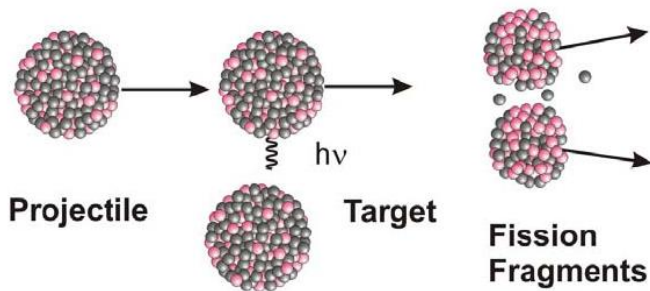

ISOL Method

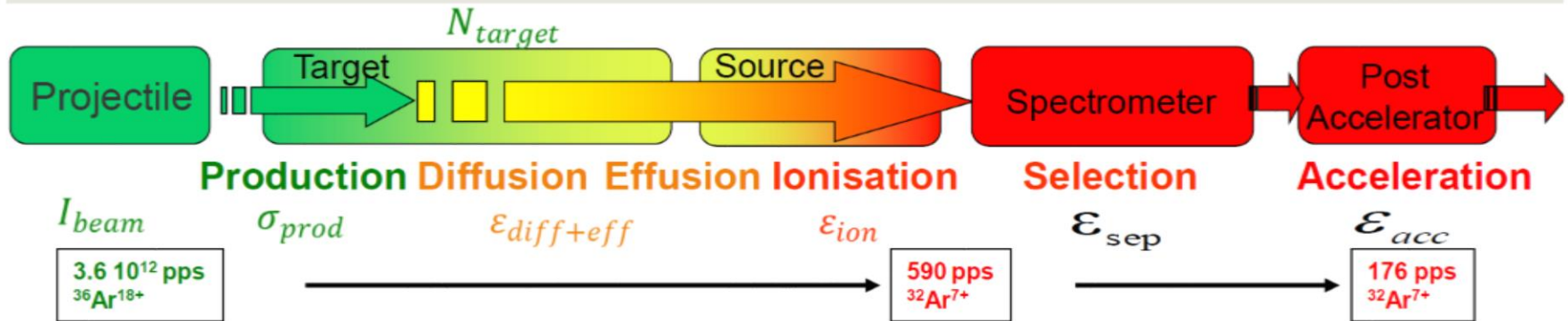

$$I_{RIB} = (\sigma_{prod} \cdot N_{target} \cdot I_{beam}) \cdot \epsilon_{diff+eff} \cdot \epsilon_{ion} \cdot \epsilon_{sep} \cdot \epsilon_{acc}$$

$\epsilon_{diff+eff} \cdot \epsilon_{ion}$ as low as 10^{-6}

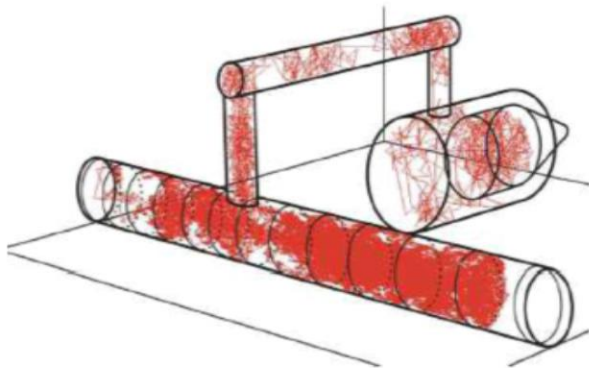

Path of an atom travelling out of a foil target to the ion source (RIBO code, (Santana-Leitner, 2005))



Facility for Rare Isotope Beams
U.S. Department of Energy Office of Science
Michigan State University

F. Pellemoine, HPTW April 2016 - Oxford, Slide 11

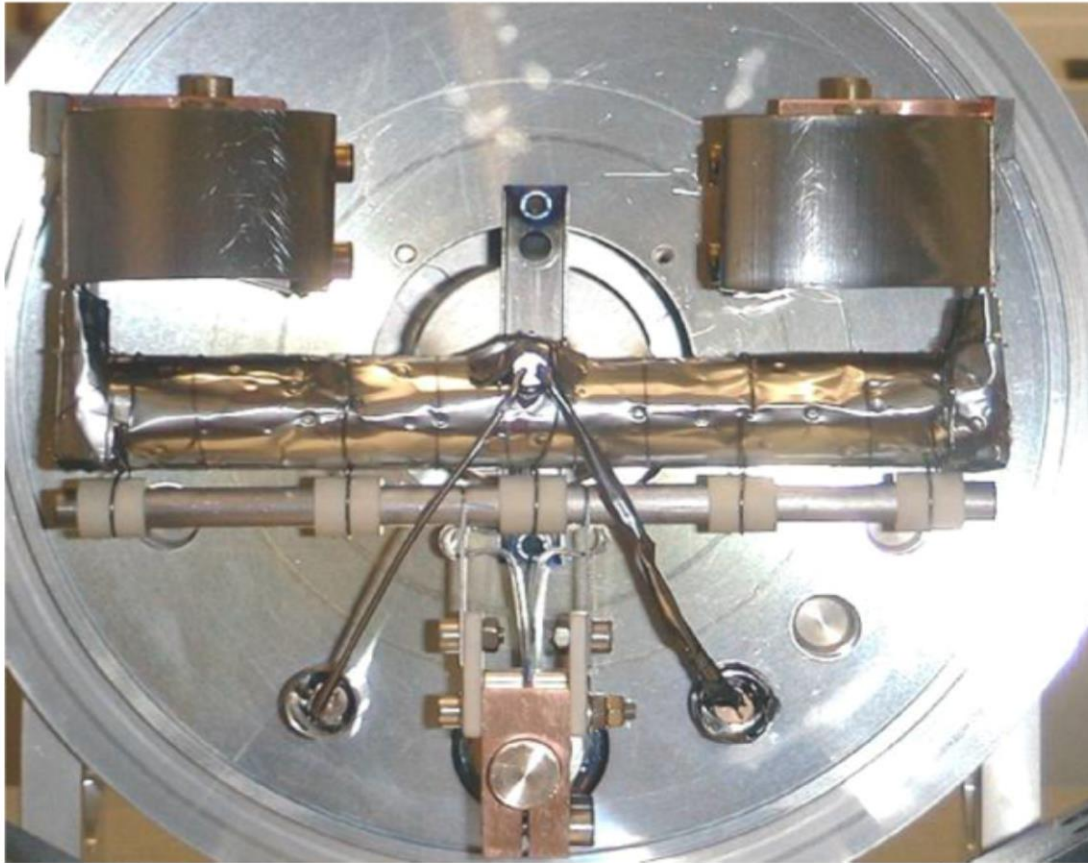

ISOLDE n-spallation
source: Ta(W)-rod
mounted below the
UC target
(before irradiation)

ISOLDE target handling.

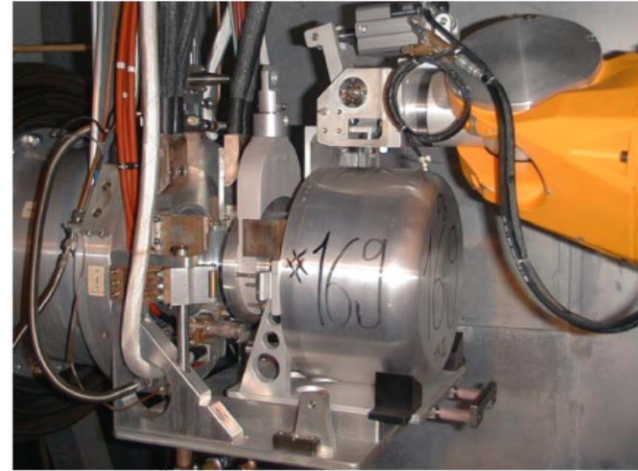

Class A laboratory

$$\Sigma_{Isotopes} (Activity/LA) > 10^7 \text{000}$$

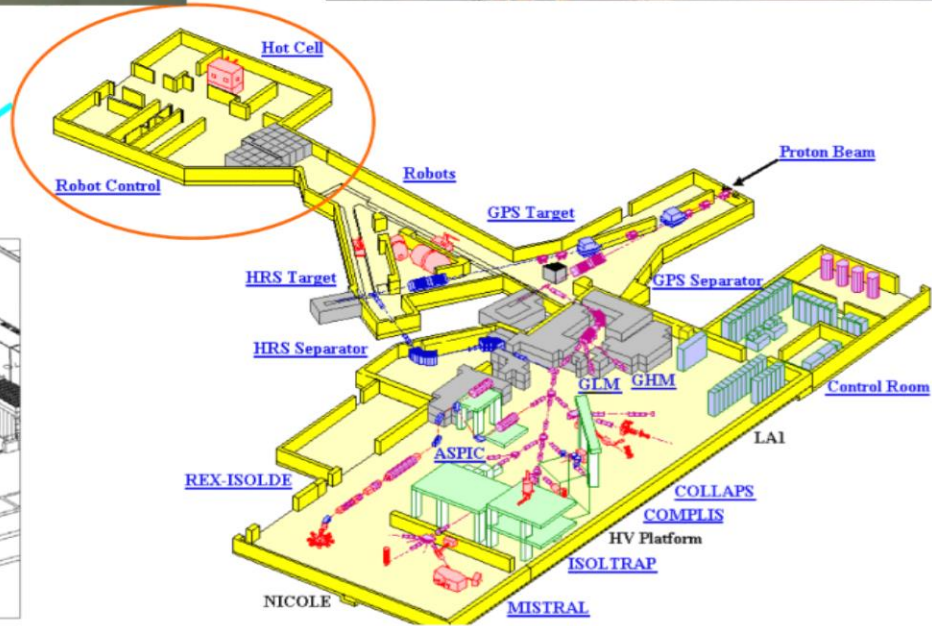
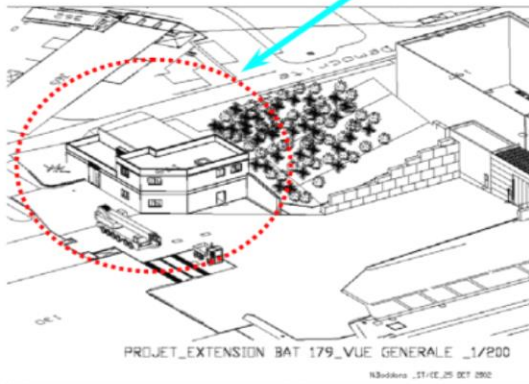

Fragment Separators (in-Flight)

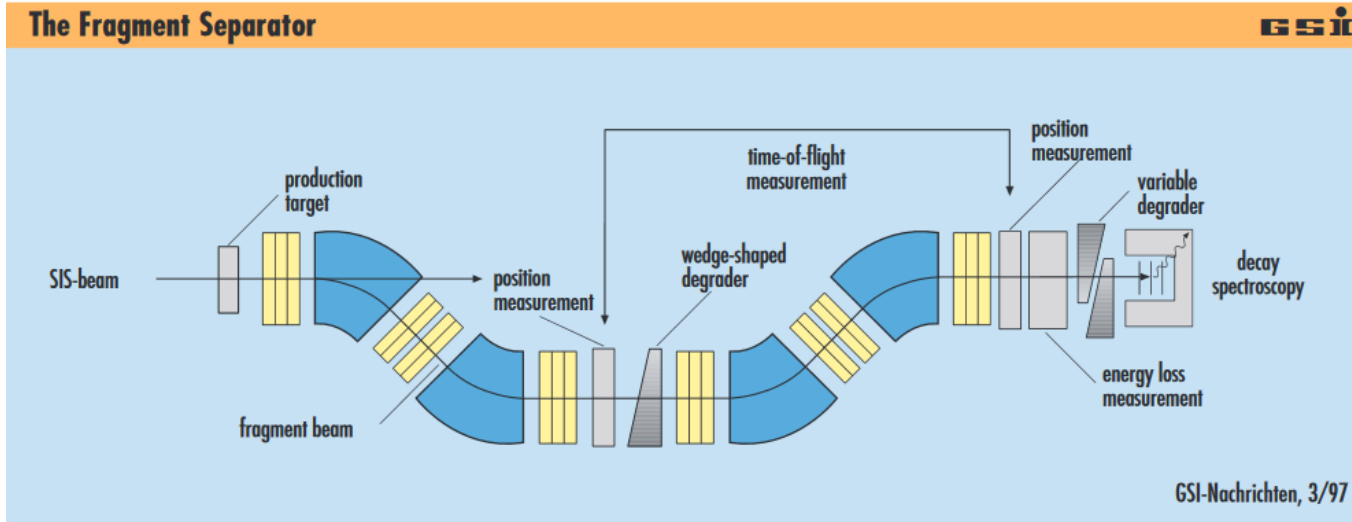

$$B \cdot \rho = p / (q \cdot e) \approx (2E \cdot m)^{1/2} / (q \cdot e)$$

1st part: m/q or A/q selection, charge states $\neq q$ lost
no isobaric selection (E similar for isobars)!

Degrader: dE/dx depends on projectile's Z .

2nd part: E selection, i.e. Z selection. (A/q' is the same for isobars)
charge states $\neq q'$ lost

Lifetime and Mass Measurements of stored exotic nuclei @ FRS

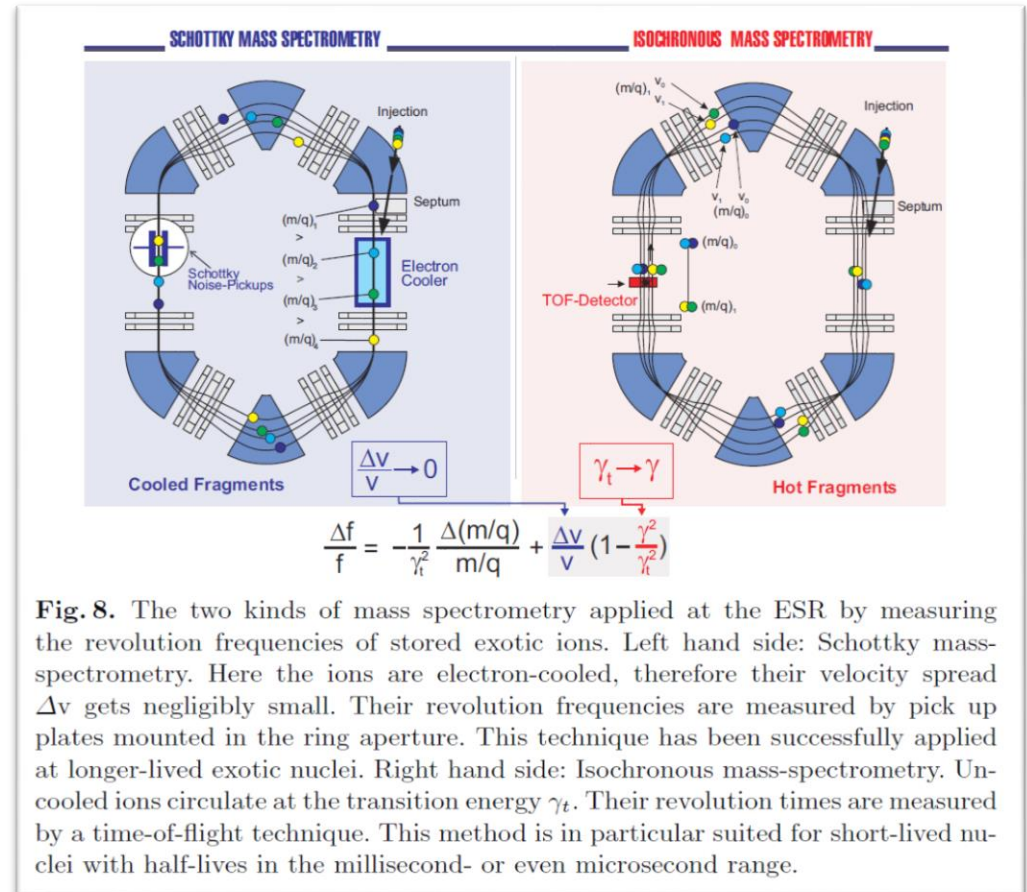
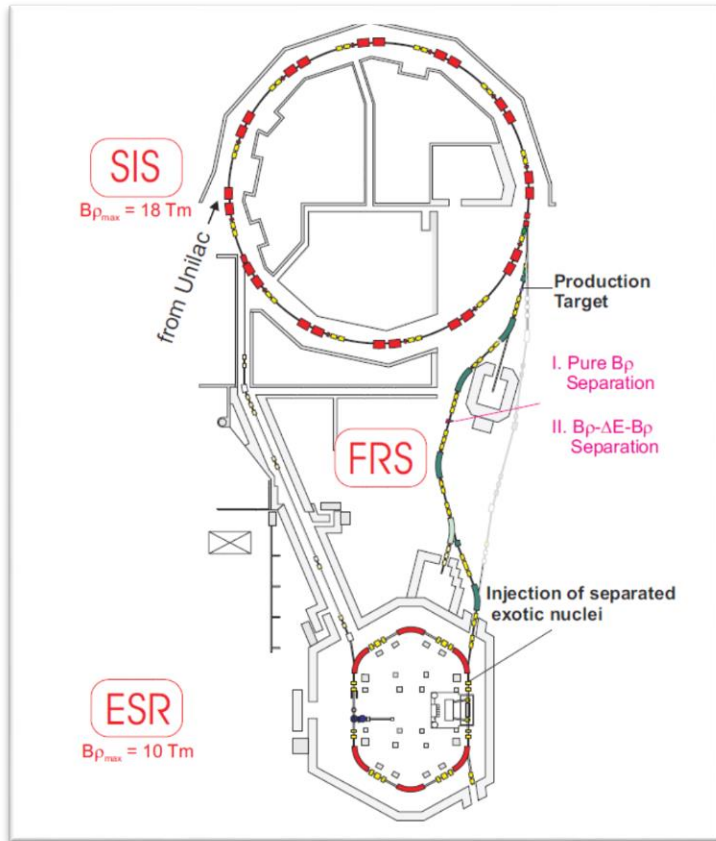

Fig. 8. The two kinds of mass spectrometry applied at the ESR by measuring the revolution frequencies of stored exotic ions. Left hand side: Schottky mass-spectrometry. Here the ions are electron-cooled, therefore their velocity spread Δv gets negligibly small. Their revolution frequencies are measured by pick up plates mounted in the ring aperture. This technique has been successfully applied at longer-lived exotic nuclei. Right hand side: Isochronous mass-spectrometry. Uncooled ions circulate at the transition energy γ_t . Their revolution times are measured by a time-of-flight technique. This method is in particular suited for short-lived nuclei with half-lives in the millisecond- or even microsecond range.

Lifetime and Mass Measurements of stored exotic nuclei @ FRS

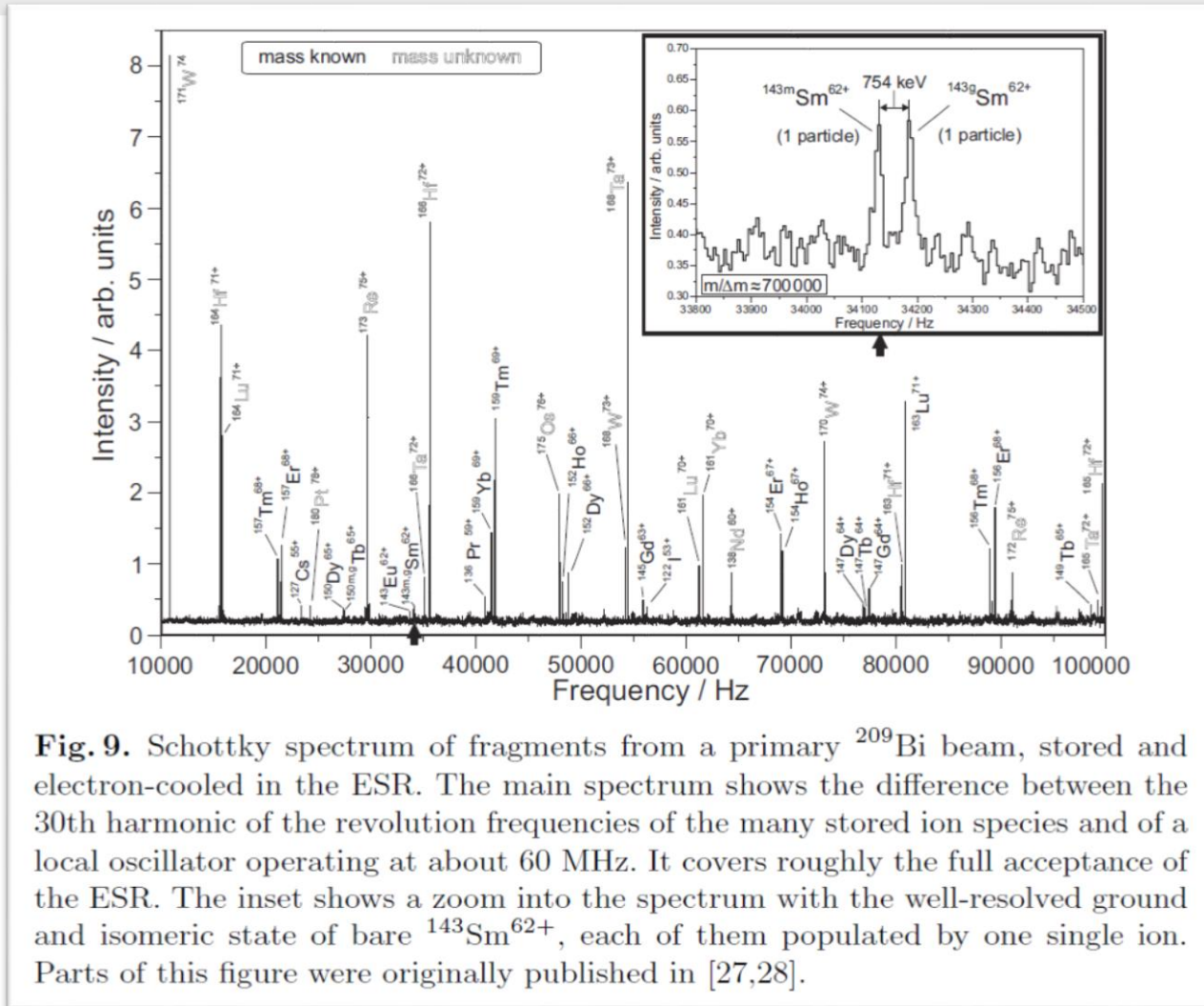
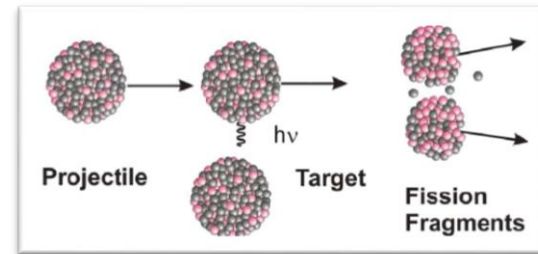
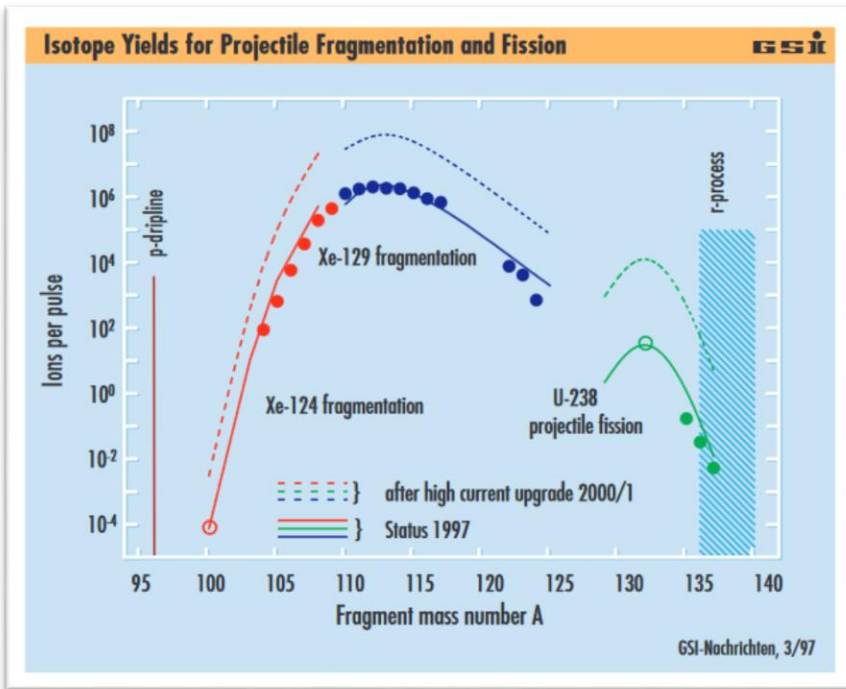

Fig. 9. Schottky spectrum of fragments from a primary ^{209}Bi beam, stored and electron-cooled in the ESR. The main spectrum shows the difference between the 30th harmonic of the revolution frequencies of the many stored ion species and of a local oscillator operating at about 60 MHz. It covers roughly the full acceptance of the ESR. The inset shows a zoom into the spectrum with the well-resolved ground and isomeric state of bare $^{143}\text{Sm}^{62+}$, each of them populated by one single ion. Parts of this figure were originally published in [27,28].

The Super Fragment Separator



Phase 1 Physics with Super-FRS and Rings: Potential for new masses, lifetimes & isomers with ILIMA



ILIMA

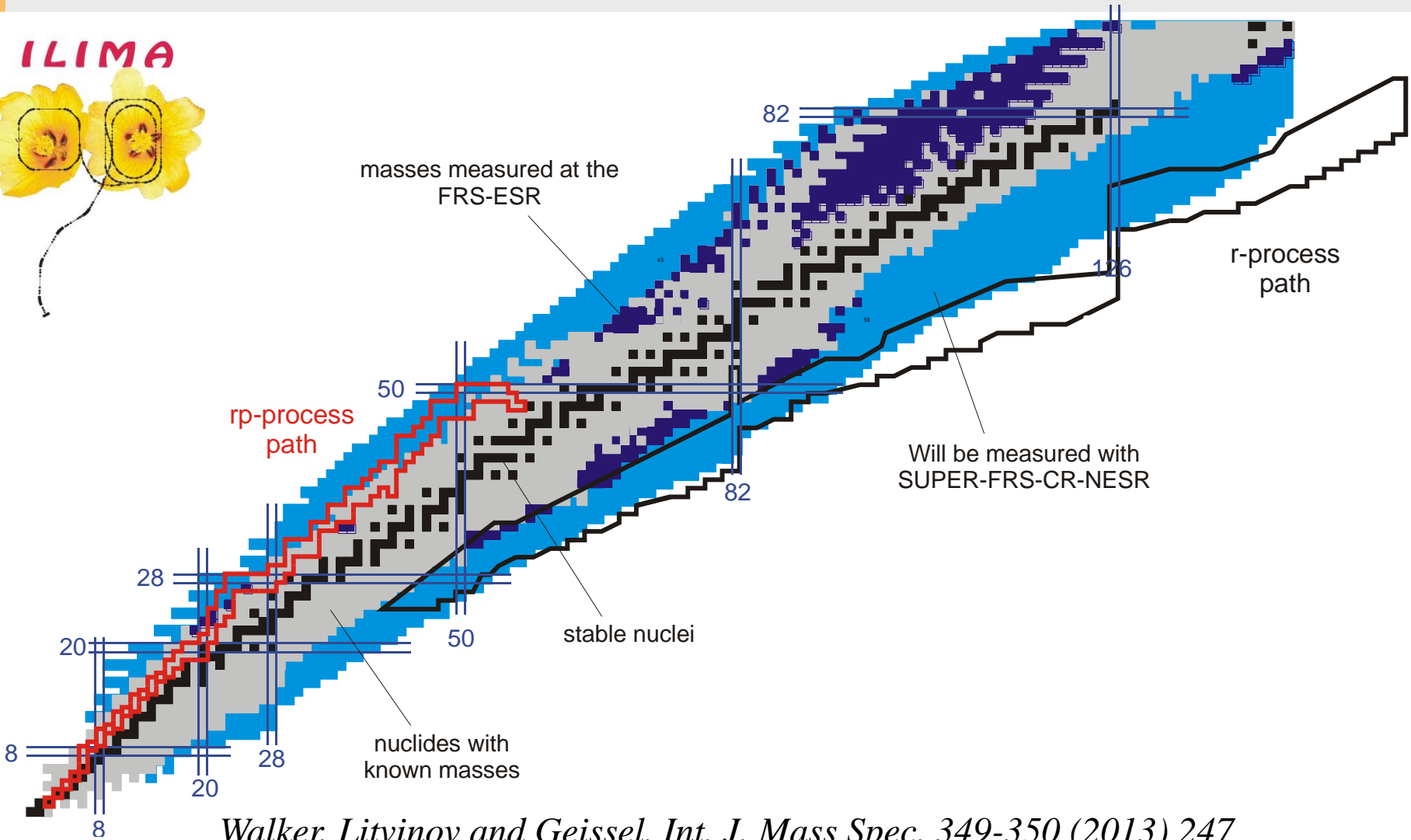
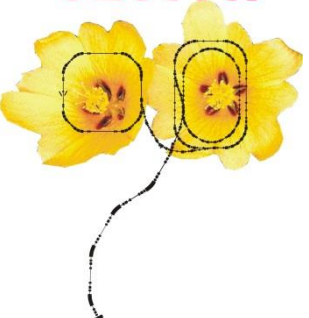

Walker, Litvinov and Geissel, *Int. J. Mass Spec.* 349-350 (2013) 247

SuperFRS @ FAIR

Primary Beams: Increase intensity

- $3 \times 10^{11}/s$; 1.5-2 GeV/u; $^{238}\text{U}^{28+}$
- **Factor > 100**
over present in intensity (space charge!)

Rare Isotope Beams: Increase Acceptance

- Broad range of **radioactive beams** up to 1.5 - 2 GeV/u;
up to factor **1 000 - 10 000** in
intensity over present

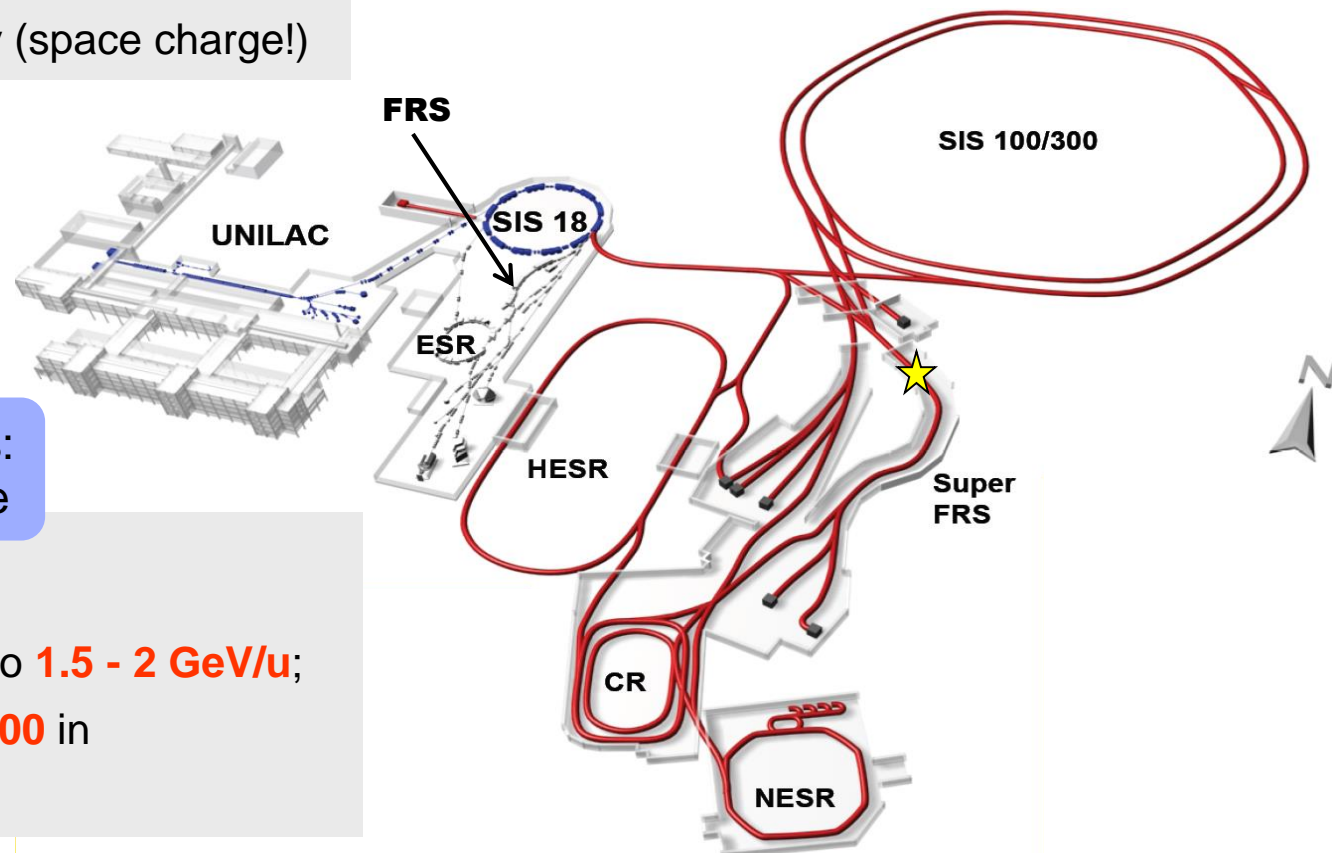

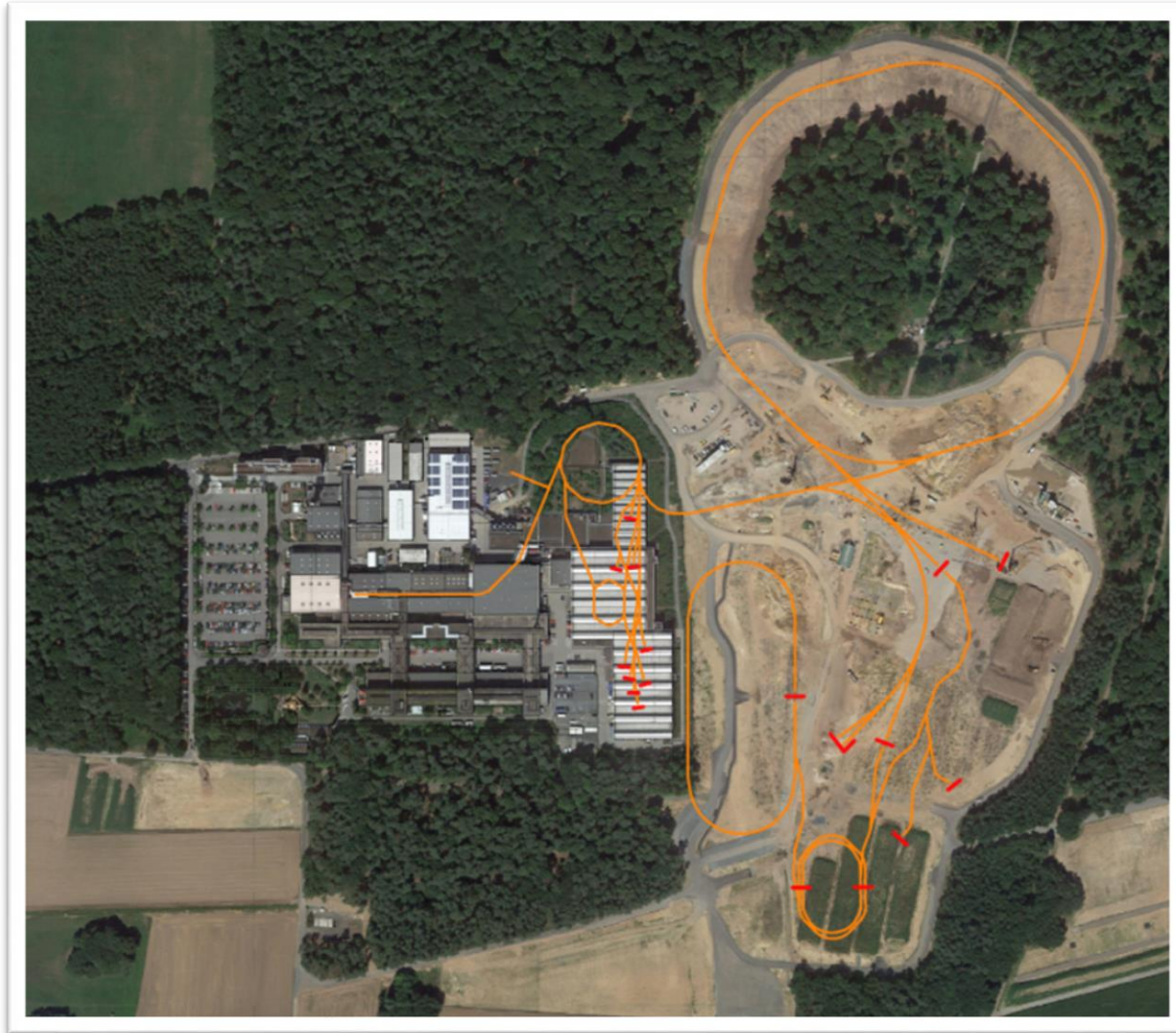

Facility	Max. Magnetic Rigidity	Momentum Acceptance $\Delta p/p$	Angular Acceptance		Momentum Resolution
	$B\rho_{\max} / [\text{Tm}]$		$\phi_x / [\text{mrad}]$	$\phi_y / [\text{mrad}]$	
FRS	18	$\pm 1 \%$	± 7.5	± 7.5	1500 ($\epsilon = 20\pi \text{ mm mrad}$)
Super-FRS	20	$\pm 2.5 \%$	± 40	± 20	1500 ($\epsilon = 40\pi \text{ mm mrad}$)

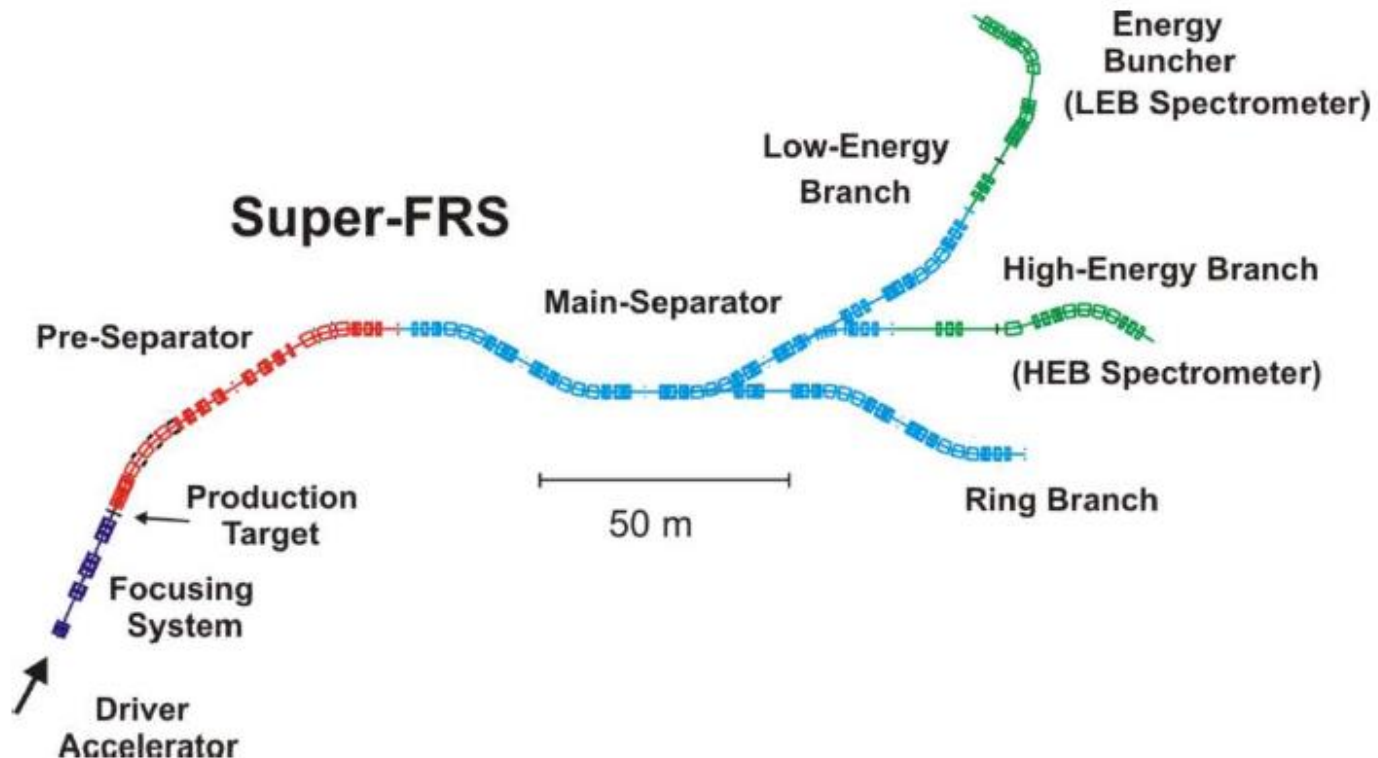

FRS

A total of 75 targets of different elements with differing thicknesses can be installed at the target station at the entrance of the fragment separator. Each of the cylindrical targets, which have a diameter of two centimeters, can be moved into the path of the ion beam with millimeter precision using step motor control. If required, the target holder can also be exchanged by remote control.

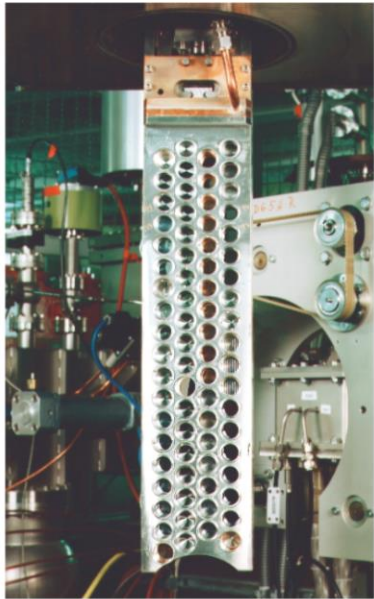

Targetchamber

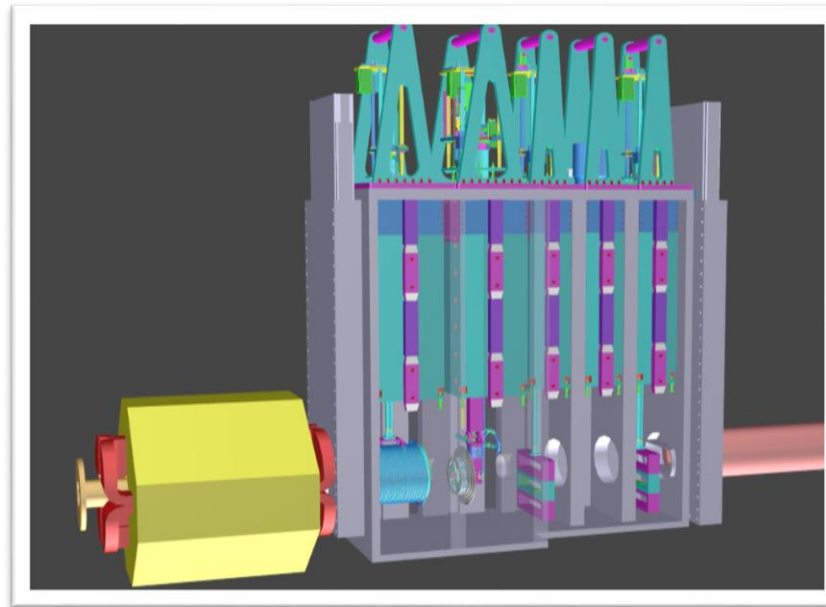

Target with shielding

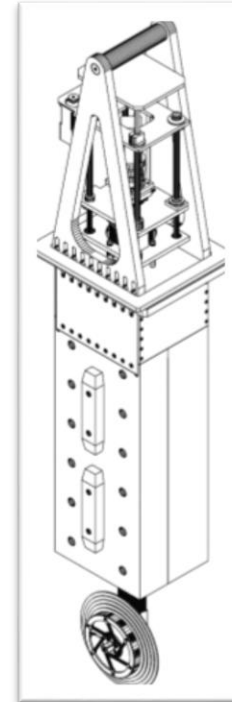

Prototype





High Power Meson Production Target

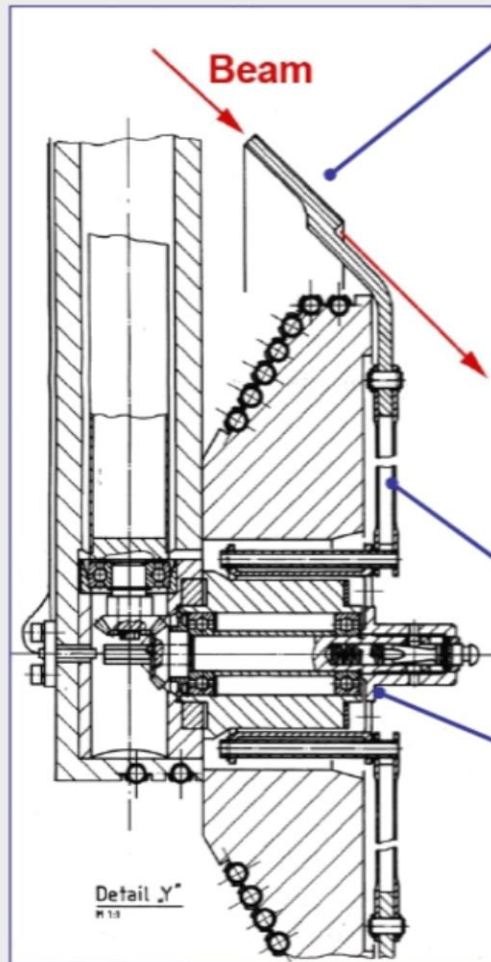

TARGET CONE

3.0mA o.k., limit: sublimation

Mean diameter: 450 mm
Graphite density: 1.8 g/cm³
Operating Temp.: 1700 K
Irrad. damage rate: 0.1 dpa/Ah
Rotation Speed: 1 Turn/s
Target thickness: 60 / 40 mm
10 / 7 g/cm²
Beam loss: 18 / 12 %
Power deposit.: 30 / 20 kW/mA

SPOKES

To enable the thermal expansion of the target cone

BALL BEARINGS *)

Silicon nitride balls
Rings and cage silver coated
Lifetime 2 y
*) GMN, Nürnberg, Germany

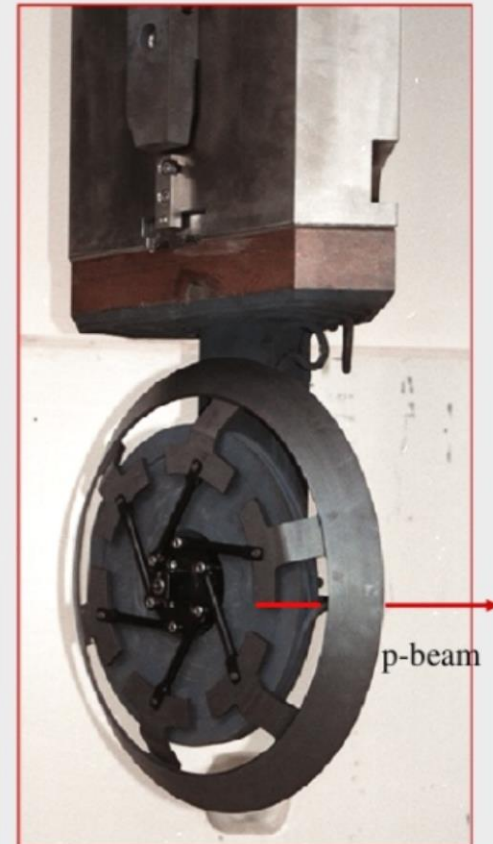

G.Heidenreich et. al.

M.Seidel. ESS Bilbao Initiative Workshop. March 16-18 (2009)

SuperFRS at FAIR

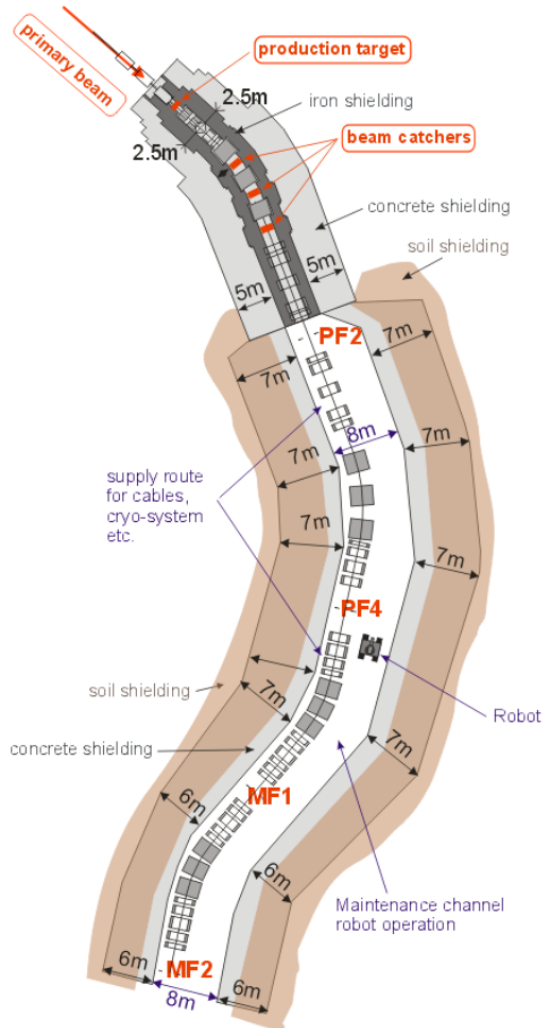

Figure 2.4-166: Schematic layout of the Super-FRS with beam line and shielding measures. The area from the target up to the intermediate focal plane PF2 of the Pre-Separator is shielded with iron in order to provide a compact radiation protection in the target building. The concrete in the Main-Separator can be partially replaced by soil taking into account an about 20% smaller absorption of the soil.

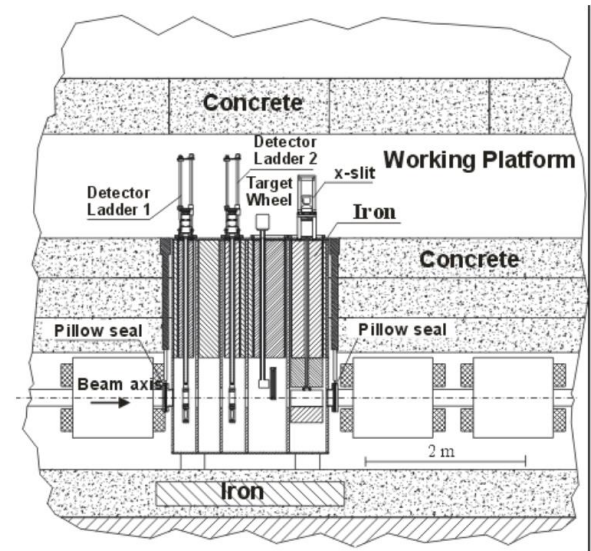

Figure 2.4-126: Schematic layout of the target area of the Super-FRS. A vertical plug system has been adapted which has proven to guarantee a safe and reliable operation at PSI in a very high radiation field. Routine maintenance at PSI is done about once per year.

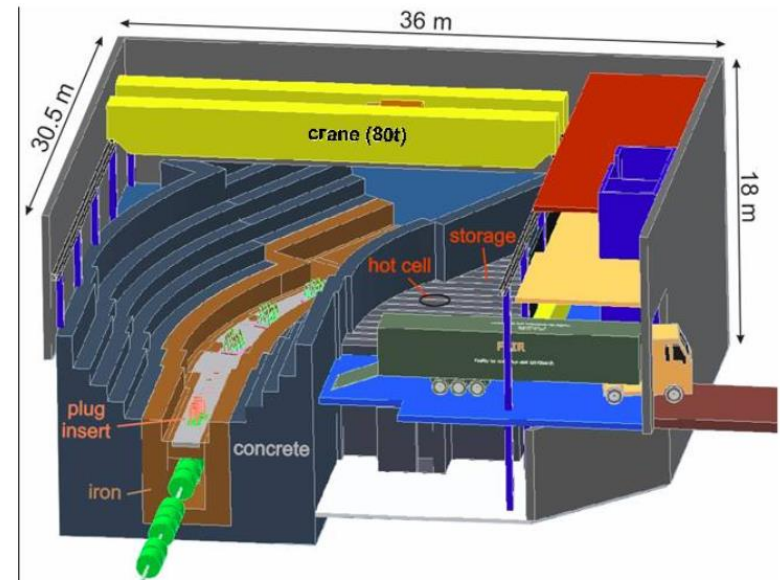
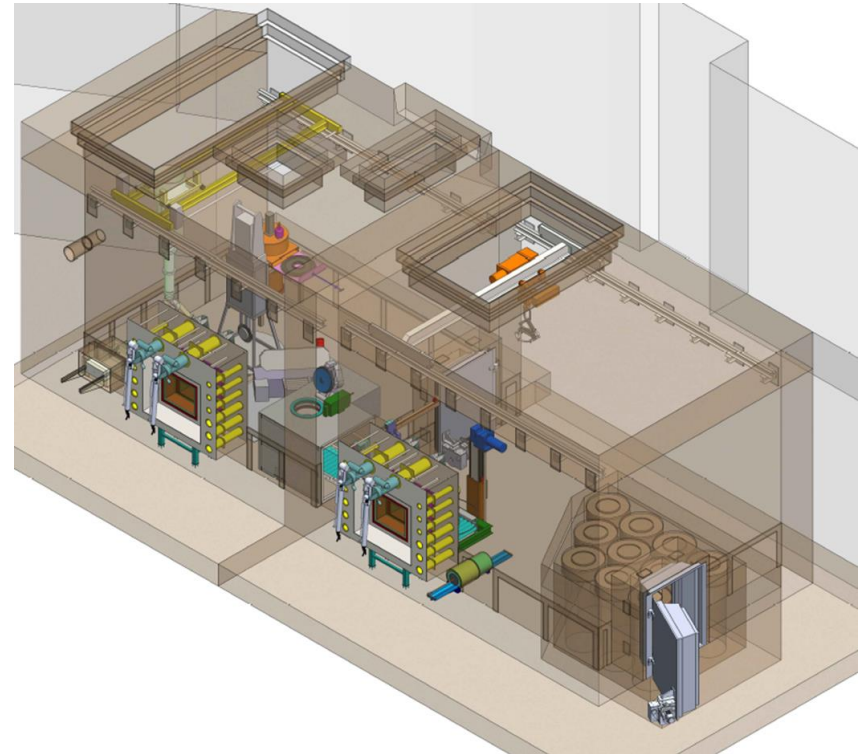
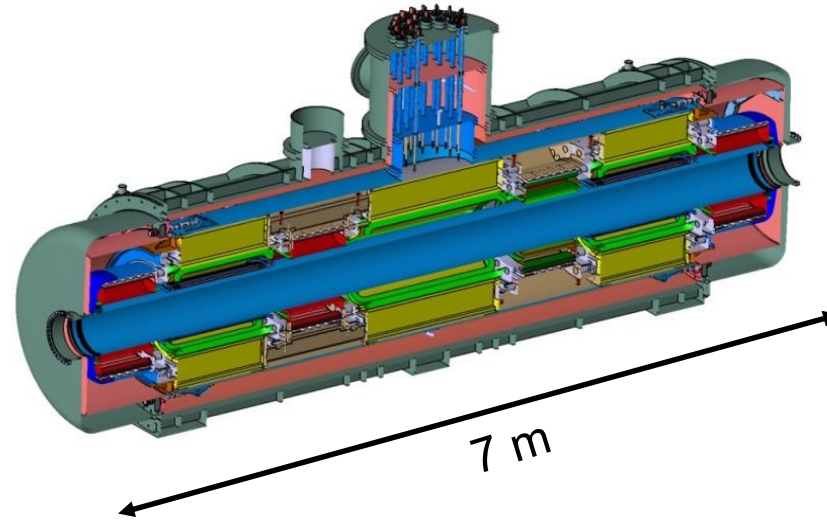

Figure 2.4-175: Layout of the Super-FRS target building. The top part of the concrete shielding can be removed to access the working platform. Heavy devices can be transported by crane to the nearby hot cell, storage places or directly onto a truck which can drive into the hall.



Figure 2.4-176: Radiation shielding bottle at PSI [65] to move activated parts to a hot cell. The whole plug is pulled into the bottle which is then transported with a crane.





© PSI

- 25 long multiplets (mainly MS)
- 8 short multiplets (PS)
- Quadrupol triplet / QS configuration
- up to 3 sextupoles and 1 steerer
- Octupole coils in short quadrupoles

- iron dominated, cold iron (≈ 40 tons)
- common helium bath, LHe ≈ 1.300 l
- warm beam pipe (38 cm inner diameter)
- per magnet 1 pair of current leads
- max. current < 300 A for all magnets

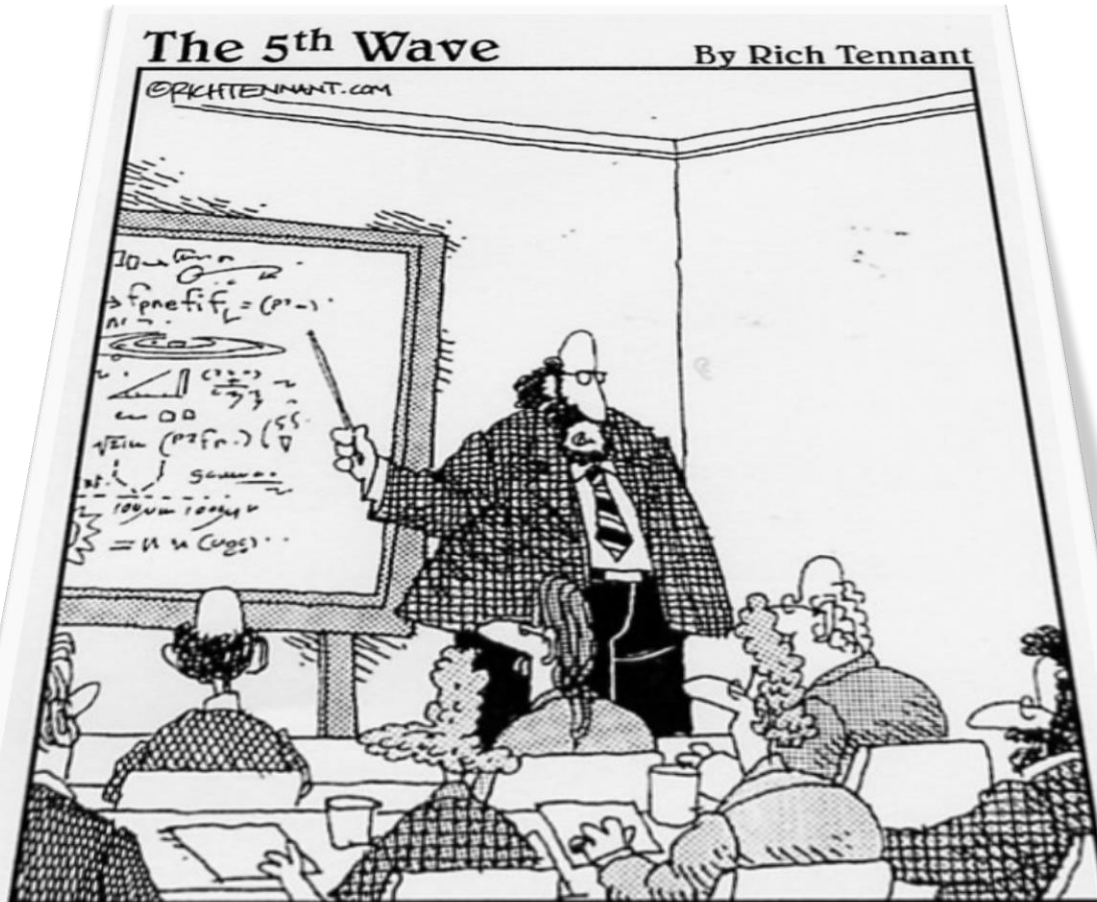

"After the discovery of 'antimatter' and 'dark matter', we have just confirmed the existence of 'doesn't matter', which does not have any influence on the Universe whatsoever."

Motivation for the large pbar Sources: p-pbar Collider (SPS, Tevatron)

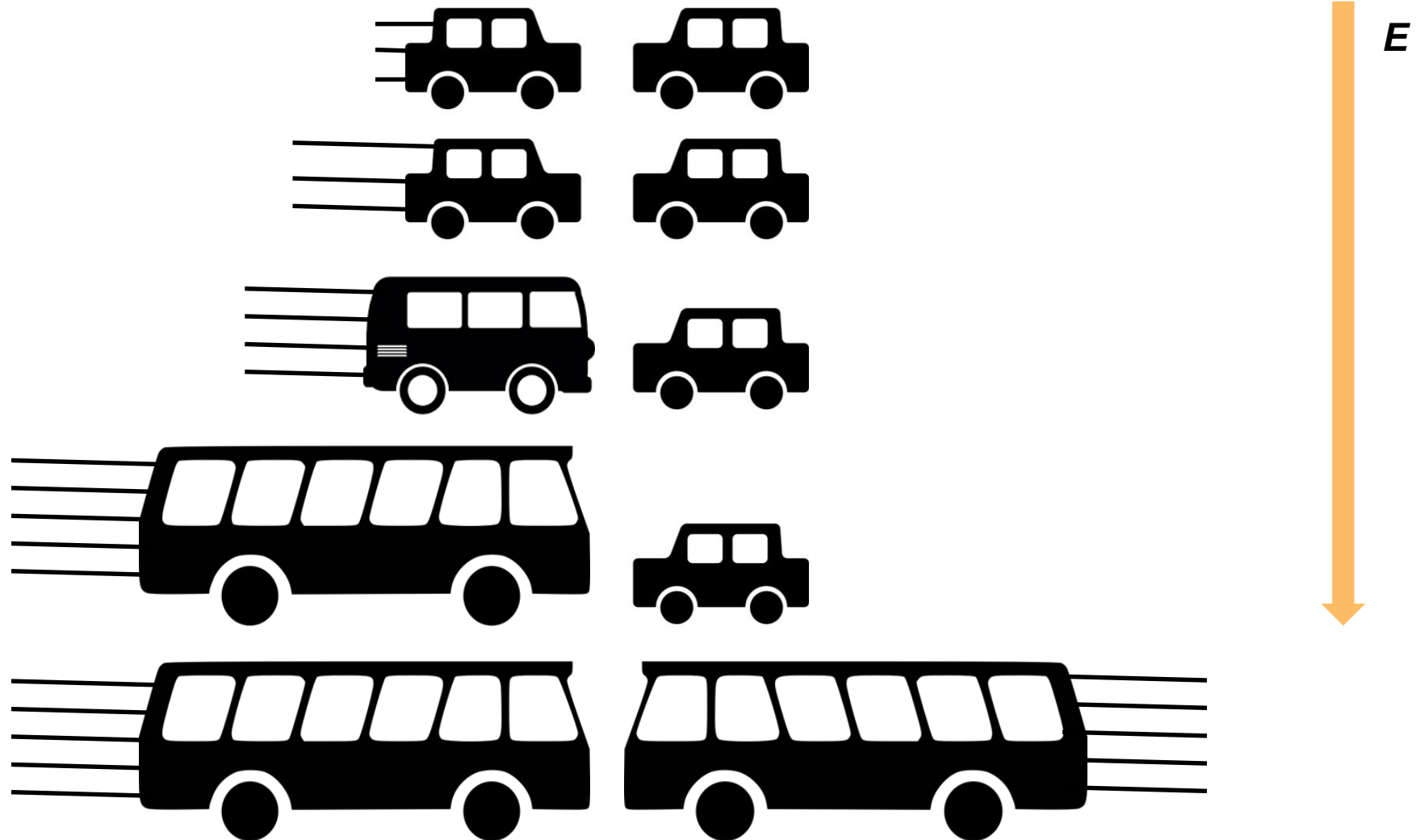

Motivation for the large pbar Sources: p-pbar Collider (SPS, Tevatron)

Detection of W and Z boson at CERN:

Nobel Prize 1984 to Carlo Rubbia (right) and Simon van der Meer (left).



Detection of the top quark at Fermilab (1995)

Nobel Prize 2008 to Makoto Kobayashi (left) and Toshihide Maskawa (right) for its prediction.



	FAIR	CERN (AC+AA)	FNAL
E(p), E(pbar)	29 GeV, 3 GeV	25 GeV, 2.7 GeV	120 GeV, 8 GeV
acceptance	240 π mm mrad	200 π mm mrad	$\approx 30 \pi$ mm mrad
protons / pulse	2×10^{13}	$1 - 2 \times 10^{13}$	$\geq 5 \times 10^{12}$
pulse length	single bunch (50 ns)	5 bunches in 400 ns	single bunch 1.6 μ s
cycle time	10 s	4.8 s	1.5 s

The Antiproton Chain

- 70 MeV / 70 mA dedicated pLinac
- SIS18 (4 GeV p)
- SIS100 (29 GeV p)
- Target / Separator: $\approx 10^{13}$ ppp \rightarrow $\approx 10^8$ pbar (0.1 Hz)
- Stochastic cooling of hot pbars in collector ring
- accumulation of pbars in accumulator ring (1 h) $\approx 10^8$ pbar \rightarrow $\approx 10^{10} - 10^{11}$ pbar
- transfer to experimental ring \rightarrow measurement
- continue accumulation during measurement
- Alternatively, accumulation and measurement can be done in one ring.

Modularized Start Version

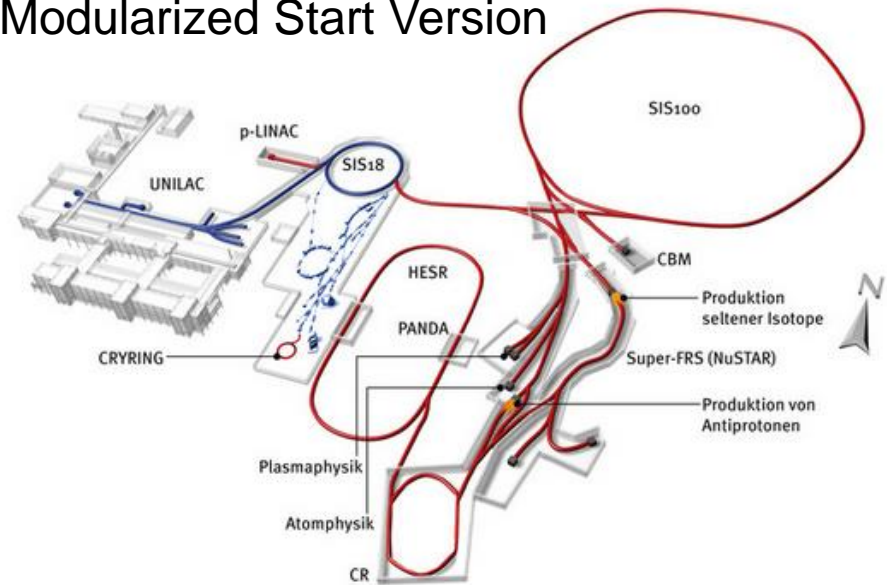

Full version of FAIR

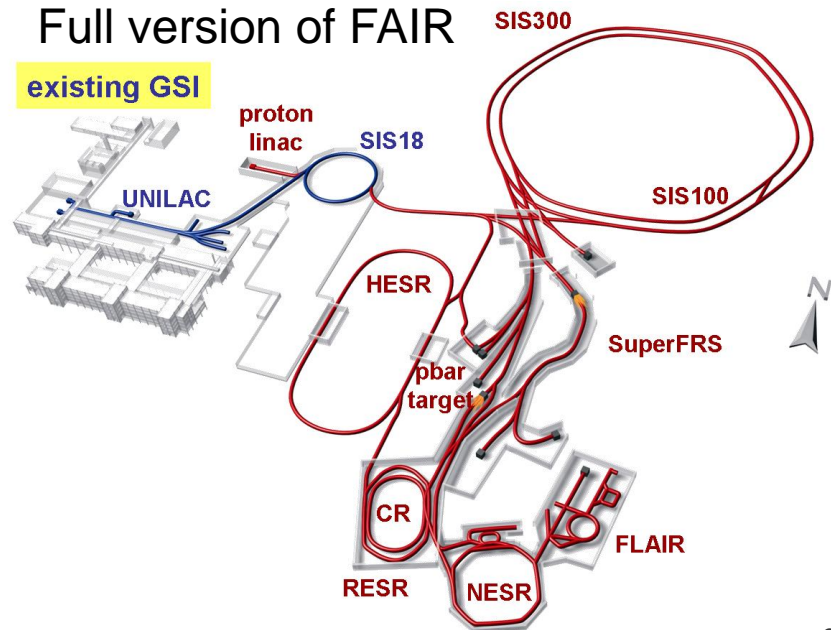

Creation of Antiprotons

c.m.

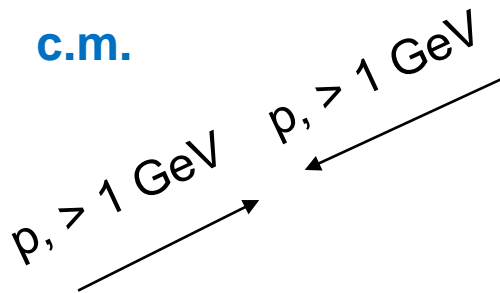

$$m = E / c^2$$

$$m_p = m_{pbar} \approx 1 \text{ GeV} / c^2$$

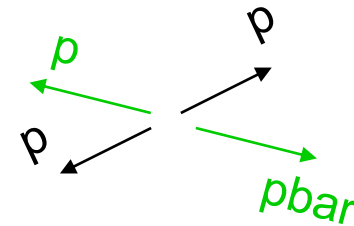

lab

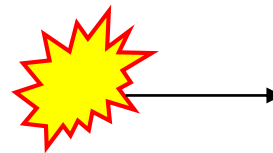

$$m = E / c^2$$

$$T_{pbar} > 6 \text{ GeV}$$

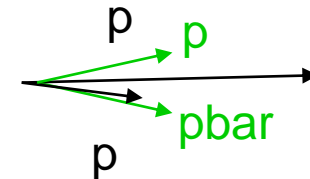

Collectible pbars

Emax SIS 100

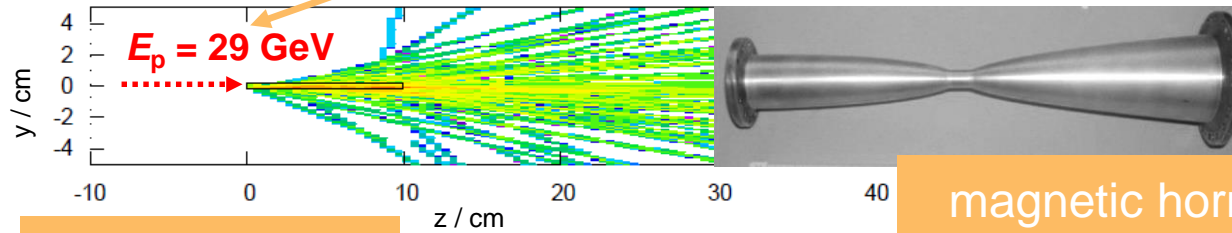

magnetic horn

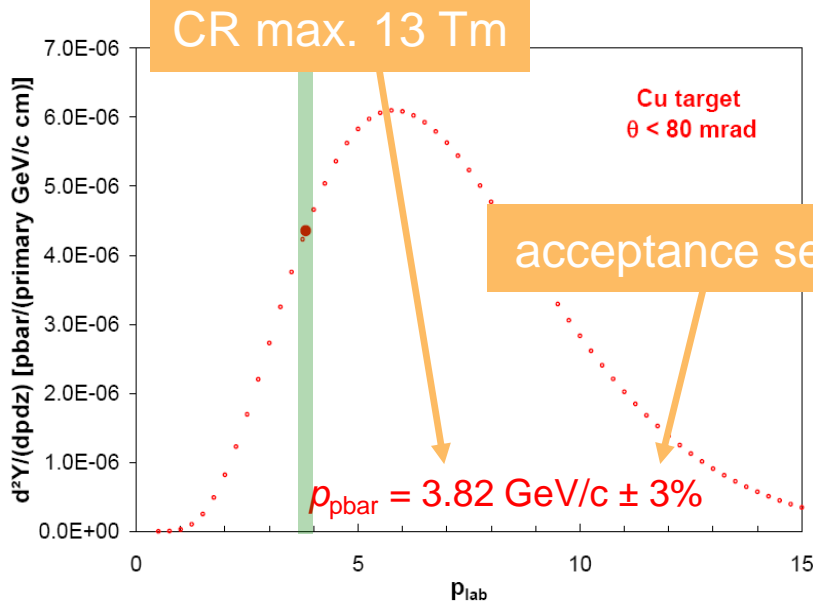

acceptance separator/CR

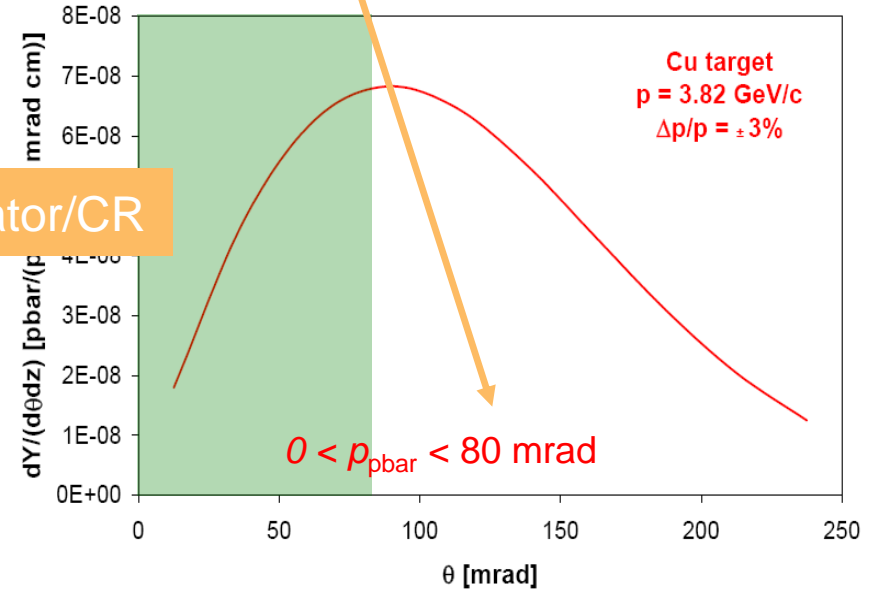

From $\sim 2.5 \times 10^{-4}$ pbar / (p cm target) $\sim 5 \times 10^{-6}$ (or 2 %) are "collectible"

MARS Simulation of the pbar Yields

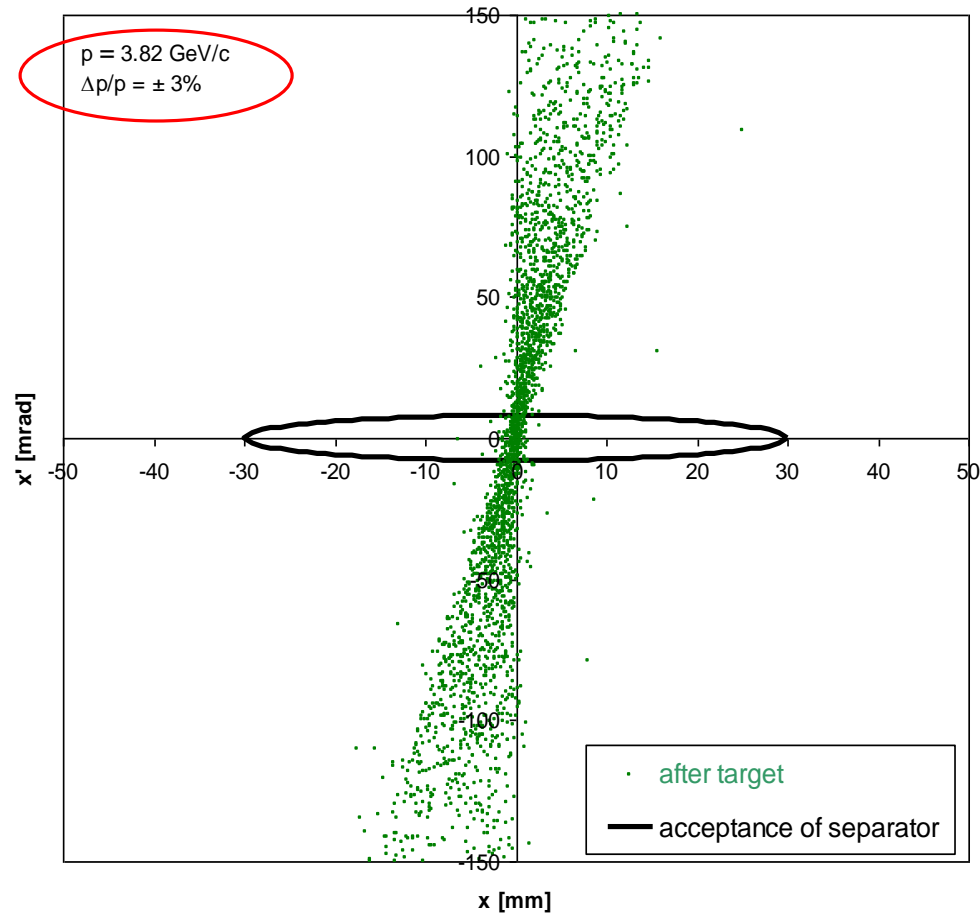

Collecting pbars: Magnetic Horn

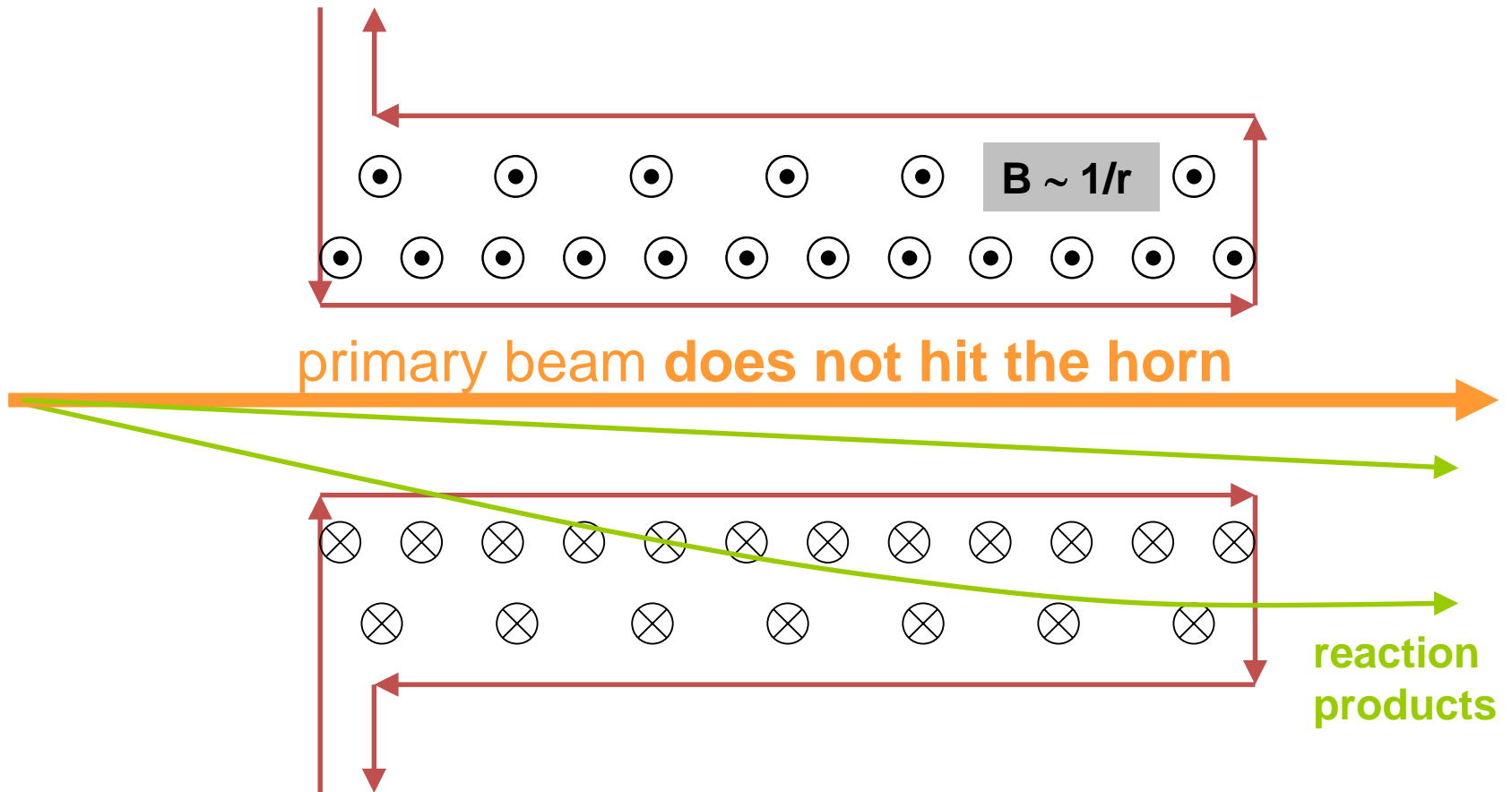

Collecting pbars: Magnetic Horn

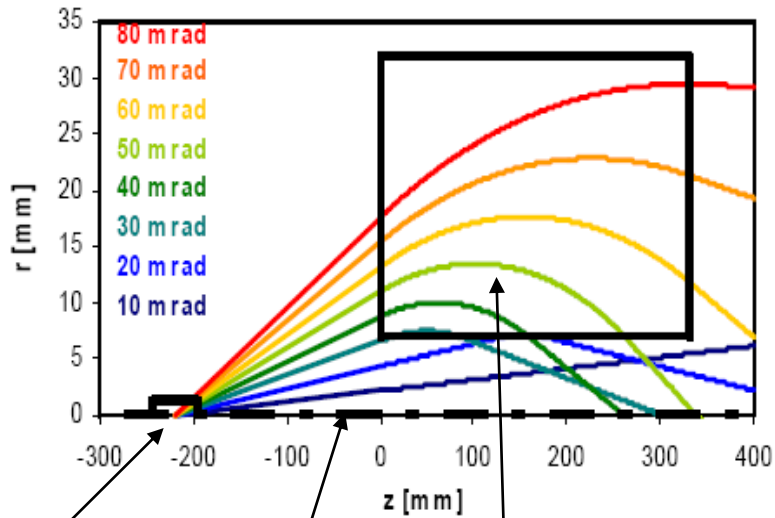

target beam axis magnetic field area

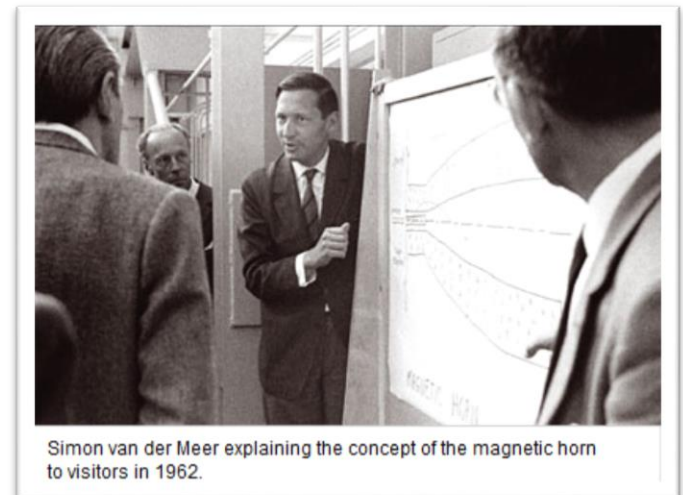
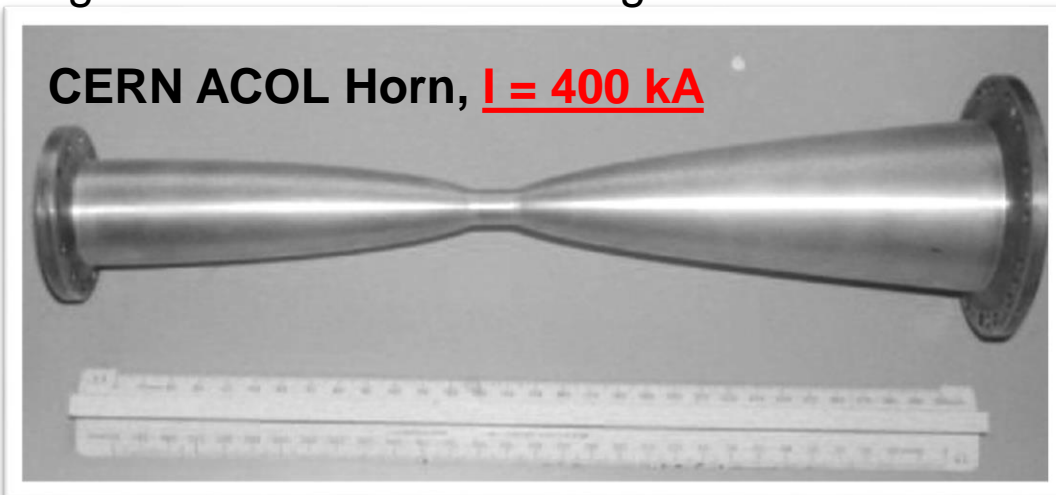
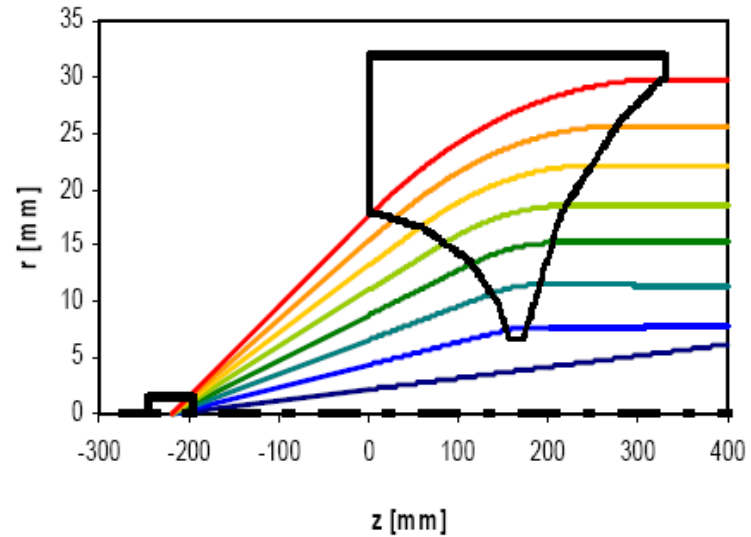

Simon van der Meer explaining the concept of the magnetic horn to visitors in 1962.

MARS Simulation of the pbar Yields

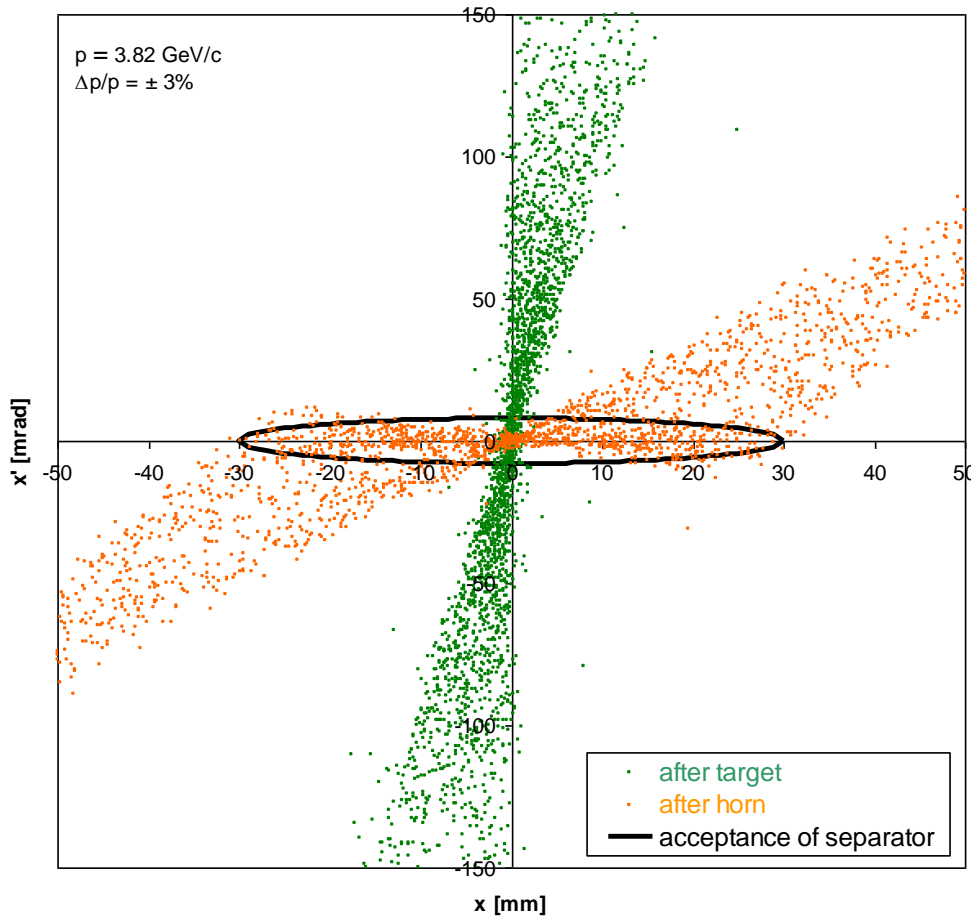

$$\text{yield} = \frac{\text{pbars in the ellipse}}{\text{primary protons}}$$
$$= 2 \times 10^{-5}$$

Collectible pbars

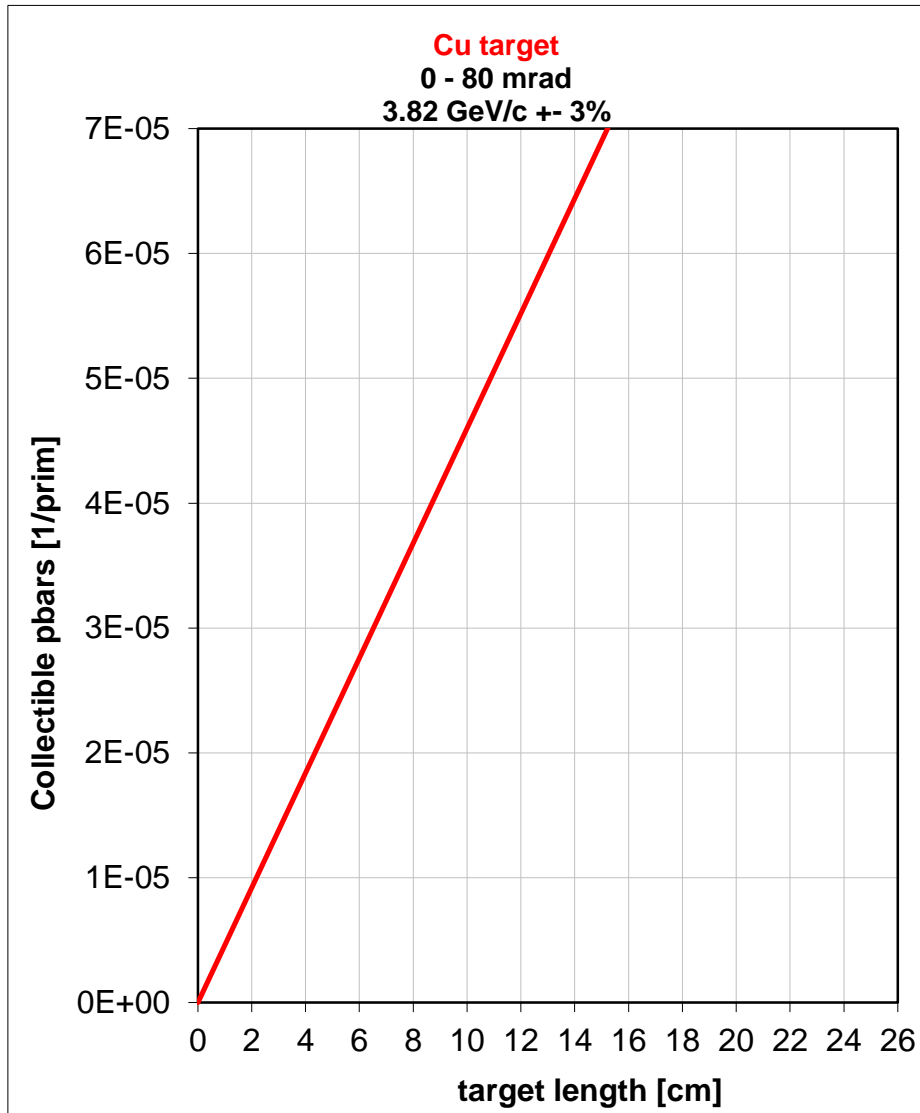

Collectible pbars: Self Absorption

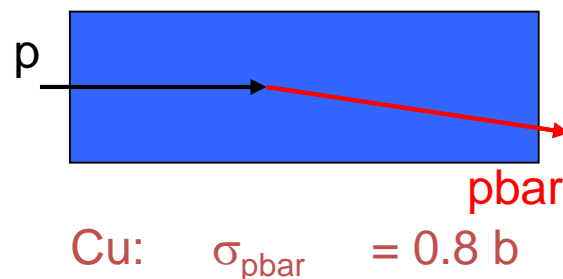
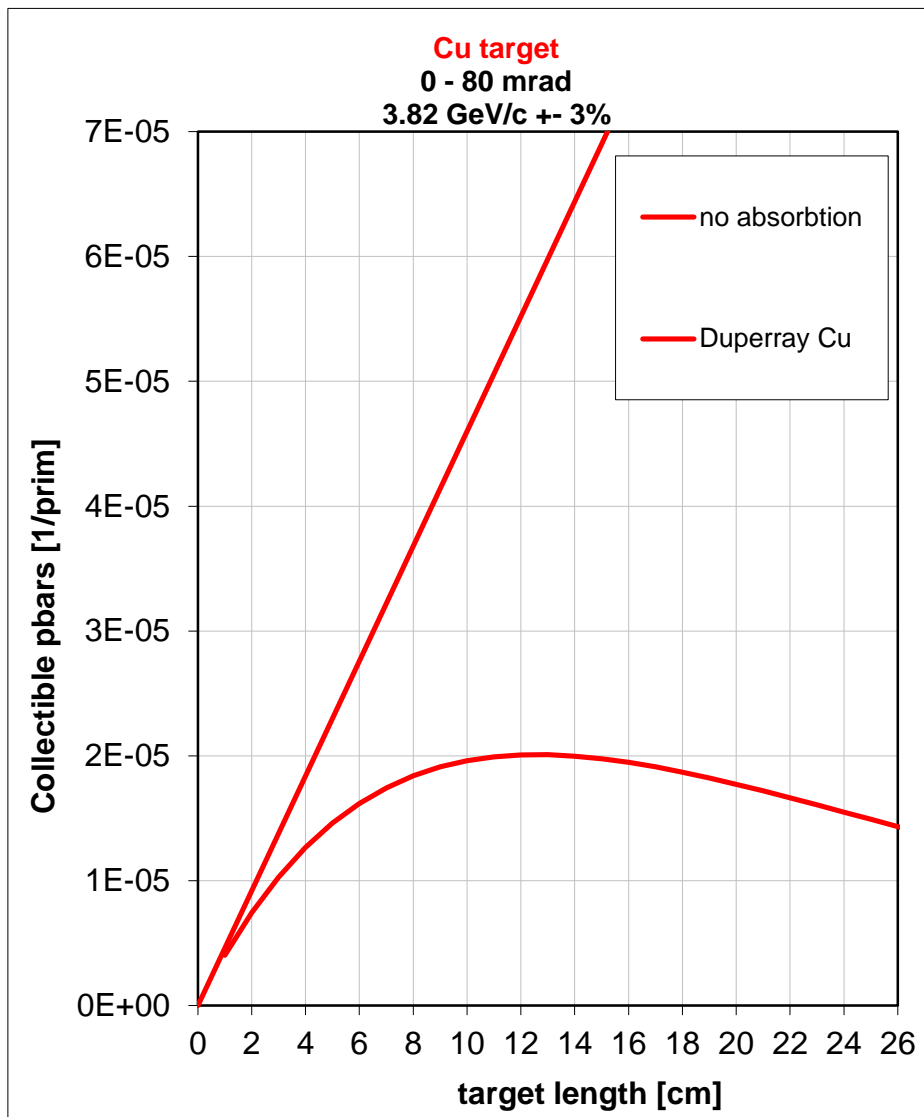

Collectible pbars: MARS/FLUKA

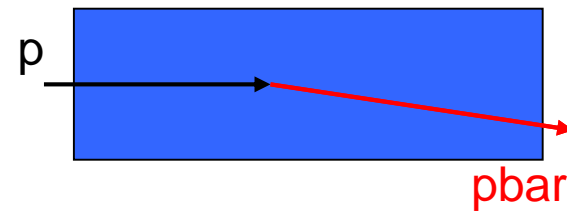
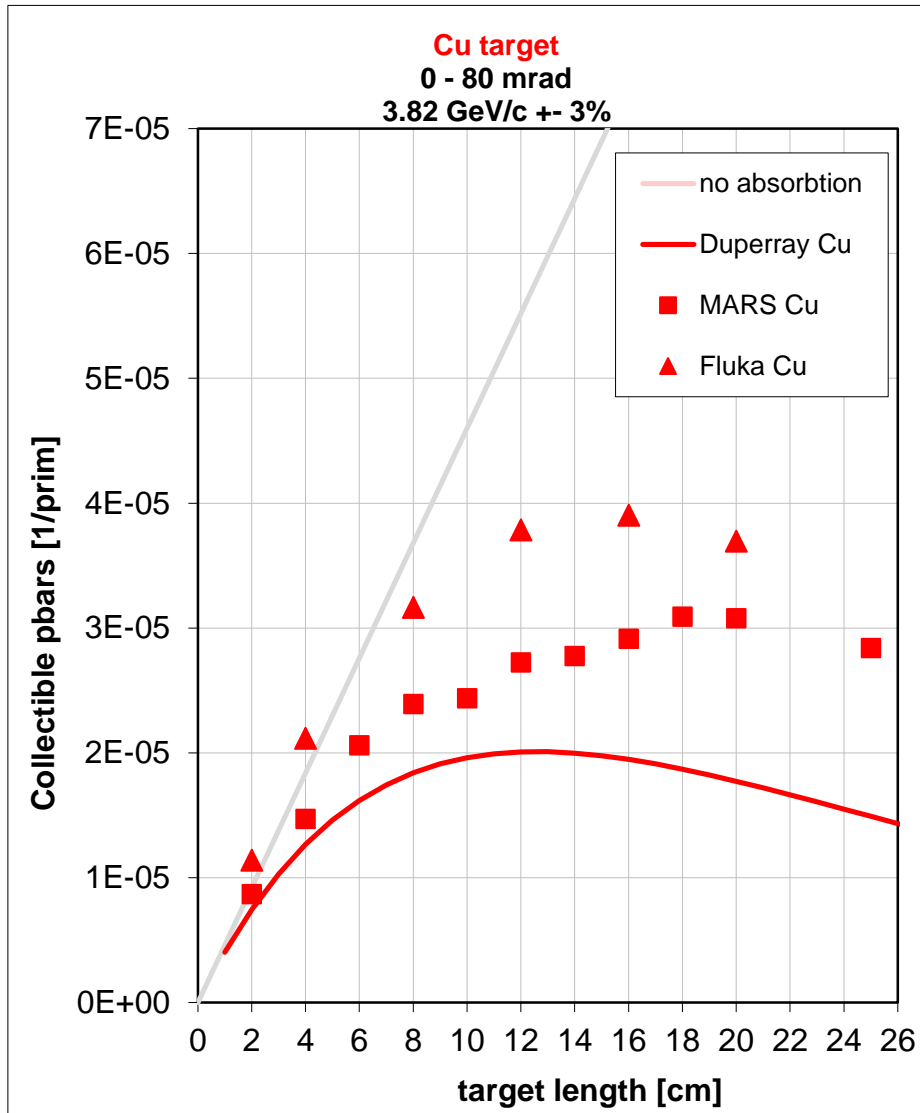

Cu: $\sigma_{pbar} = 0.8 \text{ b}$

Collectible pbars: MARS

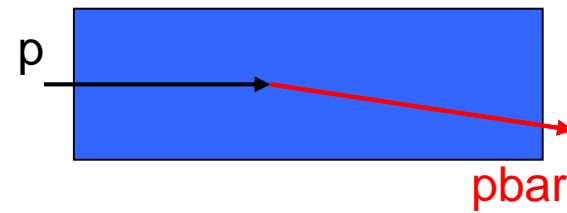
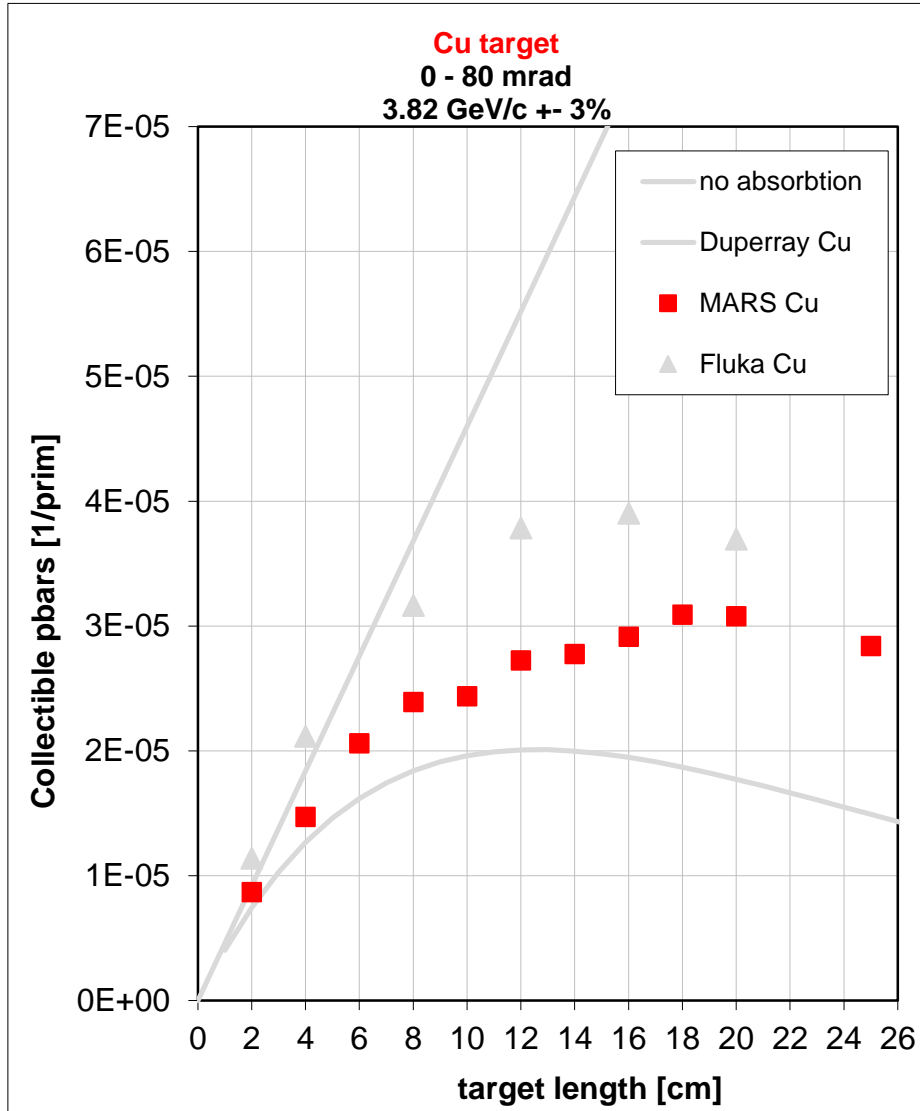

Cu: $\sigma_{pbar} = 0.8 \text{ b}$

Collectible pbars: Graphite Surrounding

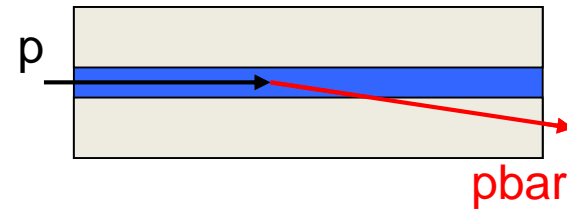
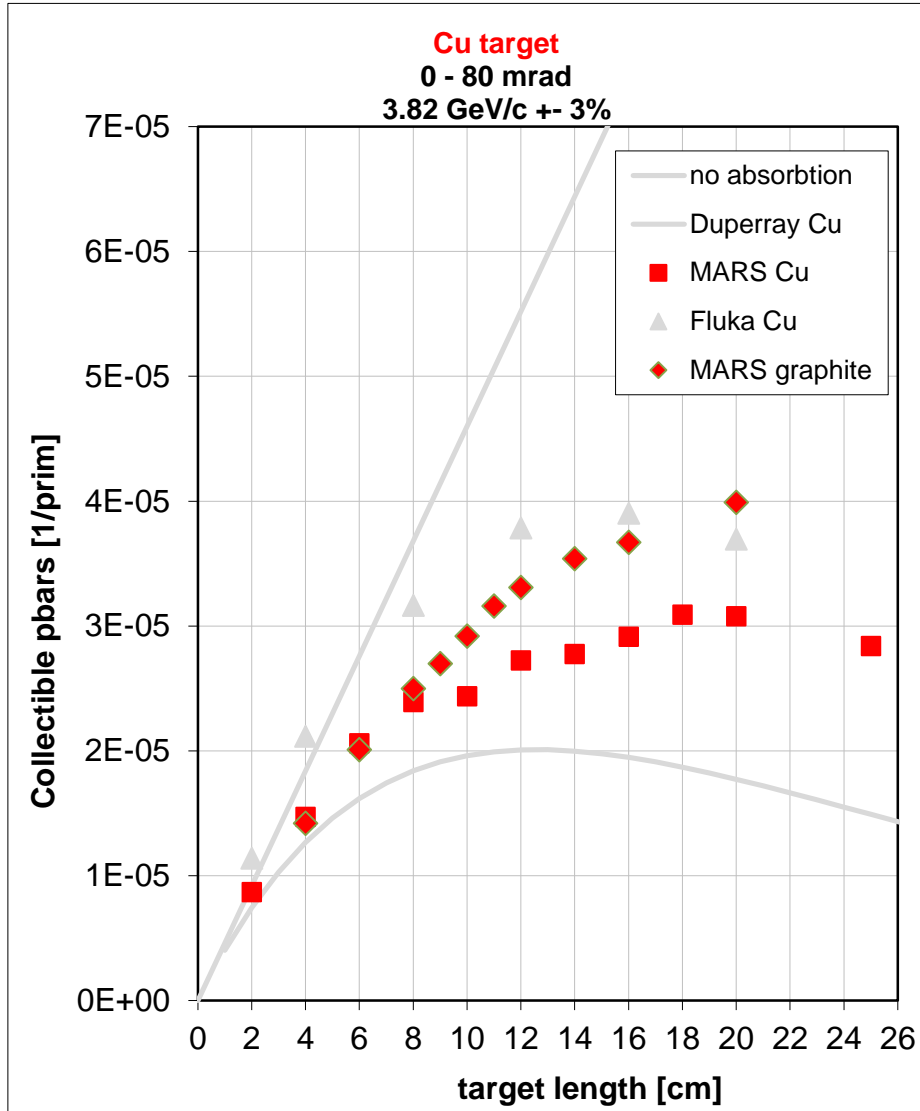

Cu: $\sigma_{pbar} = 8.8 \text{ b}$

C: $\sigma_{pbar} = 0.42 \text{ b}$

pbar Yield:

Collection efficiency of the magnetic horn

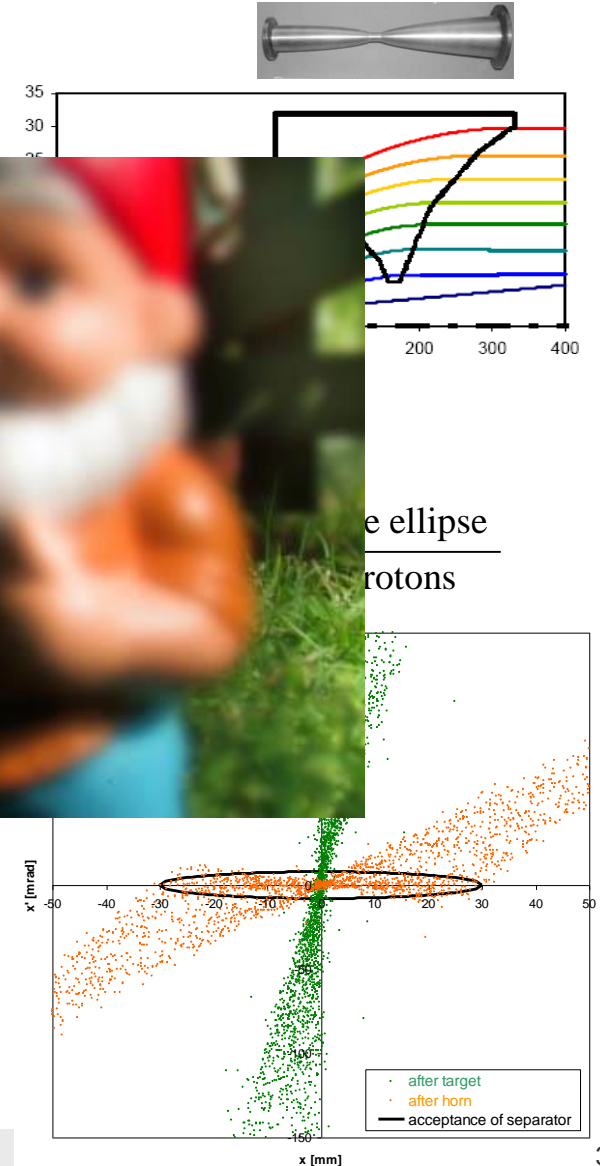
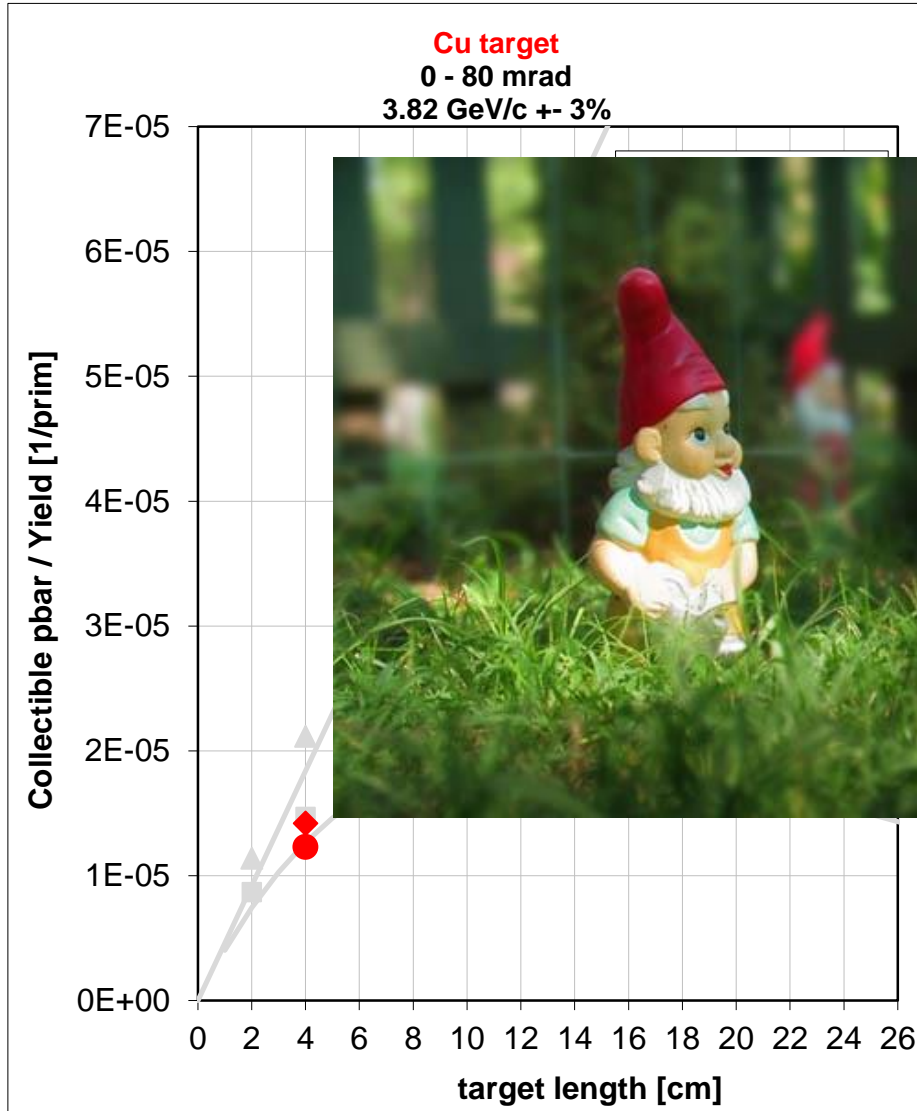

pbar Yield: High density targets?

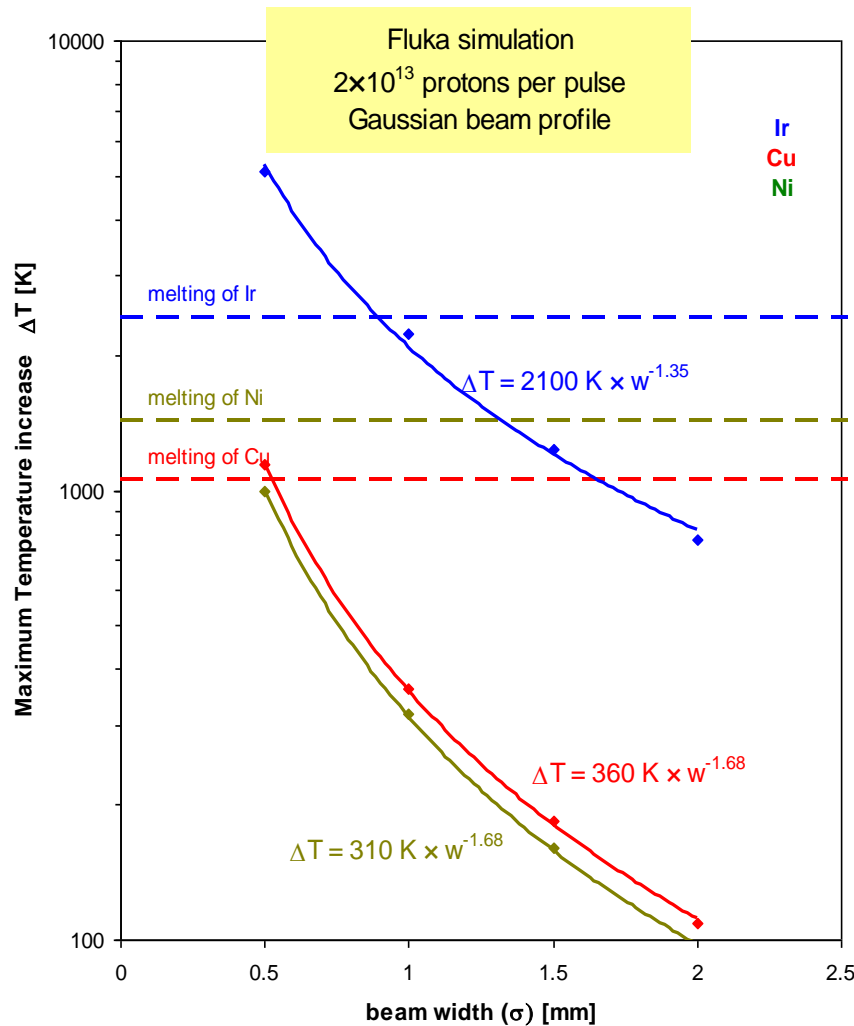

Ir (used at CERN), 22.65 g/cm^3

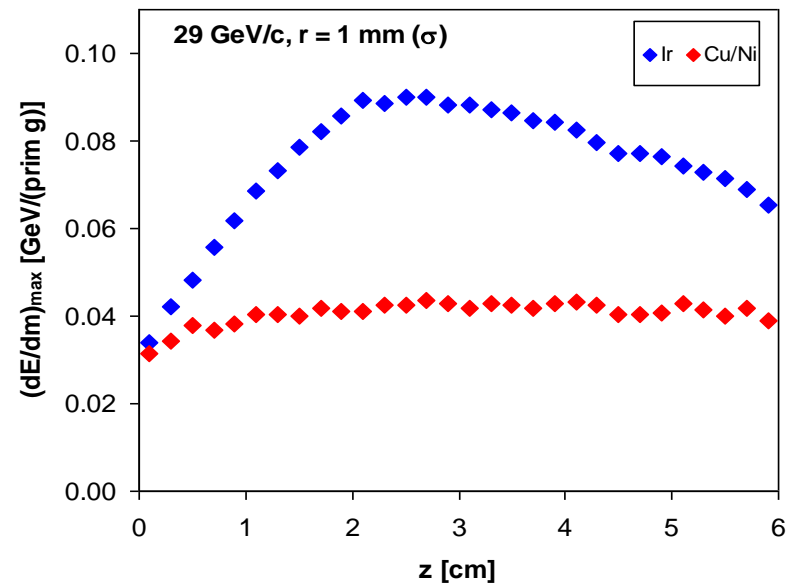

$$c_{\text{Ir}} = 130 \text{ J kg}^{-1} \text{ K}^{-1}$$

$$c_{\text{Cu}} = 385 \text{ J kg}^{-1} \text{ K}^{-1}$$

$$c_{\text{Ni}} = 440 \text{ J kg}^{-1} \text{ K}^{-1}$$

pbar Target and Magnetic Horn

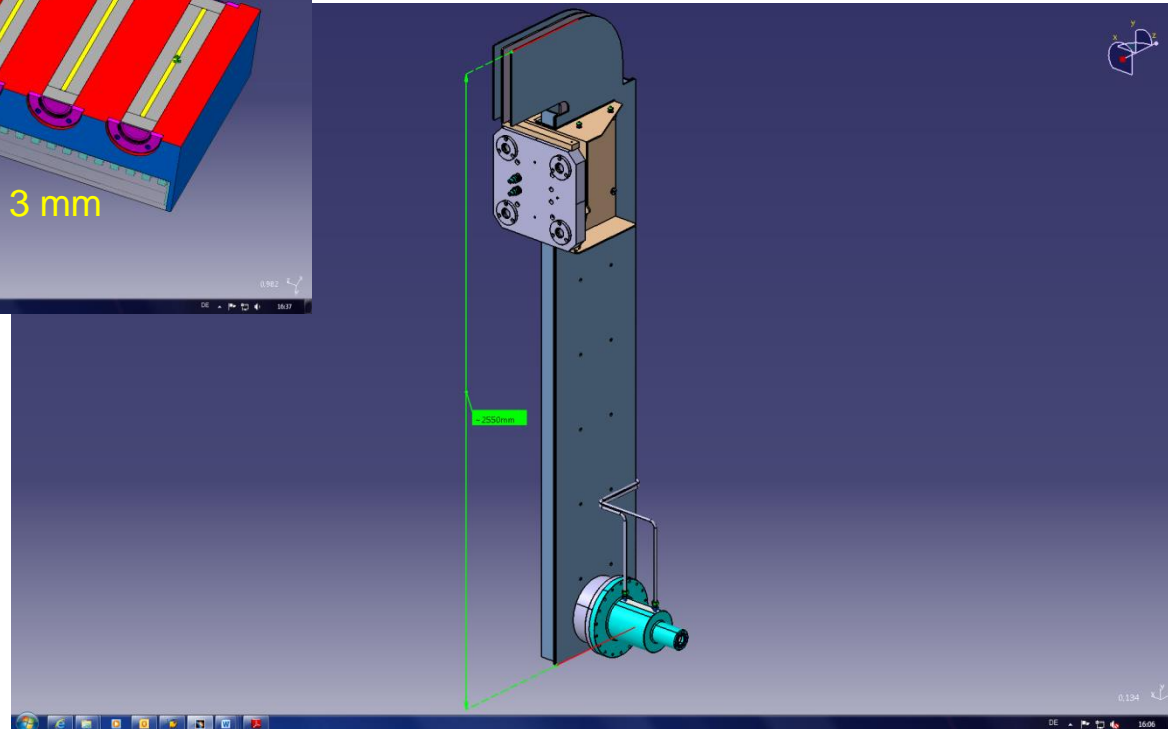
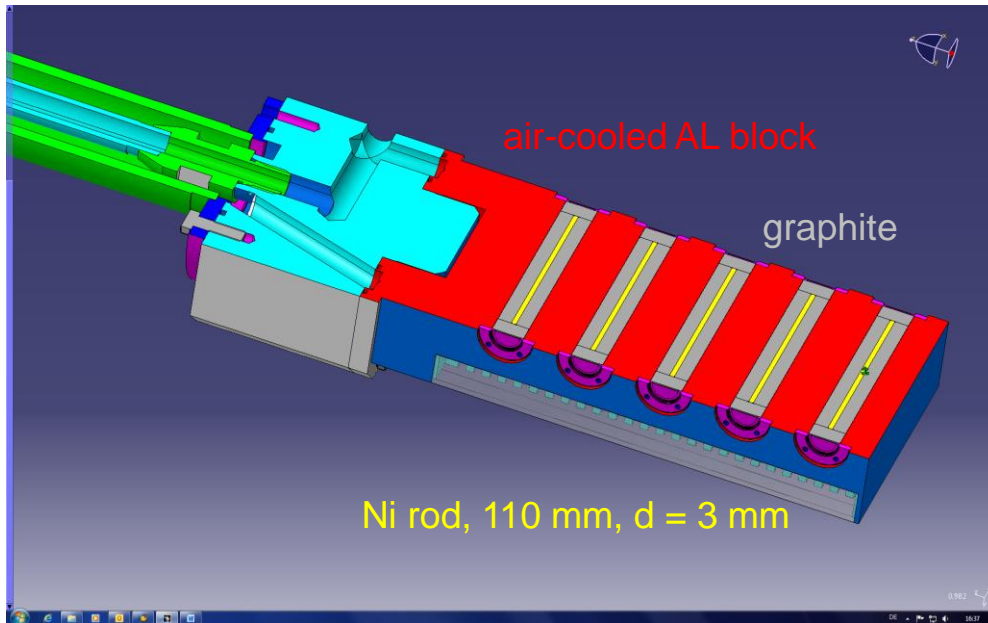

CERN target (Ir or Cu)

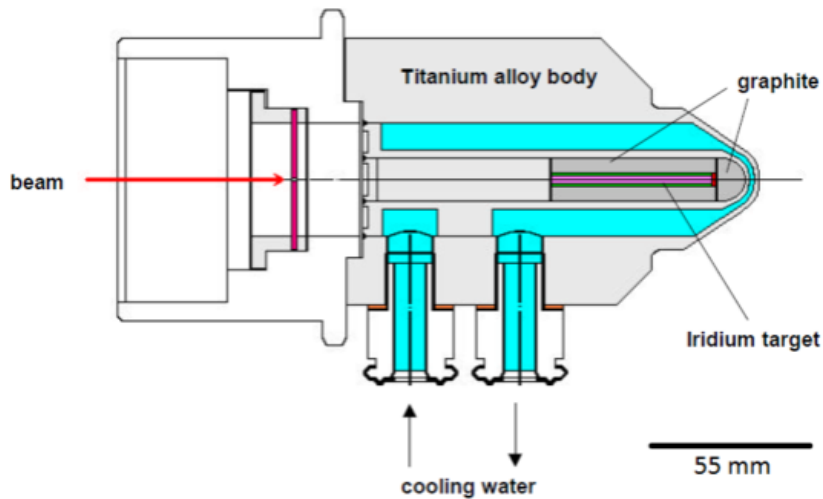

rotating Fermilab target, new and old

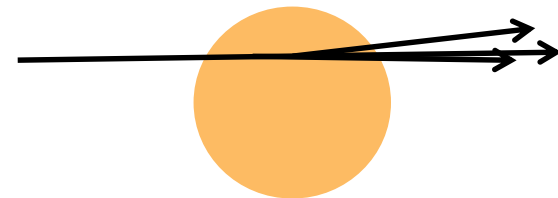

The pbar separator

pbar separator
 $240 \pi \text{ mm mrad}$
 $p = 3.82 \text{ GeV}/c$
 $\Delta p/p = \pm 3\%$

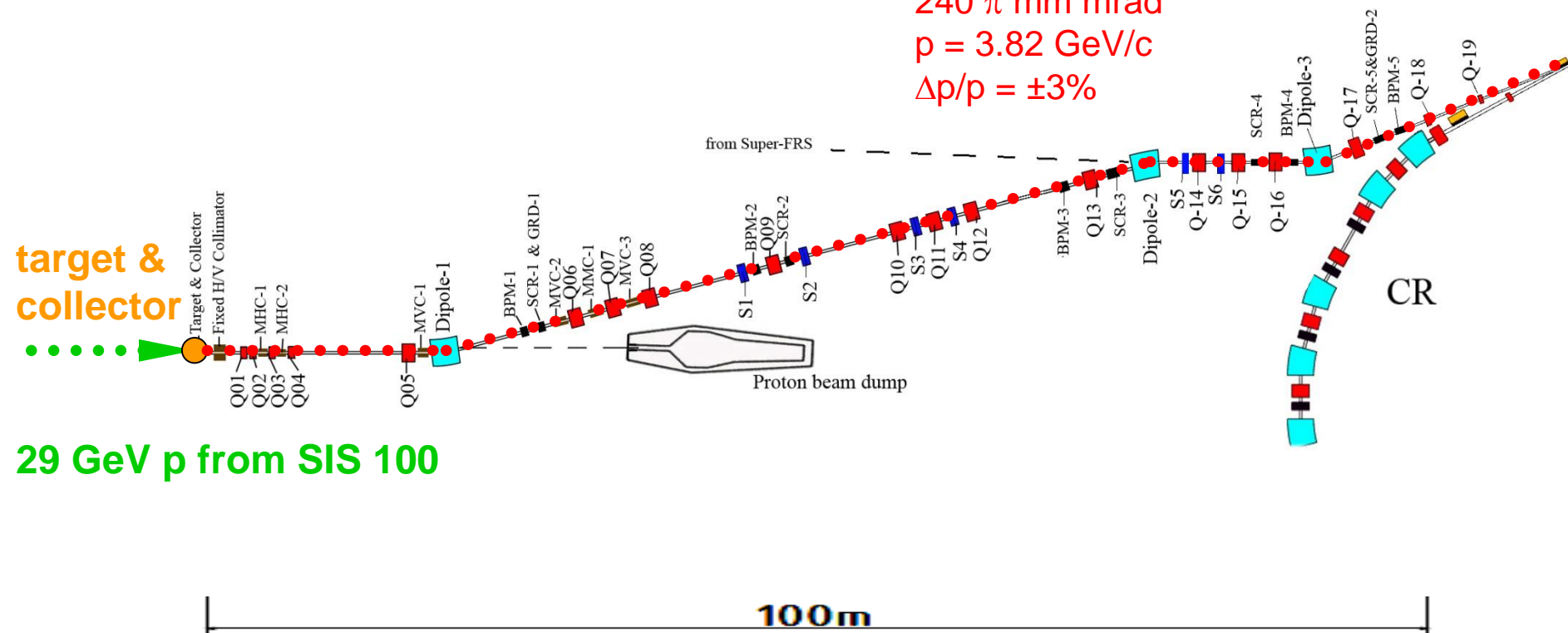

29 GeV p from SIS 100

Dose rates during operation

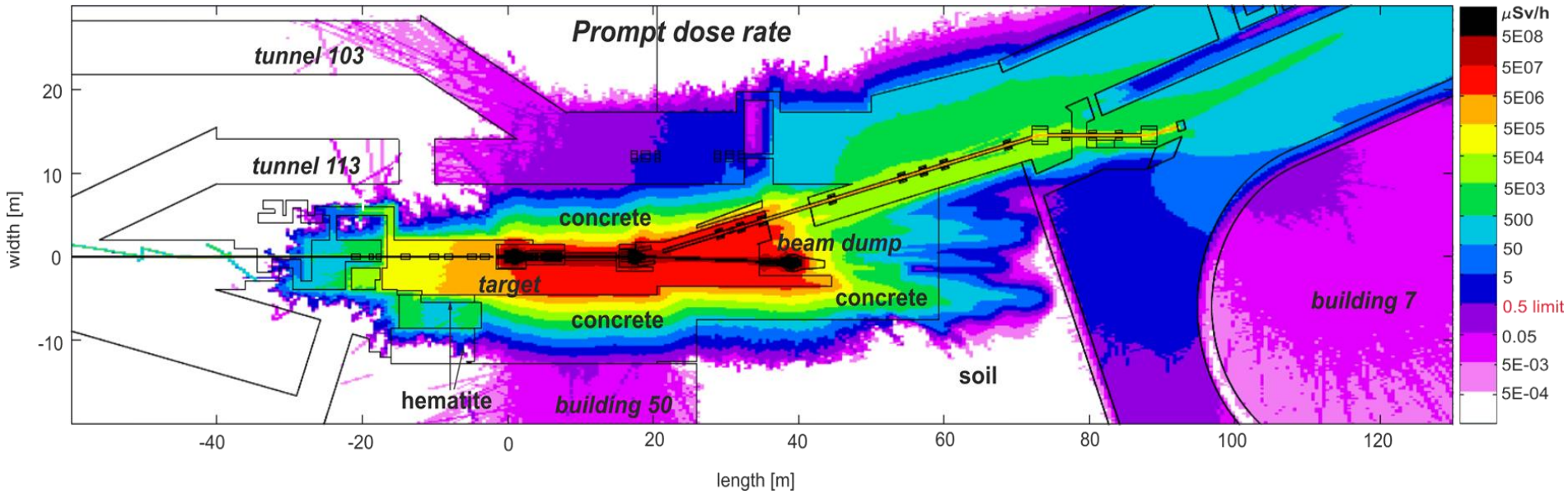

The pbar building

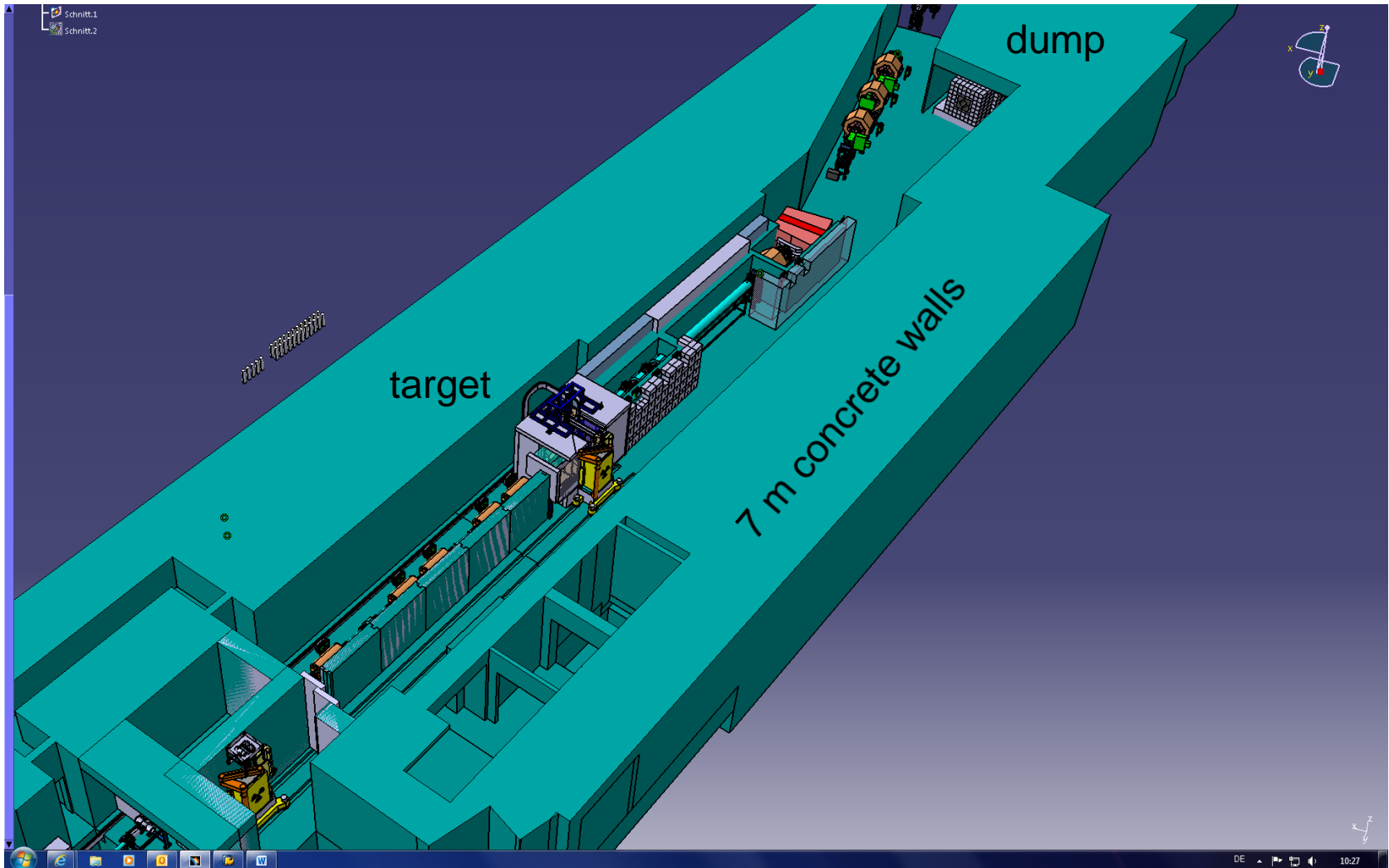

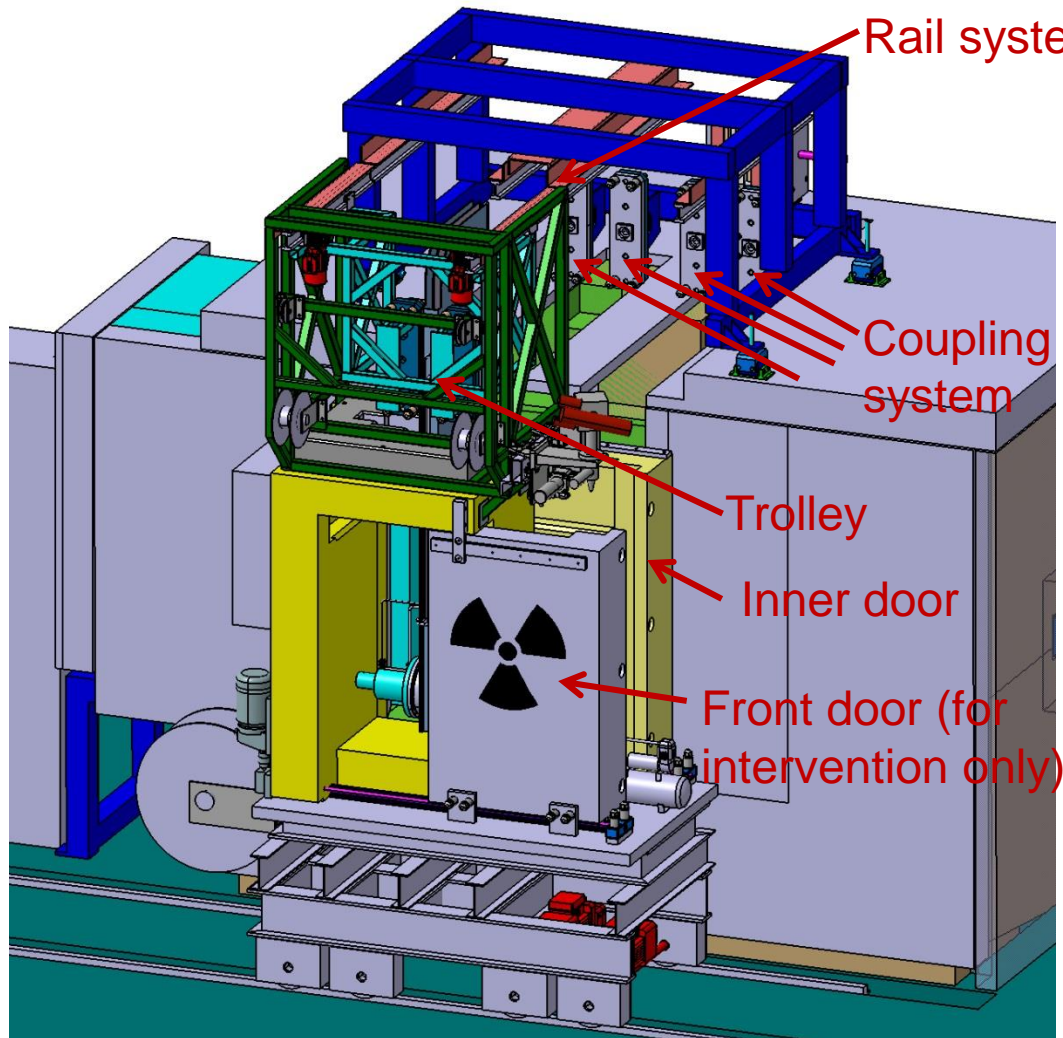

- Transport container is placed in front of target station.
- Door of target station and transport container are opened.
- Component is gripped by a quick coupling system.
- Trolley moves the component via rail system into the transport container.
- Doors are closed.

Transport concept

- Transport container moves to the shaft (1-2).
- Crane of carrying frame of the shielding flask lifts up the component (3).

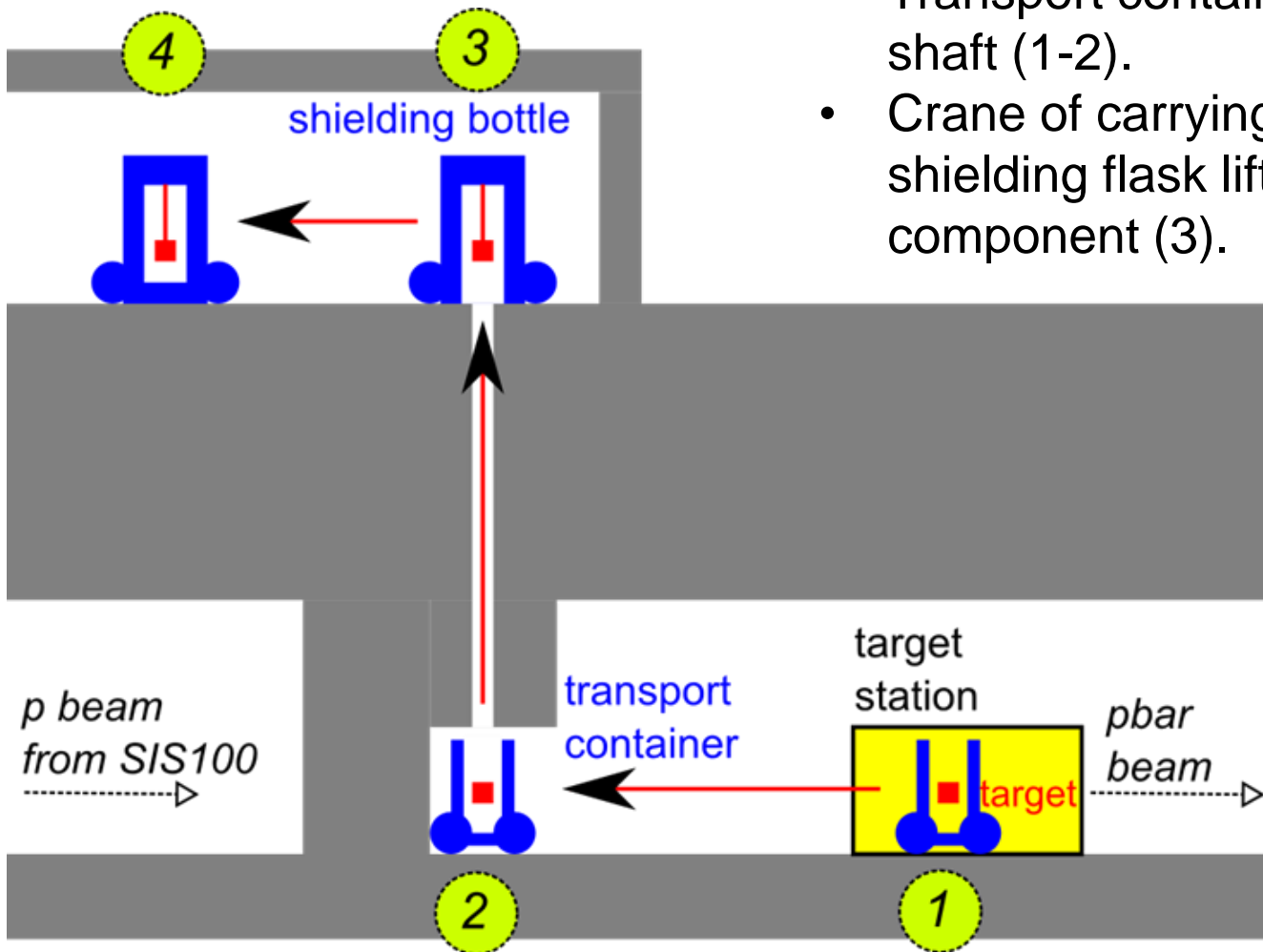

Overview of transport

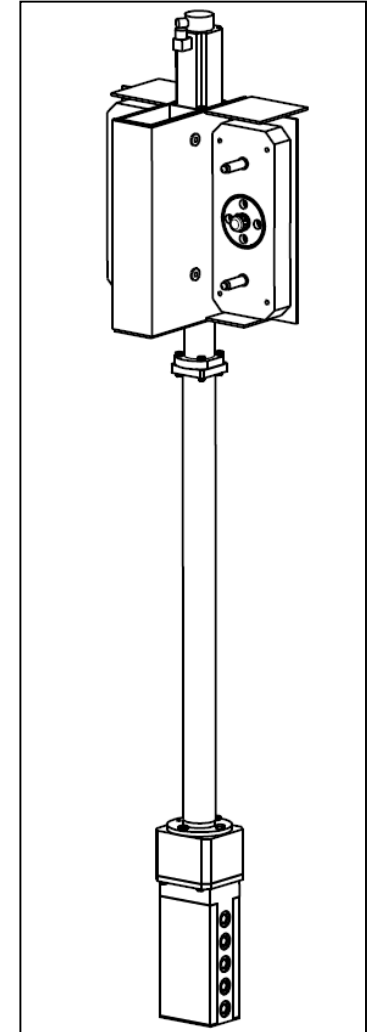
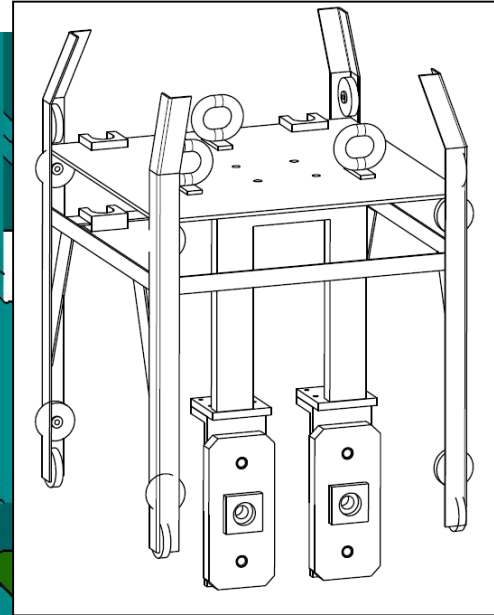
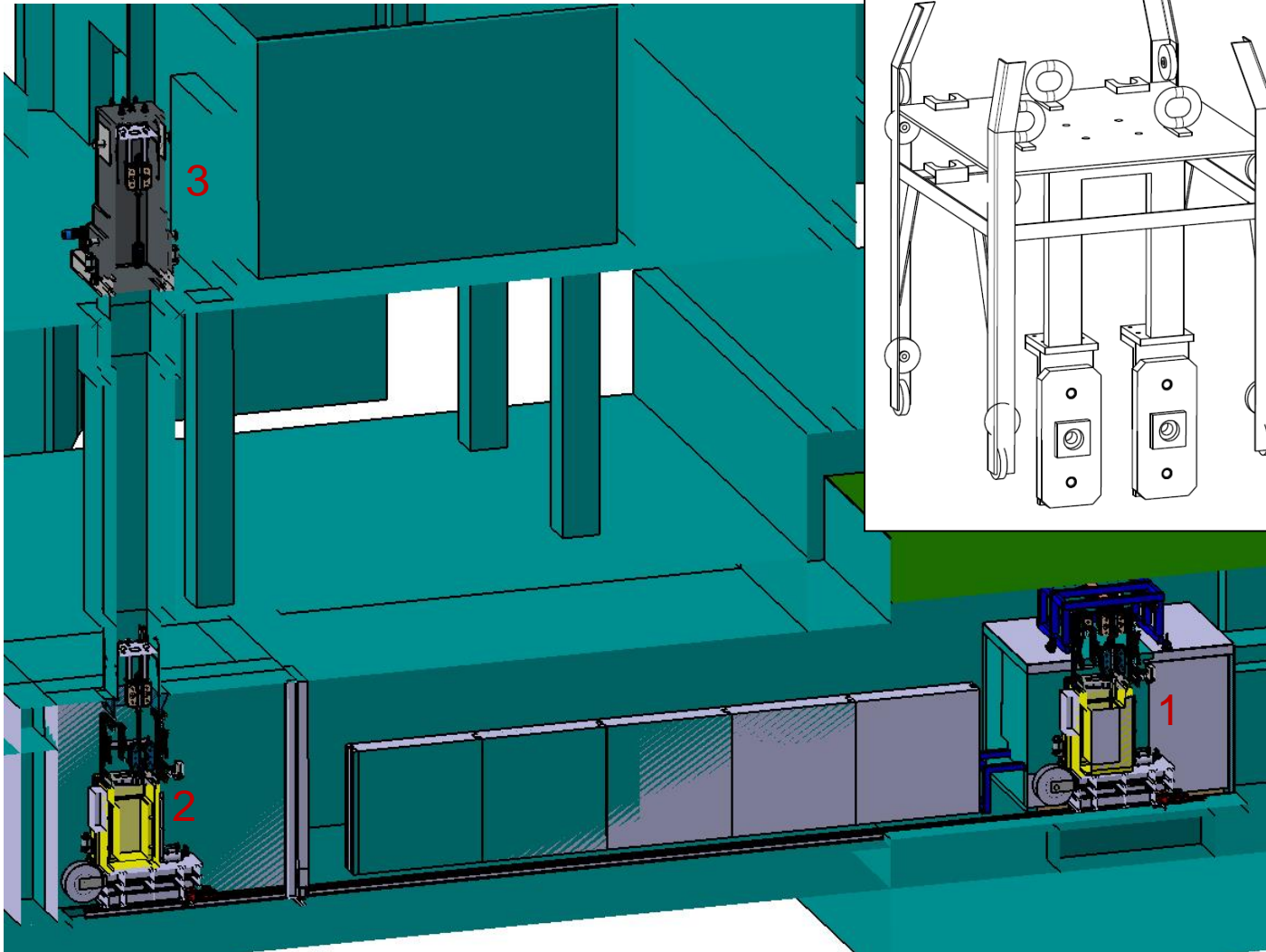

To injection orbit of collector ring:

$$p\bar{b}ar/p = 2 \times 10^{-5} \times 0.8 \times 0.7 = 1.1 \times 10^{-5}$$

scattering losses/annihilation in air/aluminum *losses in separator / during injection*

Exp. data from CERN (Baird 1998) to injection orbit:

$$p\bar{b}ar/p = 0.45 \times 10^{-5} \times 1.5 = 0.7 \times 10^{-5}$$

correction for different energies and acceptances

CR: Bunch Rotation and Stochastic Pre-Cooling

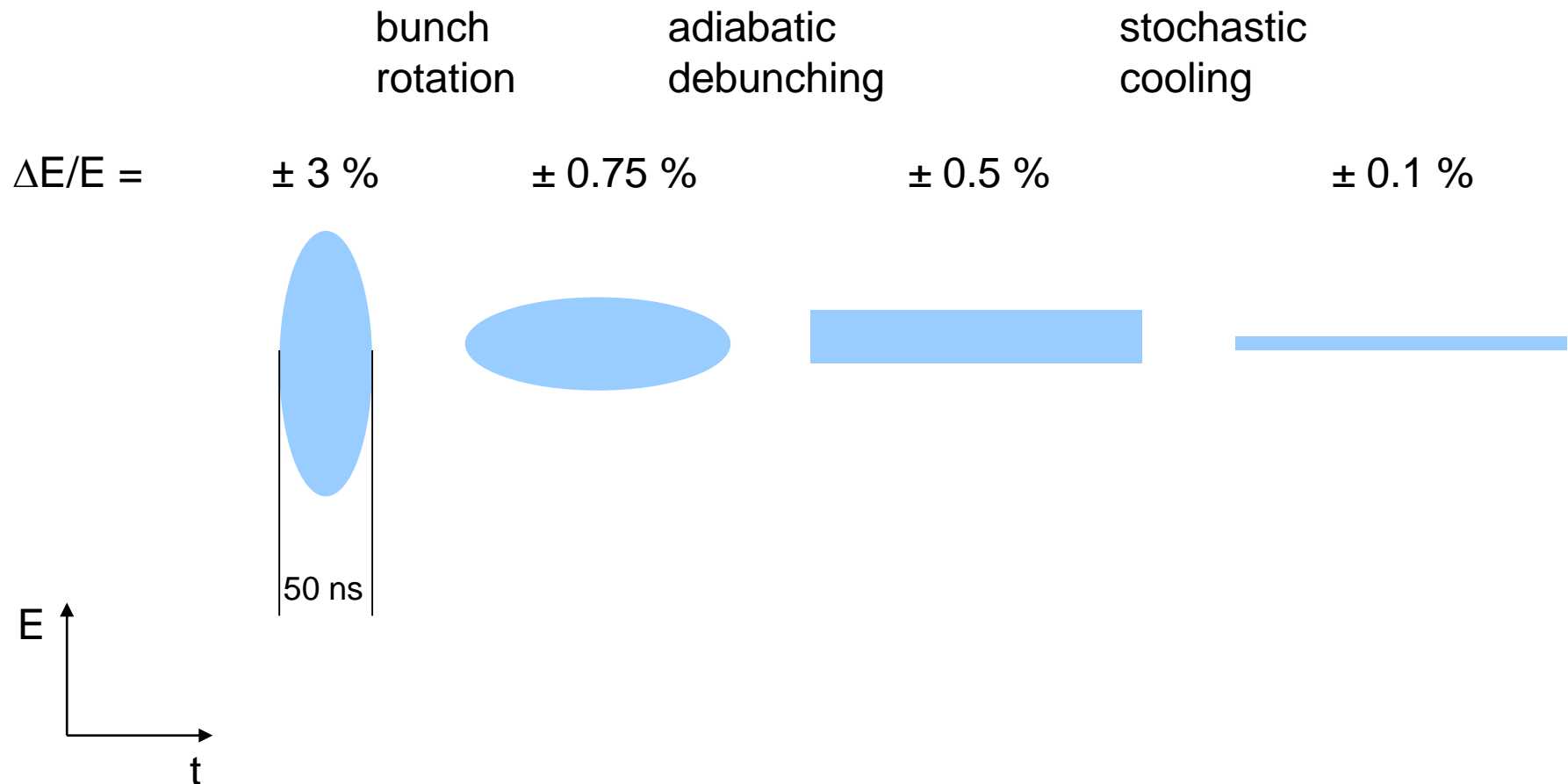

Cross section through the vacuum chamber at the momentum pick-up

stochastic cooling
for stack core



stack core

stack tail

stochastic cooling
for stack core

partial aperture
injection kicker

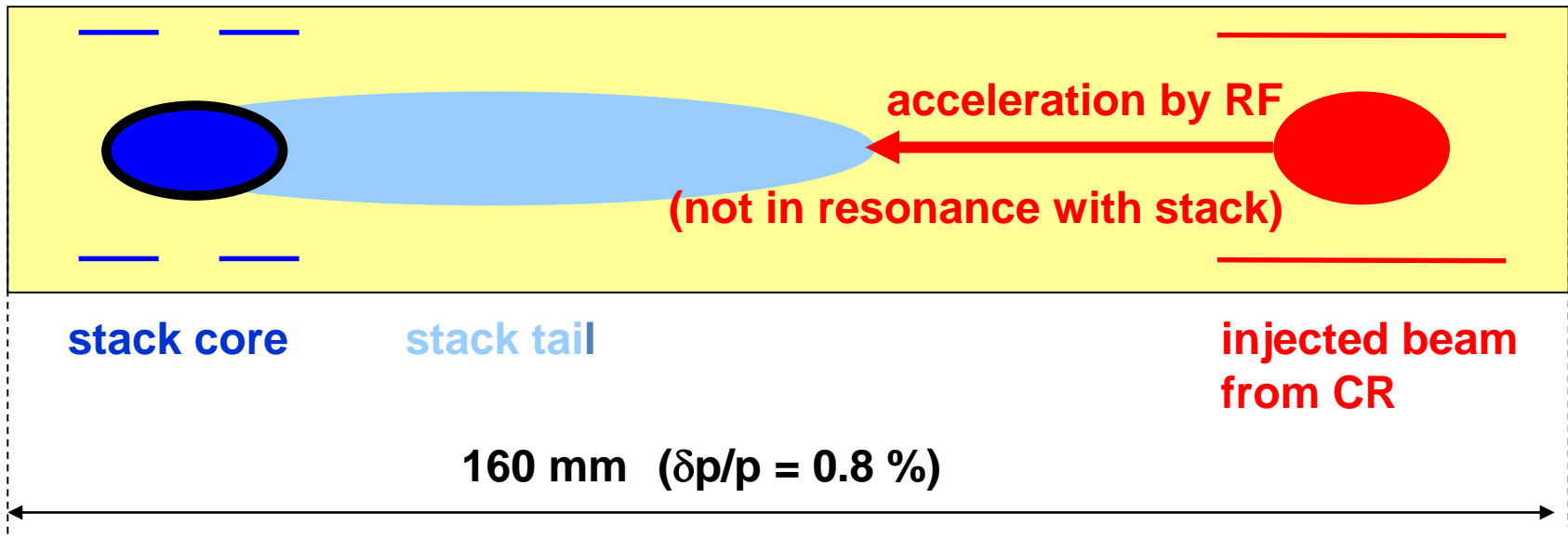

stochastic cooling
for stack core

stochastic cooling
for beam deposit
(high amplification)

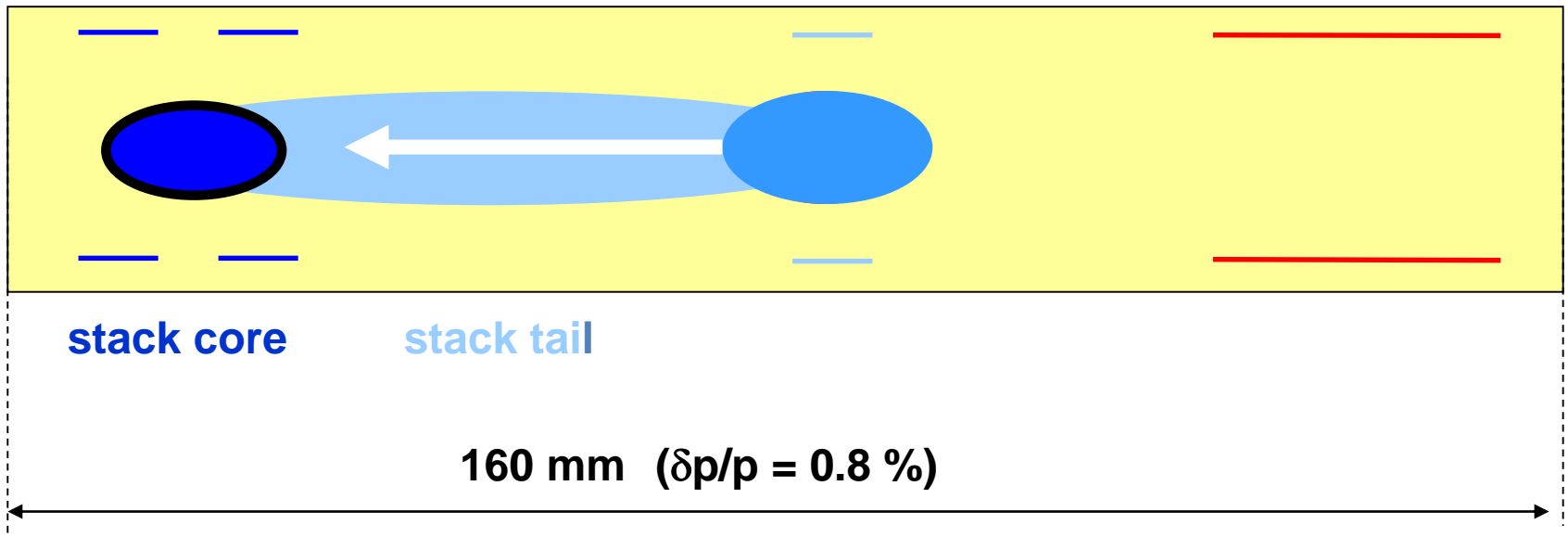

stochastic cooling for stack core

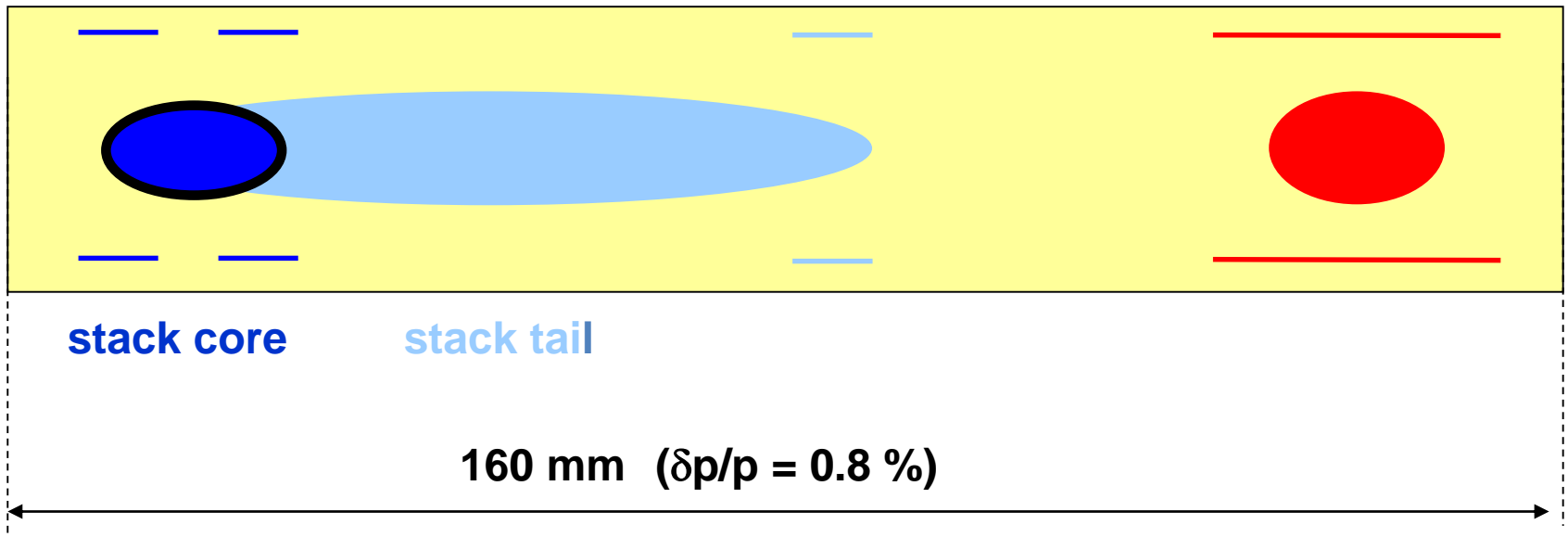

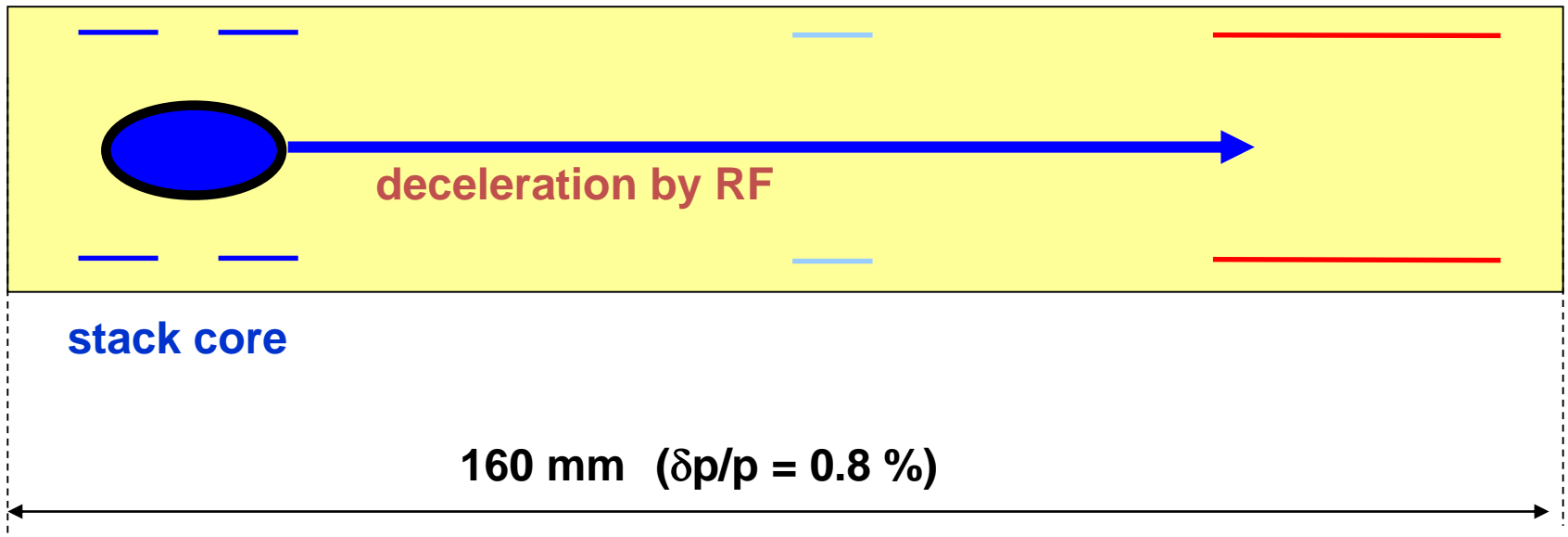

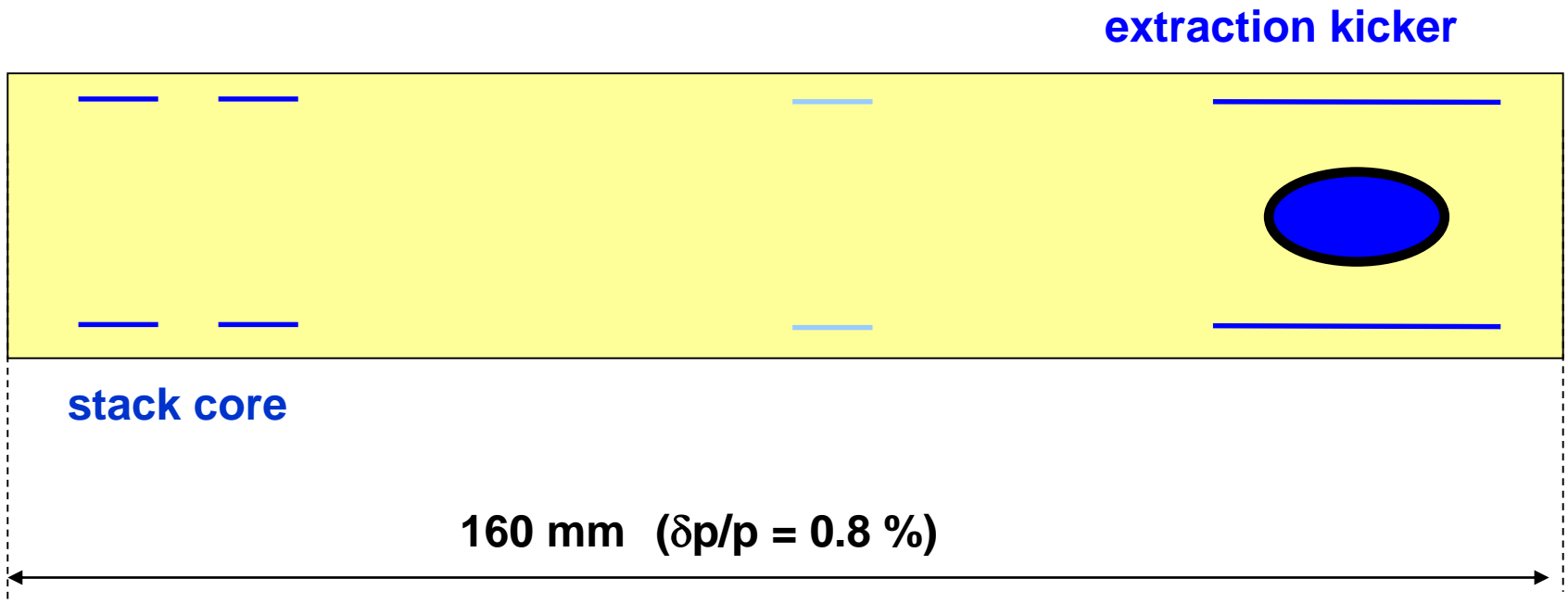

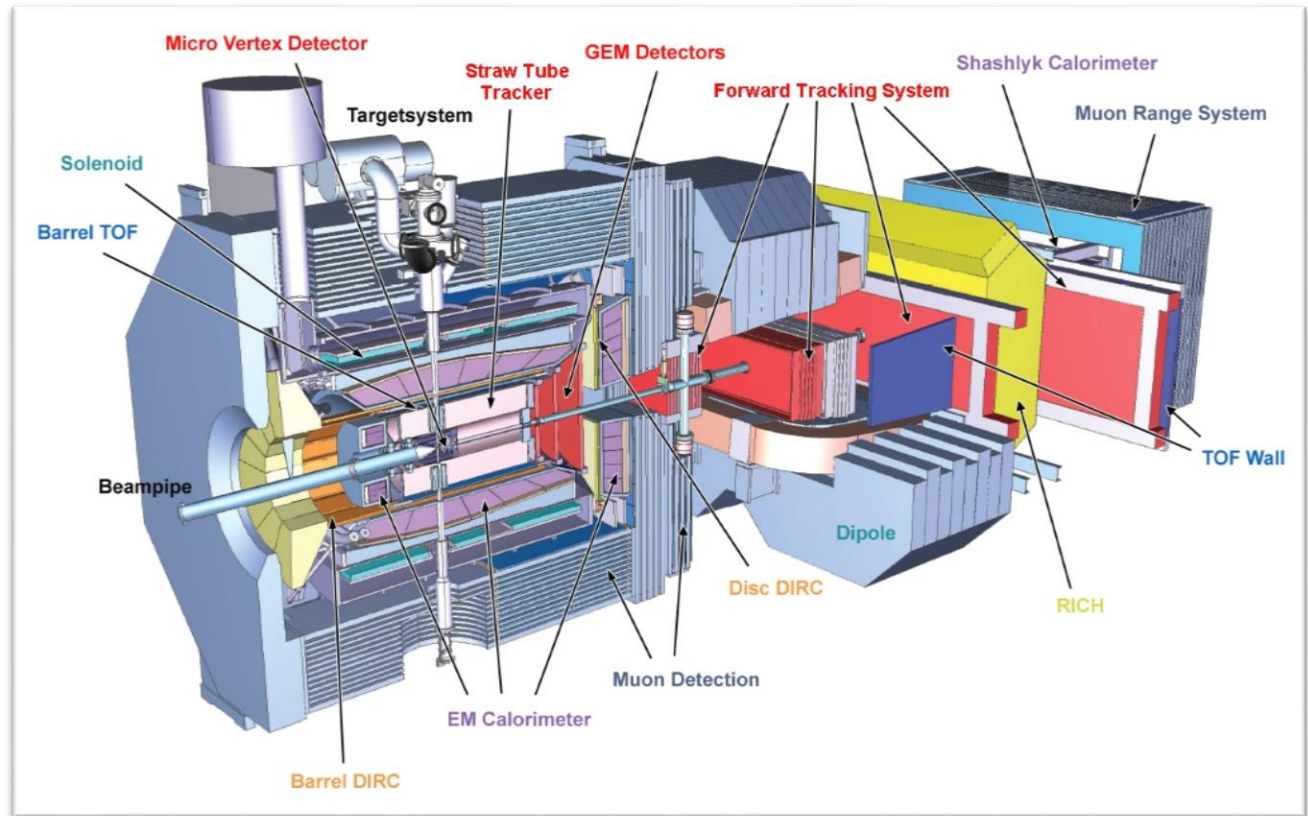
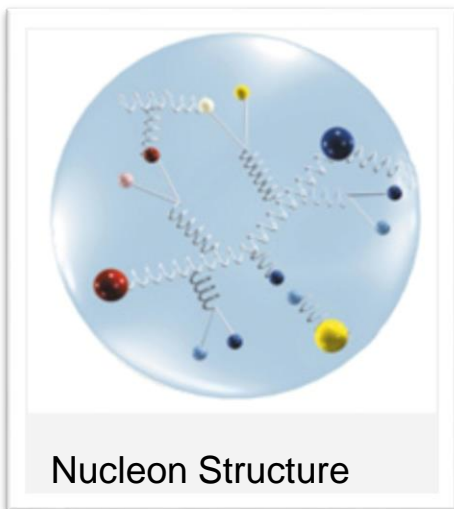
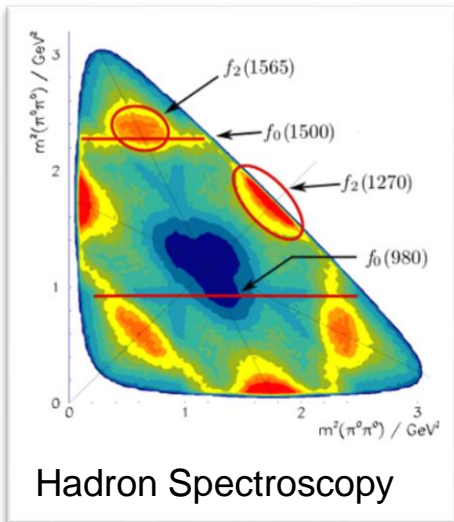

Pellet target: Frozen hydrogen droplets

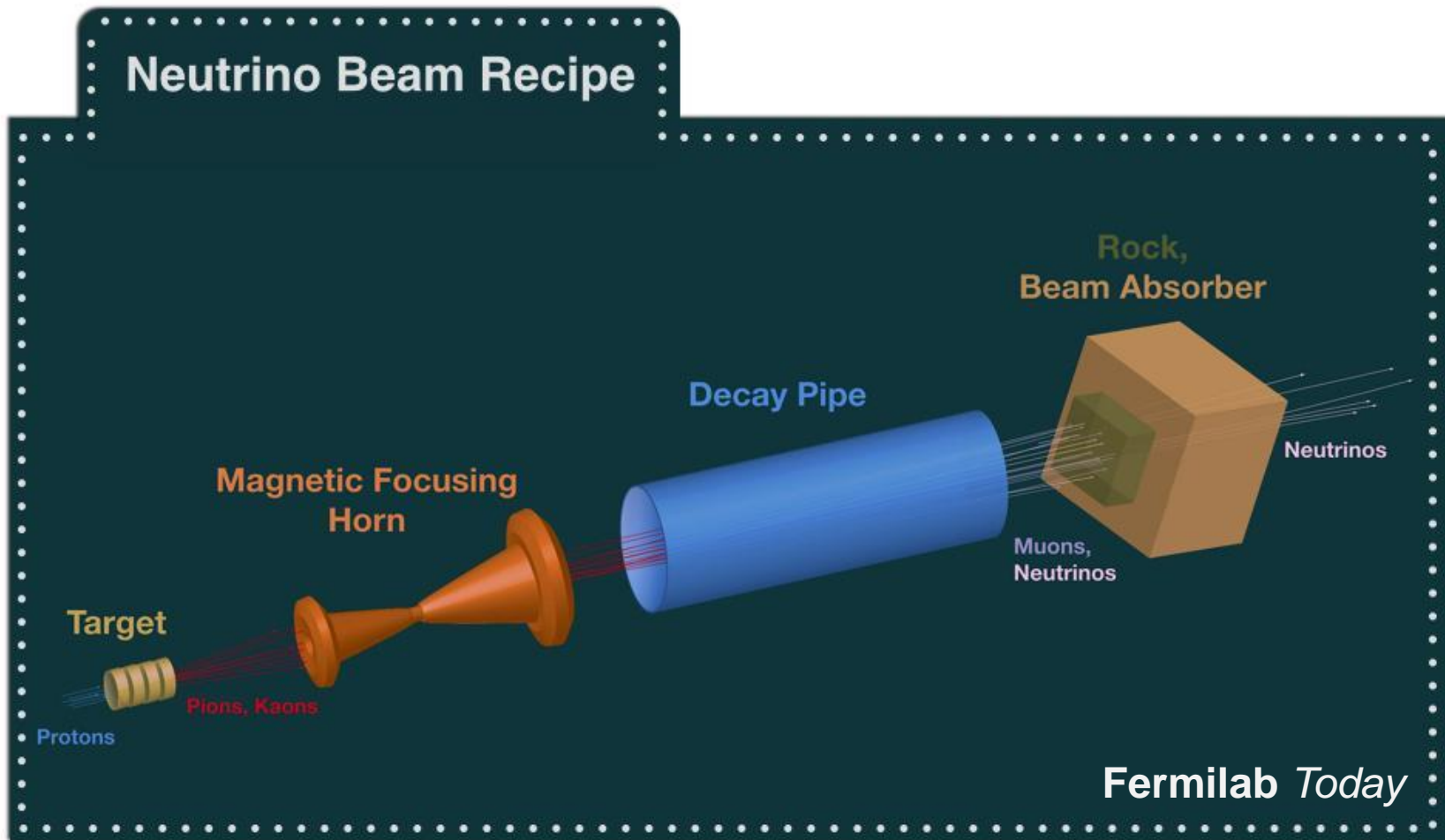

CNGS: CERN Neutrinos to Gran Sasso

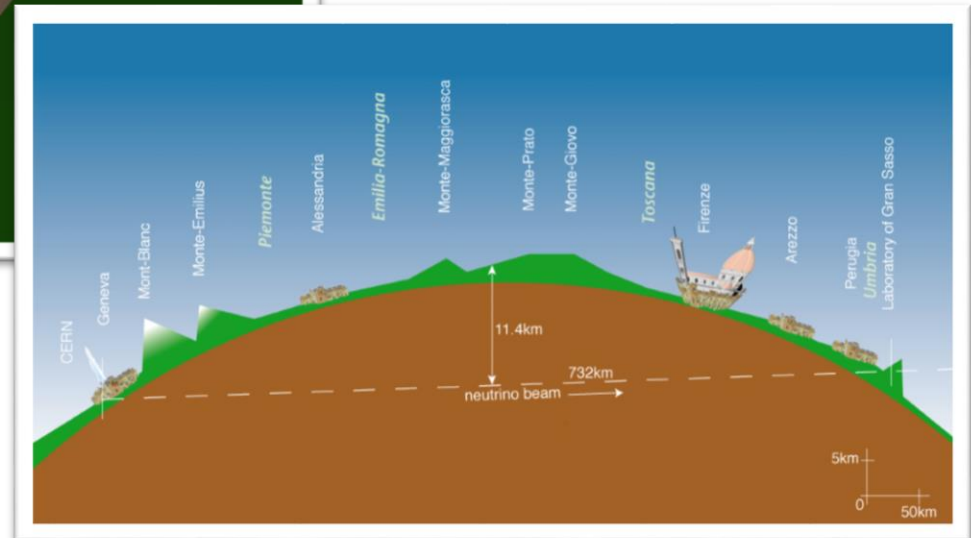
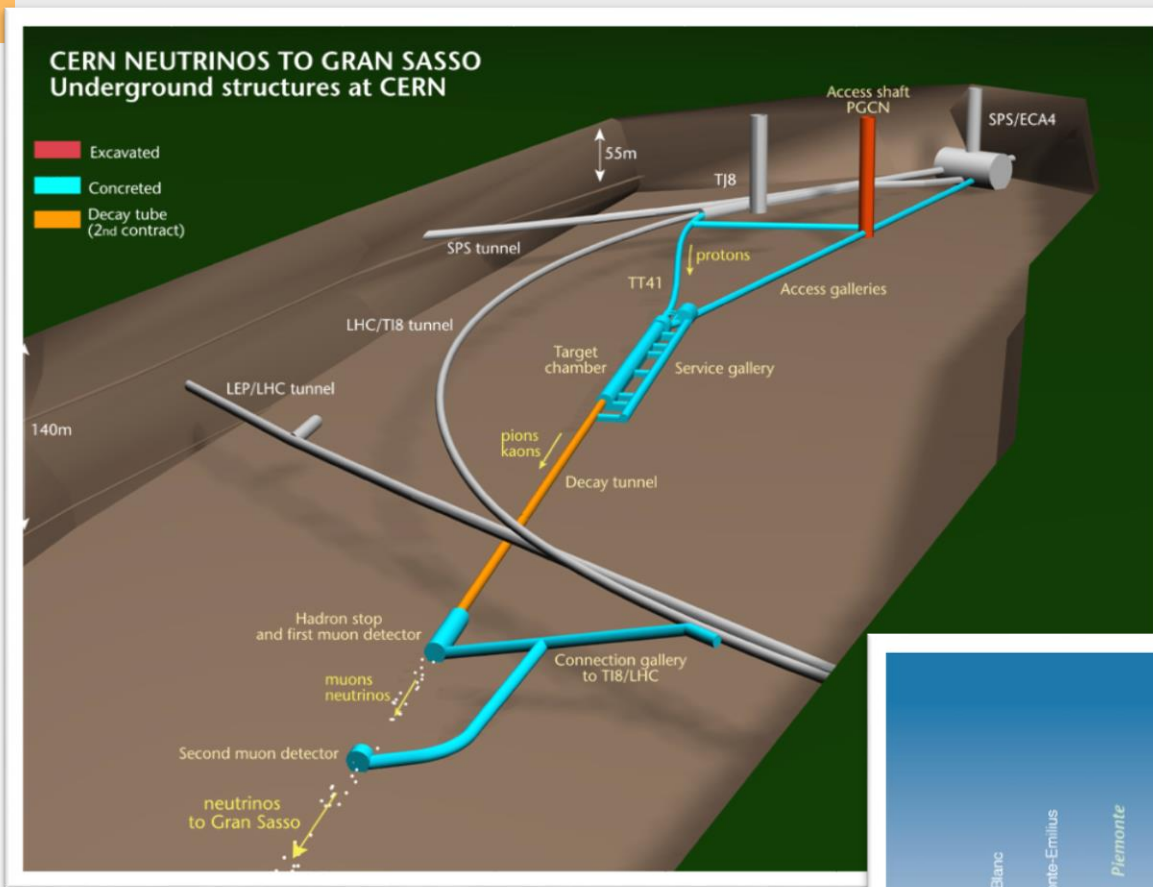

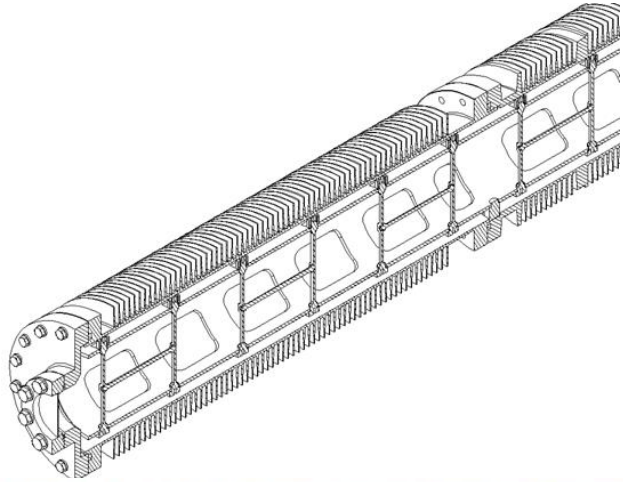

Graphite target, 2 m long
2 large horns
1km decay tunnel

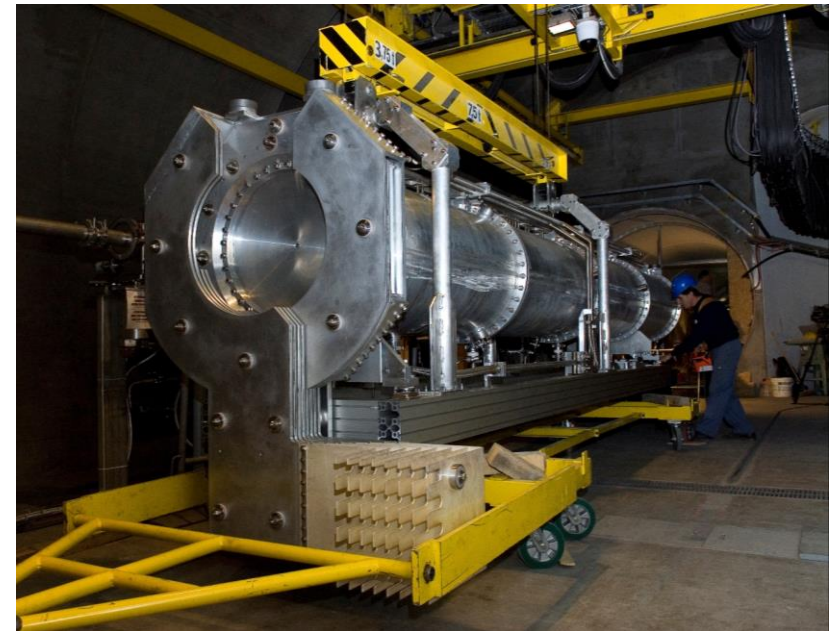

μ S: Swiss Muon Source at PSI

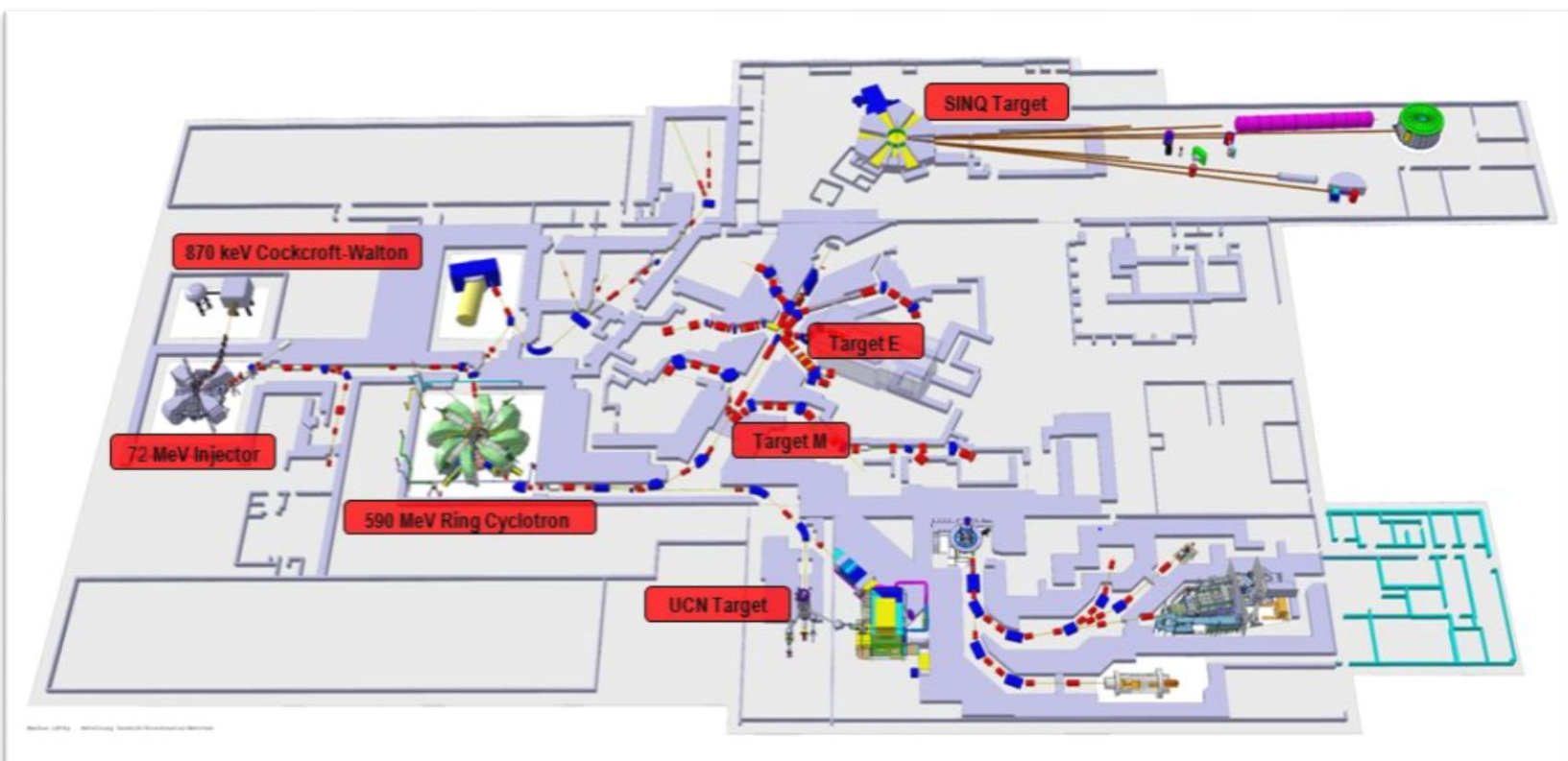
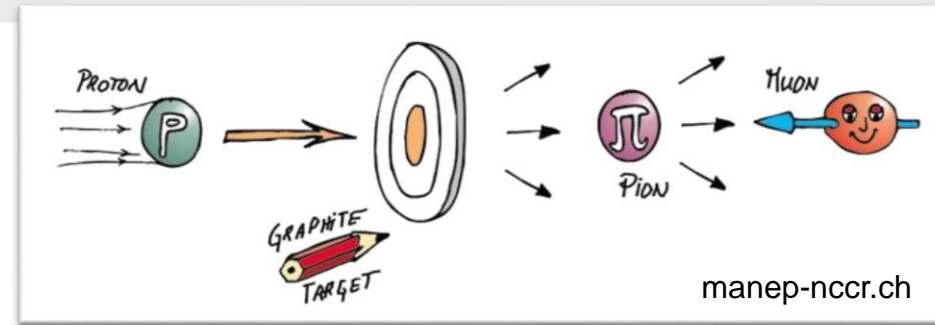

Two established methods...

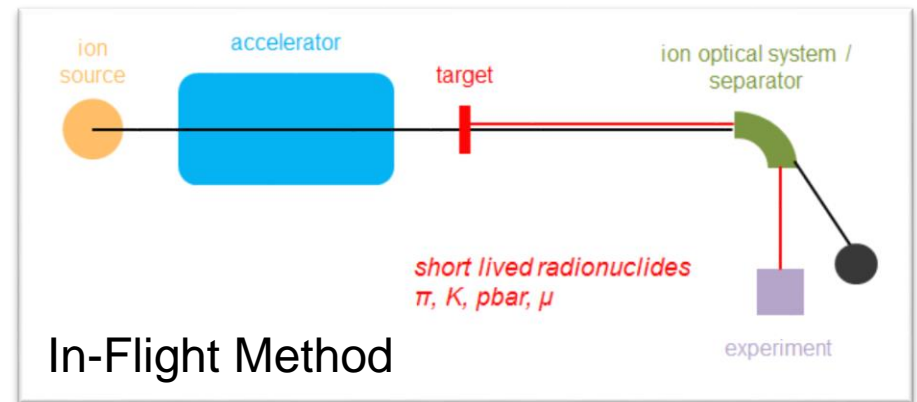
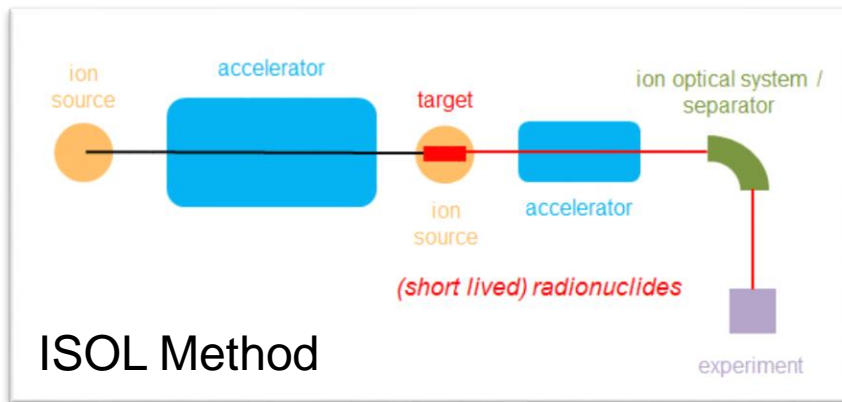

Summary

...increasing intensity request from experiments...

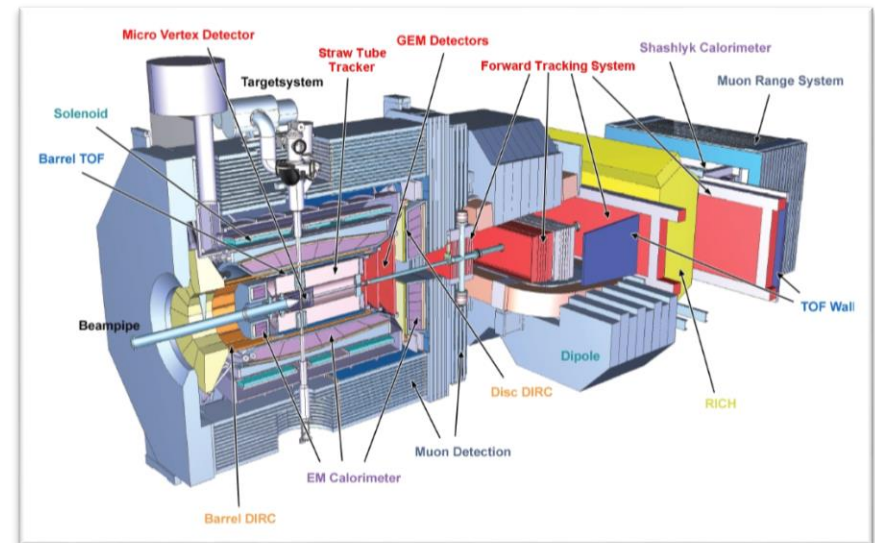
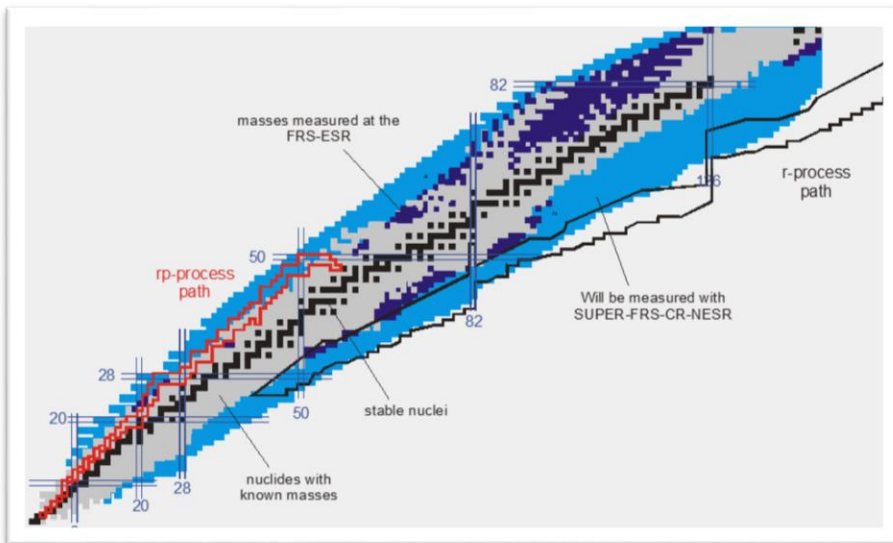

Summary

...new challenges: accelerators, targetry, separators, detectors, Rad. prot. ...

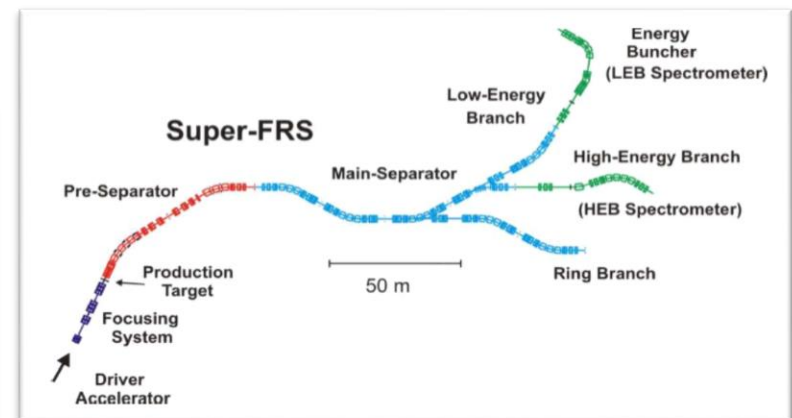
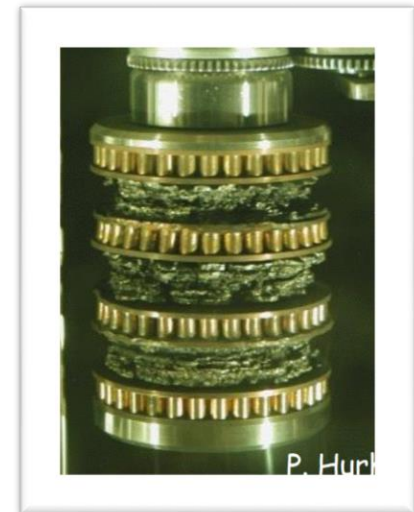
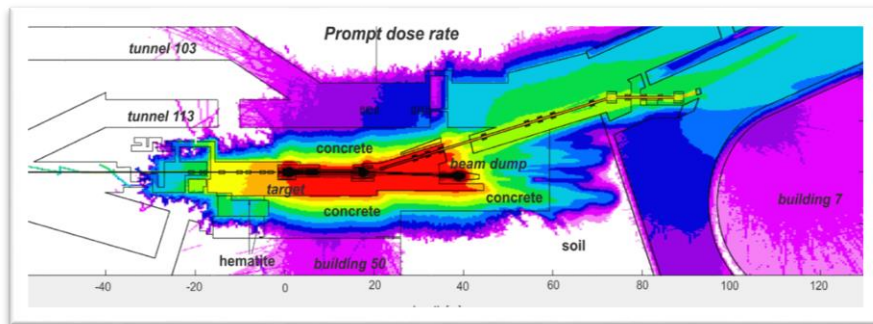

Thank you for your attention!

Facility for Rare Isotope Beams in the world

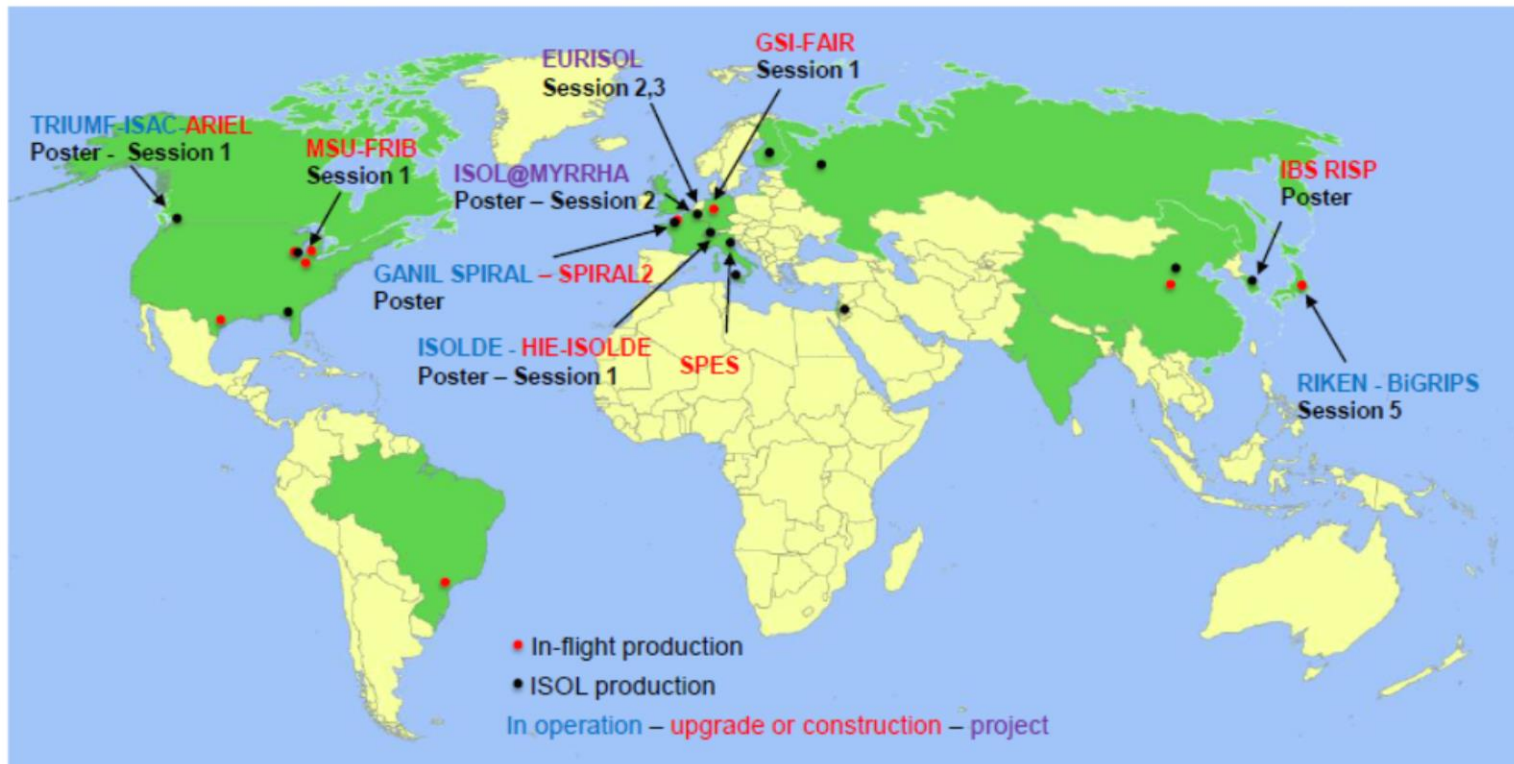

Facility for Rare Isotope Beams
U.S. Department of Energy Office of Science
Michigan State University

F. Pellemoine, HPTW April 2016 - Oxford, Slide 10