

# [553] Development of Slow Control Package for the Electromagnetic Calorimeter Trigger System

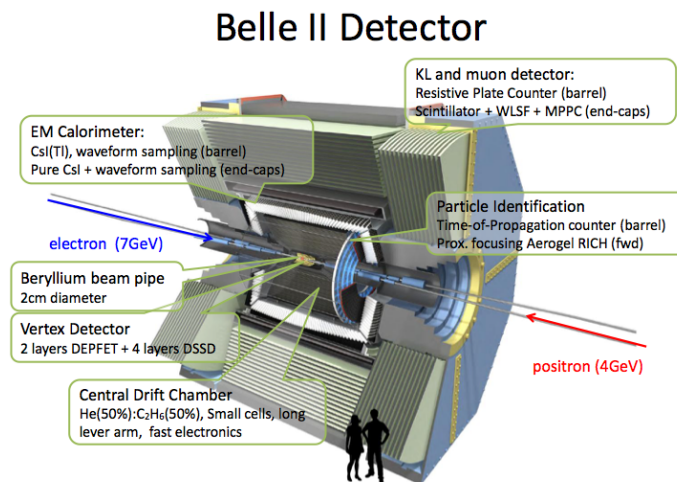

Cheolhun Kim  
Hanyang University  
Korea

**Tsukuba, Japan Belle II Experiment**

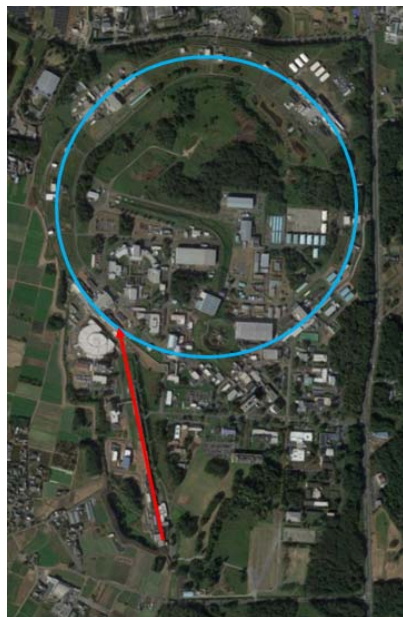
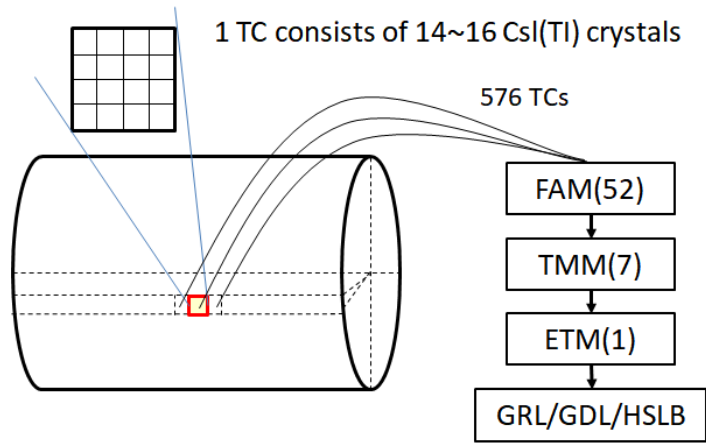

## ECL Trigger System

- 1. User Module Part
- 2. Archiver Part
- 3. Database Part

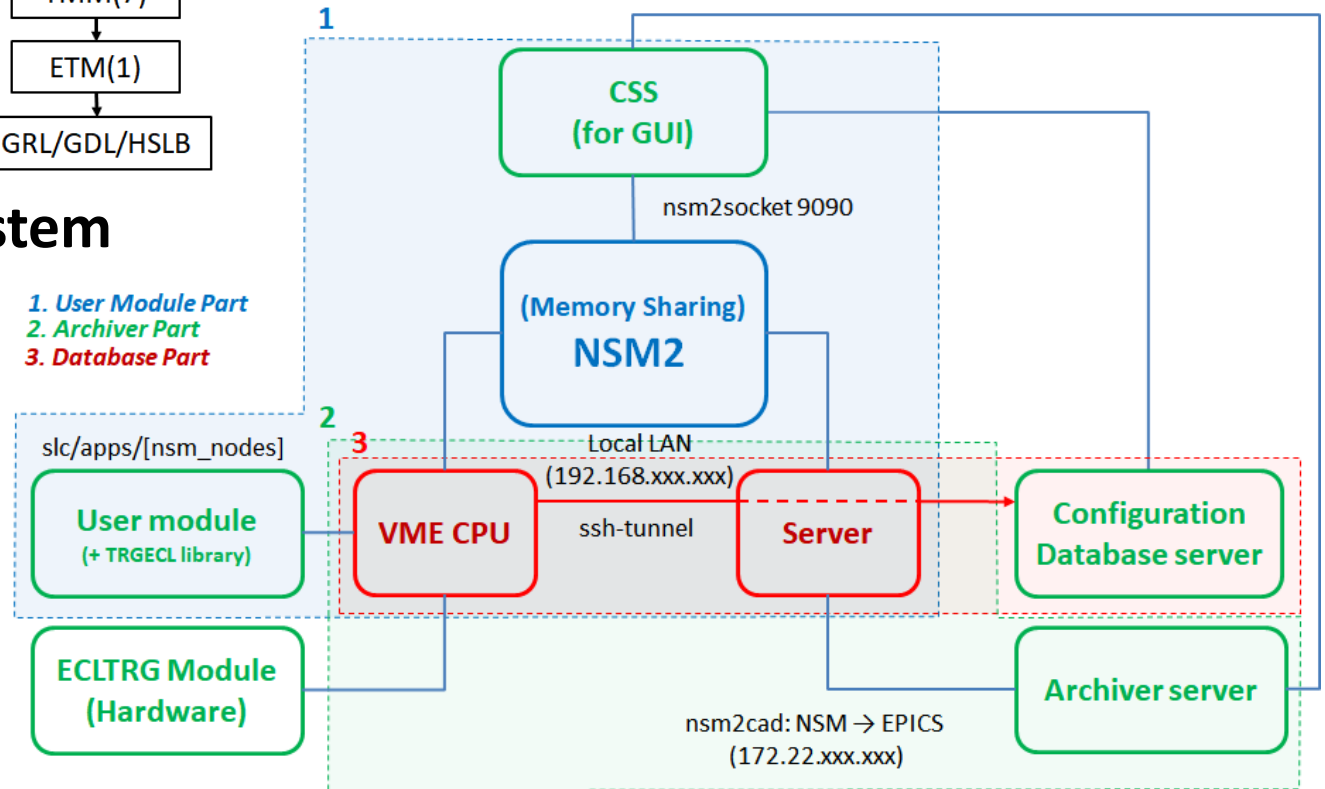

## Schematic of ECL Trigger Slow Control System

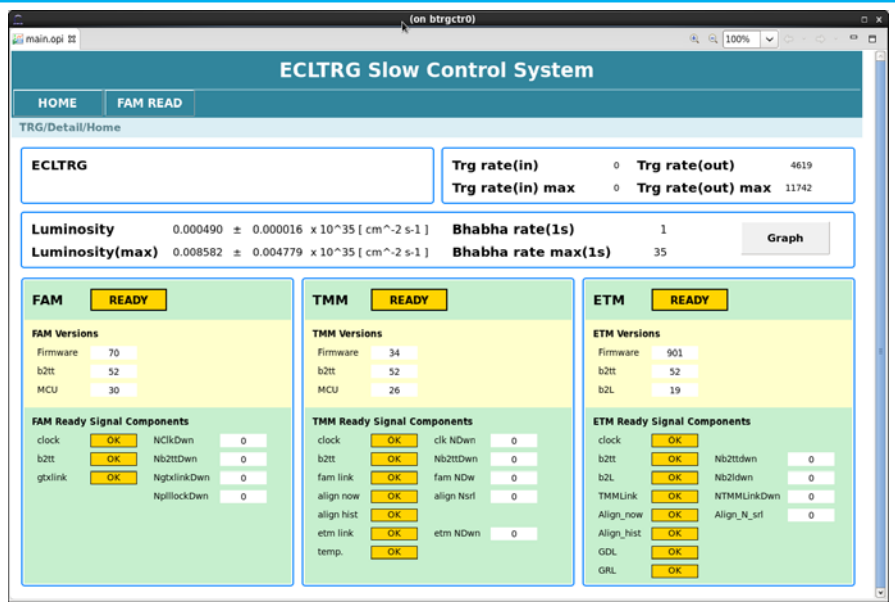

User module

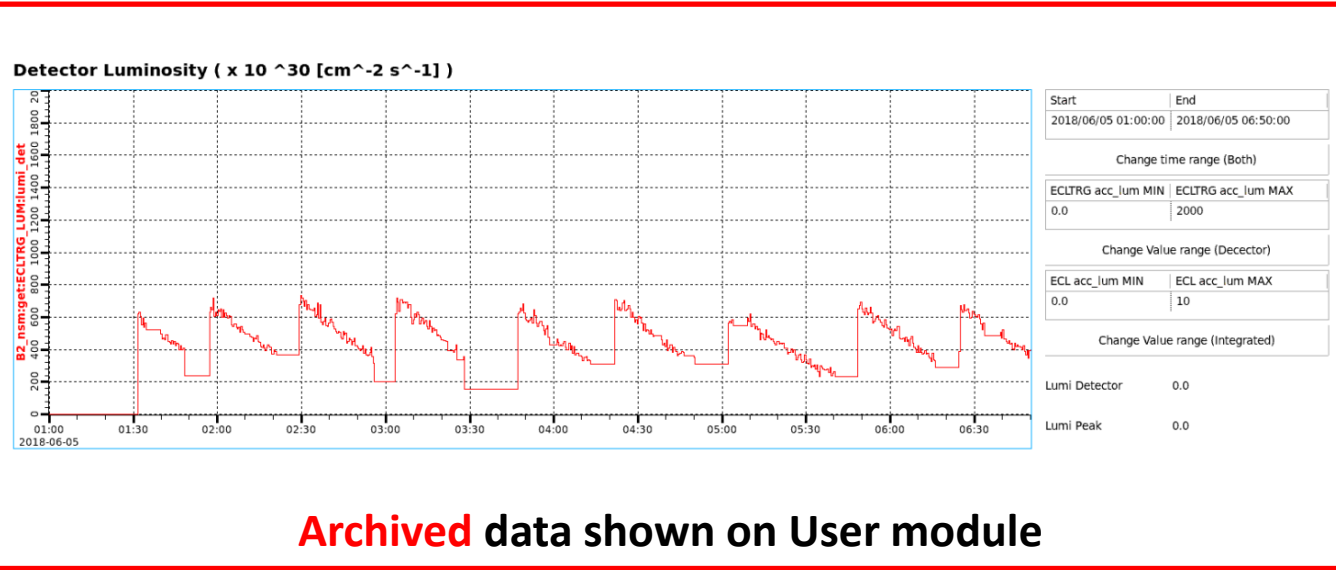
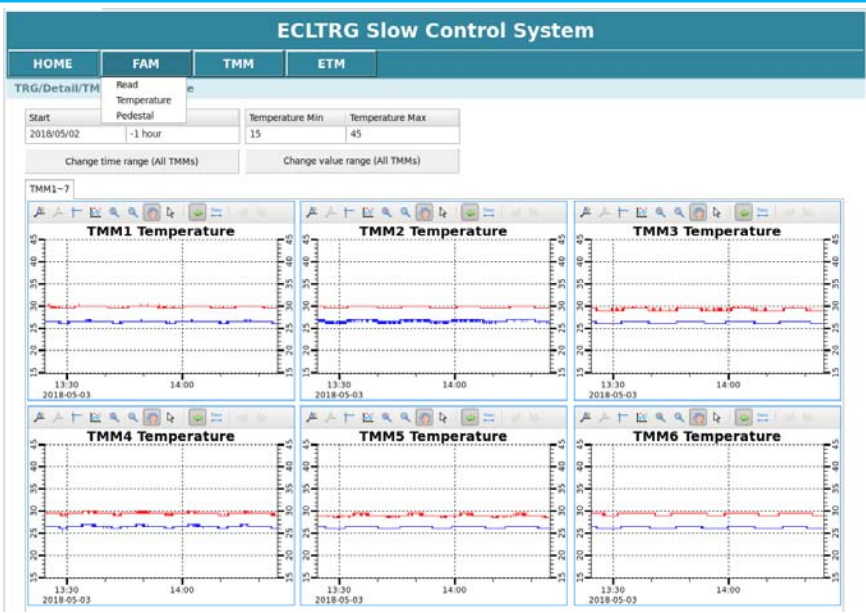

Archived data shown on User module

```
[b2ecltrg@vmecltrg ~/vmeslc] daqdblist trgecl
FAM_TOFF
FAM_TOFF 2325 20180525 073627
FAM_ETHRES 2325 20180525 063457
TRGECL_VER 2325 20180525 073627
TRGECL_VER 2325 20180525 073627
FAM_TOFF 2324 20180525 073336
FAM_ETHRES 2324 20180525 073336
TRGECL_VER 2324 20180525 073336
FAM_TOFF 2323 20180525 063457
FAM_ETHRES 2323 20180525 063457
TRGECL_VER 2323 20180525 063457
FAM_TOFF 2322 20180525 061020
FAM_ETHRES 2322 20180525 061020
TRGECL_VER 2322 20180525 061020
FAM_TOFF 2321 20180525 060249
FAM_ETHRES 2321 20180525 060249
TRGECL_VER 2321 20180525 060249
FAM_TOFF 2320 20180525 052426
FAM_ETHRES 2320 20180525 052426
TRGECL_VER 2320 20180525 052426
FAM_TOFF 2319 20180525 051909
FAM_ETHRES 2319 20180525 051909
TRGECL_VER 2319 20180525 051909
```

Configuration DB