

# Intelligent triggering: pattern recognition with Associative Memories & other tools (FPGAs) - the Fast Tracker example in ATLAS

**Kostas Kordas**  
Aristotle University  
of Thessaloniki

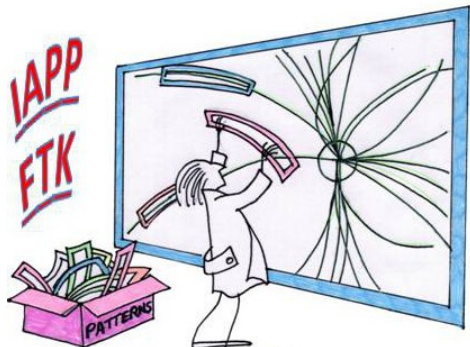

FP7-PEOPLE-2012-IAPP  
Grant No: 324318



ARISTOTLE  
UNIVERSITY OF  
THESSALONIKI

ISOTDAQ2017 , Amsterdam, February 6, 2017

# Overview

- The need for tracking info at the Trigger of High Energy Physics experiments and how to do it fast
- A specific example: the FTK (Fast Tracker) in ATLAS; tracking in two stages:
  - **Pattern matching** with Associative Memories
  - Refined **track fitting** with FPGAs
- Basically you'll see that:
  - \* if you want to avoid or cannot afford calculating something time consuming:
    - split the problem and use pre-calculated patterns and quantities.
- We'll see examples beyond FTK as well

# A. Introduction

# Experiments at the LHC - pp collisions

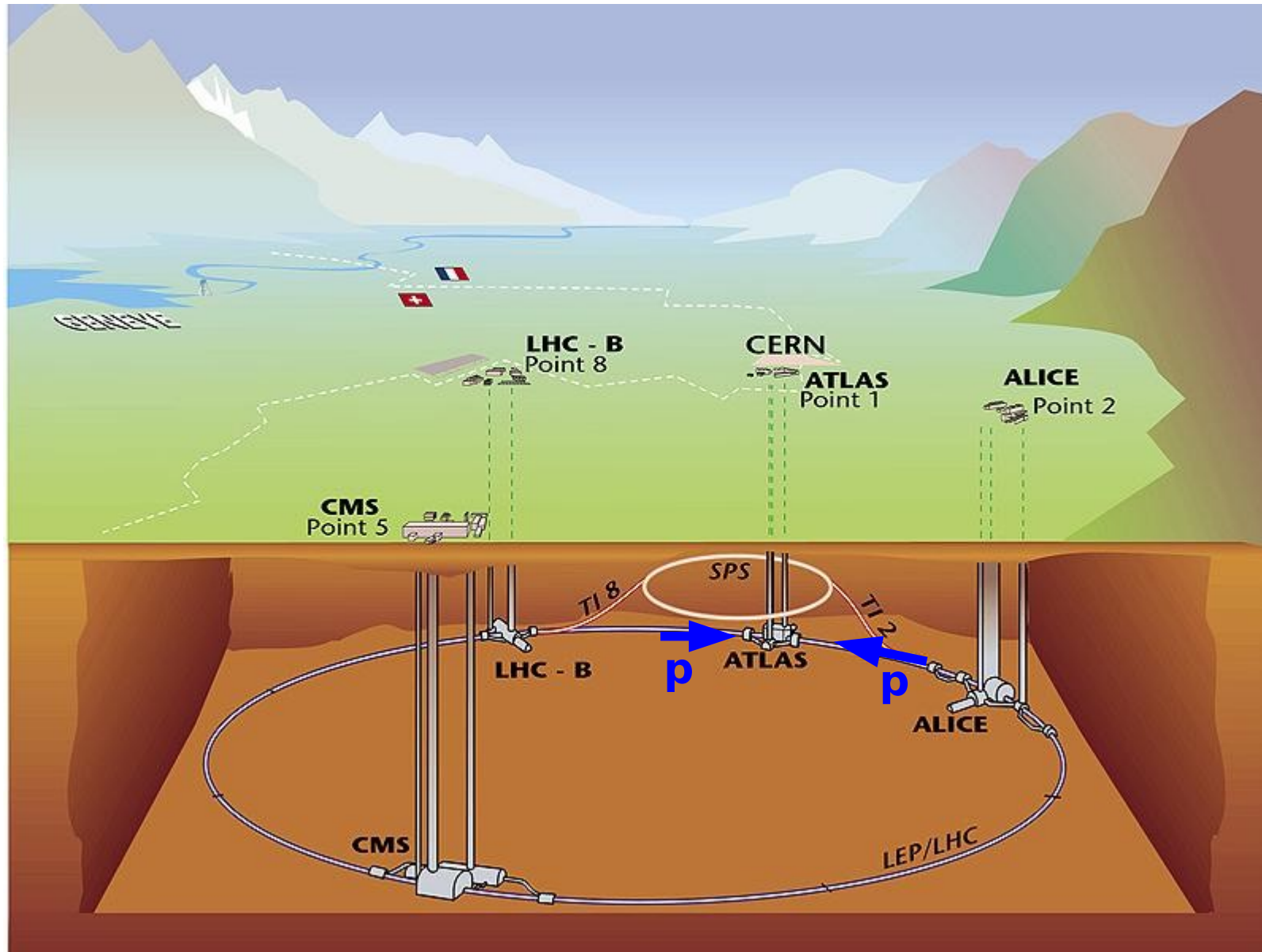

# The energy frontier - interested in **relatively rare processes**

**Probability of interaction ~ cross section:**

In order to have a reasonable number of interesting events produced, we need high luminosity colliders:

**Rate  $\sim L * \sigma$**

***LHC Design:  $L = 10^{34} \text{ cm}^{-2} \text{ s}^{-1}$***

For proton bunch spacing of 25ns: **pb**

***pp interactions/bunch crossing: ~25***

**Luminosity to become 3-5 times more.**

**>10 orders of magnitude!**

**$\sigma$   
~80 mb**

**$\mu\text{b}$**

**nb**

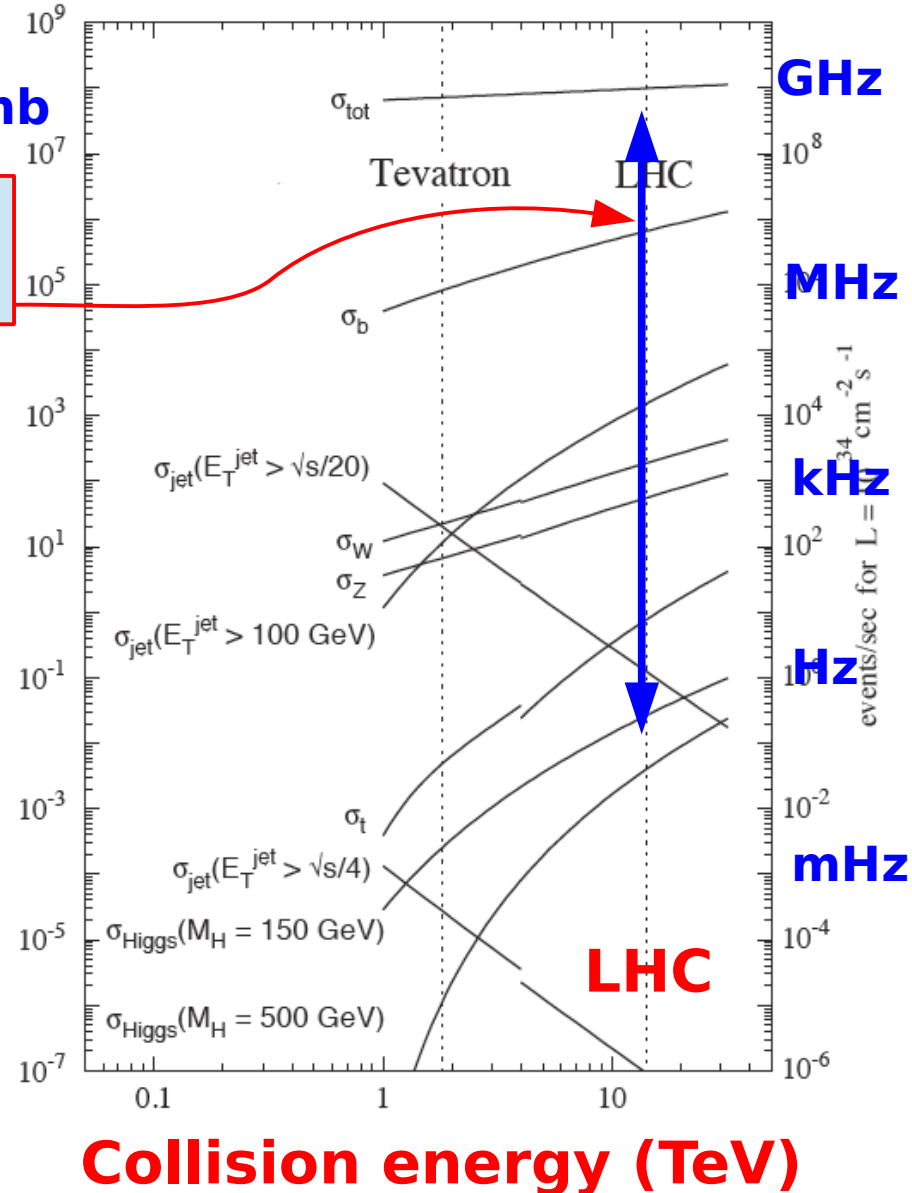

**GHz**

**MHz**

**kHz**

**Hz**

**mHz**

events/sec for  $L = 10^{34} \text{ cm}^{-2} \text{ s}^{-1}$

**LHC**

**Collision energy (TeV)**

# Chinese proverb: A picture (a movie here) is 1000 words

./LHC-event.mov

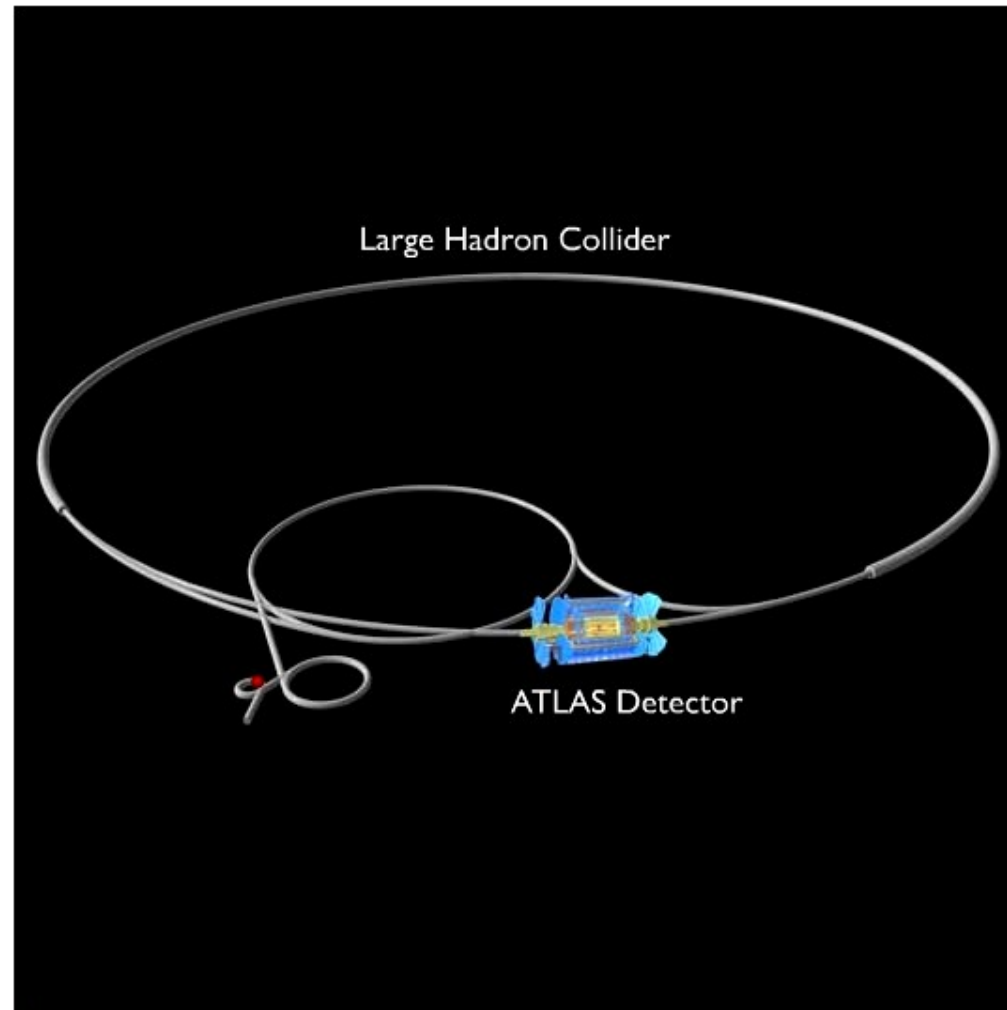



Looking at many & complex events  
every 25ns two proton bunches cross each other  
→ a superposition of  $>25$  pp collisions

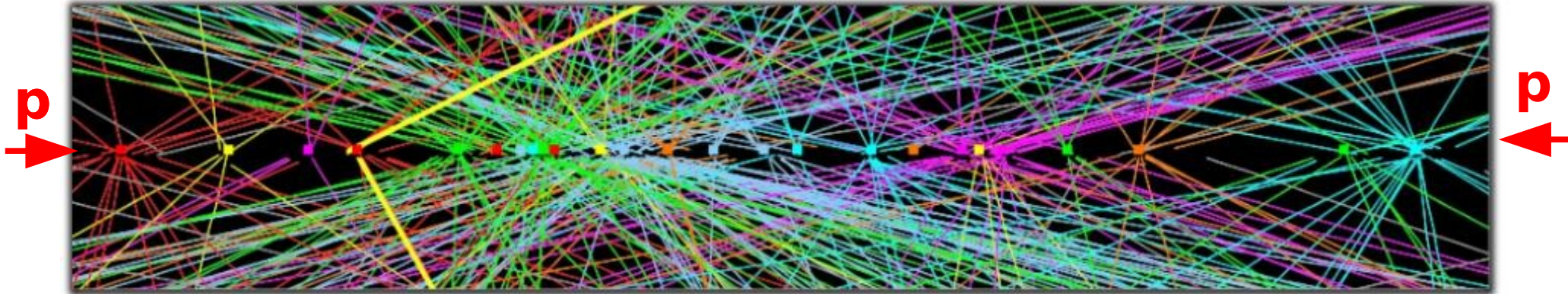

Atlas event with a Z boson decaying to two muons and 24 additional interaction vertices.

The Trigger and Data Acquisition system,

- \* **watches 40M such “events” (bunch crossings) / sec**  
→ O(1) billion pp interactions per second
- \* **select online “the most interesting” O(1k) events/sec**  
(1 : 1 Million pp interactions deemed interesting enough to keep)
- \* **and log them for offline use with a resolution of a  
~100 Mpixel camera (100M channels: total ~1.5 MB/event)**

# Trigger at 2 stages:

Level1 (L1: fast, no detailed info) &

High Level Trigger (HLT: slower, using detailed info)

- Trigger & DAQ : Select events and get the data from the detector to the computing center for the first processing.

**Permanent storage**

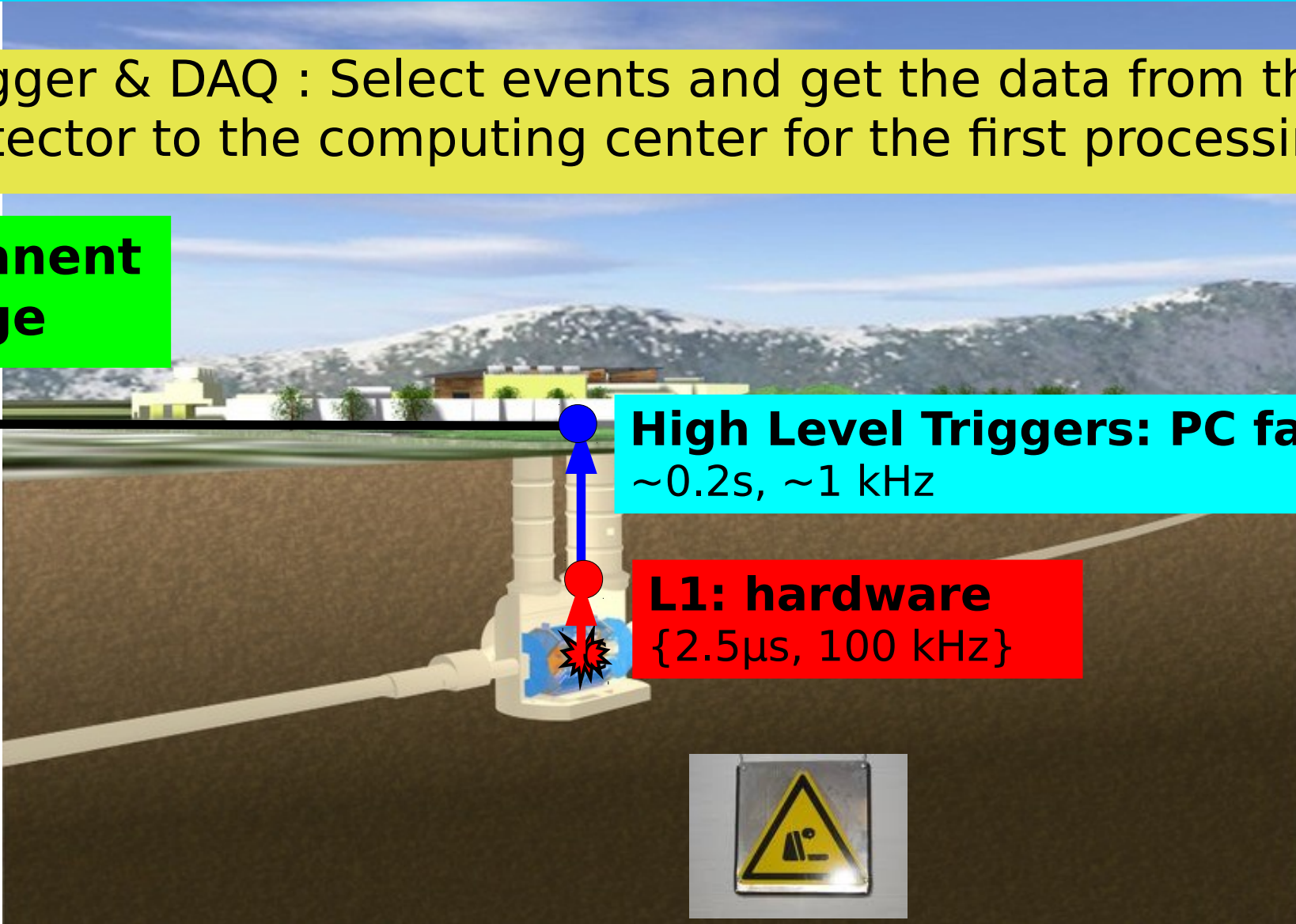
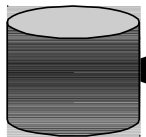

**High Level Triggers: PC farms**

$\sim 0.2s, \sim 1 \text{ kHz}$

**L1: hardware**

$\{2.5\mu s, 100 \text{ kHz}\}$





# Example: Looking for Higgs

- **How do we see the Higgs?**

→ **from its children!**

E.g., 4 muons traversing  
the detector (red lines here)

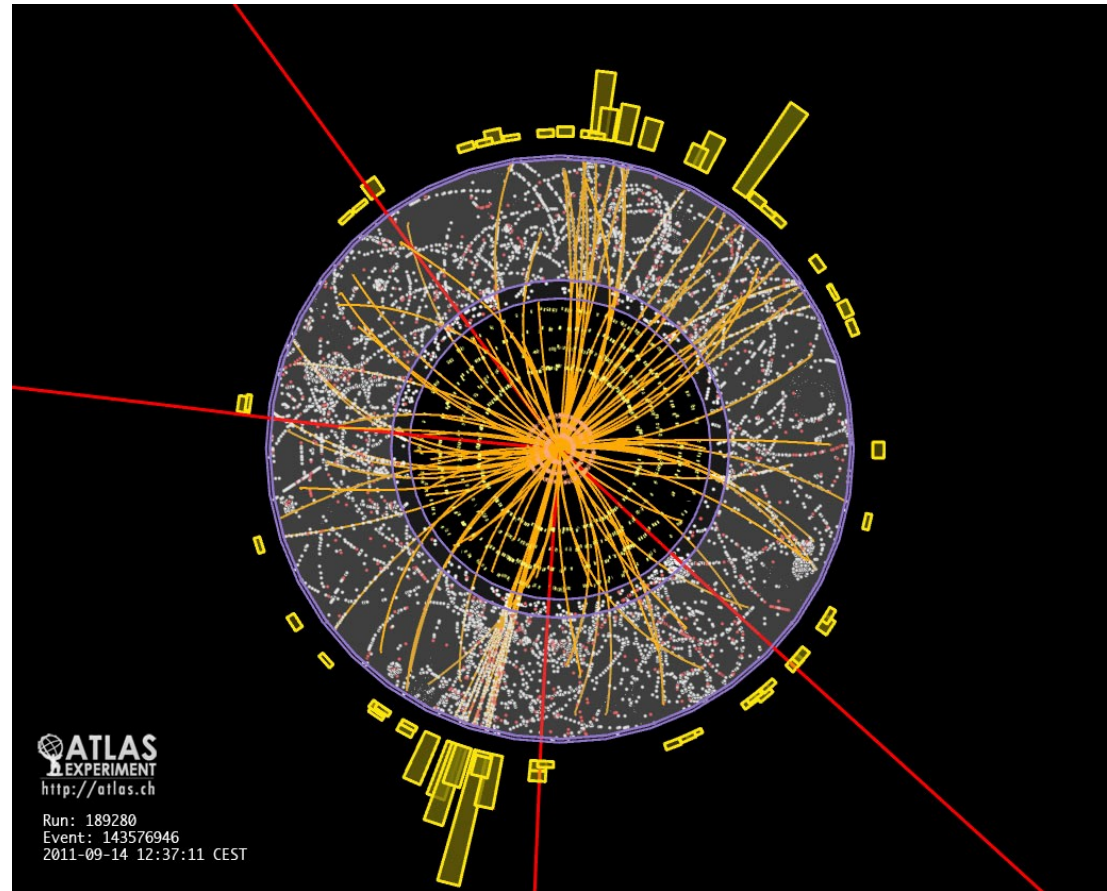

$$E = mc^2 \rightarrow E^2 = m^2 c^4 + p^2 c^2 \rightarrow E^2 = m^2 + p^2 \rightarrow m = \sqrt{(E^2 - p^2)}$$

# Selection of the right events is essential (and selection of many of them too!) e.g., ATLAS: $H \rightarrow ZZ \rightarrow 4l$

[./4l-FixedScale-NoMuProf2\\_400x300.gif](#)

[./4l-FixedScale-NoMuProf2\\_238x231.gif](#)

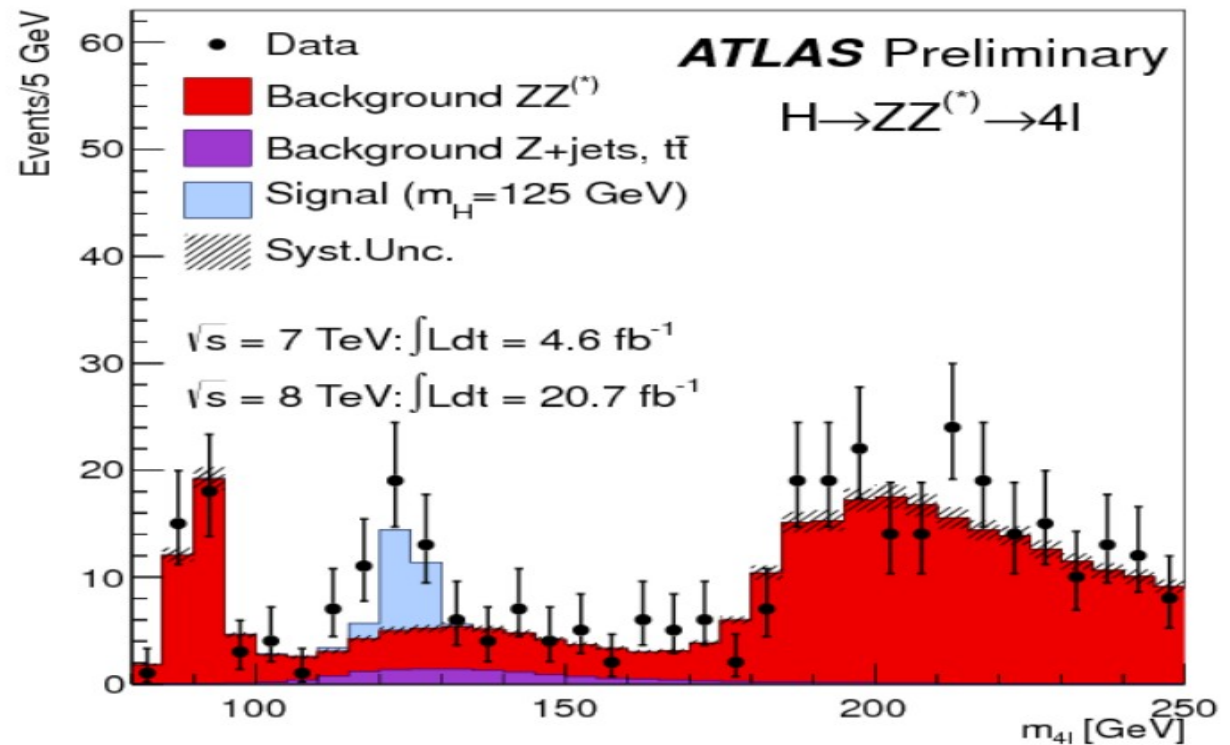

<https://twiki.cern.ch/twiki/pub/AtlasPublic/HiggsPublicResults//4l-FixedScale-NoMuProf2.gif>

The more you know about the events, the easiest you select the “signal” and reject the “background”

When there is limited time budget (L1 trigger): decide based only on the muon and calorimeter systems

But may need information from the inner tracker as early as possible to make an “educated” decision and keep as much signal as possible

e.g., 2 “jets” of tracks, which are usually boring, they could actually be

$$H \rightarrow b \bar{b} \quad \text{or} \quad H \rightarrow \tau^+ \tau^-$$

# Each charged particle leaves a trace (“a track”) in the detector as it moves outwards



Atlas event with a Z boson decaying to two muons and 24 additional interaction vertices.

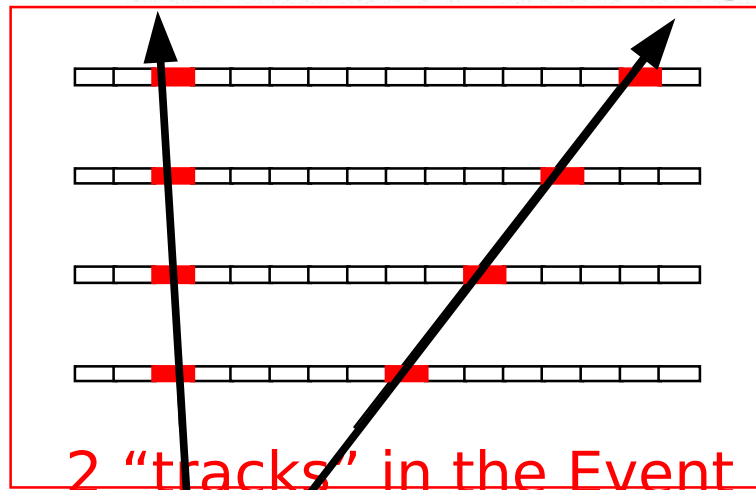

**2 “real tracks”**

- Connecting the “hit” readout cells from one detection layer to the other
- traces the charged particle's path as it moves radially outward and its' position is measured in each detector layer



# You have also noise and irrelevant hits on the same “event”/“picture”

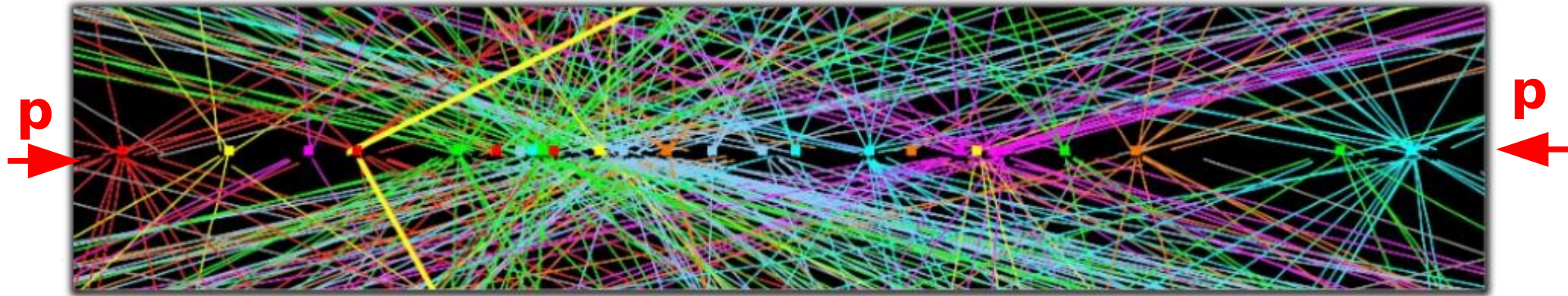

Atlas event with a Z boson decaying to two muons and 24 additional interaction vertices.

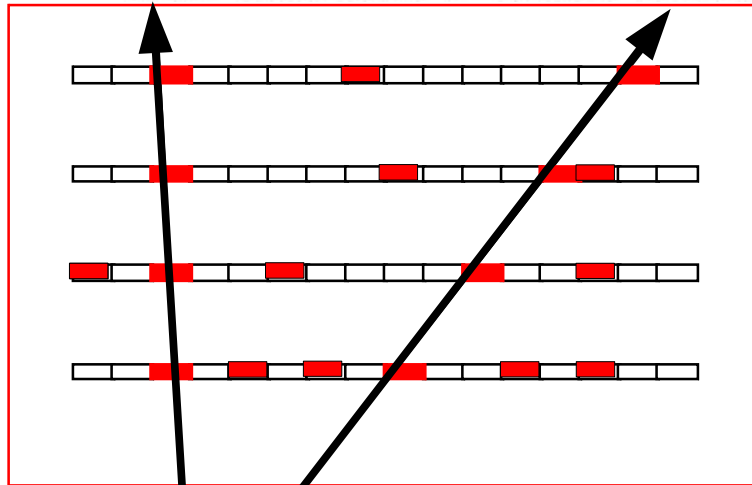

**2 “real tracks” + extra hits**



# Tracking is a combinatorics problem: which combinations of hits fit track hypothesis?

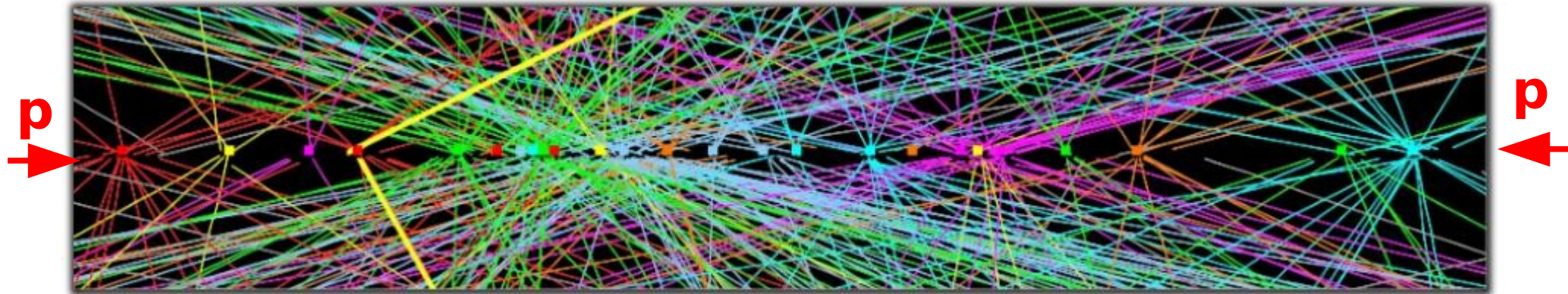

Atlas event with a Z boson decaying to two muons and 24 additional interaction vertices.

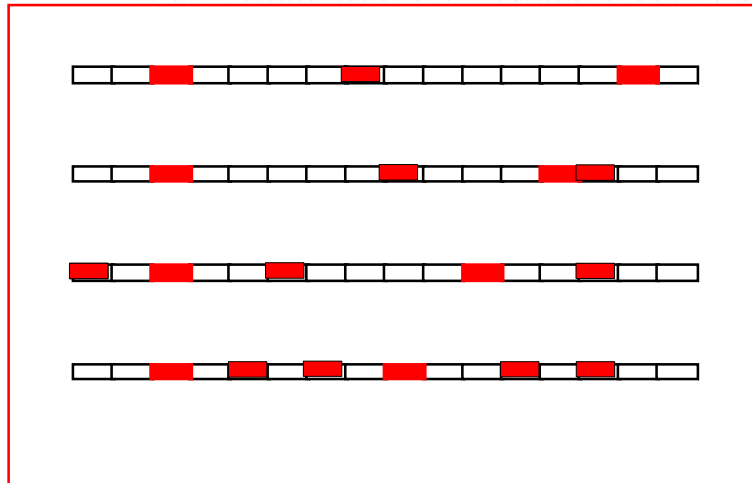

But when you look  
at this event/picture,  
**you just see hits!**

You have to find the tracks...

→ Lots of hit combinations to try

→ a huge combinatorics problem

→ becoming worse and worse  
as luminosity increases

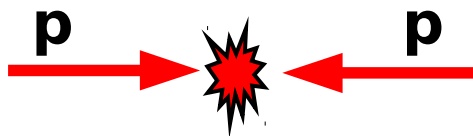

## B. The Fast Tacker (FTK) solution in ATLAS

# FTK (Fast Tracker): dedicated hardware helping the HLT, by doing the tracking before the HLT

**Permanent  
storage**

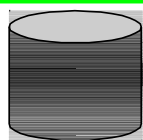

FTK

**High Level Triggers: PC farms**  
~0.2s, ~1 kHz

**L1: hardware**  
{2.5 $\mu$ s, 100 kHz}

## **Fast Tracker (FTK)**

For each event accepted by L1  
(100kHz),  
find all its tracks in <100  $\mu$ sec  
→ x1000 faster than the HLT farm  
of PCs





# FTK: Tracking particles in the Silicon Detectors

**ATLAS' Fast Tracker (FTK)** processes all Level-1 accepted events (100kHz)  
Output: all tracks w/  $p_T > 1$  GeV available to HLT. **Typical FTK latency  $\sim 100\mu\text{s}$** , compared to  **$O(50\text{ms})$  HLT**

Advantages: high-bandwidth connection with detector & HW optimized for the specific tasks

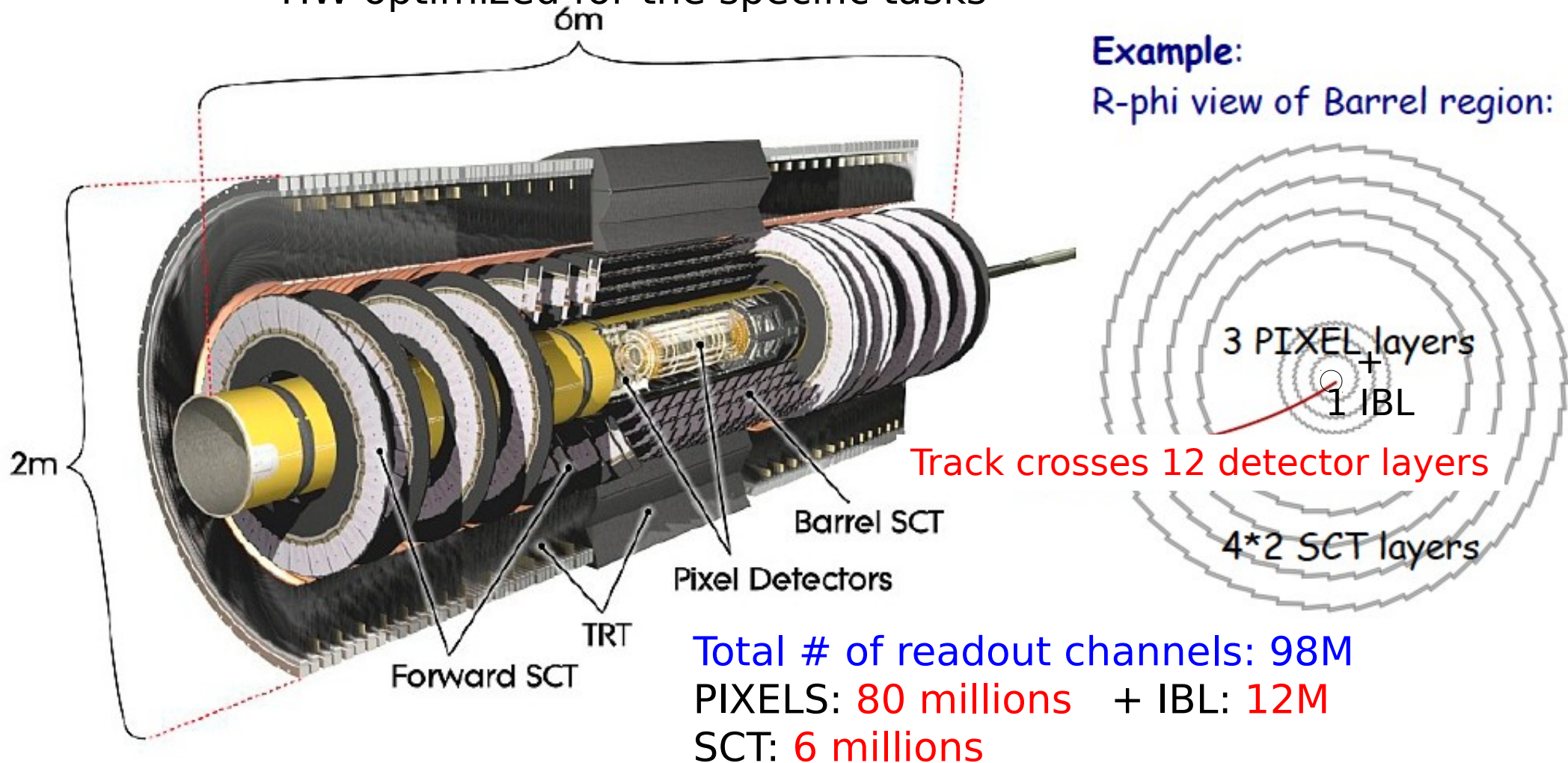

# From hits to tracks ready for the HLT in $< 100 \mu\text{s}$

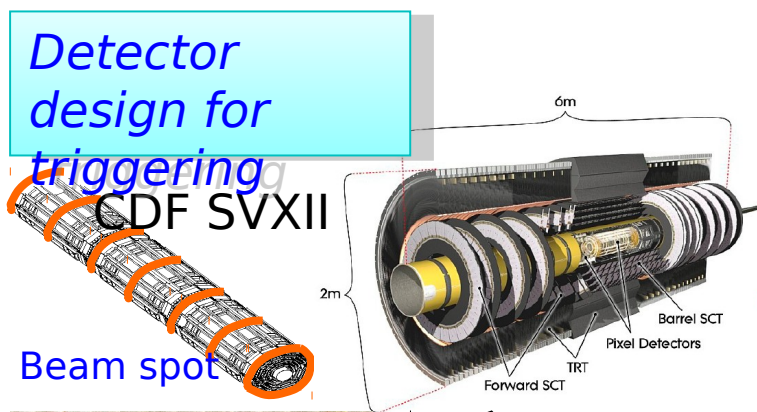

For L2: SVT trigger at CDF  
For L2: FTK in ATLAS  
For L1? : CMS & ATLAS

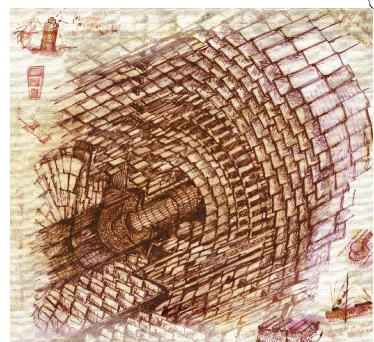

Data transfer

1. Data formatting & clustering

1. Here **FPGAs** cluster hits with sliding window and get their centroid as the hit position. Forward the data to proper Processing Units

2. Processing Units (PUs) made of these two steps

Each PU, takes care of a given detector slice (“ $\eta$ - $\phi$  tower”)  
In FTK: 64 towers

2a. Pattern Recognition

**Associative Memories**

2b. Track Fitting

**FPGAs**

HLT



# 1. Input & Data “Formatting”:

cluster adjacent hits,  
find the position of each cluster,  
forward them to the Processing Unit  
responsible for this geometrical  $\eta$ - $\phi$  region  
(64  $\eta$ - $\phi$  towers)

FPGA replica of pixel matrix

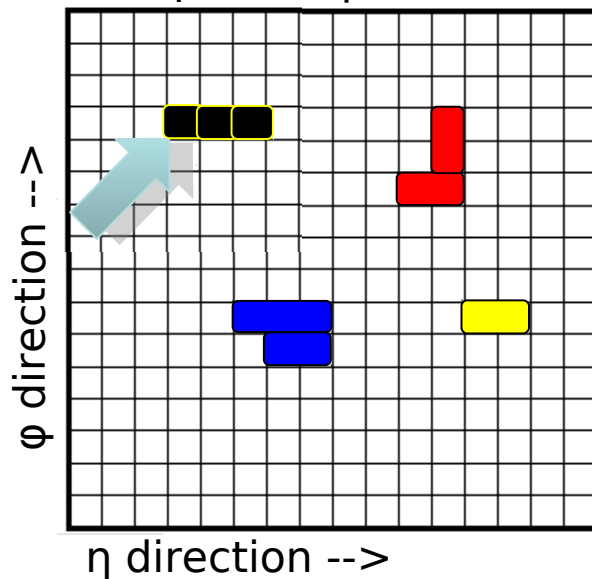

Significant **data reduction**  
by using hereafter only the  
position of each cluster

# Detail: Clustering algorithm how-to

NIM A617:254-257,2010

IEEE TNS, vol. 61, no.6, pp.3599-3606, 2014

doi: 10.1109/TNS.2014.2364183

FPGA replica of pixel matrix

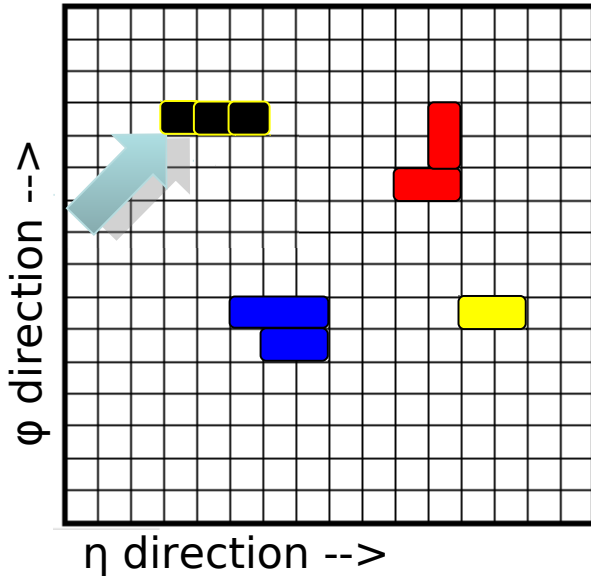

## 1<sup>st</sup> phase:

- Pixel module: a 328x144 matrix.
- Replicate a part of it (8x164) in hw matrix.
- Matrix identifies hits in the same “cluster” (= adjacent pixels)

## 2<sup>nd</sup> phase:

- Hits in cluster analyzed (averaged) to get “the hit position”, used in all next steps
- Flexibility to choose algorithm!

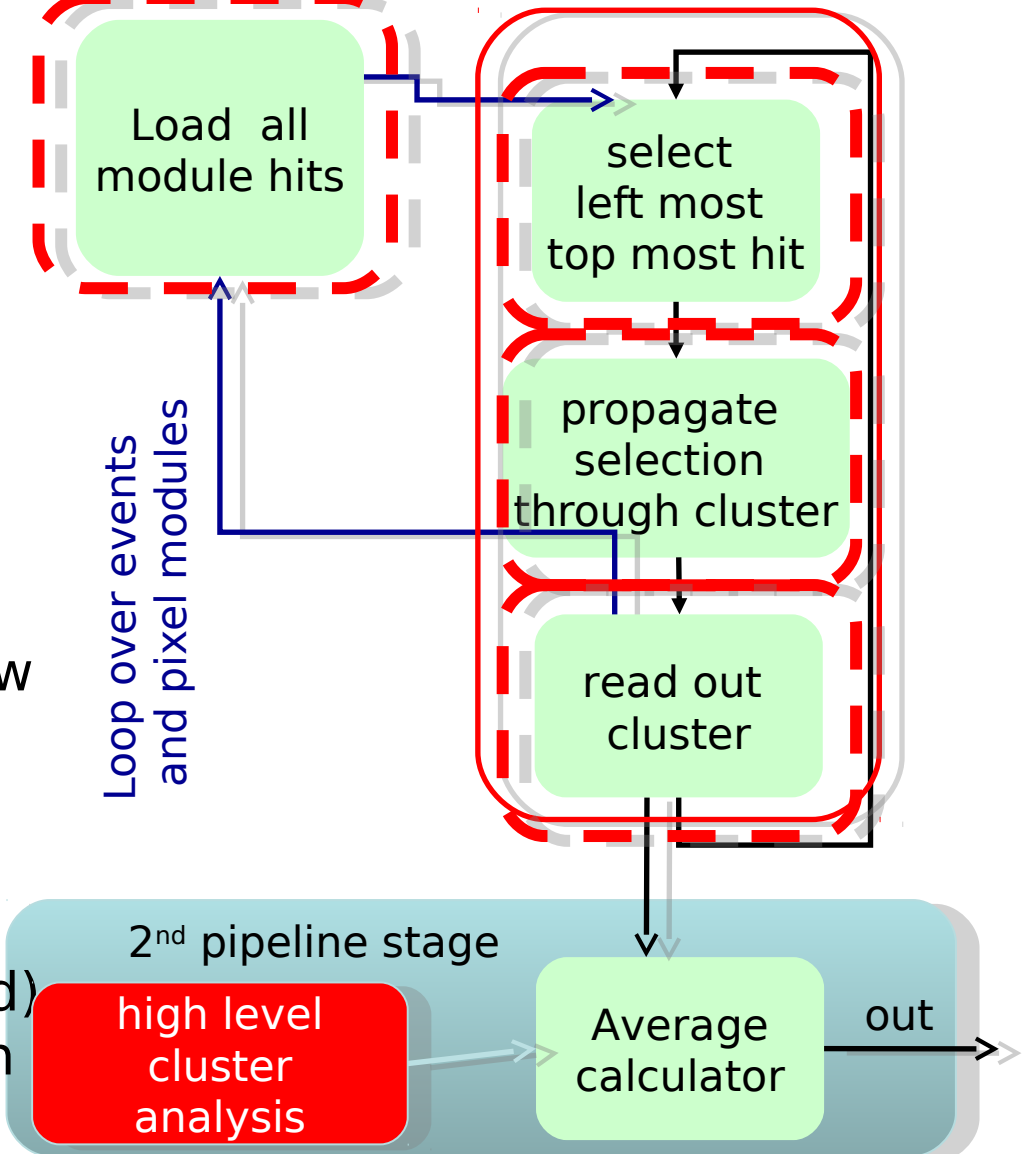

## 2. Processing Unit: tracking in 2 steps (see analogy to the Trigger doing L1 & HLT)

1. Find low resolution track candidates called “roads”. Solve most of the combinatorial problem.

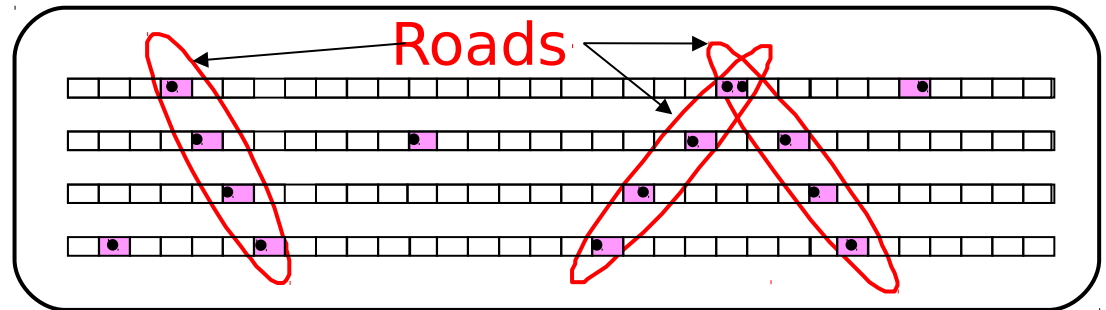

Pattern recognition w/ Associative Memory

Originally:

M. Dell’Orso, L. Ristori, NIM A 278, 436 (1989)

2. Then track fitting inside the roads. Thanks to 1st step, this is much easier.

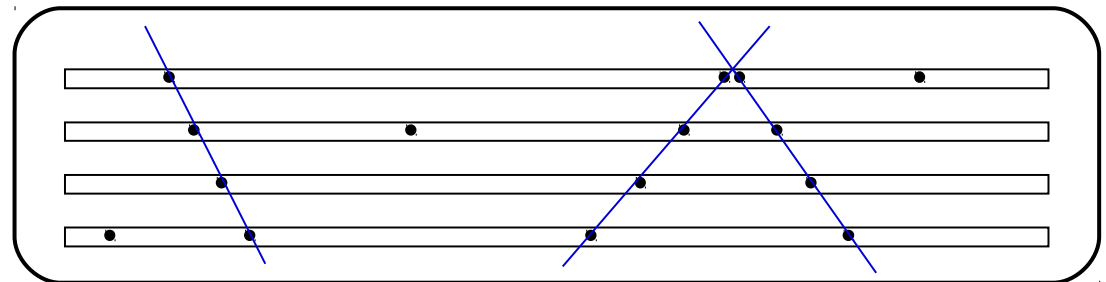

[http://www.pi.infn.it/~orso/ftk/IEEECNF2007\\_2115.pdf](http://www.pi.infn.it/~orso/ftk/IEEECNF2007_2115.pdf)

Excellent results with linear approximation!

**2a.**

**The coarse pattern matching first**

Using 8 out of the 12 silicon layers

# The detector's finite resolution makes it “binned” → finite number of “hit patterns”

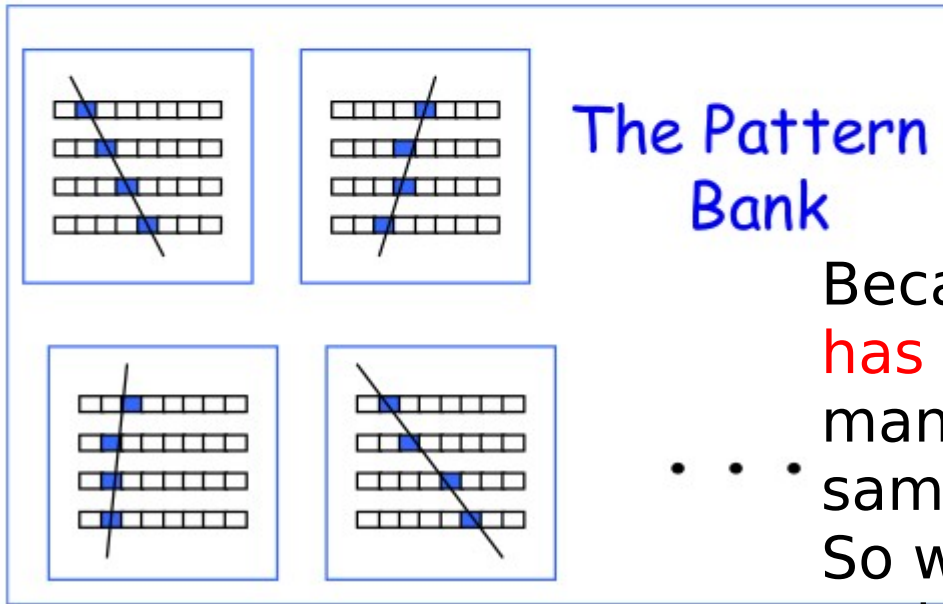
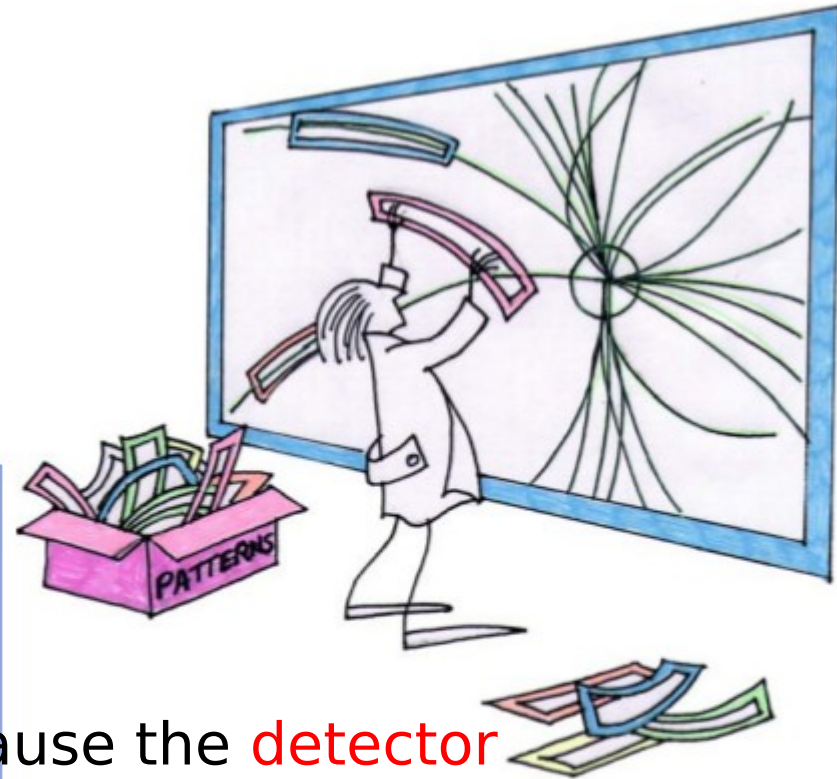
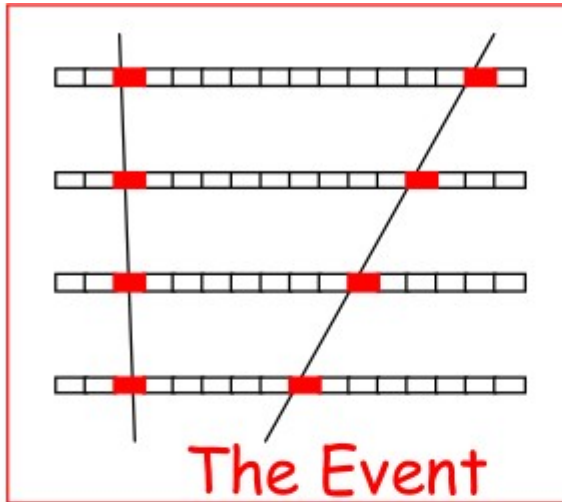

Because the **detector has a finite resolution (“bin size”)**, many different tracks generate the same hit pattern, So we have a finite number of patterns and a **finite-size pattern-bank**.



# Training: simulated tracks to find possible patterns

Pattern #1:

06 06 07 07

**1.**

Each possible track becomes a **“pattern”**

=

a series of numbers: one coordinate for each detector layer

Pattern #0:

11 12 14 15

**Pattern Bank:**

Patt0 11 12 14 15

Patt1 06 06 07 07

Patt2 15 17 18 20

Pattern #2:

15 17 18 20

**2.**

All patterns are stored in a **“pattern bank”**

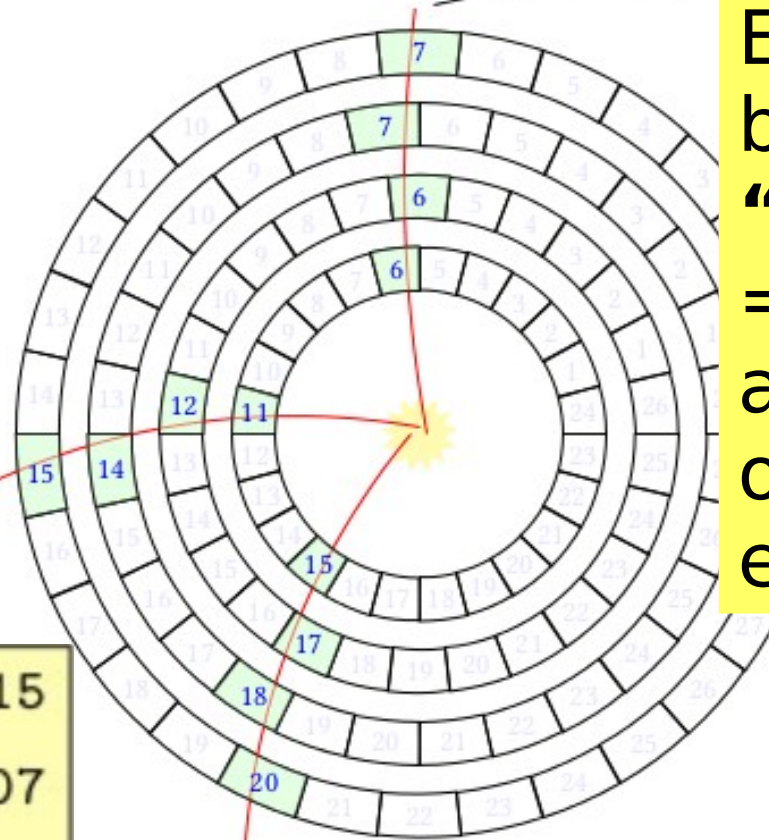

# Coarse track finding = pattern matching: does your event contain any of these patterns?

## Pattern Bank:

<u>Patt0</u>	11	12	14	15
<u>Patt1</u>	06	06	07	07
<u>Patt2</u>	15	17	18	20

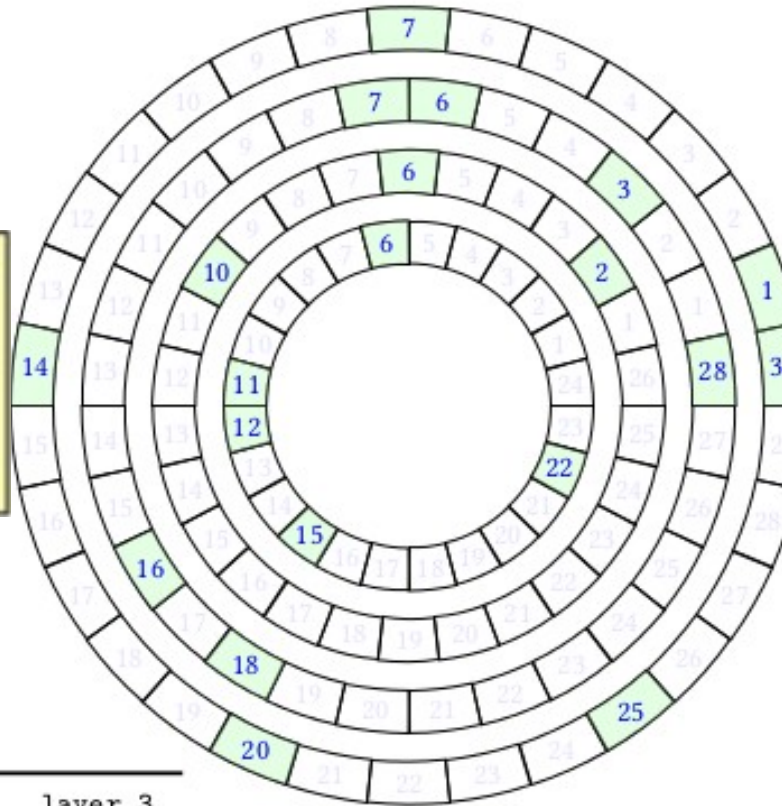

### 3.

Compare the hits in your event with the stored patterns

The "event"

layer 0	layer 1	layer 2	layer 3
6	2	3	1
11	6	6	7
12	10	7	14
15		16	20
22		18	25
		28	30

The "event" is a list of hits in each detector **layer**

Compare ALL the hits in each event with ALL the stored patterns.

**Pattern Bank:**

<u>Patt0</u>	11	12	14	15
<u>Patt1</u>	06	06	07	07
<u>Patt2</u>	15	17	18	20

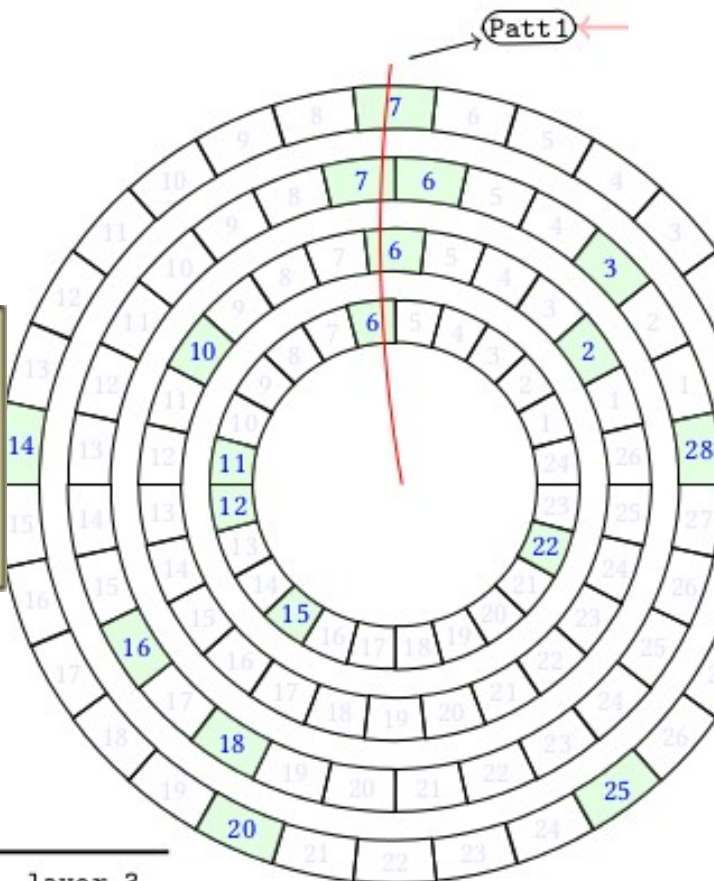

**4.** After all comparisons are done, we have the **list of matched patterns** in the event = the **list of "roads"** to perform refined tracking after

**The event**

	layer 0	layer 1	layer 2	layer 3
	6	2	3	1
	11	6	6	7
	12	10	7	14
	...			

# How to match data to patterns?

## Pattern Bank:

<u>Patt0</u>	11	12	14	15
<u>Patt1</u>	06	06	07	07
<u>Patt2</u>	15	17	18	20

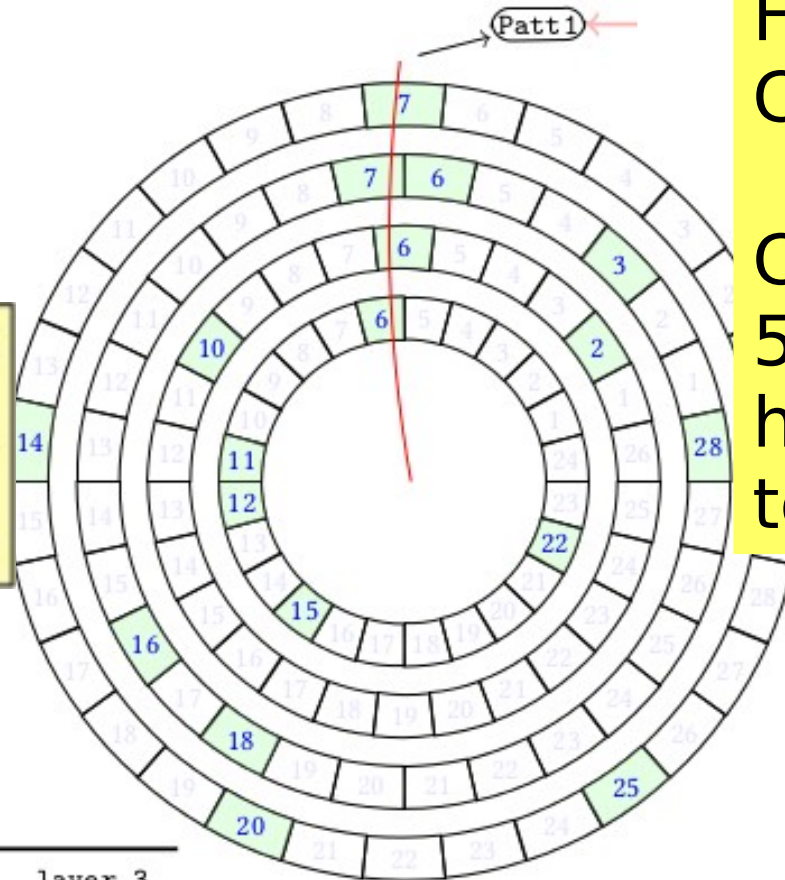

How to do the Comparison?

Check each of the  $5 \times 3 \times 6 \times 6 = 540$  hit combinations to each pattern?

The event

layer 0	layer 1	layer 2	layer 3
6	2	3	1
11	6	6	7
12	10	7	14
15		16	20
22		18	25
		28	30



# Number of patterns in your bank gets big easily

$N_p$  = number of **straight lines** crossing the detector layers

$m$  = # of layers

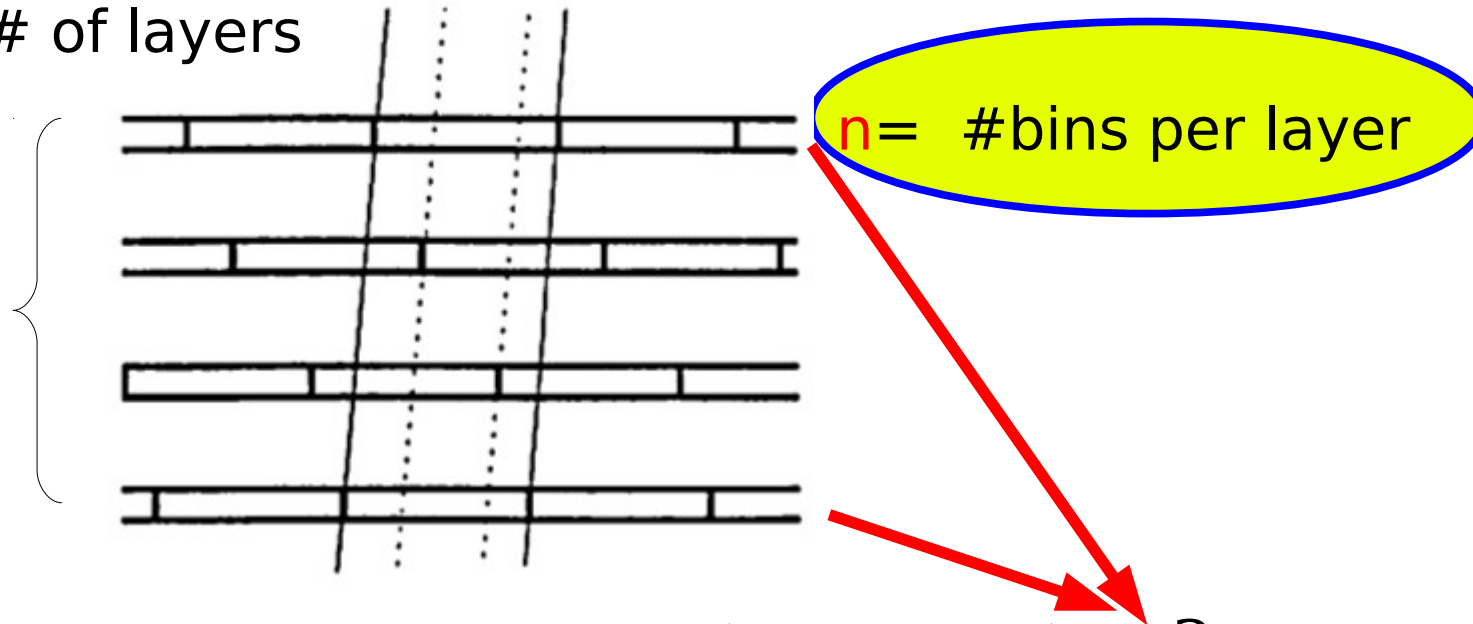

$$N_p \simeq (m-1) n^2$$

Can convince yourselves about this, with  $m=4$  in the above drawing

For a detector with 8 layers, with 1M channels/layer,  $N_p = 7 \cdot 10^{12}$  !!!

( Re-bining with 2-channels per bin:  $n \rightarrow n/2$  means  $N_p \rightarrow \frac{1}{4} N_p$  )



# $N_{\text{patterns}}$ and search time are critical

- Need a lot of memory for the patterns:
  - OK, can use larger (“coarser”) bins for 1st pattern matching (will come back to this later).
- But still, **you have to match hits with patterns fast:**
  - **Linear search**, of the pattern-table (“brute force”) is the slowest.
  - If list of patterns is ordered, can do **“binary” search**:
    - Pick the middle element in the list,
    - Compare the data to the pattern to find the good half of the list,
    - pick the middle of the new (halved) list, and so on.

Example: The list to be searched: L = 1 3 4 6 8 9 11. The value to be found: X = 4.

Compare X to 6. X is smaller. Repeat with L = 1 3 4.

Compare X to 3. X is bigger. Repeat with L = 4.

Compare X to 4. They are equal. We're done, we found X.

**Speed is extremely important at triggering.**

Find tracks at ultimate speed  
→ use **“Associative Memories”**

Ultimate speed for pattern matching:  
do it during the I/O, as the data go through  
the system → no “processing time”

# Associative Memory in a VLSI

436

Nuclear Instruments and Methods in Physics Research A278 (1989) 436-440  
North-Holland, Amsterdam

October 24, 1988

## VLSI STRUCTURES FOR TRACK FINDING

Mauro DELL'ORSO

Dipartimento di Fisica, Università di Pisa, Piazza Torricelli 2, 56100 Pisa, Italy

Luciano RISTORI

INFN Sezione di Pisa, Via Vecchia Livornese 582a, 56010 S. Piero a Grado (PI), Italy

Received 24 October 1988

We discuss the architecture of a device based on the concept of *associative memory* designed to solve the track finding problem, typical of high energy physics experiments, in a time span of a few microseconds even for very high multiplicity events. This "machine" is implemented as a large array of custom VLSI chips. All the chips are equal and each of them stores a number of "patterns". All the patterns in all the chips are compared in parallel to the data coming from the detector while the detector is being read out.

### 1. Introduction

The quality of results from present and future high energy physics experiments depends to some extent on the implementation of fast and efficient track finding algorithms. The detection of *heavy flavor* production, for example, depends on the reconstruction of secondary vertices generated by the decay of long lived particles, which in turn requires the reconstruction of the majority of the tracks in every event.

Particularly appealing is the possibility of having detailed tracking information available at trigger level even for high multiplicity events. This information could be used to select events based on impact parameter or secondary vertices. If we could do this in a sufficiently short time we would significantly enrich the sample of events containing heavy flavors.

Typical events feature up to several tens of tracks each of them traversing a few position sensitive detector layers. Each layer detects many hits and we must correctly correlate hits belonging to the same track on different layers before we can compute the parameters

M. Dell'Orso, L. Ristori, NIM A 278, 436 (1989)

### 2. The detector

In this discussion we will assume that our detector consists of a number of layers, each layer being segmented into a number of *bins*. When charged particles cross the detector they *hit* one bin per layer. No particular assumption is made on the shape of trajectories: they could be straight or curved. Also the detector layers need not be parallel nor flat. This abstraction is meant to represent a whole class of real detectors (drift chambers, silicon microstrip detectors etc.). In the real world the coordinate of each hit will actually be the result of some computation performed on "raw" data: it could be the center of gravity of a cluster or a charge division interpolation or a drift-time to space conversion depending on the particular class of detector we are considering. We assume that all these operations are performed upstream and that the resulting coordinates are "binned" in some way before being transmitted to our device.

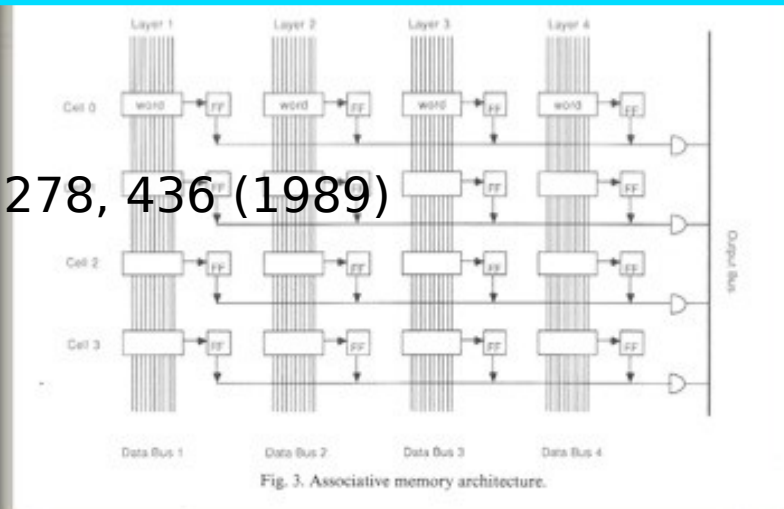

Fig. 3. Associative memory architecture.

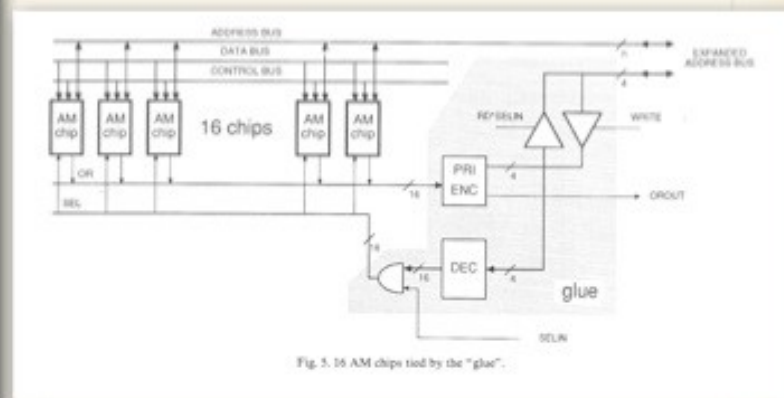

Fig. 5. 16 AM chips tied by the "glue".

We discuss the architecture of a device based on the concept of *associative memory* designed to solve the track finding problem, typical of high energy physics experiments, in a time span of a few microseconds even for very high multiplicity events. This "machine" is implemented as a large array of custom VLSI chips. All the chips are equal and each of them stores a number of "patterns". All the patterns in all the chips are compared in parallel to the data coming from the detector while the detector is being read out.

# Associative Memory (AM) = a kind of Content Addressable Memory (CAM)

- CAM = a memory that is accessed by its **contents**, not its **location**.
- E.g., while in a RAM we ask:
  - what do you have in location **xyz**?
- In a Content Addressable Memory (CAM) we ask:
  - Are there any locations holding the value **abc**?

# Binary CAMs

- **Binary CAM** (simplest):
  - uses search words consisting entirely of “1” and “0”

## Example:

stored word of -----> "**10110**" (“onepattern”)

It will be matched by the search word: "**10110**" (“the data”)



# Associative Memory: CAM cells contain pattern bank. CAM cells of same Layer are on a common bus

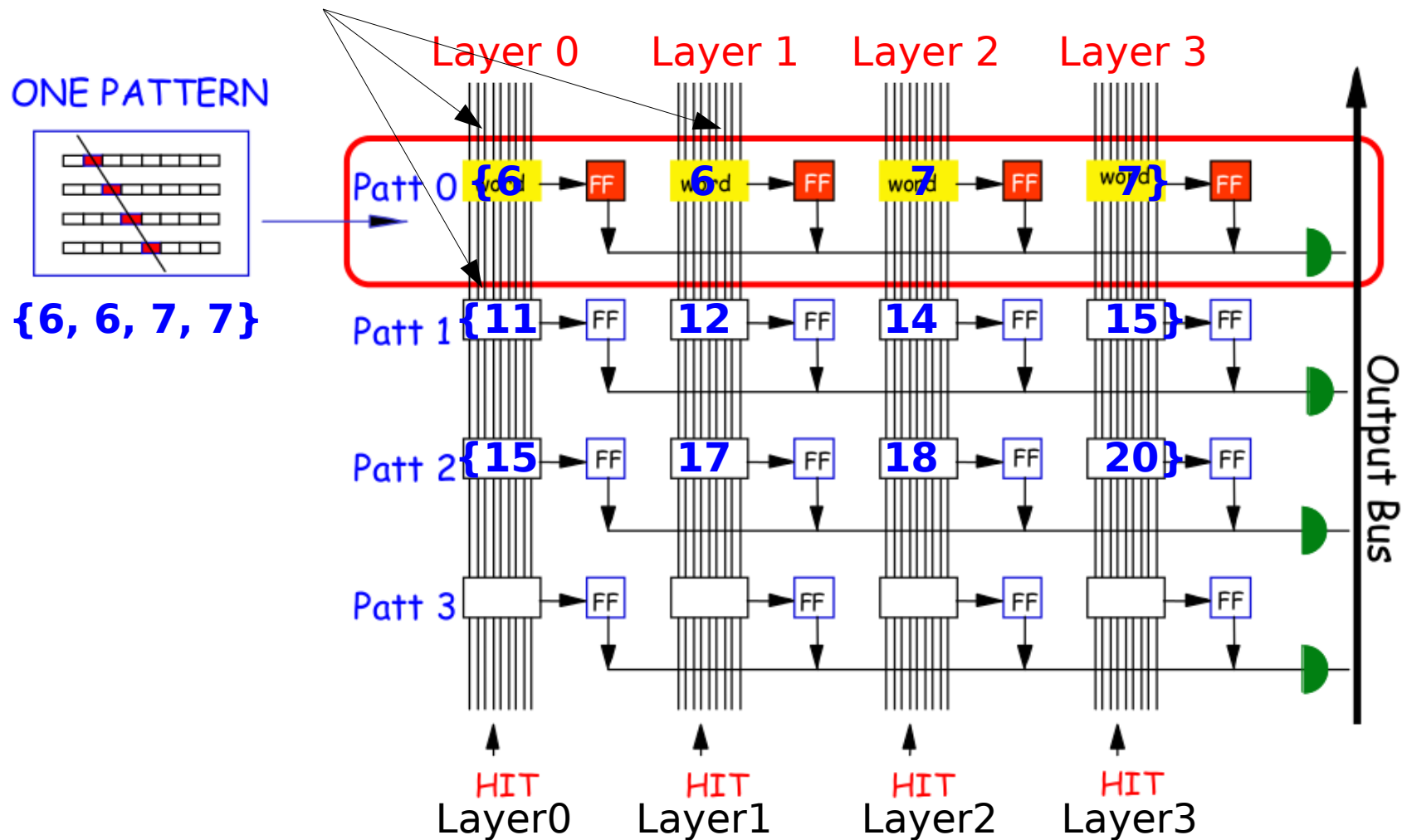

# Associative Memory: CAM cells check the matching of each hit independently

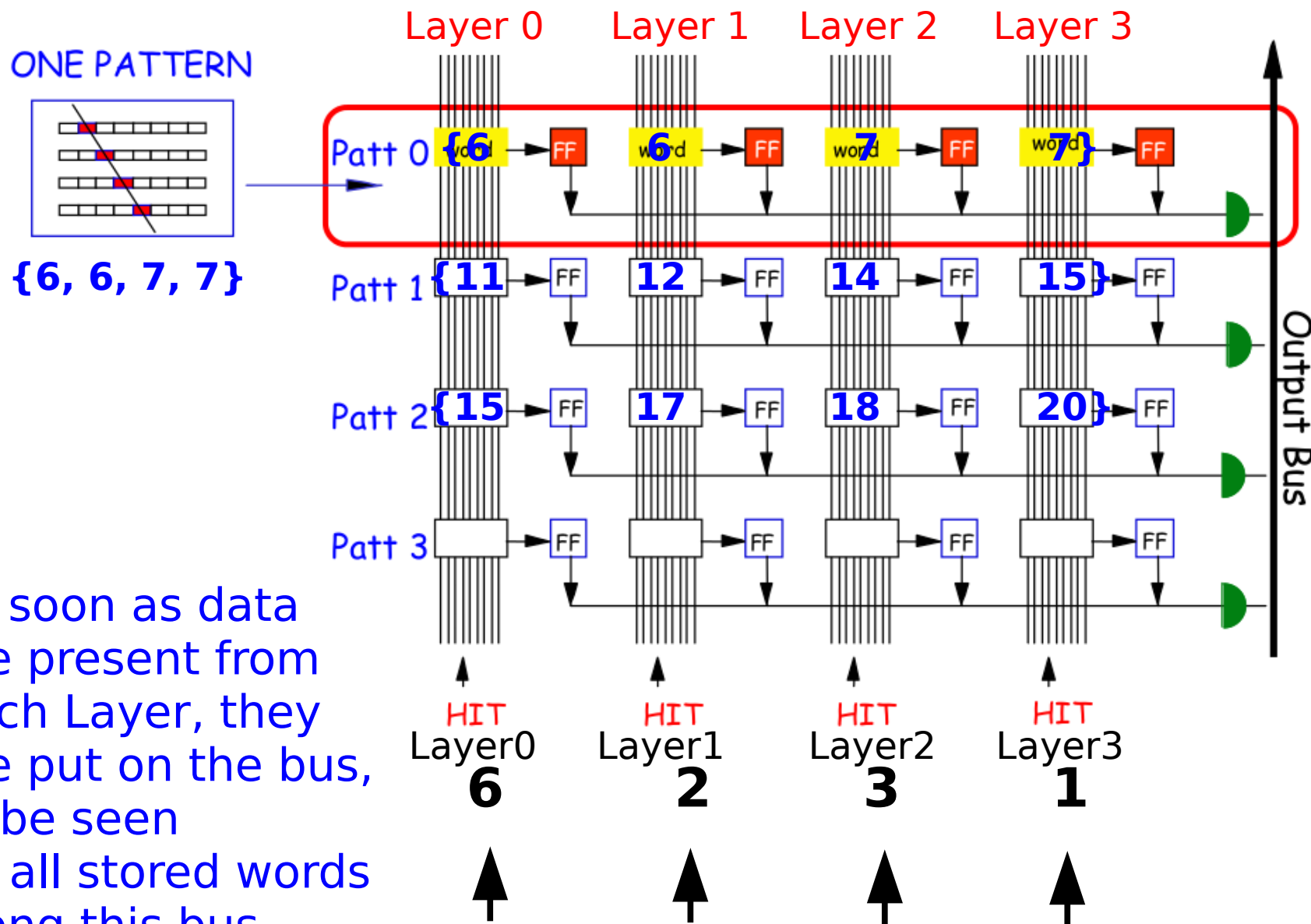

As soon as data are present from each Layer, they are put on the bus, to be seen by all stored words along this bus

# Associative Memory: CAM cells check the matching of each hit independently

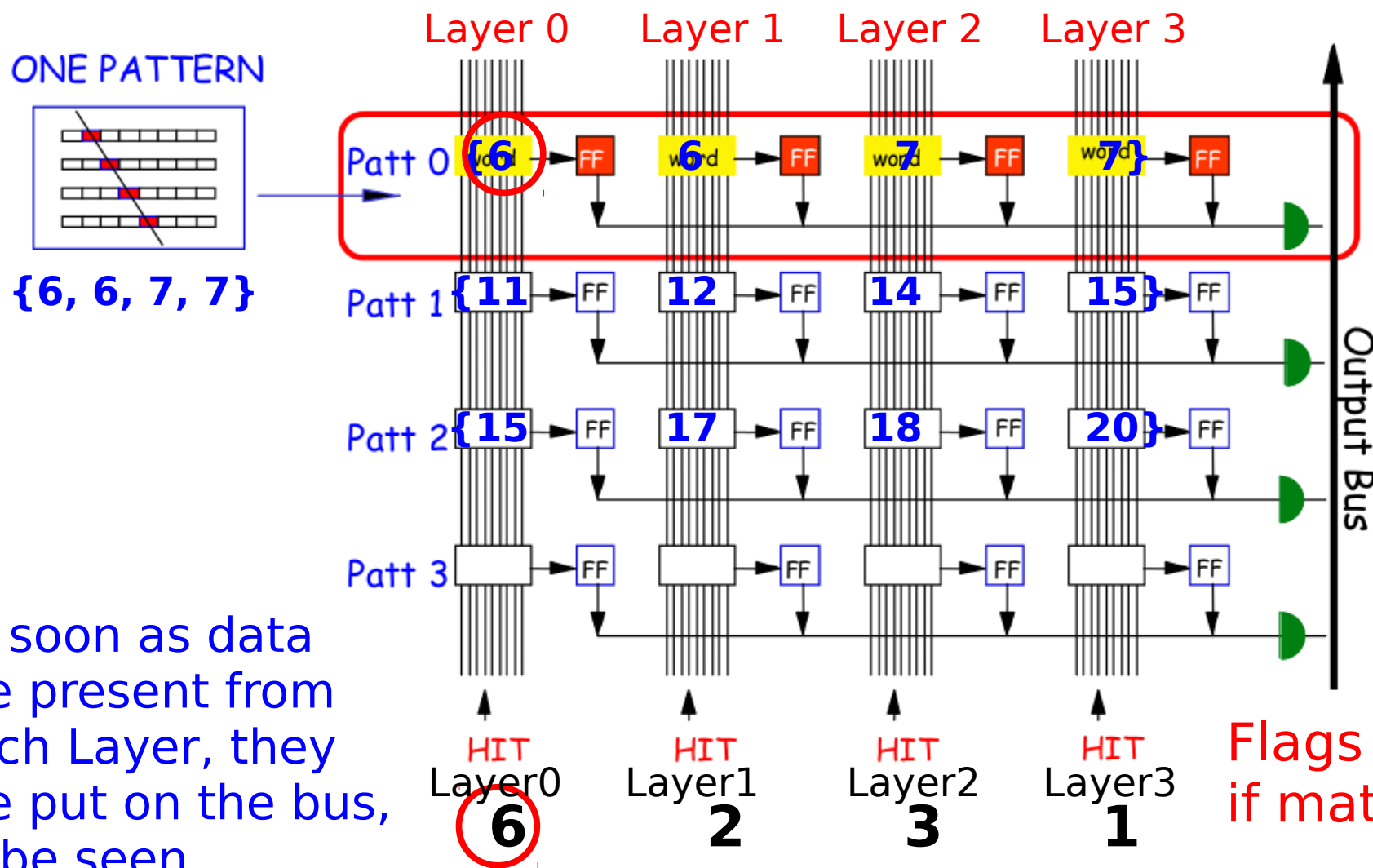

As soon as data are present from each Layer, they are put on the bus, to be seen by all stored words along this bus

# Associative Memory: CAM cells check the matching of each hit independently

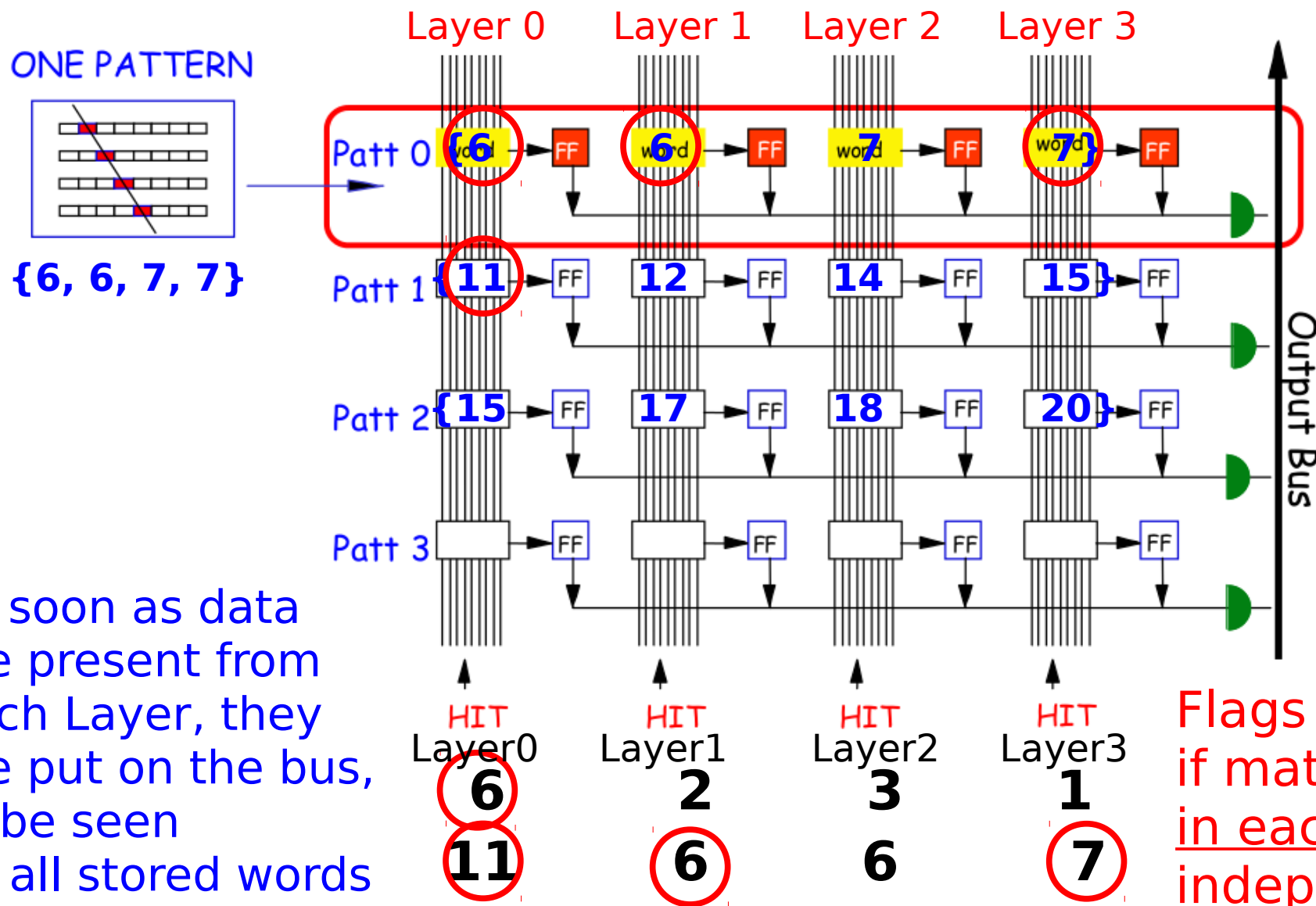

As soon as data are present from each Layer, they are put on the bus, to be seen by all stored words along this bus

Flags raised if matching in each hit independently

# Associative Memory: CAM cells check the matching of each hit independently

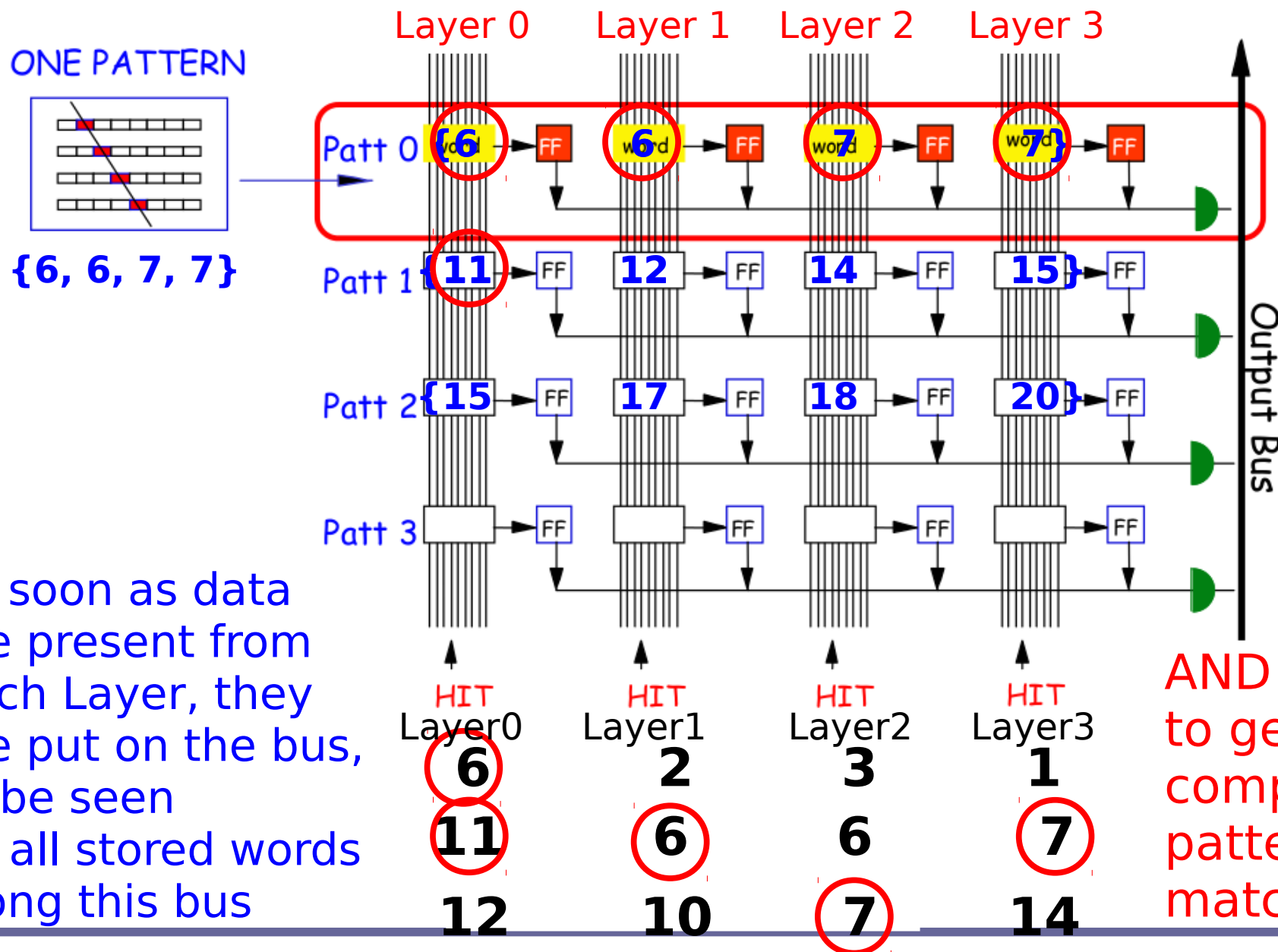



# Track trigger w/ pattern matching AM

Result:  
Matched  
Patterns  
=  
"Roads"

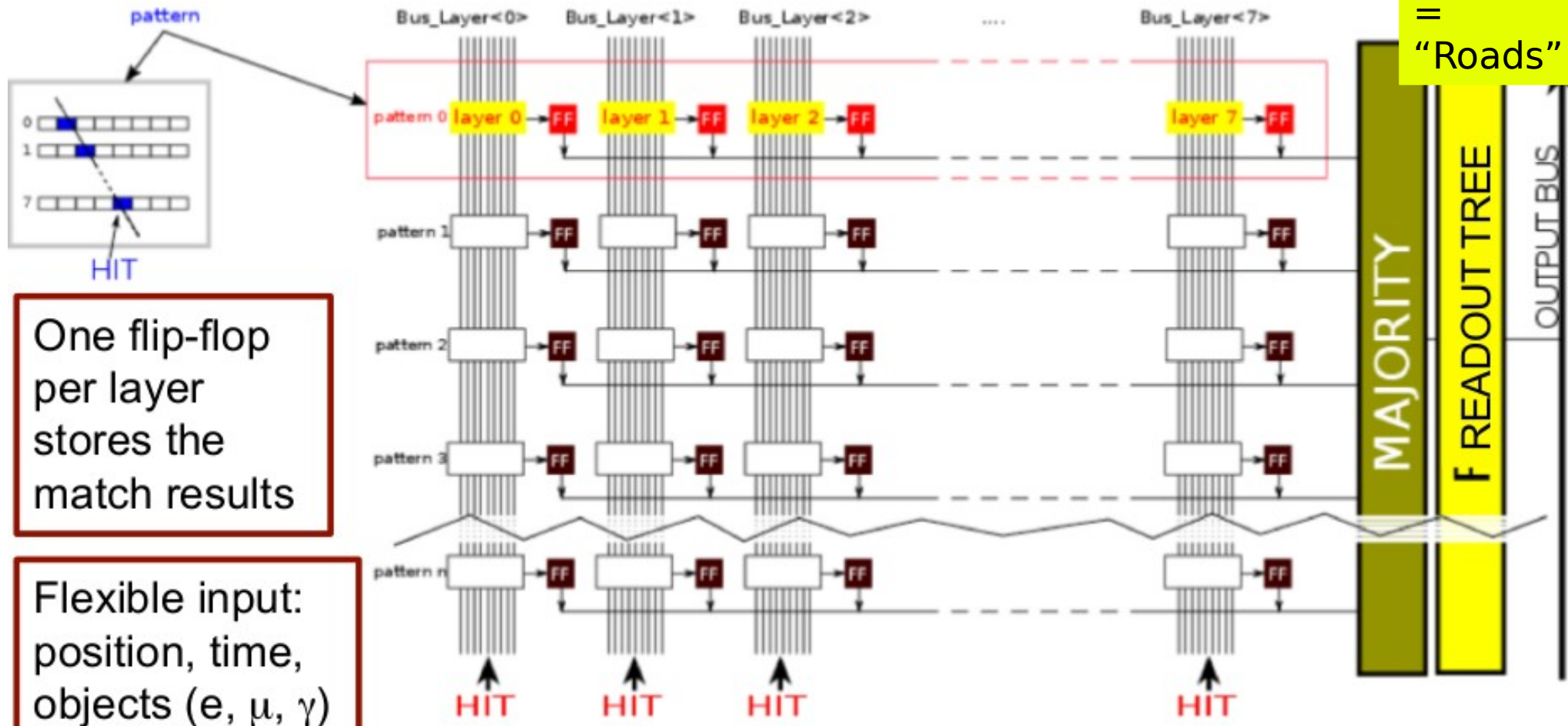

One flip-flop per layer stores the match results

Flexible input: position, time, objects ( $e$ ,  $\mu$ ,  $\gamma$ )

Pattern matching is completed as soon as all hits are loaded.  
Data arriving at different times is compared in parallel with all patterns.  
**Unique to AM chip: look for correlation of data received at different times.**

# AM evolution: mainly ASICs

SVT  
AM chip

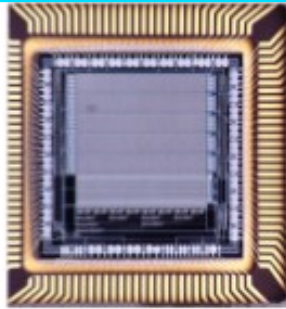

- (90's) **Full custom VLSI chip** - 0.7 $\mu$ m (INFN-Pisa)
- **128 patterns, 6x12bit words each, 30MHz**

F. Morsani et al., IEEE Trans. on Nucl. Sci., vol. 39 (1992)



Alternative **FPGA** implementation of SVT AM chip

P. Giannetti et al., Nucl. Instr. and Meth., vol. A413/2-3, (1998)

G Magazzù, 1<sup>st</sup> std cell project presented @ LHCC (1999)

SVT upgrade

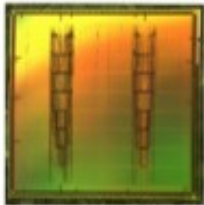

**Standard Cell 0.18  $\mu$ m**  $\rightarrow$  **5000 pattern/AM chip**

SVT upgrade total: 6M pattern, 40MHz

A. Annovi et al., **IEEE TNS**, Vol 53, Issue 4, Part 2, **2006**

FTK R&D

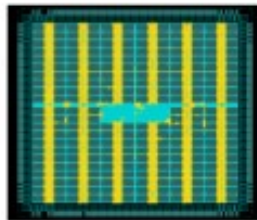

AMchip04 –65nm technology, std cell & full custom, 100MHz  
Power/pattern/MHz ~30 times less. Pattern density x12.

**First variable resolution implementation!**

F. Alberti et al 2013 *JINST* **8 C01040**, doi:[10.1088/1748-0221/8/01/C01040](https://doi.org/10.1088/1748-0221/8/01/C01040)



# AM chip for FTK: AMchip06

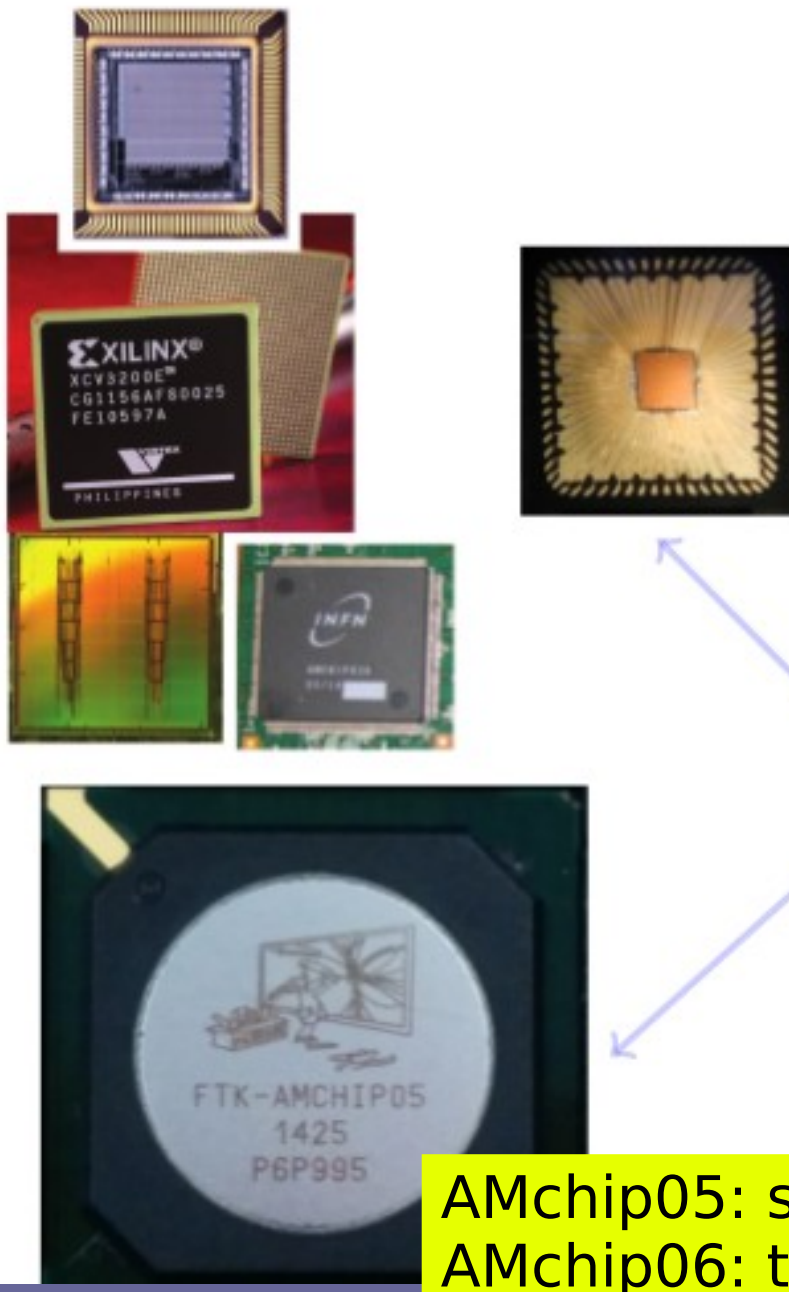

- ▶ 90's Full custom VLSI chip - 0.7mm (INFN-Pisa) 128 patterns, 6x12bit words each (F. Morsani et al., The AMchip: a Full-custom MOS VLSI Associative memory for Pattern Recognition, IEEE Trans. on Nucl. Sci., vol. 39, pp. 795-797, (1992).)
- ▶ 1998 FPGA for the same AMchip (P. Giannetti et al. A Programmable Associative Memory for Track Finding, Nucl. Instr. and Meth., vol. A413/2-3, pp.367-373, (1998) ).
- ▶ 1999 G. Magazzù, first standard cell project presented at LHCC
- ▶ 2006 Standard Cell UMC 0.18  $\mu m$  5000 pattern/AMchip for CDF SVT upgrade total: 6M patterns (L. Sartori, A. Annovi et al., A VLSI Processor for Fast Track Finding Based on Content Addressable Memories, IEEE TNS, Vol 53, Issue 4, Part 2, Aug. 2006 )
- ▶ **2012 AMchip04** 8k patterns in 14mm<sup>2</sup>, TSMC 65nm LP technology Power/pattern/MHz 40 times less. Pattern density x12. First variable resolution implementation. (F. Alberti et al 2013 JINST 8 C01040, doi:10.1088/1748-0221/8/01/C01040 )
- ▶ **2013-2014 AMchip MiniAsic and AMchip05** a further step towards final AMchip version. Serialized input and output buses at 2 Gbs, further power reduction approach. BGA 23 x 23 package.
- ▶ **2014-2015 AMchip06:** final FTK version of the AMchip for the ATLAS experiment .

AMchip05: switched to serialized IO (11\*2Gbs)  
AMchip06: the FTK AM chip with 128k patterns/chip

Pattern matching not restricted to trackers.  
Applies everywhere there is correlated  
behaviour. e.g:

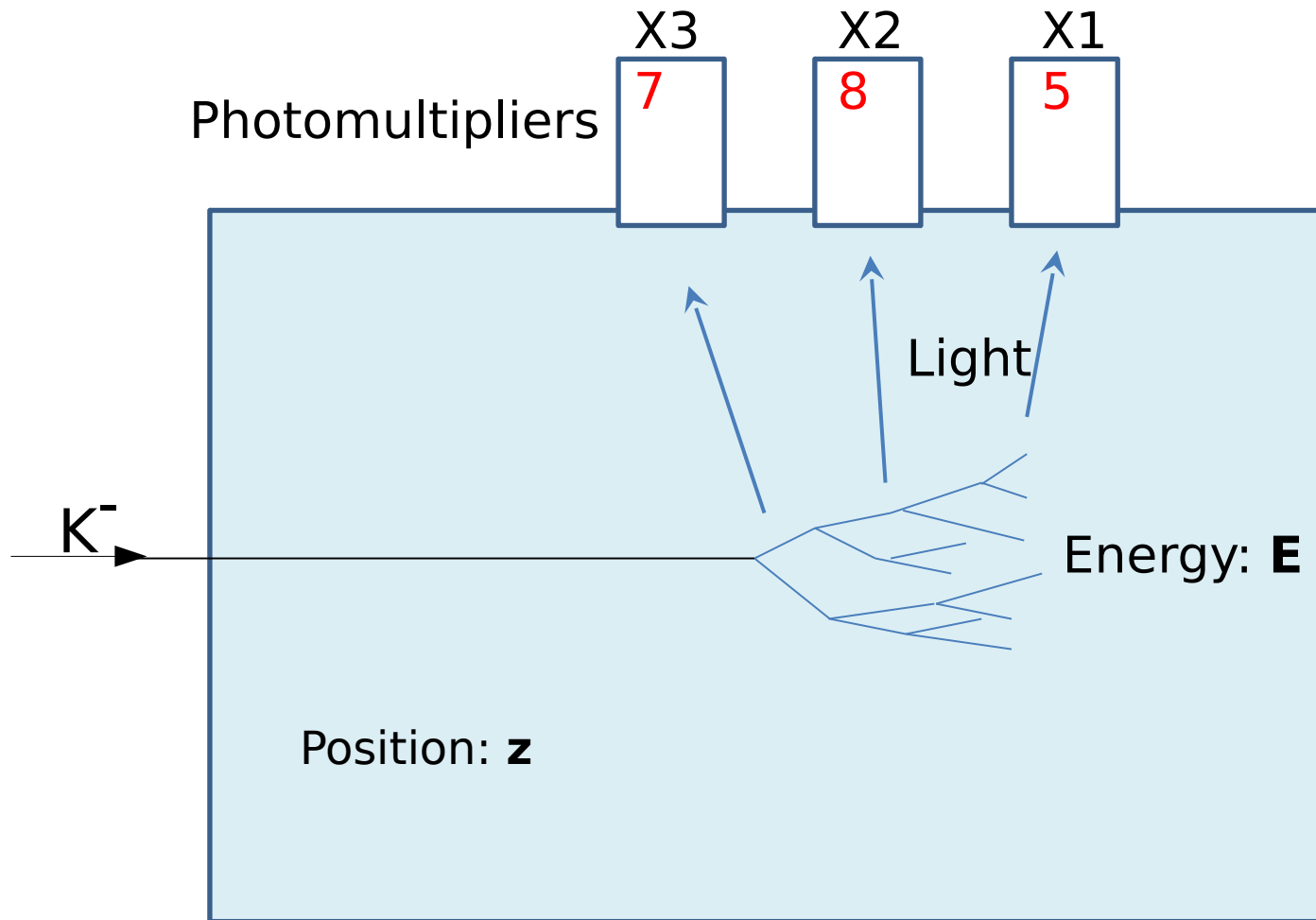

# The values in X1 and X2 are correlated: their values define the possible {X1,X2} patterns

For example, task = Associate the measured X1 and X2:  
e.g., X1 = 5 with X2 = 8

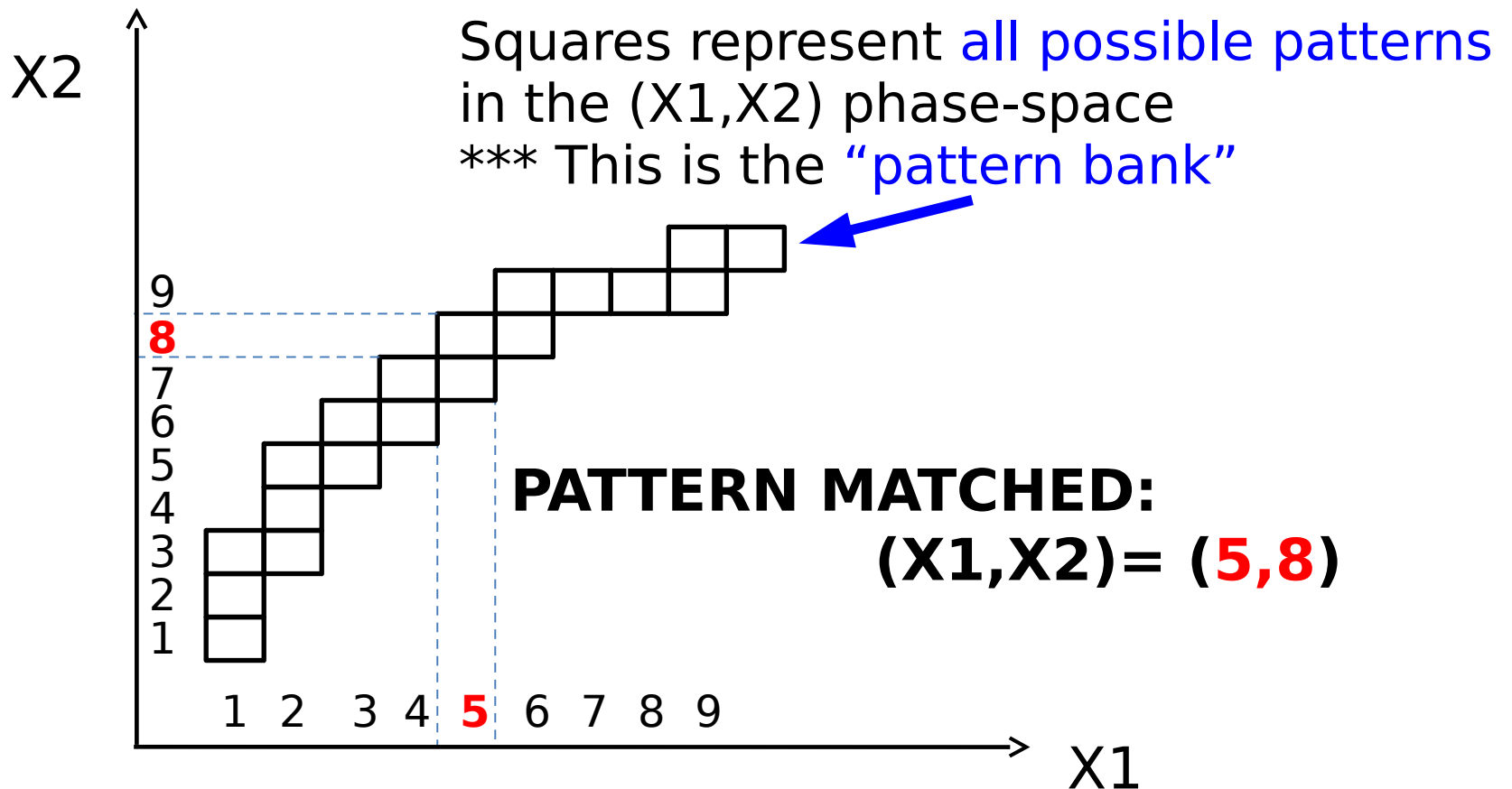



## 2b.

Now that we have a system that does pattern matching as the data are coming in,

storage problem: how do we deal with the number of patterns which can be big in the high-granularity detectors?

$N_{\text{patterns}}$  depends on the “bin size”,  
 i.e, the granularity with which we want  
 to look at the detector

Wide patterns

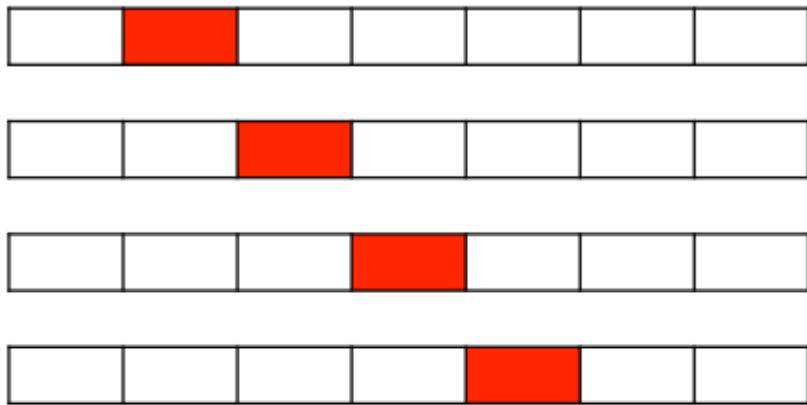

Thin patterns

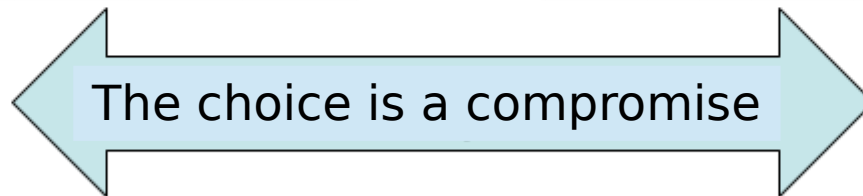
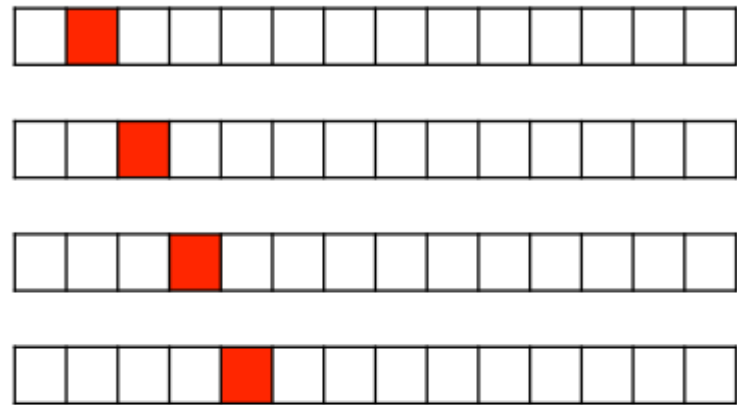

High efficiency  
 with less patterns (hardware)  
**BUT more fakes**

More patterns (hardware)  
 for same efficiency less fakes  
Fakes are workload for track fitter !

Recall: the number of patterns  $N_p$ , with  $m$  layers, of  $n$  bins each, is  $N_p \simeq (m-1)n^2$

High efficiency with large bins (small number of patterns) → but, lots of fake tracks found → lots of work for detailed track fitting!

**We want “few patterns”-“few fakes” scenario**

ATL-UPGRADE-PROC-2011-004  
doi:10.1109/ANIMMA.2011.6172856

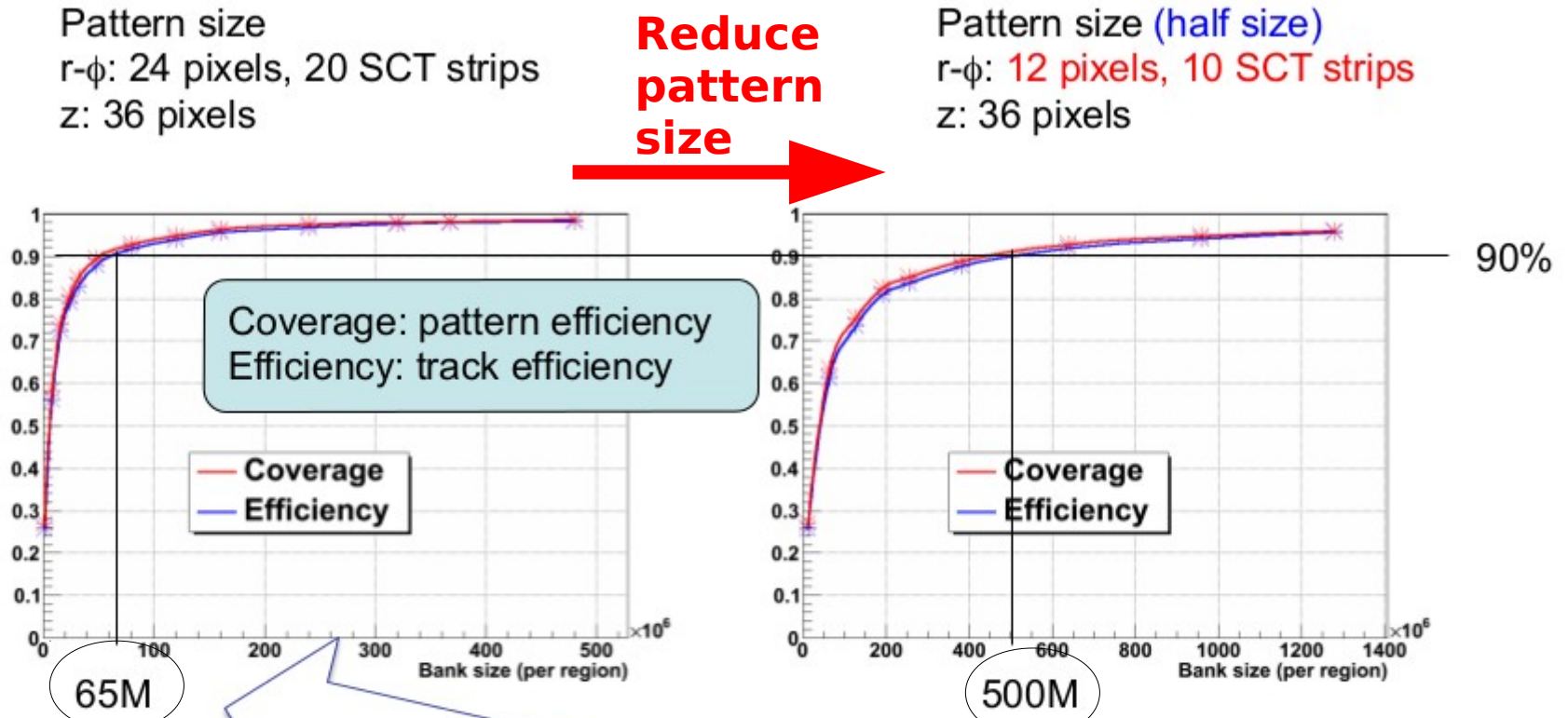

# of patterns in AM chips (barrel only, 45 φ degrees)

<# matched patterns/event @ 3E34> = 342k

<# matched patterns/event @ 3E34> = 40k

# roads (large fake fraction) represents the workload for the track fitter

# Use the feature of “ternary CAMs”

- **Ternary CAM:** added flexibility to the search
  - allows a third matching state of "X" or "Don't Care" for one or more bits in the stored pattern word: **one pattern matches various data words**
- **Example:** a ternary CAM might have a stored word of -----> **"10XX0"** (“one pattern”)  
This will match any of 4 search words: **"10000"** (“the data”)  
**"10010"** (“the data”)  
**"10100"** (“the data”)  
**"10110"** (“the data”)  
The added flexibility comes at additional cost:
  - the internal memory cell must now encode *three possible states instead of the two of binary CAM*. This additional state is typically implemented *by adding a mask bit ("care" or "don't care" bit) to every memory cell.*

# Variable resolution (bin sizes) with “Don't Care” (DC) bits

Alberto Annovi

\* ANIMMA - A new “Variable Resolution Associative Memory” for High Energy Physics  
ATL-UPGRADE-PROC-2011-004, doi:10.1109/ANIMMA.2011.6172856

\* “Variable resolution Associative Memory for the Fast Tracker ATLAS upgrade”, ICATTP 2013

- For each layer: a “bin” is identified by a number with DC bits (X)
- Least significant bits of “bin” number can use 3 states (0, 1, X)
- The “bin” number is stored in the Associative Memory
- The DC bits can be used to OR neighborhood high-resolution bins, which differ by few bits, without increasing the number of patterns

Pixels:

0	1	2	3	4	5	6	7
8	9	10	11	12	13	14	15
16	17	18	19	20	21	22	23
24	25	26	27	28	29	30	31

Using binary format

“01010” selects bin 10

“0001x” selects bins 2 or 3

“1x000” selects bins 16 or 24

“0x11x” selects bins 6,7,14, or 15

“111xx” selects bins 28 to 31



# Refinements: majority & variable widths

- Majority Logic: Only require N out of M layers have a match
  - Gains efficiency
- Variable Resolution Patterns (Don't Care Bits)

With 2 DC bits: Apart from reduction in fakes (factor 7), we save also a factor 5 in the size of the pattern bank!

No variable resolution:  
3 patterns needed

1 bit variable resolution:  
1 pattern needed

3 bit variable resolution:  
1 pattern with 1/16th volume

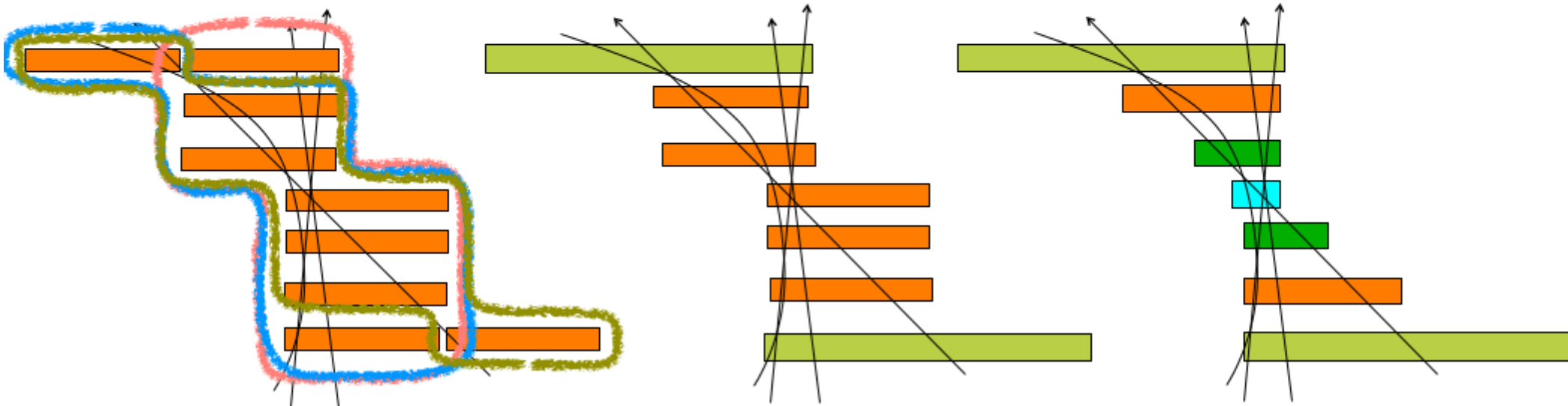

Technique can be exploited by any coincidence based trigger!

Alberto Annovi

\* ANIMMA - A new "Variable Resolution Associative Memory" for High Energy Physics  
ATL-UPGRADE-PROC-2011-004, doi:10.1109/ANIMMA.2011.6172856

\* "Variable resolution Associative Memory for the Fast Tracker ATLAS upgrade", ICATTP 2013

### 3.

Now that we have found some matching patterns

each matching pattern defines a “road” for the refined tracking

go and

fetch all the (few now) hits it contains, and we should

fit them to a helical track to measure the track parameters precisely

# Track fitting in FPGAs: 1<sup>st</sup> stage, 8 layers

- Pattern recognition layers 
- 8 layers track fit
  - full resolution hits
  - reject most fakes

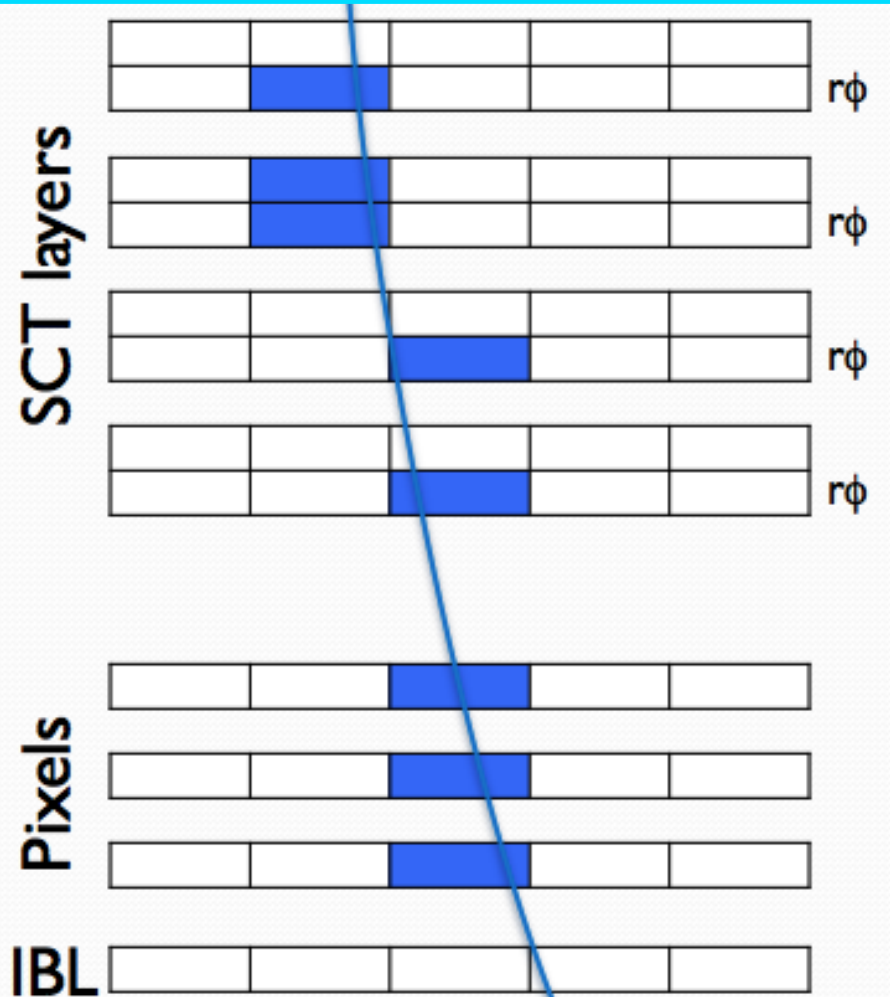

5 parameters &  $\chi^2$   
 $d_0, z_0, \eta, \phi, PT, \chi^2$

Hit coordinate  
 (local to each  
 detector module)

**Full resolution hits**

$$\tilde{p}_i = \sum_{l=1}^N C_{il} x_l + q_i$$



Track fitting in FPGAs w/ many Digital Signal Processors (DSPs)

**BUT: Linear approximation:** get a set of linear equations

“each parameter depends linearly on the hits” → fast

**multiplications with pre-computed constants ~1 Gfits/s per FPGA**

# Track fitting in FPGAs: 2<sup>nd</sup> stage, 12 layers

- Pattern recognition layers 
- 8 layers track fit
  - full resolution hits
  - reject most fakes
- Extrapolate track to other layers 
  - Look for hits in a narrow region
- Full 12 layer fit 

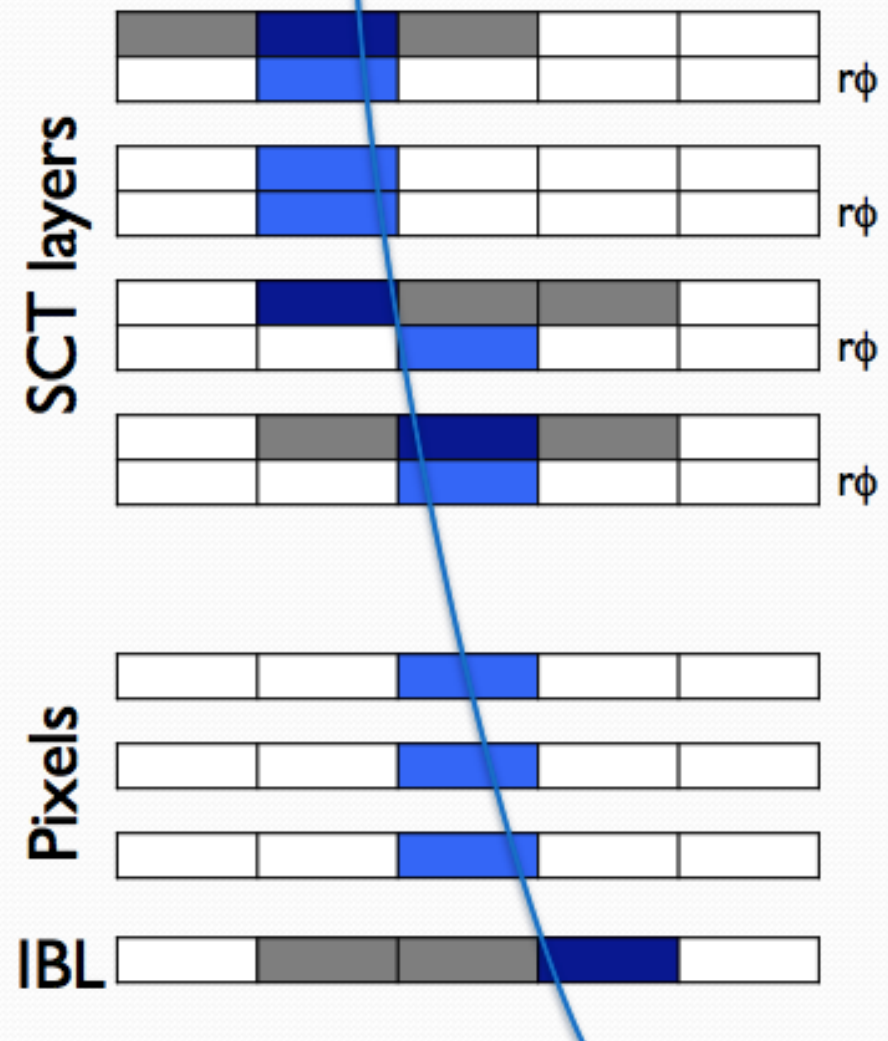

Done on FPGAs, on a “2nd stage” board

# Approximations and Tables with constants are very common calculation tools. Don't be afraid of them!

- E.g., in a computer if normal math calls are time-expensive:
  - $\sin(x)$  = **Taylor expansion** gives a polynomial to calculate  $\sin(x) \approx x - \frac{x^3}{6} + \frac{x^5}{120}$
- Or, use **Look-Up Tables (LUTs = precalculated values stored in tables)** and **interpolate** between the neighbouring  $\sin(x)$  to get the value you ask for

```
function lookup_sine(x)
  x1 := floor(x*1000/pi)
  y1 := sine_table[x1]
  y2 := sine_table[x1+1]
  return y1 + (y2-y1)*(x*1000/pi-x1)
```

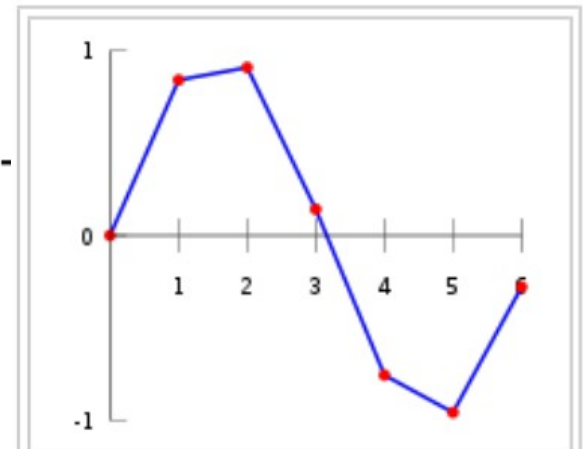

Linear interpolation on a portion of the sine function



# FTK : working configuration

- High resolution patterns:  $(15 \times 36)_{\text{pix}} \times 16_{\text{sct}}$ 
  - Pixels: 15 channels along  $\phi$ , 36 ch. along  $\eta$
  - Strips: 16 strips
- Background events with 69 superimposed pp collisions
  - Instantaneous luminosity  $3 \times 10^{34}$  Hz/cm<sup>2</sup>
- Hardware constraints (for each of 64  $\eta$ - $\phi$  towers)
  - # AM patterns  $< 16.8 \times 10^6$
  - # roads/event  $< 16 \times 10^3$
  - # fits/event  $< 80 \times 10^3$

DC bits group detector channels together and increase the pattern resolution

Work load for track fitter

	Coarse resolution roads	Max # DC bits / layer	# AM pattern * 10 <sup>6</sup>	Efficiency %	roads / evt * 10 <sup>3</sup>	fits / evt * 10 <sup>3</sup>
Barrel	$(30 \times 72)_{\text{pix}} \times 32_{\text{sct}}$	$2_{\text{pix}} \times 1_{\text{sct}}$	16.8	93.3%	3.2	26
Endcap	$(30 \times 72)_{\text{pix}} \times 32_{\text{sct}}$	$2_{\text{pix}} \times 1_{\text{sct}}$	16.8	91.2%	6.9	55

Alberto Annovi

\* ANIMMA - A new "Variable Resolution Associative Memory" for High Energy Physics  
ATL-UPGRADE-PROC-2011-004, doi:10.1109/ANIMMA.2011.6172856

\* "Variable resolution Associative Memory for the Fast Tracker ATLAS upgrade", ICATTP 2013

# Some documentation for details

FTK Technical Design Report (TDR): <https://cds.cern.ch/record/1552953?ln=en>  
<https://atlas.web.cern.ch/Atlas/GROUPS/PHYSICS/UPGRADE/CERN-LHCC-2013-007/index.html>

FTK Public results: <https://twiki.cern.ch/twiki/bin/view/AtlasPublic/FTKPublicResults>

# The road to FTK: Content Addressable Memory, the Associative Memory & FPGAs

- K. Pagiamtzis and A. Sheikholeslami, "*Content-addressable memory (CAM) circuits and architectures: A tutorial and survey*," in IEEE Journal of Solid-State Circuits, vol.41, no.3, pp. 712-727, March 2006
- M. Dell'Orso and L. Ristori, "*VLSI Structures Track Finding*", Nucl. Instr. and Meth. A, vol. 278, pp. 436-440, 1989.
- W. Ashmanskas et al., "*The CDF online Silicon Vertex Tracker*", Nucl. Instr. and Meth. A, vol. 485, pp. 178-182, 2002.
- A. Annovi, et al., "*Associative memory design for the Fast Track processor (FTK) at ATLAS*," in IEEE NSS/MIC, 2009, Orlando, pp. 1866 - 1867.
- C.-L. Sotiropoulou, S. Gkaitatzis, A. Annovi, et al. "*A Multi-Core FPGA-based 2D-Clustering Implementation for Real-Time Image Processing*", in IEEE Trans. on Nuclear Science, vol. 61, no. 6, pp. 3599 - 3606, December 2014.

# From the FTK to the future

- FTK uses the AMchip06, an Associative Memory with
  - 128k patterns of 8 words  $\times$  18 bits each word
  - high speed serial links
  - variable resolution (up to 6 ternary bits)
  - low power
  - 8  $\times$  16 bit comparisons at 100 MHz
- These ideas and technology will not be restricted to FTK in ATLAS
  - Future applications in HEP (tracking in L1 for ATLAS and CMS...)
  - Applications outside HEP (medical imaging, smart cameras, genomics, ...)

# The point to take home:

- **Split the problem** in a fast (**coarse**) one, and a **refined one** working with much reduced data.

(you know now that we do this all the time in the trigger)

- **Use pre-calculated patterns & values wherever you can**: if you get the desired precision, **you gain a lot in time**

...And time is precious in the online world!

- We saw the **example of the Fast Tracker upgrade in ATLAS**, using
  - **AM-based pattern matching** with “AM chip” (ASIC),
  - **refined track-fitting** and almost everything else needed (from formatting to smart databases, to I/O) in powerful modern FPGAs



## C. Other examples

# Other examples

- What presented here is not the only way to solve the tracking problem fast.
  - Hough transforms in FPGAs,
  - GPUs for the HLT farms etc.
  - ...etc...
- But nothing can be as fast as doing the tracking while reading your data, as they pass through the system.
  - If you can not afford to be slower, then you'll probably use an Associative Memory.

# Tracking at HEP in the future: AM+FPGAs, FPGAs, CPUs, and GPUs

- V. Halyo, et. al., *“GPU Enhancement of the Trigger to Extend Physics Reach at the LHC,”* Journal of Instrumentation 8 P10005, 2013. → **You will hear from Gianluca Lamanna on Tuesday**
- C. Gentsos, F. Crescioli, P. Giannetti, D. Magalotti, S. Nikolaidis, *“Future evolution of the Fast Tracker (FTK) processing unit”*, PoS (TIPP2014) 209
- A. Annovi, et al., *“Associative Memory for L1 Track Triggering in LHC Environment,”* in IEEE Trans. on Nuclear Science, Vol. 60, No. 5, pp. 3627 – 3632, 2013.
- G. Hall, et al., *“A time-multiplexed track-trigger for the CMS HL-LHC upgrade”*, in NIM A, Vol.824, 11 July 2016, pp. 292–295
- ... etc...

**HighLuminosity-LHC** (HL-LHC): pile-up of ~140 events/crossing will be typical; up to 200 events per crossing are considered likely.

At L1: need tracking in  $<10 \mu\text{s}$

# L1 Track Trigger at CMS : start with a cleaner picture (not just hits)

- ~99% of tracks have  $P_T < 2 \text{ GeV}/c$  ; interesting things have higher  $P_T$  tracks.
- CMS makes the detector itself selective on such tracks by finding track “stubs” on closely spaced layers

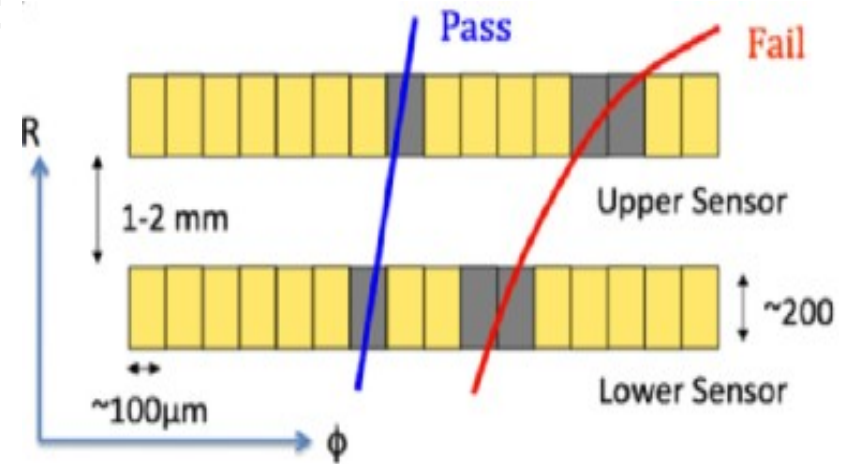

- At  $B=4$  Tesla, you have for each stub (straight line) of angle  $\varphi$ , at some double layer at a radius  $r$ , originating from a track generated with  $\varphi_0$  and  $P_T$

$$\varphi = \frac{\pm 0.006}{p_T} r + \varphi_0$$

# Track trigger example at CMS with FPGA-only

- This  $\varphi(r)$  behaviour is a straight line:  $\varphi = \mathbf{m} \mathbf{r} + \mathbf{c}$ 
  - Do a “**Hough transform**”: map individual  $\{r, \varphi\}$  measurement points to a whole-line characteristic in 2D space: **the slope (m) & the intercept (c)**
  - Given an  $\{r, \varphi\}$  pair, try values for m, get c:  $\mathbf{c} = -\mathbf{m} \mathbf{r} + \varphi$  and put  $\{m, c\}$  in a 2-dimensional histogram
    - **$\{r, \varphi\}$  measurements from same track will populate same  $\{m, c\}$  bin**
    - **Most populated bin = characterises whole track**
    - Note: Small  $|m|$  values:  $|m| = 0.006/P_T \rightarrow |m| < 0.003$
- Pileup events:  $\{m, c\}$  array heavily populated and such peaks are not initially prominent.

But, by requiring e.g., all stubs in the  $(m, c)$  histogram bin to be from different radial layers, significantly reduces the background



# Hough transform

- P. V. C. Hough, *“Method and means for recognizing complex patterns,”* U.S. Patent 3,069,654, 1962.
- R. O. Duda and P. E. Hart, *“Use of the Hough transformation to detect lines and curves in pictures”* Communications of the ACM, vol. 15, no. 1, pp. 11-15, 1972.
- J. Illingworth and J. Kittler, *“The Adaptive Hough Transform”*, IEEE Trans. On Pattern Analysis and Machine Intelligence, Vol PAMI-9, No. 5, Sept. 1987, pp. 690-698.
- Xin Zhou, Yasuaki Ito, and Koji Nakano. *“An FPGA Implementation of Hough Transform using DSP blocks and block RAMs.”* Bulletin of Networking, Computing, Systems, and Software, Vol 2, No 1 (2013), pages 18-24.

....etc....

- **On FPGAs: important to adapt the algorithms to the constraints of FPGA operation.** Algorithms can overflow the capacity of even a very large FPGA because of timing constraints or routing congestion

# Beyond High Energy Physics applications: image processing

- Hough transform is one of the classic techniques used in image processing to do first an “edge-detection”
- Let's see an interesting example on image perception:

M. Del Viva, G. Punzi, and D. Benedetti. *“Information and perception of meaningful patterns.”* PloS one 8.7 (2013): e69154.

“... models describe the **initial processing of visual information as the extraction of a simplified “sketch” based on a limited number of “salient features”** [11], [12], that therefore contains a much reduced amount of information.”

“We adopt the **principle of maximum entropy** as a measure of optimization: we ask **what is choice of the pattern set producing the largest amount of entropy allowed by the given limitations of the system.** We will see that this simple requirement, together with the imposed strict limitations to the computing resources of the system, allows to completely determine the choice of the pattern set from the knowledge of the statistical properties of the input data.”

# Image processing, an interesting example with patterns: M. Del Viva, G. Punzi, and D. Benedetti. Fig. 1

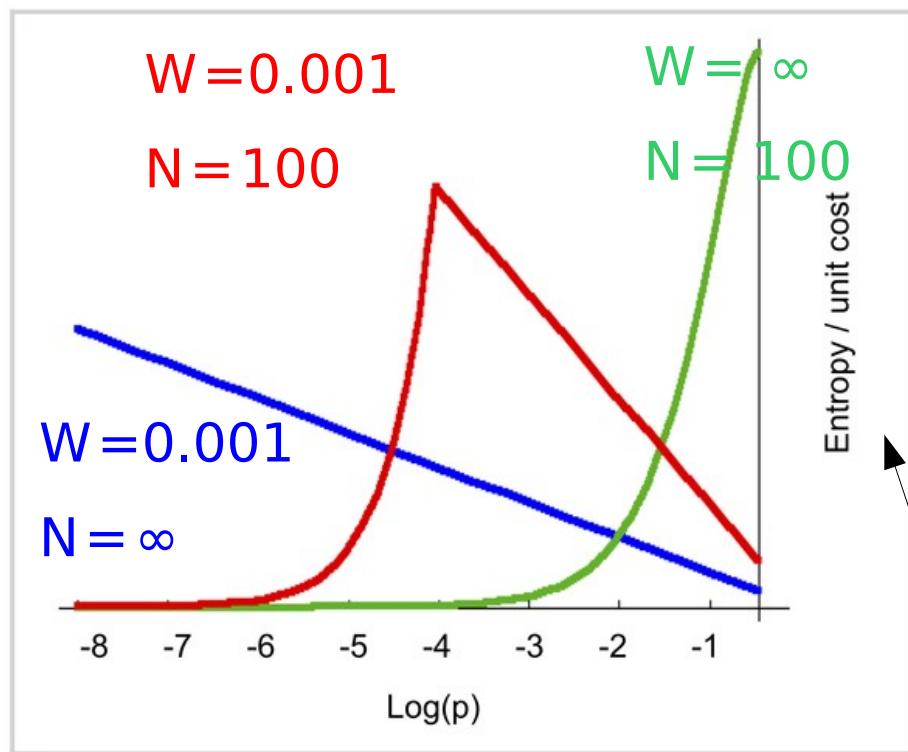

Constrain #1: storage

$N$  = number of patterns

Constraint #2: output bandwidth

$W$  = reduction factor  
(e.g.,  $W=0.001 \rightarrow 1/1000$   
can be selected with this  
pattern set)

$p$  = probability that the given  
pattern matches the  
(sub)image we check

$$f(p) = \frac{-p \log(p)}{\max(1/N, p/W)}$$

unit cost for each  
pattern

# Image processing, an interesting example with patterns: M. Del Viva, G. Punzi, and D. Benedetti, Fig. 3 and 4

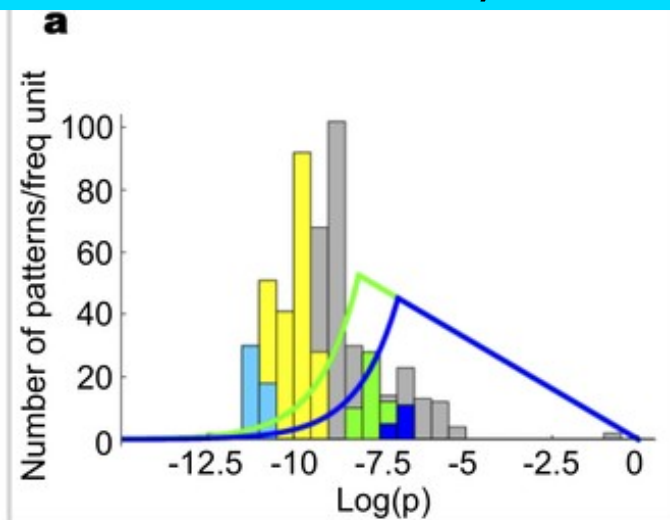

- In a 3x3 grid:
  - 512 possible patterns
- Green:
  - the “best” 50 of them (use them in the images below)
- Blue:
  - the “best” 15 of them

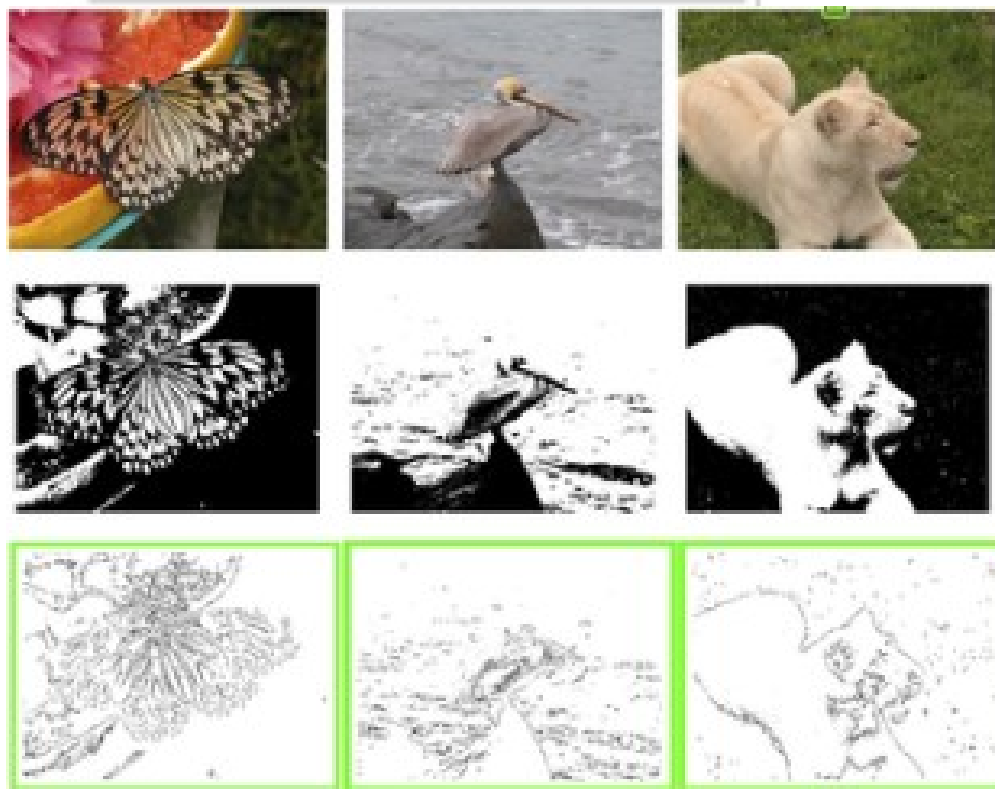

# Image processing, an interesting example with patterns: M. Del Viva, G. Punzi, and D. Benedetti. Fig. 2

Our tracking detectors also produce images,  
and we select events based on them

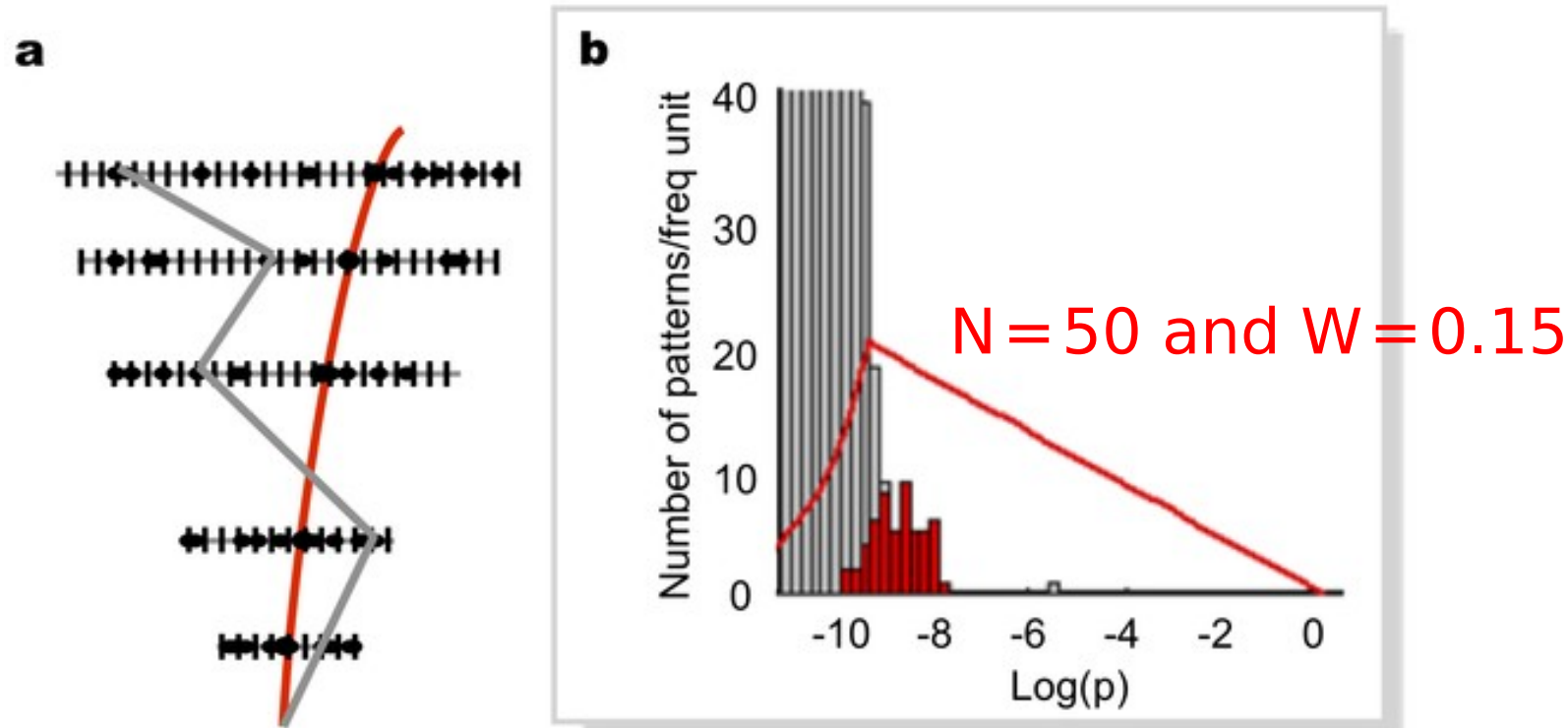

Of course, we know that all these zig-zag lines are meaningless  
Training on simulated events, to get the patterns with max. entropy,  
picks up the patterns we also select when we do simulations  
to define the pattern bank.

Done.

An announcement before closing →



# An announcement: MOCAS T 2017

<http://mocas t.physics.auth.gr/>

4<sup>th</sup> edition with a session for  
FTK + Detector and Trigger/DAQ Electronics !!!



Call for Papers

Organizing Committee

**4 - 6 May 2017 Thessaloniki Greece**

**Thank you!**

Acknowledgments:

Alberto Annovi, Francesco Crescioli, Mauro Dell' Orso, Paola Giannetti,  
and FTK members

Extras...



# FTK - Fast Tracker for Hadron Colliders

An FP7 IAPP project (February 1, 2103 - January 31, 2017)

Home

Partners

The Project

Dissemination

Jobs

- Pisa (coord)
- AUTH
- CAEN
- CERN
- CNRS/Paris
- Prisma Electronics

- The FTK Project
- FTK application in HEP
- Other FTK applications
- Transfer of Knowledge

- Talks and Proceedings
- Papers
- FTK events

Collaboration 

## <http://ftk-iapp.physics.auth.gr/>



This project aims to develop an extremely fast but compact processor, with supercomputer performances, for pattern recognition, data reduction, and information extraction in high quality image processing.

The proposed hardware prototype features flexibility for potential applications in a wide range of fields, from triggering in high energy physics to simulating human brain functions in experimental psychology or to automating diagnosis by imaging in medical physics. In general, any artificial intelligence process based on massive pattern recognition could largely profit from our device, provided data are suitably prepared and formatted.

The project has received funding from the European Union's Seventh Framework Programme for research, technological development and demonstration under grant agreement n.324318  
Participants (2 SMEs and 4 Academic Institutions)



FP7 Project  
324318



UNIVERSITÀ DI PISA  
University of  
Pisa, Italy



Aristotle  
University of  
Thessaloniki  
(AUTH), Greece



CAEN  
Tools for Discovery  
CAEN SpA,  
Italy



CERN,  
Switzerland



CNRS, France



Prisma  
Electronics  
ABEE,  
Greece



# Extras

- D. Emeliyanov, et al., “GPU-based tracking algorithms for the ATLAS high-level trigger” in Journal of Phys. Conf., Ser. 396, 012018, 2012.
- J. Mattmann, et al., “Track finding in ATLAS using GPUs,” in Journal of Phys. Conf., Ser. 396, 022035, 2012.
- Y. Ago, Y. Ito, and K. Nakano, “An FPGA implementation for neural networks with the FDFM processor core approach,” International Journal of Parallel, Emergent and Distributed Systems, vol. 28, no. 4, pp. 308–320, 2012.

Input Mezzanine card(IM)  
+ Data Formatter(DF)

Processor Units: Auxiliary  
card(AUX) +  
Associative Memory Board(AM)

Dual HOLA card

Copy the hit from ID and send to FTK

**IM:** Receive the hits and perform clustering  
**DF:** hit sharing and provide pipeline (the "custom switch" to fan-out hits to the relevant Processor for this  $\eta$ - $\phi$  tower

**AM:** pattern recognition in SuperBin ("SuperStrip") resolution

**AUX:** a) mapping between hits and SuperStrips",  
 b) track fitting:  $pt, \eta, \phi, d0, z0$

Pixels & SCT  
 RODS

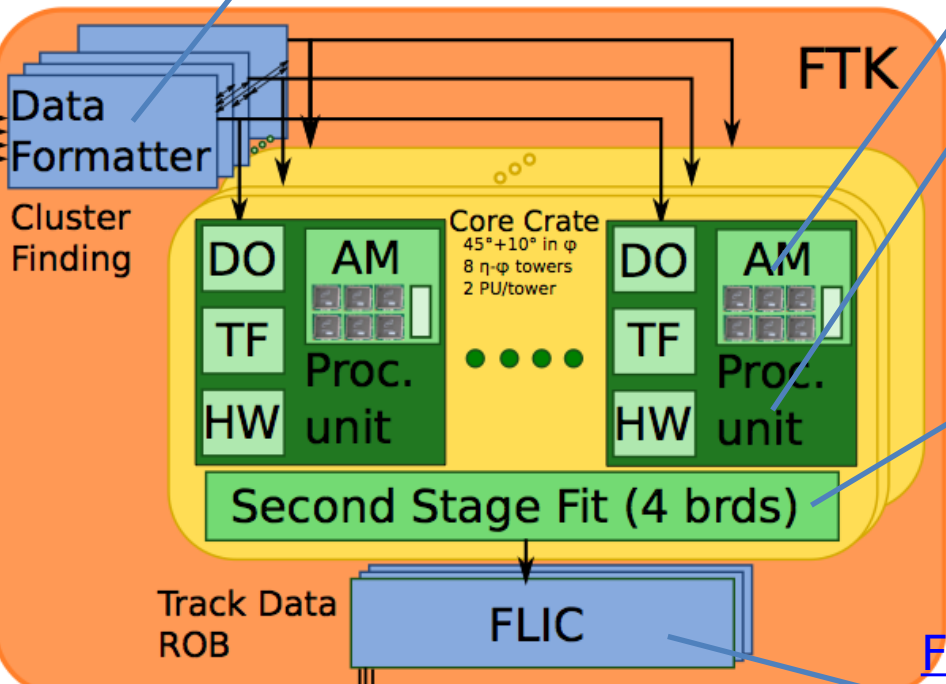

Second Stage Board(SSB)

Reduce the fake track using remaining silicon layers.

FTK to Level2 Interface Crate(FLIC)

Send track info to HLT

\* Red: involvement of the group



Input Mezzanine card(IM)  
+ Data Formatter(DF)

Processor Units: Auxiliary  
card(AUX) +

Associative Memory Board(AM)

Dual HOLA card

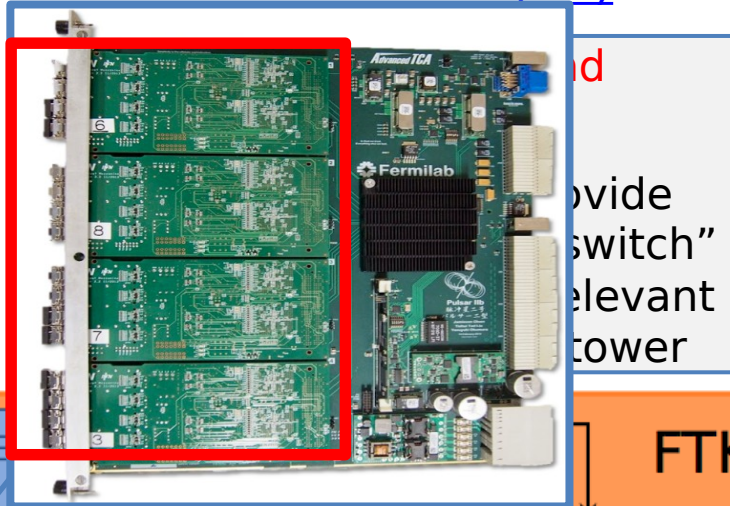
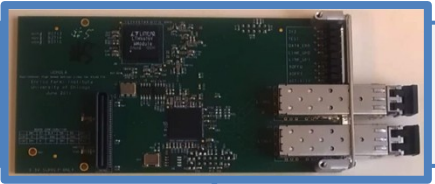

provide  
switch"  
relevant  
tower



Pixels  
& SCT

RODS

Data  
Formatter

Cluster  
Finding

DO

AM

Core Crate  
45°+10° in φ  
8 η-φ towers  
2 PU/tower

DO

AM

TF

Proc.  
unit

TF

Proc.  
unit

Second Stage Fit (4 brds)

Second Stage Board(SSB)

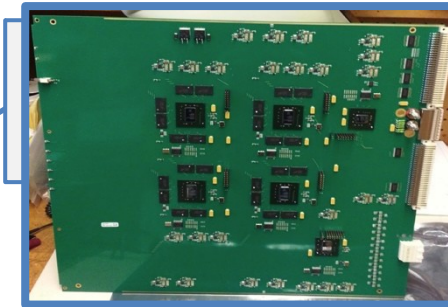

work using  
ers.

100 kHz  
Event  
Rate

Track Data  
ROB

FLIC

FTK to Level2 Interface Crate(FLIC)



Raw Data  
ROBs

FTK ROBs

HLT

Processing

\* Red: involvement of the group

# FTK Schedule

**All boards for the full detector coverage are available at 2018**

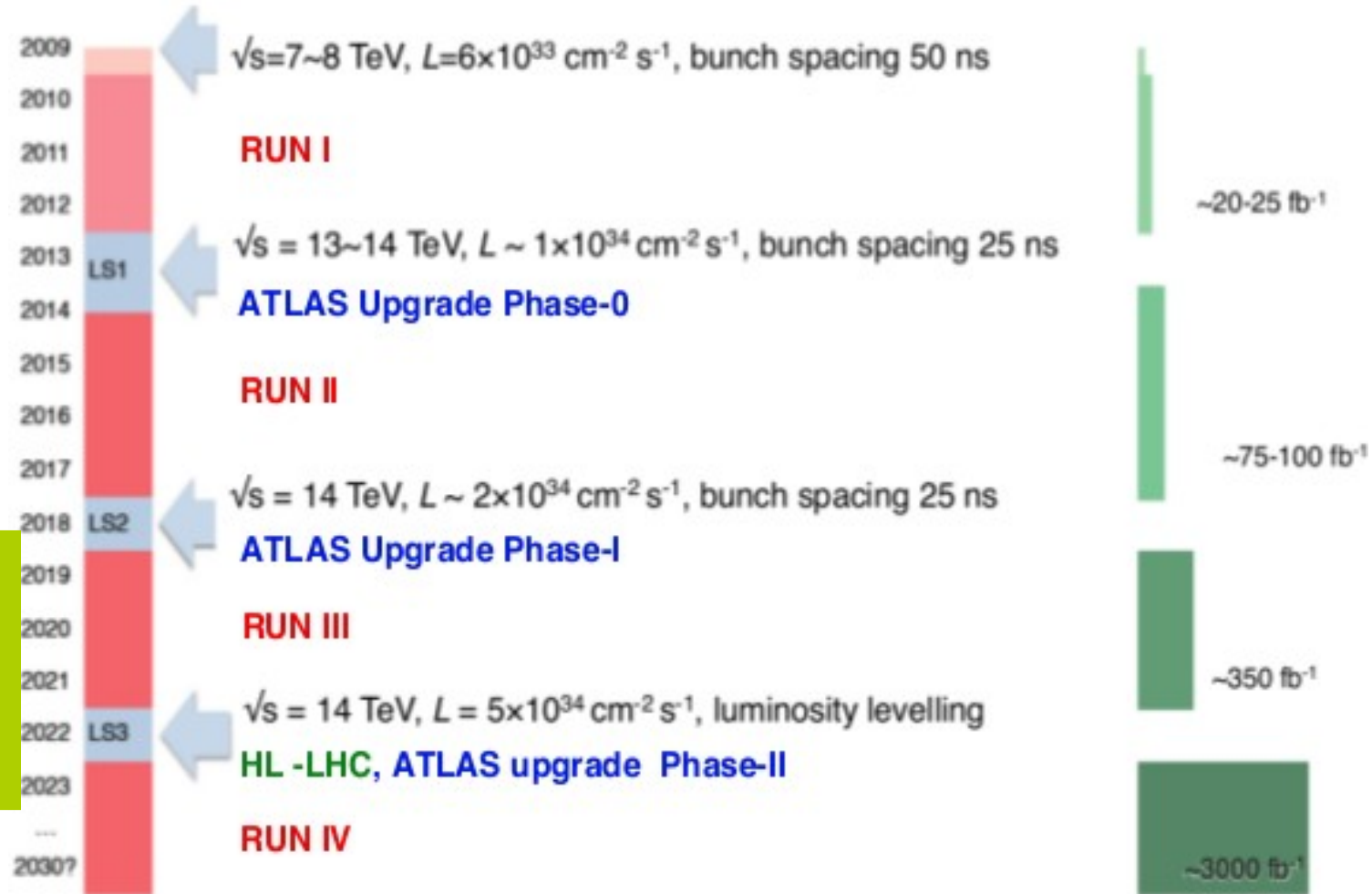

Installation  
 Start data  
 Full detector  
 All boards  
 in place to  
 deal with  
 design  
 lumi

# FTK Latency

FTK has enough processing power at  $L=3 \times 10^{34} \text{cm}^{-2}\text{s}^{-1}$  (operating rate  $\sim 60\%$  )

**Latency was rise-up by heavy event, but after such an event the latency quickly return to the typical range.**

$L=3 \times 10^{34}$  MC sample (Z  $\rightarrow$  mm) @ 100 kHz LVL1 rate.

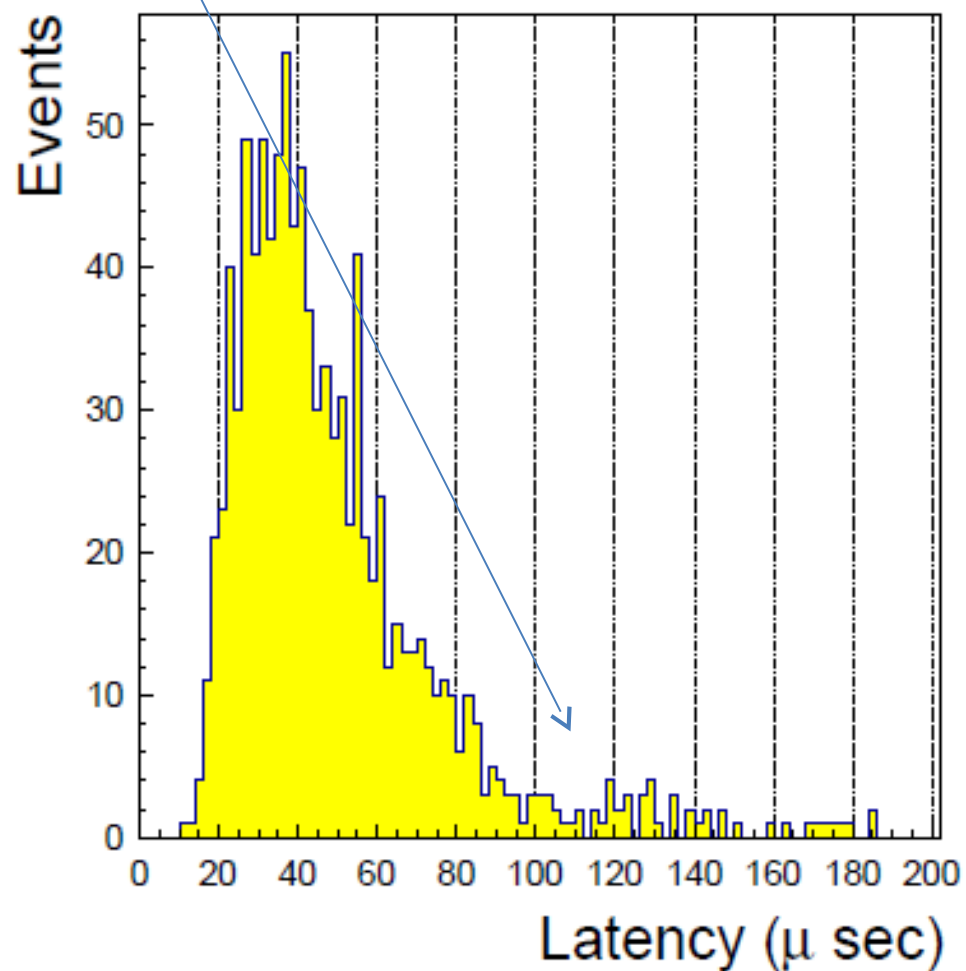
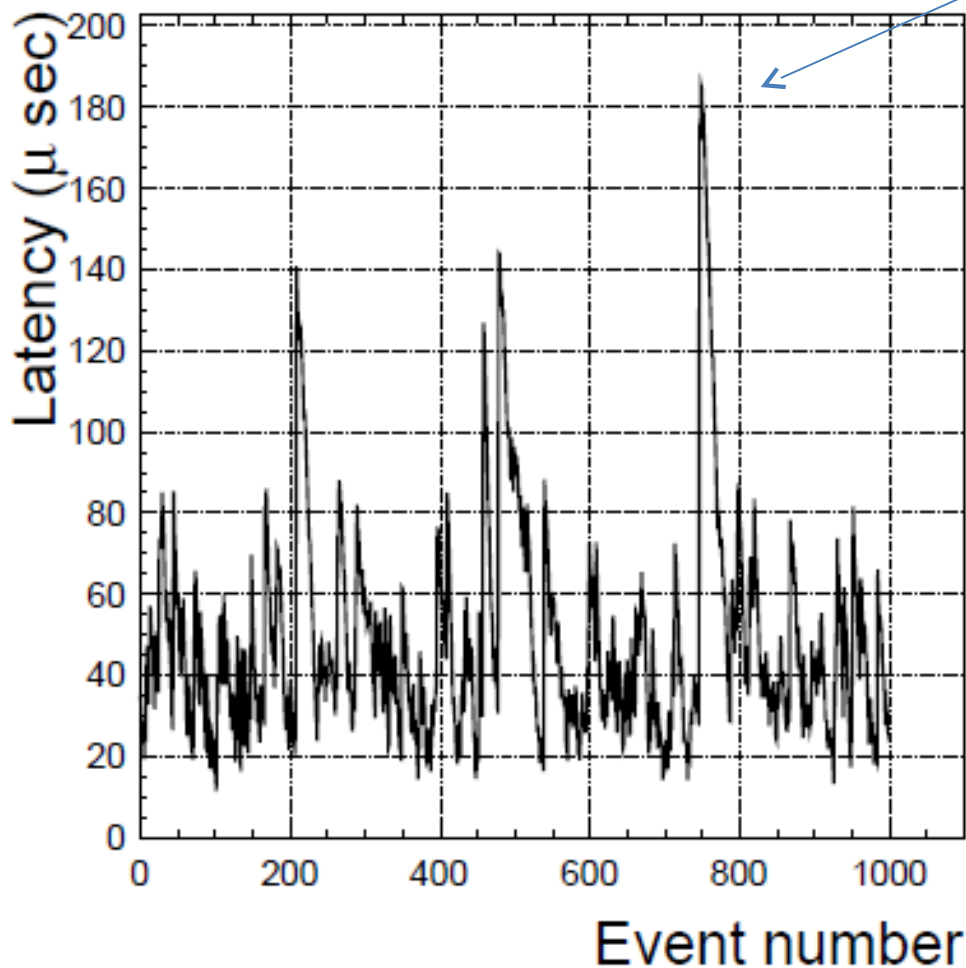

Averagely latency is  $\sim 50 \mu\text{sec}$  and maximum on tail is  $\sim$  few handed  $\mu\text{sec}$ . It is enough speed for HLT requirement.

# FTK Track performance

All results are base line of FTK performance!

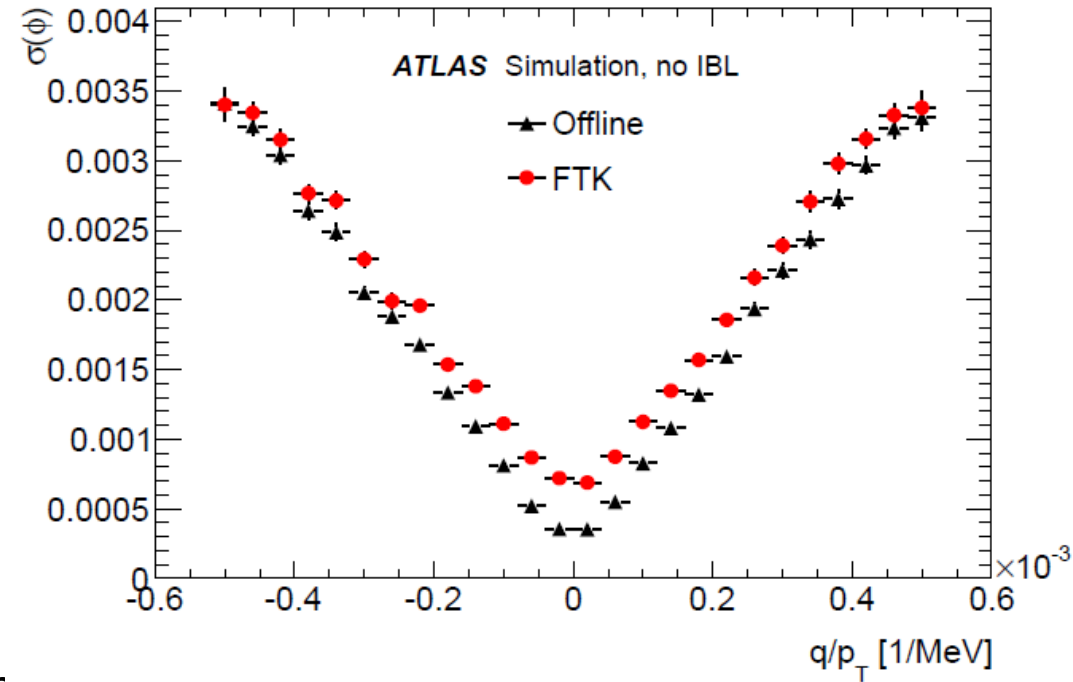
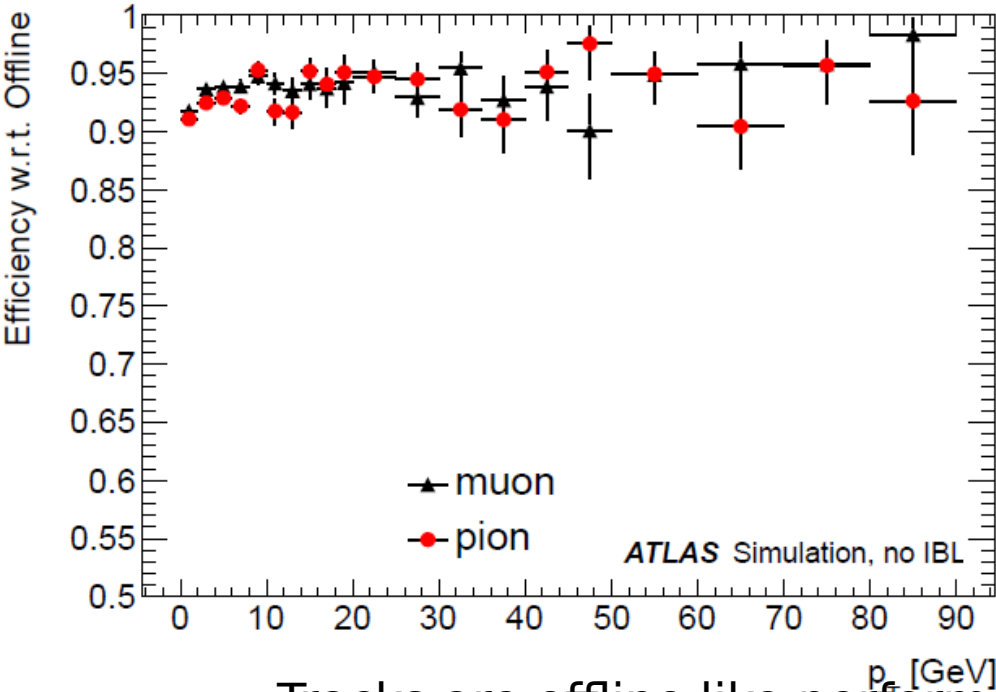

Tracks are offline like performance

Difference is :

- Algorithm of hit clustering
- Lack of Low Pt patterns
- Broken of linear approximation.
- No TRT, not  $\delta$ ray correction, etc

**More than 90 % efficiency with respect to offline.**

# b-jet tag trigger

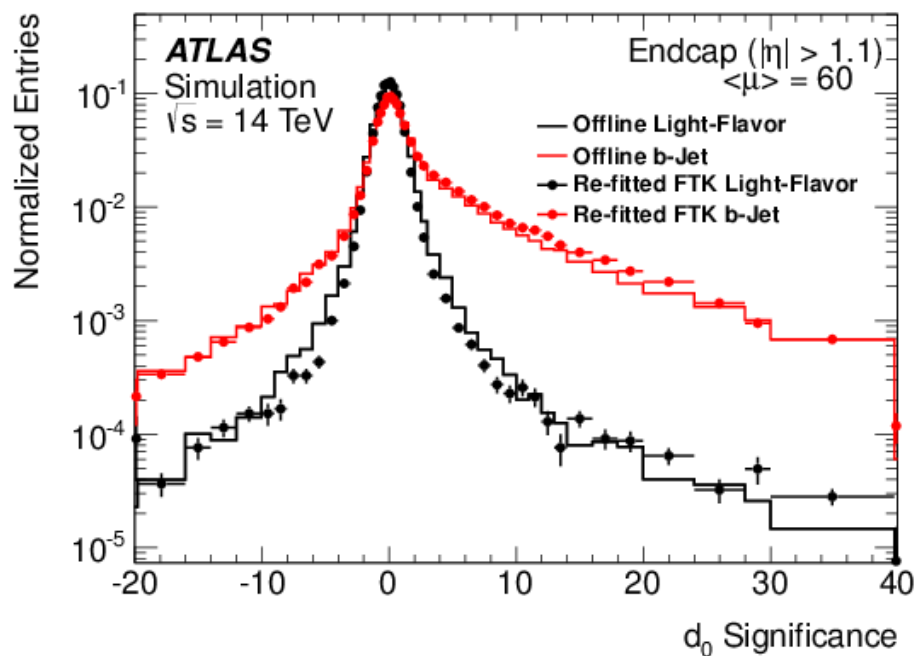
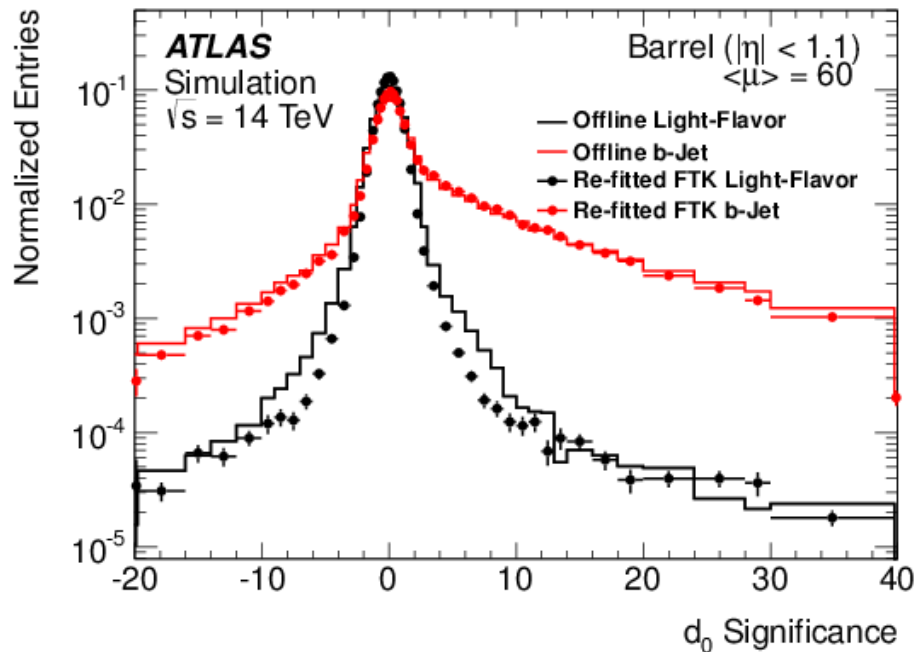

## Base line of FTK!

- With IBL and refit of FTK track
- FTK can be run with Loser HLT jet PT threshold

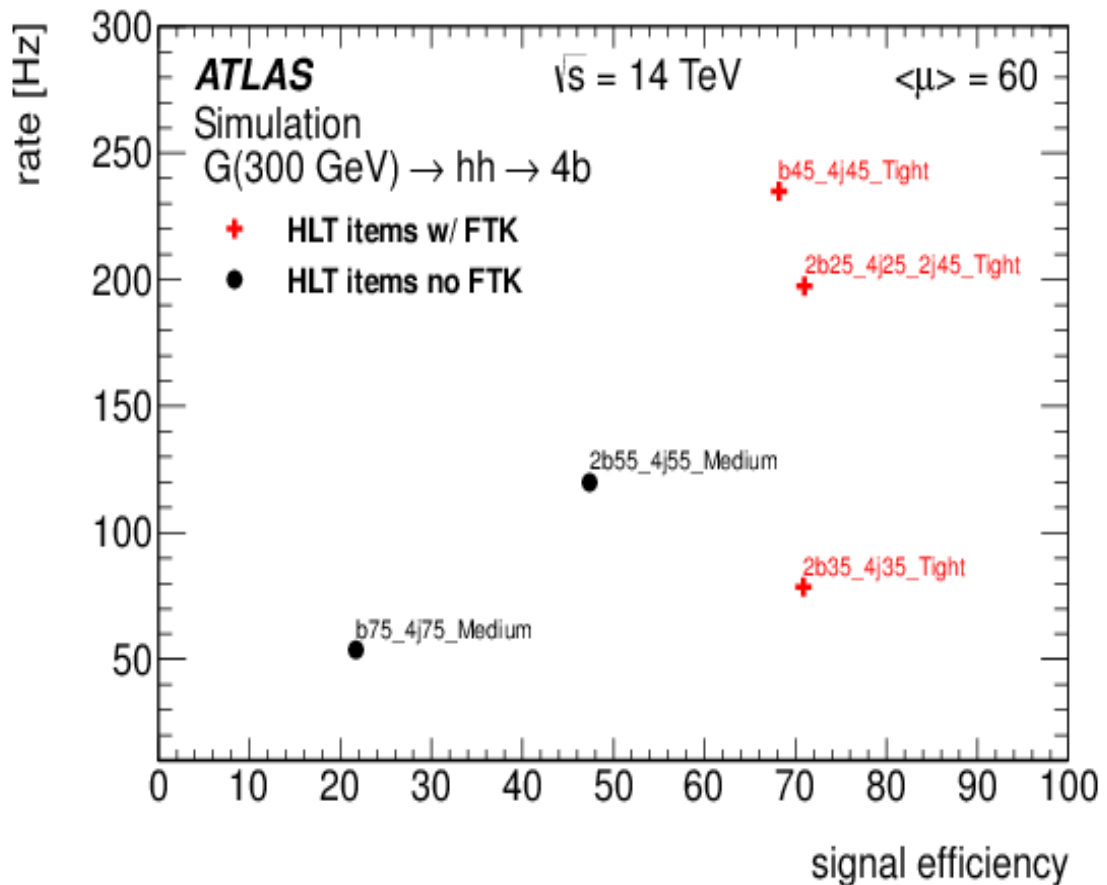



# AM = hits compared to pre-computed patterns

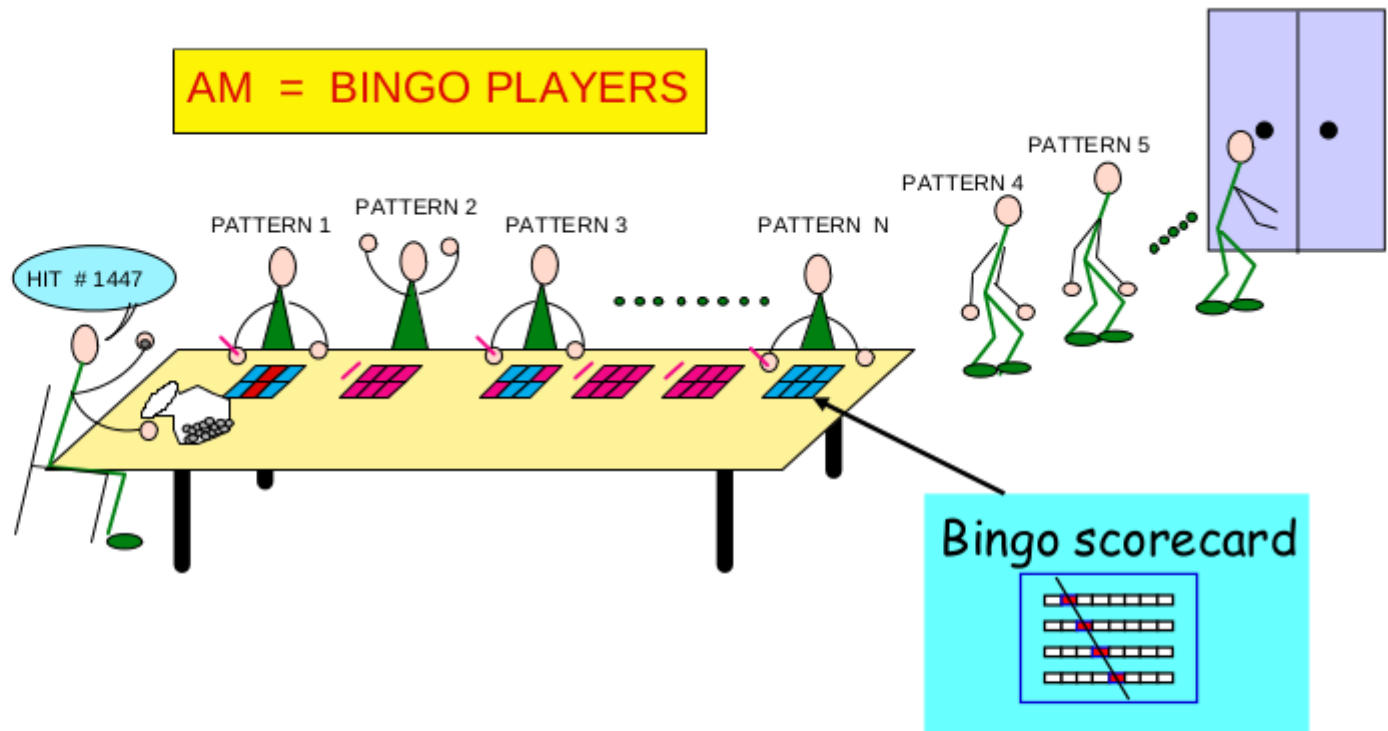

- Dedicated device: maximum **parallelism**
- Each pattern with **private comparator**
- Track search **during** detector **readout**



# Pattern matching: does your event contain any of these patterns?

## Pattern Bank:

<u>Patt0</u>	11	12	14	15
<u>Patt1</u>	06	06	07	07
<u>Patt2</u>	15	17	18	20

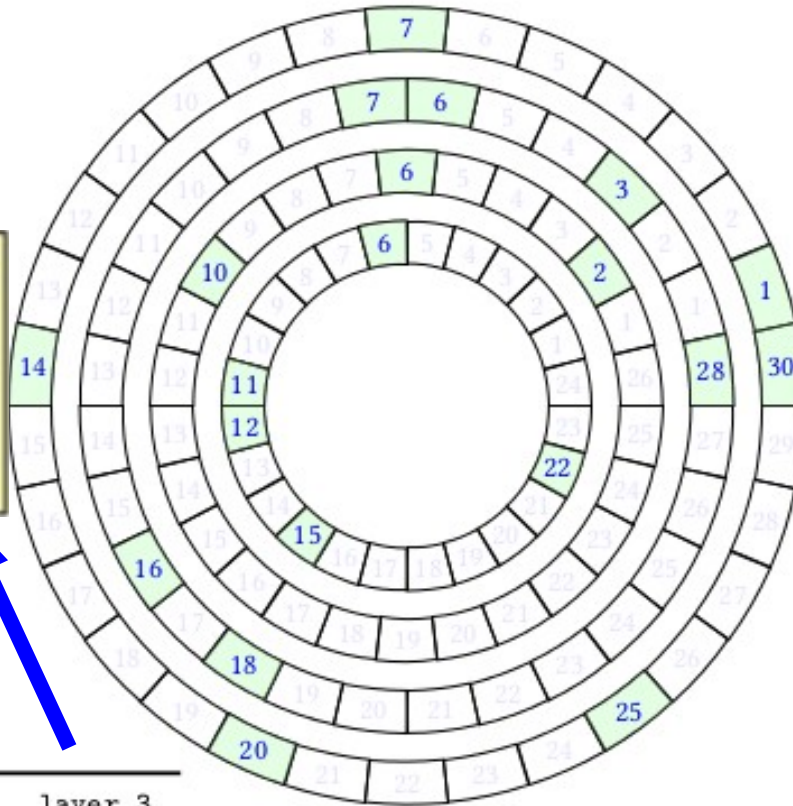

**4. Comparison Of all hits to All patterns at once**

**The event**

layer 0	layer 1	layer 2	layer 3
<b>6</b>	<b>2</b>	<b>3</b> <sup>3</sup>	<b>1</b> <sup>1</sup>

The “event” is a list of hits in each detector **layer**

# Pattern Bank:

Patt0	11	12	14	15
Patt1	06	06	07	07
Patt2	15	17	18	20

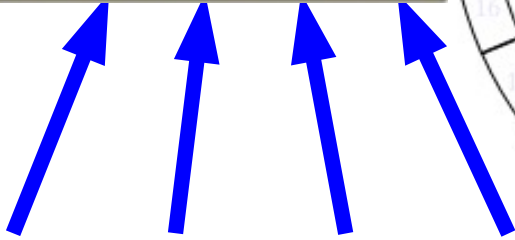
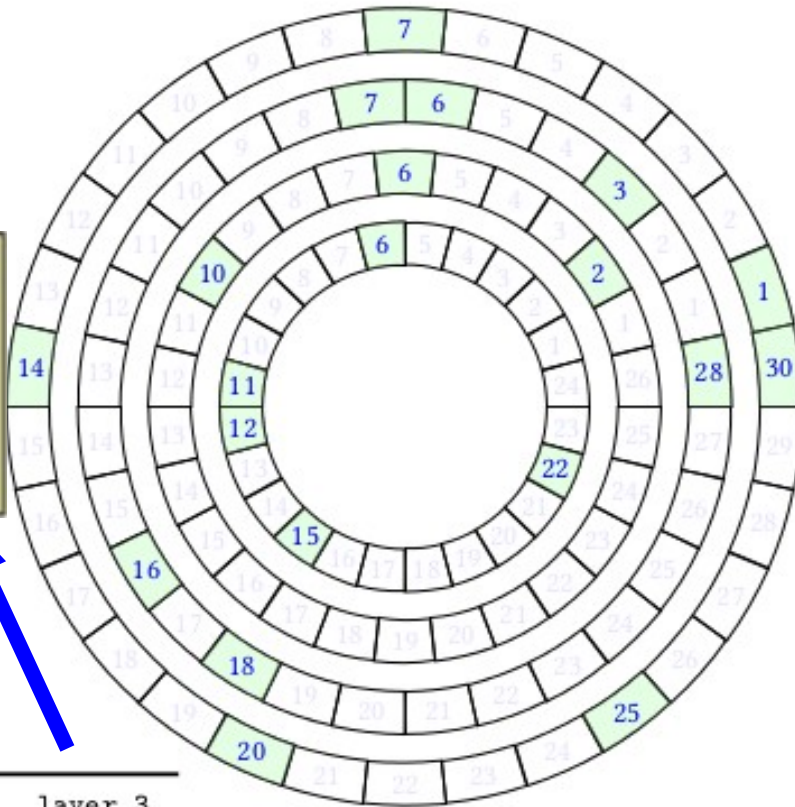

The event

layer 0	layer 1	layer 2	layer 3
<b>6</b>	<b>2</b>	<b>3<sup>3</sup></b>	<b>1<sup>1</sup></b>
<b>11</b>	<b>6</b>	<b>6</b>	<b>7</b>

Compare the hits in each event with ALL the stored patterns.

## Pattern Bank:

Patt0	11	12	14	15
Patt1	06	06	07	07
Patt2	15	17	18	20

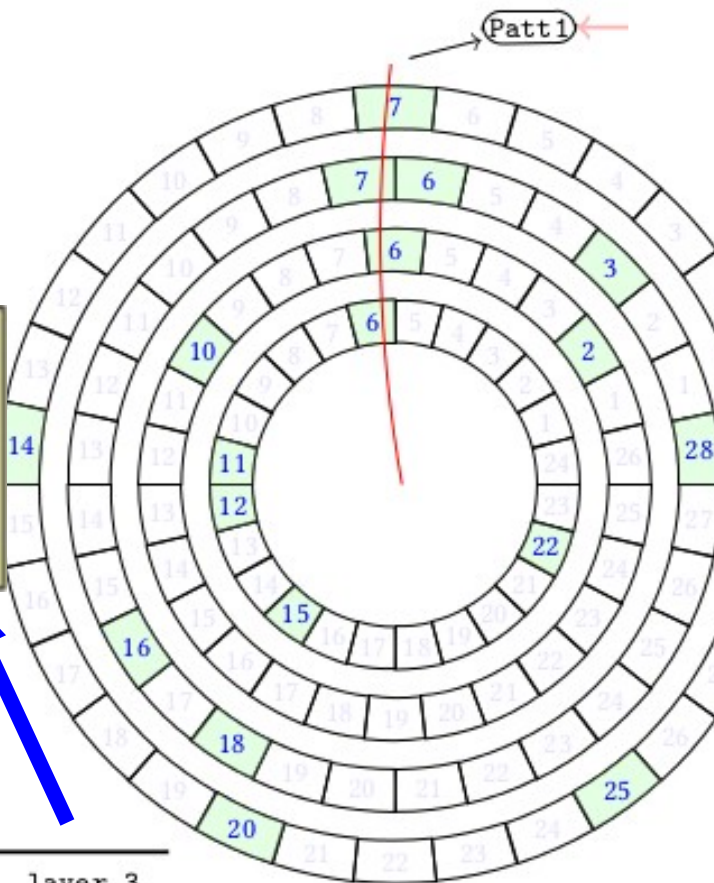

4. After all comparisons are done, we have the **list of matched patterns** in the event = the **list of "roads"** to perform refined tracking after

The event

layer 0	layer 1	layer 2	layer 3
6	2	3	1
11	6	6	7
12	10	7	14
...	...	...	...