

Introduction to detectors and detector readout

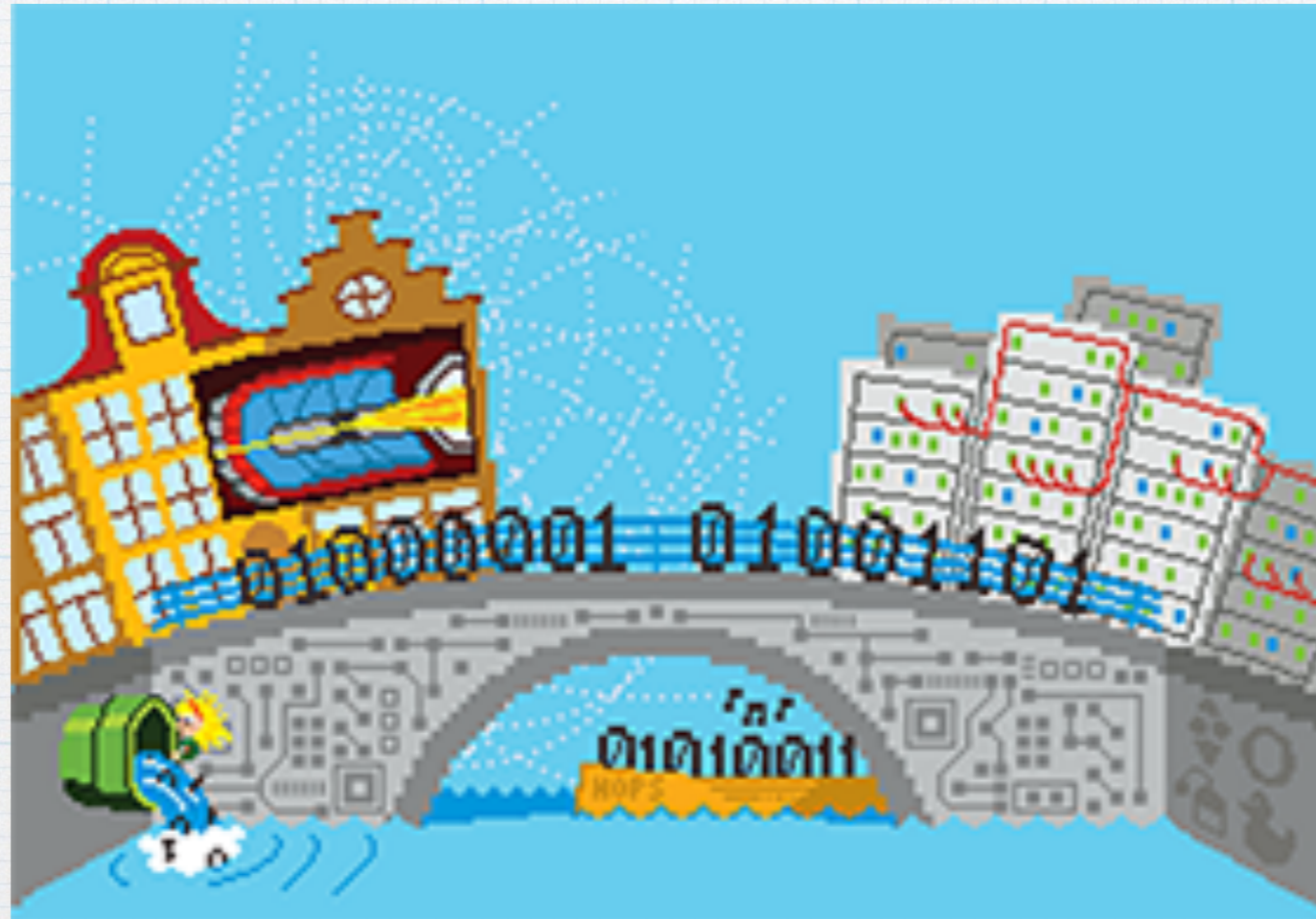

International School of Trigger and Data AcQuisition
29 Jan - 7 Feb 2017,

Gökhan ÜNEL / UCI

ingredients for a Particle Physics experiment

RoadMap + Alleys

* Measure time

- * position, beam profile — tracking
- * Particle momentum, charge — spectrometer

* Measure Yes/No info

- * trigger, accept / veto

* Measure charge

- * Faraday Cup
- * Energy — calorimetry

* Readout Signals

- * buffer, digitize, multiplex

* Care for infrastructure

- * HV/LV PS, Gas and cables!

- Mostly electromagnetic interactions
- A bit of strong interactions
- Very little weak interactions

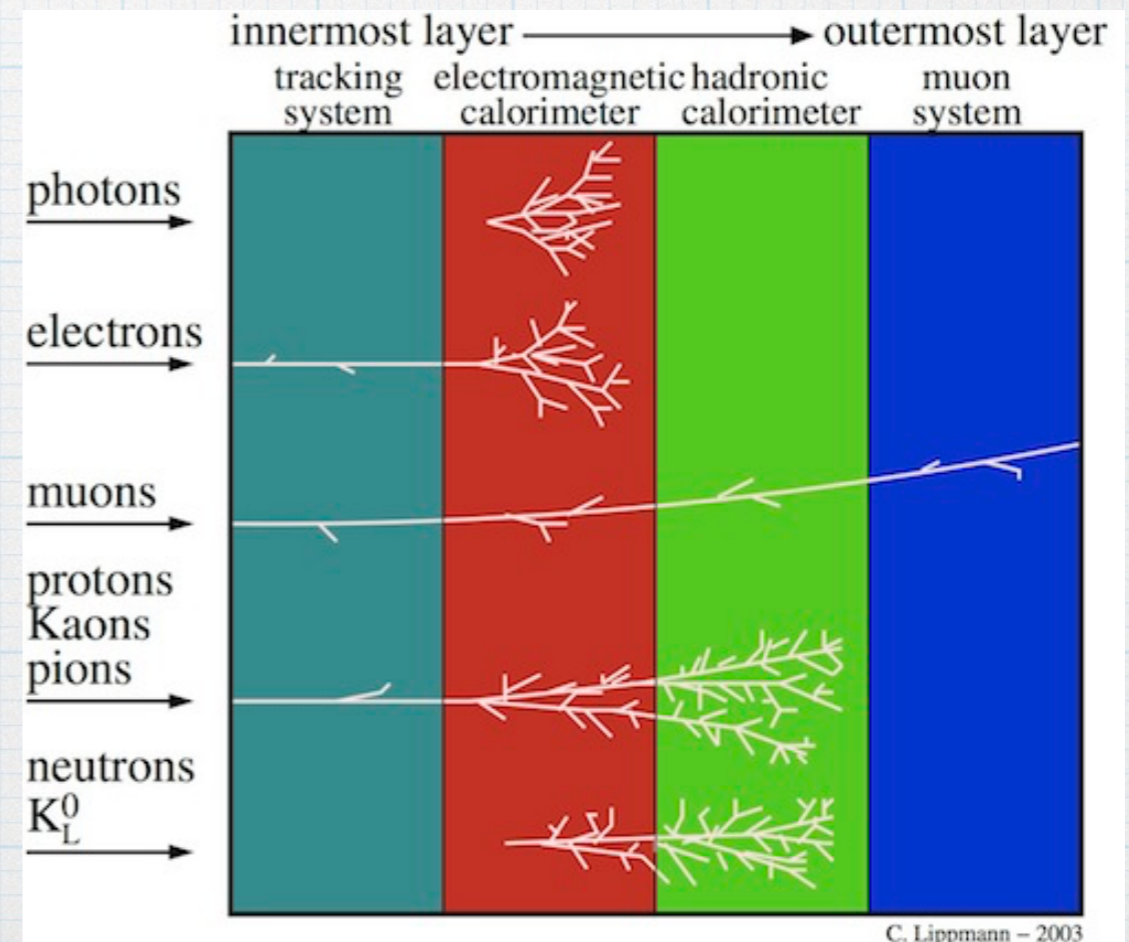

Tracking

- * objects are monitored since the beginning of civilisation.
- * hunters, militia, astronomers...

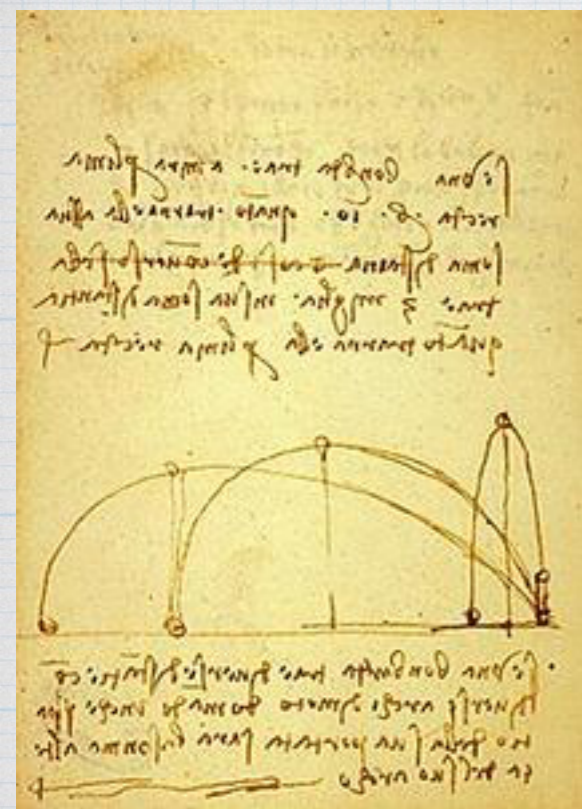

LEONARDO DA VINCI - Studies of the trajectory of the projectiles fired from mortars ~1493

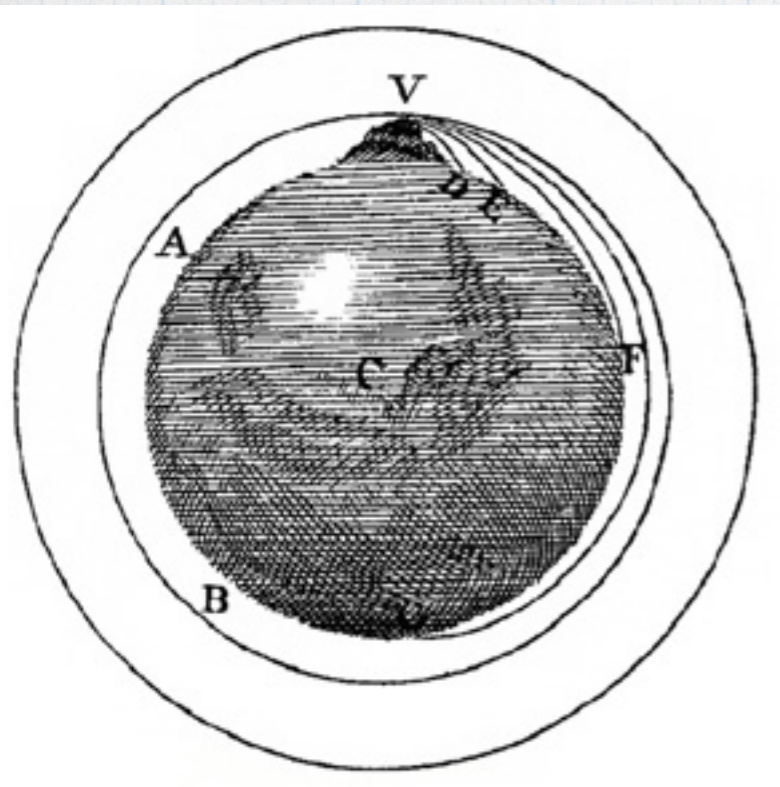
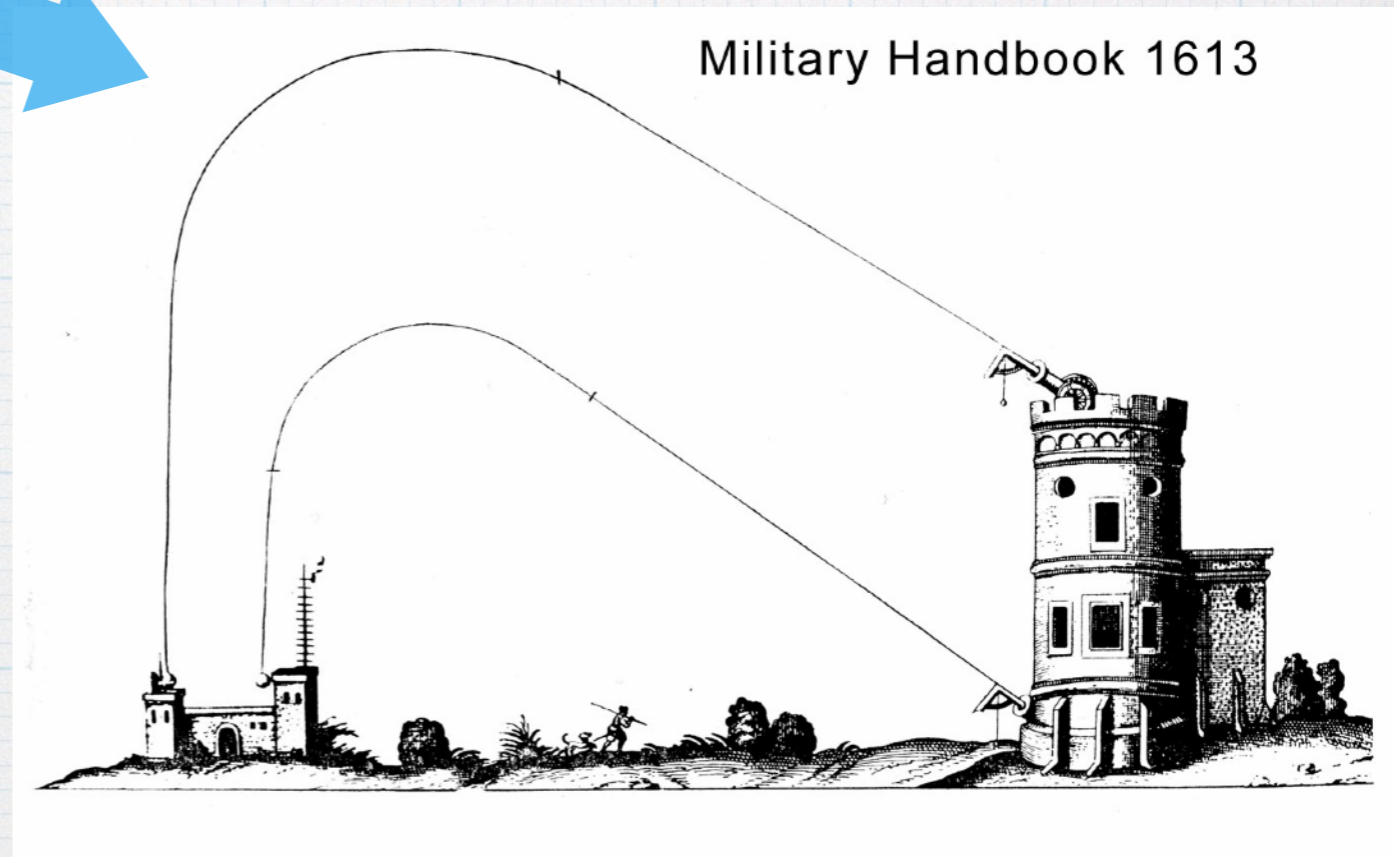

Projectile motion illustrated in *A Treatise of the System of the World* (published posthumously, 1729) by Isaac Newton (1642-1727)

Particle Tracking

* What happens?

- * Ionisation of a medium by a traversing particle.
 - * medium: gas, semiconductor
- * HV (electric field) to transport charges to electrodes (few kV)
 - * electrons move faster wrt ions (30-40 times)
- * Electrons accumulate on the electrodes

* How to read it out?

- * acquire signal from the segmented electrode to read position

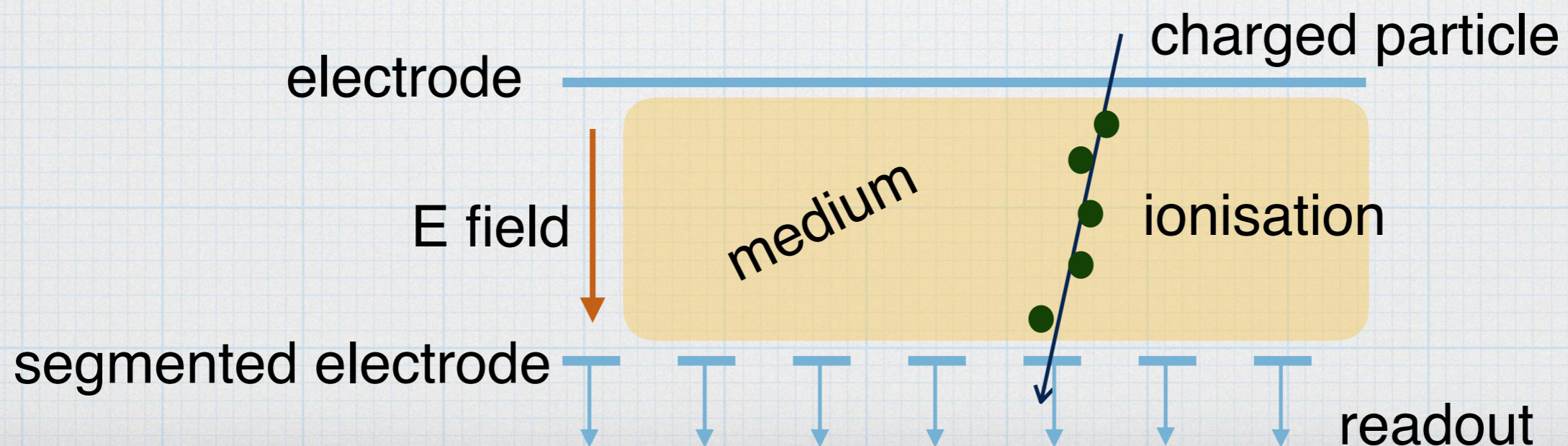

wire chamber as a tracker

- Better positioning: electrode perpendicular to particle track
 - ➔ position: $x = c_0 + c_1\Delta t + c_2\Delta t^2 \dots$
 - ➔ Δt : drift time of electrons to anode wire (under positive HV)
 - ➔ We need a Time to Digital Converter: TDC
- Space resolution: 80 – 200 μm
- “Low mass” (guess?) detectors, can be big: 4m x 2m

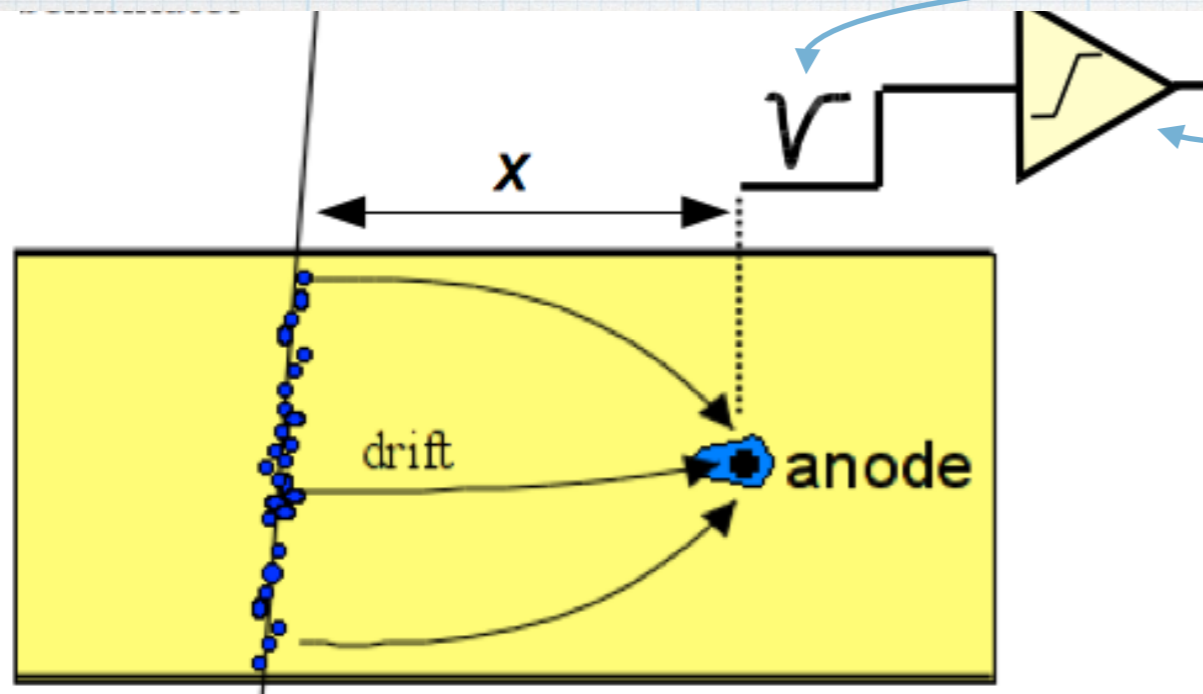

typical signal shape.

need a discriminator to eliminate noise

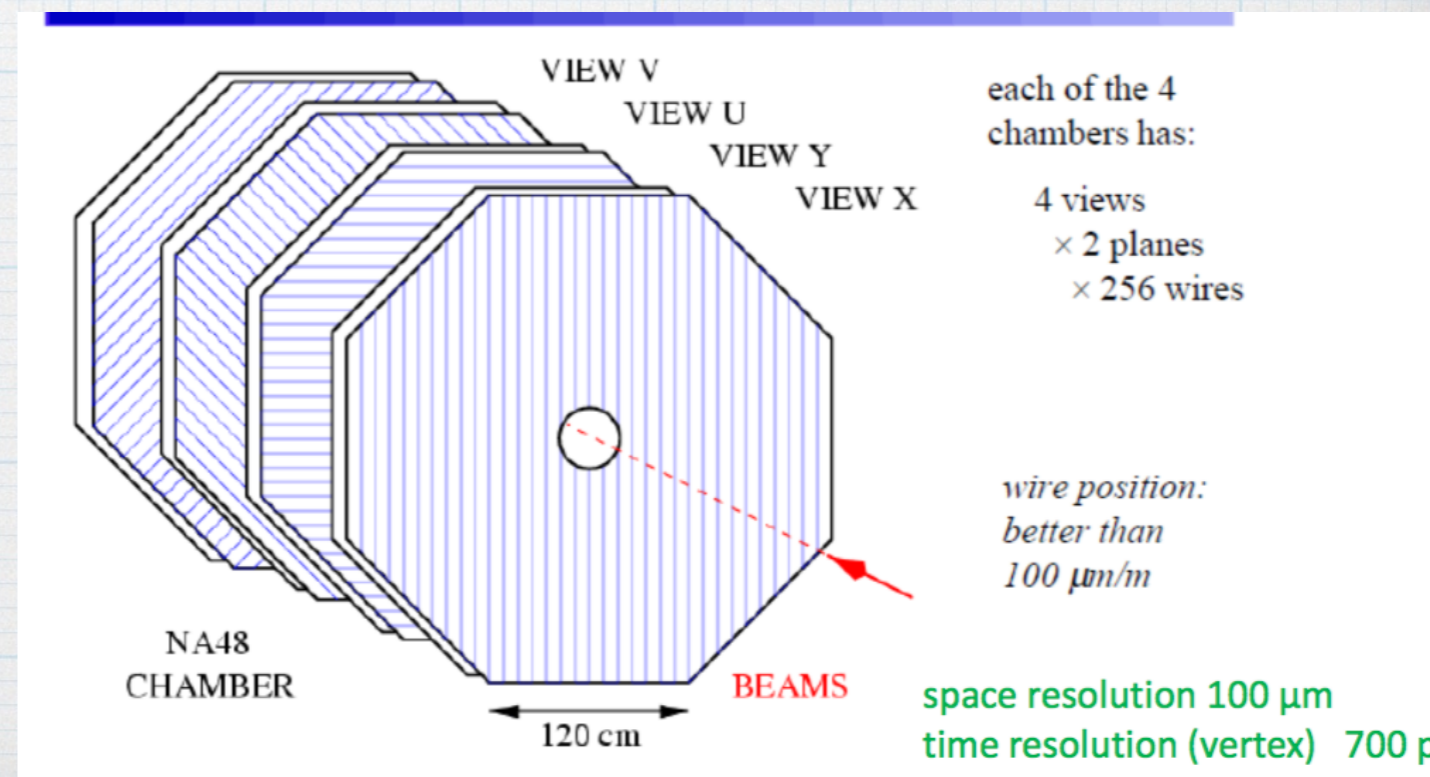

a “wire” chamber stationed at z (typically beam direction) with x - y planes to measure a point in space. u - v planes are often used for redundancy

From tracker to spectrometer

- * The principle: make the charged particle's track curve in a known magnetic field to find its
 - * charge
 - * momentum
- * In a fixed target experiment typically a dipole magnet is used. Bending power must be well known.

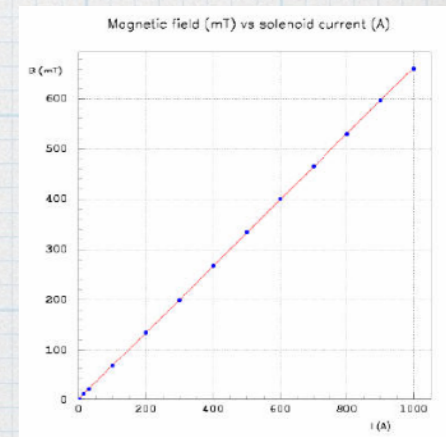
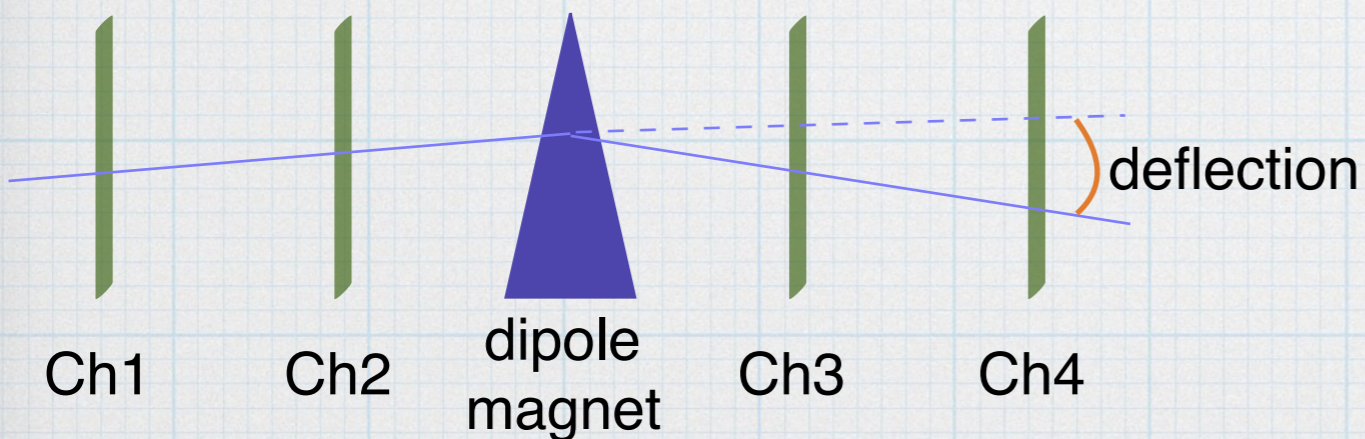

for a constant B field

* measure deflection to find the momentum p perpendicular to the field

* $p(\text{GeV}) = 0.3 Z B(\text{T}) R(\text{m})$

* $p(\text{GeV}) = 0.3 Z B(\text{T}) d(\text{m}) / [2 \sin(\theta/2)]$

* where

* Z: Particle Charge

* d: Field length

* θ : Deflection angle

* R: Curvature Radius

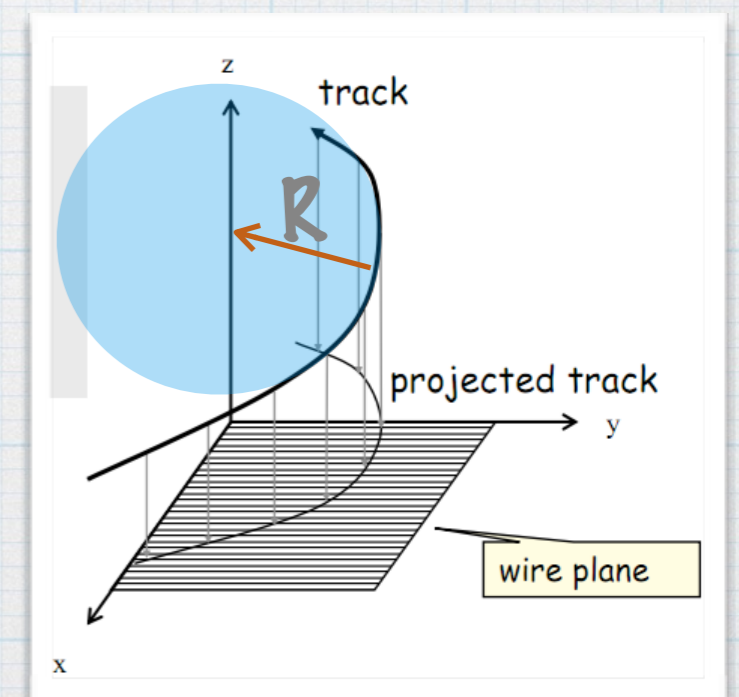
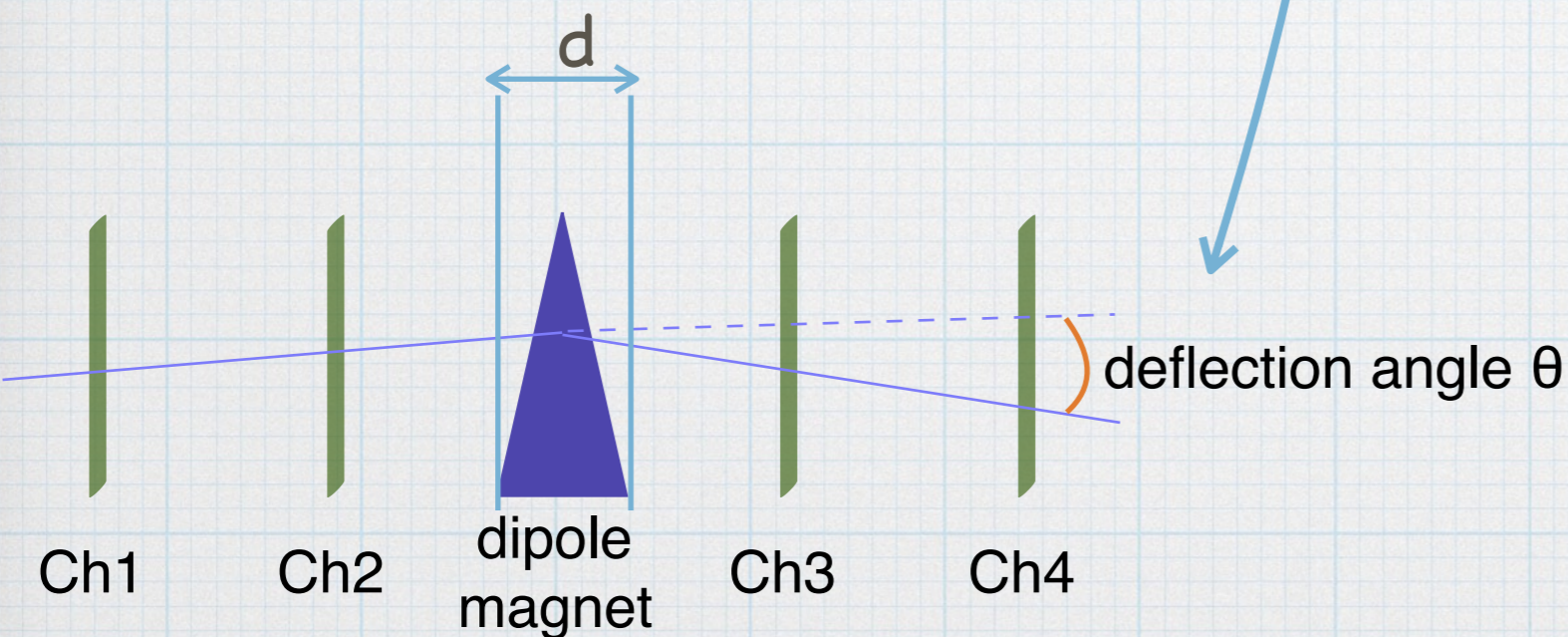

spectrometer for colliding beams

We use solenoid (CMS) and/or toroid (ATLAS) magnets

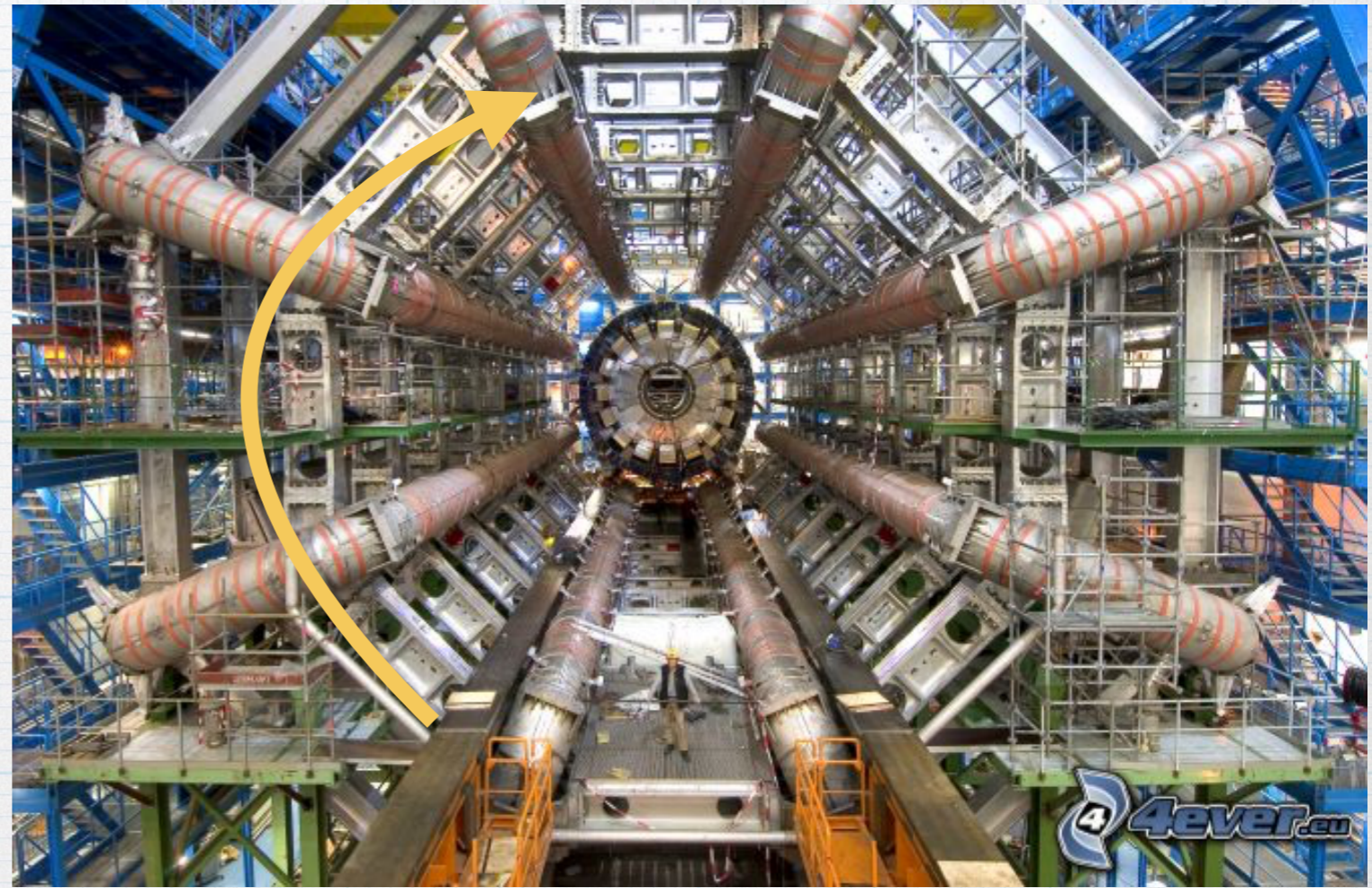
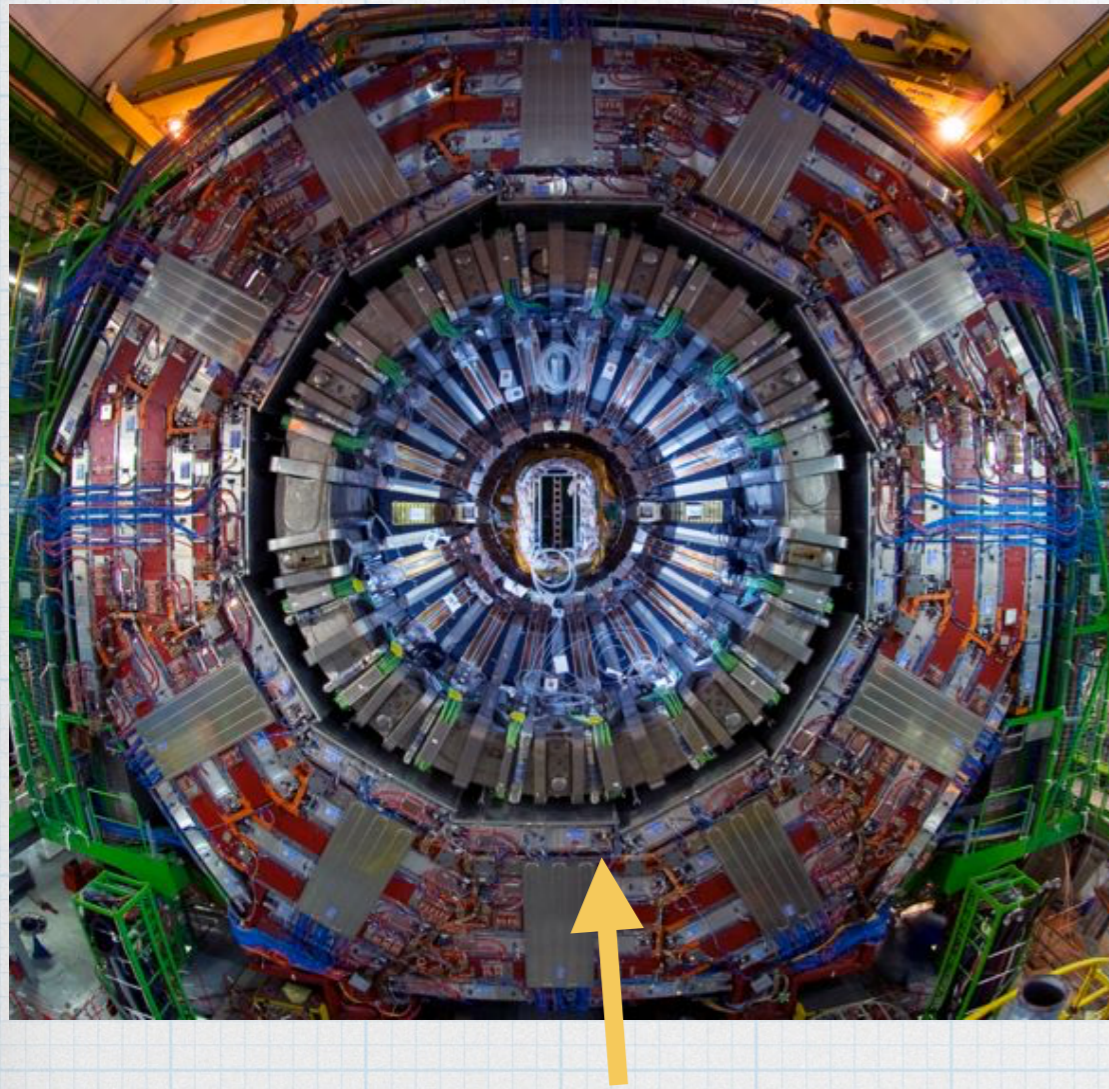

momentum resolution decreases with increasing particle momentum

why?

what about signal height?

Energy loss by ionisation described by Bethe's formula in 1930s

- $\langle dE/dx \rangle$: mean energy loss per unit length of a particle which has
 - charge Z_1 and speed β
 - in a medium with atomic number Z and atomic mass A

$$\left\langle \frac{dE}{dx} \right\rangle = -4\pi r_e^2 m_e c^2 \frac{Z_1^2}{\beta^2} N_A \frac{Z}{A} \times \left[\frac{1}{2} \ln \frac{2m_e c^2 \beta^2 \gamma^2 T_{max}}{I^2} - \beta^2 - \frac{\delta(\beta\gamma)}{2} \right]$$

- I = mean excitation energy of the medium
- T_{max} = maximum energy that can be transferred to the electrons of the medium
- $\delta(\beta\gamma)$ = polarization function of the medium

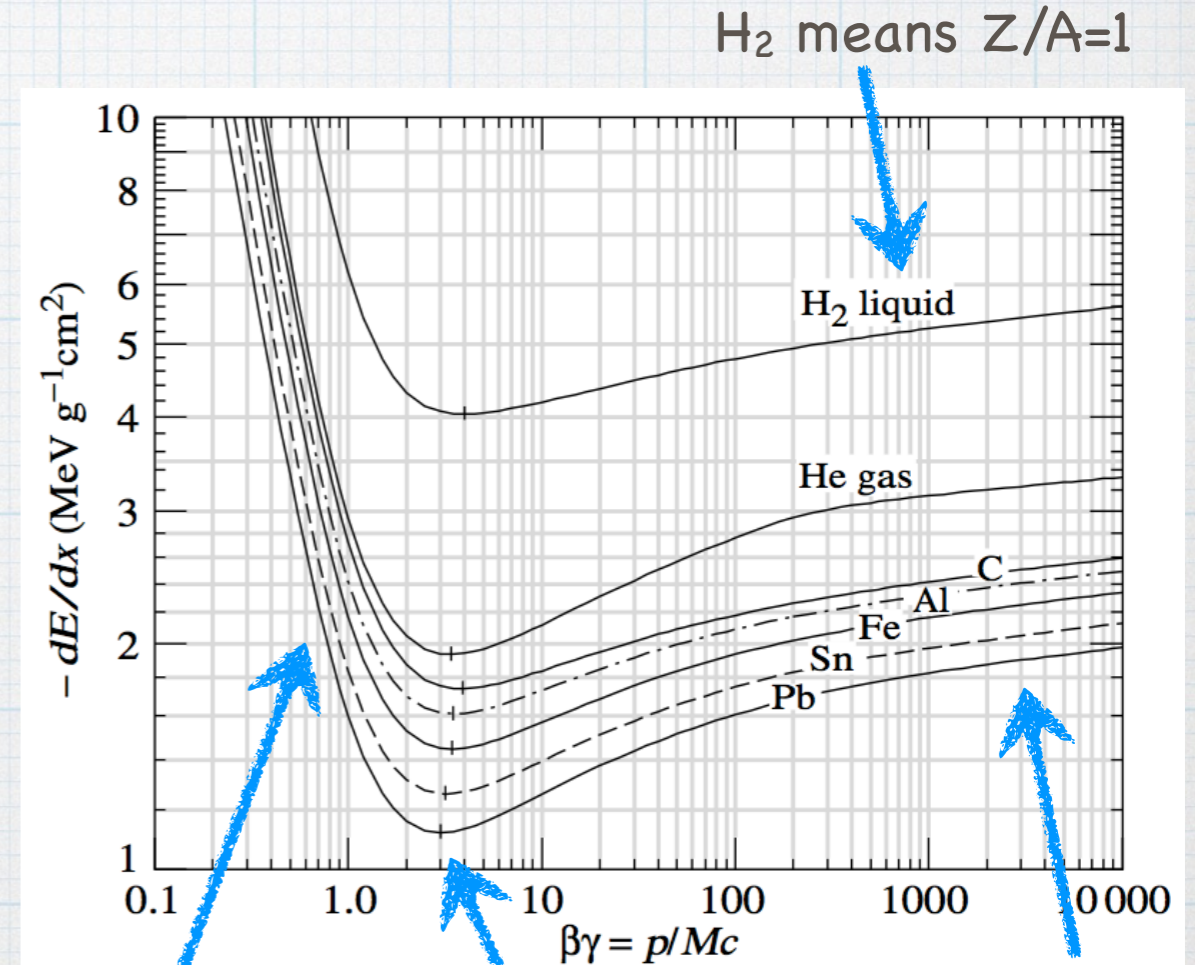
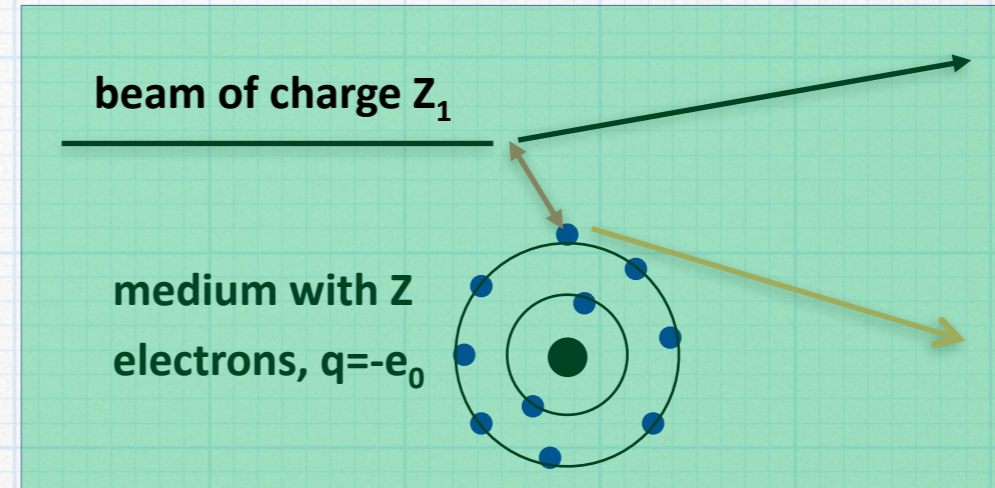

Bethe formula gives the average energy loss. Average, Most Probable Value and Shape Distributions define what happens in real life.

pulse shape can be calculated by Landau theory

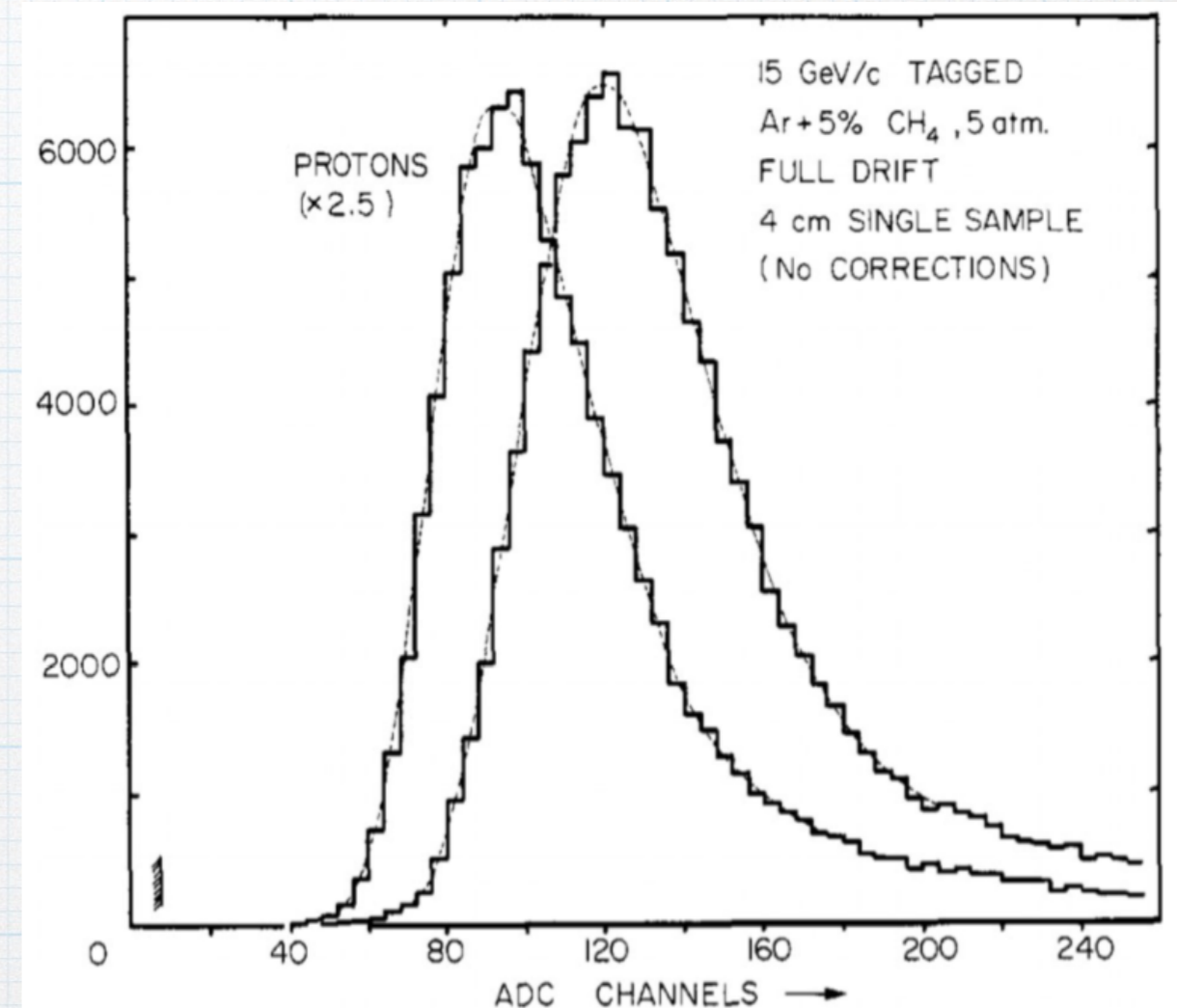
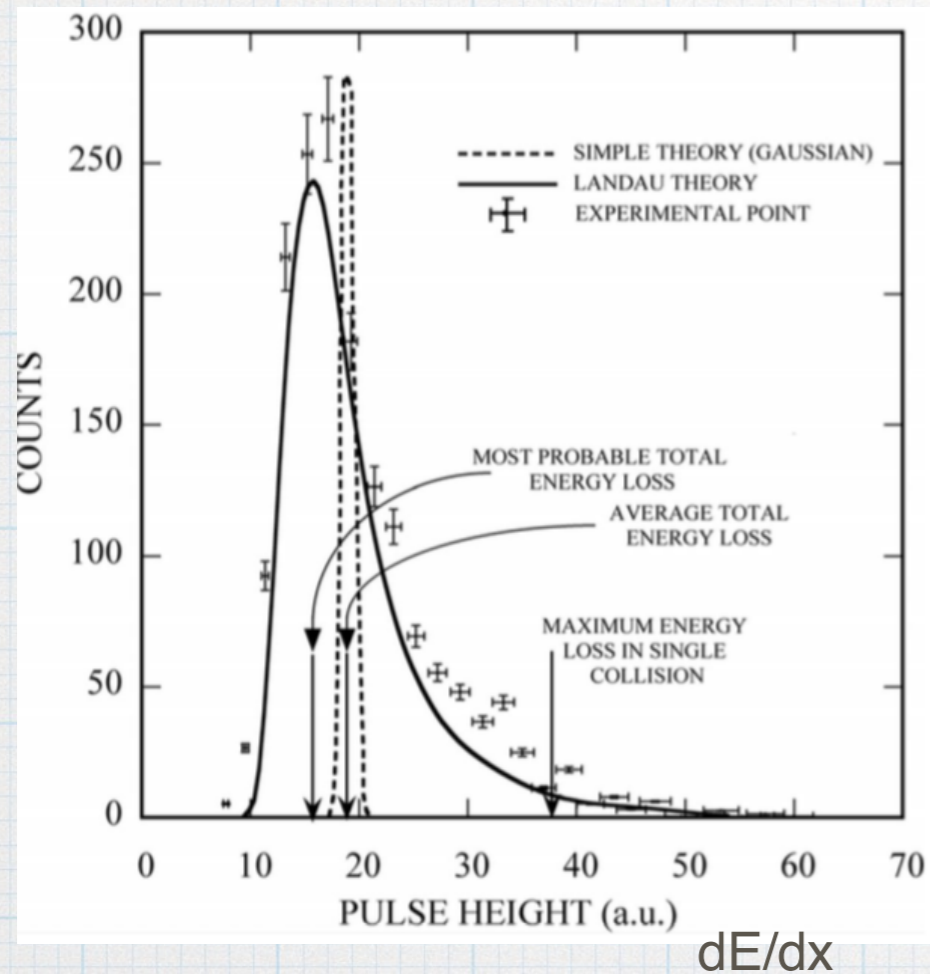

- Accurate measurement of primary ionization cloud is difficult, since the cloud can be quickly smeared by diffusion during its drift to a collecting electrode.
- if the signal height can be acquired, particle energy can be estimated.
 - then particle identification can be made.
- need for detectors reading signal proportional to particle energy

"wire" chambers

* MWPC/ DCh

- * #signal wires = #readout chs
- * precision chamber 80um

* DWC - only 2 ch/plane

- * analog signal delayed & compared - position only
- * resolution about 200um

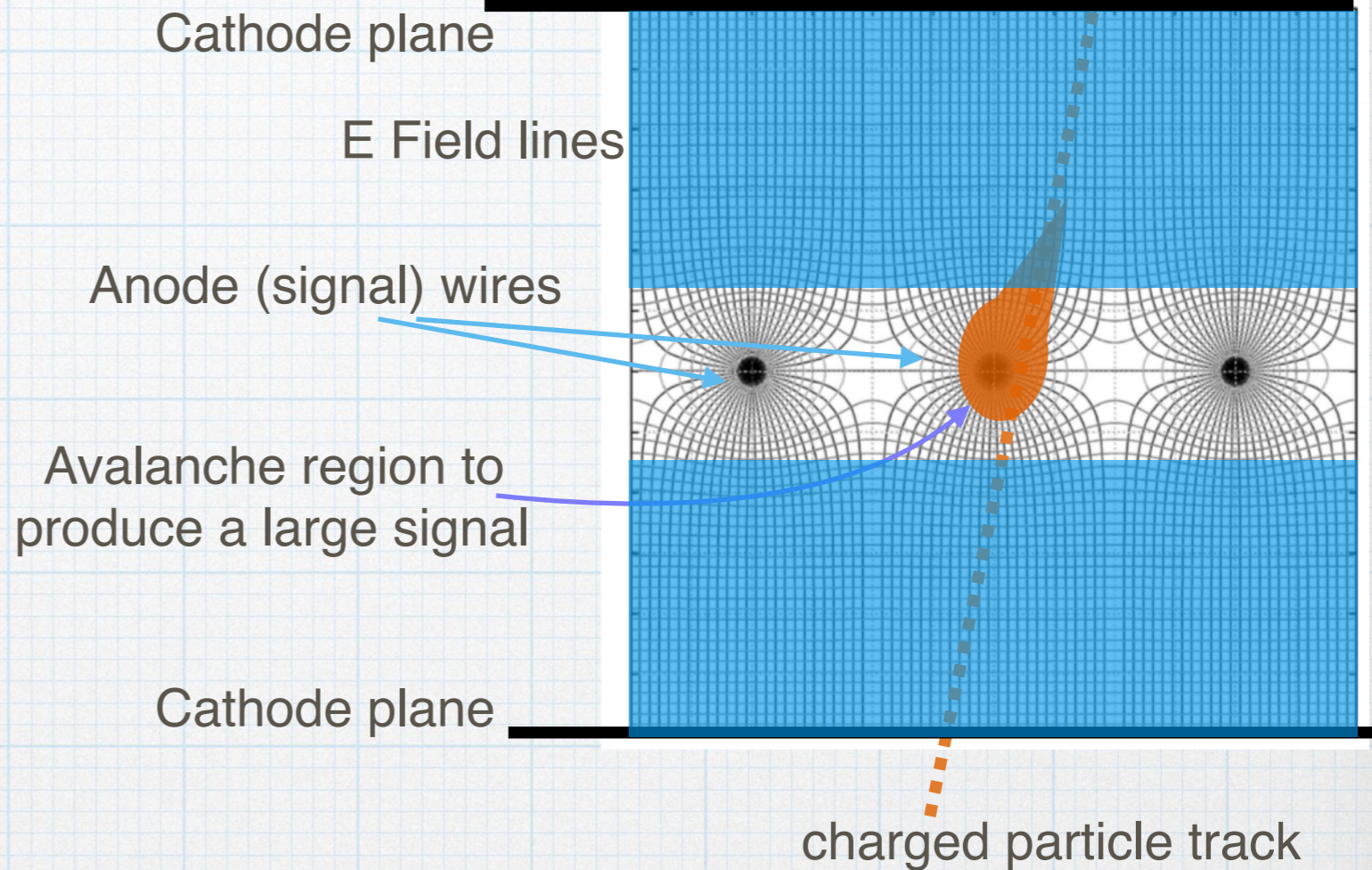
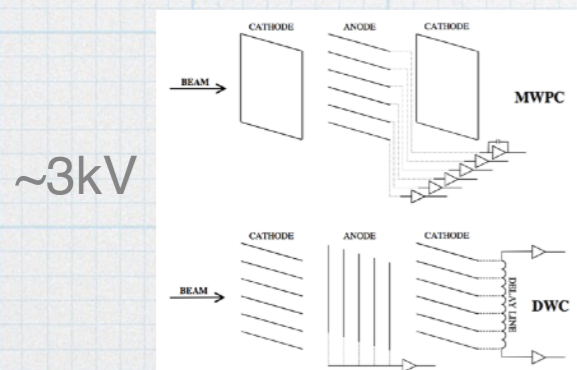

* Resistive Plate Ch - Thin Gap Ch $d(a-c) < d(w-w)$

- * supports a very high rate of 1 - 20 kHz/cm²
- * Trigger chambers with 1cm resolution

- * RPC: C2F4H2(97%) - i-C4H10
- * TGC: CO2(55%)- i-C5H12

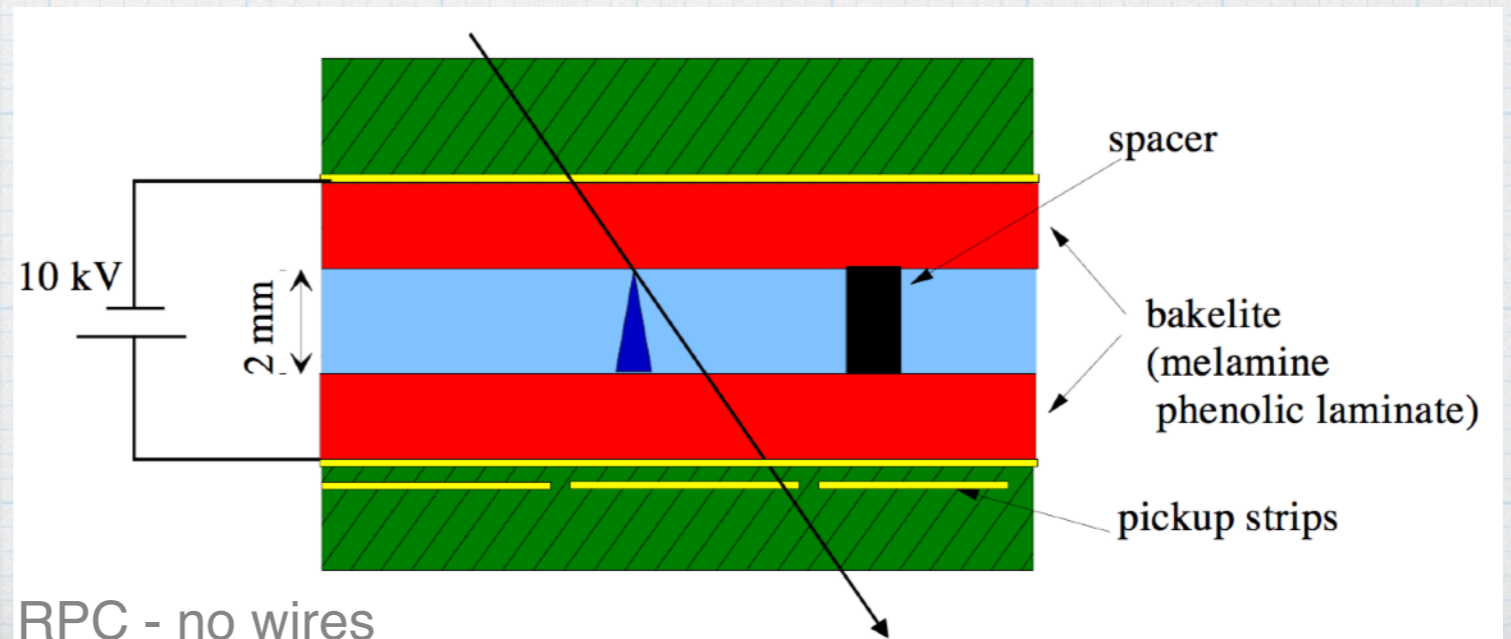

* Time Projection Ch

- * 3D tracking + Energy

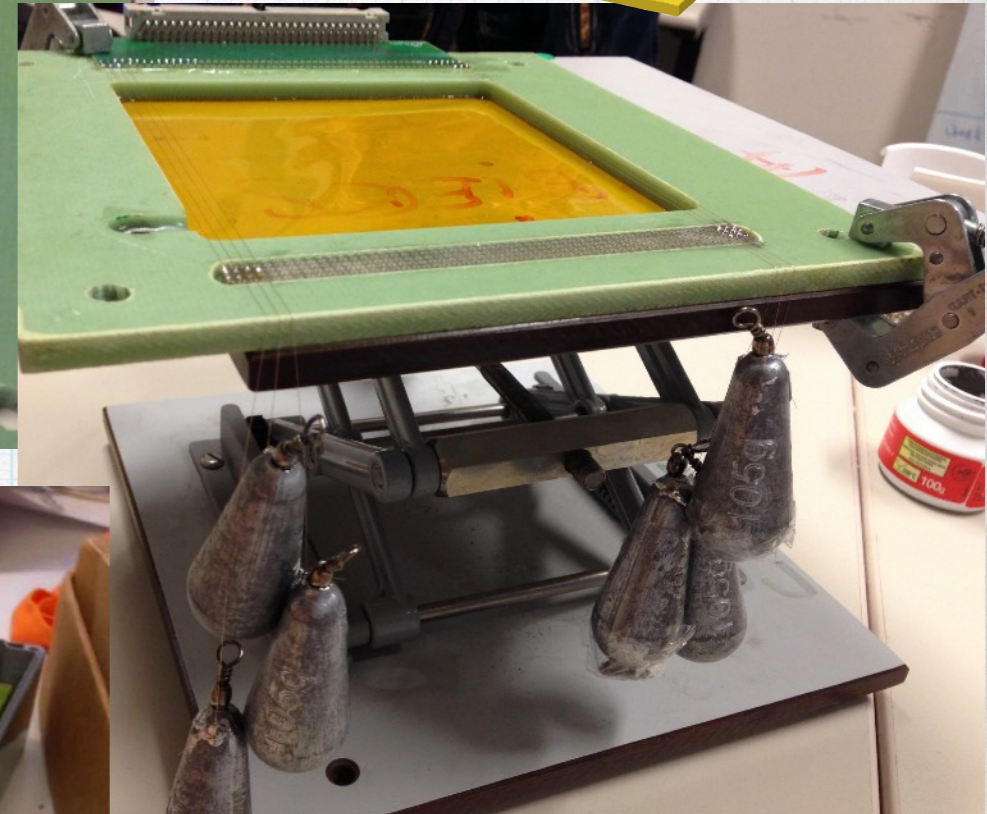
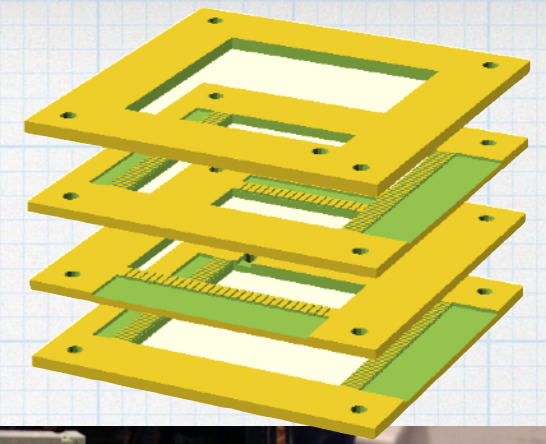

DWC alley

build your own DWC

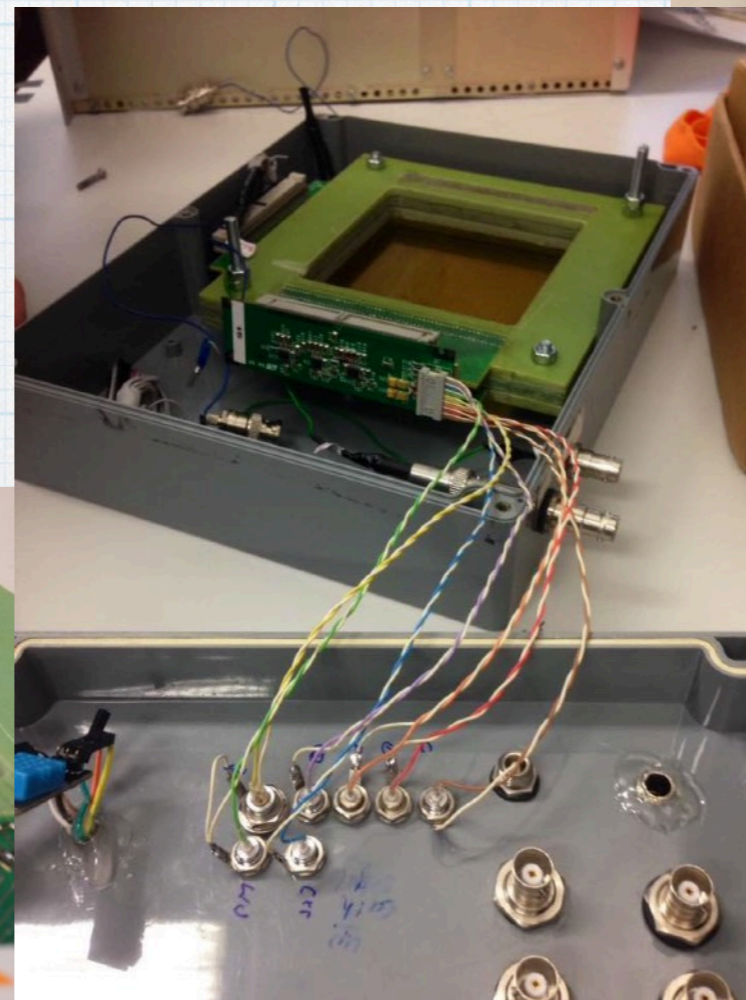
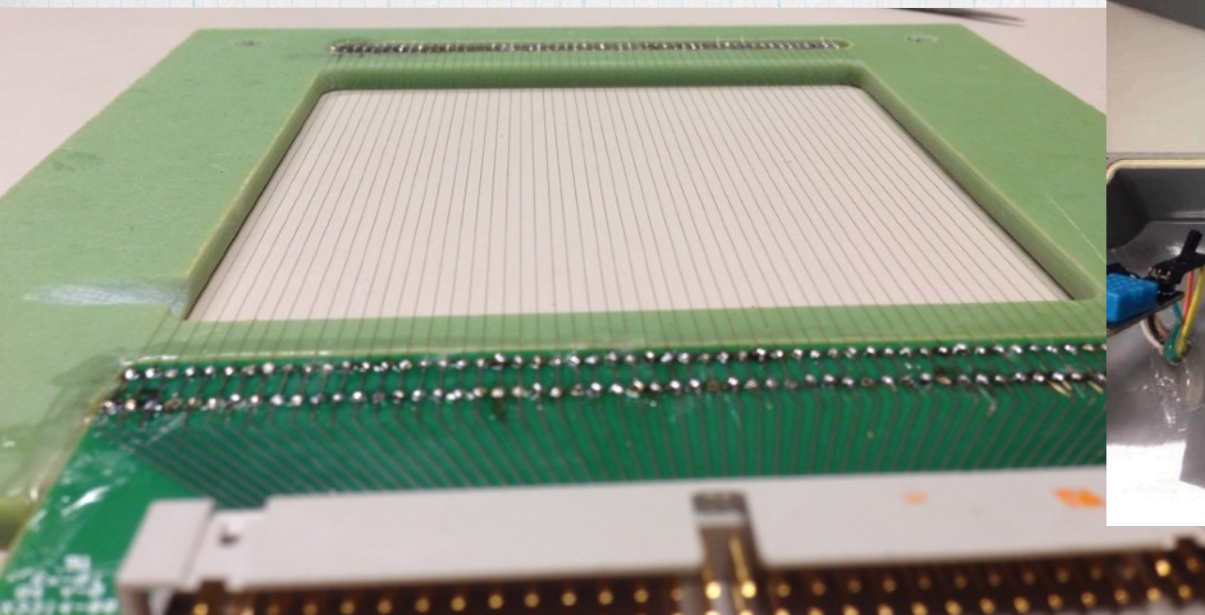

with Sr90 β source

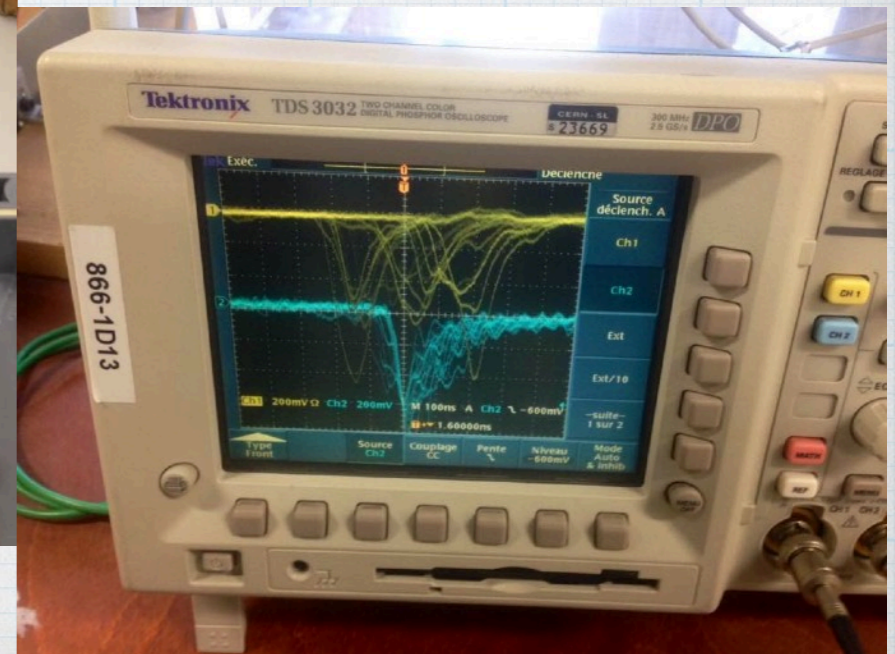

Time Projection Ch

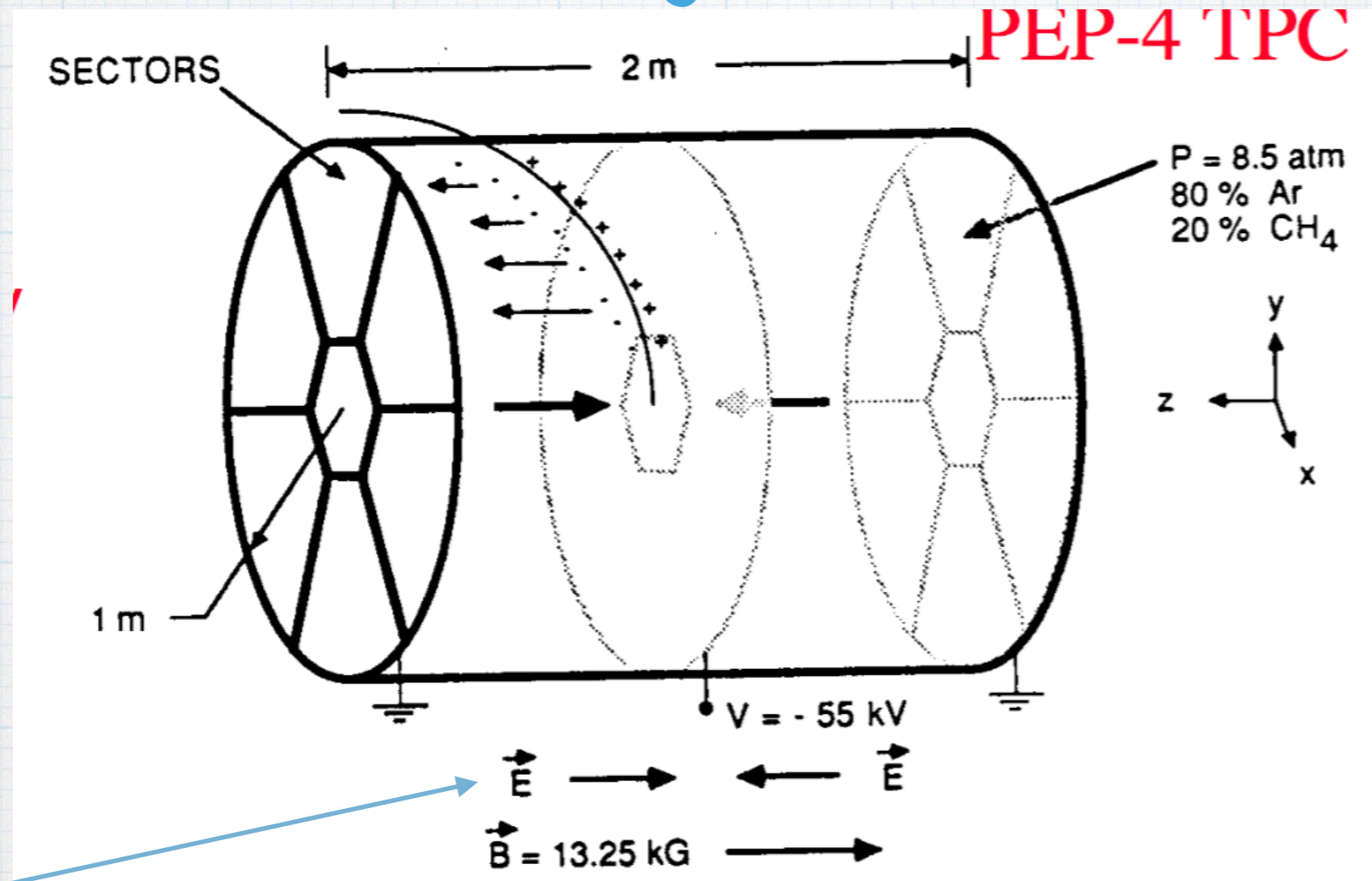

downside of TPC?

- E field to drift electrons towards the MWPCs at the both ends of the cylindrical volume.
 - wire coordinates give x-y positions of the track
 - signal timing gives z position of the track
 - signal amplitude gives $dE/dx \rightarrow$ energy information
- B field parallel to E field curves the ionization track
 - momentum information can be extracted

particle
identification

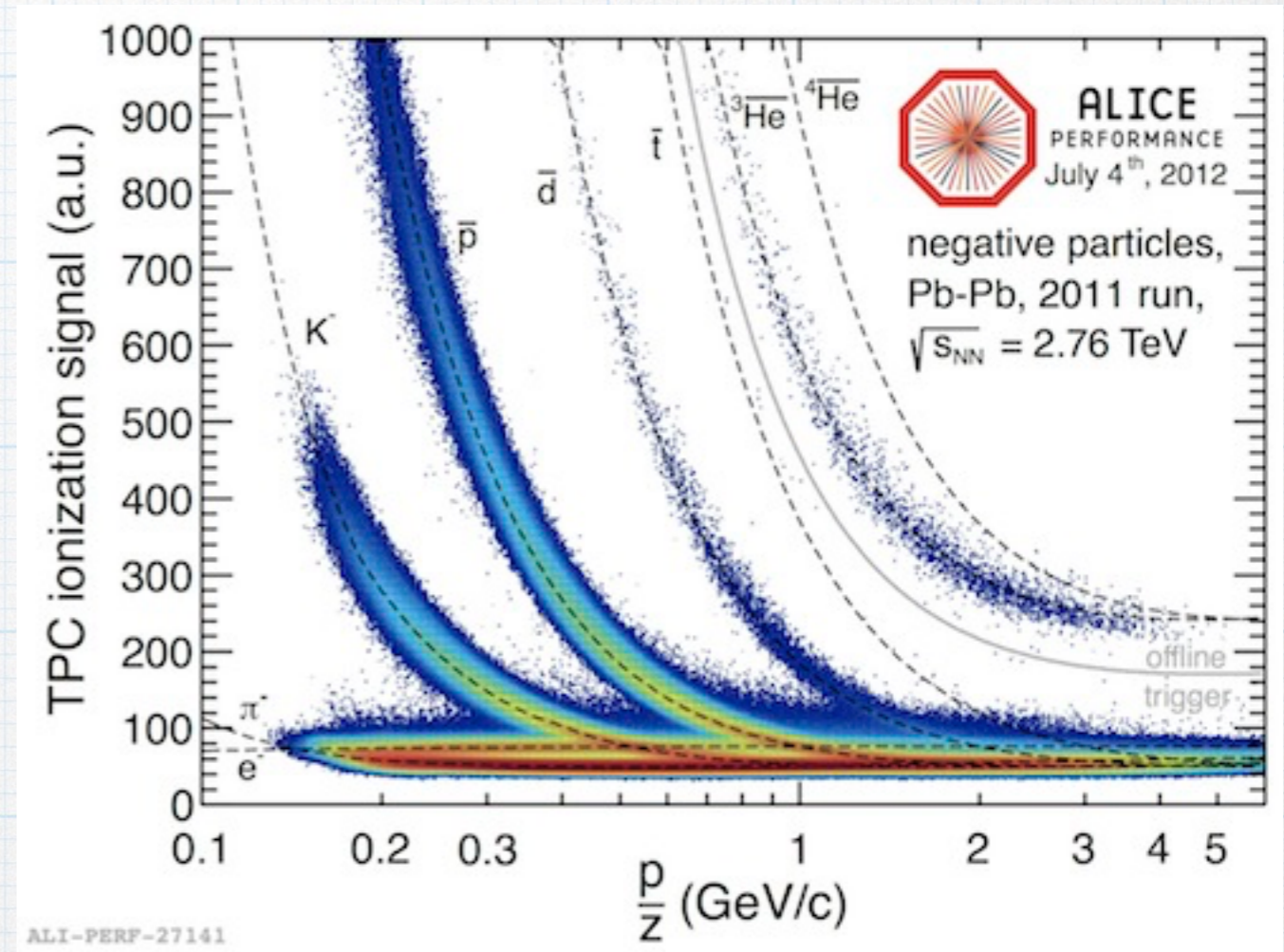
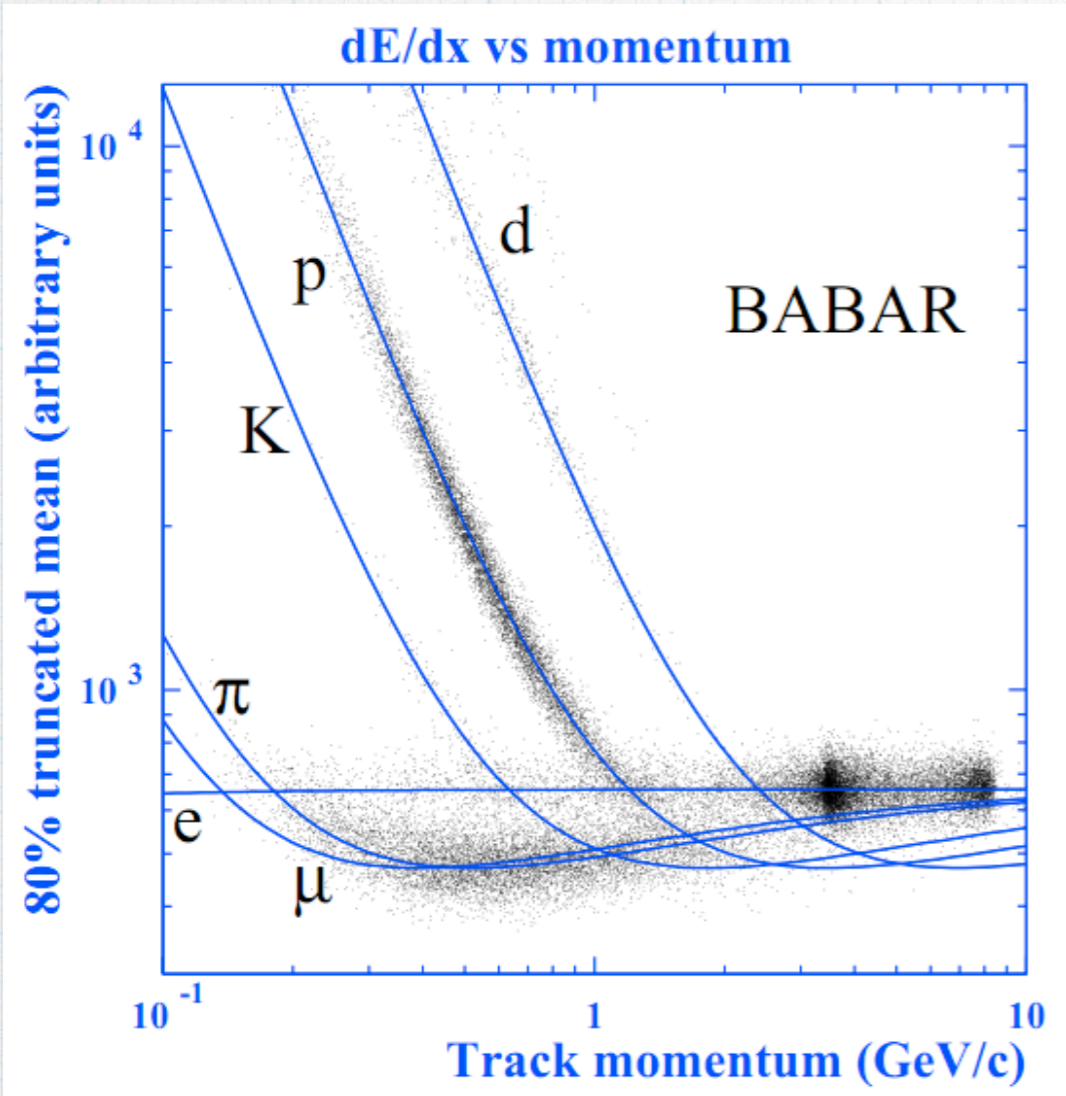

TPC particle identification examples

Transition Radiation

- * A charged high energy particle travelling between two media with different dielectric constants emits EM radiation.
- * $E_r \propto \gamma$ and $\theta_r \propto 1/\gamma$
- * ATLAS TR Tracker uses 370k tubes of $L=144\text{cm}$ & $d=4\text{mm}$ filled with gas mixture ionized by TR x-rays. This improves $e-\pi$ separation.

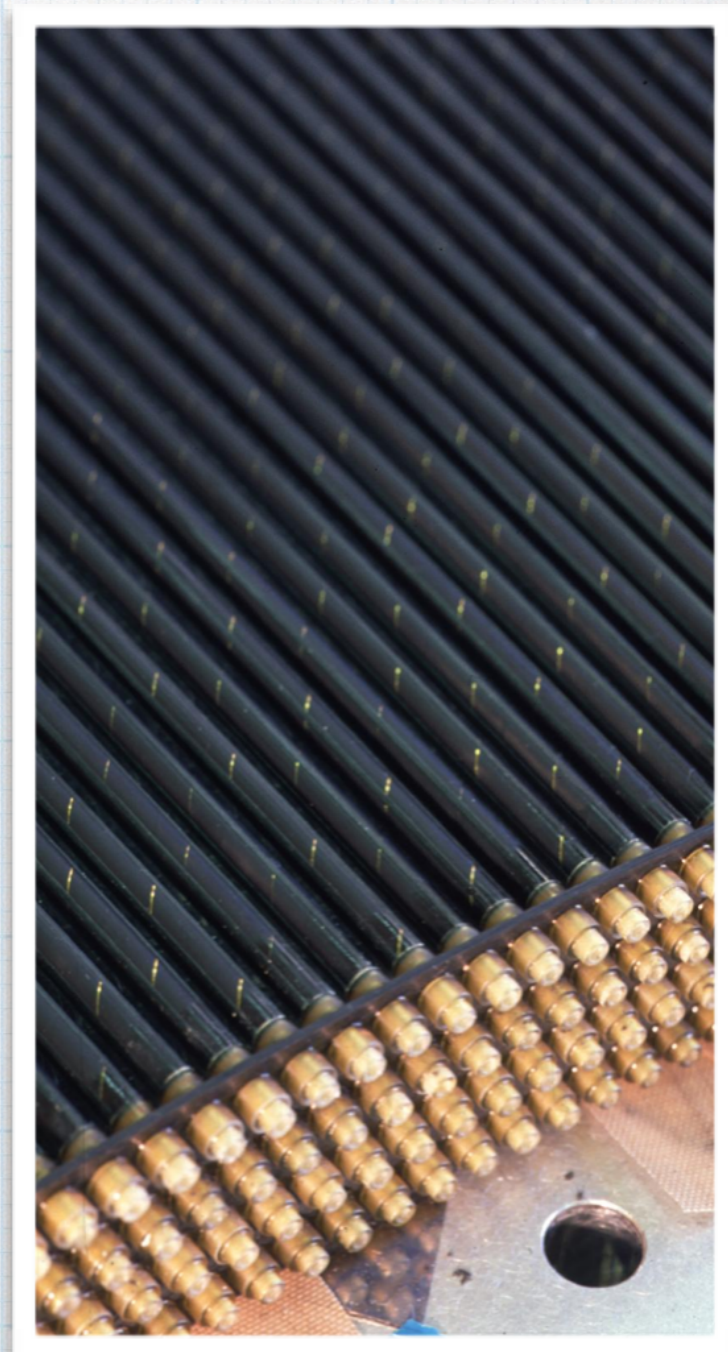
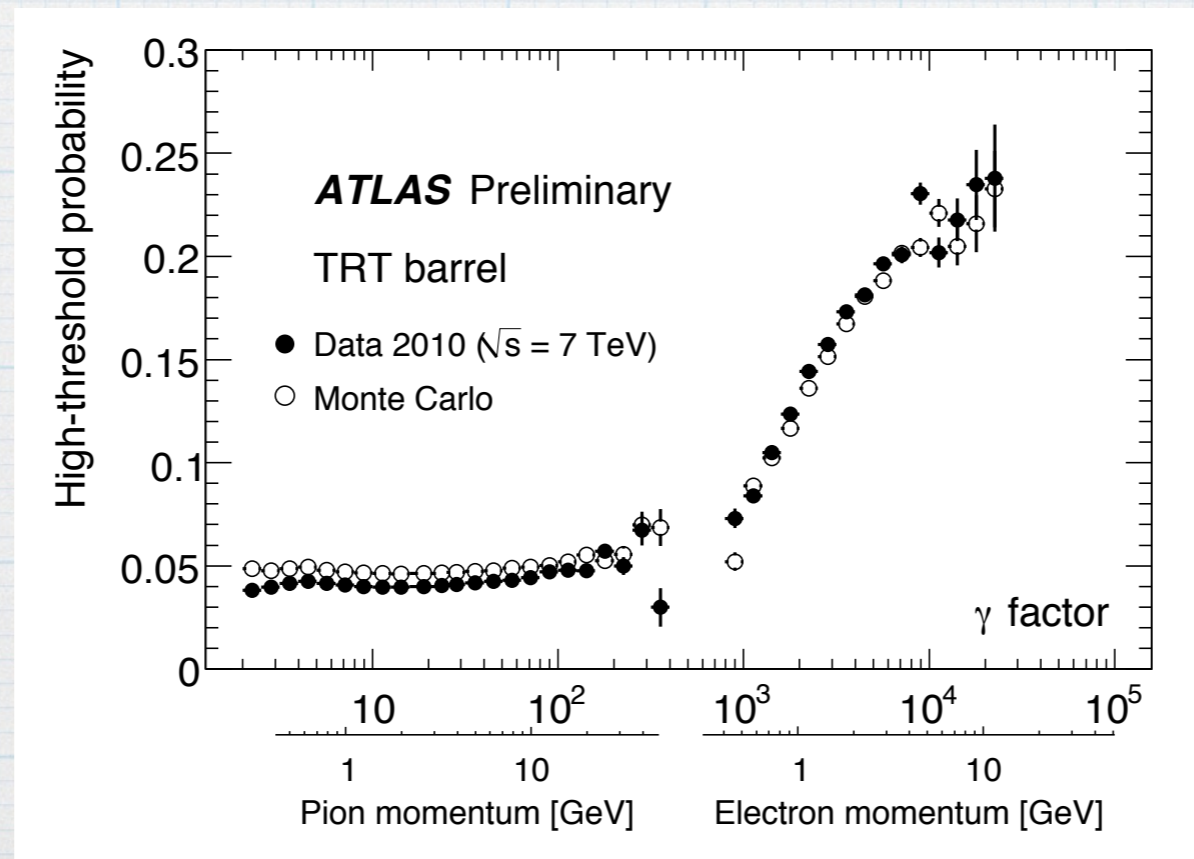
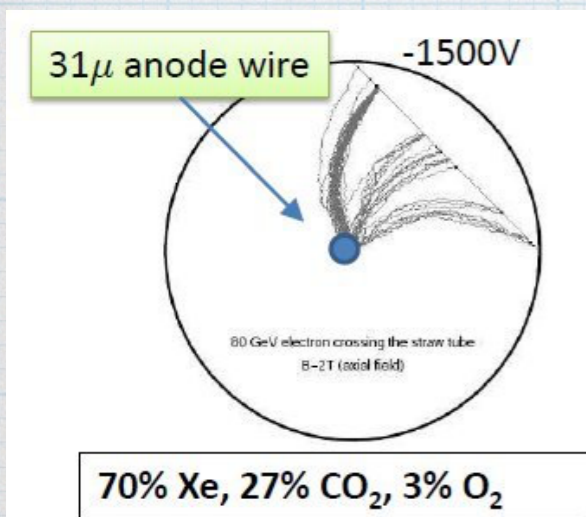

Silicon as the ionisation medium

- * Same working principle as the gaseous chamber

- * Advantages

- * much smaller areas can be instrumented
- * smaller bias voltage needed (LV: 100V)
- * better resolution: about $10\mu\text{m}$

- * Disadvantages

- * Thermal noise can give fake signal
- * Cooling is necessary
- * Expensive detector
- * Many (100k) readout channels

- * Typical utilisation

- * Pixel: x,y information
 - * Many channels, expensive
- * Strip: only x or y information
 - * But I can use two or more strips at an angle to get x-y information.

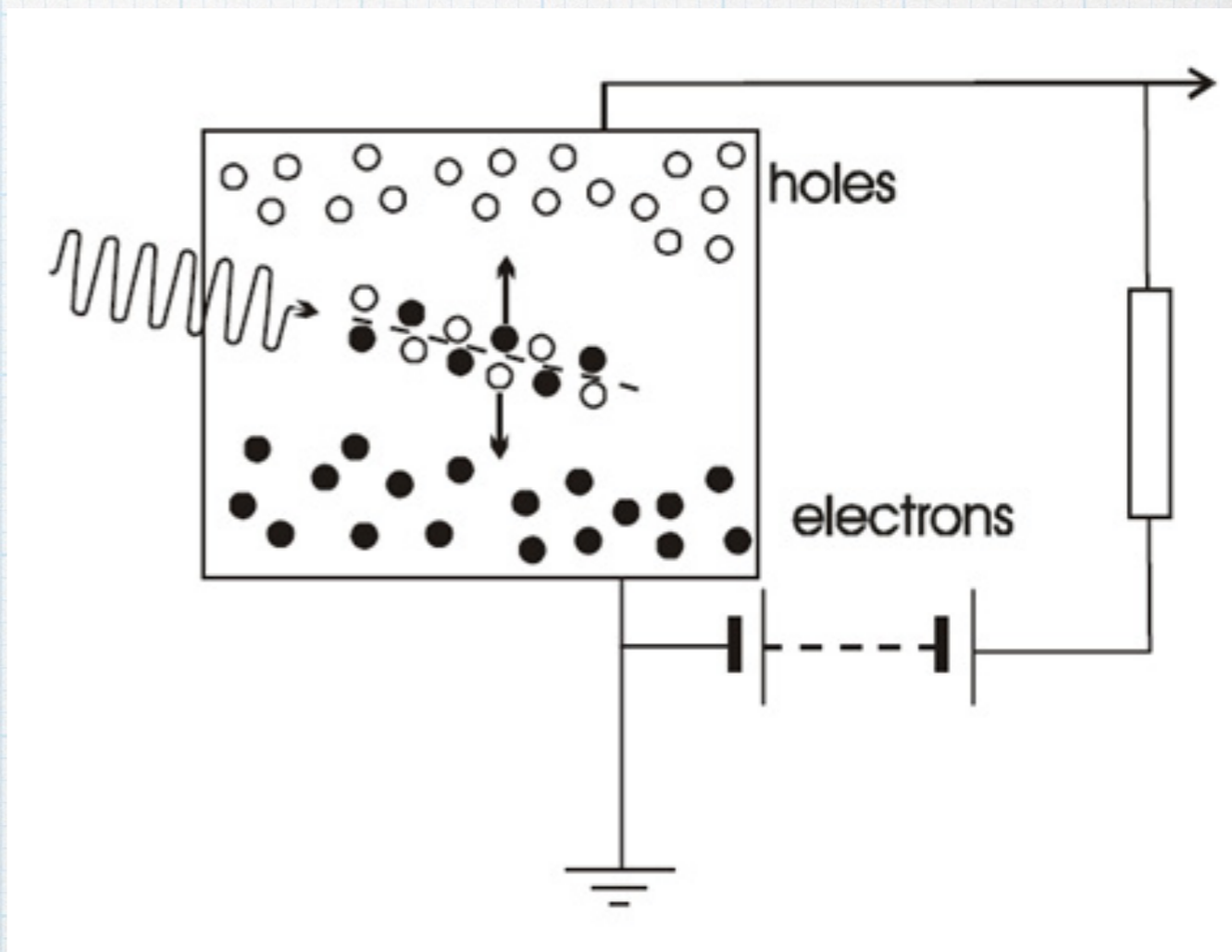

ATLAS Inner detector

* Silicon system

* Pixel : $R=12.3\text{cm}$

* ideal $16\mu\text{m}$, using
cosmics $24\mu\text{m}$

* SCT : $R=51.4\text{cm}$

* ideal $24\mu\text{m}$, using
cosmics $30\mu\text{m}$

* TRT Detector

$R=108.2\text{cm}$

* ideal $130\mu\text{m}$, using
cosmics $187\mu\text{m}$

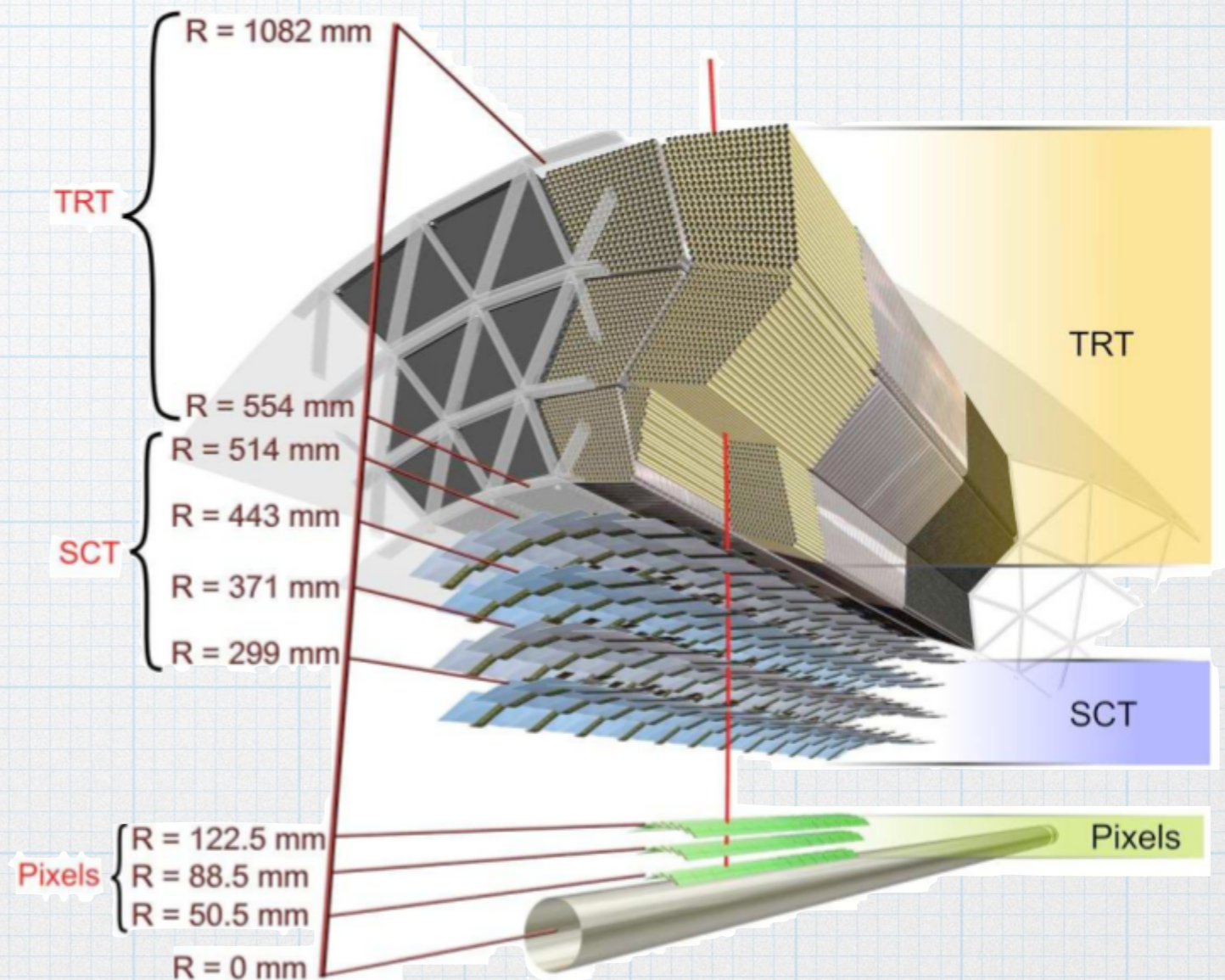

Scintillator

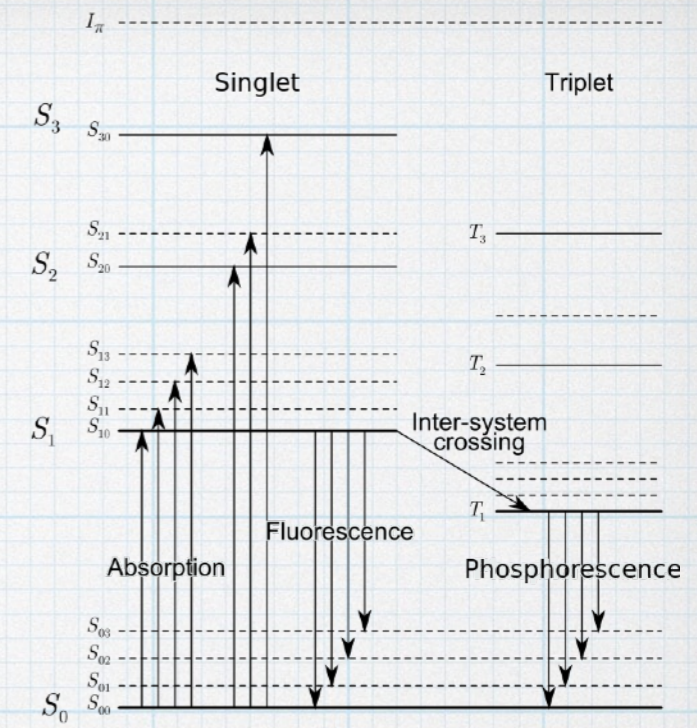

- * New interaction mechanism!
 - * energy absorbed by the atoms, and emitted as light later on.
 - * fast (fluorescence) and slow (phosphorescence) components.
- * Converts the energy deposited by traversing particles into light: scintillation mechanism
 - * ≈ 40 photons/keV NaI(Tl),
 - * ≈ 10 photons/keV plastic scintillator,
 - * ≈ 4 photons/keV BGO
- * Transparent to its own light.
- * Plastic or Crystal Scintillator – W. Crookes 1903, ZnS screen

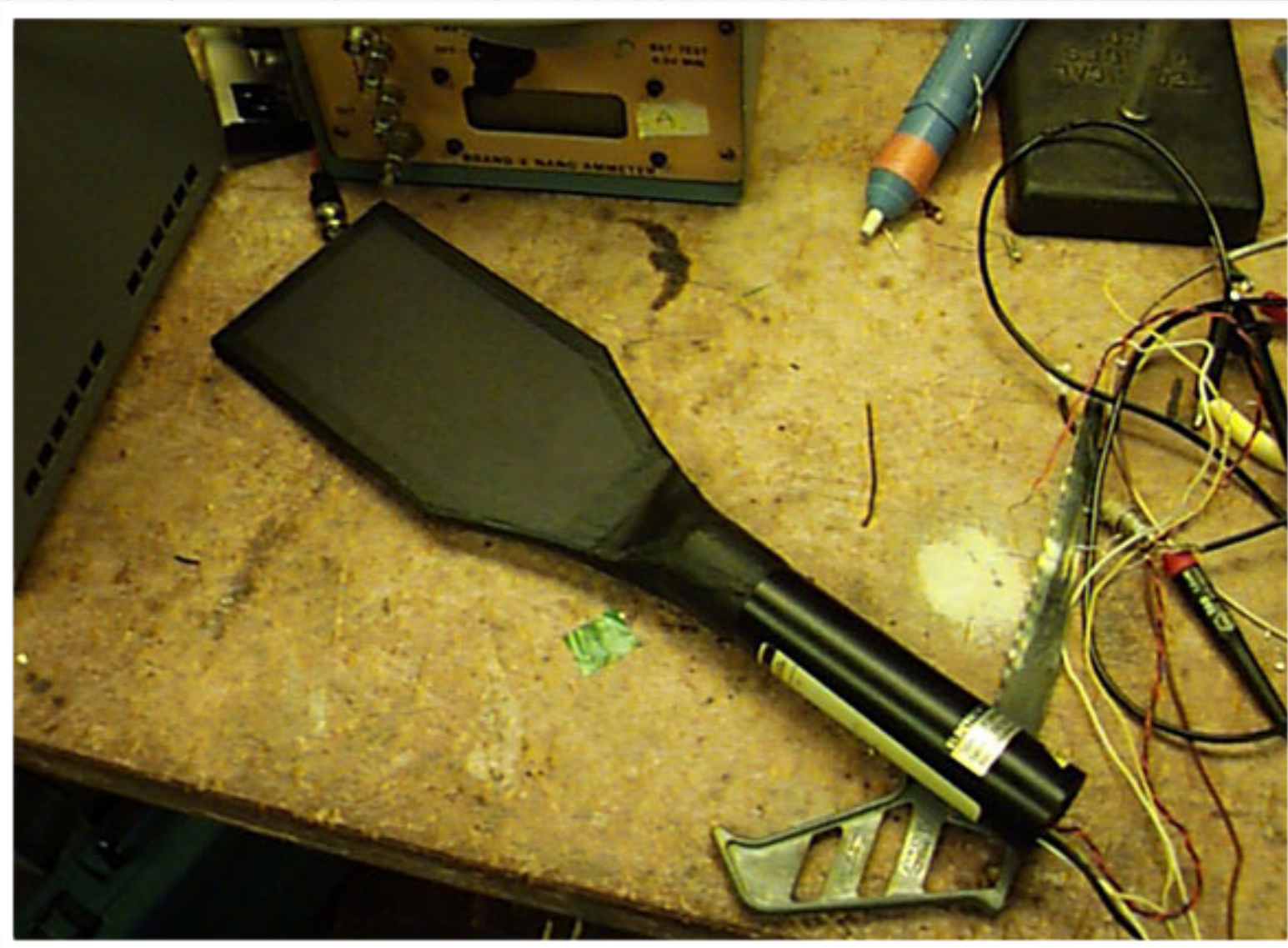

Scintillator Alley: DIY

to see a beam



To build a plastic scintillator

N₂

Dow Styron
634 PS pellet +
PPO + POPOP

heater

extruder

final shape

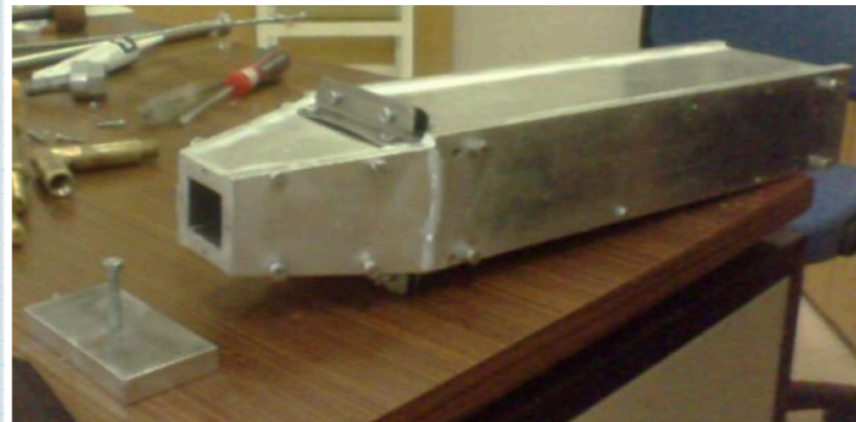

reading out a scintillator

- Digitizing the scintillation light

- Converting light to charge: photoelectric effect

- Photomultiplier tube does the job (with ~2kV)

- An electric signal is readout → need to convert analog to digital: **ADC**

- ▶ Total charge: $Q = k E (+k'E^2)$

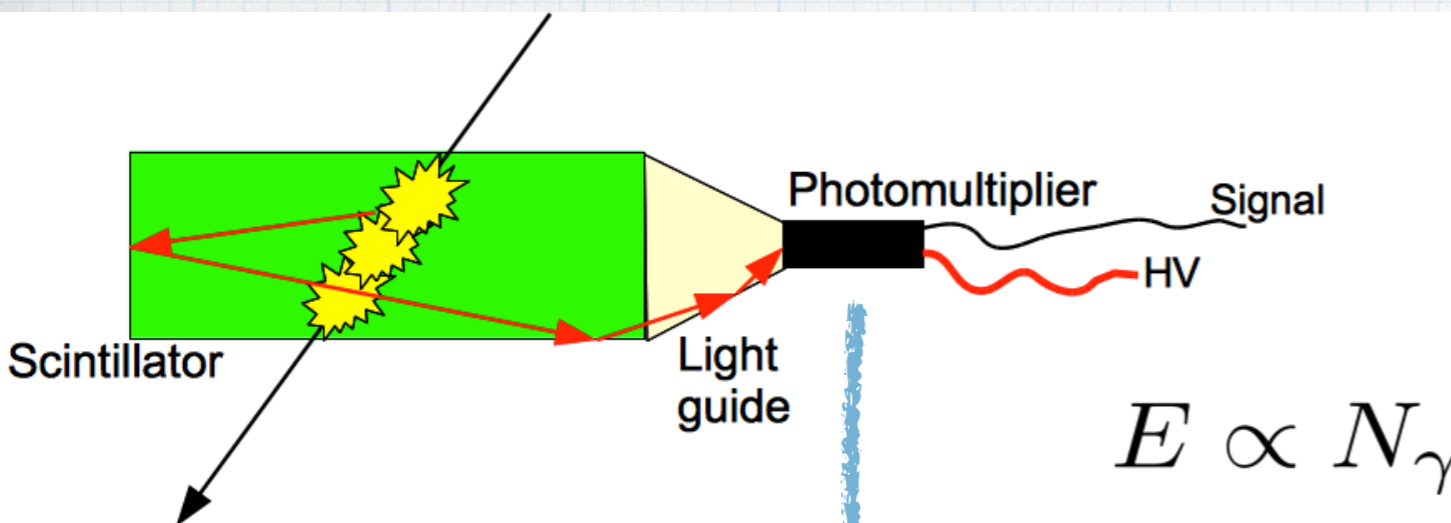

- there are position sensitive PMTs (x-wire AND padded types)

- SiPM are “a la mode”
small sensitive area
uses silicon photodiode
bias voltage small (<100V)
can work under B field

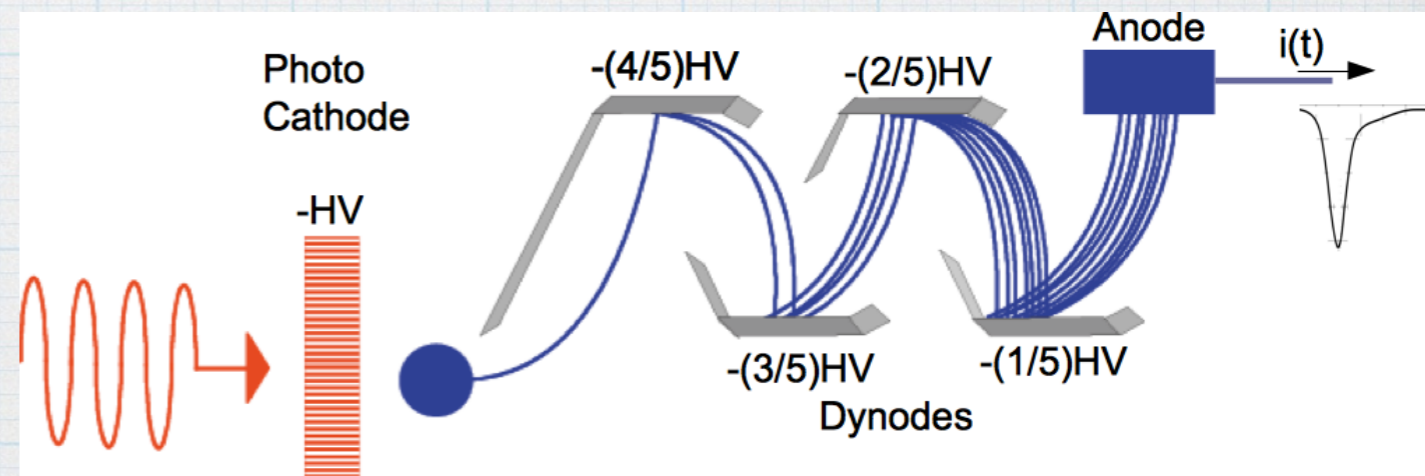

if signal is received without scintillation light: dark current

High gain: ~1M times

scintillator auxiliaries

Polystyrene

- PbWO₄ Crystal
- LYSO(Ce) Crystal
- BGO Crystal
- CsI Crystal
- NaI(Tl) Crystal
- CdWO₄ Crystal
- YSO(Ce) Crystal

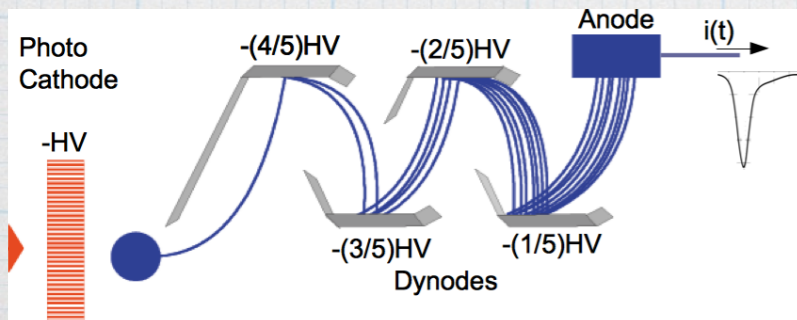
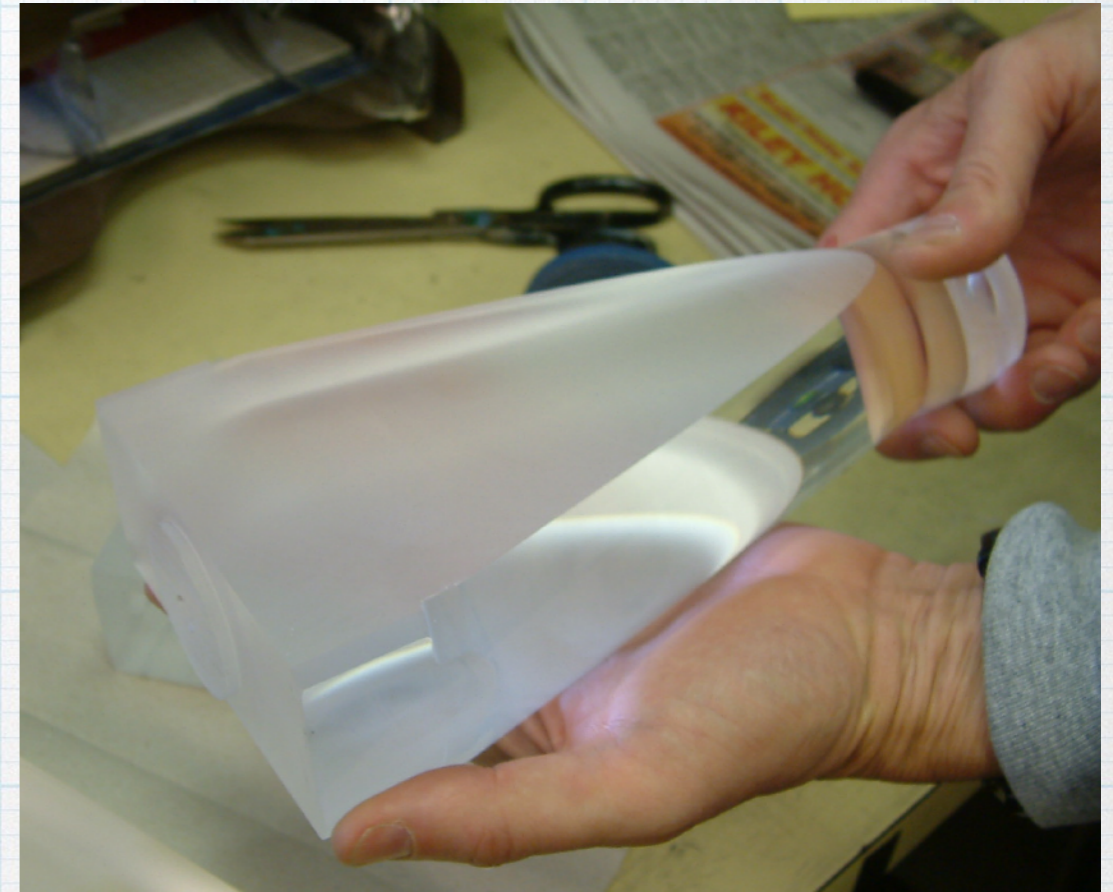

PMT



light guide

PMT alley: Čerenkov Radiation

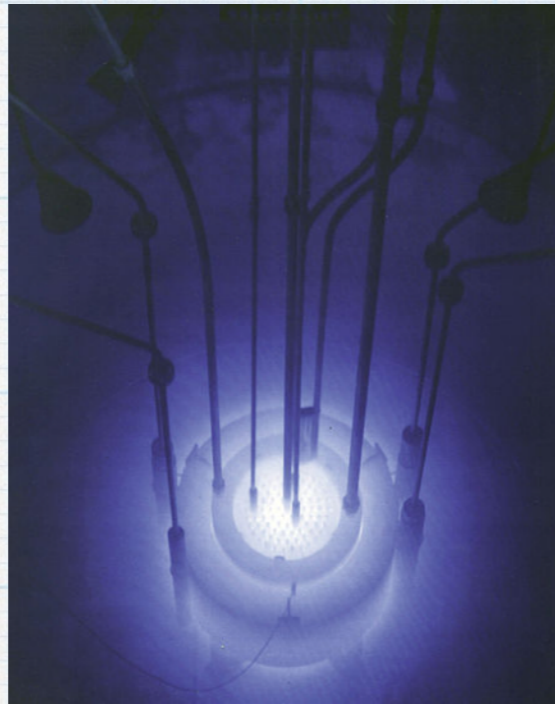
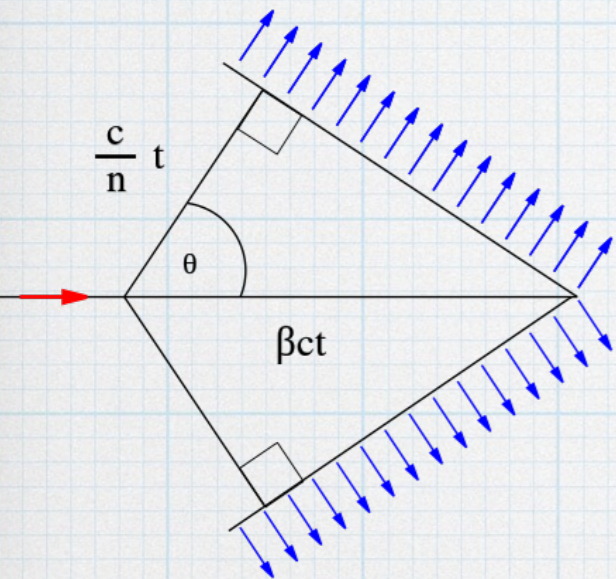

hamamatsu 50cm PMT

- ◆ If a charged particle's speed inside a medium ($\beta=v/c$), is greater than the speed of light in that medium ($\beta_{thr}=1/n$, $n \equiv$ medium's refractive index, $n \geq 1$), the particle emits EM radiation at an angle $\cos\theta_c = 1/(n\beta)$
- ◆ This light read by large PMTs can be used for particle identification if momentum can be independently measured.

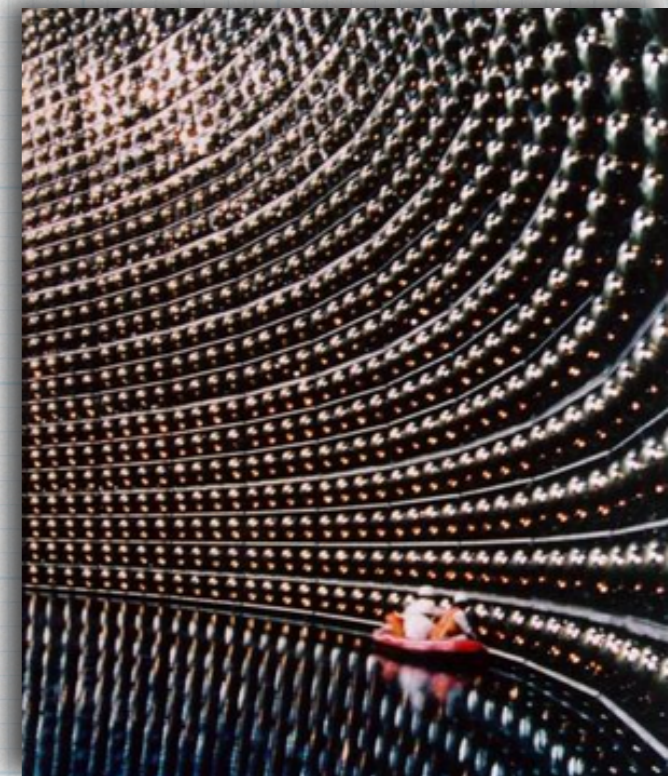
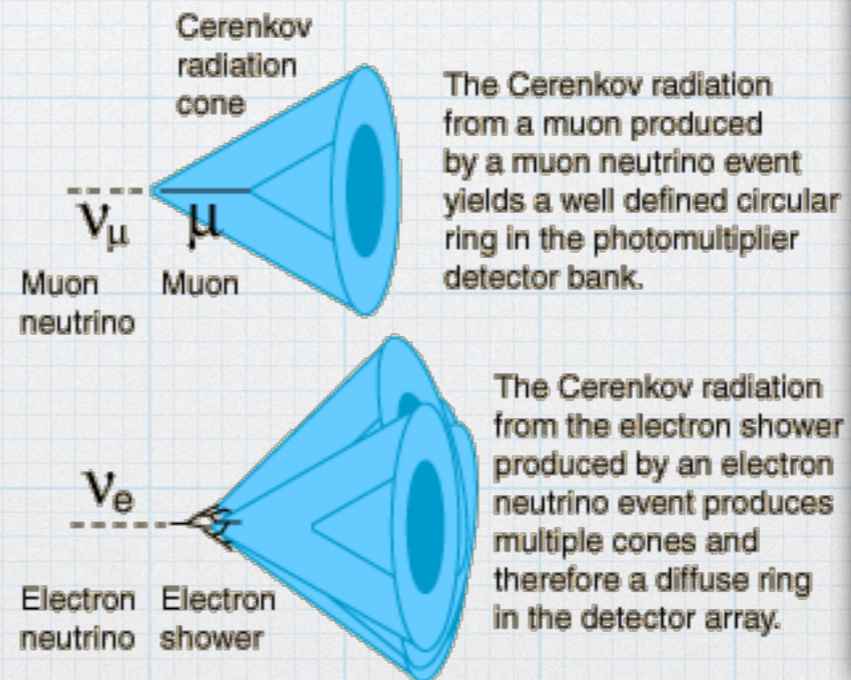

Using scintillators in a beamline

- * As veto
 - * reject events from beam halo
- * As trigger
 - * simple way to count event types
 - * $N1 = s1.s2.\overline{s3}$
 - * $N2 = N1.(T1 \parallel T2)$
- * As a crude tracker: hodoscope
 - * read a long scintillator from both ends and compare the arrival times of signals to PMTs. Time difference can be converted to positron information.

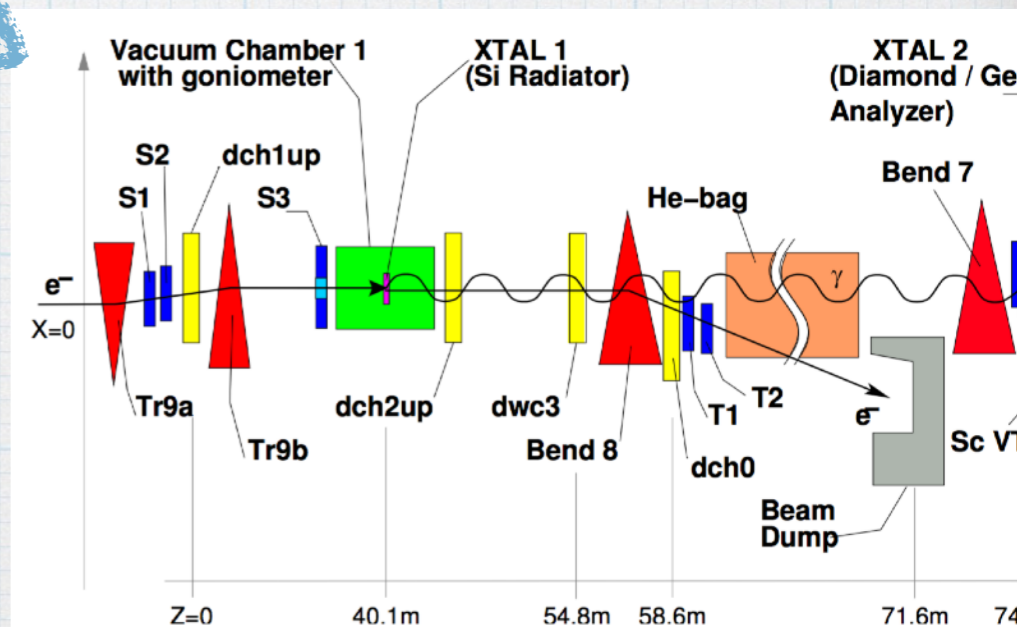
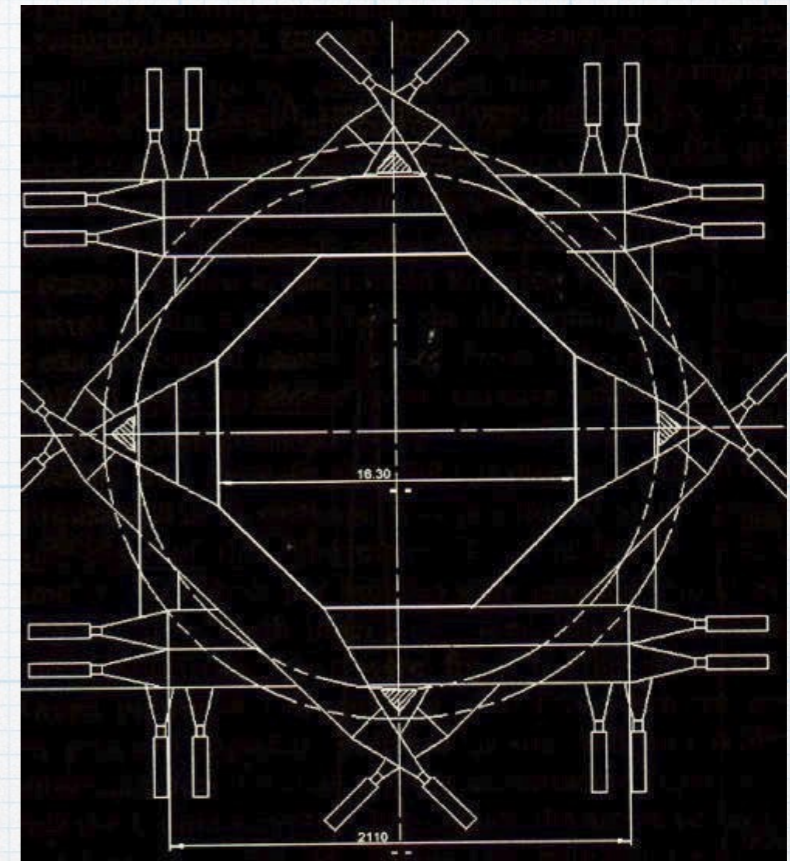
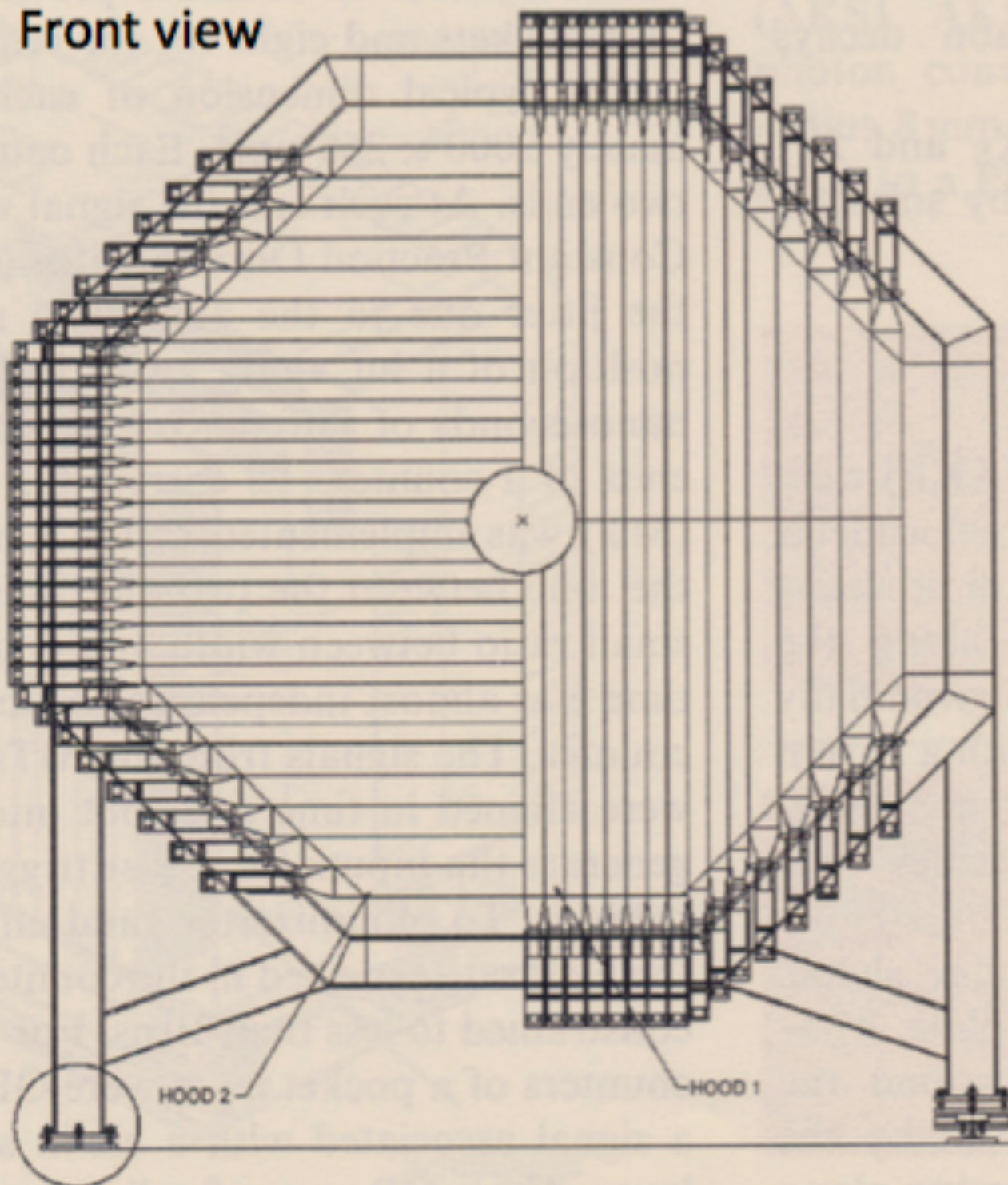

Fig. 1. Setup of the Na59 Experiment

Na48 Hodoscope

Front view



Charged hodoscope

- 2 planes of scintillation counters
- 2 orientations
- Time resolution 260 ps
- In front of Kr calorimeter
- Time difference between planes gives direction of particles

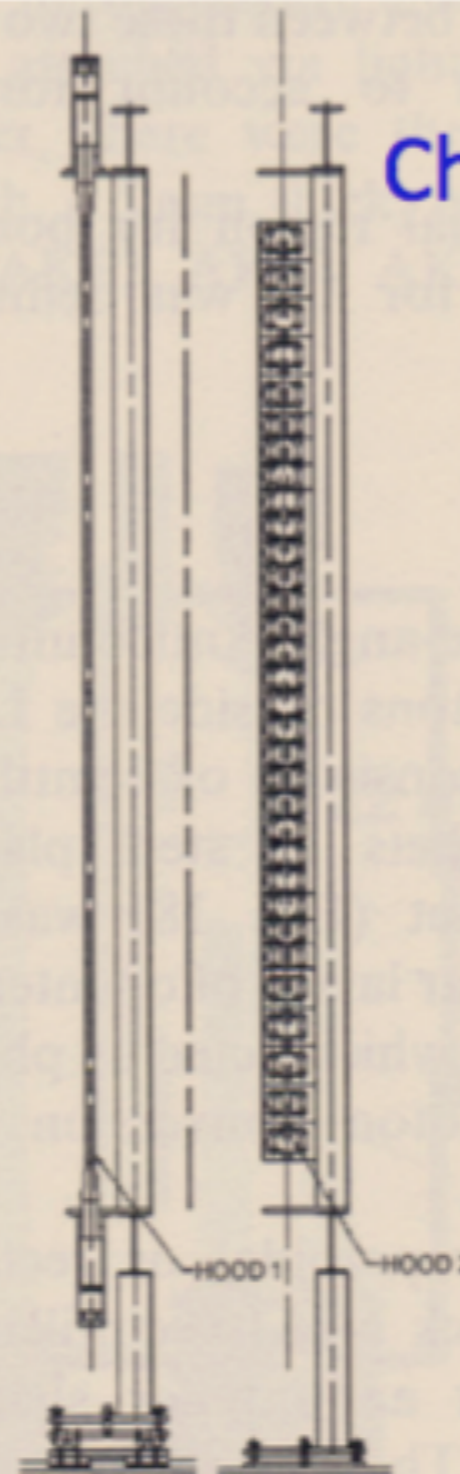

Side view

triggering a delay wire chamber by a scintillator

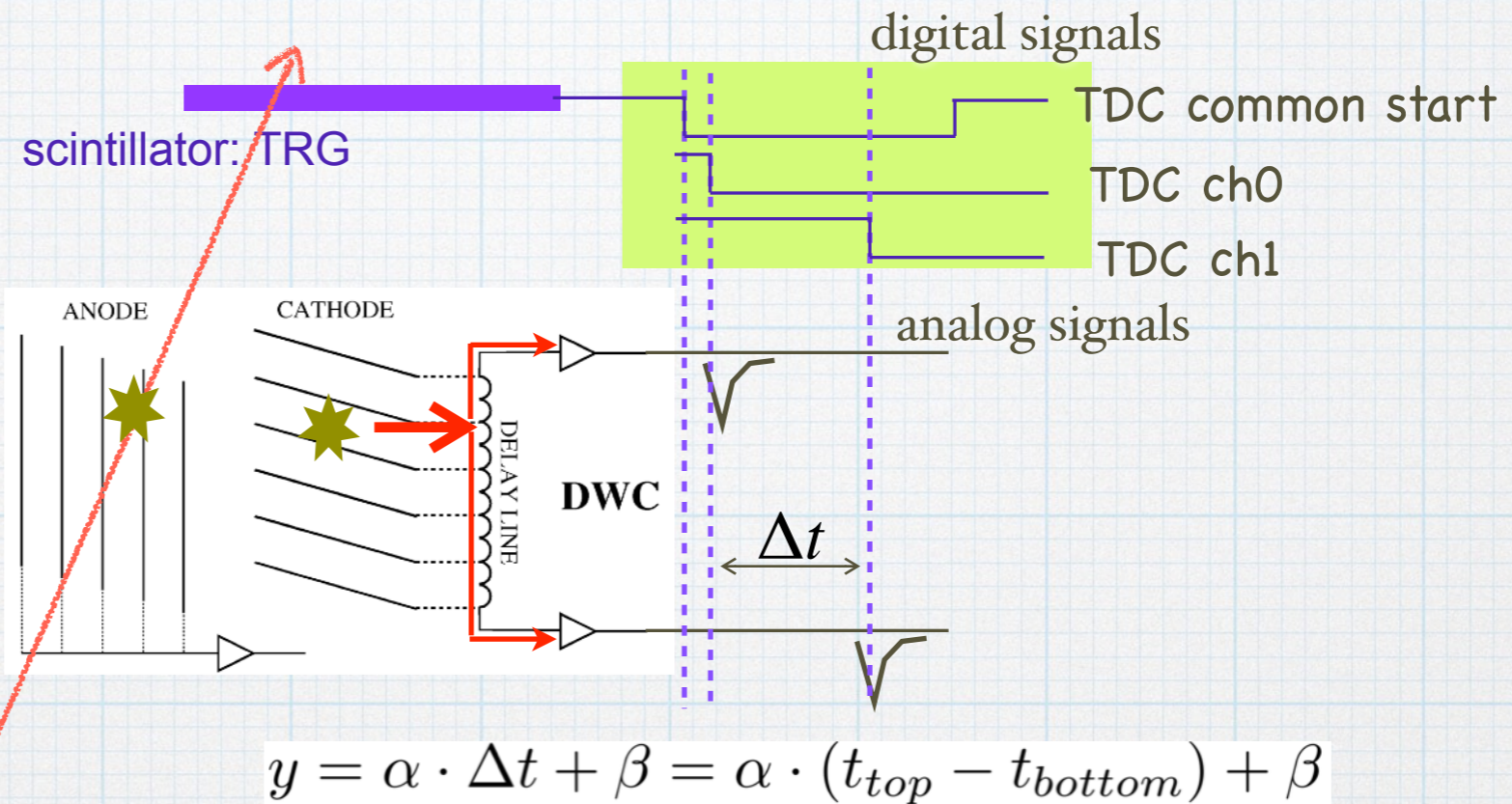
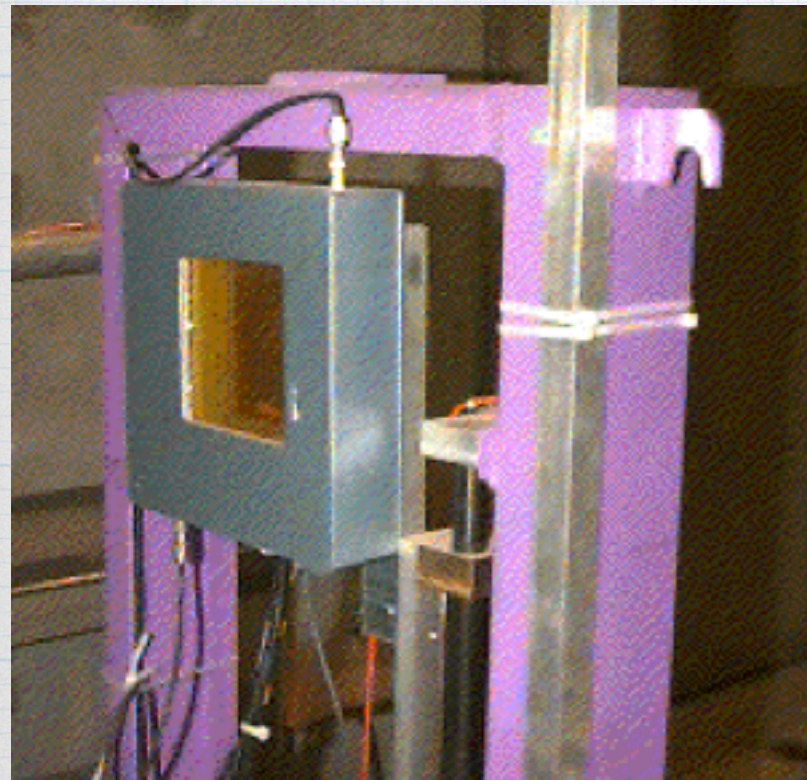

● DWC: Delay Wire Chamber

- ➔ Simple detector to typically measure the beam profile on fixed target experiments.
- ➔ gaseous & multiwire
- ➔ TDC readout: 2CH /plane.

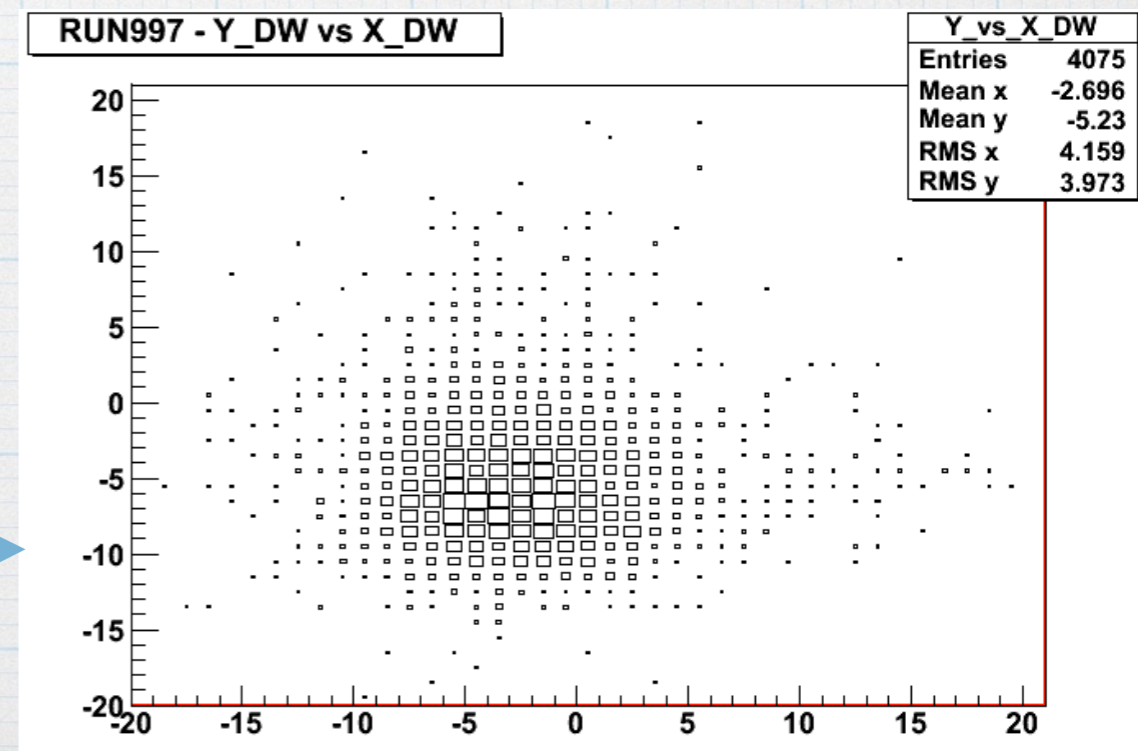

triggering alley

- * Select interesting events
 - * Do it as early as possible
 - * Do it as efficiently as possible
 - * Do it as rapidly as possible
 - * Use all the available information
- * May have to trigger in stages
 - * low level: use hardware, be quick and crude
 - * high level: use software, be thorough

beam monitoring alley

Measure Charge q

collect q in a Faraday Cup

measure q with an ampermeter

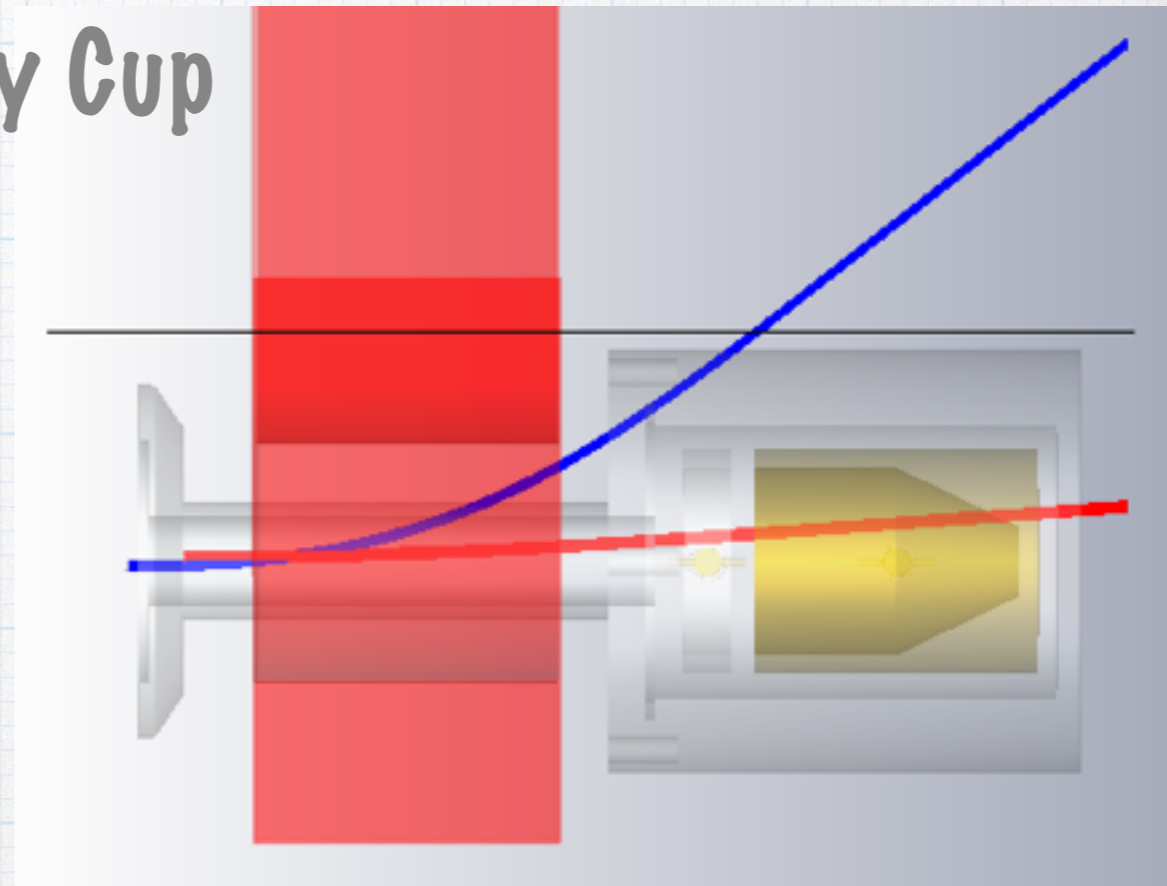

pick up passing q with a Current Transformer

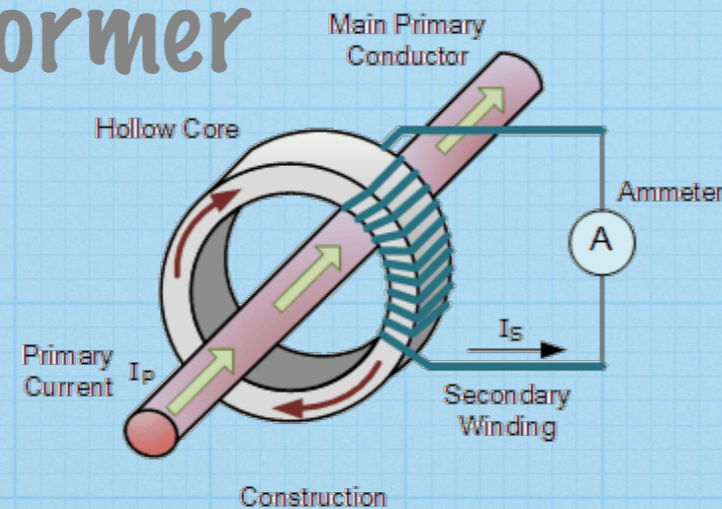

measure q with a scope



you can also have 2 such devices and do a time of flight (TOF) measurement to determine beam momentum

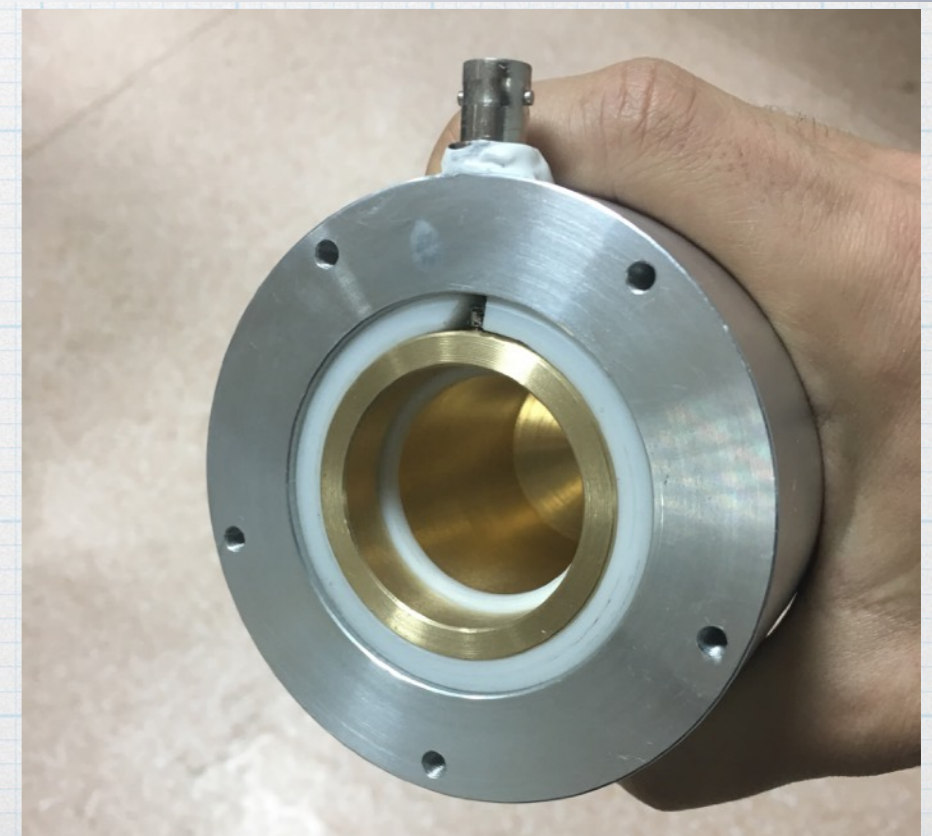

Calorimeter

- * The name calorimeter was made up by Antoine Lavoisier. In 1780, he used a guinea pig in his experiments with this device to measure heat production. The heat from the guinea pig's respiration melted snow surrounding the calorimeter, showing that respiratory gas exchange is a combustion, similar to a candle burning.
- * PP calorimeters are "destructive" energy measurement devices.
 - * the particle beam to be measured has to be absorbed.
- * PP calorimeters benefit from many additional interactions:

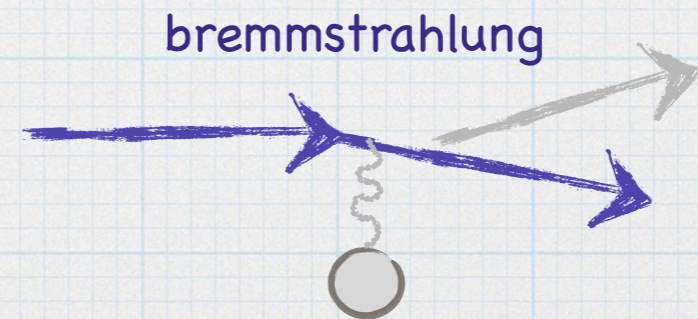
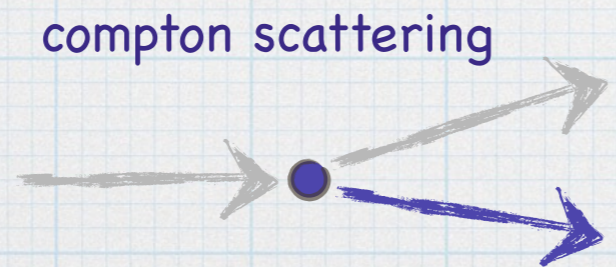
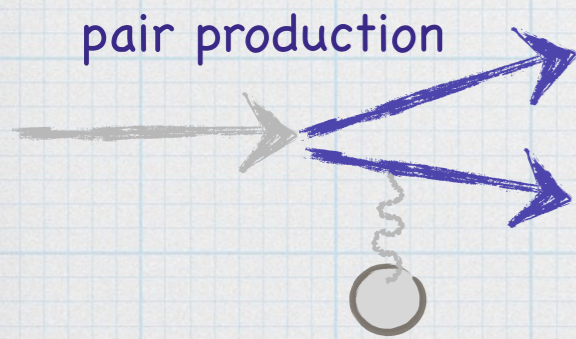
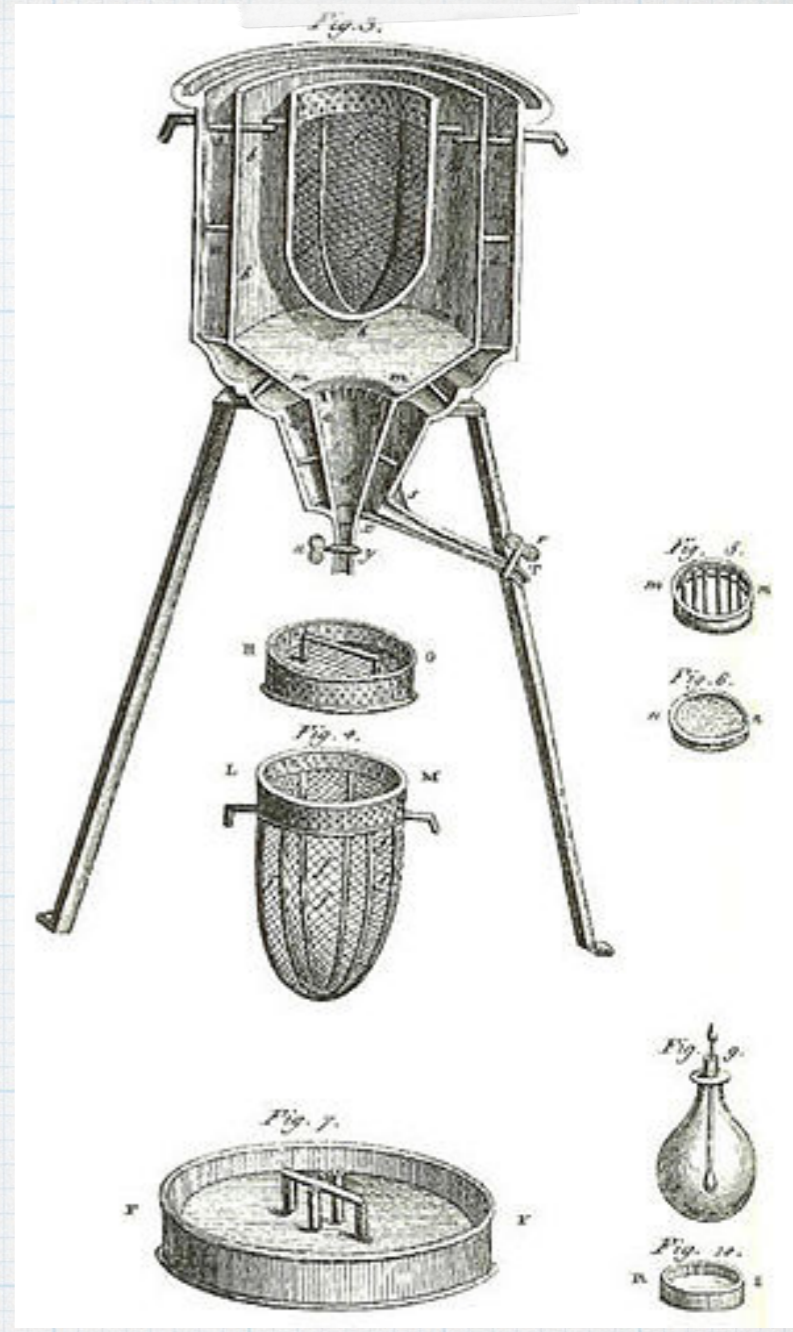

PP calorimetry

- * Particle interactions determine calorimeter type
 - * material choice, size
- * Incoming particle interacts with calorimeter material
 - * it generates a "shower" of secondary particles
 - * These particles excite, ionize the material of the calorimeter
 - * Incoming particle can be neutral or charged

* Two flavors

- * Electromagnetic (photons, electrons)

- * Radiation length (electron loses 1/e of its energy)

- * Hadronic (strongly interacting particles)

- * Nuclear interaction length $\lambda \approx 35 \text{ g} \cdot \text{cm}^{-2} A^{1/3}$ (# rel. particles drops to 1/e of its initial value)

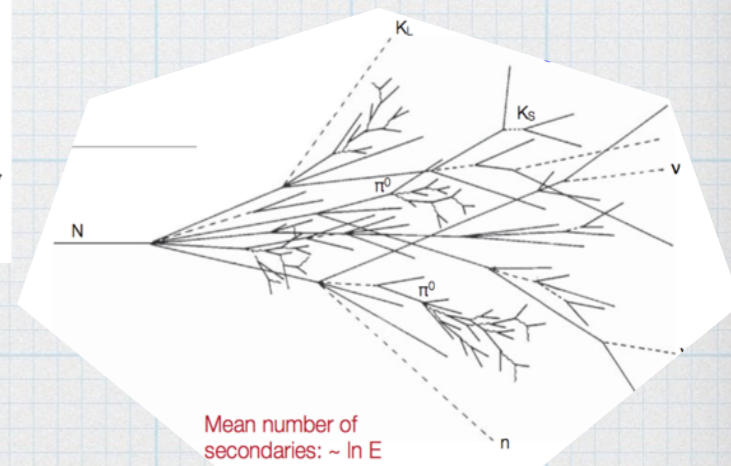
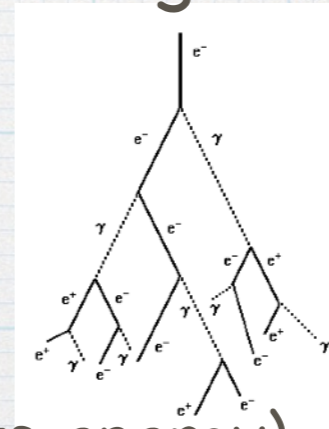

Mean number of secondaries: $\sim \ln E$

EM calorimeters

- * Radiation length, X_0 : the distance at which the particle energy drops down to $1/e$ of its initial

value: $E(x) = E_0 e^{-x/X_0}$ $X_0 = \frac{716.4 \text{ cm}^{-2} A}{Z(Z+1) \ln(287/\sqrt{Z})}$ ATLAS EMcalo: $22X_0$

- * Critical Energy, E_c : The energy at which losses due to Bremsstrahlung and ionization are equal.

$$E_c = \frac{580 \text{ MeV}}{Z}$$

- * Moliere Radius, R_m : The radius of a cylinder containing on average 90% of the shower's energy deposition.

- $R_m = 0.0265 X_0 (Z + 1.2)$
- $R_m = 21X_0 / E_c$

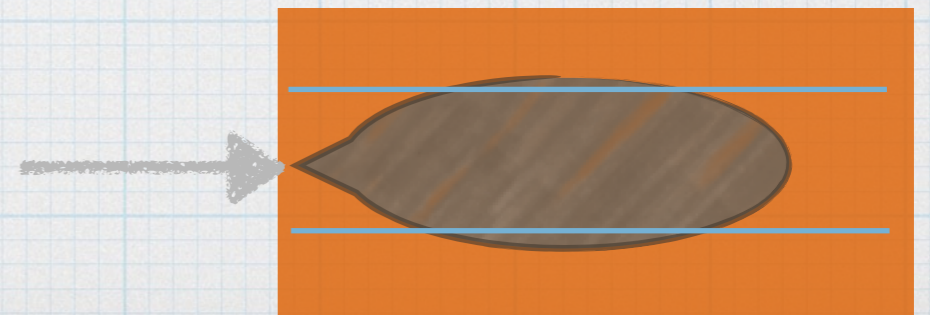

Homogeneous vs Sampling Calorimeters

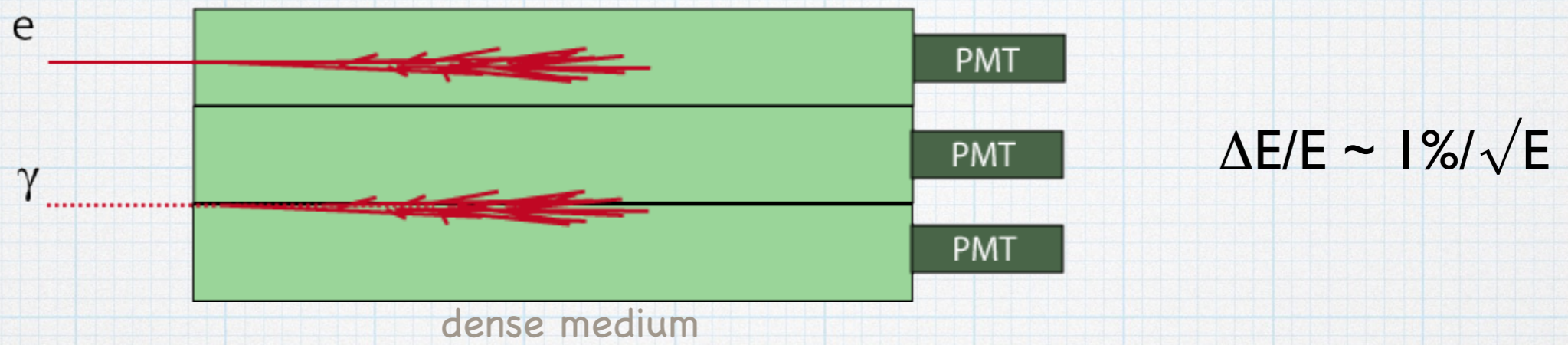

The dense medium may be "active" or "passive" :

- Homogeneous calorimeters: CsI(Tl), BGO, Pb-glass, PWO, Xe(liq)...
- Sampling calorimeters: Pb-scintillator, Fe-scintillator, Pb-Ar(liq)...



High Z passive material
e.g. Pb, Cu,...

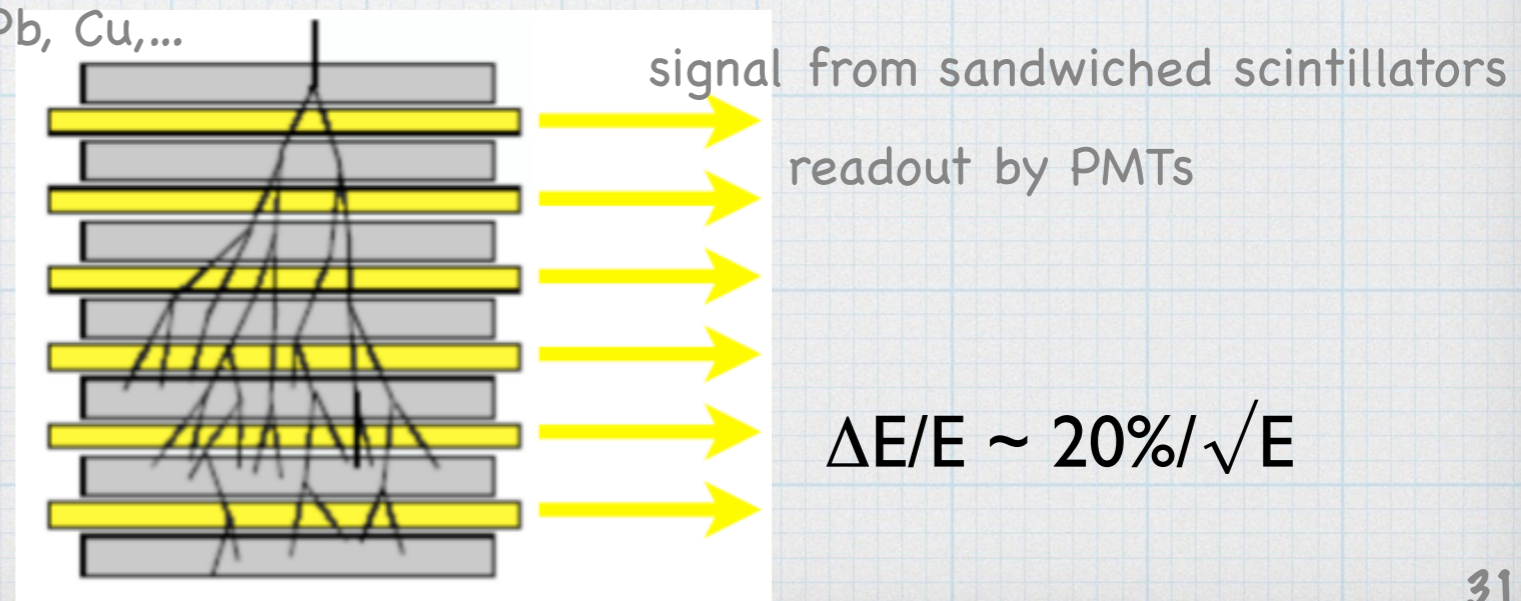

Calorimeter Materials

- * Crystal calorimeter
 - * Measure produced light
 - * Full containment in depth difficult
 - * Response stability limited
- * Semiconductors (Ge)
 - * Only small devices feasible
- * Liquid noble gas calorimeter
 - * Intrinsically stable
 - * Easy calibration
 - * Complication of cryogenics
 - * Slow collection time



Hadronic Calorimeters

- * High Energy strongly interacting particles, interact with the nucleons of the medium.
- * A hadronic shower: cascades of mesons ($K, \pi \dots$) and hadrons ($p, n \dots$) similar to EM case
- * Absorption length, λ : Scale at which secondary, tertiary particles are produced.
 - * Typically $9-10\lambda$ are needed for longitudinal containment and 1λ for lateral. Hcal depth $>$ EMcal.
- * Most common type: Sampling Calorimeter
 - * High Z material (Fe, Pb,..) and Sensor (Scintillator, LAr)

particle ID revisited

$$E^2 = p^2 + m^2$$

Measure E and p independently

- Energy from calorimeter
- p from magnetic spectrometer

Calculate E/p:

-E/p \approx 1 for electrons, \ll 1 for π

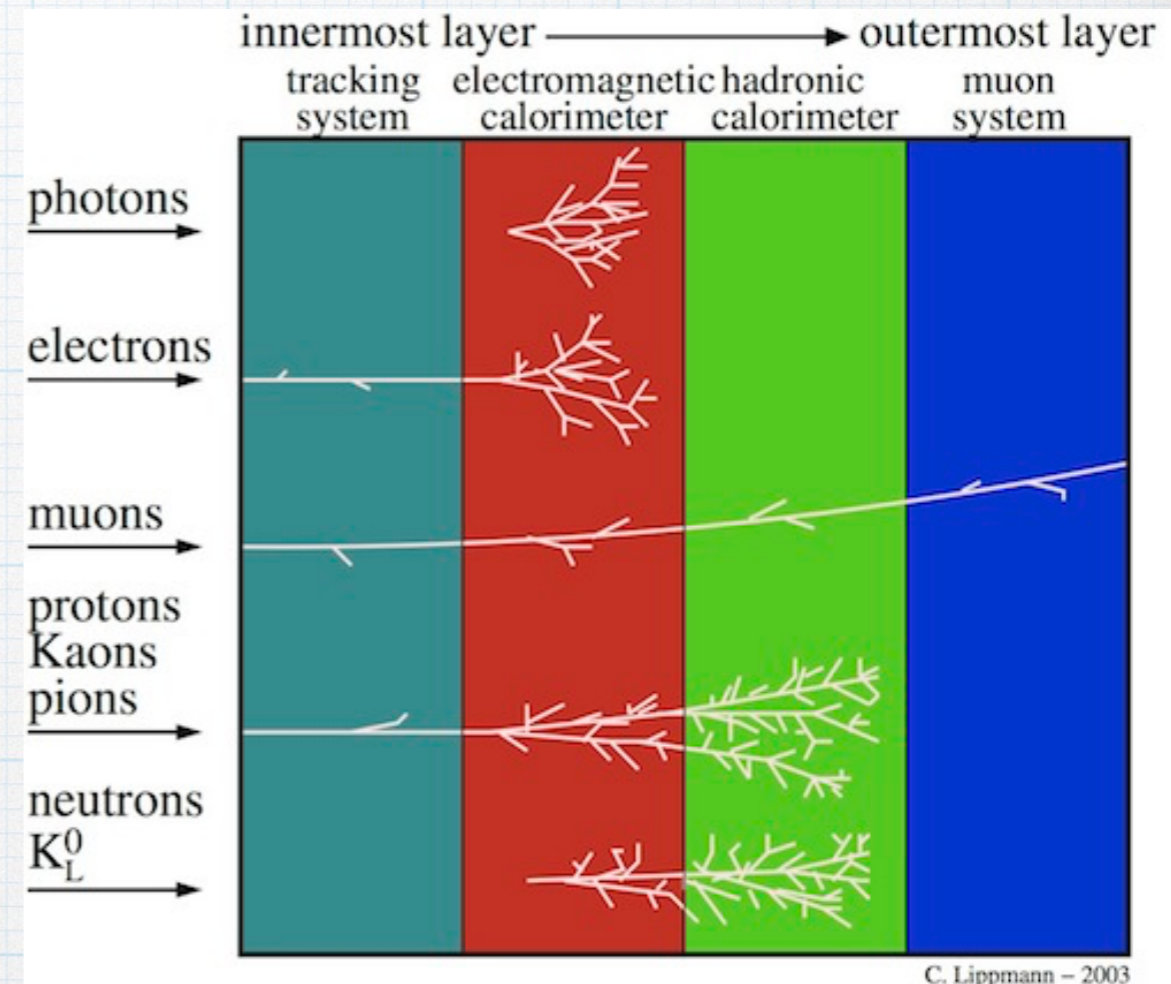

Only muons will be able to traverse the calorimeters

Balance the momentum in transverse plane to find hints for neutrino(s). Denoted as MET.



Run Number

Date

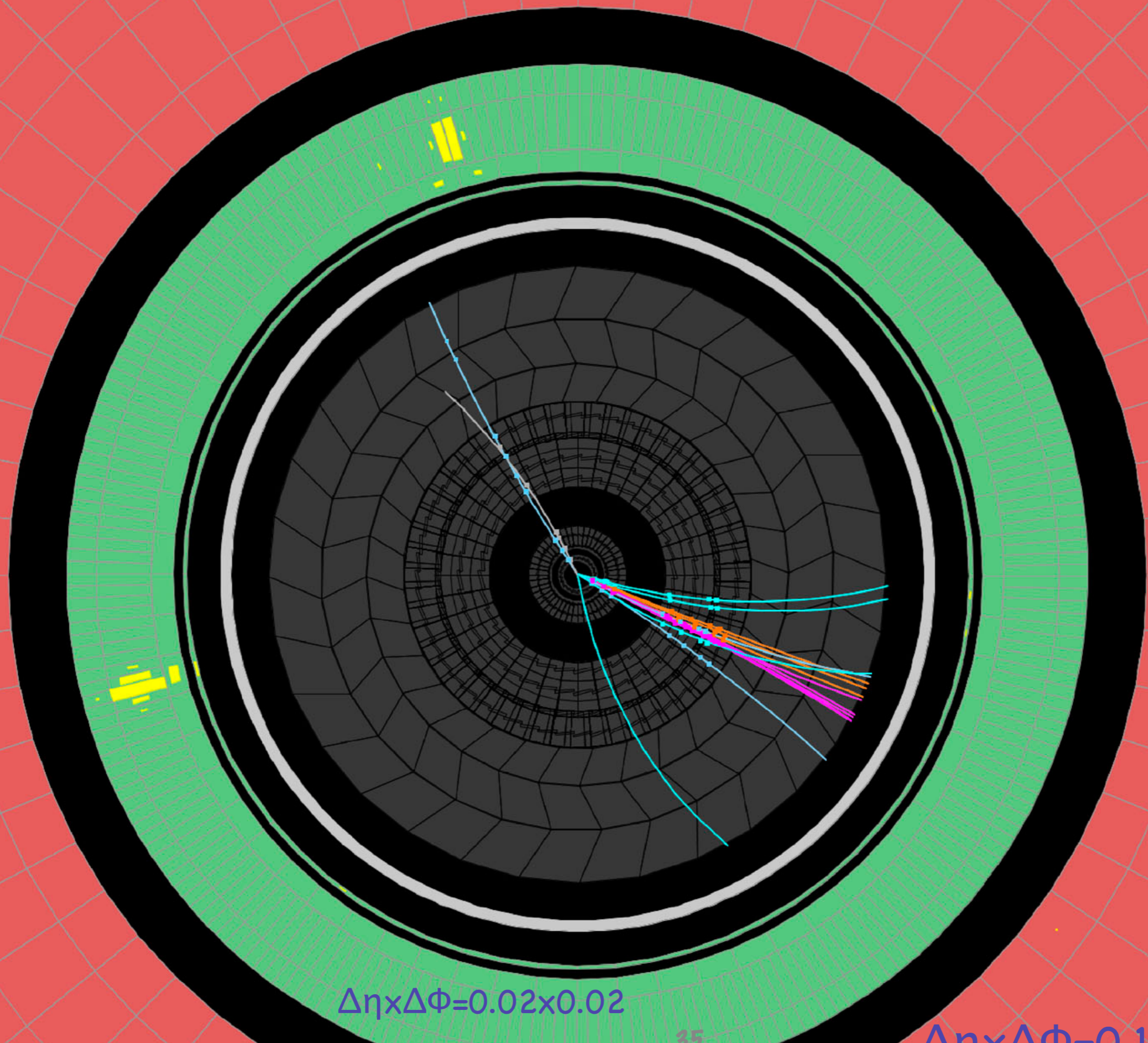

$\Delta\eta \times \Delta\Phi = 0.02 \times 0.02$

35

$\Delta\eta \times \Delta\Phi = 0.1 \times 0.1$

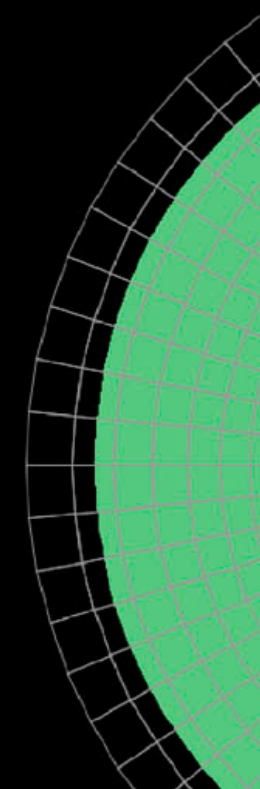

ReadOut Chain

1. pre-amplifier

Strengthen the initial signal to a measureable level

2. discriminator - filter

Reduce noise.

3. buffer (analog)

Used when ADC is not fast enough or an ADC should be shared across channels. Reduces the readout electronics dead-time.

4. digitiser

Convert analog info to digital using standard electronics

5. zero-suppression and digital buffering

No need to send channels with 0, but event format should contain channel ID. Alternative: data compression algorithms. Buffering can also be done in RAM.

6. multiplexer

single data path can be shared (in time) between multiple senders and receivers. Beware of synchronization issues.

7. network

Gigabit to infiniband many network solutions are available.

8. storage

Disk servers, tape robots, custom solutions... many choices...

In practice achieved using ASICs made by and for HEP expts: low level Front End design.

Infrastructure

- Cables (fibers) for power, data, controls
- Pipes for gases, cooling
- Access to the detector
- Mounting tools
- Control room
- Storage of supplies (gas, cooling, spares)

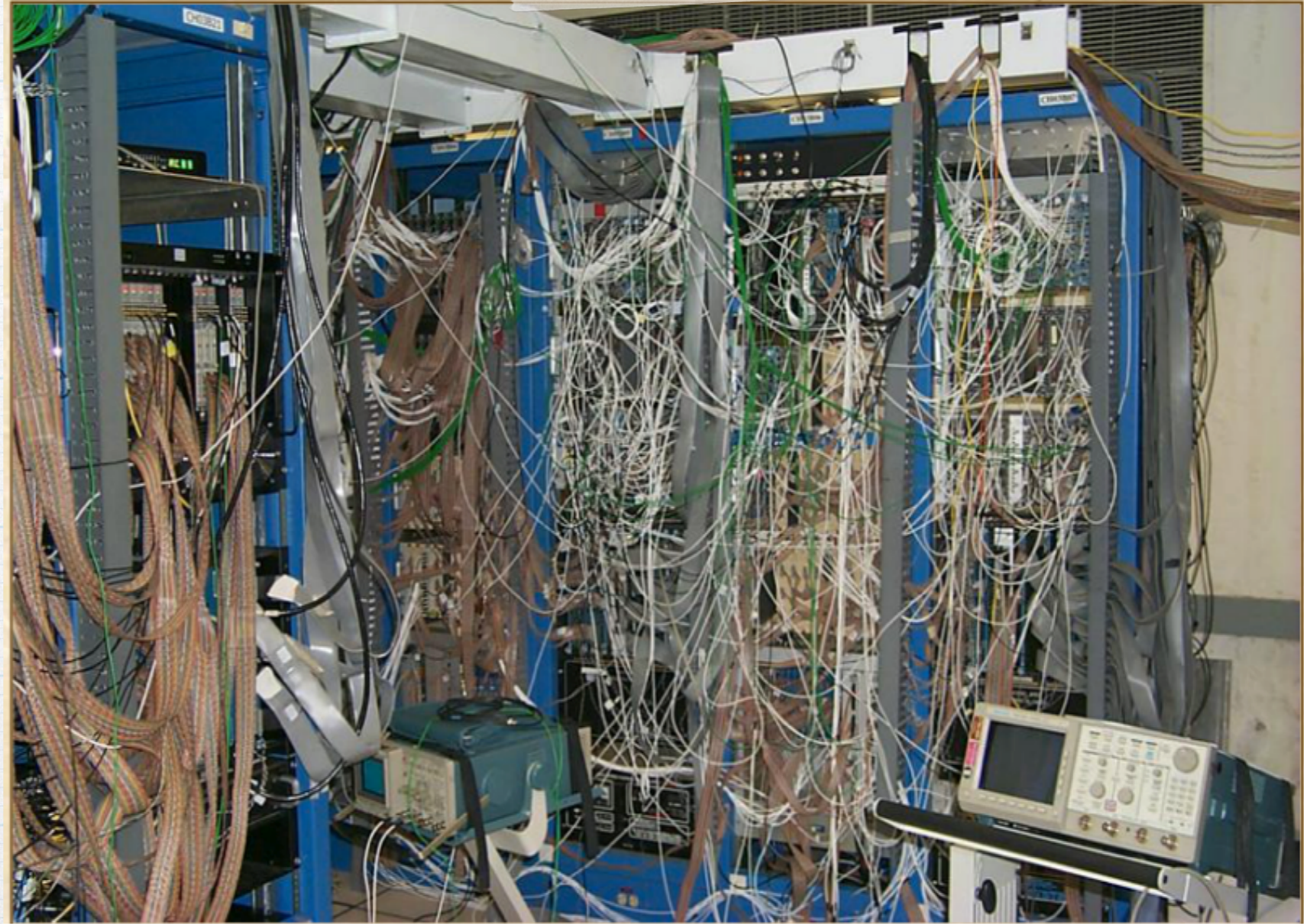

Thank you for your attention

outlook

- * Building an experiment requires very diverse competences: Physics, detectors, computing, networking, infrastructure, management,...
- * These requirements are technically challenging.
- * Exp. physics needs a broad knowledge in many areas.
- * To become a TDAQ person means talking to various experts: one needs at least to know the jargon.
- * Enjoy the rest of the school, especially the exercises.

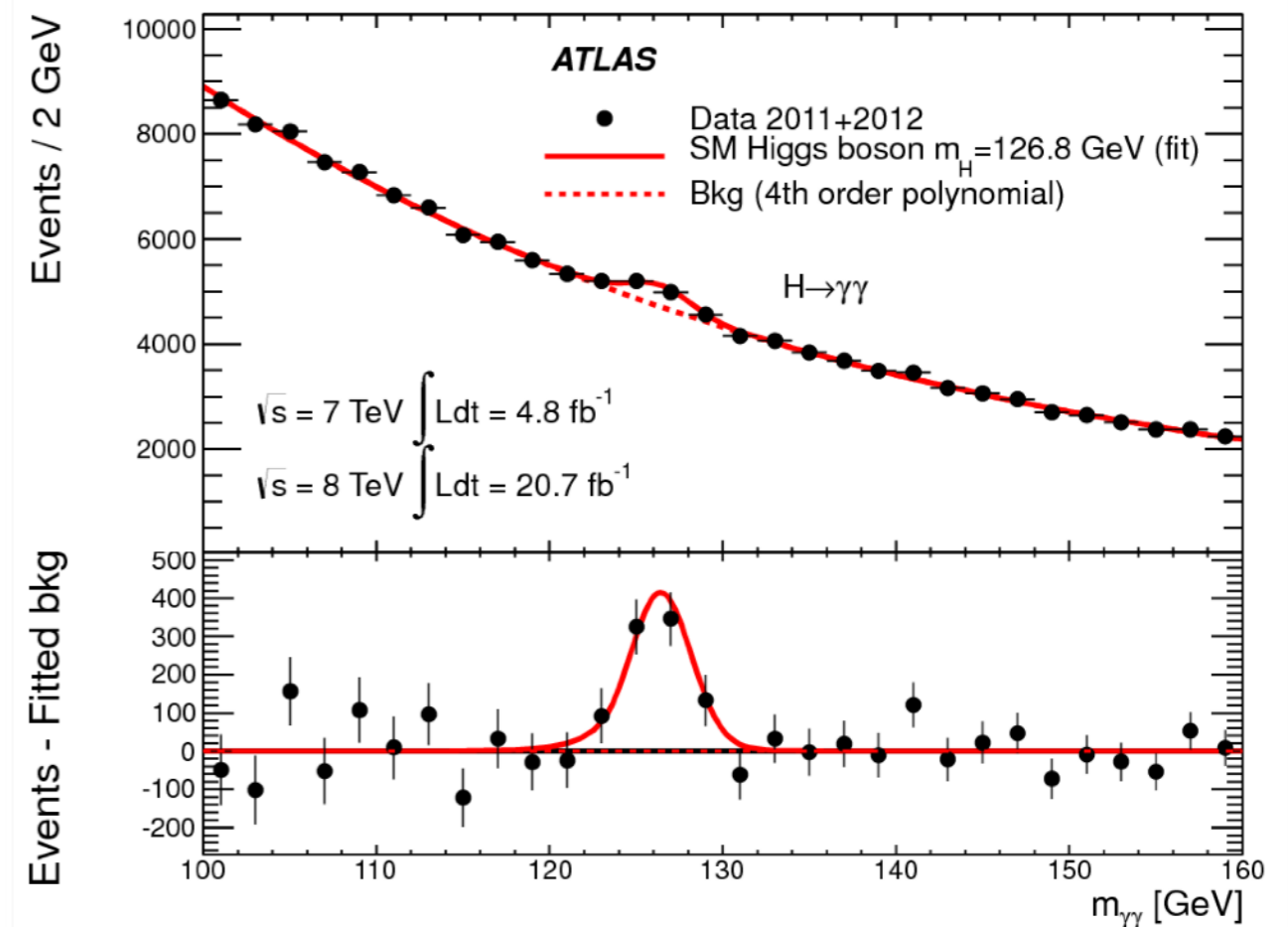

a successful experiment: Higgs discovery

further reading & references

1. W. R. Leo, "Techniques For Nuclear And Particle Physics Experiments", Springer-Verlag, 1994
2. F. Sauli "Gaseous Radiation Detectors" Cambridge Univ. Press, 2014
3. C. Grupen & B. Shwartz "Particle Detectors" Cambridge Univ. Press, 2008
4. R Wigmans "Calorimetry: Energy Measurement in Particle Physics", Clarendon Press, 2000
5. ATLAS, CMS, BaBar, LHCb, D0 etc. TDR reports (various dates)
6. CERN Summer Student Lectures on Particle Detectors 2002