Lecture 13 - Radiofrequency Cavities III

Professor Emmanuel Tsesmelis
Principal Physicist, CERN
Department of Physics, University of Oxford

Accelerator Physics Graduate Course
John Adams Institute for Accelerator Science
16 November 2016

Table of Contents III

- Synchronizing Particles with Cavities
 - Operation of Linac Structure
 - Power Generators for Accelerators
 - Triode Amplifier, Tetrode Amplifier, Klystron
 - Accelerator RF Examples
 - Large Hadron Collider (LHC)
 - Linear Colliders (ILC, CLIC)
-

Synchronising Particles with Cavities

- If accelerator has more than single cavity, particles should be bunched to arrive at the same phase with respect to the voltage at each cavity.
- Space cavities by distance L that a particle travels in one RF period

$$L = \beta\lambda \text{ (Alvarez, } 2\pi) \text{ or } L = \beta\lambda / 2 \text{ (Wideroe, } \pi)$$

$$\text{with } \beta = v / c \text{ and } \lambda = 2\pi c / \omega$$

Synchronising Particles with Cavities

- Alvarez Structure
 - Increasing L between accelerating gaps along structure.
 - Snapshot of fields across each gap shows them all exactly in phase.
 - Particle's phase advance between cells is 2π
- Wideröe Structure
 - Alternate drift tubes grounded.
 - Snapshot shows vector alternating in sign from gap to gap.
- In these cases, cells oscillate either in phase or in antiphase.
 - Difficult for power to propagate along the waveguide and small errors produce serious distortions.

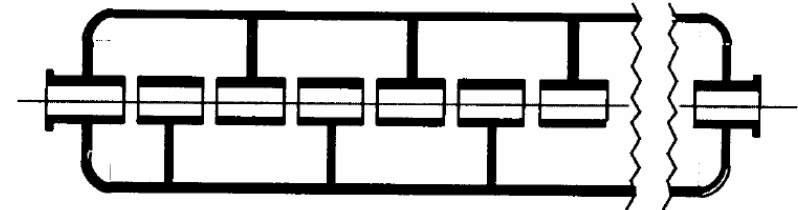

Alvarez Cavity

Wideröe Cavity

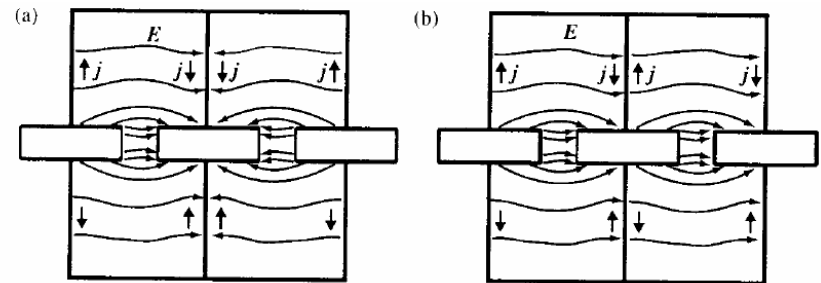

Adjacent single-gap cavities in (a) π mode and (b) 2π mode

Operation of LINAC Structure

- Standard operation of linac structure is in the S-band.
 - $\lambda=0.100\text{m}$ ($f_{RF}=3\text{ GHz}$)
- As in radar technology, RF power supplied by pulsed power tubes – klystrons.
 - Power fed into linac structure by TE_{10} wave in rectangular waveguide which is connected perpendicular to cylindrical TM_{01} cavity.

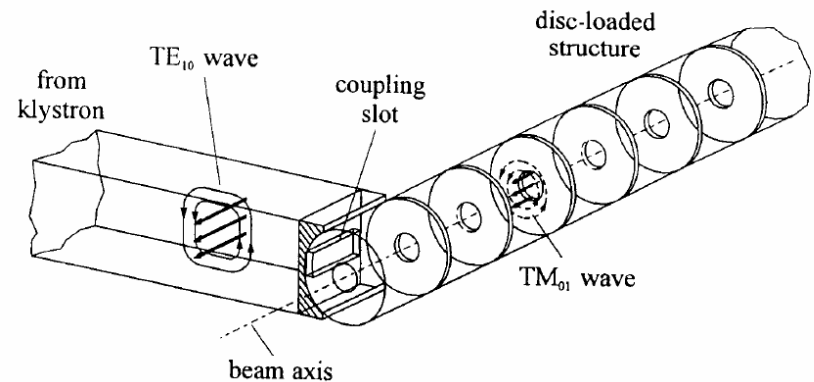

Operation of LINAC Structure

The two modes of operation of a linac structure.

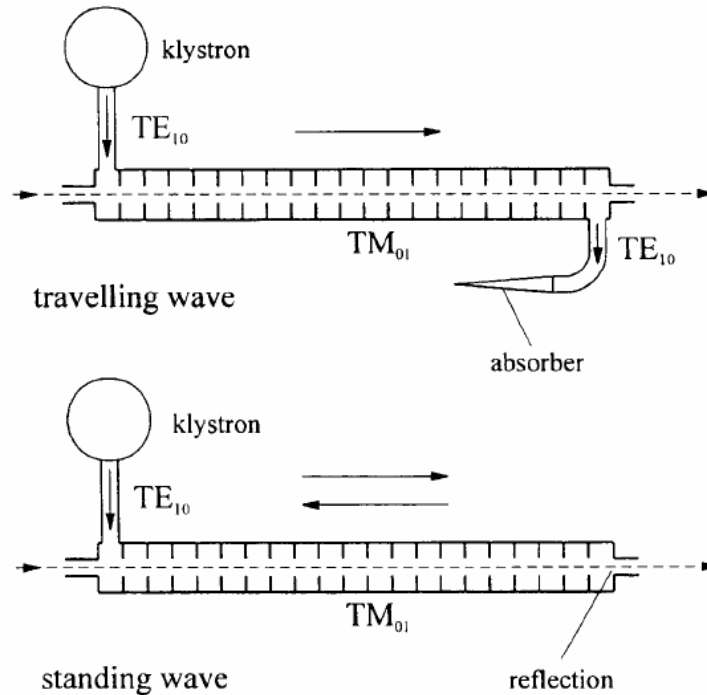

Travelling wave mode, in which an absorber is installed at the end of the structure to prevent reflections, is more commonly used.

In a standing wave mode, the energy is reflected virtually without loss.

Operation of LINAC Structure

- Irises form a periodic structure within cavity, reflecting the wave as it passes through and causing interference.
- Loss-free propagation only if wavelength is integer multiple of iris separation d :

$$\lambda_z = pd \quad \text{with} \quad p = 1, 2, 3, \dots$$

resulting in

$$\frac{2\pi}{p} = \frac{2\pi}{\lambda_z} d = k_z d \quad \text{with} \quad p = 1, 2, 3, \dots$$

- Irises only allow certain wavelengths, characterised by number p , to travel in longitudinal direction.
- These fixed wave configurations are termed modes.
- In principle there are arbitrary such modes but only three used for acceleration.

$$k_z d = \begin{cases} \pi & (\pi \text{ mode} \quad \text{i.e. } \lambda_z = 2d) & \text{if } p = 2 \end{cases}$$

$$k_z d = \begin{cases} \frac{2\pi}{3} & (2\pi/3 \text{ mode} \quad \text{i.e. } \lambda_z = 3d) & \text{if } p = 3 \end{cases}$$

$$k_z d = \begin{cases} \frac{\pi}{2} & (\pi/2 \text{ mode} \quad \text{i.e. } \lambda_z = 4d) & \text{if } p = 4 \end{cases}$$

Operation of LINAC Structure

- π -mode
 - Takes long time for transient oscillations to die away and a stationary state to be used.
 - Not suitable for fast-pulsed operation.
- $\pi/2$ -mode
 - Low shunt impedance so for fixed RF power energy gain per structure is small.
- $2\pi/3$ -mode
 - Best compromise between π -mode & $\pi/2$ -mode

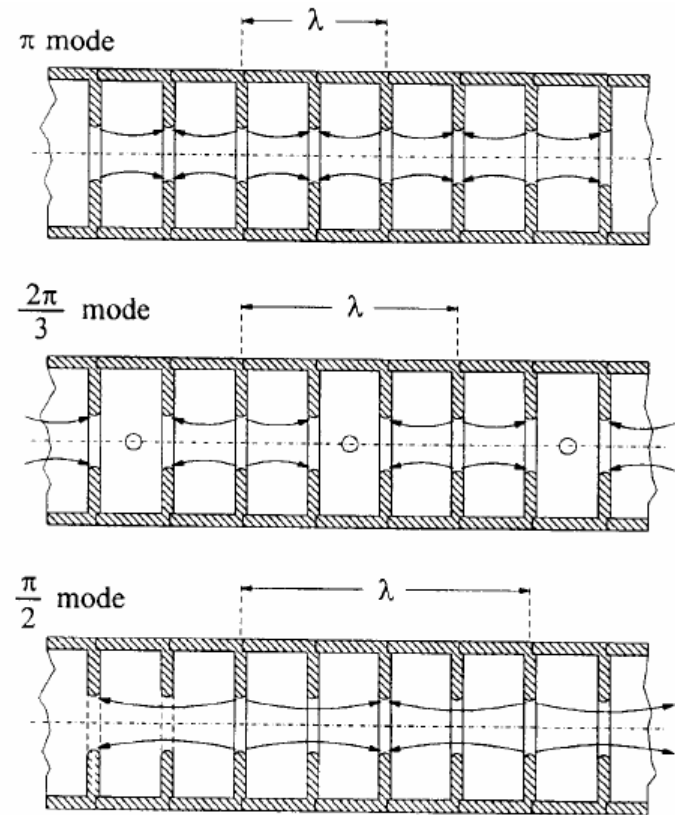

Field configurations of three most important modes in linac structures.

Power Generators for Accelerators

- ❑ The sinusoidal power needed to drive the accelerating structures ranges between a few kW to a few MW.
 - ❑ RF power amplifiers
 - ❑ Triodes & tetrodes: few MHz to few hundred MHz
 - ❑ Klystrons: above a few hundred MHz
 - ❑ Proven to be the most effective power generator for accelerator applications
-

Triode Amplifier

- Three active electrodes
 - Cathode (filament)
 - Grid
 - Anode (plate)
- Anode current obeys Langmuir-Child Law

$$I_a = k (V_a + \mu V_g)^{3/2}$$

- k = perveance of tube
- μ = amplification factor
- V_a = anode voltage
- V_g = grid voltage

Tetrode Amplifier

- ❑ Four active electrodes
 - ❑ Cathode (filament)
 - ❑ Control Grid
 - ❑ Screen Grid – reduce space charge between cathode and Control Grid
 - ❑ Anode (plate)
- ❑ Anode current obeys Langmuir-Child Law

$$I_a = k \left(V_{cg} + \mu_s V_{sg} + \mu_a V_a \right)^{3/2}$$

- ❑ k = perveance of tube
- ❑ μ_a = anode amplification factor
- ❑ μ_s = screen grid amplification factor
- ❑ V_a = anode voltage
- ❑ V_{cg} = control grid voltage
- ❑ V_{sg} = screen grid voltage

Klystrons

Principle of operation

- Electrons emitted from round cathode with large surface area.
- Accelerated by voltage of a few tens of kV.
- Yields a round beam with a current of between a few amperes and tens of amperes.
- Electrodes close to the cathode focus the beam and solenoid along the tube ensure good beam collimation.
- Outgoing particles from cathode have a well-defined velocity and pass through cavities operated in TM_{011} mode.
- Wave excited in this resonator by external pre-amplifier.

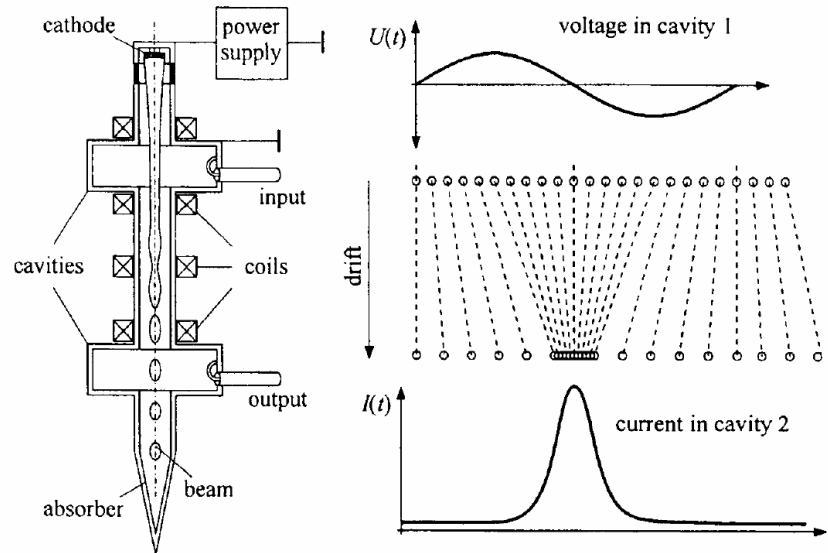

Klystrons are similar to a small linear accelerator.

Klystrons

- ❑ Depending on phase, will modulate velocity with resonant frequency of particles (accelerate, decelerate, or have no influence).
 - ❑ In subsequent zero-field drift, faster particles move ahead, while slower ones lag behind.
 - ❑ Changes hitherto uniform particle density distribution and bunches of particles are formed with separation given by λ of driving wave.
-

Klystrons

- ❑ Continuous current from cathode becomes pulsed current with frequency of coupled pulsed current.
 - ❑ A second cavity mounted at this location is resonantly excited by pulsed current and the RF wave generated in this second cavity is then coupled out.
 - ❑ A better coupling of beam to output cavity achieved by inserting additional cavity resonators, each tuned to frequencies close to operating frequency.
-

Klystrons

□ Klystron output power

$$P_{klystron} = \eta U_0 I_{beam}$$

- U_0 = klystron supply voltage (e.g. 45 kV)
- I_{beam} = beam current (e.g. 12.5 A)
- η = klystron efficiency (45% - 65%)

Large Hadron Collider (LHC)

Superconducting Cavities (SC)

- ❑ The use of superconducting material (Nb) at low temperature (2-4 K) reduces considerably the ohmic losses and almost all the RF power from the source is made available to the beam (i.e. ~100% efficiency).
 - ❑ In contrast to normal conducting cavities, SC cavities favour the use of lower frequencies.
 - ❑ Offers a larger opening to the beam.
 - ❑ Reduces the interaction of the beam with the cavity that is responsible for beam instability.
-

Superconducting Cavities

❑ Characteristics

- ❑ Q_0 as high as $10^9 - 10^{10}$ are achievable.
 - ❑ Leads to much longer filling times.
 - ❑ Higher electric field gradients are reached for acceleration – 25-30 MV/m.
 - ❑ Reduces number of cavities or a higher energy can be reached with a given number of cavities.
 - ❑ Single-cell or multi-cell.
 - ❑ Used for both lepton and hadron machines.
-

Parameter Specification

- ❑ Two independent RF systems.
 - ❑ One per each beam cooled with 4.5 K saturated He gas
- ❑ Each RF system has eight single-cell cavities
 - ❑ Each cavity has 2 MV accelerating voltage, corresponding to a field strength of 5.5 MV/m
 - ❑ $R/Q = 45 \Omega$
- ❑ RF Power System
 - ❑ Each cavity is driven by individual RF system with a single klystron, circulator and load.
 - ❑ Maximum of 4800 kW of RF power will be generated by the 16 (300 kW) 400 MHz klystrons.
 - ❑ Each klystron will feed via a Y-junction circulator and a WR2300 waveguide line, a single-cell SC cavity.
 - ❑ High Voltage Interface
 - ❑ Each of the 4 main 100 kV power converters, re-used from LEP, will power 4 klystrons.

Large Hadron Collider

The Main Beam and RF Parameters

	Unit	Injection 450 GeV	Collision 7 TeV
Bunch area (2σ)*	eVs	1.0	2.5
Bunch length (4σ)*	ns	1.71	1.06
Energy spread (2σ)*	10^{-3}	0.88	0.22
Intensity per bunch	10^{11} p	1.15	1.15
Number of bunches		2808	2808
Transverse emittance V/H	μm	3.75	3.75
Intensity per beam	A	0.582	0.582
Synchrotron radiation loss/turn	keV	-	7
Longitudinal damping time	h	-	13
Intrabeam scattering growth time - H	h	38	80
- L	h	30	61
Frequency	MHz	400.789	400.790
Harmonic number		35640	35640
RF voltage/beam	MV	8	16
Energy gain/turn (20 min. ramp)	keV	485	
RF power supplied during acceleration/ beam	kW	~275	
Synchrotron frequency	Hz	63.7	23.0
Bucket area	eVs	1.43	7.91
RF (400 MHz) component of beam current	A	0.87	1.05

Cavity Material

- ❑ As frequency of 400 MHz is close to that of LEP (352 MHz), the same proven LEP technology of Nb sputtered cavities is applied to the LHC.
- ❑ Nb Sputtering on Cu
 - ❑ Advantage over solid Nb in that susceptibility to quenching is very much reduced.
 - ❑ Local heat generated by small surface defects or impurities is quickly conducted away by the Cu.
 - ❑ Nb-sputtered cavities are insensitive to the Earth's B-field

Large Hadron Collider

Design of a four-cavity cryomodule

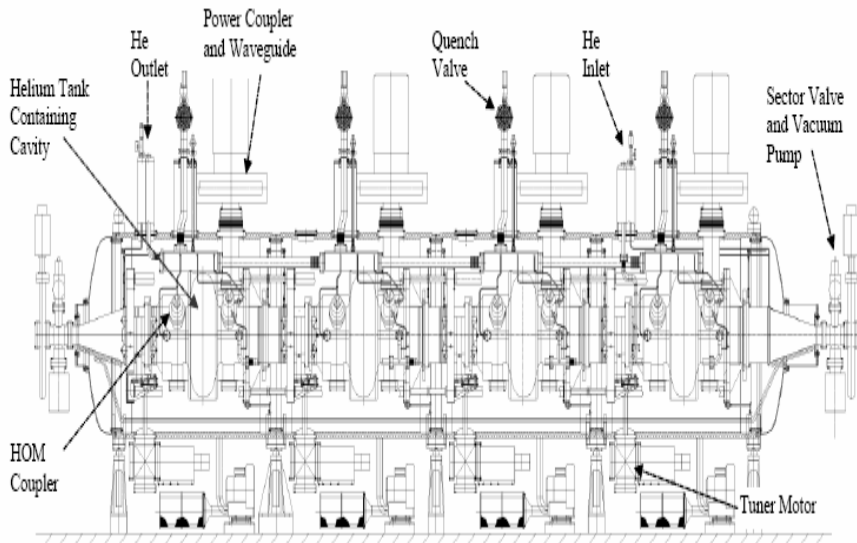

A four-cavity module during assembly



- Four cavities, each equipped with their He tank and power coupler, are grouped together in a single cryomodule.
- Reduces overall static thermal losses and requires less total space for installation than a single cavity configuration.

Linear Colliders

International Linear Collider Baseline Design

2

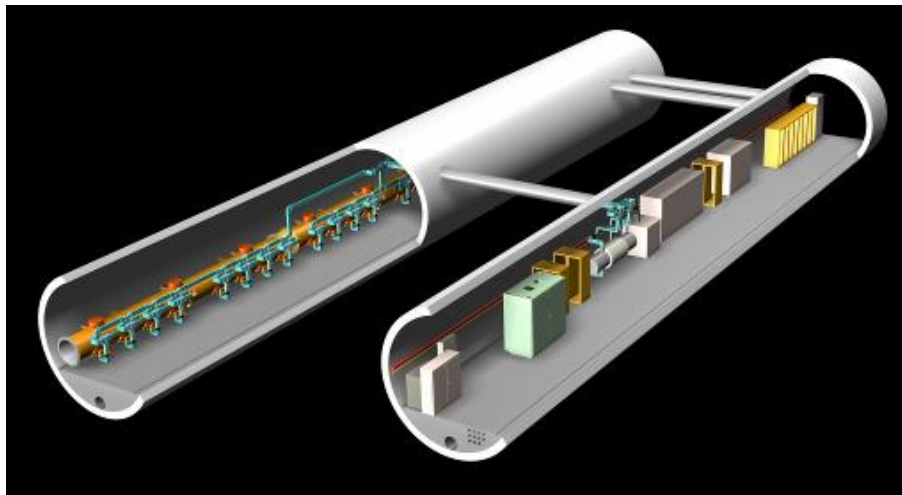
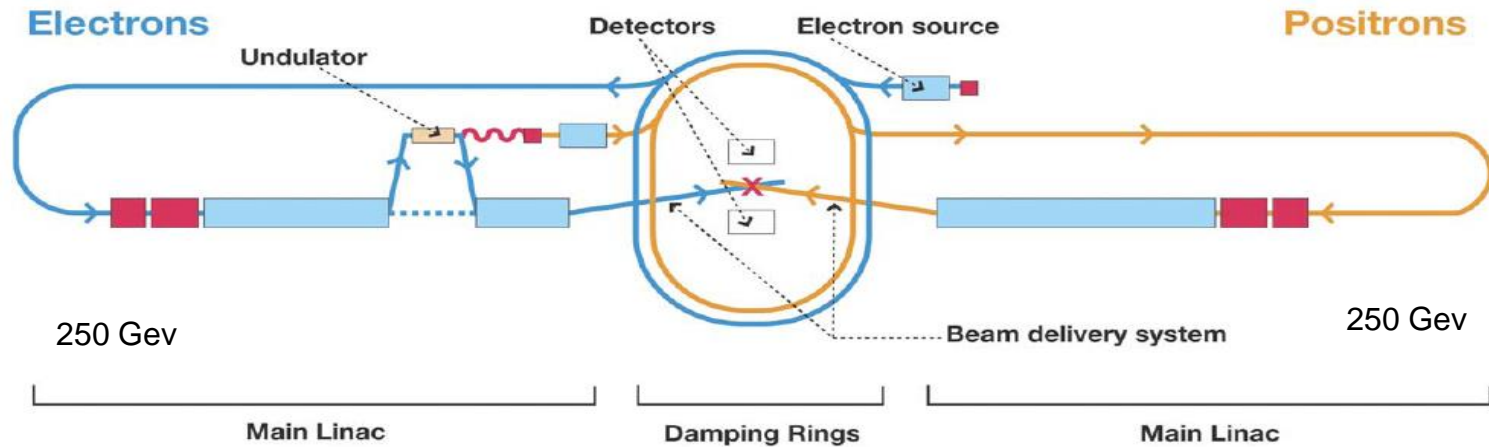

e+ e- Linear Collider

Energy	250 GeV x 250 GeV
# of RF units	560
# of cryomodules	1680
# of 9-cell cavities	14560
2 Detectors push-pull	
peak luminosity	$2 \cdot 10^{34} \text{ cm}^{-2}\text{s}^{-1}$
5 Hz rep rate, 1000 -> 6000 bunches	
IP : σ_x 350 – 620 nm; σ_y 3.5 – 9.0 nm	
Total power	~230 MW
Accelerating Gradient	31.5 MeV/m

Cavities

- ❑ Basic element of the superconducting RF is a nine-cell 1.3 GHz niobium cavity
 - ❑ Each cavity is about 1 m. long
 - ❑ Operated at 2K
 - ❑ Nine cavities are mounted together in a string and assembled in a common low-temperature cryostat (cryomodule)
 - ❑ About 17 000 cavities are needed for the ILC
 - ❑ Key to high-gradient performance is ultra-clean and defect-free inner surface of cavity consisting of Nb material and electron beam welds
 - ❑ Use of electropolishing in clean-room environment
-

Cavity Design Parameters

ILC 9-cell superconducting cavity design parameters

Parameter	Value
Type of accelerating structure	Standing Wave
Accelerating Mode	TM ₀₁₀ , π mode
Fundamental Frequency	1.300 GHz
Average installed gradient	31.5 MV/m
Qualification gradient	35.0 MV/m
Installed quality factor	$\geq 1 \times 10^{10}$
Quality factor during qualification	$\geq 0.8 \times 10^{10}$
Active length	1.038 m
Number of cells	9
Cell to cell coupling	1.87%
Iris diameter	70 mm
R/Q	1036 Ω
Geometry factor	270 Ω
$E_{\text{peak}}/E_{\text{acc}}$	2.0
$B_{\text{peak}}/E_{\text{acc}}$	4.26 mT MV ⁻¹ m ⁻¹
Tuning range	± 300 kHz
$\Delta f/\Delta L$	315 kHz/mm
Number of HOM couplers	2

Superconducting RF Structures

A TESLA nine-cell 1.3 GHz superconducting niobium cavity.



ILC prototype cryomodules.

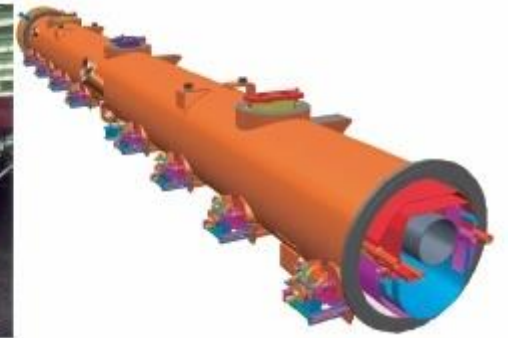

Clean room environments are mandatory for the cavity preparation and assembly.



Multi-Beam Klystrons

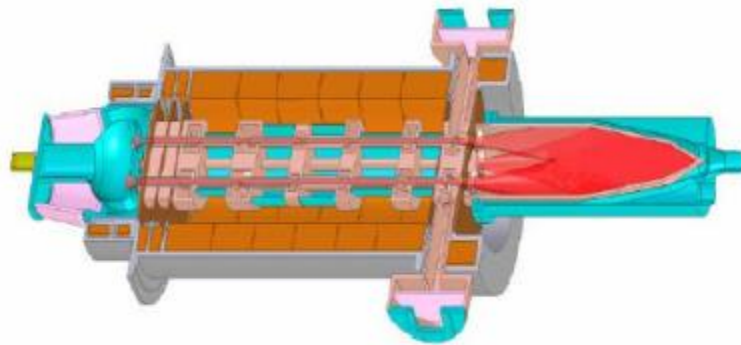

Toshiba E3736



10 MW L-band source

The Full CLIC scheme

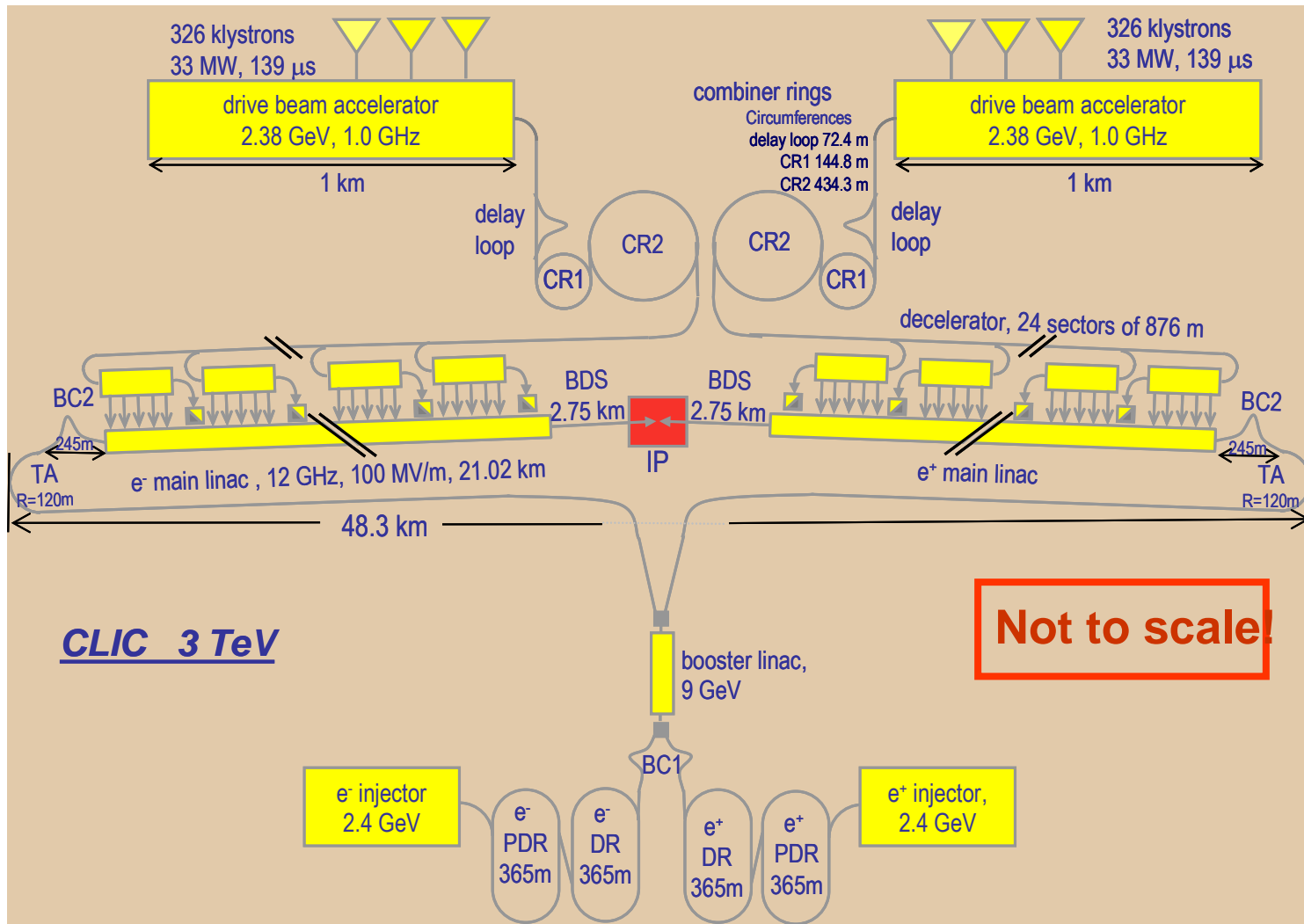

CLIC Accelerating Module

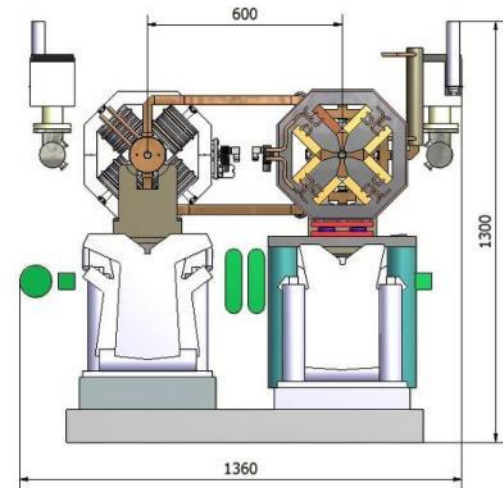
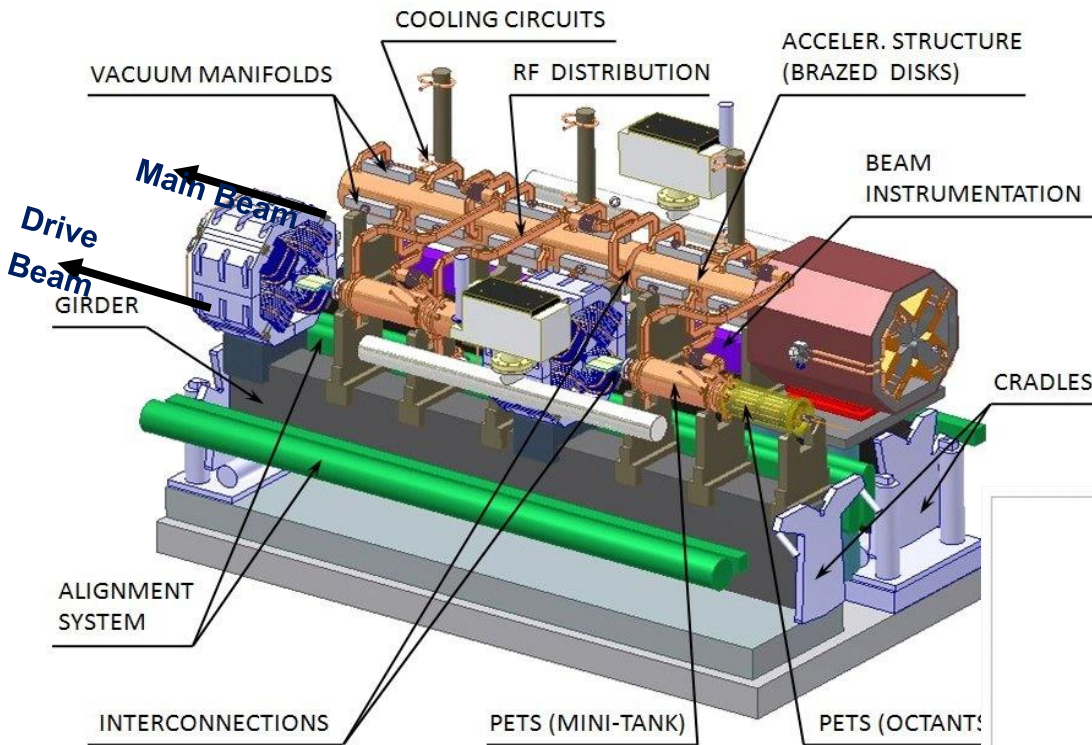

Transfer lines

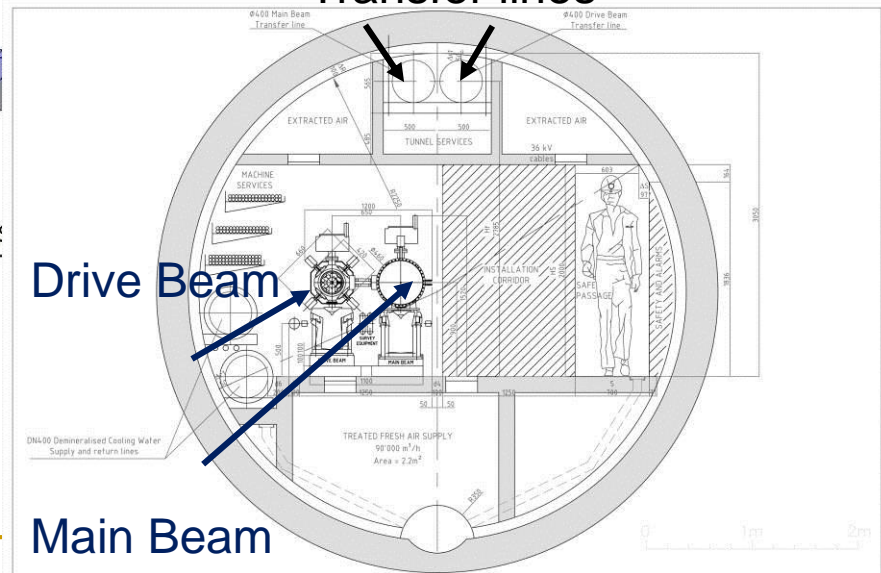

Accelerating Structures

Objective:

- Withstand of 100 MV/m without damage
- breakdown rate $< 10^{-7}$
- Strong damping of HOMs

Technologies:

Brazed disks - milled quadrants

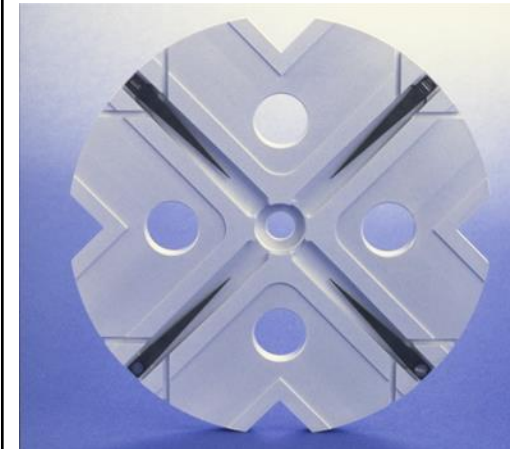
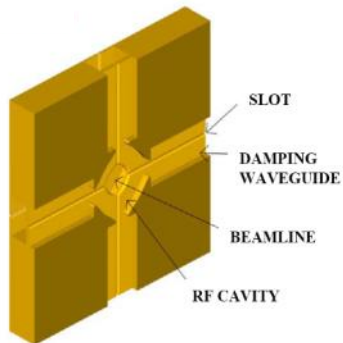
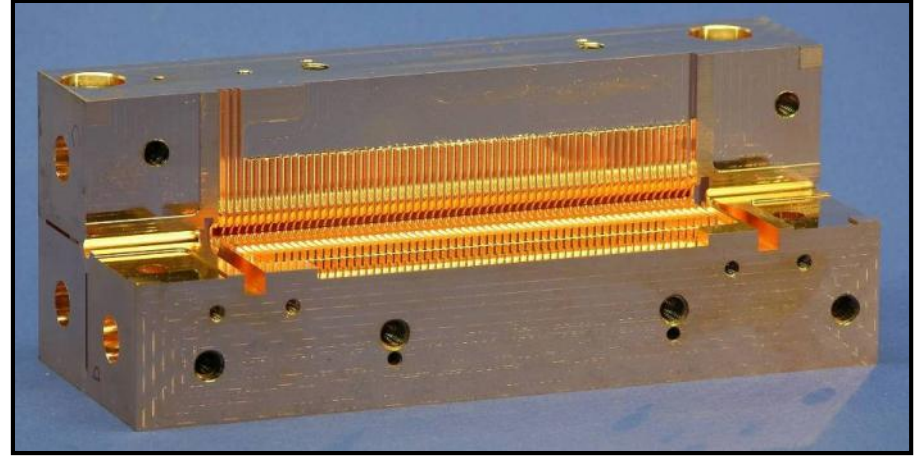

CLIC Two-beam Acceleration Concept

- 12 GHz modulated and high power drive beam
- RF power extraction in a special structure (PETS)
- Use RF power to accelerate main beam

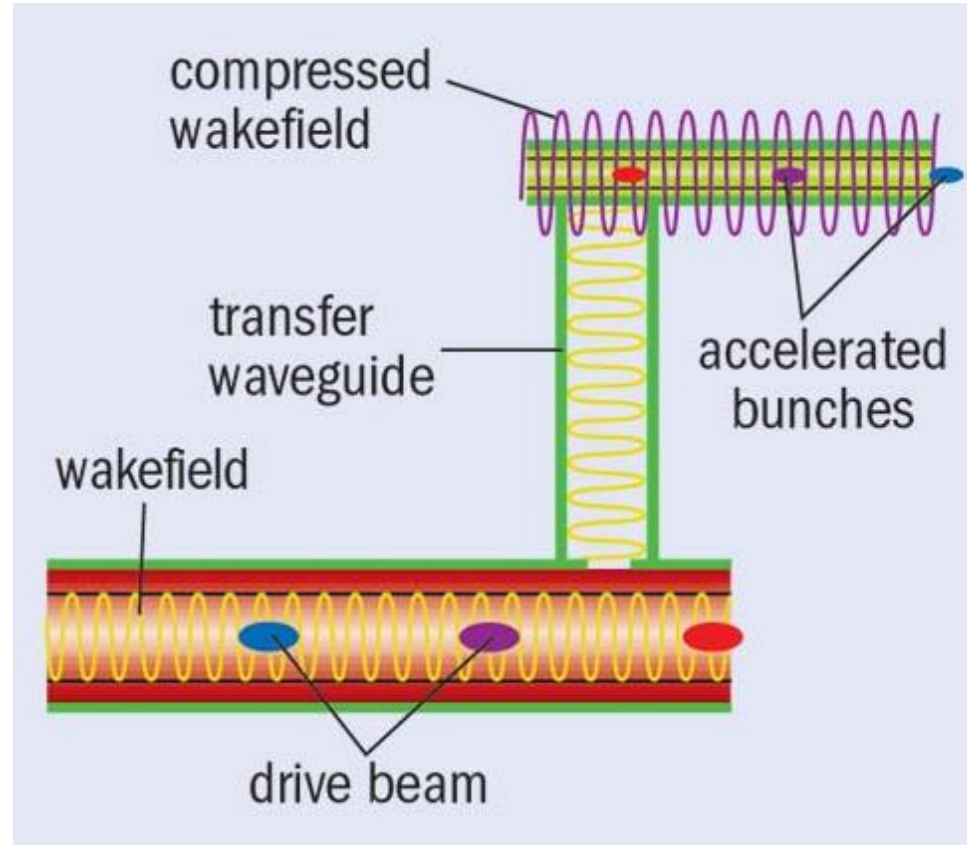

Simulation of RF Power Transfer

time: 00.0 ns

Accelerating structure

Surfer riding the wave

PETS structure

The induced fields travel along the PETS structure and build up resonantly

Decelerating structure



Accelerating Cavities

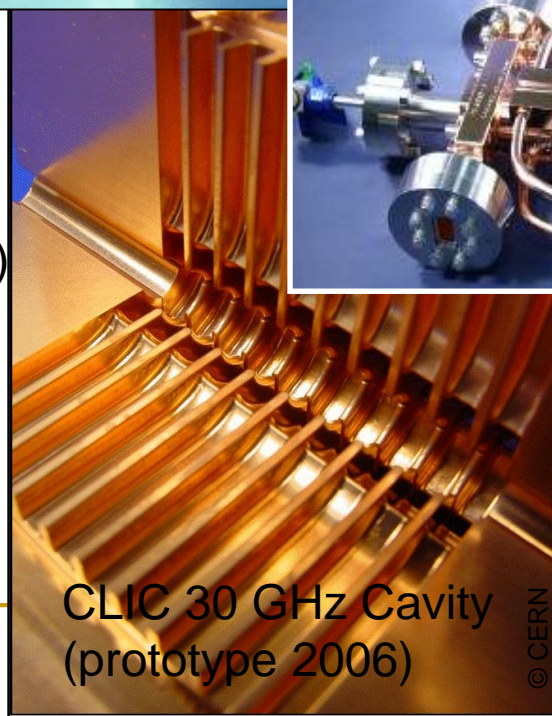
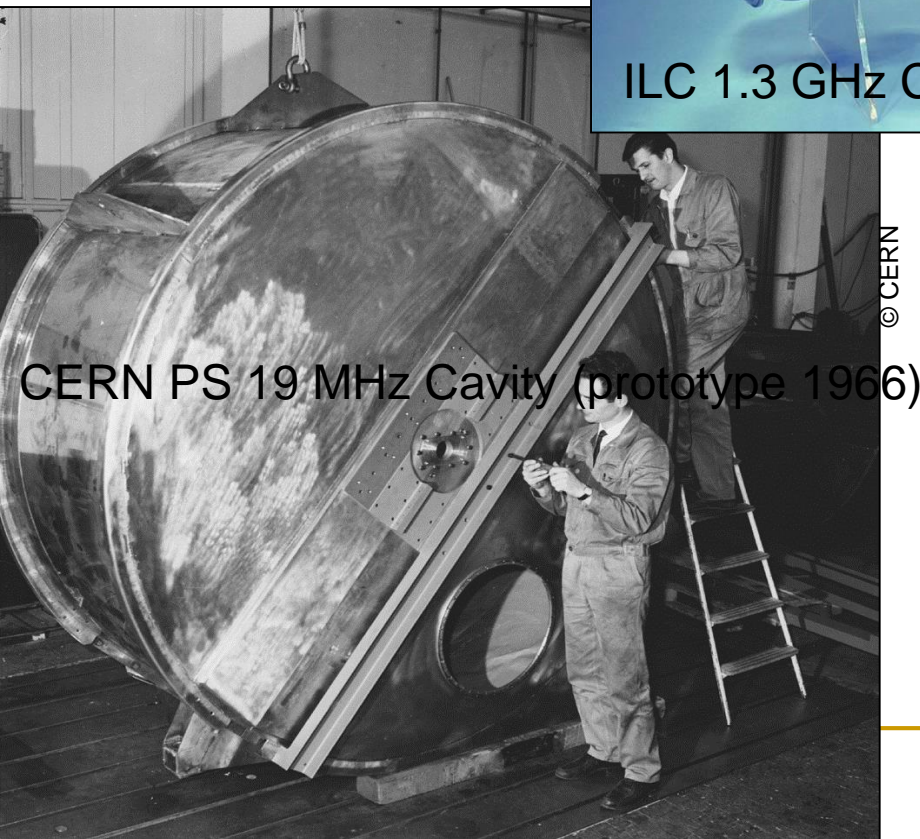
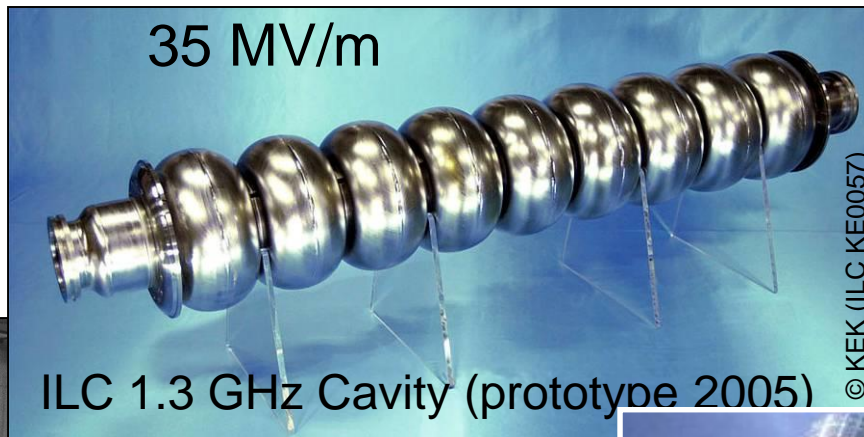

Acknowledgments and References

- John David Jackson, *Classical Electrodynamics*, John David Jackson, 1998
 - Klaus Wille, *The Physics of Particle Accelerators*, Oxford University Press, 2005
 - Edmund Wilson, *An Introduction to Particle Accelerators*, Oxford University Press, 2006
-