

***LATTICE***

***DESIGN I***

***Lecture 2***  
***January 2017***

***P.J. Bryant***

# *The central orbit is usually simple*

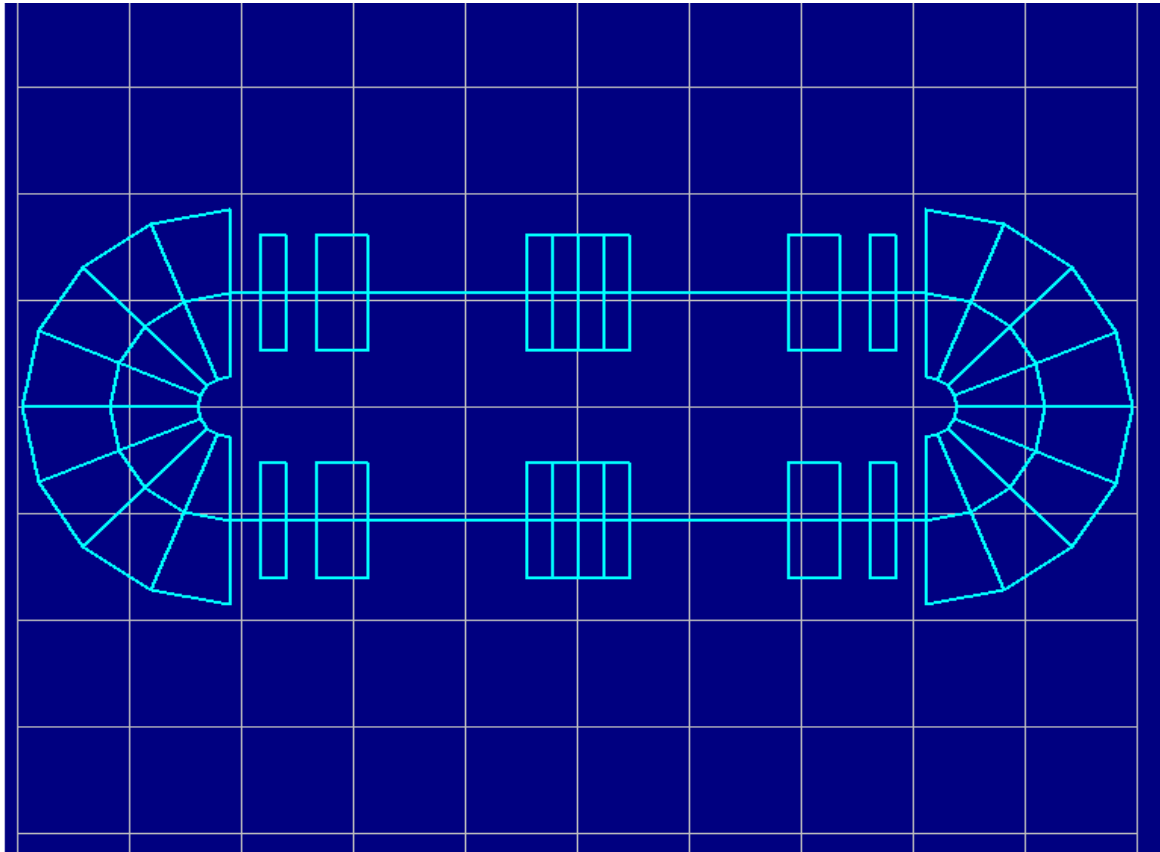

- ❖ Example racetrack lattice with two 180 degree dipoles and various quadrupoles and sextupoles.
- ❖ **The central orbit passes straight through the centres of the lenses and is circular in each dipole.**
- ❖ Lattice programs will calculate the geometry after the specification of the elements.
- ❖ Some rings and transfer lines can be more complicated. There is a suite of routines in WinAGILE on the CD-ROM for calculating the more difficult cases.

# Dipole types and edge focusing

## ❖ Sector dipole (SBEND)

This 'shape' is used in the derivation of the motion equation and often appears in older machines.

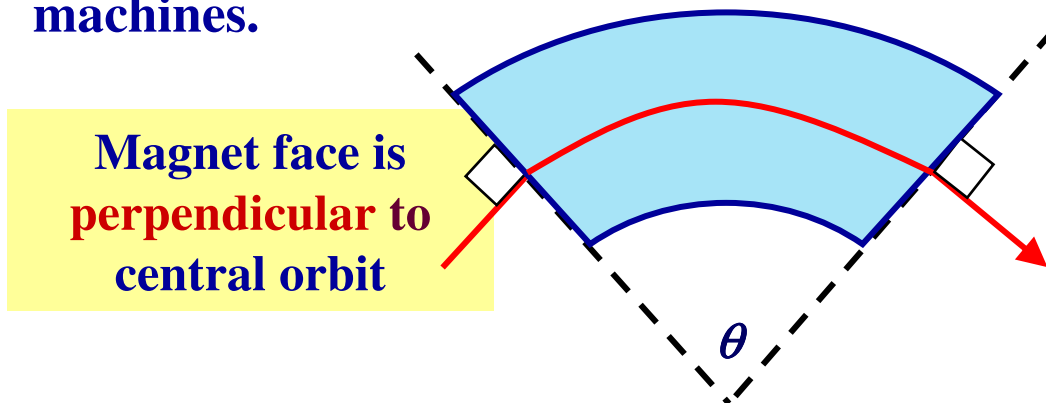

## ❖ Rectangular dipole (RBEND)

Modern lattices usually use rectangular dipoles. This 'shape' excites edge focusing.

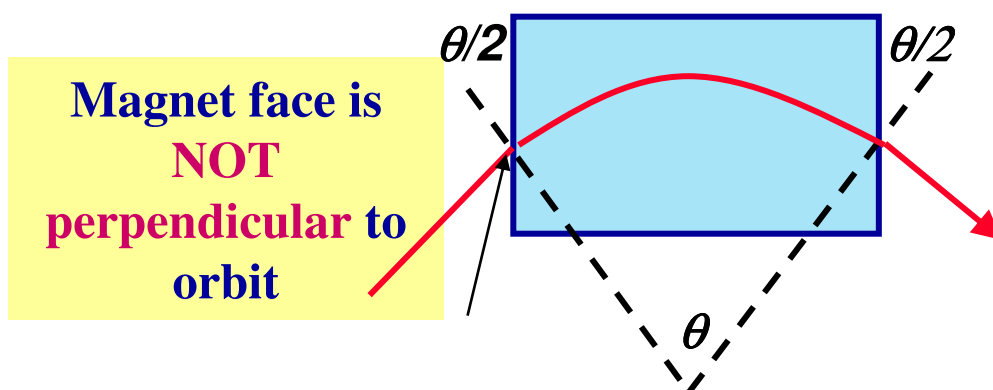

## ❖ General dipole (SBEND + edge angles)

Some dipoles have edges inclined at special angles. These are modeled by a SBEND with edge angles. *In fact, the SBEND can cover all cases and the RBEND is a convenience definition.*

*NOTE all cases have the same central-orbit geometry.*

# FODO cell

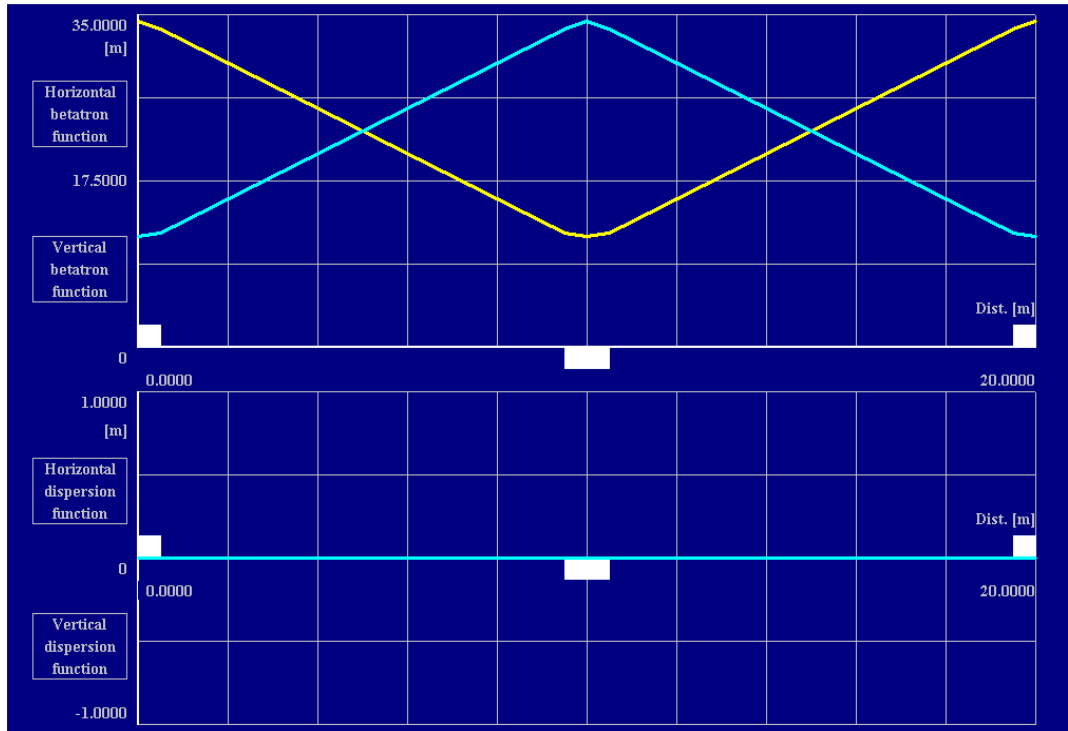

- ❖ The basic FODO cell is the best known and studied cell in lattice optics.
- ❖ The usual choices for phase advances are  $45^\circ$ ,  $60^\circ$  and  $90^\circ$ . The  $60^\circ$  cell has the best all-round characteristics and is close to the minimum beam sizes obtained at  $\sim 76^\circ$ .
- ❖ In the above example:  $\Delta\mu=60^\circ$ ,  $k_F = -0.1035$ ,  $k_D = 0.1035$  and  $L_{\text{cell}} = 20$  m.

Note an 'F quadrupole' is denoted by a box above the axis and a 'D' by a box below the axis. Dipoles are denoted by a box extending above and below.

# FODO with dipoles

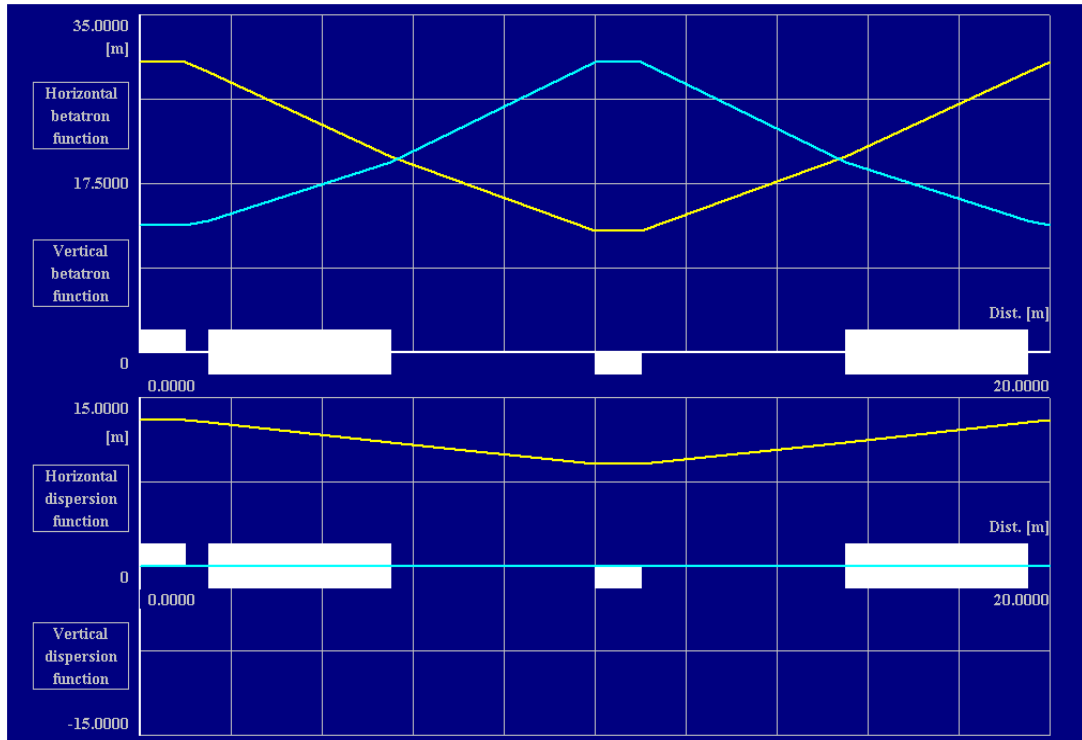

- ❖ The addition of dipoles changes the focusing slightly and introduces dispersion.
- ❖ In the above example:  $\Delta\mu_x = 60^\circ$ ,  $\Delta\mu_y = 60^\circ$ ,  $k_F = -0.0722$ ,  $k_D = 0.0915$ ,  $\theta_H = 0.2618$  rad and  $L_{\text{cell}} = 20$  m. The dipoles are sector bends.

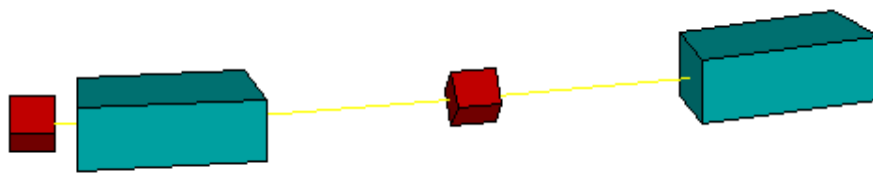

**Note.** In a dipole, the  $1/\rho^2$  term focuses only in the plane of bending. This is the total focusing effect in a sector dipole. In rectangular dipoles, the edges subtract from the  $1/\rho^2$  term reducing it to zero and add focusing to the orthogonal plane.

# A regular ring using a FODO

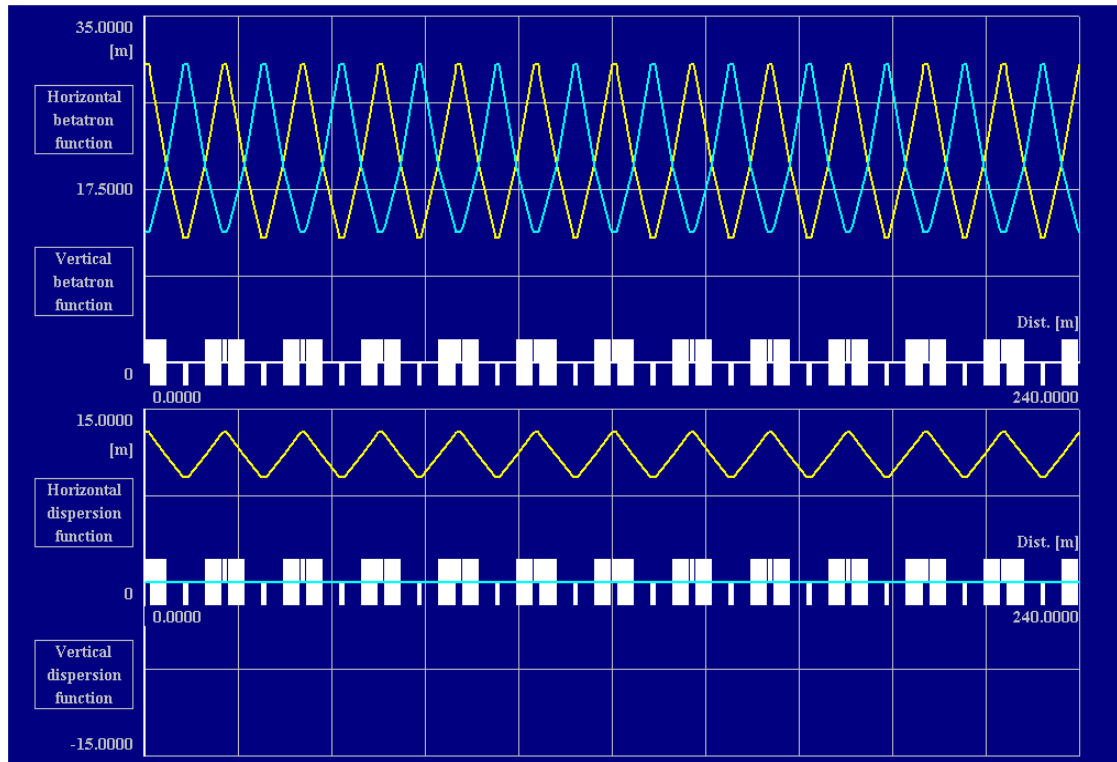

- ❖ Using a simple cell we can make a ring, **BUT** the drift spaces tend to be too short for extraction and injection.

Note that the dipoles have been placed in  $\beta_y$  minima to save power.

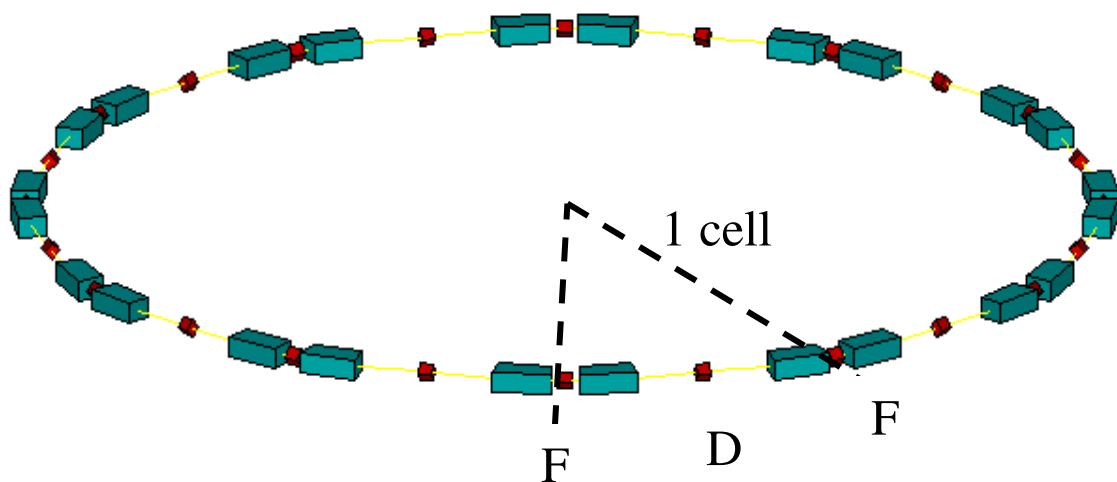

# A ring using a split FODO

- ❖ Here the F and D quads are split into 2 units. Between the 'split' quads, the betatron amplitude functions are quasi-constant.
- ❖ Unlike the previous lattice, the dipoles sit around  $\beta_y$  max. because in this example the requirements of a light source take precedence over the aperture and cost of the magnets.

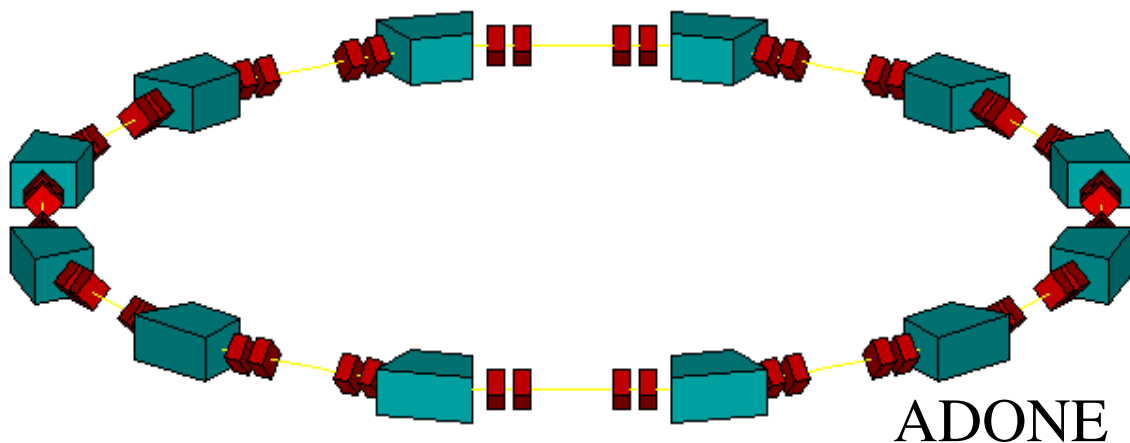
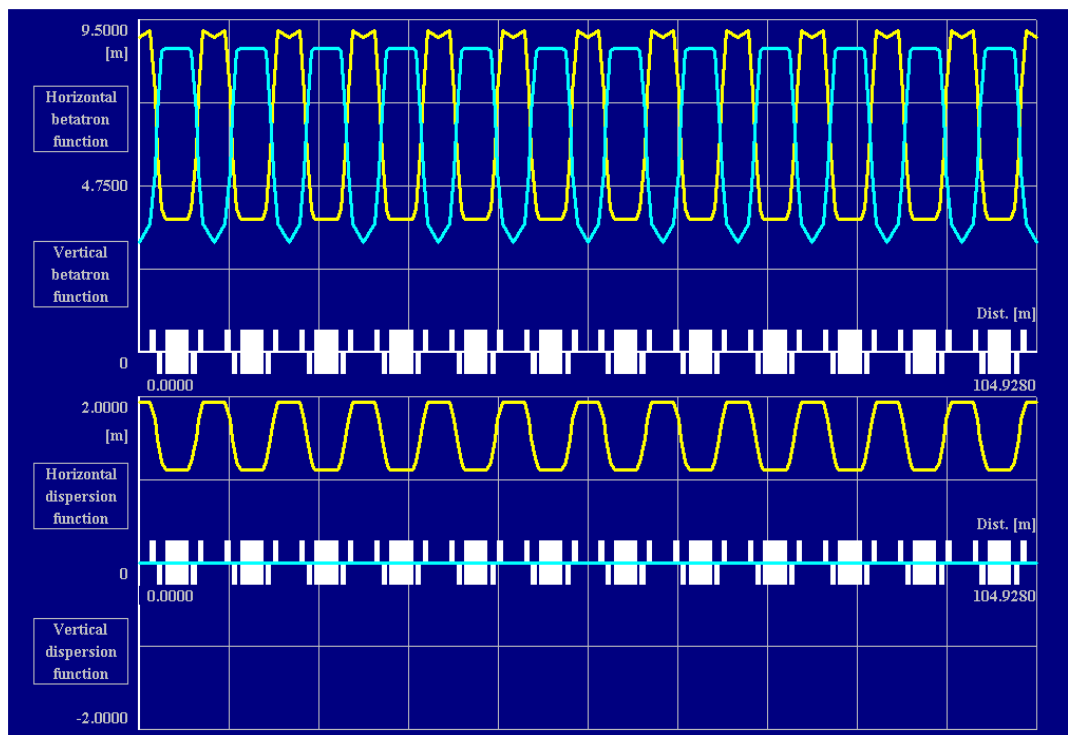

# *A ring using a doublet*

- ❖ Another way to make the space in a FODO more useful is to move the central quadrupole to one side. This effectively creates pairs of quads, or doublets.
- ❖ Doublets have been very popular, but they do cause large peaks and steep asymmetric slopes in the betatron amplitude functions.

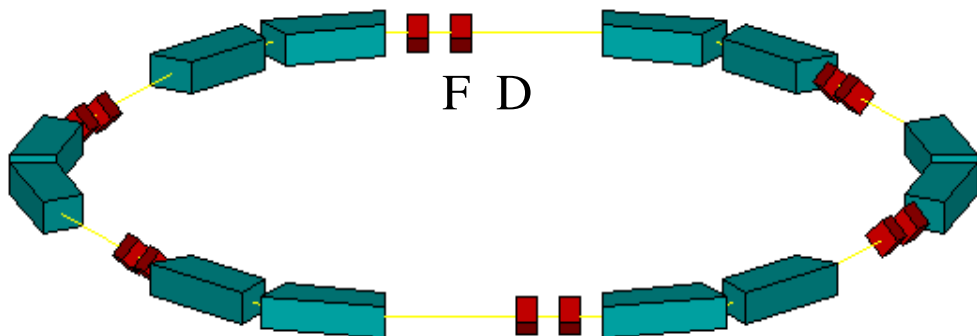
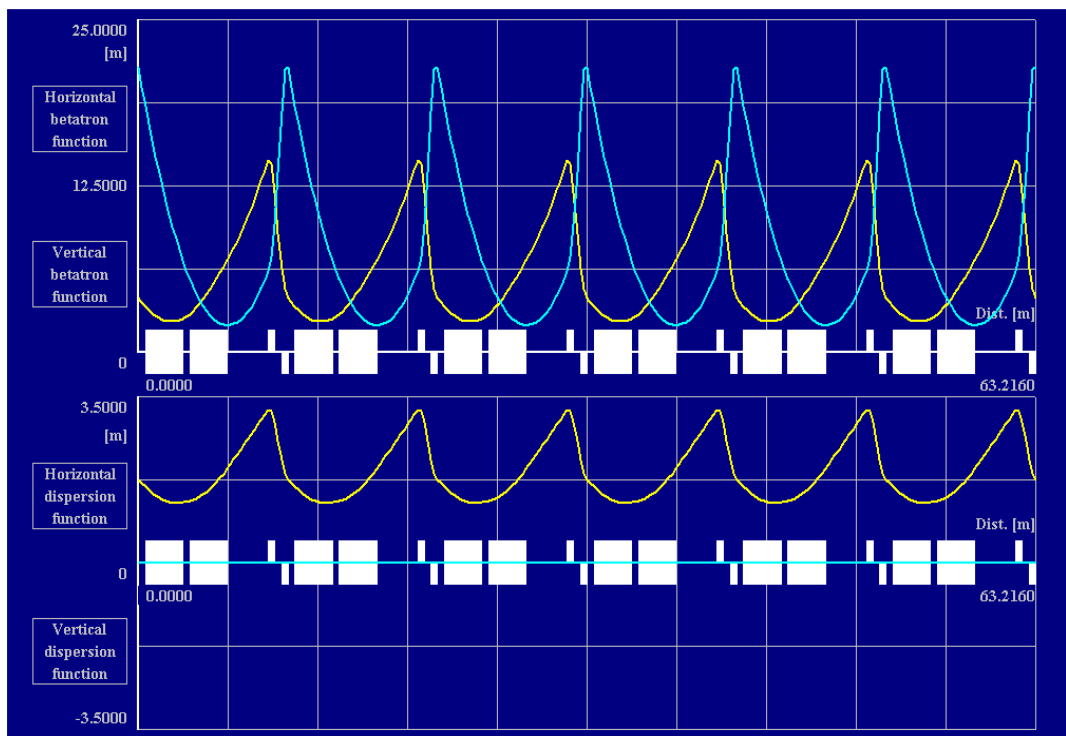

GSI medical ring



# *Controlling dispersion*

- ❖ All the rings shown so far simply repeat a standard cell  $n$  times to reach  $2\pi$  of bending.
- ❖ This works for plain accelerators and often leads to an economical solution in which all quadrupoles for example are powered by a single power converter.
- ❖ In more advanced lattices, we would like to have regions with zero dispersion e.g. for RF cavities. This is done in small rings by closing the dispersion in bumps. For large rings, see later.
- ❖ To close a dispersion bump one needs a phase advance of  $180^\circ$  to  $360^\circ$  in the plane of bending.
- ❖ This leads to solutions for rings with two, or three or four or more closed dispersion bumps separated by dispersion-free sections.
- ❖ Each closed bump forms a ‘corner’ and the ring looks ‘triangular’ or ‘square’ or ‘pentagonal’ and so on.

# Closing a dispersion bump

## ❖ Case 1. The half-wavelength bump

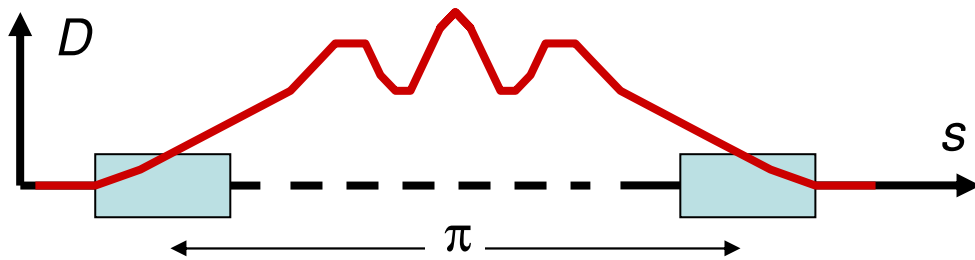

Possible where 2 short magnets can provide all of the required bending.

## ❖ Case 2. Uniformly distributed bending

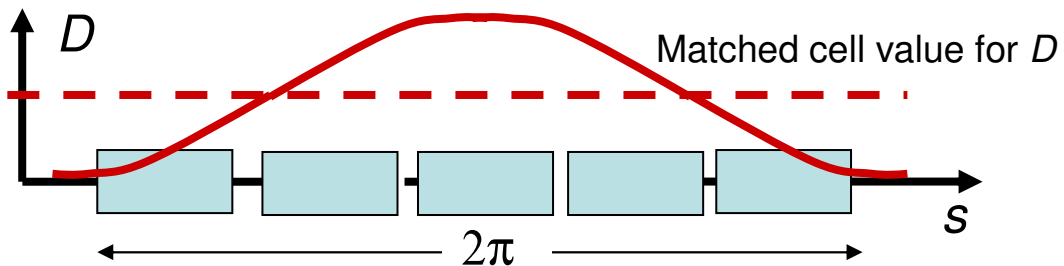

When the bending is uniformly distributed, the dispersion  $D$  oscillates about the equilibrium value of the matched cell.

## ❖ Case 3. Hybrid

Often the lattice of a small ring will be a mixture of the two limiting cases above.

# A ring using a triplet

- ❖ A triplet is another possible cell for a ring.
- ❖ In this example, the large horizontal phase advance at the centre of the triplet is used to make 3 closed, half-wave, dispersion bumps.
- ❖ The ‘waist’ in the vertical betatron amplitude in the long straight sections is used for the dipoles. This keeps the aperture requirements and cost down .

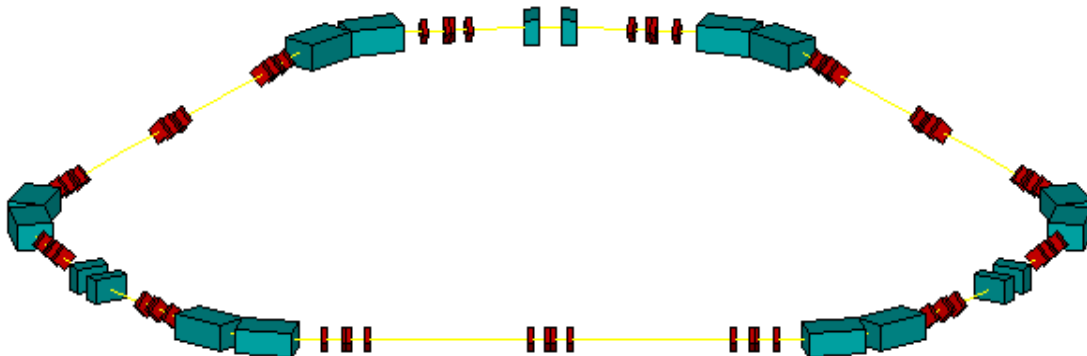
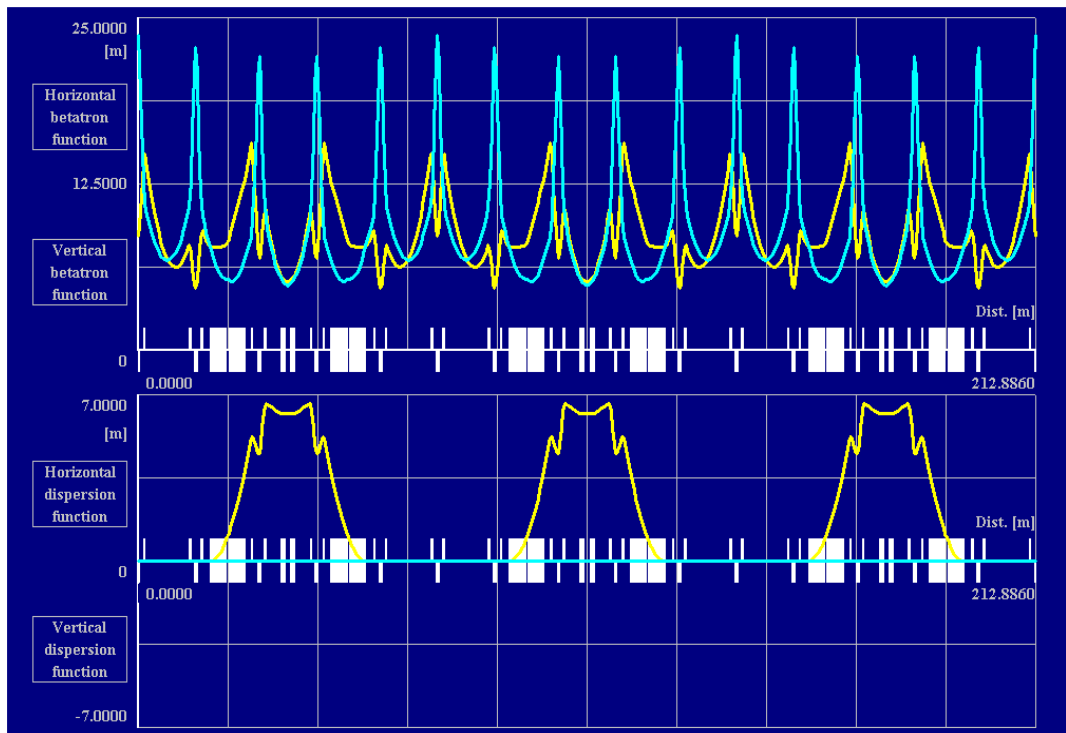

AUSTRON

# Characteristics of triplets

❖ **Phase advance**  $\mu_{s_1 \rightarrow s_2} = \int_{s_1}^{s_2} \frac{1}{\beta} ds$

❖ **Thus regions of low- $\beta$  give large phase advances.**

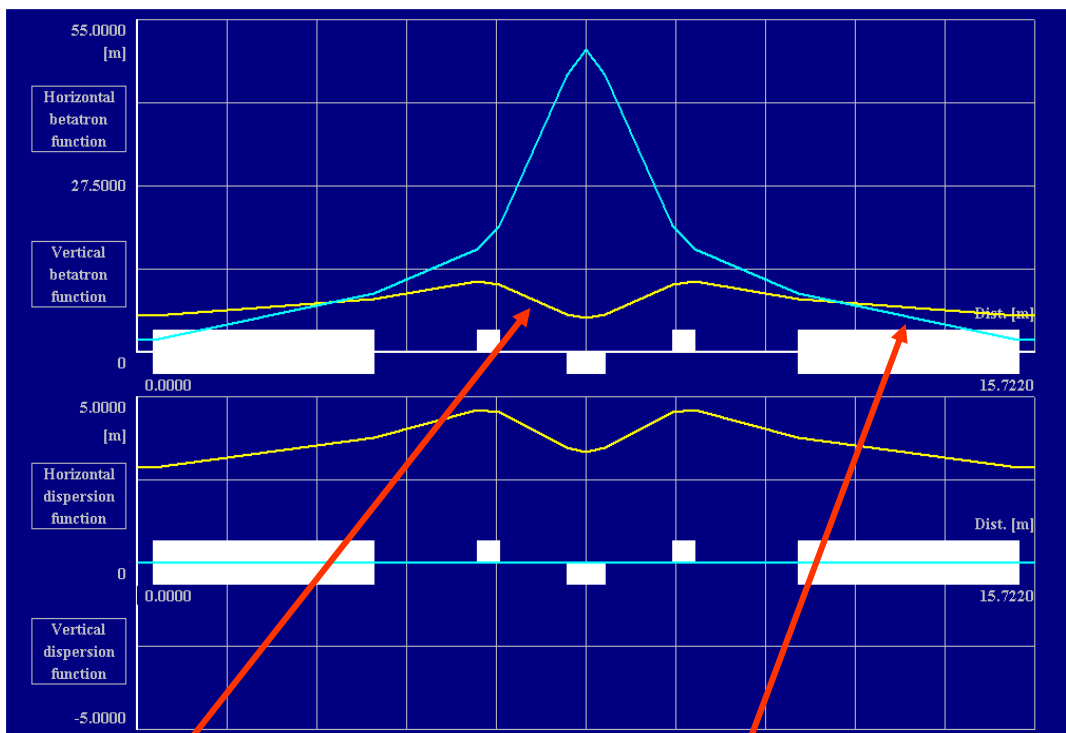

$\beta_x$  is kept small for large phase advance for closing dispersion bump

Small  $\beta_y$  in dipole saves money

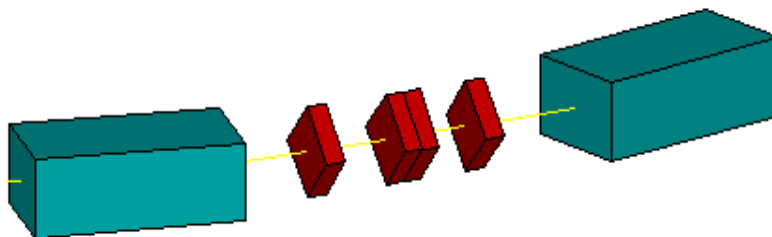

# Light source lattice

- ❖ Chasman-Greene, double-bend achromat, high-brightness lattice Ref. [2.1]. The aim is to minimise  $D_x(s)$  and  $\beta_x(s)$  in the dipoles.
- ❖ Each cell supports a closed, half-wave, dispersion bump. This example has 4 bumps making a ‘square’ ring.

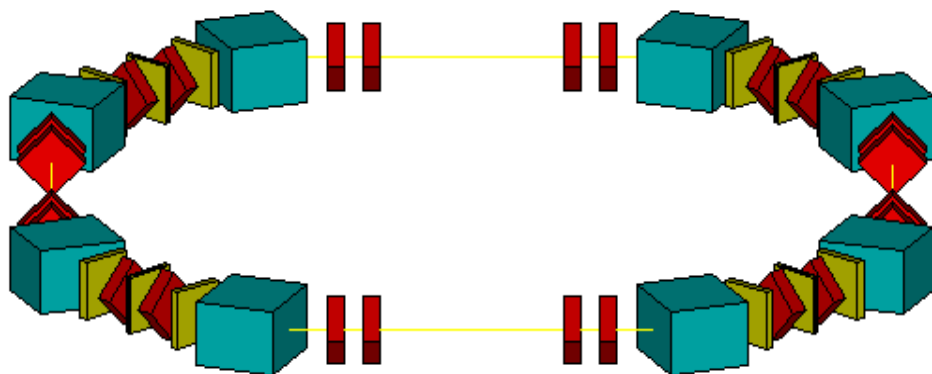
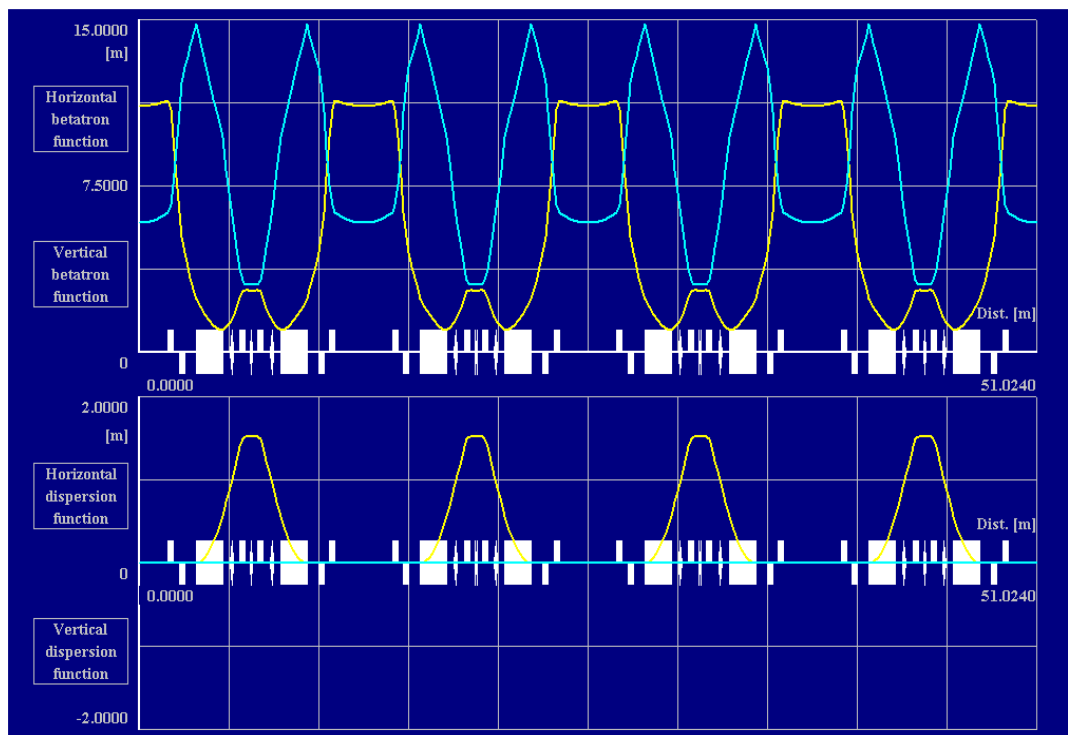

NLSL

# Medical machine lattice

- ❖ The PIMMS medical machine lattice.
- ❖ This ring has 2 dispersion bumps with distributed bending. Compared to the earlier examples, this creates a 'rounder' ring.

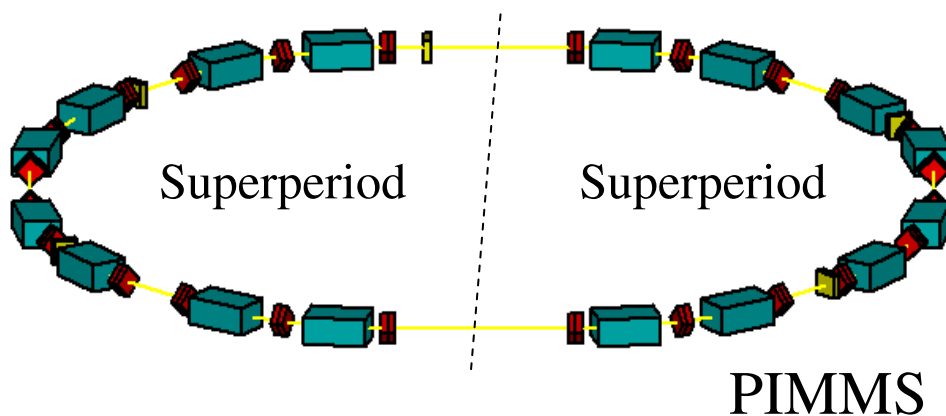
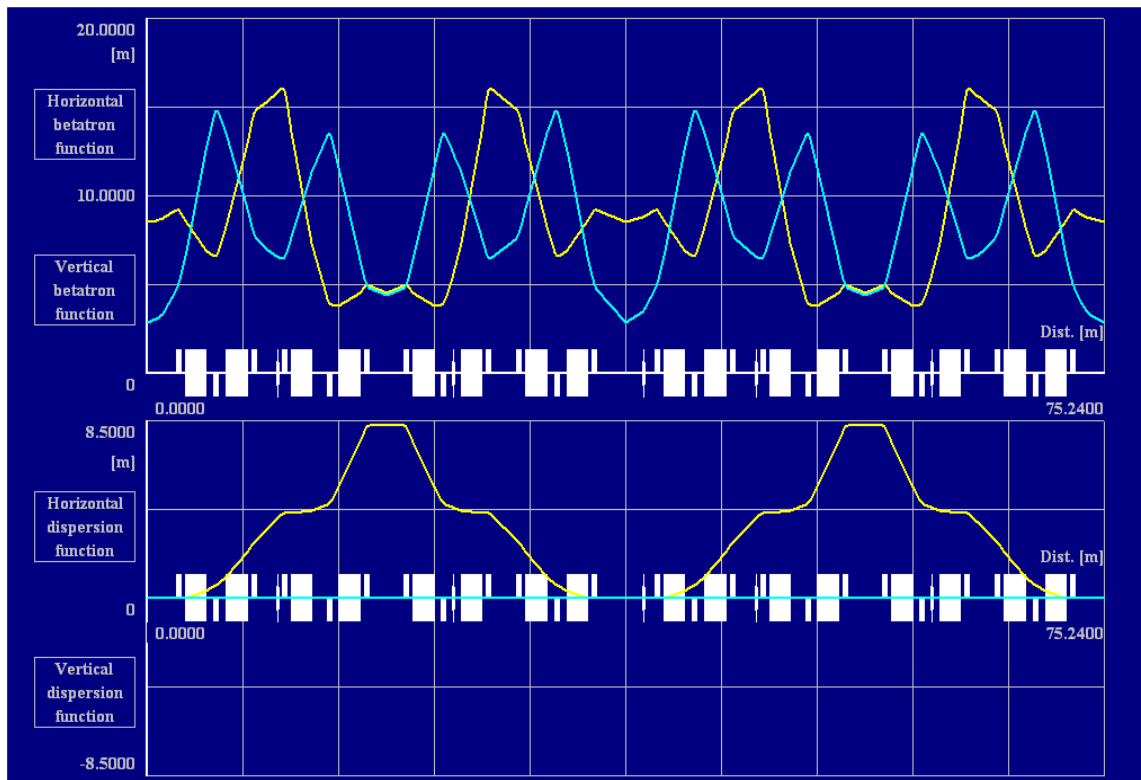

# Large rings

- ❖ Large rings, such as the LHC, often have a basic FODO cell in the arcs.
- ❖ The overall ring has an  $n$ -fold symmetry containing the  $n$ -arcs and  $n$  straight regions in which the physics experiments are mounted.
- ❖ Between the arc and the straight region there is the so-called *dispersion suppressor* that brings the dispersion function to zero in the straight region in a controlled way. There are several schemes for dispersion suppressors (see next slides).
- ❖ The straight regions contain the injection and extraction and the RF cavities, which, in an electron machine like LEP, can occupy hundreds of metres.
- ❖ A dispersion-free straight region may also host a low- $\beta$  insertion for physics or a collimation insertion.

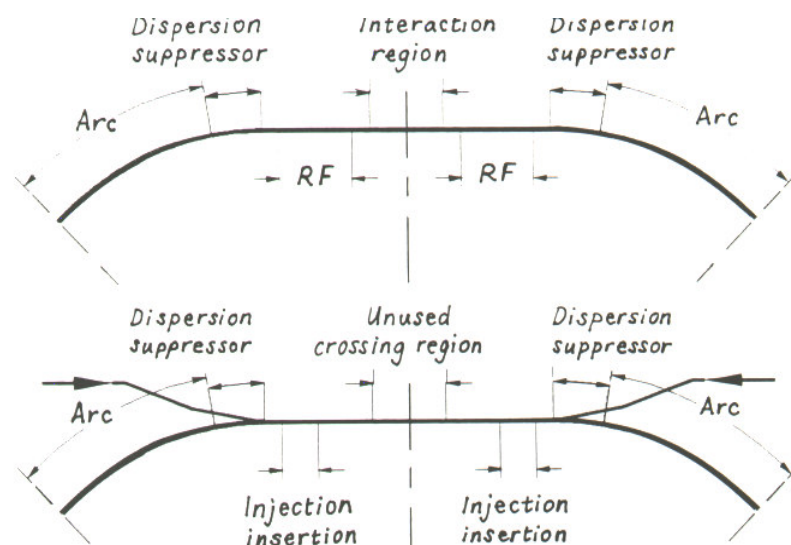

# Missing-magnet suppressor

- ❖ Lattice functions of a missing-magnet, dispersion suppressor for a 60° FODO cell. Note how  $\beta_x$  and  $\beta_y$  hardly notice the suppression of  $D_x$ .

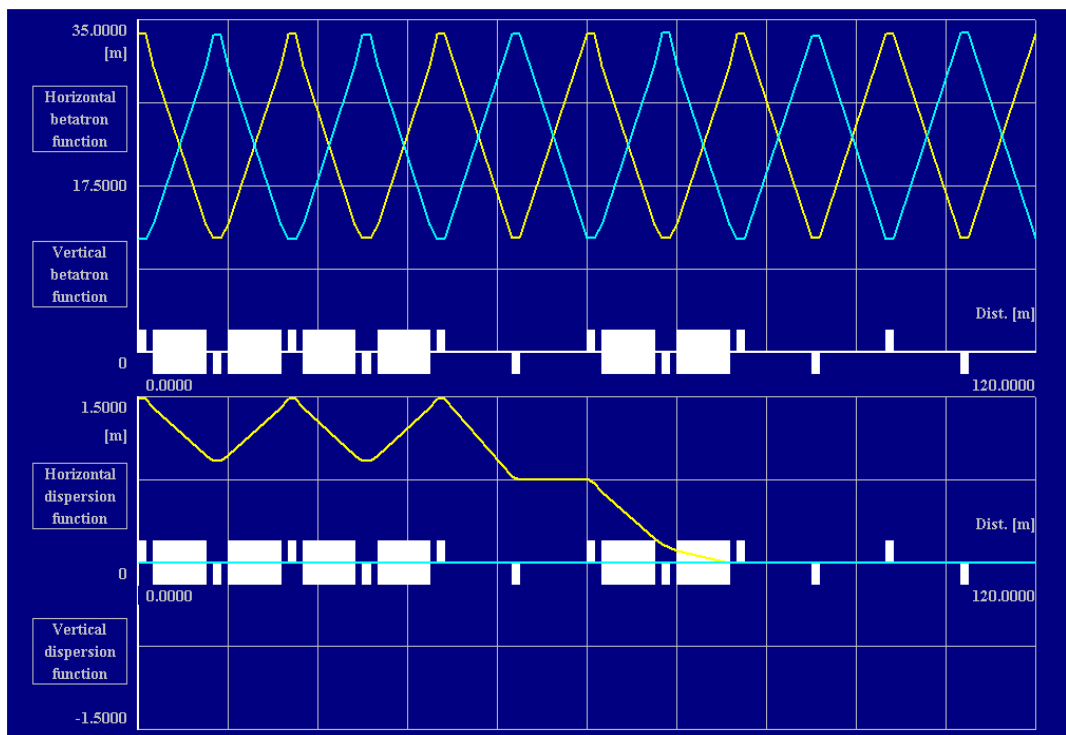

File name : DEMO-004 LATTICE ELEMENTS (On-Axis) Date of run: 11/  
 Treated as: transfer line Time of run: 8:4

User title: Demonstration FODO cell with 60deg phase advance and rectangular dip.

Unit no.	Name	Type	Length [m]	Hor. Mbend [rad]	Vert. Mbend [rad]	Edge angle-1 [rad]	Edge angle-2 [rad]	k-Mquad [1/m <sup>2</sup> ]
1	FQ	QUADR	1.0000	0.000000	0.000000	0.00000	0.00000	-0.103513
2	ss0	DRIFT	1.0000	0.000000	0.000000	0.00000	0.00000	0.000000
3	Dipole	RBEND	7.0000	0.030000	0.000000	0.01500	0.01500	0.000000
4	ss0	DRIFT	1.0000	0.000000	0.000000	0.00000	0.00000	0.000000
5	DQ	QUADR	1.0000	0.000000	0.000000	0.00000	0.00000	0.103513

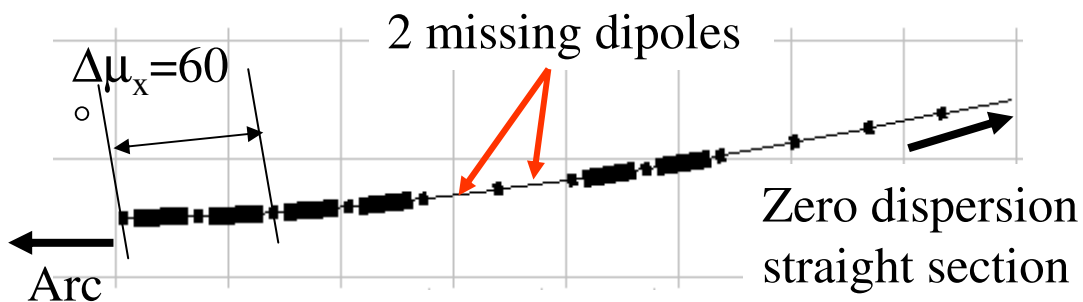



# Half-field suppressor

- ❖ Lattice functions of a half-field, dispersion suppressor for a  $60^\circ$  FODO cell. The functions  $\beta_x$  and  $\beta_y$  are visibly perturbed by the suppression of  $D_x$ .

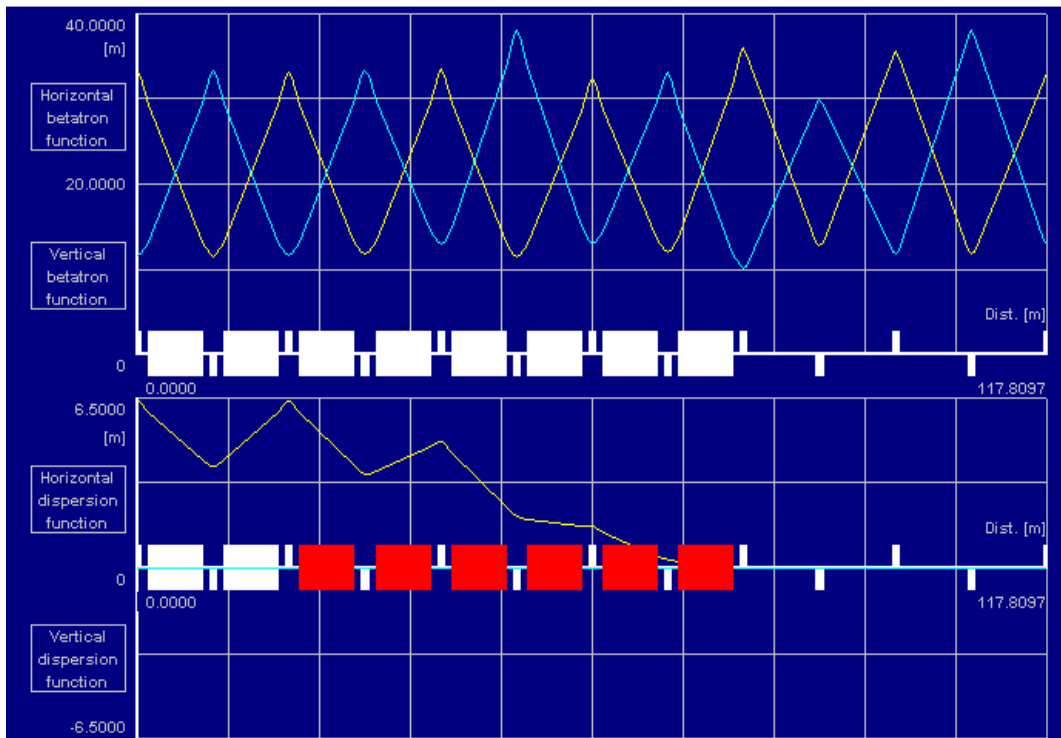

File name: Octant\_3 LATTICE ELEMENTS (On-Axis) Date of run: 11  
 Treated as: transfer line Time of run: 4:4  
 User title: Demo disp. suppr. with FODO cell with 60deg phase advance and RBEND.

Unit no.	Name	Type	Length [m]	Hor. Mbend [rad]	Vert. Mbend [rad]	Edge angle-1 [rad]	Edge angle-2 [rad]	k-Mquad [1/m <sup>2</sup> ]
1	FQH1	QUADR	0.4087	0.000000	0.000000	0.00000	0.00000	-0.124042
2	ss0	DRIFT	1.0000	0.000000	0.000000	0.00000	0.00000	0.000000
3	Dipole	SBEND	7.0000	0.130900	0.000000	0.00000	0.00000	0.000000
4	ss0	DRIFT	1.0000	0.000000	0.000000	0.00000	0.00000	0.000000
5	DQH1	QUADR	0.4087	0.000000	0.000000	0.00000	0.00000	0.126769

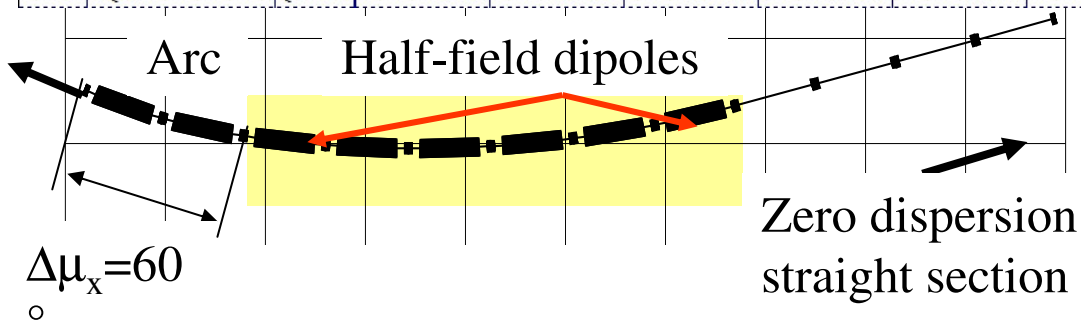

# Dispersion suppressors Ref. [2.2]

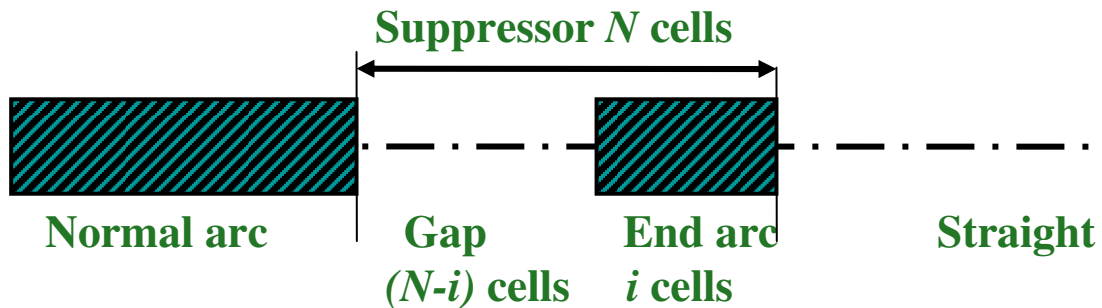

- ❖ Missing-magnet suppressors for FODO arcs (Fquad. + Dipole + Dquad. + Dipole):

$N$	Gap	$i$	$\Delta\mu$	End arc dipole $\theta$
2	1	1	$60^\circ$	$L/\rho$
3	1	2	$45^\circ$	$(L/\rho)/\sqrt{2}$
4	2	2	$30^\circ$	$(L/\rho)/2$

- ❖ Half-field suppressors for FODO arcs ( $N = i$ , no gap)

$N=i$	Gap	$\Delta\mu$	End arc dipole $\theta$
2	0	$90^\circ$	$(L/\rho)/2$
3	0	$60^\circ$	$(L/\rho)/2$
4	0	$45^\circ$	$(L/\rho)/2$

**Half-field is useful in electron machines as it reduces the synchrotron radiation into the experimental region.**

# Low- $\beta$ insertion

- ❖ Often, it is necessary to make the beam size small in both planes. This requires a so-called *low- $\beta$  insertion*.
- ❖ As an example, a doublet has been added after the dispersion suppressor on slide 16 to bring both betatron amplitudes down to 3 m.
- ❖ This case requires some further numerical matching to reduce the peak and further separate the doublet quadrupoles.

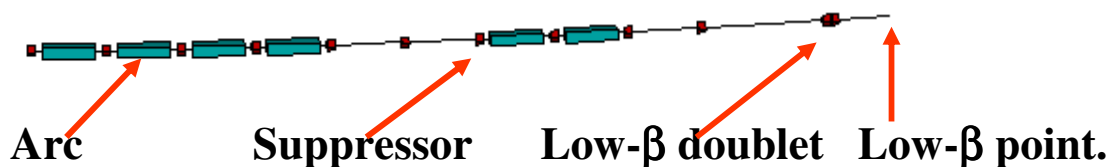
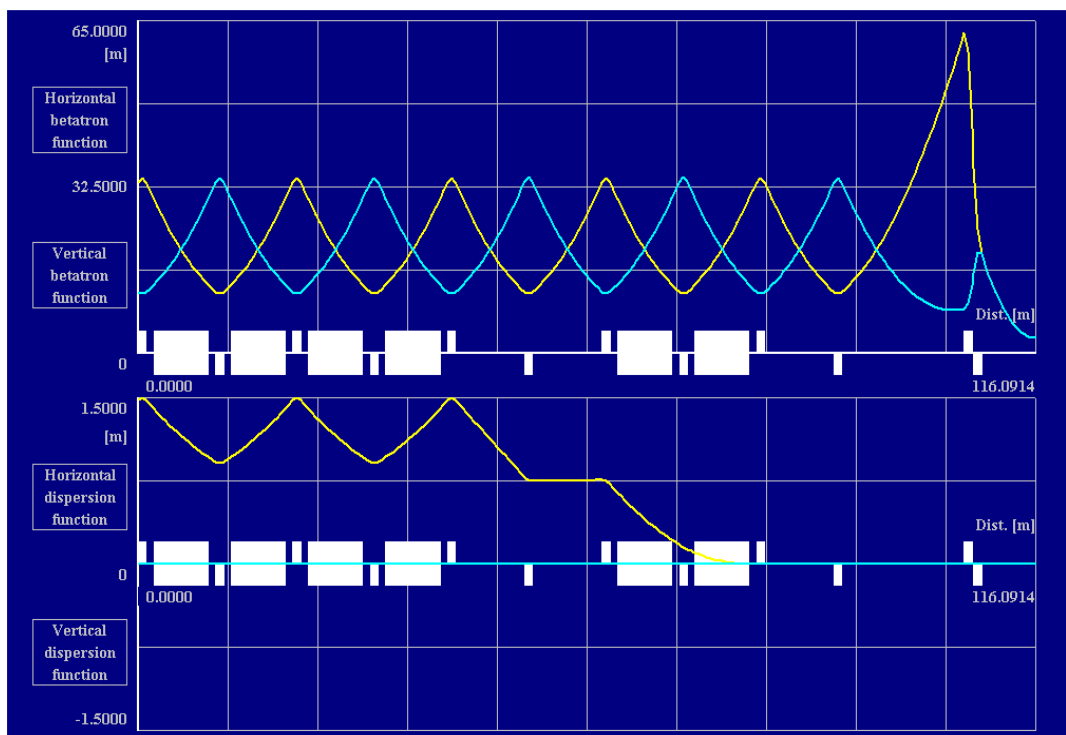

# Modules

- ❖ The last example invoked *numerical matching*.
- ❖ Although we would like to believe that one can just type in what one wants, push the button and get a good result, it is better to have some strategies.
- ❖ Knowledge of some standard modules can be useful.
- ❖ The most basic module is the 1:1 module that has the very simple transfer matrix.

$$\begin{pmatrix} 1 & 0 \\ 0 & 1 \end{pmatrix}$$

- ❖ This module will return the input values of  $x$  and  $x'$  at the exit. Thus any beam distribution will simply be transported unchanged to the exit.
- ❖ What does one have to specify in terms of  $\beta$ ,  $\alpha$  and  $\mu$  to get this matrix?

# 1:1 and 1:-1 modules

- ❖ A “1 : 1” module returns the entry beam co-ordinates at the exit and the “1:-1” returns the negative values.
- ❖ Take the general transfer matrix, Lecture 1 Eqn (1.8):

$$\begin{pmatrix} \left(\frac{\beta_2}{\beta_1}\right)^{1/2} (\cos \Delta\mu + \alpha_1 \sin \Delta\mu) & (\beta_1\beta_2)^{1/2} \sin \Delta\mu \\ -(\beta_1\beta_2)^{-1/2} [(1 + \alpha_1\alpha_2) \sin \Delta\mu + (\alpha_2 - \alpha_1) \cos \Delta\mu] & \left(\frac{\beta_1}{\beta_2}\right)^{1/2} (\cos \Delta\mu - \alpha_2 \sin \Delta\mu) \end{pmatrix}$$

- ❖ Set  $\Delta\mu = 2\pi$ ,  $\beta_2 = \beta_1$  and  $\alpha_2 = \alpha_1$  to create the 1:1 matrix.

$$\begin{pmatrix} 1 & 0 \\ 0 & 1 \end{pmatrix}$$

- ❖ Set  $\Delta\mu = \pi$ ,  $\beta_2 = \beta_1$  and  $\alpha_2 = \alpha_1$  to create the 1:-1 matrix.

$$\begin{pmatrix} -1 & 0 \\ 0 & -1 \end{pmatrix}$$

- ❖ You can create these matrices in a lattice program with say 4 or 2 FODO cells with  $90^\circ$  phase advance. The module you create would always be 1:1 or 1:-1 and would always return the input beam to the exit accordingly, whatever the input Twiss functions were.
- ❖ For example, if you had made an arc with a closed dispersion bump and equal input and output Twiss functions, then you could join two of these arcs with 1:1 modules to provide long straight regions.

# Telescope modules

- ❖ Since phase space is conserved, it is clear that when the beam width increases the angular divergence will go down and *vice versa*.
- ❖ This can be seen in the telescopic modules 1:*n* or 1:-*n*. The matrices are of the form:

$$\begin{pmatrix} \pm n & 0 \\ 0 & \pm \frac{1}{n} \end{pmatrix}$$

- ❖ Matrices of this type scale the excursion  $x$  by  $n$  and inversely scale the angular divergence  $x'$  by  $1/n$ . The moduli are still unity so phase space is conserved.
- ❖ To obtain this type of module put  $\Delta\mu = \pi$ , or  $\Delta\mu = 2\pi$ ,  $\beta_2 = n\beta_1$  and  $\alpha_2 = \alpha_1$ .

# Length scaling of a module

- ❖ From Lecture 1 Equation (1.7), we had

$$\frac{d^2 \sqrt{\beta}}{ds^2} + K_y(s) \sqrt{\beta} = (\sqrt{\beta})^{-3}.$$

- ❖ It was stated that this equation is rarely used. Well, here is one case. Let us suppose that you have created an ideal 1:1 or 1:-1 module, but it is too long. How can you shorten it and still have the same transfer matrix?

- ❖ Rewrite equation (1.7) with scaling factors,

$$s = \kappa s, \quad \beta = \tau \beta, \quad K = \lambda K_y(s)$$

$$\frac{d^2 \sqrt{\tau \beta}}{\kappa^2 ds^2} + \lambda K_y(s) \sqrt{\tau \beta} = (\tau \sqrt{\beta})^{-3}.$$

- ❖ With some re-arrangement,

$$\frac{\tau^2}{\kappa^2} \frac{d^2 \sqrt{\beta}}{ds^2} + \lambda \tau^2 K_y(s) \sqrt{\beta} = (\sqrt{\beta})^{-3}.$$

- ❖ By inspection one sees that the equation is unchanged, if

$$\kappa^2 = \tau^2 \text{ and } \lambda = \tau^{-2}.$$

Try,  $\kappa = \tau = 0.8$  and  $\lambda = 1/0.64$

all  $\beta$  functions and all lengths will be reduced by 20%, and all gradients increased by 56%, but phase advances and  $\alpha$ -functions are unchanged. Thus the 1:1 or 1:-1 module has the same properties as before.

$$\mu = \int \frac{1}{(\tau \beta)} d|\kappa s|, \quad \alpha = -\frac{1}{2} \frac{d(\tau \beta)}{d(\kappa s)}$$

# Single-turn injection/extraction

- ❖ A conventional injection/extraction insertion,

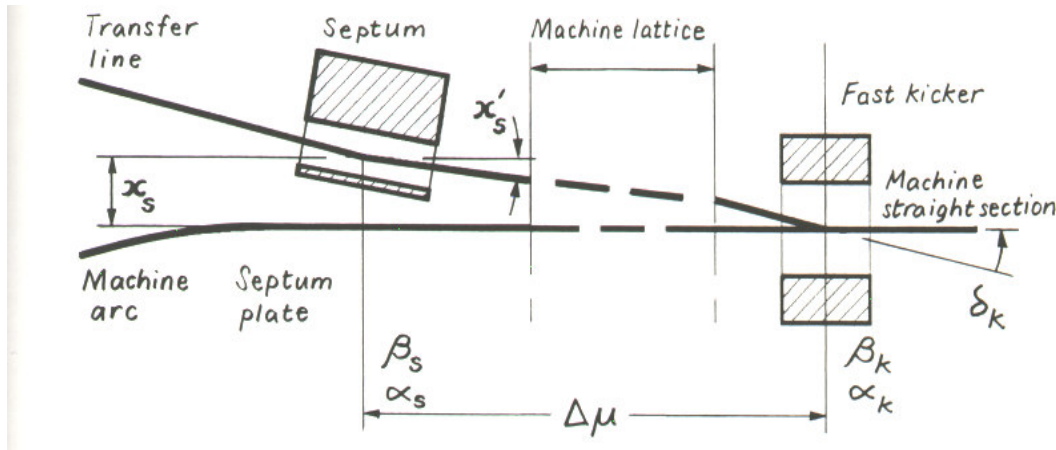

- ❖ The  $\Delta\mu$  is ideally  $90^\circ$ .
- ❖ If there is a quadrupole between the kicker and septum, then it is better to have a defocusing lens to benefit from the outward kick.
- ❖ It is better to have zero dispersion in order to have a narrow beam.
- ❖ It is also an advantage to have a large  $\beta_x$  at the kicker.
- ❖ If the septum bends in the same plane as the kicker then a *current-wall septum* is needed. If the bend is perpendicular to the first kick then a *Lambertson septum* is needed.



# Septa designs

## ❖ Current-wall septum

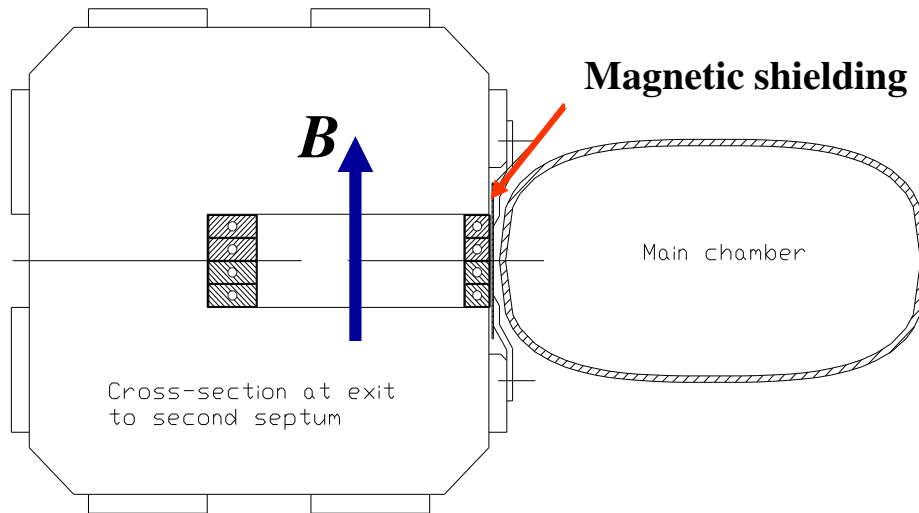

## ❖ Lambertson septum

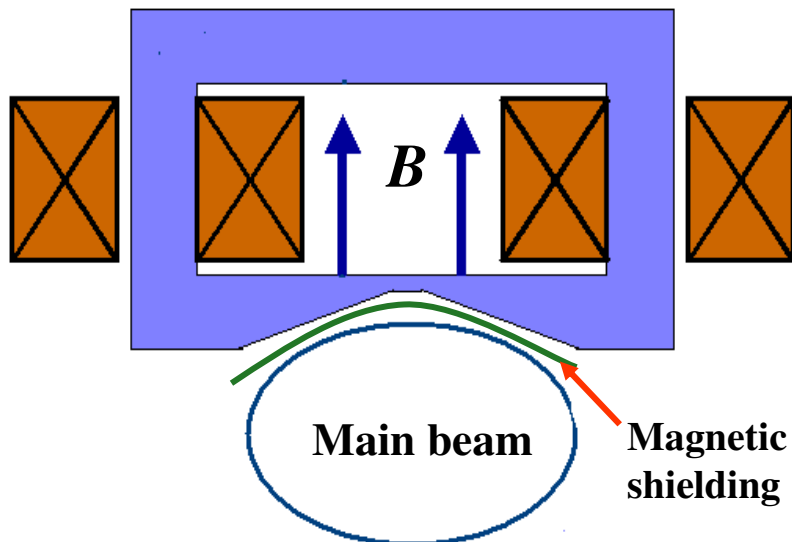

# *H minus stripping*

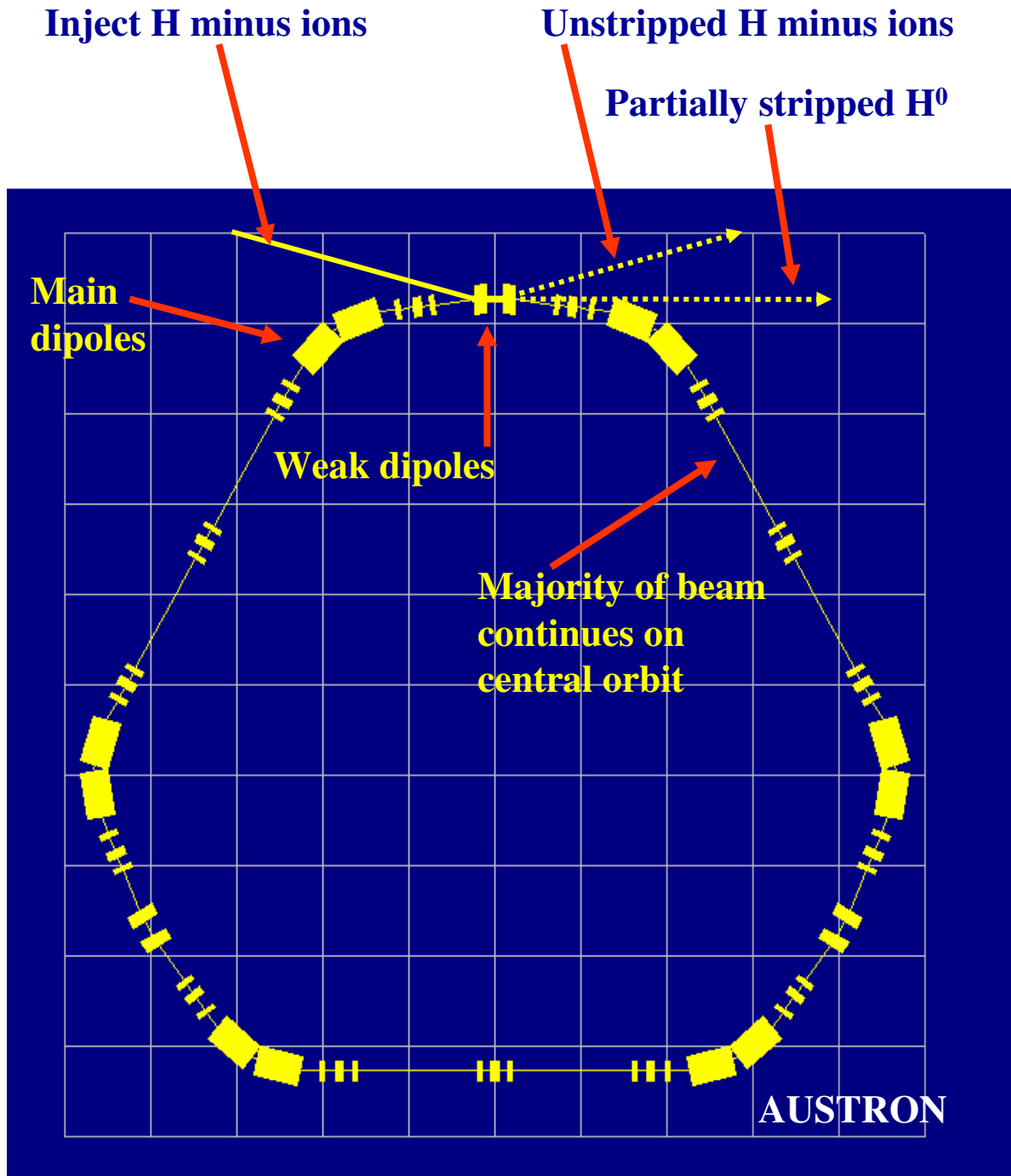

**This injection ‘cheats’ Liouville, but the beam still suffers some emittance blowup from scattering in the stripping foil.**

# *Injection by radiation damping*

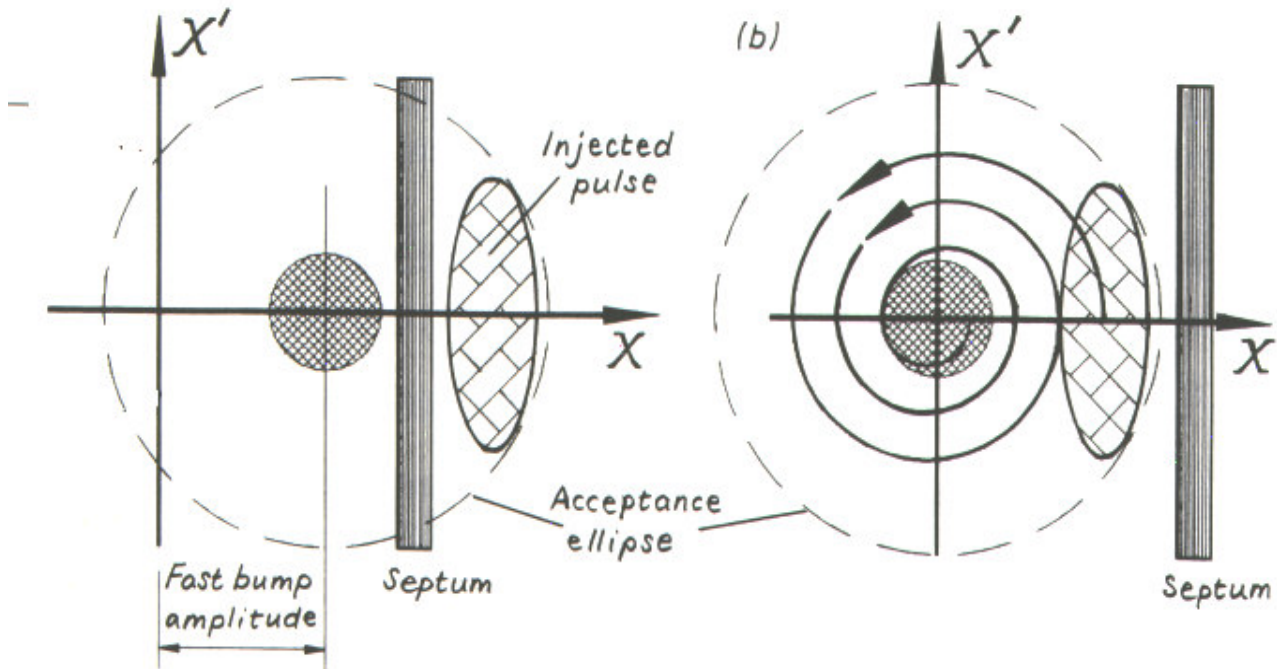

- ❖ **Displace central orbit with a fast bump towards the septum.**
- ❖ **Inject a pulse.**
- ❖ **Collapse bump before injected pulse returns to septum.**
- ❖ **Let synchrotron radiation damp newly injected pulse into the core of the beam.**

# Multi-turn injection

- ❖ Construct a fast closed-orbit bump that pushes the central orbit to the septum wall before collapsing linearly.
- ❖ In this example, the fractional tune is close to  $2/3$ . Inject say 5 pulses over 5 turns and collapse the bump by  $\sim 1/3$  of the pulse width on each turn.
- ❖ The injected pulses are well separated for clarity. In practice, significant losses are accepted in order to closely pack the dense cores of a larger number of pulses.
- ❖ WinAGILE has an expert routine for multiturn injection.

