

# JUAS RF Course 2017

## Cavities



Superconducting LEP cavity

[Fritz.Caspers@cern.ch](mailto:Fritz.Caspers@cern.ch)

## RF Theory

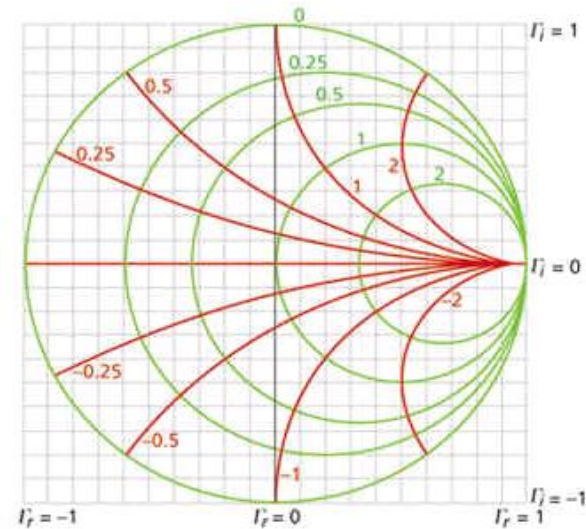

The Smith Chart

[manfred.wendt@cern.ch](mailto:manfred.wendt@cern.ch)

# Basics on RF Transmission, and Resonant Structures

## Section A

- ◆ *Basics*
- ◆ *Transmission-lines*
- ◆ *Striplines, Microstrip-lines, Slotlines*
- ◆ *Waveguide and single cell cavity structures*
- ◆ *Decibel*
- ◆ *Equivalent circuit*
- ◆ *Characteristic in time and in frequency domain*
- ◆ *Beam-cavity interaction*

## Section B

- ◆ *Scaling laws*
- ◆ *Simulation techniques*
- ◆ *Higher order modes (HOMs)*
- ◆ *Transit time factor*
- ◆ *Coupling and tuning*
- ◆ *Different shapes of cavities*
- ◆ *Voltage breakdown & Multipactor*
- ◆ *Multi-cell cavities, travelling wave structures*

# S-Parameters, Smith Chart, and Active Systems

## Section C

- ◆ *Standing waves*
- ◆ *The Smith Chart*
- ◆ *Navigation in the Smith Chart*
- ◆ *Examples*
- ◆ *Rulers on the Smith Chart*

## Section D

- ◆ *S-Parameters*
- ◆ *The scattering matrix*

## Section E

- ◆ *Active elements*
  - *Transistors*
  - *Gridded tubes*
  - *Klystrons*
  - *IOTs*
- ◆ *Measurement devices and concepts*
- ◆ *Superheterodyne Concept*

# Simplified RF System

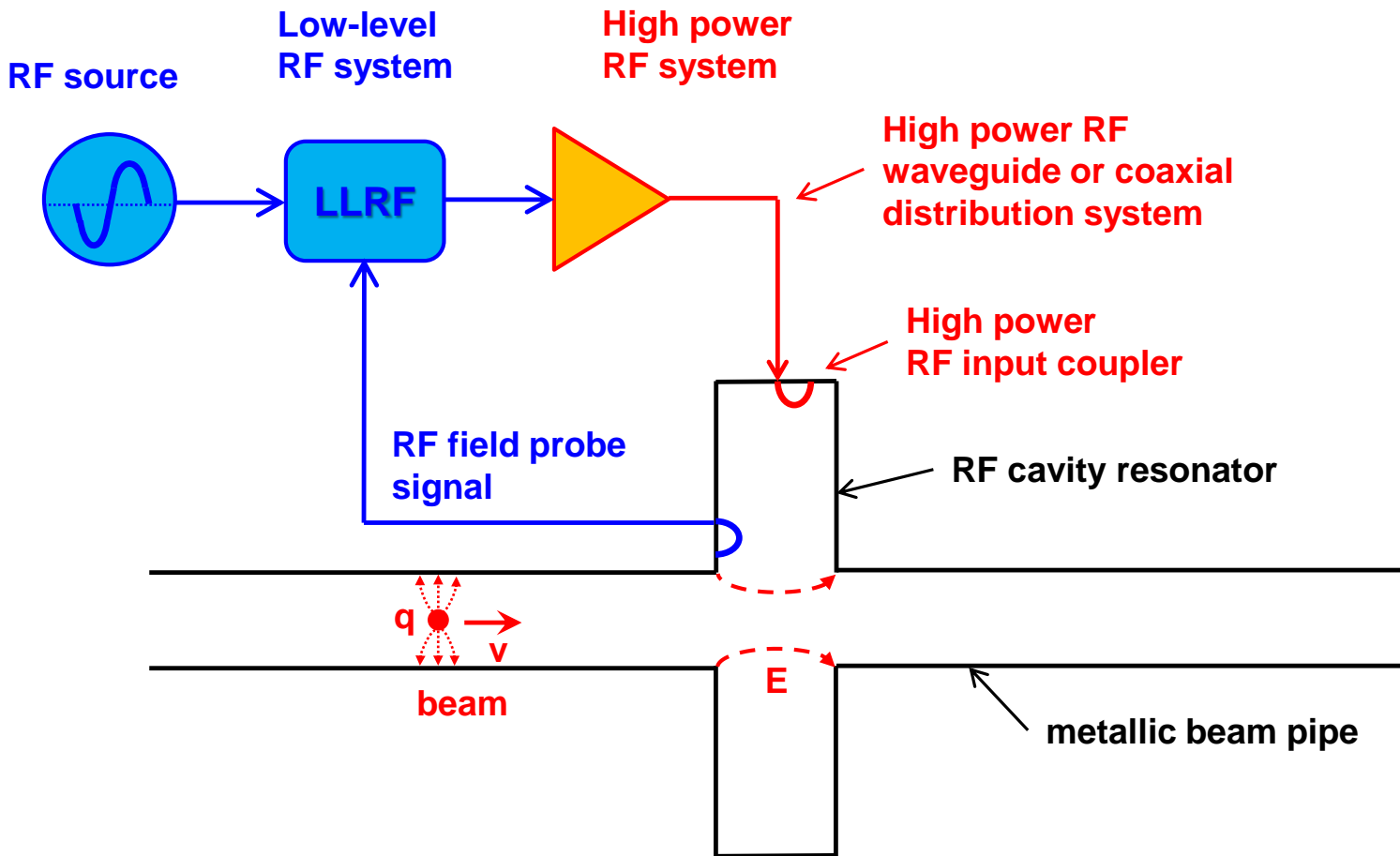

# Maxwell's equations (1)

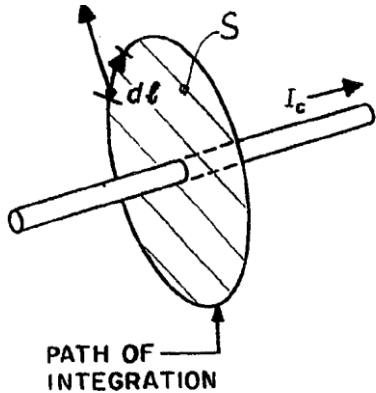

Ampere's Law:

$$\oint_C \mathbf{H} \, d\mathbf{l} = I = I_c + I_d = \iint_S \left( \mathbf{J}_F + \frac{\partial \mathbf{D}}{\partial t} \right) d\mathbf{S}$$

conductive current      displacement current

with  $\mathbf{J}_F$  being the "free" or conduction current density,

and  $\frac{\partial \mathbf{D}}{\partial t} = \mathbf{J}_D$

the displacement current density.

$$\text{curl } \mathbf{H} = \nabla \times \mathbf{H} = \mathbf{J}_F + \frac{\partial \mathbf{D}}{\partial t}$$

with the current density  $\mathbf{J}_F$   
the electric displacement field  $\mathbf{D}$   
and the magnetic field  $\mathbf{H}$

Faraday's Law  
(Kelvin – Stokes Theorem):

$$\oint_{\partial \Sigma} \mathbf{E} \, d\mathbf{l} = - \int_{\Sigma} \frac{\partial \mathbf{B}}{\partial t} \, d\mathbf{A}$$

$$\text{curl } \mathbf{E} = \nabla \times \mathbf{E} = - \frac{\partial \mathbf{B}}{\partial t}$$

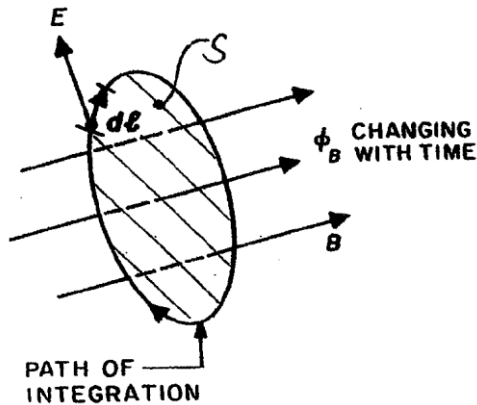

with the magnetic field  $\mathbf{B}$  linked to the magnetic flux,

$$\Phi_B = \iint_{\Sigma(t)} \mathbf{B}(\mathbf{r}, t) \, d\mathbf{A}$$

and the electromotive force (EMF)

$$\mathcal{E} = - \frac{\partial \Phi_B}{\partial t}$$

with the electric field  $\mathbf{E}$   
and the magnetic field  $\mathbf{B}$

integral form

differential form

# Maxwell's equations (2)

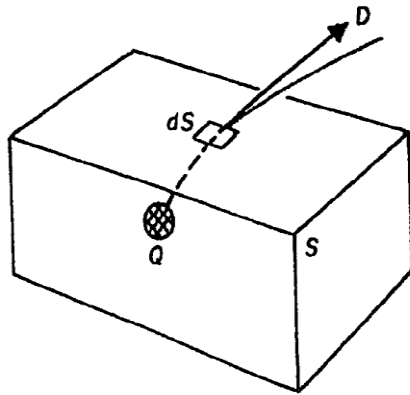

$S$  = TOTAL SURFACE  
 $Q$  = TOTAL CHARGE INSIDE  $S$

Gauss' Law (Electricity):

$$\oiint_S \mathbf{D} \, dA = \Phi_D = Q_{\text{free}}$$

with the electric displacement  $\mathbf{D}$   
 and the free charge  $Q_{\text{free}}$   
 equivalent to the  $\mathbf{D}$ -field flux  $\Phi_D$

$$\text{div } \mathbf{D} = \nabla \cdot \mathbf{D} = \rho_{\text{free}}$$

with the free charge density  $\rho_{\text{free}}$

The surface  $S$  must be closed!

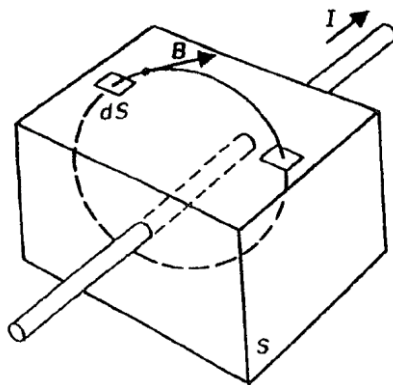

Gauss' Law (Magnetism):

$$\oiint_S \mathbf{B} \, dS = 0$$

with the magnetic field  $\mathbf{B}$

$$\text{div } \mathbf{B} = \nabla \cdot \mathbf{B} = 0$$

there are no magnetic charges

Integral form

differential form

# Displacement and conduction currents in a simple capacitor

end plates =  
sides planes of  
a pillbox cavity

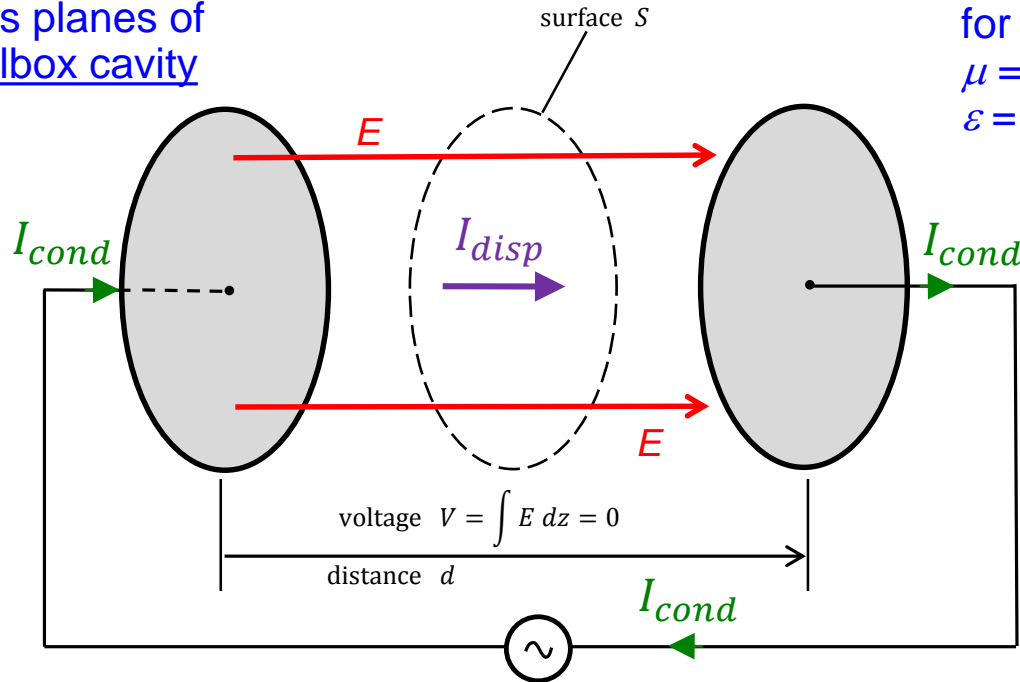

for vacuum and approximately for air:  
 $\mu = \mu_0 = 4\pi \cdot 10^{-7} = 1.257 \cdot 10^{-6} \text{ Vs/(Am)}$   
 $\varepsilon = \varepsilon_0 = 8.854 \cdot 10^{-12} \text{ As/(Vm)}$

The conduction current passes  
as displacement current the  
capacitor gap

$$\left. \begin{aligned} \text{Displacement current in the dielectric: } I_{disp} &= \frac{\partial \Phi_D}{\partial t} = \varepsilon \int \frac{\partial \mathbf{E}}{\partial t} \cdot d\mathbf{S} = \varepsilon \mathbf{S} \frac{\partial \mathbf{E}}{\partial t} \\ \text{Conduction current in conductor: } I_{cond} &= \frac{\partial Q}{\partial t} = C \frac{\partial V}{\partial t} = \varepsilon \frac{\mathbf{S}}{d} \mathbf{d} \frac{\partial \mathbf{E}}{\partial t} = \varepsilon \mathbf{S} \frac{\partial \mathbf{E}}{\partial t} \end{aligned} \right\} I_{disp} = I_{cond}$$

with the electric flux  $\Phi_D$  and the charge  $Q$ .



# From L and C to a cavity

With a gap in the beam pipe we still have both ends at the same electric potential

→ put a cavity in there

Creates E-field for accelerating the particles; Along the cavity walls the field is zero and so is the integral

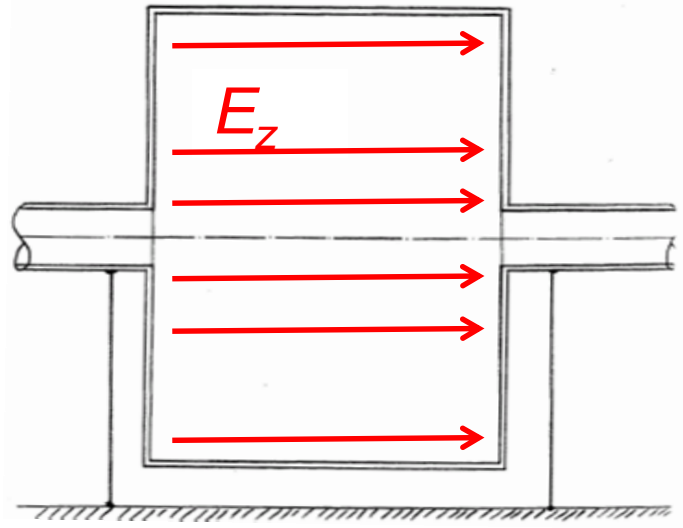
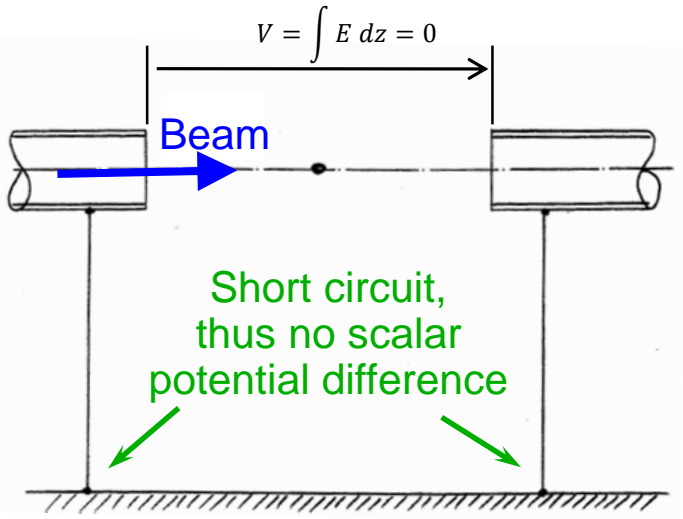

Capacitor at high frequencies,  
The Feynman Lectures on Physics

Can the short-circuit be avoided?

Answer: No - but it doesn't bother us at high frequencies.



# TEM transmission lines (1)

Transverse electric modes (TEM) can propagate on any structure with at least two conductors

Given a structure with

$C'$  ... capacitance per unit length in Faraday per meter [F/m]

$L'$  ... inductance per unit length in Henry per meter [H/m]

Typical values for an air filled TEM line (not necessarily coax):  $C' = 30$  pF/m       $L' = 166$  nH/m

It then follows (no losses assumed)

$$\text{characteristic impedance} \quad Z = \frac{V_{\text{wave}}}{I_{\text{wave}}} = \sqrt{\frac{L'}{C'}} \quad [Z] = \Omega$$

$$\text{velocity of propagation} \quad v = \frac{1}{\sqrt{L'C'}} = \frac{c_0}{\sqrt{\mu_r \epsilon_r}} \quad [v] = m/s$$

If  $\mu_r = \epsilon_r = 1$  (vacuum or approximately air), then the velocity of propagation is equal to the velocity of light  $c_0 \approx 3 \cdot 10^8$  m/s

# TEM transmission lines (2)

Formulae for the characteristic impedance  $Z$  can be found in many textbooks (e.g. "Reference Data for Radio Engineers" or others). From a known  $Z$  the values for  $C'$  and  $L'$  can be deduced by

$$\left. \begin{array}{l} C' = \frac{1}{vZ} \\ L' = \frac{Z}{v} \end{array} \right\} \text{for "normal" cable } (\mu_r = 1)$$

$$\begin{array}{ll} C' = \frac{100\sqrt{\epsilon_r}}{3Z} & [C'] = pF/cm \\ L' = \frac{\sqrt{\epsilon_r}}{30} Z & [L'] = nH/cm \end{array}$$

For coaxial cables : 
$$Z = \sqrt{\frac{\mu_r}{\epsilon_r}} 60 \ln\left(\frac{R}{r}\right)$$

# TEM transmission lines (3)

Coaxial cable with minimum loss:

$$\alpha_R = \frac{R_S \sqrt{\epsilon_r}}{Z_0 D} \cdot \frac{1 + \frac{D}{d}}{\ln\left(\frac{D}{d}\right)}$$

$R_S$  Surface resistance

$$R_S = \frac{\rho}{\delta} = \frac{1}{\sigma \delta}$$

$$f_\alpha = \alpha_R \frac{Z_0 D}{R_S \sqrt{\epsilon_r}} = \frac{1 + \frac{D}{d}}{\ln\left(\frac{D}{d}\right)}$$

$$Z_L = \sqrt{\frac{\mu_0}{\epsilon_0}} \frac{\ln\left(\frac{D}{d}\right)}{2\pi \sqrt{\epsilon_r}}$$



Abb. 4.6/2. Wellenwiderstand und Dämpfung  $\alpha_R$  eines Koaxialkabels in Abhängigkeit vom Durchmesser Verhältnis  $D/d$ . In dem eingezeichneten Toleranzfeld bedeutet eine Linie jeweils 1% Abweichung vom Optimum

Reprinted from O.Zinke, H.Brunswig,  
Lehrbuch der Hochfrequenztechnik, p.222

# TEM transmission lines (4)

Applied to 50-Ohm-lines (the impedance mostly used) one finds

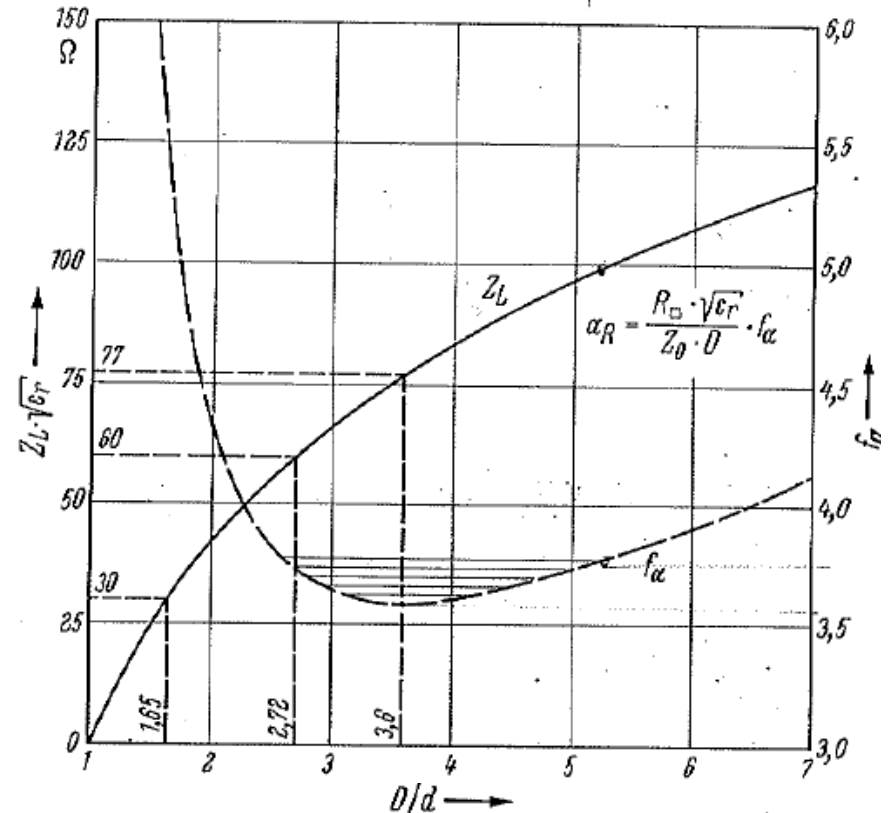
	Vacuum or air	Polyethylene (PE)
$\epsilon_r$	1	2.26
$v$ (m/sec)	$c_0 \cdot 3 \cdot 10^8$	$0.665 c_0$
$L'$ (nH/m)	166.7	250.6
$C'$ (pF/m)	66.7	100.2
$R/r$	2.30	3.50

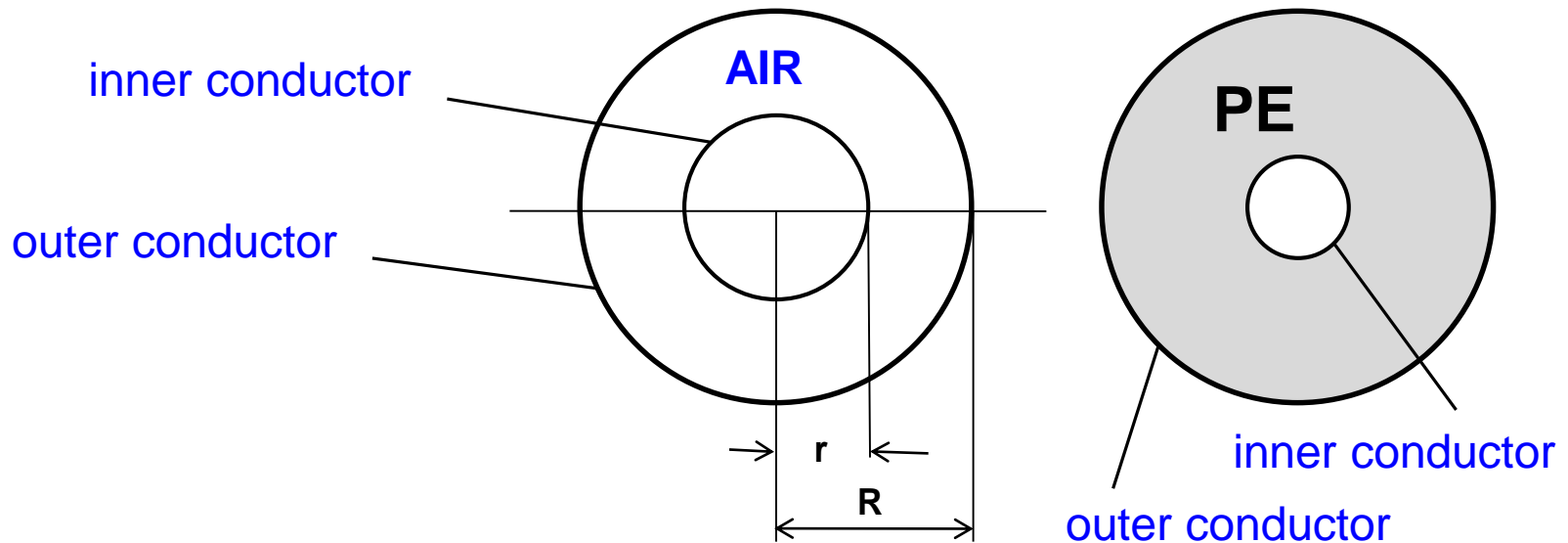

# Transmission lines (1)

## ◆ Coaxial lines

- frequency range: 0...~100 GHz
- largest practical size: 350 mm for outer conductor, 150 mm for the inner conductor
- power rating: for CW operation at 200 MHz: 1 MW
- low-pass line, upper frequency limit given by moding
- relatively high attenuation
- power limited by inner conductor (high field => thermal load)
- in general easier to handle than waveguides

## ◆ Waveguides

- frequency range 0.32...325 GHz (standard guides)
- largest practical size: 590 mm x 298 mm
- power rating: 150 MW peak at 310 MHz
- low attenuation
- bandpass, low frequency cut-off determined by dimension

Watch a good old school “visual” introduction into transmission-lines:  
<https://youtu.be/I9m2w4DgeVk>

# Transmission lines (2)

Standard RF coax cables

single screen

50 Ω

H+S type	Item no.	Curves see page	Center conductor [1]			Dielectric [2]		Screen 1 [3]			Screen 2 [4]		Jacket [5]			Weight kg/100 m	Operating voltage kV	Max. operation frequency	Cable group*	
			Design	Mat.	Dim. mm	Mat.	Dim. mm	Mat.	Dim. mm	Cover %	Dim. mm	Cover %	Mat.	Dim. mm	Colour				crimp	clamp
G_03212-01	22610095	5 and 6	Strand-19	CuSn	0.90	PE	2.95	CuSn	3.60	95	-	-	PUR <sup>1)</sup>	4.95	black	3.60	2.5	1	U7	U7
RG_58_C/U	22510015		Strand-19	CuSn	0.90	PE	2.95	CuSn	3.60	96	-	-	PVC2(LM)	4.95	black	3.70	2.5	1	U7	U7
RG_58_C/U-01	22510350		Strand-19	CuSn	0.90	PE	2.95	CuSn	3.60	96	-	-	PVC2(LM)	4.95	black	3.70	2.5	1	U7	U7
RG_58_C/U-05	22511239		Strand-19	CuSn	0.90	PE	2.95	CuSn	3.60	96	-	-	PVC2(LM)	4.95	blue	3.70	2.5	1	U7	U7
RG_58_C/U-06	22510017		Strand-19	CuSn	0.90	PE	2.95	CuSn	3.60	96	-	-	PVC	4.95	black	3.70	2.5	1	U7	U7
RG_58_C/U-07	22511244		Strand-19	CuSn	0.90	PE	2.95	CuSn	3.60	96	-	-	PVC2(LM)	4.95	grey	3.70	2.5	1	U7	U7
RG_58_C/U-22	22511607		Strand-19	CuSn	0.90	PE	2.95	CuSn	3.60	96	-	-	PVC2(LM)	4.95	red	3.70	2.5	1	U7	U7
RG_58_C/U-62 <sup>b)</sup>	23024284		Strand-19	CuAg	0.90	PE	2.95	CuAg	3.60	96	-	-	PVC(UL)	4.95	black	3.70	2.5	1	U7	U7
G_03232	22510128		Strand7	Cu	0.95	PE	2.95	Cu	3.60	95	-	-	PVC	5.00	black	3.70	2.5	1	U7	U7
G_03262-1	22512108		Strand7	CuSn	0.90	PE	2.95	CuSn	3.60	96	-	-	LSFH <sup>1)</sup>	4.95	black	3.90	2.5	1	U7	U7
G_03272	22511434		Strand7	Cu	0.95	PE	2.95	Cu	3.60	95	-	-	PE <sup>1)</sup>	5.00	black	3.50	2.5	2	U7	U7
G_05232	22510176		Strand7	Cu	1.50	PE	4.80	Cu	5.60	92	-	-	PVC2(LM)	7.40	black	7.70	3.5	1	-	U19
RG_213_U	22510052		Strand7	Cu	2.25	PE	7.25	Cu	8.10	96	-	-	PVC2(LM)	10.30	black	15.30	5.0	1	U29	U28
RG_213_U-01 <sup>a)</sup>	22510053		Strand7	Cu	2.25	PE	7.24	Cu	8.10	96	-	-	PVC2(LM)	10.30	black	15.30	5.0	1	U29	U28
RG_213_U-04	22510055		Strand7	Cu	2.25	PE	7.25	Cu	8.10	96	-	-	PVC	10.30	black	15.30	5.0	1	U29	U28
G_07262	22511836		Strand7	Cu	2.25	PE	7.28	Cu	8.10	96	-	-	LSFH <sup>1)</sup>	10.30	black	15.30	5.0	1	U29	U28
RG_218_U	22510066	Wire	Cu	5.00	PE	17.30	Cu	18.40	96	-	-	PVC2(LM)	22.10	black	66.90	11.0	1	-	U44	

\* for suitable connectors

<sup>a)</sup> precision type: impedance 50 ± 1 Ω

<sup>b)</sup> UL recognised (see UL types page 117)

<sup>1)</sup> Low Smoke Free of Halogen (LSFH) acc. waste electrical and electronic equipment (WEEE) and restriction of the use of certain hazardous substances (RoHS) directive.

# Transmission lines (3)

## Attenuation

Standard RF coax cables, single screen, 50  $\Omega$

typical values at +20 °C ambient temperature

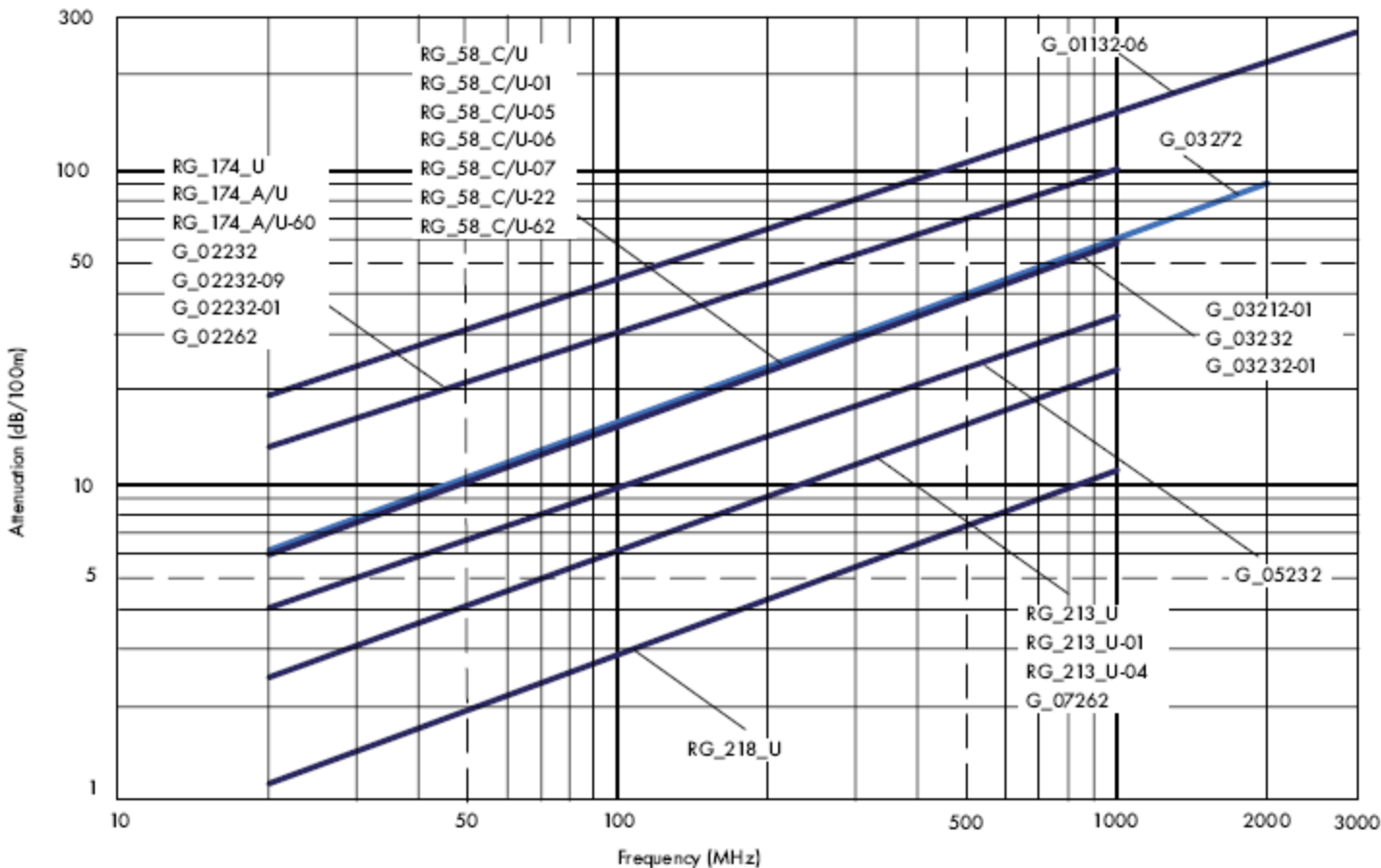

# Transmission lines (4)

Power

Standard RF coax cables, single screen, 50  $\Omega$

typical values at +40 °C ambient temperature

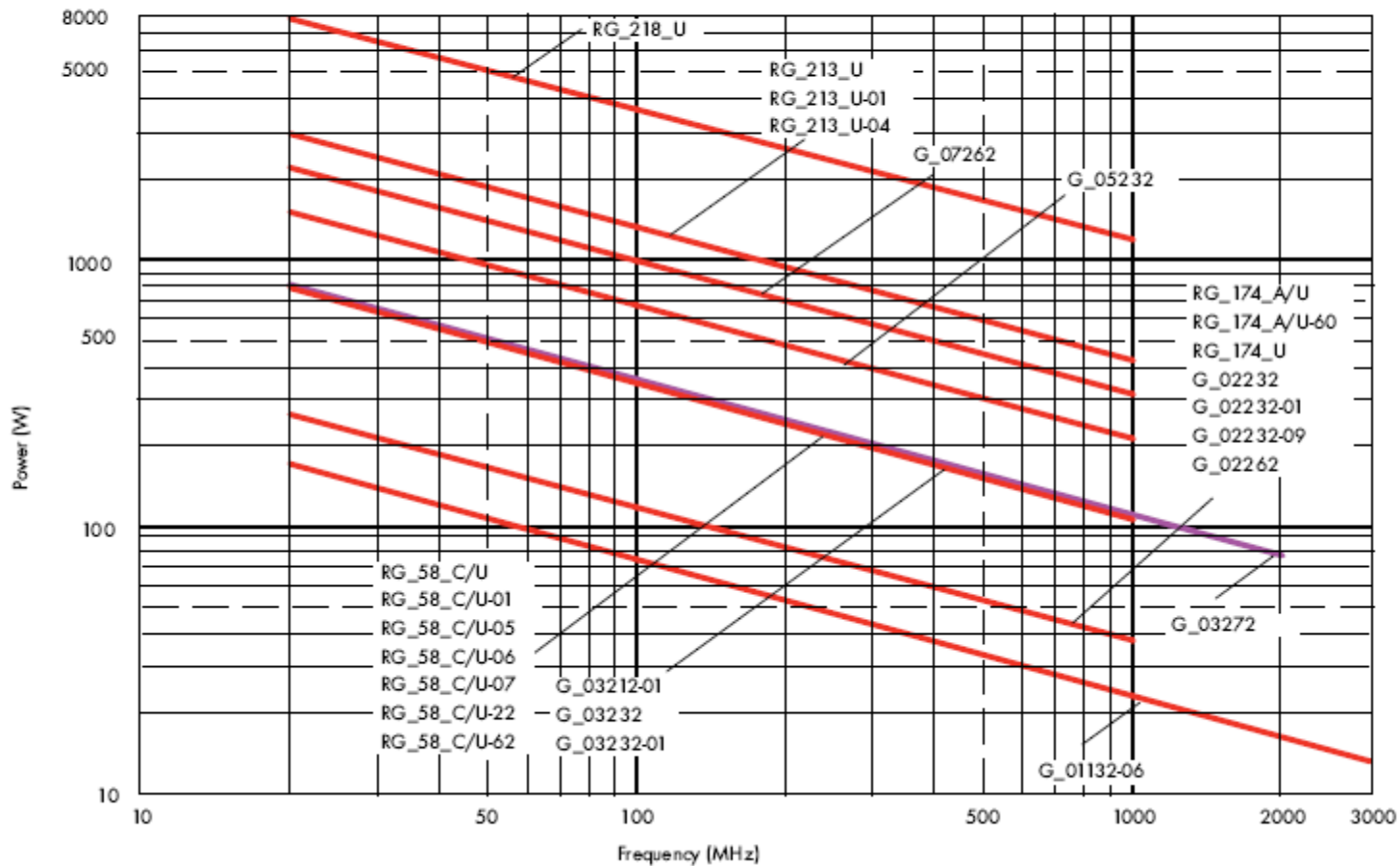



# Striplines (1)

A stripline is a **flat conductor** between a top **and** bottom ground plane. The space around this conductor is filled with a homogeneous dielectric material. This line propagates a pure TEM mode. With the static capacity per unit length,  $C'$ , the static inductance per unit length,  $L'$ , the relative permittivity of the dielectric,  $\epsilon_r$  and the speed of light  $c$  the characteristic impedance  $Z_0$  of the line is given by

$$Z_0 = \sqrt{\frac{L'}{C'}}$$

$$v_{ph} = \frac{c}{\sqrt{\epsilon_r}} = \frac{1}{\sqrt{L'C'}}$$

$$Z_0 = \sqrt{\epsilon_r} \frac{1}{C'c}$$

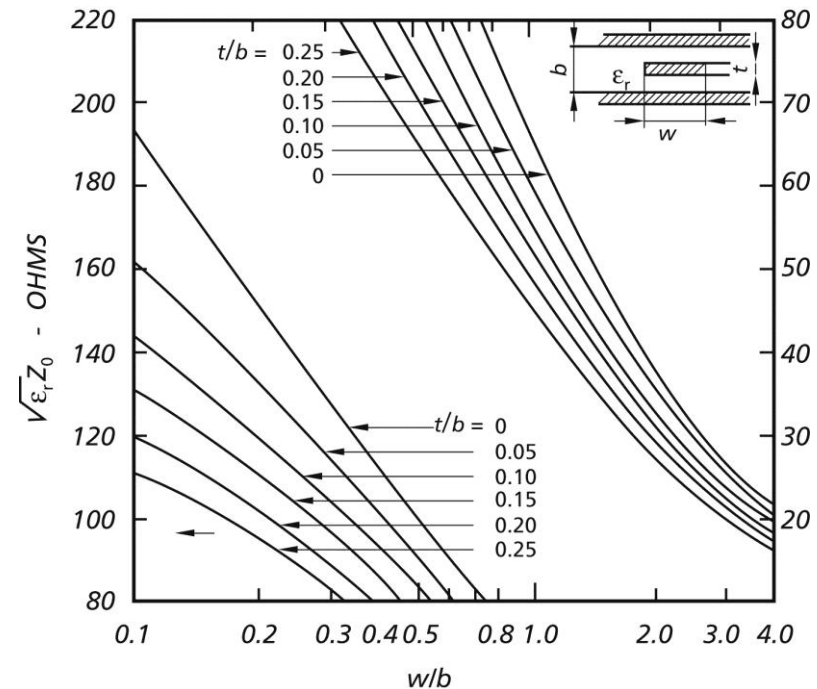

Characteristic impedance of striplines

# Striplines (2)

For a mathematical treatment, the effect of the fringing fields may be described in terms of static capacities. The total capacity is the sum of the principal and fringe capacities  $C_p$  and  $C_f$ .

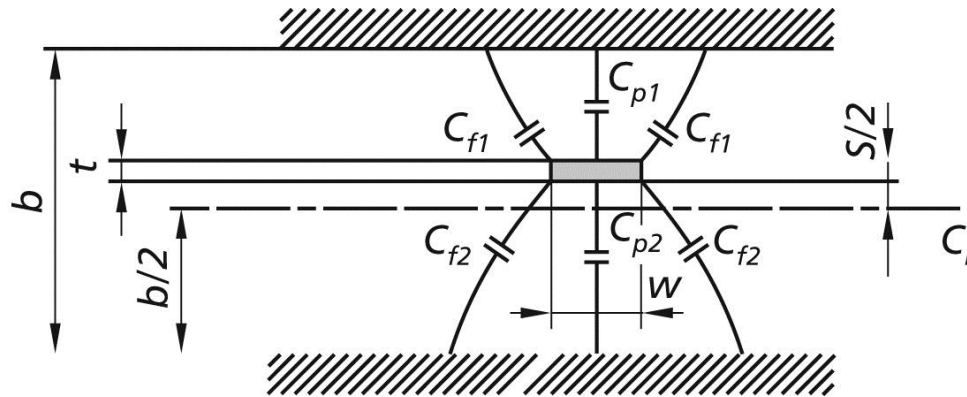

$$C_{tot} = C_{p1} + C_{p2} + 2C_{f1} + 2C_{f2}$$

$C_f$  stands for fringe field capacity,

$C_p$  stands for principal capacity

# Striplines (3)

Coupled striplines (in odd and even mode):

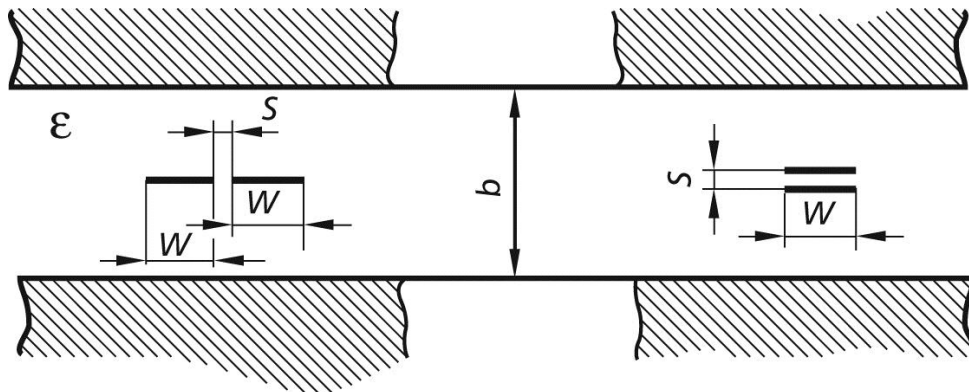
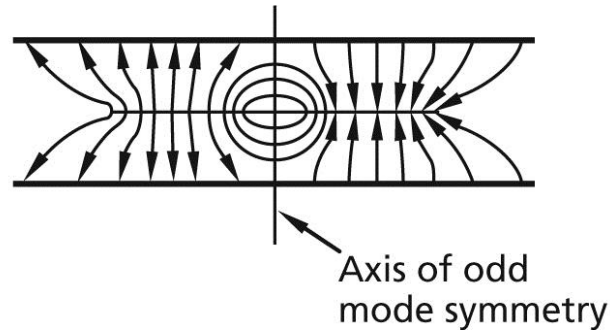
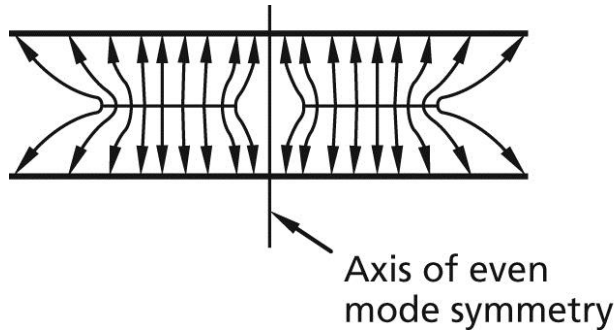

side-coupled

broad-coupled

$$Z_{0,even} = \frac{1}{\sqrt{\epsilon_r}} \cdot \frac{94.15 \Omega}{\frac{w}{b} + \frac{\ln 2}{\pi} + \frac{1}{\pi} \ln \left( 1 + \tanh \left( \frac{\pi s}{2b} \right) \right)}$$

$$Z_{0,odd} = \frac{1}{\sqrt{\epsilon_r}} \cdot \frac{94.15 \Omega}{\frac{w}{b} + \frac{\ln 2}{\pi} + \frac{1}{\pi} \ln \left( 1 + \coth \left( \frac{\pi s}{2b} \right) \right)}$$

This formula for side-coupled structure only.

# Microstriplines (1)

A microstripline may be visualized as a stripline with the top cover and the top dielectric layer taken away. It is thus an asymmetric open structure, and only part of its cross section is filled with a dielectric material. Since there is a transversely inhomogeneous dielectric, only a quasi-TEM wave exists. This has several implications such as a frequency-dependent characteristic impedance and a considerable dispersion.

(a) Mechanical construction

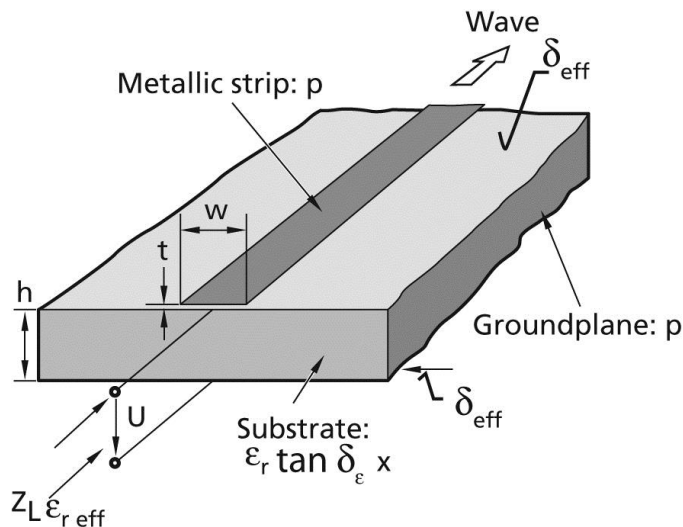

(b) Static field approximation

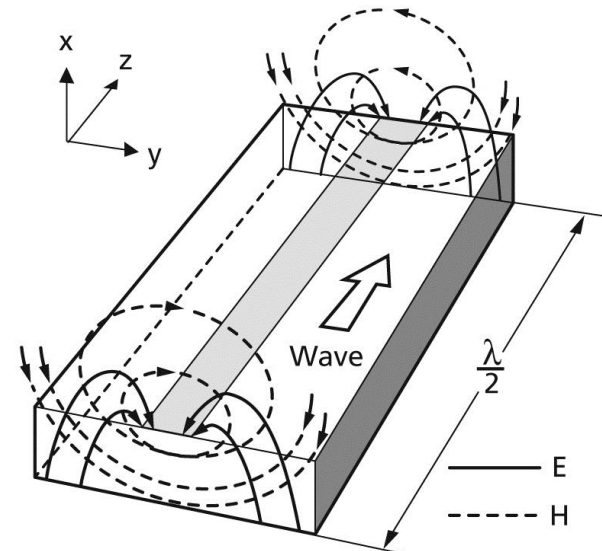

Note: Quasi-TEM wave due to different dielectric constants in different parts of the cross-section. We do get longitudinal field components.

# Microstriplines (2)

Frequency-dependent characteristic impedance

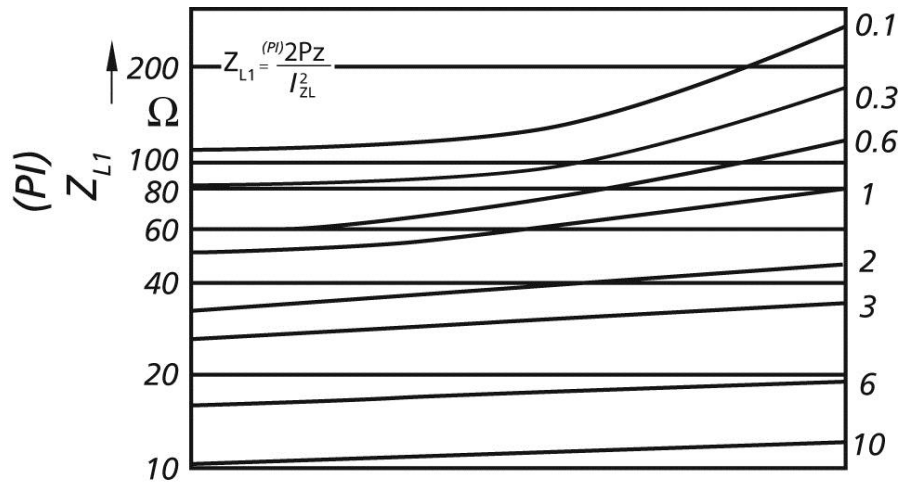

Effective permittivity

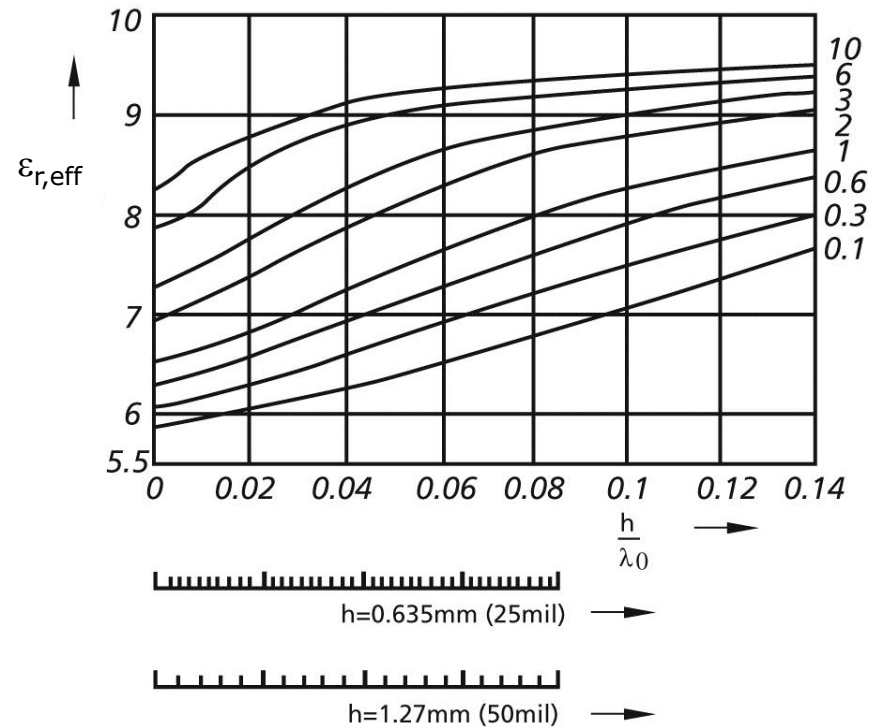

# Microstriplines (3)

Planar transmission lines used in MIC (microwave integrated circuits)

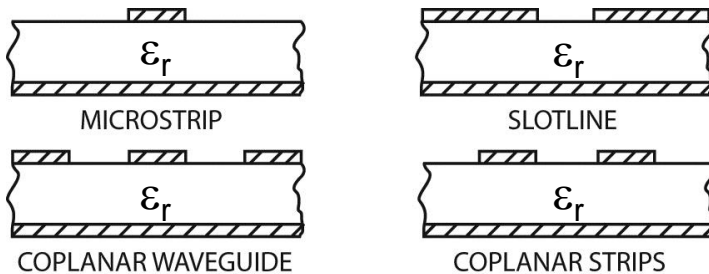

Various transmission lines derived from microstrip

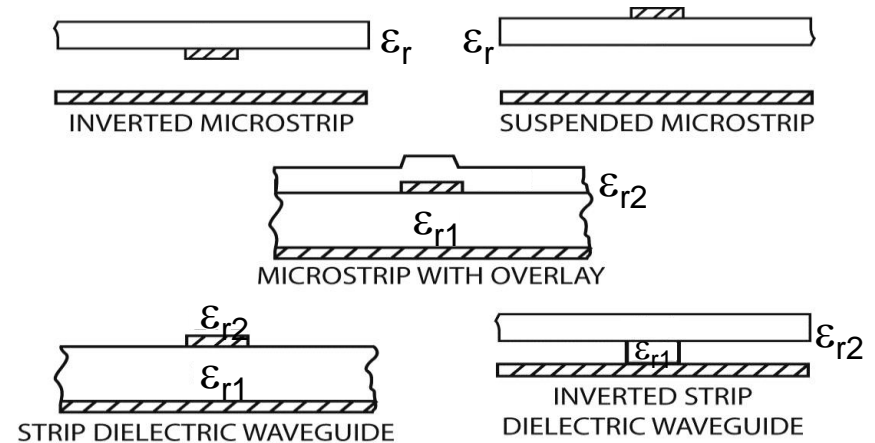

# Slotlines (1)

The slotline may be considered as the dual structure of the microstrip. It is essentially a slot in the metallization of a dielectric substrate. The characteristic impedance and the effective dielectric constant exhibit similar dispersion properties to those of the microstrip line.

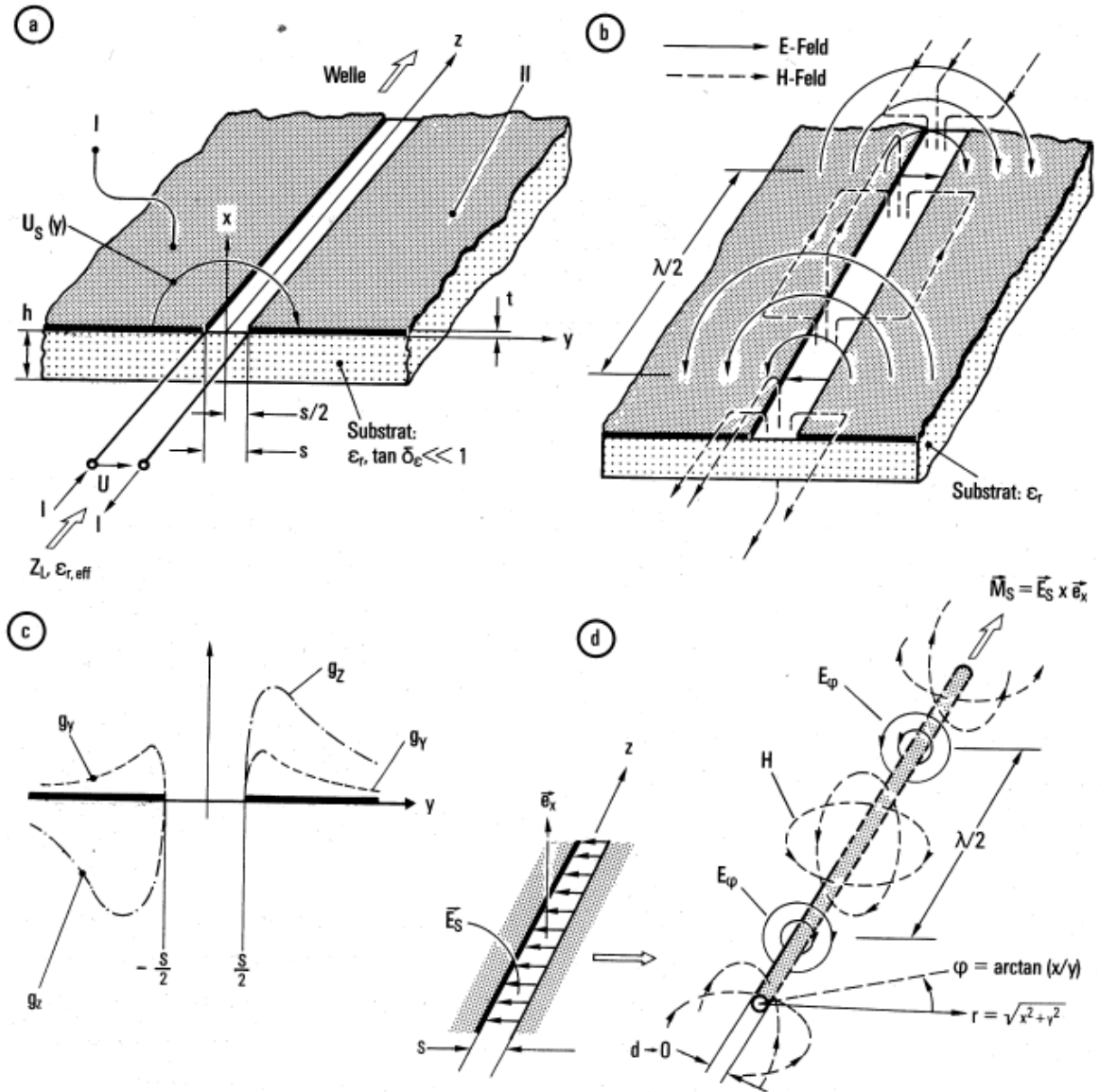

(a) Mechanical construction

(b) Field pattern  
(TE approximation)

(c) Longitudinal and  
transverse current  
densities

(d) Magnetic line current  
model.

# Slotlines (2)

A broadband (decade bandwidth) pulse inverter. Assuming the upper microstrip to be the input, the signal leaving the circuit on the lower microstrip is inverted since this microstrip ends on the opposite side of the slotline compared to the input.

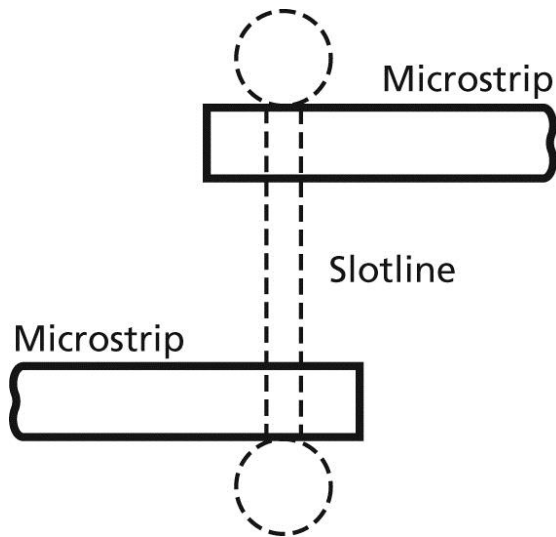

Two microstrip-slotline transitions connected back to back for  $180^\circ$  phase change.



# Let there be waveguide modes 😊

Details have been discussed in other lectures (hopefully 😊)

For all homogeneous waveguides (any cross section), there are two basic types of modes, with different orthogonality:

	<b>Europe:</b>	<b>USA:</b>
◆	<b>H mode</b>	<b>= TE</b>
◆	<b>E mode</b>	<b>= TM</b>

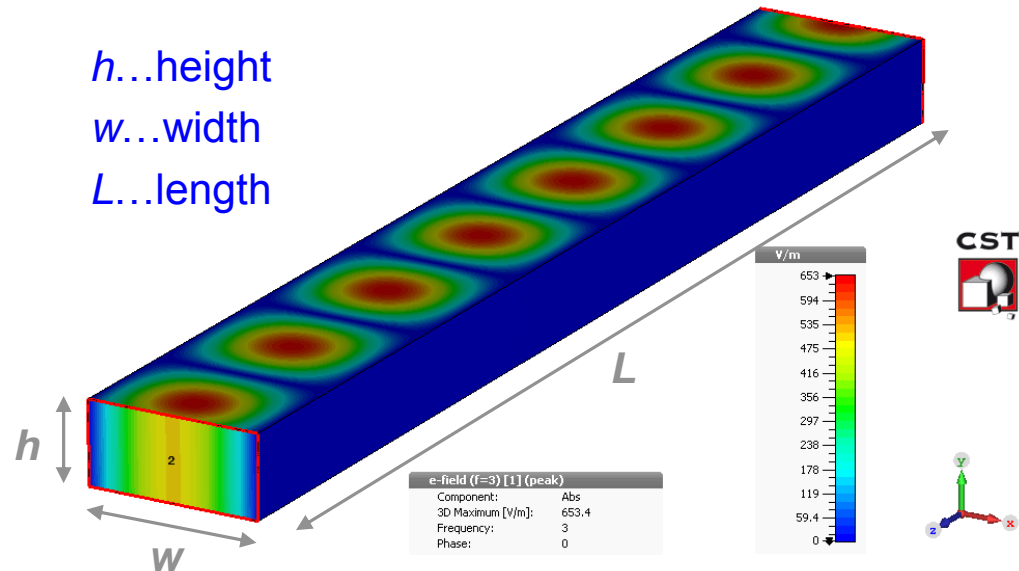

- ◆ H modes are characterized by the fact that they have **only** an H-component in the direction of propagation and no E-field in this direction (Transverse Electric)
- ◆ E modes on the other hand are characterized by the fact that they have **only** an E-component in direction of propagation and no H-field in this direction (Transverse Magnetic)
  - → Waveguide modes in a homogeneous waveguide with homogeneous fill (no partial fill with dielectric) are described by a maximum of up to five mode parameters

# “Electric” boundary condition for cavities and waveguides

In the stationary (general) case:

- ◆ On perfect conducting surfaces the parallel component of the electric field has to vanish:

$$E_{\parallel} = 0$$

- ◆ There is no perpendicular magnetic field to a conducting surface:

$$B_{\perp} = 0$$

- E-field and B-field are coupled:  $B_{\perp} \neq 0$  would cause  $E_{\parallel} \neq 0$

# Well known waveguide modes (1)

The most well known waveguide modes are:

- ◆ Rectangular waveguide:
  - ◆  $H_{10}$  ( $TE_{10}$ ) (fundamental mode, depends only from the width)

Electric field  
in cross section

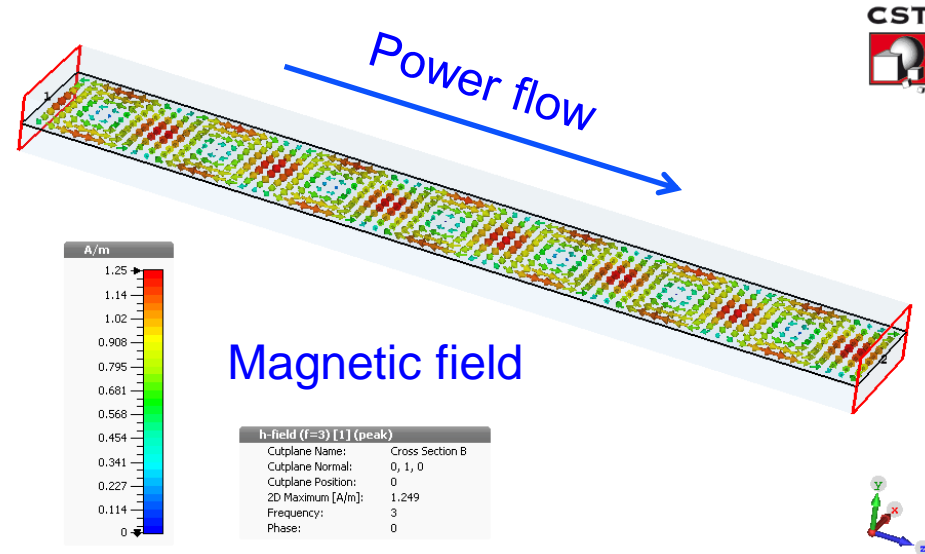
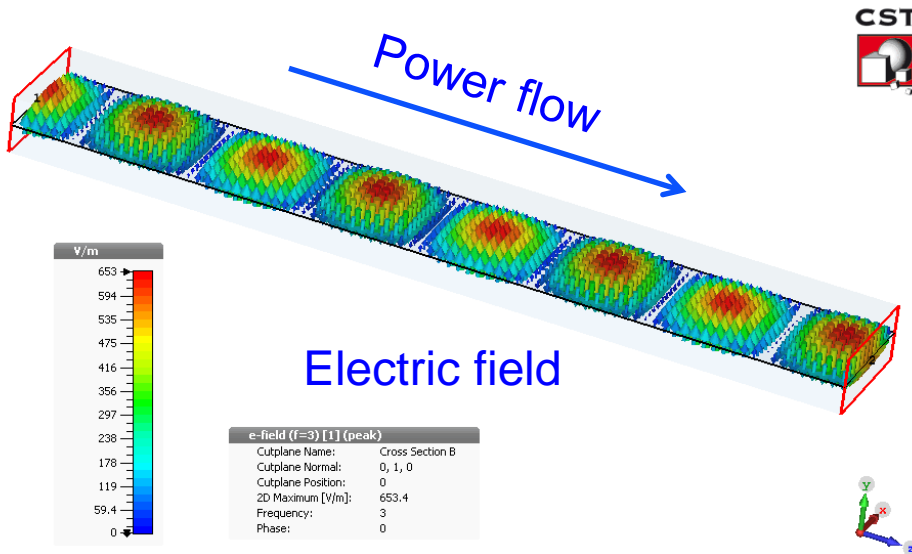
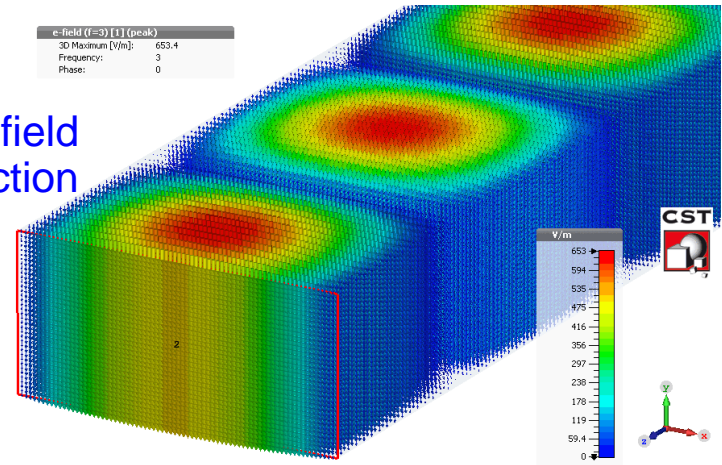

# Well known waveguide modes (2)

- ◆ Cylindrical waveguide:

- ◆  $E_{01}$  ( $TM_{01}$ ) mode is similar to the mode in coaxial cables.

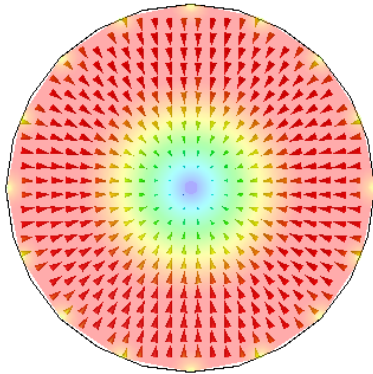

Transverse electric field (cross section)

- ◆  $H_{11}$  ( $TE_{11}$ ) mode has 2 polarizations, and the lowest cut-off frequency

How is the polarization defined?

Answer: W.r.t. the E field plane!

Why E field? Because it is easier to measure!

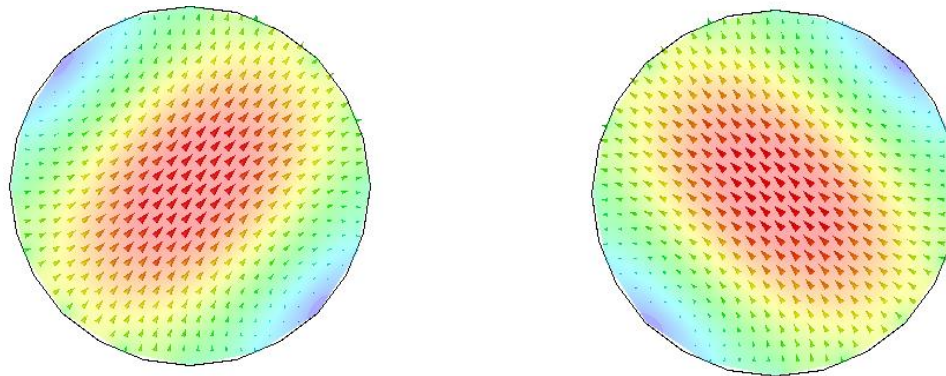

Transverse electric field (cross section)

Pictures: courtesy E. Jensen

# Higher order waveguide modes (1)

- ◆ Rectangular waveguide (transverse electric field in cross section):

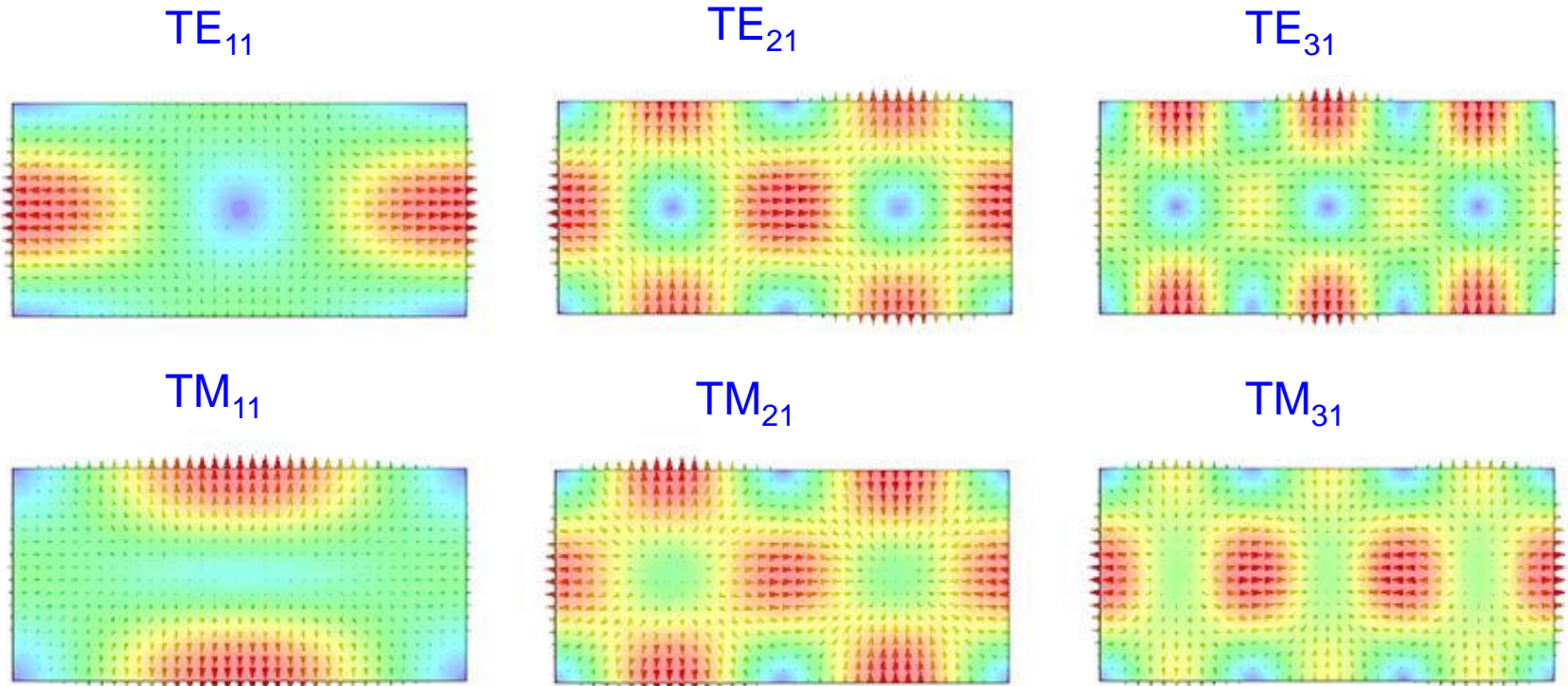

Pictures: courtesy E. Jensen

# Rectangular waveguide

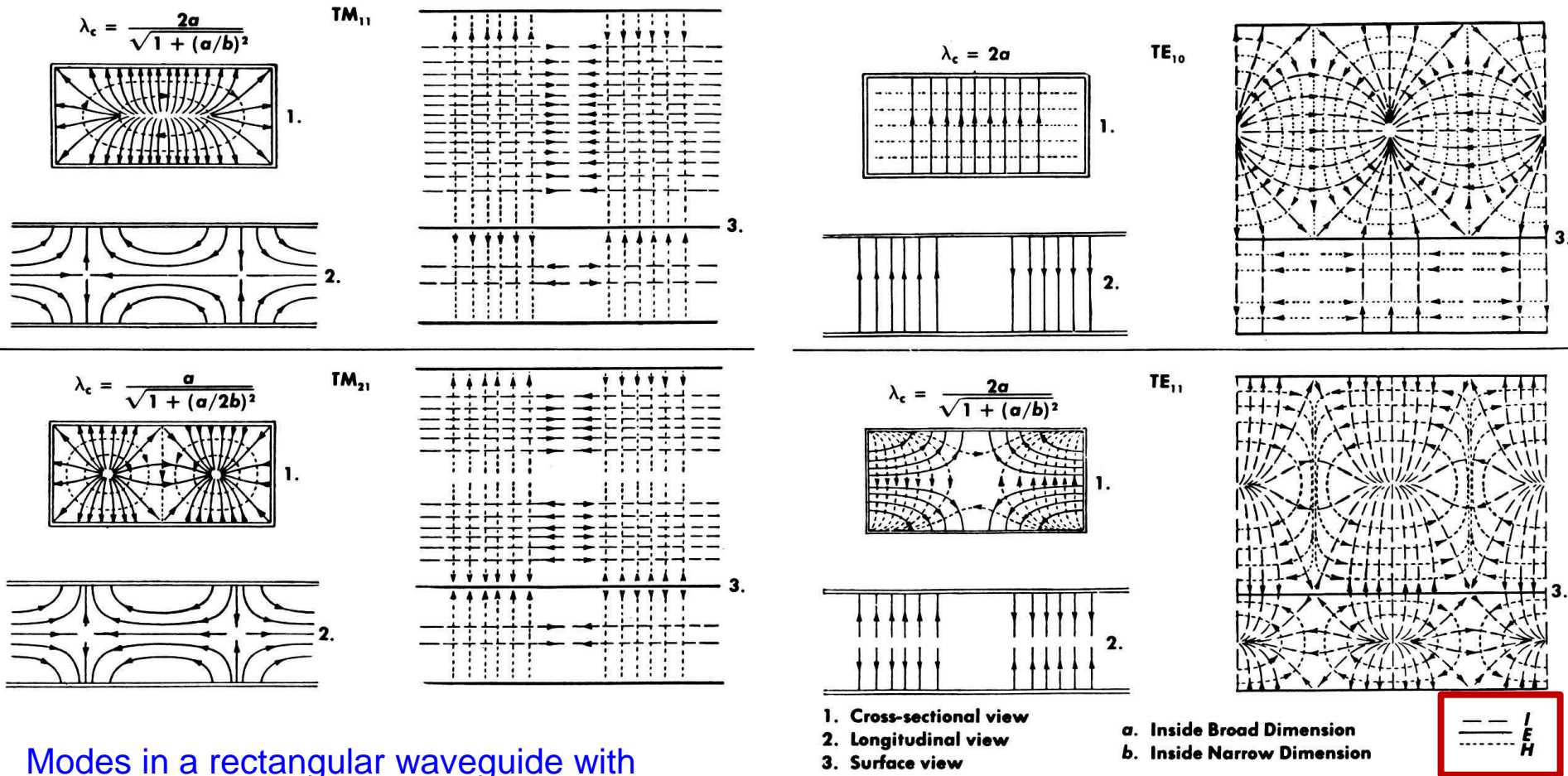

Modes in a rectangular waveguide with dimensions a and b.  
solid lines: E field, dotted lines: H field

Reprinted from Saad, T S, *Microwave Engineers' Handbook*, Artech House

# Higher order waveguide modes (2)

- ◆ Circular waveguide (cross-section plot of the transverse electric field):

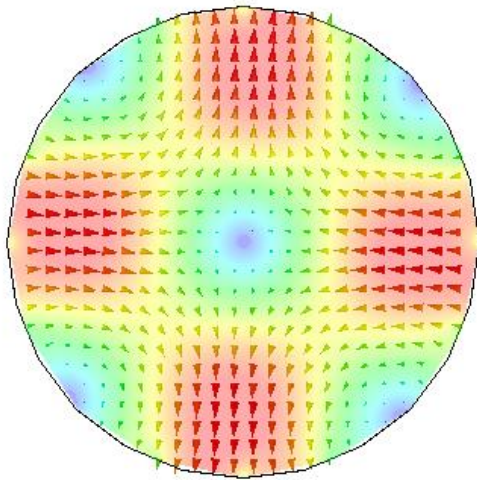

$TE_{21}$

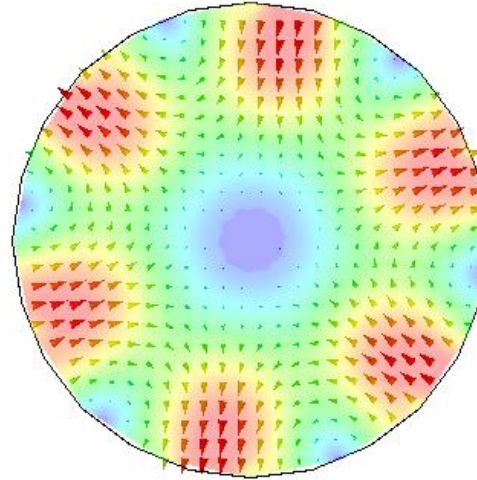

$TE_{31}$

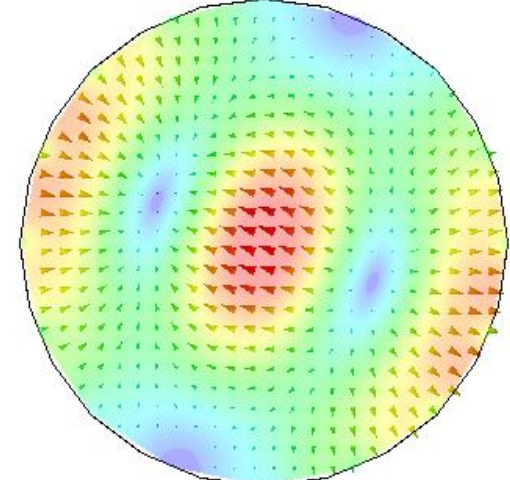

$TM_{11}$

- ◆  $TE_{21}$ : 2 pairs of maxima in azimuth, one maximum radially
- ◆  $TE_{31}$ : 3 pairs of maxima in azimuth, one maximum radially

Pictures: courtesy E. Jensen

# Circular waveguide

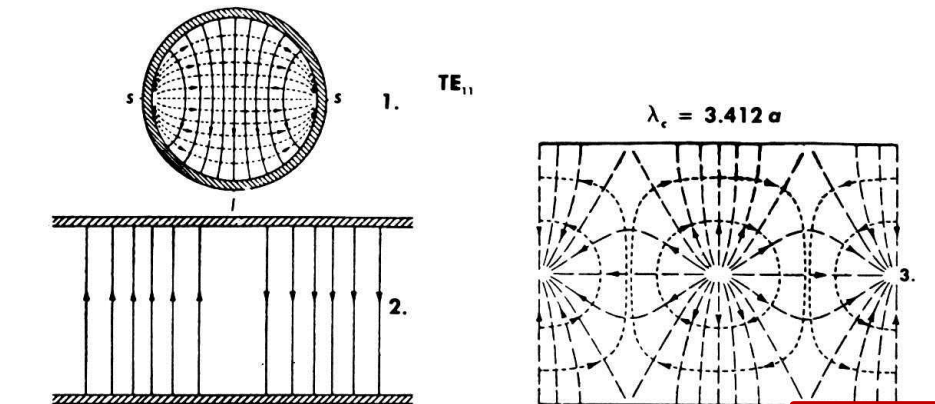
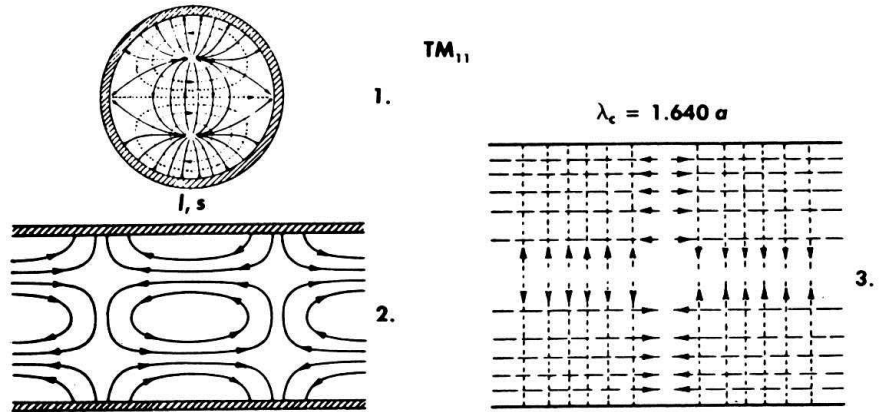
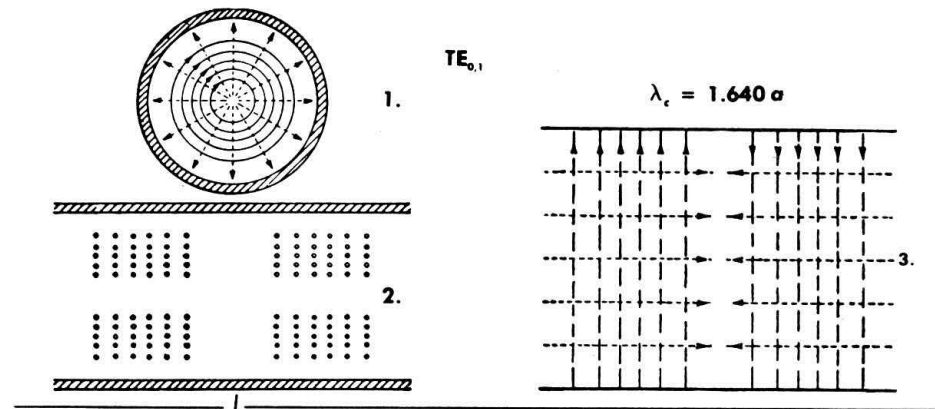
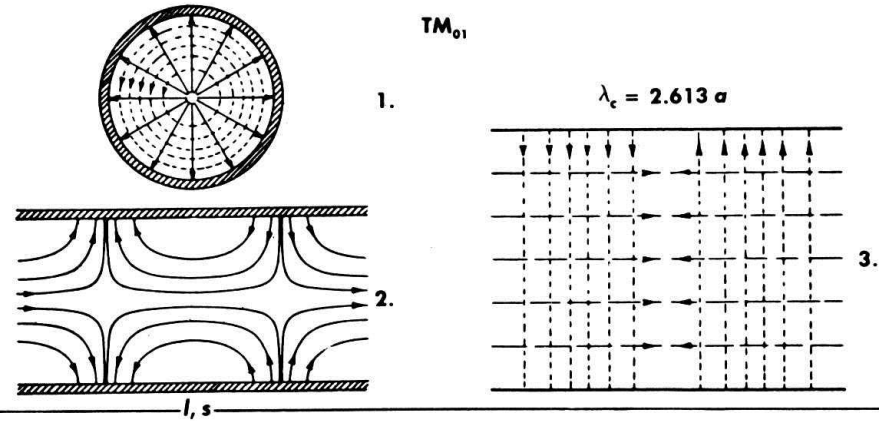

Modes in a circular waveguide with radius  $a$   
 solid lines: E field, dotted lines: H field  
 Please note the similarity to the pillbox cavity!

- 1. Cross-sectional view
  - 2. Longitudinal view through plane  $l-s$
  - 3. Surface view from  $s-s$
- $a$ . Inside Radius
- $I$

—  $E$

...  $H$

Reprinted from Saad, T S, *Microwave Engineers' Handbook*, Artech House



# Mode chart of a rectangular waveguide

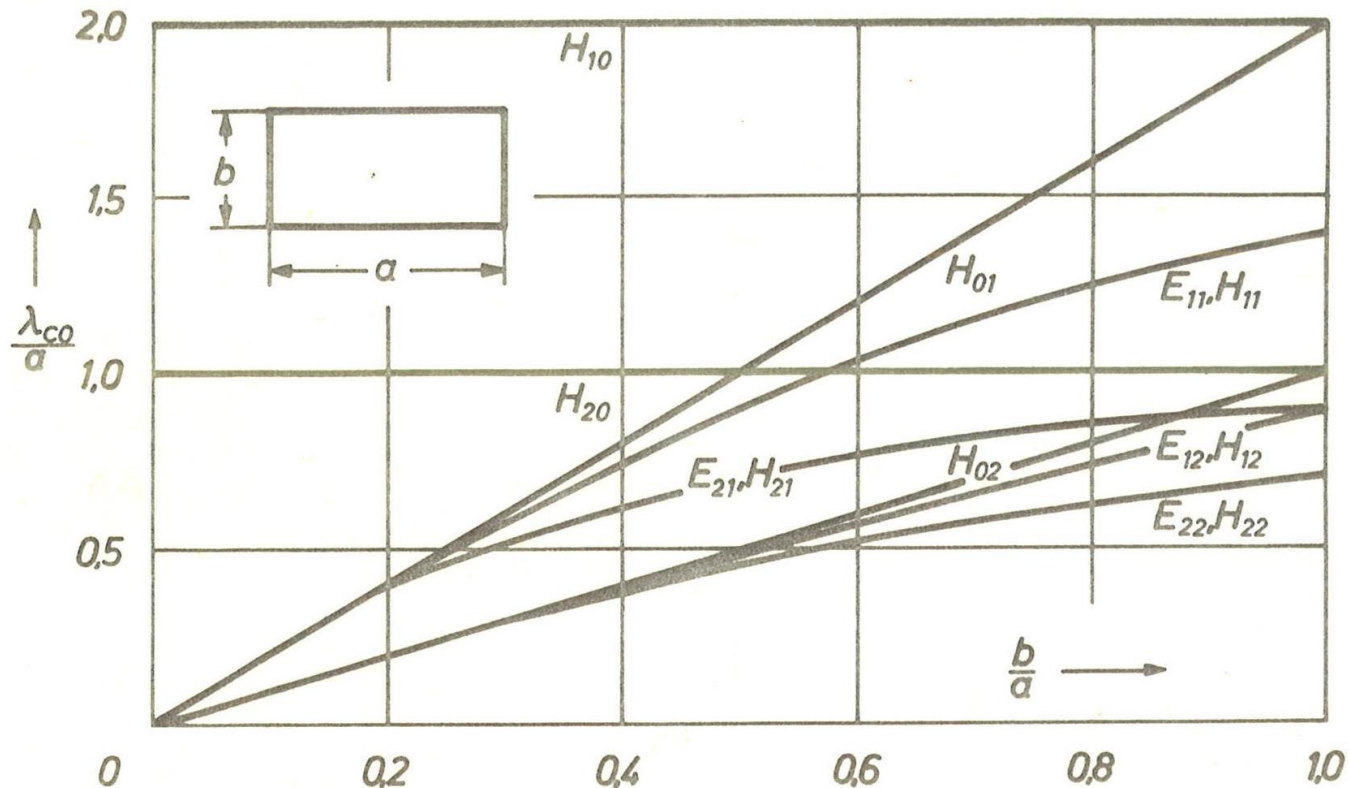

$\lambda_{co}$  = free space wavelength at cutoff

Cutoff frequency = frequency of the fundamental mode

Remember: H = TE      E = TM

# Mode chart of a cylindrical waveguide

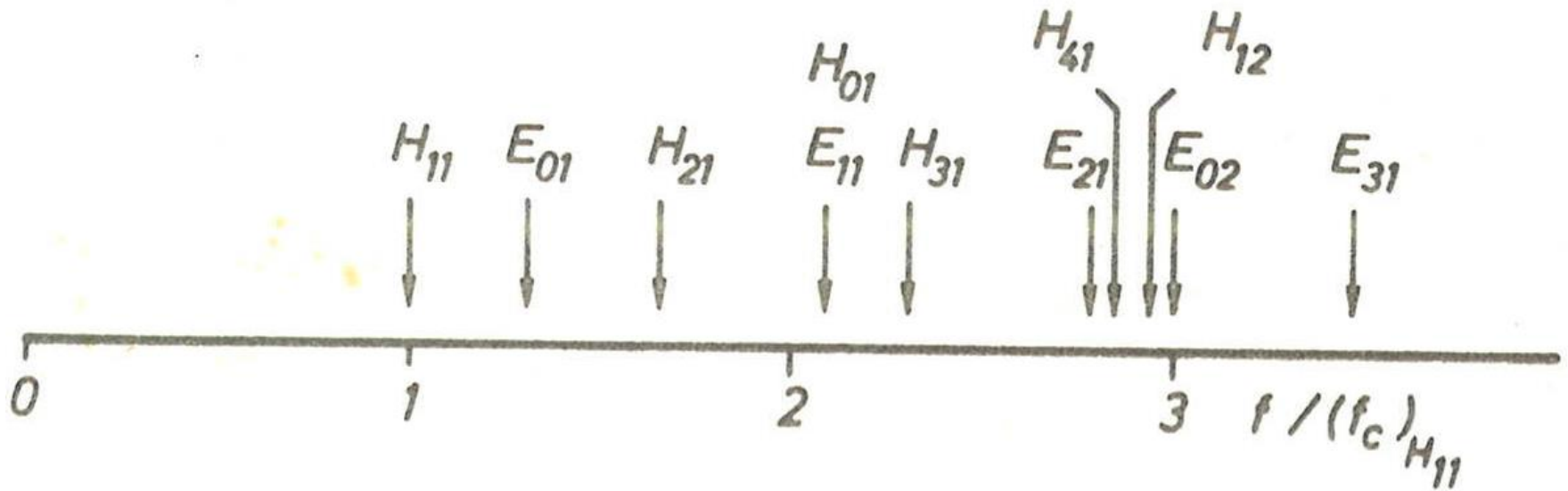

Why is the reference the  $H_{11}$  mode?

Because it is the fundamental mode of the cylindrical waveguide!

# Elliptical waveguide (1)

E field lines for  $TE_{10}$  mode

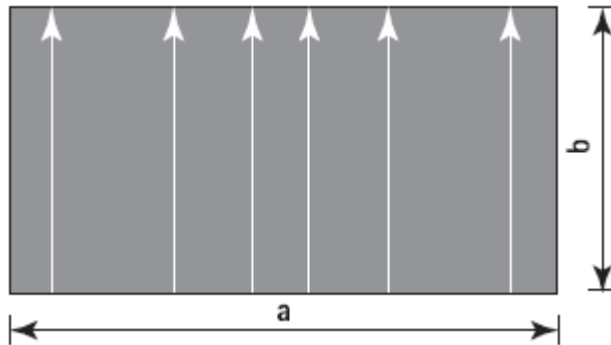

E field lines for  $TE_{c11}$  mode

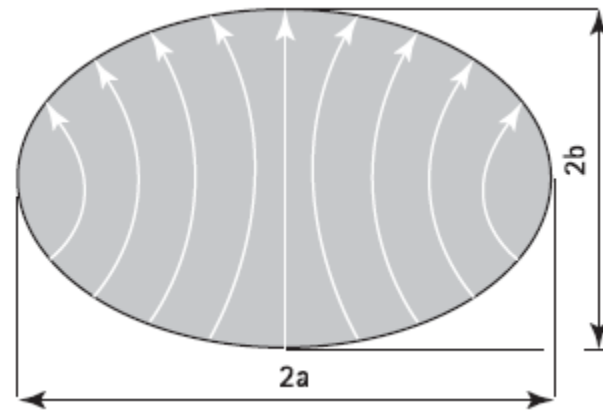

The small index  $c$  stands for the polarization and refers to sine (s) or cosine (c).

The cut-off wavelengths of the various modes that can propagate in an elliptical waveguide can be found analytically using rather complicated methods or numerically.

Application: beam pipes often have elliptical cross sections

# Elliptical waveguide (2)

Typical attenuation values for flexible elliptical waveguides:

Rigid rectangular cross-section waveguides are rather seldom used in industry.

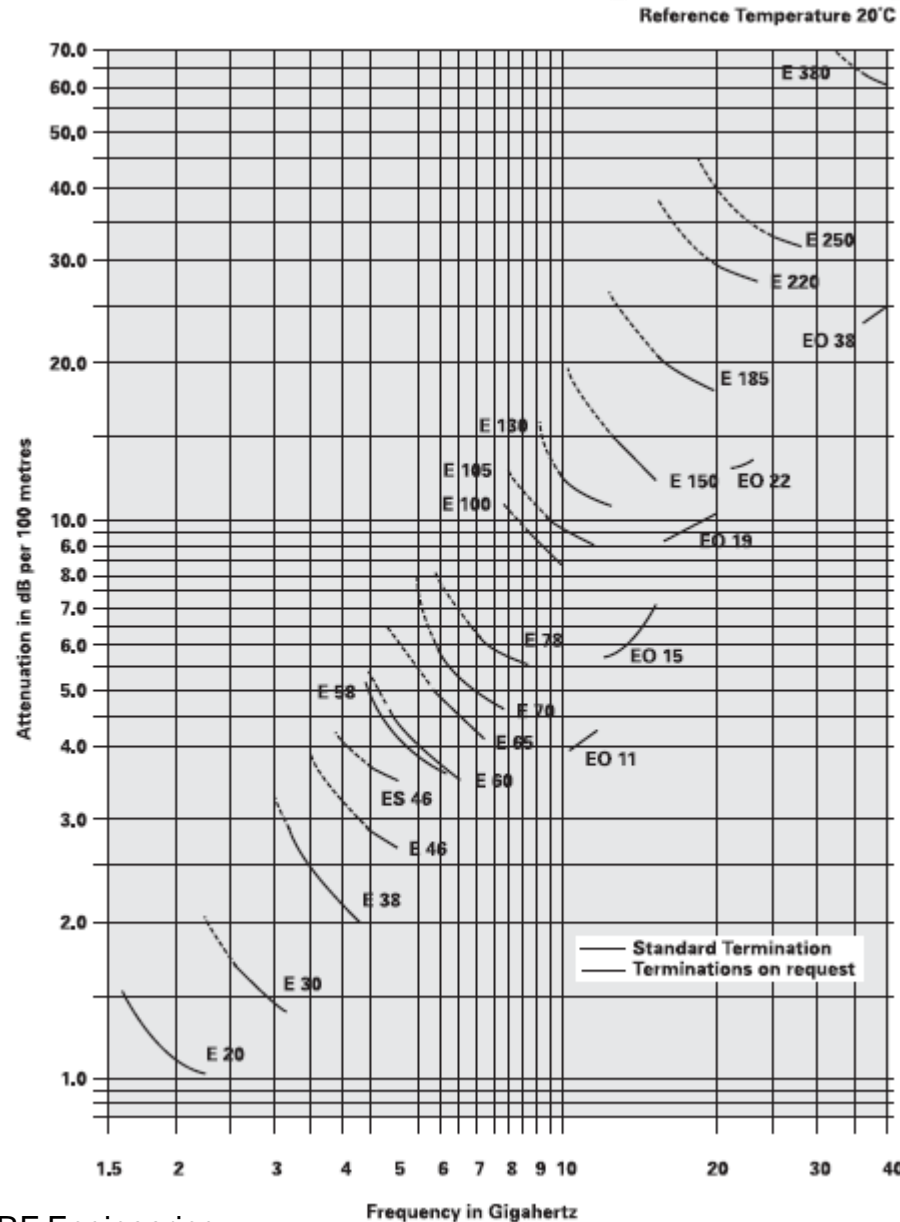

EO stands for overmoded waveguide

# Elliptical waveguide (3)

## Datasheet

WVG. TYPE	OPER. FREQ. GHz	CUT OFF FREQ. GHz	MAX. VSWR/ RETURN LOSS, dB	ATTENUATION dB/100m (ft)			AVG. POWER kW MID BAND	GROUP VELOCITY %c MID BAND	GROUP DELAY ns/100m (ft) MID BAND
				IN THE OPERATING FREQUENCY BAND					
				LOW BAND	MID BAND	HIGH BAND			
E30	2.7 - 3.1	1.8	1.128/24.4	1.61 (0.49)	1.49 (0.45)	1.4 (0.43)	30.37	78.4	425.4 (129.7)
E38	3.6 - 4.2	2.4	1.15/23.1	2.37 (0.72)	2.20 (0.67)	2.08 (0.63)	16.27	78.8	423.2 (129.0)
EP38	3.6 - 4.2	2.4	1.083/28.0	2.37 (0.72)	2.20 (0.67)	2.08 (0.63)	16.27	78.8	423.2 (129.0)
E46	4.4 - 5.0	2.88	1.15/23.1	2.92 (0.89)	2.80 (0.85)	2.73 (0.83)	10.93	79.0	422.1 (128.7)
EP46	4.4 - 5.0	2.88	1.083/28.0	2.92 (0.89)	2.80 (0.85)	2.73 (0.83)	10.93	79.0	422.1 (128.7)
ES46	4.4 - 5.0	3.08	1.15/23.1	3.69 (1.12)	3.55 (1.08)	3.49 (1.06)	8.39	75.5	441.6 (134.6)
ESP46	4.4 - 5.0	3.08	1.073/29.1	3.69 (1.12)	3.55 (1.08)	3.49 (1.06)	8.39	75.5	441.6 (134.6)
EP58	4.4 - 6.2	3.56	1.083/28.0	5.10 (1.55)	3.96 (1.21)	3.60 (1.10)	6.54	74.1	450.3 (137.2)
E60	5.6 - 6.425	3.65	1.15/23.1	4.15 (1.27)	3.95 (1.20)	3.80 (1.16)	7.24	79.4	420.3 (128.1)
EP60	5.6 - 6.425	3.65	1.062/30.5	4.15 (1.27)	3.95 (1.20)	3.80 (1.16)	7.24	79.4	420.3 (128.1)
E65	5.9 - 7.125	4.01	1.15/23.1	4.9 (1.50)	4.5 (1.37)	4.25 (1.30)	5.26	78.7	423.8 (129.2)
EP65	5.9 - 7.125	4.01	1.062/30.5	4.9 (1.50)	4.5 (1.37)	4.25 (1.30)	5.26	78.7	423.8 (129.2)
EP70	6.4 - 7.75	4.34	1.062/30.5	5.5 (1.68)	5.0 (1.52)	4.8 (1.46)	4.65	79.1	421.5 (128.5)
E78	7.1 - 8.5	4.72	1.15/23.1	6.2 (1.89)	5.8 (1.77)	5.6 (1.71)	3.67	79.6	419.0 (127.7)
EP78	7.1 - 8.5	4.72	1.062/30.5	6.2 (1.89)	5.8 (1.77)	5.6 (1.71)	3.67	79.6	419.0 (127.7)
EP100	9.0 - 10.0	6.43	1.105/26.0	9.5 (2.90)	8.9 (2.71)	8.4 (2.56)	1.91	73.6	453.1 (138.1)
E105	10.0 - 11.7	6.49	1.15/23.1	9.6 (2.92)	9.2 (2.79)	8.9 (2.71)	1.77	79.9	417.3 (127.2)
EP105	10.0 - 11.7	6.49	1.062/30.5	9.6 (2.92)	9.2 (2.79)	8.9 (2.71)	1.77	79.9	417.3 (127.2)
E130	10.7 - 13.25	7.43	1.15/23.1	12.6 (3.84)	11.5 (3.52)	11.1 (3.39)	1.22	78.5	424.8 (129.5)
EP130	10.7 - 13.25	7.43	1.083/28.0	12.6 (3.84)	11.5 (3.52)	11.1 (3.39)	1.22	78.5	424.8 (129.5)
E150	13.4 - 15.35	8.64	1.15/23.1	14.6 (4.44)	14.0 (4.26)	13.7 (4.16)	0.88	79.7	418.6 (127.6)
EP150	13.4 - 15.35	8.64	1.083/28.0	14.6 (4.44)	14.0 (4.26)	13.7 (4.16)	0.88	79.7	418.6 (127.6)
E185	17.3 - 19.7	11.06	1.15/23.1	20.3 (6.17)	19.4 (5.92)	18.9 (5.75)	0.51	80.2	416.1 (126.8)
EP185	17.3 - 19.7	11.06	1.083/28.0	20.3 (6.17)	19.4 (5.92)	18.9 (5.75)	0.51	80.2	416.1 (126.8)
E220	21.2 - 23.6	13.36	1.105/26.0	28.8 (8.77)	28.3 (8.63)	28.1 (8.56)	0.31	80.3	415.6 (126.7)
E250	24.25 - 26.5	15.06	1.15/23.1	33.2 (10.1)	32.4 (9.88)	32.0 (9.75)	0.31	80.5	414.2 (126.3)
E300	27.5 - 33.4	19.05	1.15/23.1	50.0 (15.2)	46.0 (14.0)	44.4 (13.5)	0.14	78.1	427.1 (130.2)
E380	37.0 - 39.5	23.45	1.15/23.1	61.3 (18.7)	60.7 (18.5)	60.0 (18.3)	0.09	79.1	421.9 (128.6)

# General Solution for a Rectangular (brick-type) Cavity

When describing field components in a Cartesian coordinates system (assuming a homogeneous and isotropic material in a space charge free volume) with harmonic functions (angular frequency  $\omega$ ) then each Cartesian component needs to fulfill Laplace's equation:

$$\Delta\Psi + k_0^2 \varepsilon_r \mu_r \Psi = 0$$

$$k_0^2 = \omega^2 \varepsilon_0 \mu_0 \quad k_0 \text{ free space wave number}$$

$$k_0 = 2\pi / \lambda_0 \quad \lambda_0 \text{ free space wave length}$$

As a general solution we can use the product ansatz for  $\Psi$

$$\Psi = X(x)Y(y)Z(z)$$

From this one obtains the general solution for  $\Psi$  ( $\Psi$  may be a vector potential or field)

$$\Psi = \left\{ \begin{array}{l} A \cdot \cos(k_x x) + B \cdot \sin(k_x x) \\ A' \cdot e^{-jk_x x} + B' \cdot e^{jk_x x} \end{array} \right\} \left\{ \begin{array}{l} C \cdot \cos(k_y y) + D \cdot \sin(k_y y) \\ C' \cdot e^{-jk_y y} + D' \cdot e^{jk_y y} \end{array} \right\} \left\{ \begin{array}{l} E \cdot \cos(k_z z) + F \cdot \sin(k_z z) \\ E' \cdot e^{-jk_z z} + F' \cdot e^{jk_z z} \end{array} \right\}$$

standing waves

travelling waves

with the separation condition

$$(k_x)^2 + (k_y)^2 + (k_z)^2 = (k_0)^2 \varepsilon_r \mu_r$$

$$k_x = \frac{n\pi}{a}$$

$$k_y = \frac{m\pi}{b}$$

$$k_z = \frac{p\pi}{c}$$

Cavity basics

see also: G. Dome, RF Theory  
Proceeding Oxford CAS, April 91  
CERN Yellow Report 92-03, Vol. I;

W. Demtroeder, Experimentalphysik 2,  
Springer 2004

# General Solution in Cylindrical Coordinates

As a general solution we can use the product ansatz for  $\Psi$

$$\Psi = R(\rho)F(\varphi)Z(z)$$

From this one obtains the general solution for  $\Psi$  ( $\Psi$  may be a vector potential or field)

$$\Psi = \left\{ \begin{array}{l} A \cdot J_m(k_\rho \rho) + B \cdot N_m(k_\rho \rho) \\ A' \cdot H_m^{(2)}(k_\rho \rho) + B' \cdot H_m^{(1)}(k_\rho \rho) \end{array} \right\} \left\{ \begin{array}{l} C \cdot \cos(m\varphi) + D \cdot \sin(m\varphi) \\ C' \cdot e^{-jm\varphi} + D' \cdot e^{jm\varphi} \end{array} \right\} \left\{ \begin{array}{l} E \cdot \cos(k_z z) + F \cdot \sin(k_z z) \\ E' \cdot e^{-jk_z z} + F' \cdot e^{jk_z z} \end{array} \right\}$$

standing waves ←  
travelling waves ←

and the functions

$J_m$  ... cylindrical harmonics of the Bessel function of order  $m$

$N_m$  ... cylindrical harmonics of the Neumann function of order  $m$

$H_m^{(1)}$  ... Hankel function of the first kind of order  $m$  (outward travelling wave)

$H_m^{(2)}$  ... Hankel function of the second kind of order  $m$  (inward travelling wave)

$$H_m^{(1)} = J_m + jN_m$$

$$H_m^{(2)} = J_m - jN_m$$

Here the separation condition is

$$\boxed{(k_\rho)^2 + (k_z)^2 = (k_0)^2 \varepsilon_r \mu_r}$$

Hint: the index  $m$  indicating the order of the Bessel and Neumann function shows up again in the argument of the sine and cosine for the azimuthal dependency.

# Bessel Functions (1)

A nice example of the derivation of a Bessel function is the solution of the cylinder problem of the capacitor given in the Feynman reference (Bessel function via a series expansion).

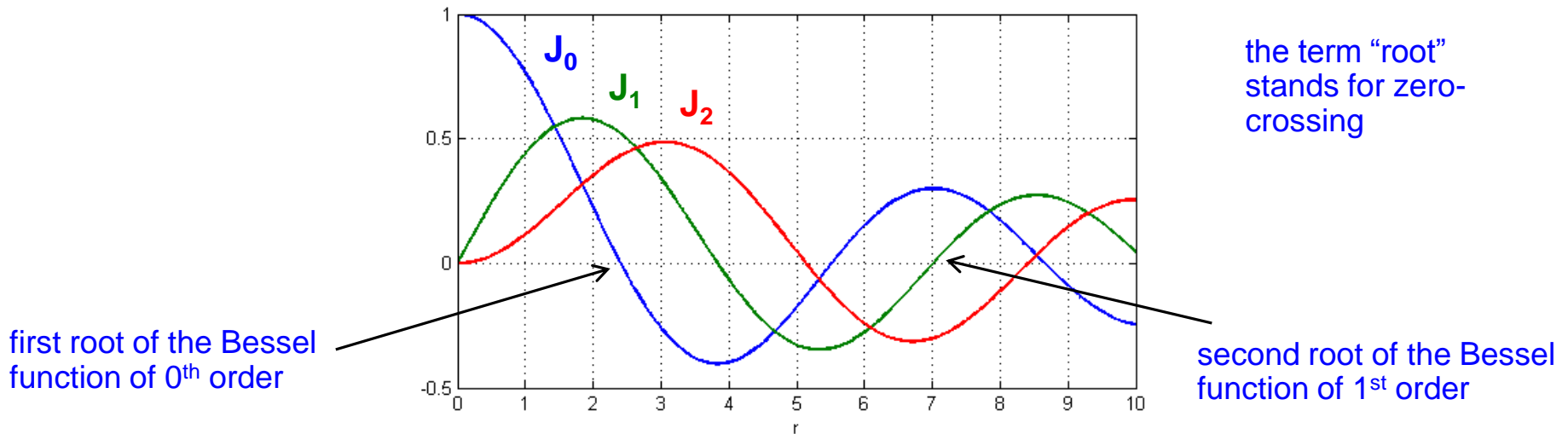

- ◆ Comment: For the generalized solution of cylinder symmetrical boundary value problems (e.g. higher order modes on a coaxial resonator) Neumann functions are required. Standing wave patterns are described by Bessel- and Neumann functions respectively, radially travelling waves in terms of Hankel functions.
- ◆ Hint: Sometimes the **Bessel function** is called **Bessel function of first kind**, a **Neumann** (or **Weber's**) **function** is a **Bessel function of second kind**, and a **Hankel function** is called a **Bessel function of third kind**.



# Bessel Functions (2)

Some practical numerical values:

k-th roots of the first five Bessel functions:

$k$	$J_0(x)$	$J_1(x)$	$J_2(x)$	$J_3(x)$	$J_4(x)$	$J_5(x)$
1	2.4048	3.8317	5.1356	6.3802	7.5883	8.7715
2	5.5201	7.0156	8.4172	9.7610	11.0647	12.3386
3	8.6537	10.1735	11.6198	13.0152	14.3725	15.7002
4	11.7915	13.3237	14.7960	16.2235	17.6160	18.9801
5	14.9309	16.4706	17.9598	19.4094	20.8269	22.2178

See: <http://mathworld.wolfram.com/BesselFunctionZeros.html>

# Bessel Functions (3)

For determination of cutoff frequencies of E and H type waveguide modes (travelling wave case):

$n \backslash m$	0	1	2	3
1	$H_{01}$ 3,832	$H_{11}$ 1,841	$H_{21}$ 3,054	$H_{31}$ 4,201
2	$H_{02}$ 7,016	$H_{12}$ 5,331	$H_{22}$ 6,706	$H_{32}$ 8,015
3	$H_{03}$ 10,173	$H_{13}$ 8,536	$H_{23}$ 9,969	$H_{33}$ 11,346

$n \backslash m$	0	1	2	3
1	$E_{01}$ 2,405	$E_{11}$ 3,832	$E_{21}$ 5,136	$E_{31}$ 6,380
2	$E_{02}$ 5,520	$E_{12}$ 7,016	$E_{22}$ 8,417	$E_{32}$ 9,761
3	$E_{03}$ 8,654	$E_{13}$ 10,173	$E_{23}$ 11,620	$E_{33}$ 13,015

# Neumann Functions

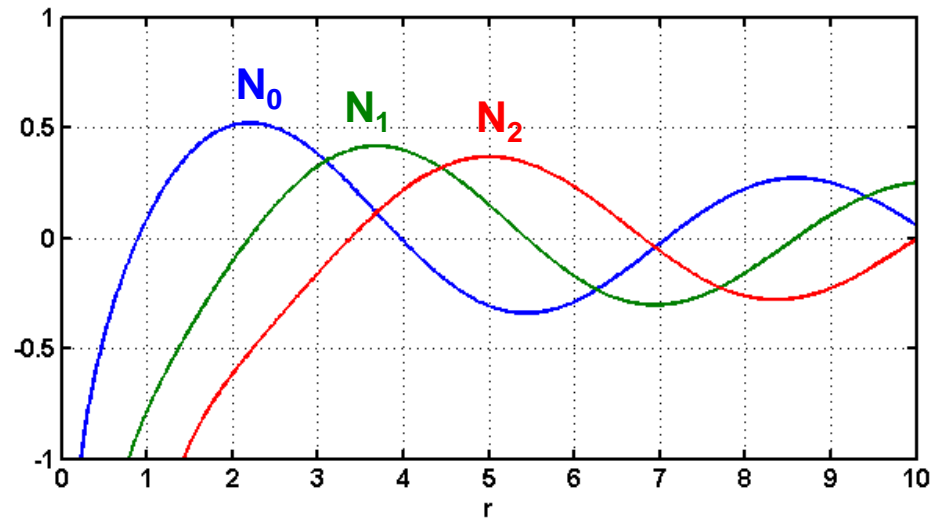

Neumann functions are often also denoted as  $Y_m(r)$ .

Important f.e. for coaxial cables. The conductor in the core averts the pole at  $r=0$

# Electromagnetic waves

- ◆ Propagation of electromagnetic waves inside empty metallic channels is possible: there exist solutions of Maxwell's equations describing waves
- ◆ These waves are called waveguide modes
- ◆ There exist two types of waves,
  - Transverse electric (TE) modes:  
→ the electric field has only transverse components
  - Transverse magnetic (TM) modes:  
→ the magnetic field has only transverse components
- ◆ Propagate at above a characteristic cut-off frequency
- ◆ In a rectangular waveguide, the first mode that can propagate is the TE<sub>10</sub> mode. The condition for propagation is that half of a wavelength can “fit” into the cross-section => cut-off wavelength  $\lambda_c = 2a$
- ◆ The modes are named according to the number of field maxima they have along each dimension. The E field of the TE<sub>10</sub> mode for instance has 1 maximum along x and 0 maxima along the y axis.
- ◆ For circular waveguides, the maxima are counted in the radial and azimuthal direction

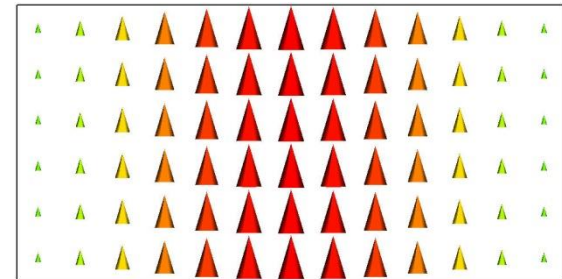

Transverse E-field of the fundamental TE<sub>10</sub> mode

# Mode Indices in Resonators (1)

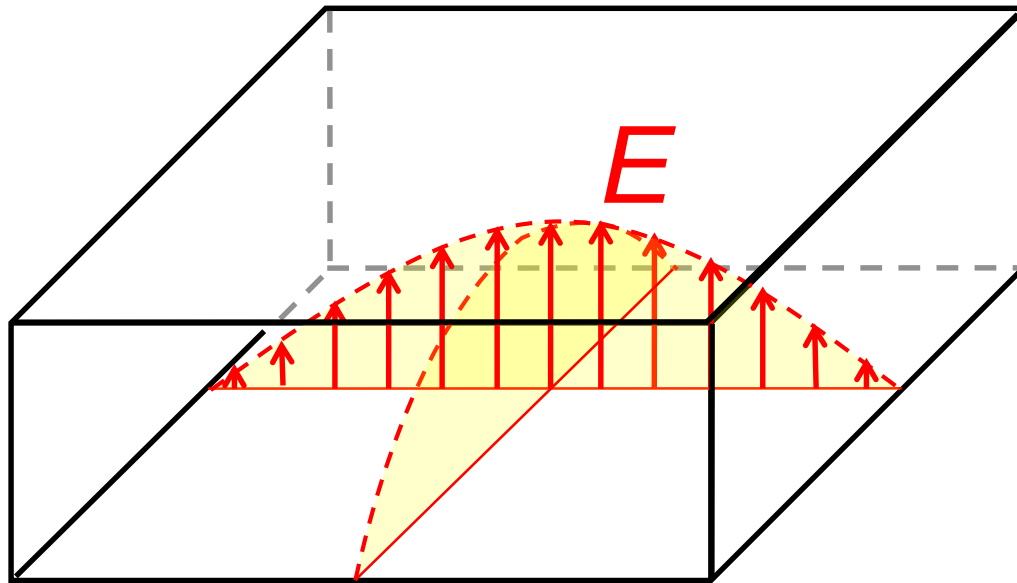

$$\text{TE}_{101} \\ = \text{H}_{101}$$

For a structure in rectangular coordinates the mode indices simply indicate the **number of half waves** (standing waves) along the respective axis. Here we have one maximum along the x-axis, no maximum in vertical dimension (y-axis), and one maximum along the z-axis.  $\text{TE}_{101}$  corresponds to  $\text{TE}_{xyz}$

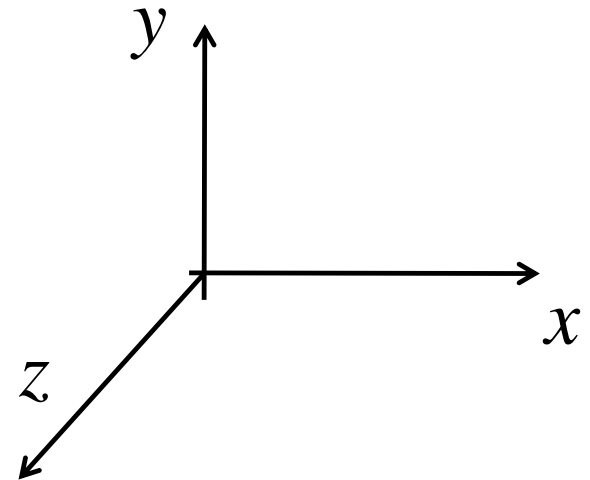

# Mode Indices in Resonators (2)

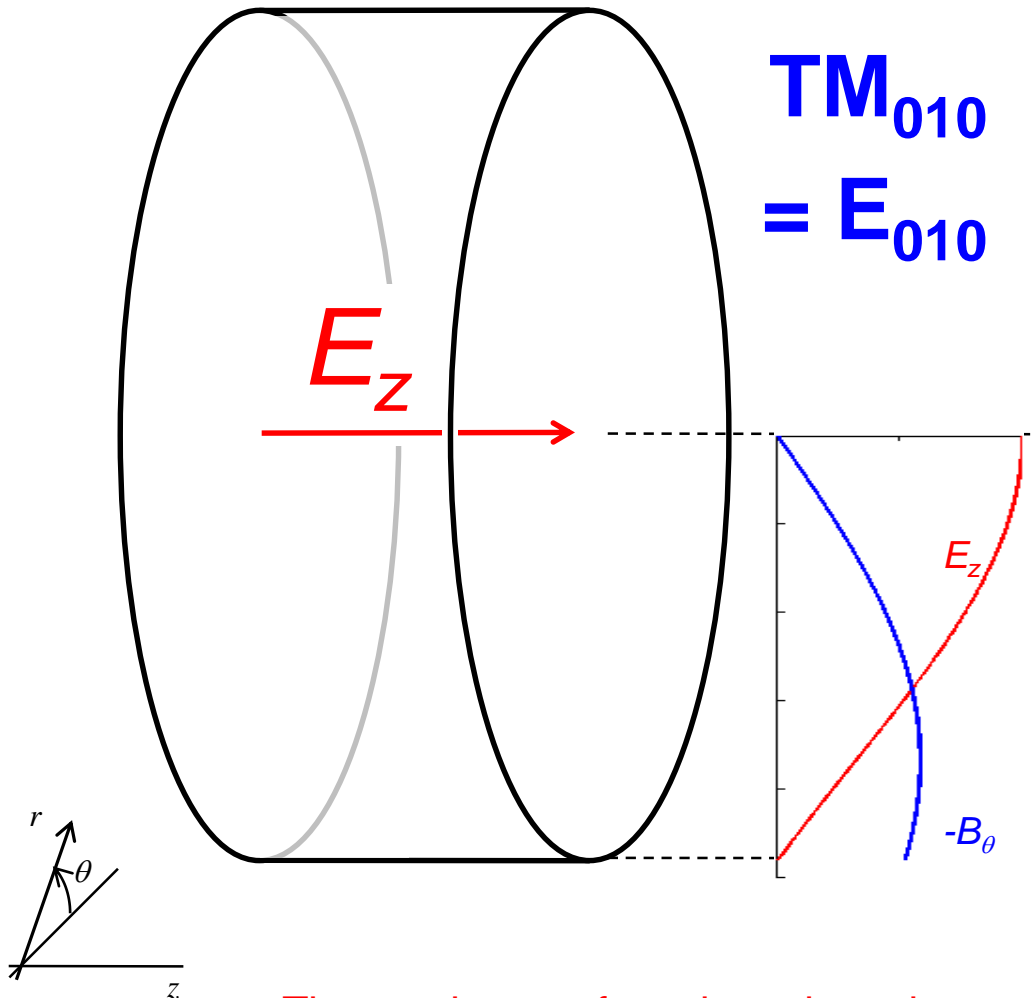

$$\text{TM}_{010} \\ = \text{E}_{010}$$

For a structure in cylindrical coordinates:

The first index is the order of the Bessel function or in general cylindrical function.

The second index indicates “the root” of the cylindrical function which is the number of zero-crossings.

The third index is the number of half waves (maxima) along the z-axis.

Hint: In an empty pillbox there will be no Neumann function as it has a pole in the center (conservation of energy). However we need Bessel and Neumann functions for higher order modes of **coaxial** structures.

The number  $m$  of maxima along the azimuth is coupled to the order of the Bessel function (see slide on theory).

# Fields in a pillbox cavity

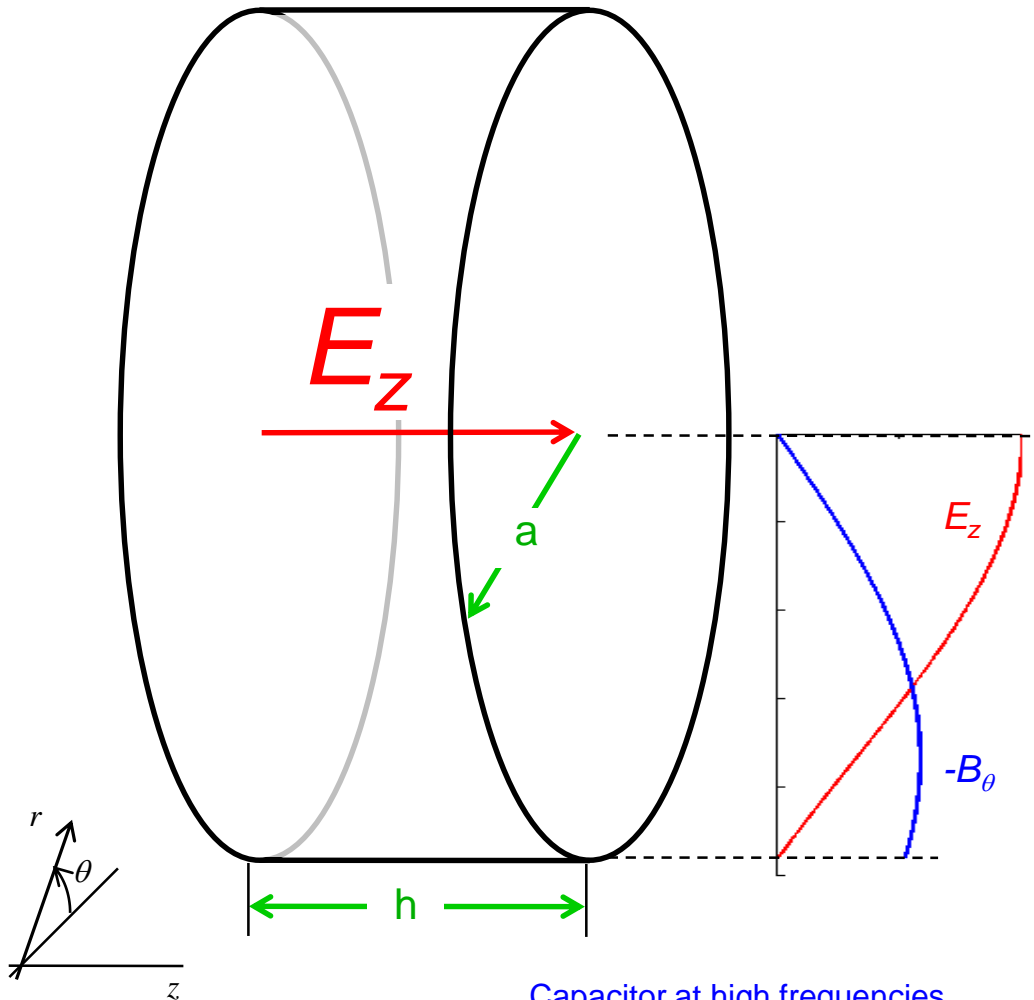

Cavity height:  $h$   
cavity radius:  $a$

$TM_{010}$  mode resonance  
=  $E_{010}$  mode resonance for

$$a = 0.383\lambda = 1.53\lambda / 4$$

$TM_{010}$  resonance frequency  
**independent of  $h$ !!!**

In the cylindrical geometry the  $E$  and  $H$  fields are proportional to Bessel functions for the radial dependency.

Capacitor at high frequencies,  
The Feynman Lectures on Physics

# Common cavity geometries (1)

Square prism  $H_{101}$  or  $TE_{101}$

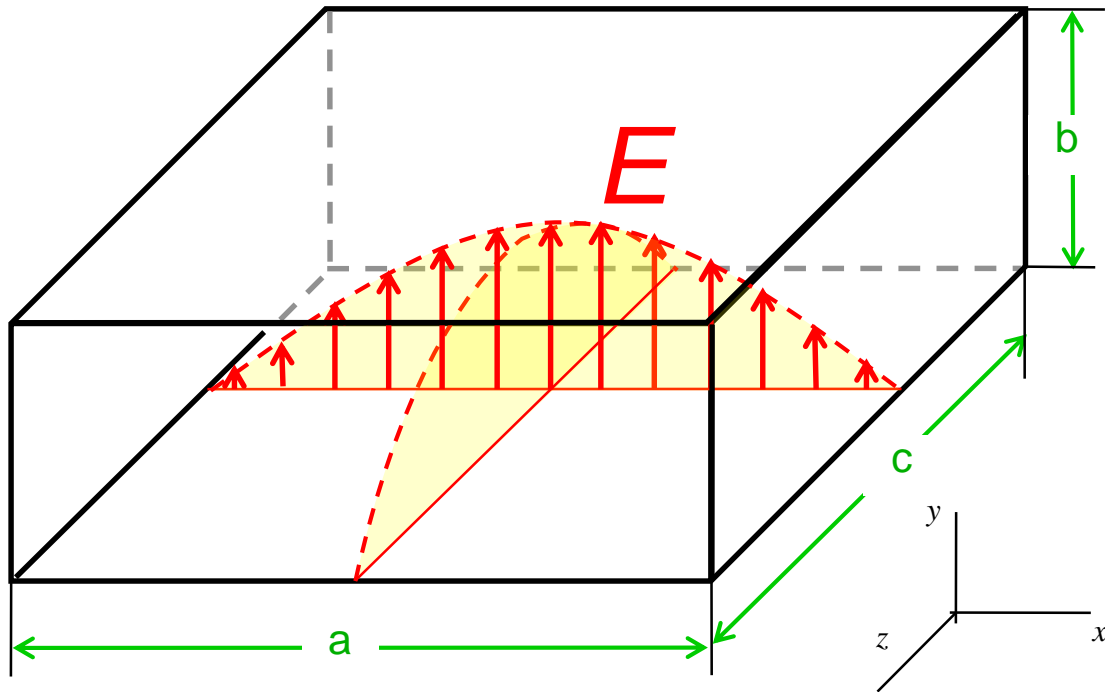

Comment: For a brick-shaped cavity (the structure is described in Cartesian coordinates) the  $E$  and  $H$  fields would be described by sine and cosine distributions. The mode indices indicate the number of half waves along the  $x$ -,  $y$ -, and  $z$ -axis, respectively.

$$\lambda_0 = \frac{2}{\sqrt{\left(\frac{m}{a}\right)^2 + \left(\frac{n}{b}\right)^2 + \left(\frac{p}{c}\right)^2}}$$

$$Q_{H_{101}} = \frac{\lambda_0 b}{\delta} \frac{(a^2 + c^2)^{3/2}}{2c^3(a + 2b) + a^3(c + 2b)}$$

form factor (dimensionless)

$$\text{Skin depth } \delta = \sqrt{\frac{2}{\omega\sigma\mu}}$$

with  $\omega = 2\pi f$

this simplifies in the case  $a=c$ :

$$\lambda_0 = \sqrt{2}a$$

$$Q = \frac{1}{\delta} \frac{ab}{a + 2b}$$



# Common cavity geometries (2)

Circular cylinder:  $E_{010}, = TM_{010}$

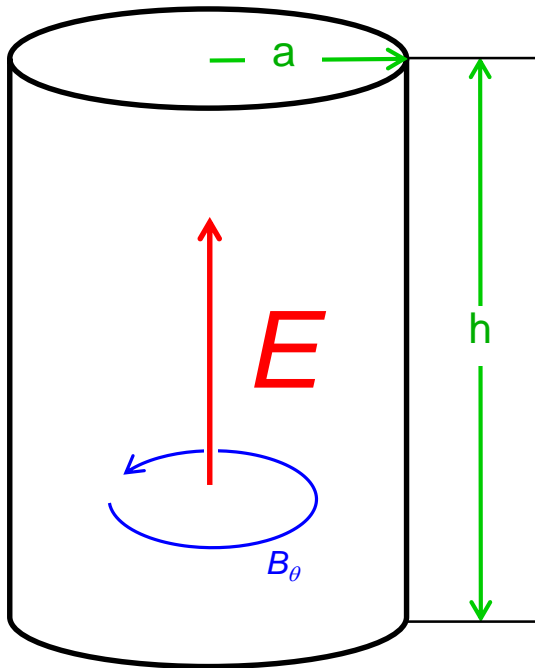

$$\lambda_0 = 2.61a$$

$$Q = \left( 0.383 \frac{\lambda_0}{\delta} \right) \left[ 1 + \left( 0.383 \frac{\lambda_0}{h} \right) \right]^{-1}$$
$$= 0.383 \lambda_0 / \delta \left[ 1 + \frac{a}{h} \right]^{-1} = \frac{a}{\delta} \left[ 1 + \frac{a}{h} \right]^{-1}$$

$$R/Q \approx 185 h/a \quad \text{for } h/a < 0.5 \quad ^1$$

Note:  $h$  denotes the **full** height of the cavity  
In some cases and also in certain numerical codes,  $h$  stands for the half height

<sup>1</sup>: This formula uses Linac definition and includes time transit factor ( $v=c$ )

# R/Q for cavities

The full formula for calculating the R/Q value of a cavity is

$$\frac{R}{Q} = \frac{4\eta}{\chi_{01}^3 \pi J_1^2(\chi_{01})} \frac{\sin^2\left(\frac{\chi_{01}}{2} \frac{h}{a}\right)}{\frac{h}{a}}$$

see lecture: RF cavities, E. Jensen, Varna CAS 2010

with

$$\eta = \sqrt{\frac{\mu_0}{\epsilon_0}} = \sqrt{\mu_0^2 c_0^2} = 4\pi \times 10^{-7} \times 3 \times 10^8 = 377\Omega$$

$$\chi_{01} = 2.4048 \quad (\text{First zero of the Bessel function of 0}^{\text{th}} \text{ order})$$

$$J_1(\chi_{01}) = 0.5192$$

This leads to

$$\frac{R}{Q} = 128 \frac{\sin^2\left(1.2024 \frac{h}{a}\right)}{\frac{h}{a}}$$

The sinus can be approximated by  $\sin(x) = x$  (for small values of  $x$ ) leading to

$$\frac{R}{Q} \approx 128 \frac{\left(1.2024 \frac{h}{a}\right)^2}{\frac{h}{a}} = 185 \frac{h}{a}$$

# Common cavity geometries (3)

Circular cylinder:

$H_{011}$

$$Q = 0.61 \frac{\lambda_0}{\delta} \frac{\left[ 1 + 0.17 \left( \frac{2a}{h} \right)^2 \right]^{3/2}}{1 + 0.17 \left( \frac{2a}{h} \right)^3}$$

$H_{111}$

$$Q = 0.206 \frac{\lambda_0}{\delta} \frac{\left[ 1 + 0.73 \left( \frac{2a}{h} \right)^2 \right]^{3/2}}{1 + 0.22 \left( \frac{2a}{h} \right)^2 + 0.51 \left( \frac{2a}{h} \right)^3}$$

# Common cavity geometries (4)

## Coaxial TEM

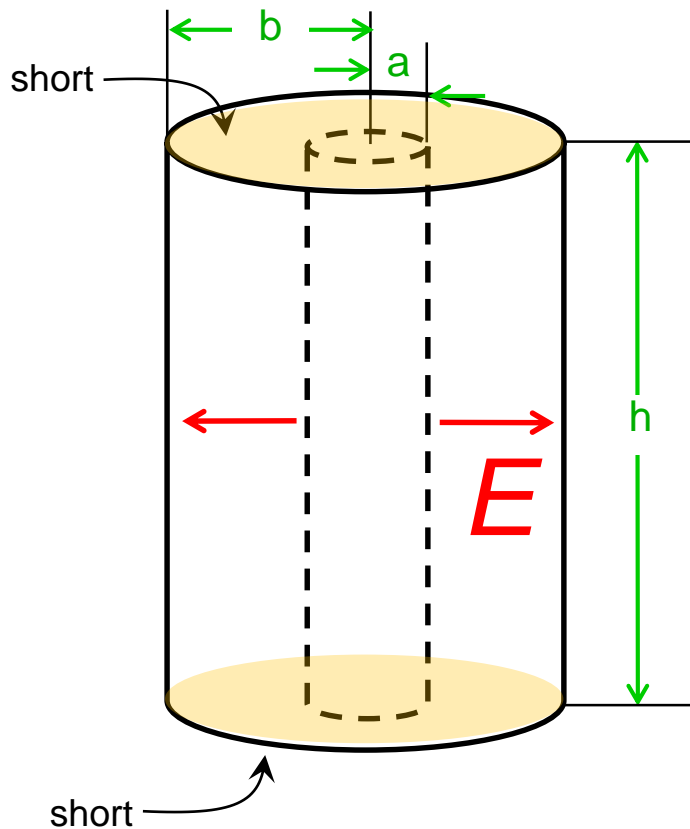

$$\lambda_0 = 2h \text{ or } h = \lambda_0 / 2$$

$$Q = \frac{\lambda_0}{\delta} \frac{1}{4 + \frac{h}{b} \cdot \frac{1+b/a}{\ln(b/a)}}$$

Optimum  $Q$  for  $(b/a) = 3.6$  ( $Z_{Copt} = 77\Omega$ )

$$Q_{optimum} = \frac{\lambda_0}{\delta} \frac{1}{4 + 7.2 \frac{h}{b}}$$

Coaxial line with minimum loss

→ slide TEM transmission lines (3)

Taken from S. Saad et.al.,  
Microwave Engineers' Handbook, Volume I, p.180

# Common cavity geometries (5)

Sphere

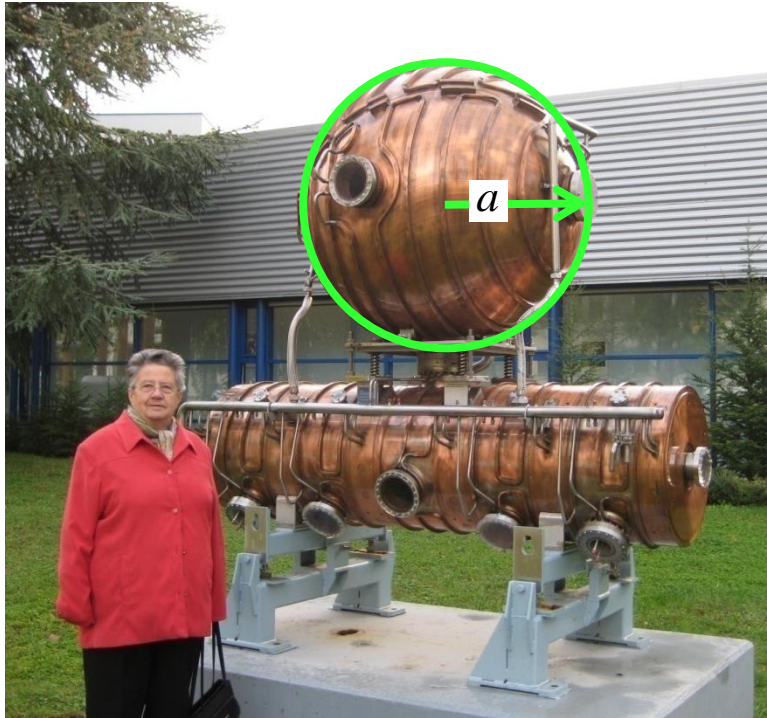

“Energy storage in LEP”

$$\lambda_0 = 2.28a$$

$$Q = 0.318(\lambda / \delta)$$

Sphere with cones

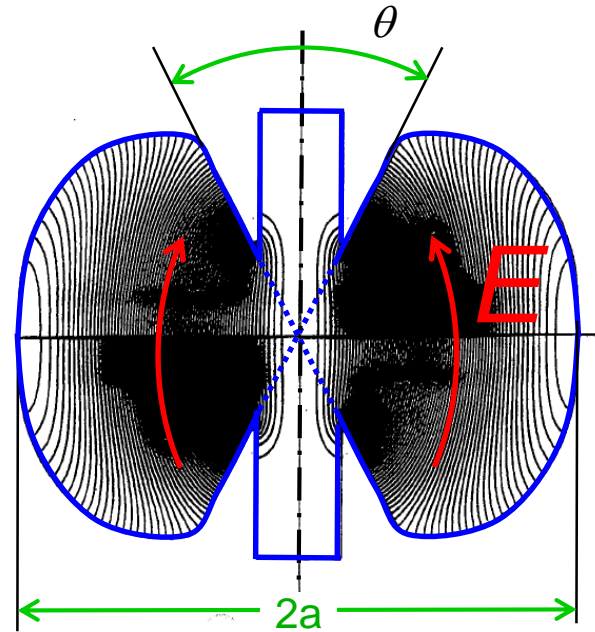

“Nose cone cavity”

$$\lambda_0 = 4a \rightarrow a = \lambda_0 / 4$$

Optimum  $Q$  for  $\theta = 34^\circ$

$$Q_{opt,34^\circ} = 0.1095(\lambda / \delta)$$

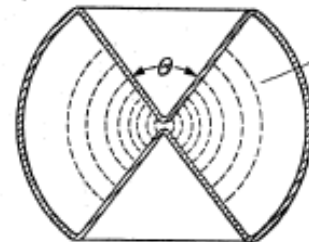

the tips of the cone don't touch

a spherical “ $\lambda/4$ -resonator”

# Mode chart of a brick-shaped cavity – Version 1

Reprinted from Meinke, H. and Gundlach, F. W.,  
*Taschenbuch der Hochfrequenztechnik*, S.469  
 Erste Auflage, Springer-Verlag, Berlin (1968) and  
*Techniques of Microwave Measurements* by Carol G. Montgomery,  
 1st ed., 1947; by permission, McGraw-Hill Book Co., N. Y.

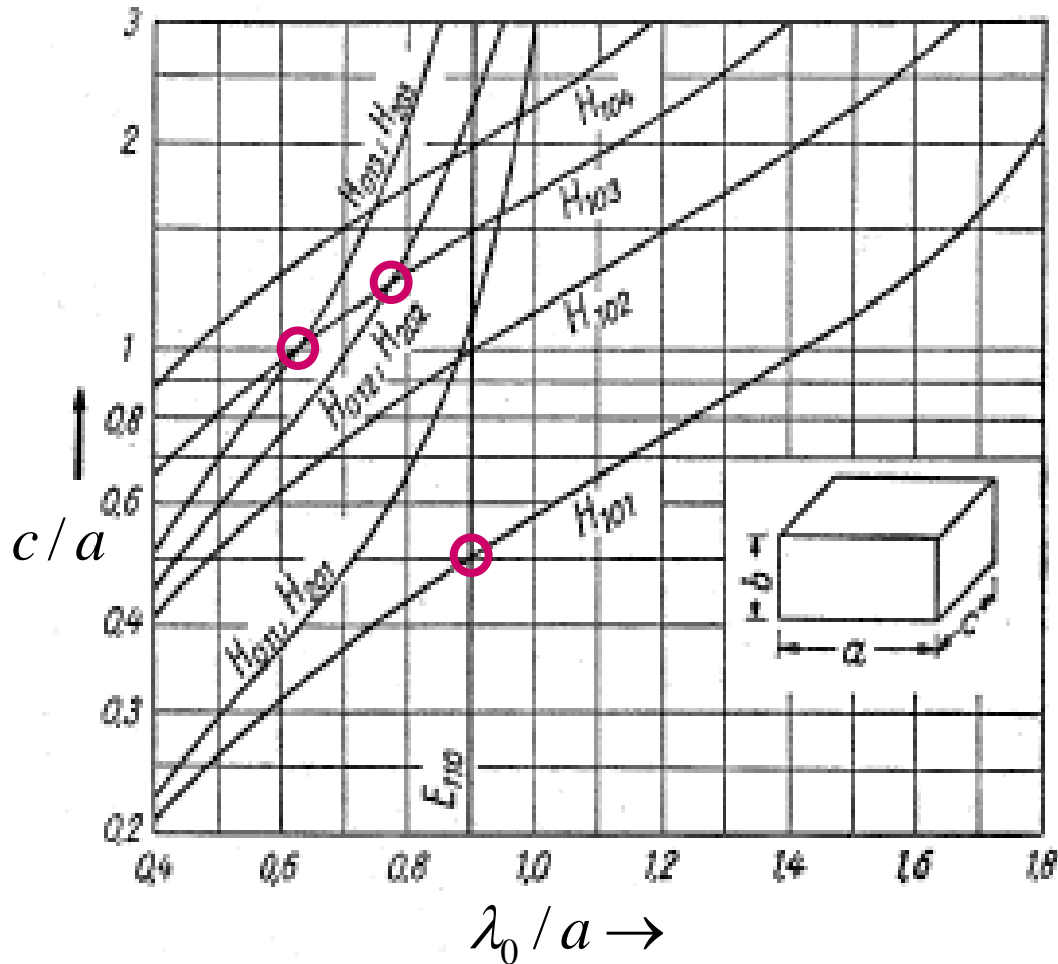

The resonant wavelength of the  $H_{mnp}$  resonance calculates as

$$\lambda_0 = \frac{2}{\sqrt{\left(\frac{m}{a}\right)^2 + \left(\frac{n}{b}\right)^2 + \left(\frac{p}{c}\right)^2}}$$

for a  $E_{mn}$  or a  $H_{mn}$  wave with  $p$  half waves along the  $c$ -direction.

○ ... Degenerate modes

**Attention: The chart is only valid for  $a:b = 2:1$**

# Mode chart of a Pillbox cavity – Version 1

Reprinted from Meinke, H. and Gundlach, F. W., *Taschenbuch der Hochfrequenztechnik*, S.471 Erste Auflage, Springer-Verlag, Berlin (1968) and *Techniques of Microwave Measurements* by Carol G. Montgomery, 1st ed., 1947; by permission, McGraw-Hill Book Co., N. Y.

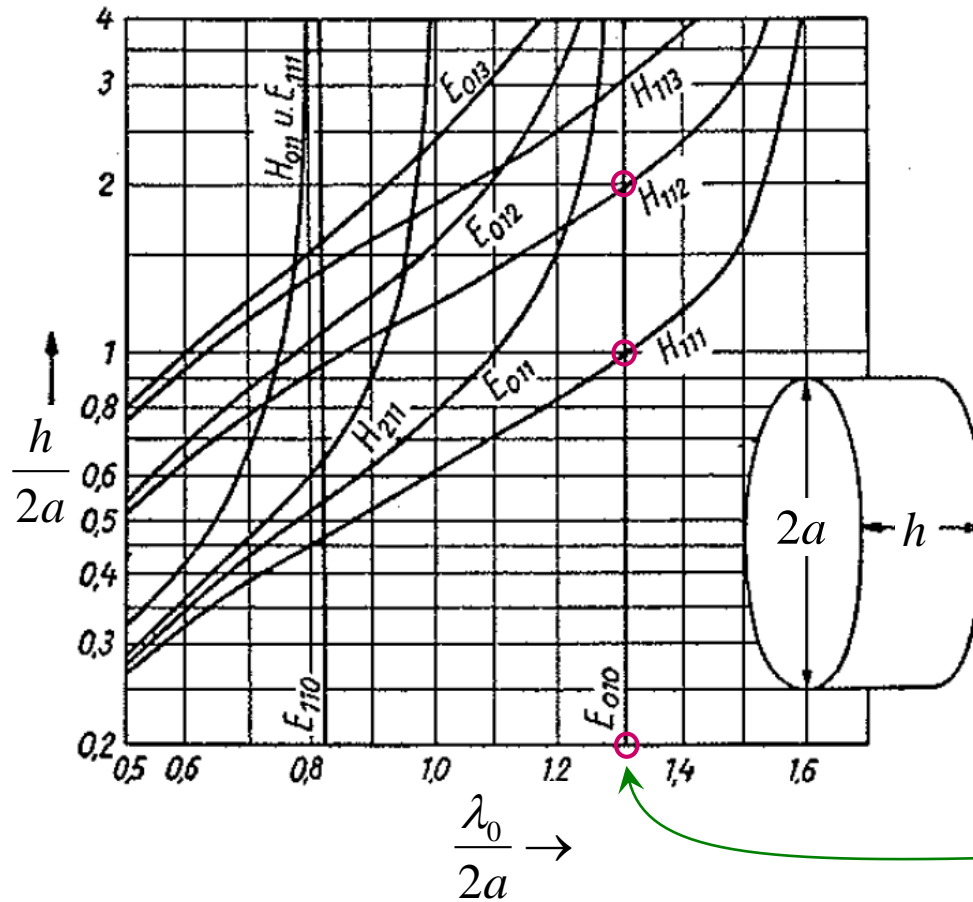

Cylindrical cavity with **radius  $a$** , **height =  $h$**  and **resonant wavelength  $\lambda_0$** .  
H stands for TE and E for TM modes.

*Example:*

$E_{010}$ :  $\lambda_0 \approx 2.6a$

$H_{111}$ :  $h \approx 2a$

$H_{112}$ :  $h \approx 4a$

# Mode chart of a Pillbox cavity – Version 2

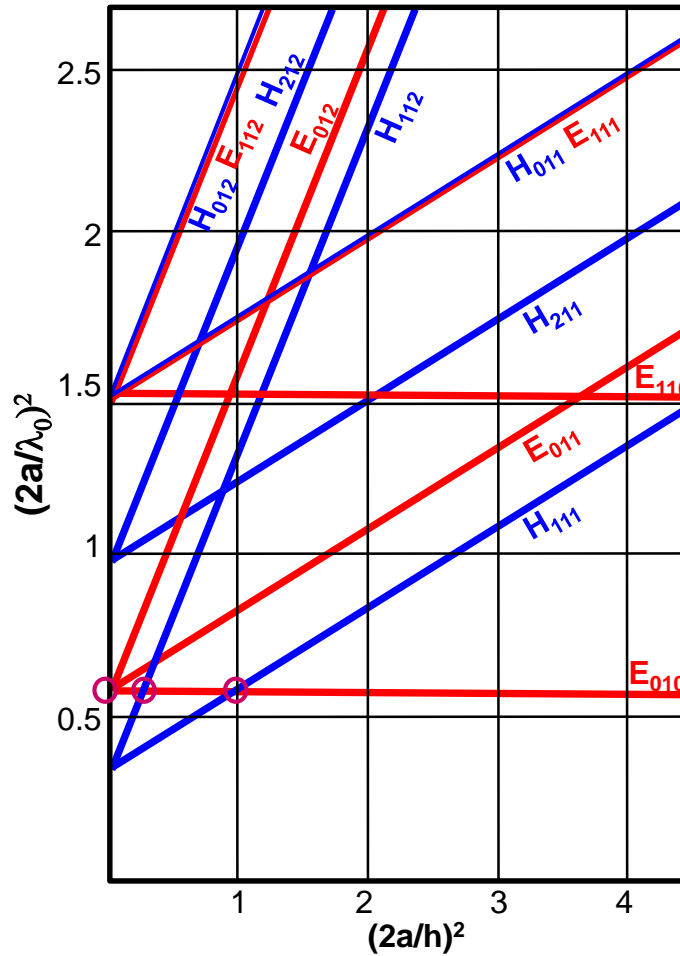

Cylindrical cavity with **radius a**,  
**height = h** and **resonant wavelength  $\lambda_0$** .  
H stands for TE and E for TM modes.

*Example:*

←  $E_{010}$ :  $(2a/\lambda_0)^2 \approx 0.6 \rightarrow \lambda_0 \approx 2.6a$   
 $H_{111}$ :  $h \approx 2a$   
 $H_{112}$ :  $h \approx 4a$

Reprinted from Meinke, H. and Gundlach, F. W.,  
*Taschenbuch der Hochfrequenztechnik*, S.471  
 Erste Auflage, Springer-Verlag, Berlin (1968) and  
*Techniques of Microwave Measurements* by Carol G. Montgomery,  
 1st ed., 1947; by permission, McGraw-Hill Book Co., N. Y.



# Mode chart of a Pillbox cavity – Version 3

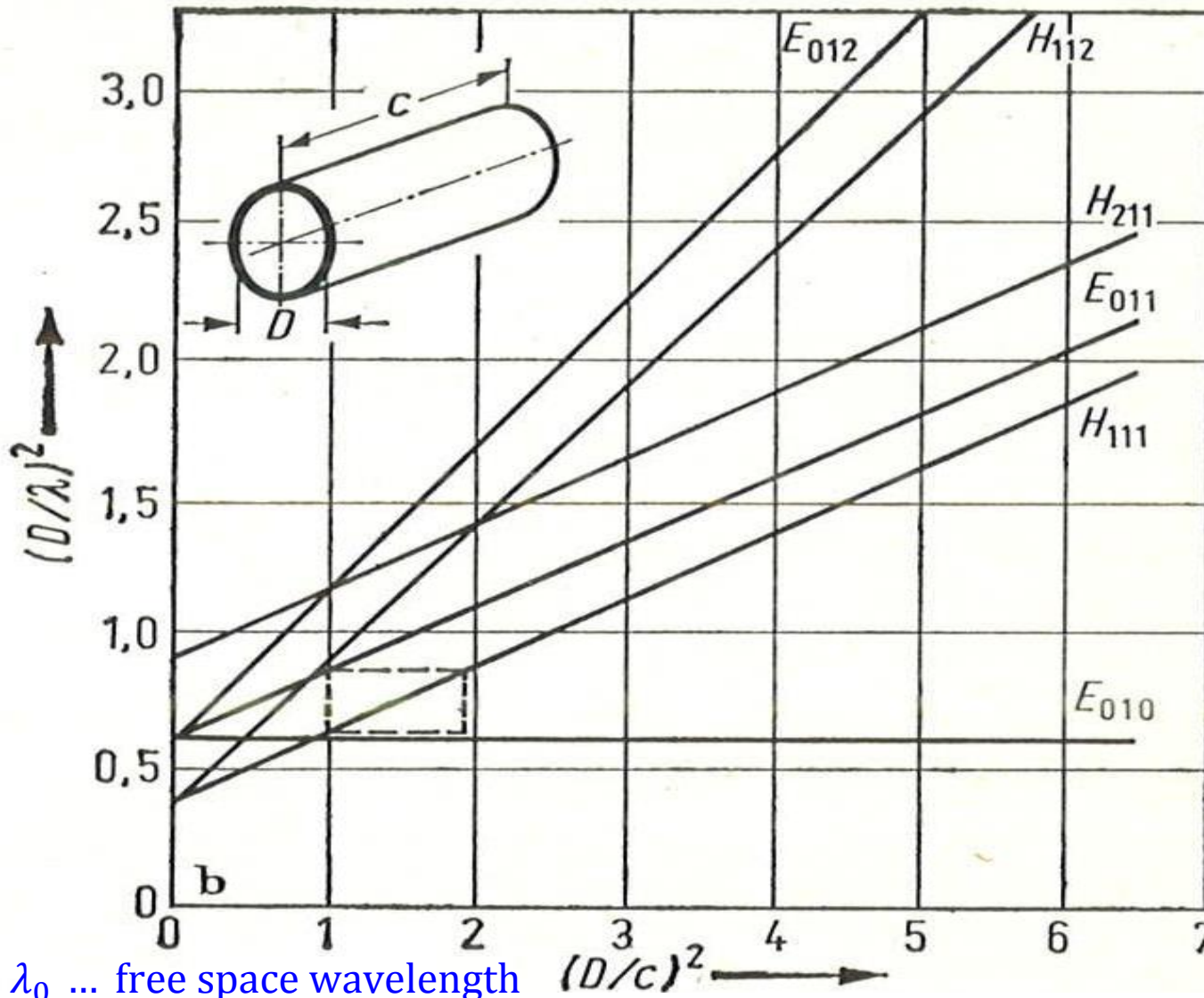

Caution! Here,  $c$  refers to the length of the cavity **NOT** the speed of light!

Reprinted from Zinke, o. and Brunswig, H., Lehrbuch der Hochfrequenztechnik, erster Band

$\lambda = \lambda_0 \dots$  free space wavelength

# Higher order Mode chart of a Coaxial line

Reprinted from Meinke, H. and Gundlach, F. W.,  
*Taschenbuch der Hochfrequenztechnik*, S.471  
 Vierte Auflage, Springer-Verlag, Berlin (1986)

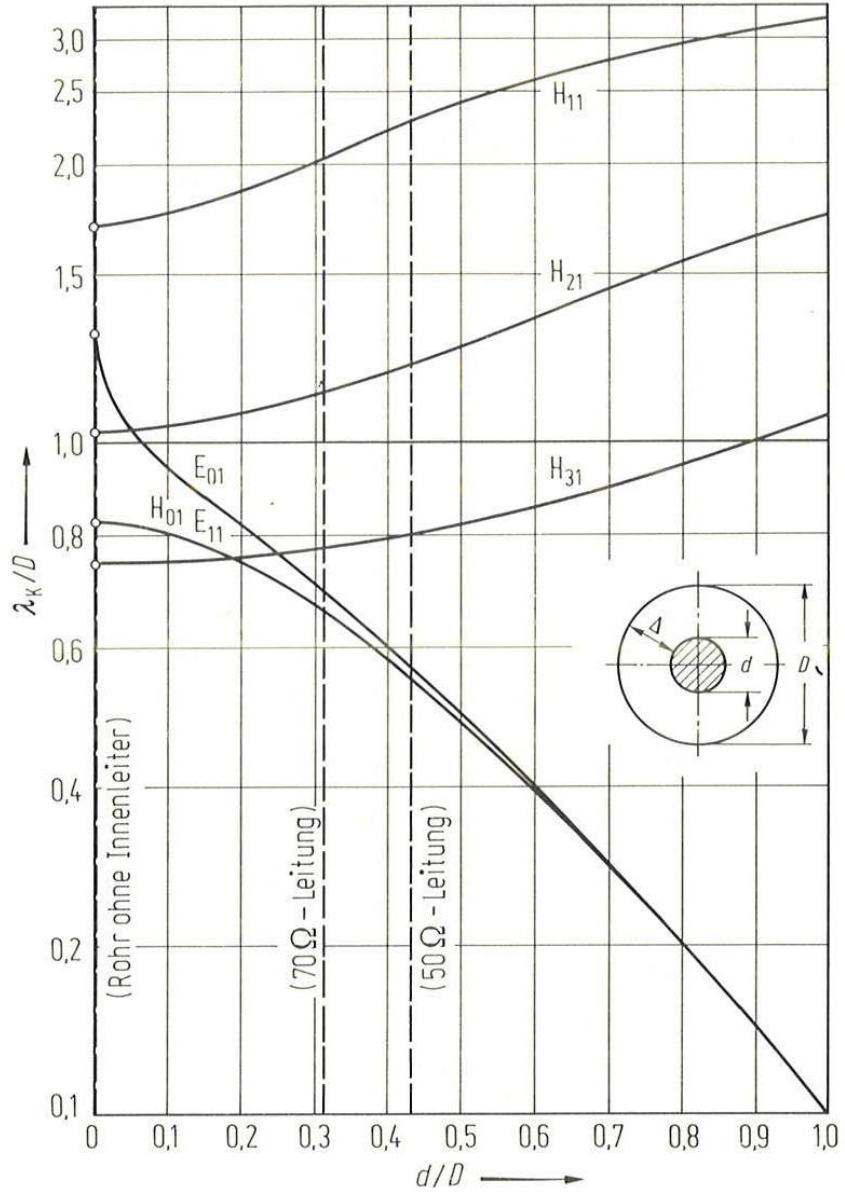

$\lambda_K$  ... cutoff frequency

German textbook...

# Skin-effect and scaling laws for copper

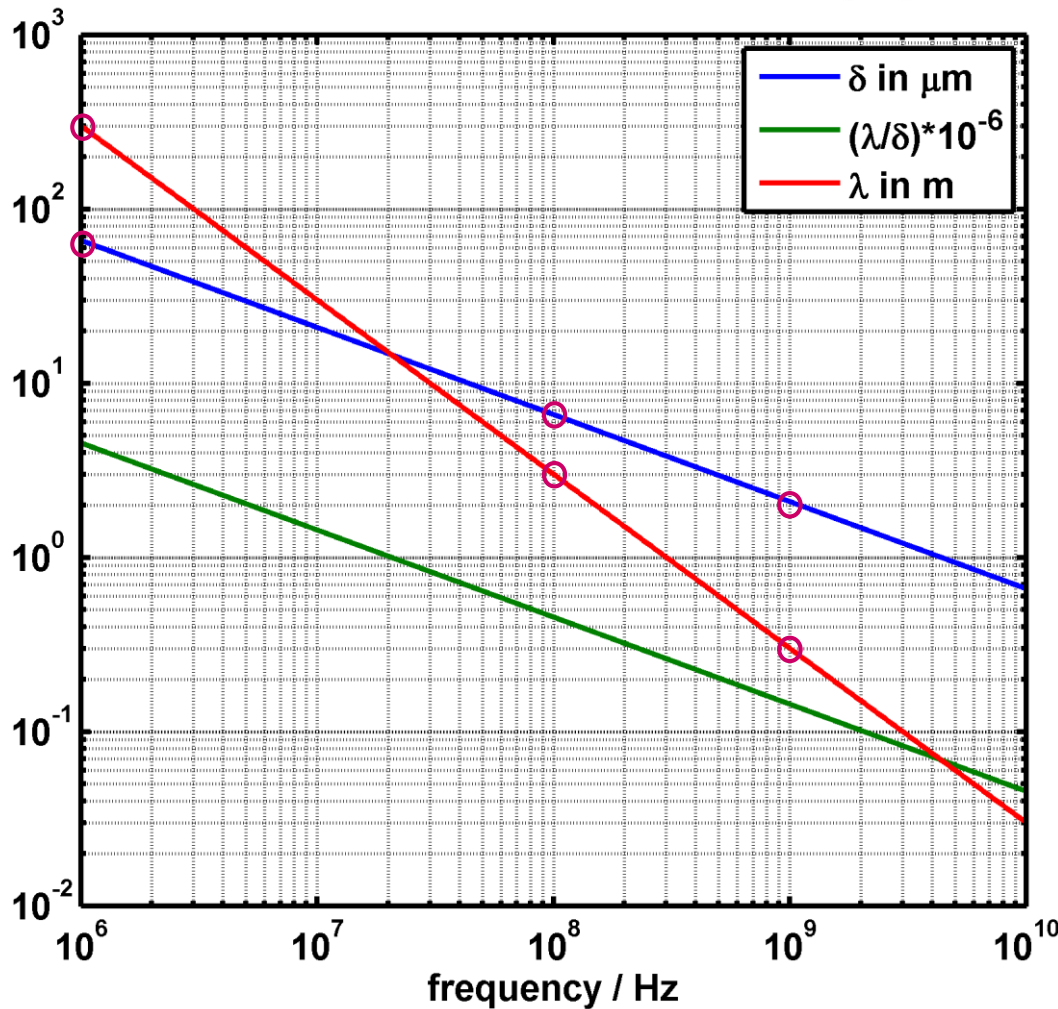

Skin-effect graph, plot for copper at room temperature and no DC magnetic field

$$\delta = \sqrt{\frac{1}{\pi f \mu \sigma}}$$

$$\lambda = \frac{c}{f}$$

Examples:

f	$\lambda$	$\delta$ (copper)
1 GHz	0.3 m	2 $\mu\text{m}$
100 MHz	3 m	6.6 $\mu\text{m}$
1 MHz	300 m	66 $\mu\text{m}$
50 Hz	6 000 km	9.3 mm

$$\mu_0 = 4\pi \cdot 10^{-7} \text{ Vs/Am}$$

$$\epsilon_0 = 8.854187 \cdot 10^{-12} \text{ As/Vm}$$

$$c \approx 3 \cdot 10^8 \text{ m/s}$$

Plotted are the wavelength  $\lambda$  in [m], the skin depth  $\delta$  in [ $\mu\text{m}$ ] and the ratio  $(\lambda\delta) \cdot 10^6$  for copper.  
Conductivity of copper:  $\sigma = 58 \cdot 10^6 \text{ S/m}$

Reprinted from Meinke, H. and Gundlach, F. W.,  
*Taschenbuch der Hochfrequenztechnik*,  
Dritte Auflage, Springer-Verlag, Berlin (1968) and  
*Techniques of Microwave Measurements* by Carol G. Montgomery,  
1st ed., 1947; by permission, McGraw-Hill Book Co., N. Y.

# Decibel (1)

- ◆ The Decibel is the unit used to express relative differences in signal power. It is expressed as the base 10 logarithm of the ratio of the powers of two signals:

$$P \text{ [dB]} = 10 \cdot \log(P/P_{\text{ref}})$$

- ◆ Signal amplitudes can also be expressed in dB. Since power is proportional to the square of a signal's amplitude, the voltage in dB is expressed as follows:

$$V \text{ [dB]} = 20 \cdot \log(V/V_{\text{ref}})$$

- ◆  $P_{\text{ref}}$  and  $V_{\text{ref}}$  are the reference power and voltage, respectively.
- ◆ A given value in dB is the same for power ratios as for voltage ratios
- ◆ There are no “power dB” or “voltage dB” as dB values always express a ratio!!!

# Decibel (2)

- ◆ The following table helps to indicate the order of magnitude associated with dB:
- ◆ Power ratio = voltage ratio squared!
- ◆ S parameters are defined as ratios and sometimes expressed in dB, no explicit reference needed!

	power ratio	V, I, E or H ratio, $S_{ij}$
-20 dB	0.01	0.1
<b>-10 dB</b>	<b>0.1</b>	<b>0.32</b>
-3 dB	0.50	0.71
-1 dB	0.74	0.89
<b>0 dB</b>	<b>1</b>	<b>1</b>
1 dB	1.26	1.12
3 dB	2.00	1.41
<b>10 dB</b>	<b>10</b>	<b>3.16</b>
20 dB	100	10
$n * 10$ dB	$10^n$	$10^{n/2}$

# Decibel (3)

- ◆ Conversely, the absolute power and voltage can be obtained from “referenced” dB values (dBm, dBW, etc.), e.g.:

$$P = P_{ref} \cdot 10^{\frac{P[\text{dBW}]}{10}}, \text{ with } P_{ref} = 1W$$

$$V = V_{ref} \cdot 10^{\frac{V[\text{dBm}]}{20}}, \text{ with } P_{ref} = 1mW$$

$$\text{for } Z_0 = 50\Omega: V_{ref} = \sqrt{0.05} V$$

- ◆ Logarithms are useful as the unit of measurement because (1) signal power tends to span several orders of magnitude and (2) signal attenuation losses and gains can be expressed in terms of subtraction and addition.

Reference: dB or not dB (Rohde&Schwarz, 2006)

(Application Note: 1MA98\_6e\_dB\_or\_not\_dB)

# Decibel (4)

- ◆ Frequently dB values are expressed using a special reference level and not SI units. Strictly speaking, the reference value should be included in parenthesis when giving a dB value, e.g. +3 dB (1W) indicates 3 dB at  $P_{\text{ref}} = 1 \text{ Watt}$ , thus 2 W.
- ◆ For instance, dBm defines dB using a reference level of  $P_{\text{ref}} = 1 \text{ mW}$ , which is equivalent to  $V_{\text{ref}} = 223.6 \text{ mV}$ , assuming a reference impedance of  $50\Omega$ .
- ◆ Thus, 0 dBm correspond to -30 dBW, where dBW indicates a reference level of  $P_{\text{ref}}=1\text{W}$ .
- ◆ Other common units:
  - dBmV for the small voltages,  $V_{\text{ref}} = 1 \text{ mV}$
  - dB $\mu$ V/m for the electric field strength radiated from an antenna,  $E_{\text{ref}} = 1 \mu\text{V/m}$

# Decibel (5)

- ◆ If the basic values from Decibel (3) are known, then one can easily calculate intermediate values:
- ◆  $14\text{dB} = 20\text{dB} - 6\text{dB}$       -> power ratio:  $100/4 = 25$
- ◆  $17\text{dB} = 20\text{dB} - 3\text{dB}$       -> power ratio:  $100/2 = 50$
- ◆  $33\text{dB} = 20\text{dB} + 10\text{dB} + 3\text{dB}$       -> power ratio:  $100 \cdot 10 \cdot 2 = 2000$



# Basic equivalent circuits

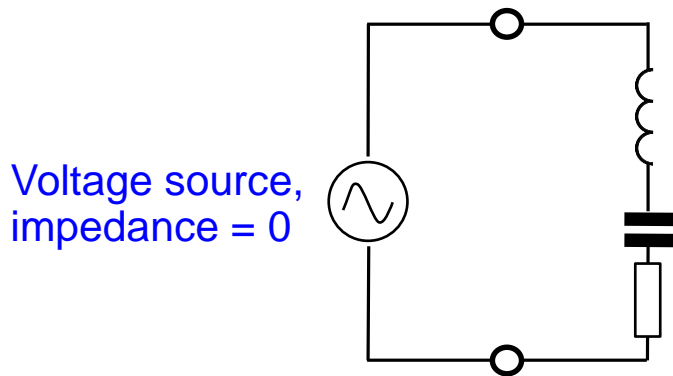

(a)

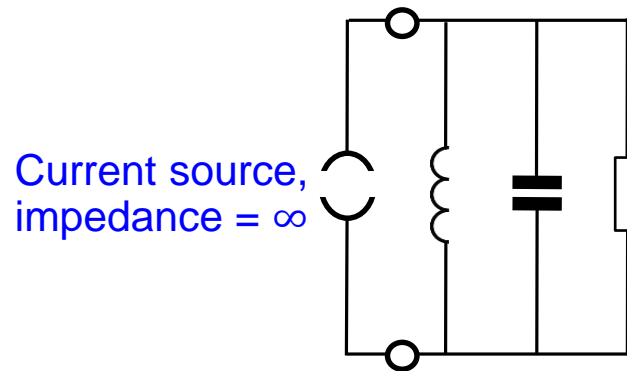

(b)

- ◆ Often an equivalent circuit with elements in series is used (a)
- ◆ However for our purpose a circuit with parallel elements (b) is preferable since an efficient acceleration of a beam requires the maximum possible voltage and such a circuit has maximum impedance at resonance
- ◆ Hence the cavity is a transformer with maximum impedance seen by the beam

# Equivalent circuit (1)

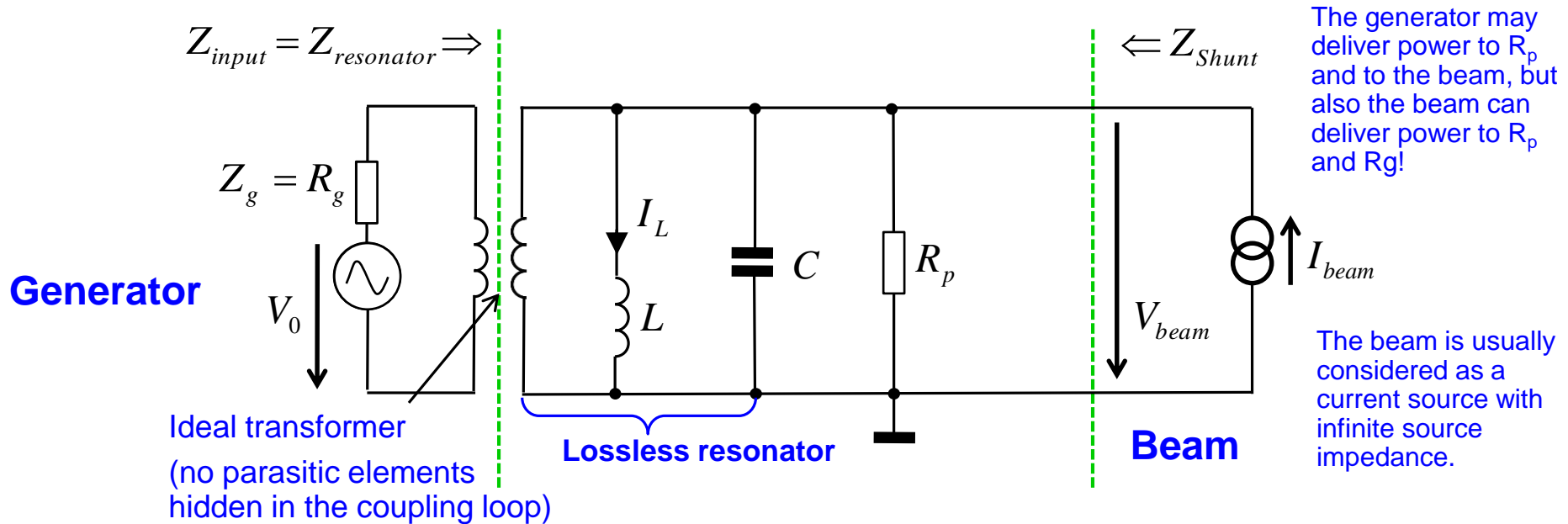

$R_p$  = resistor representing the losses of the parallel RLC equivalent circuit (resonator losses)

We have Resonance condition, when  $\omega L = \frac{1}{\omega C}$

→ Resonance frequency:  $\omega_{res} = 2\pi f_{res} = \frac{1}{\sqrt{LC}} \Rightarrow f_{res} = \frac{1}{2\pi} \frac{1}{\sqrt{LC}}$

# Equivalent circuit (2)

- ◆ Characteristic impedance “R upon Q”

*(R/Q) is independent of Q and a pure geometry factor for any cavity or resonator! This lumped element formula here assumes a HOMOGENEOUS field in the capacitor !*

$$X = \frac{R}{Q} = \omega_{res} L = \frac{1}{\omega_{res} C} = \sqrt{L/C}$$

- ◆ Stored energy at resonance

$$W = \frac{C V_C^2}{2} = \frac{L I_L^2}{2}$$

$V_C$  ... Voltage at capacitor  
 $I_L$  ... Current in the coil

- ◆ Dissipated power

$$P = \frac{V^2}{2R}$$

- ◆ Q-factor

$$Q = \frac{R}{X} = \frac{\omega_{res} W}{P}$$

←..... W ... stored energy  
←..... P ... dissipated power over period

- ◆ Shunt impedance (circuit definition)

$$R = \frac{V^2}{2P}$$

- ◆ Tuning sensitivity

$$\frac{\Delta f}{f} = -\frac{1}{2} \frac{\Delta C}{C} = -\frac{1}{2} \frac{\Delta L}{L}$$

- ◆ Coupling parameter (shunt impedance over generator or feeder impedance Z)

$$k^2 = \frac{R}{R_{input}}$$

# The Quality Factor (1)

- ◆ The quality (Q) factor of a resonant circuit is defined as the ratio of the stored energy  $W$  over the energy dissipated  $P$  in one oscillation cycle.

$$Q = \frac{\omega_{res} W}{P}$$

- ◆ The Q factor can be given as
  - $Q_0$ : Unloaded Q factor of the unperturbed system, e.g. an isolated cavity without external loading
  - $Q_L$ : Loaded Q factor with measurement or power supply circuits connected
  - $Q_{ext}$ : External Q factor of the measurement circuits without cavity
- ◆ These Q factors are related by

$$\frac{1}{Q_L} = \frac{1}{Q_0} + \frac{1}{Q_{ext}}$$

# The Quality Factor (2)

- ◆ Q as defined in a Circuit Theory Textbook:

$$Q = \frac{R}{\omega_{res} L}$$

- ◆ Q as defined in a Field Theory Textbook:

$$Q = 2\pi \frac{\text{energy stored in the resonator}}{\text{energy dissipated per period}}$$

- ◆ Q as defined in an optoelectronics Textbook:

$$Q = \frac{\nu_0}{\nu_{1/2}}$$

$\nu_0$  = the resonant frequency

$\nu_{1/2}$  = "full - width at half (power) maximum" (FWHM = 3dB point)

# Input Impedance: Z-plane

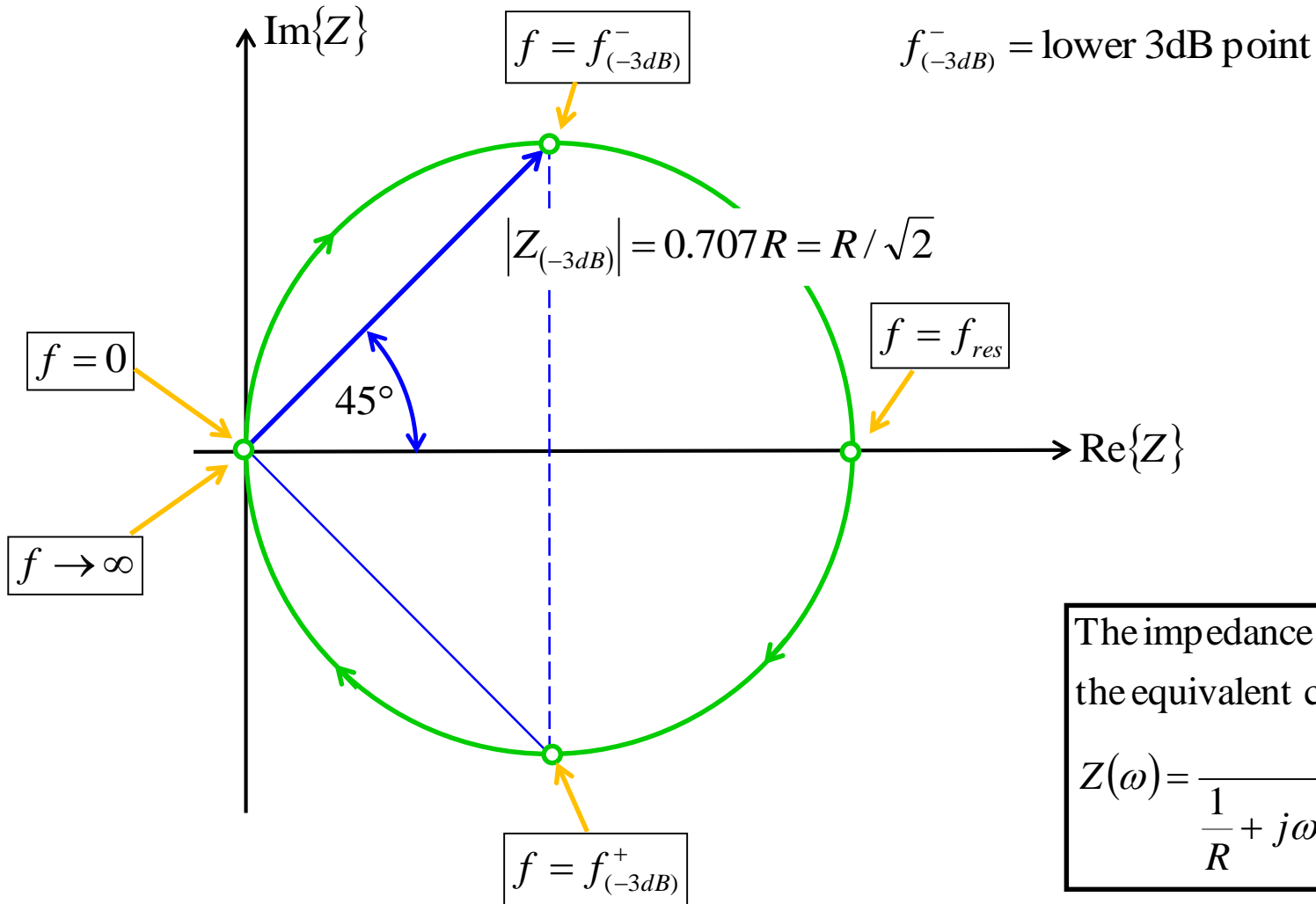

$f_{(-3dB)}^+ = \text{upper 3dB point}$

# Input Admittance: Y-plane

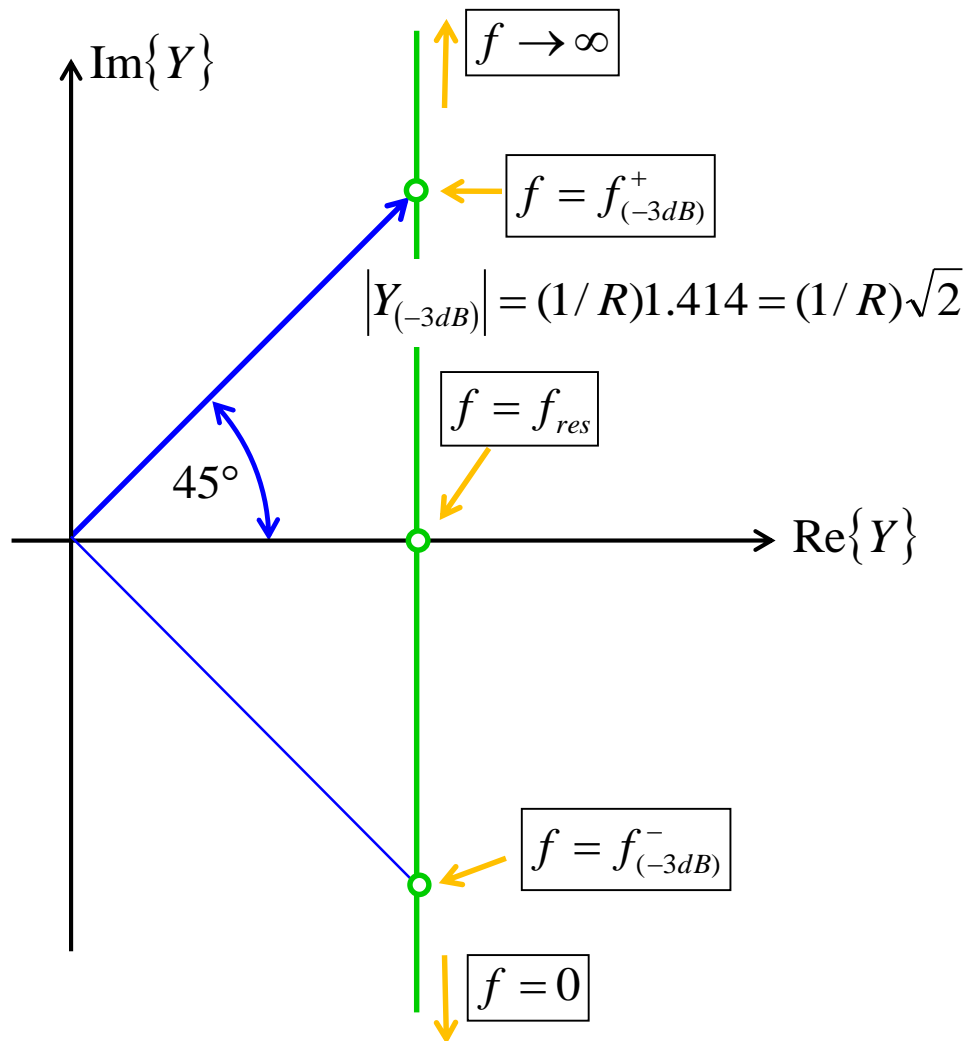

Evaluating the admittance  $Y$  for the equivalent circuit we get

$$\begin{aligned}
 Y &= \frac{1}{Z} = \frac{1}{R} + j\omega C + \frac{1}{j\omega L} \\
 &= \frac{1}{R} + j\left(\omega C - \frac{1}{\omega L}\right) \\
 &= \frac{1}{R} + j\frac{1}{R/Q} \left(\frac{f}{f_{res}} - \frac{f_{res}}{f}\right)
 \end{aligned}$$

# 3 dB bandwidth

In the Z-plane (= impedance)  $|Z|$  reduces to 0.707 to the value at resonance.

The real part of Z becomes 50% of the real part of that at resonance.

The phase deviates +/- 45 degrees from the phase at resonance.

0.707 in voltage = unit voltage – 3dB (decibel)

0.707 in voltage = 50% in power since power  $\sim V^2$

The Q factor of a resonance peak or dip can be calculated from the center frequency  $f_{res}$  and the 3 dB bandwidth  $\Delta f = f_{(-3dB)}^+ - f_{(-3dB)}^-$  as  $Q = f_{res} / \Delta f$ .



# Transients on an RC-Element (1)

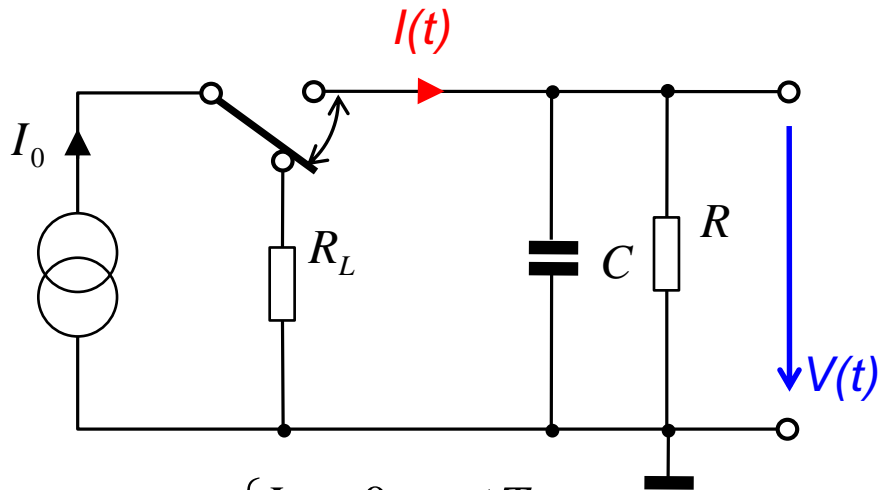

$$I(t) = \begin{cases} I_0 & 0 < t \leq T \\ 0 & \text{otherwise} \end{cases}$$

A voltage source would not work here! Explain why.

$\tau = RC$  ... time constant

$V_0 = I_0 R$  ... maximum voltage

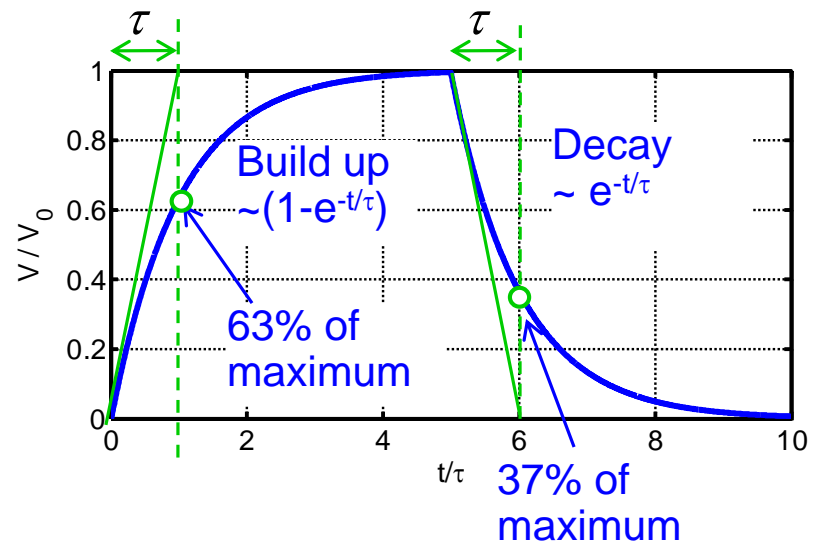
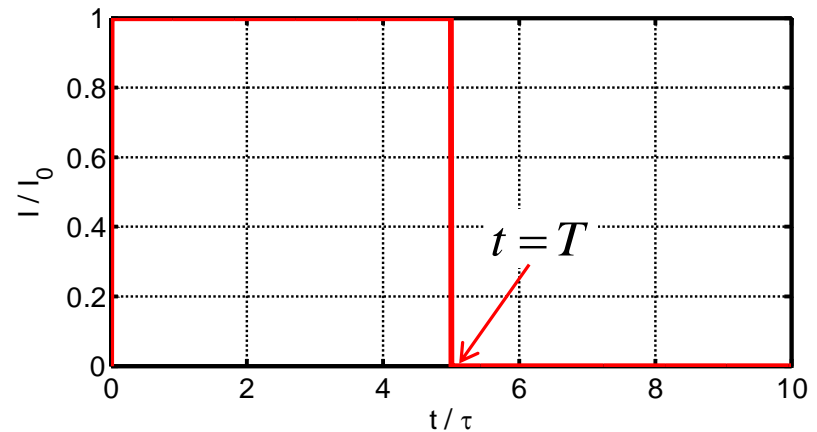

# Transients on an RC-Element (2)

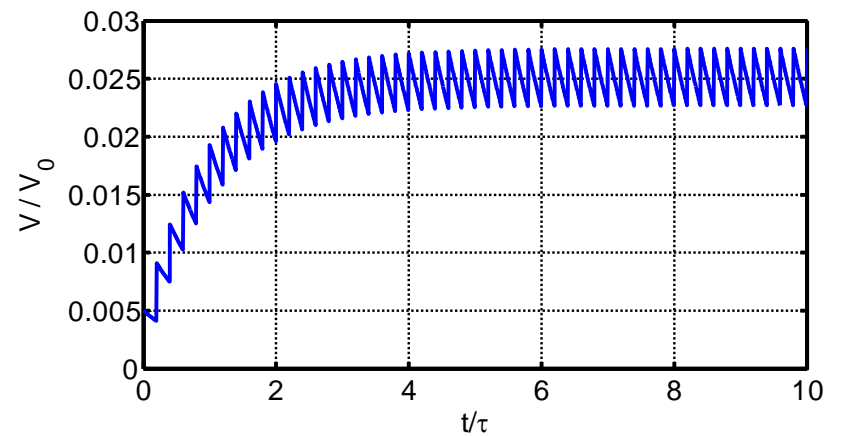
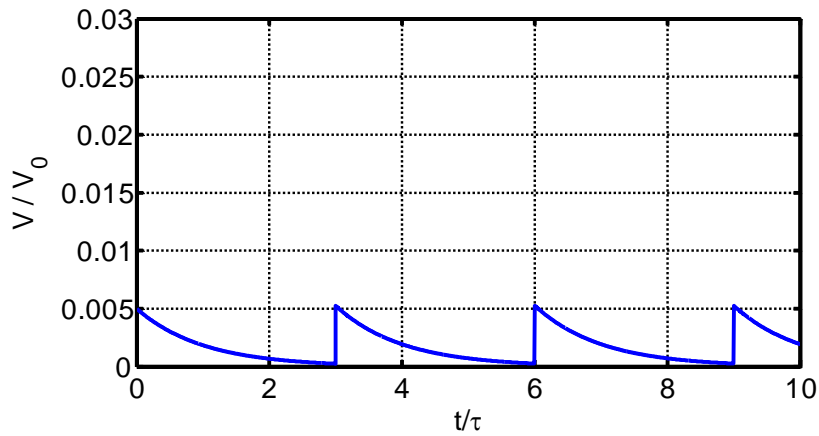
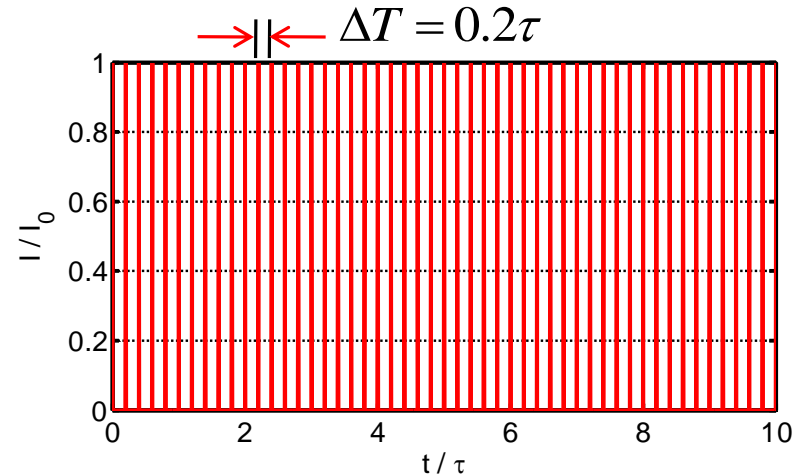
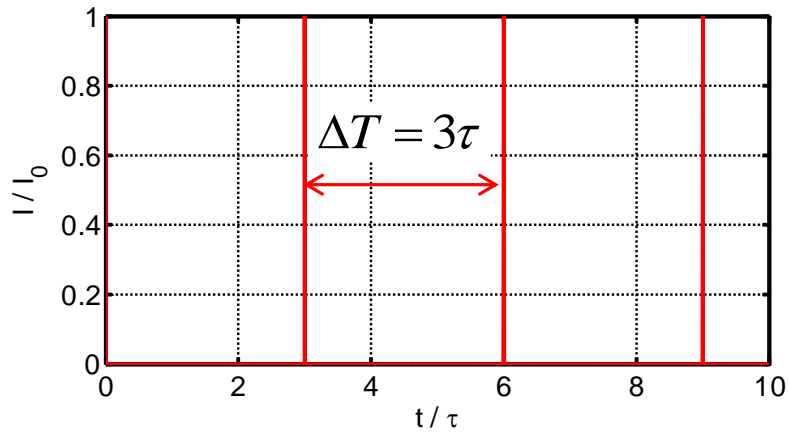

# Response of a tuned cavity to sinusoidal drive current (1)

Drive current  $I$

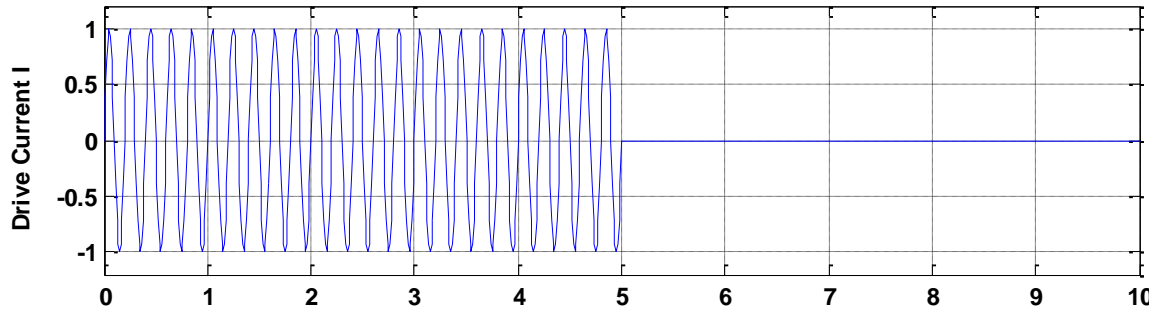

In the first moment, the cavity acts like a capacitor, as seen from the generator (compare equivalent circuit). The RF is therefore short-circuited

Cavity response  $U$

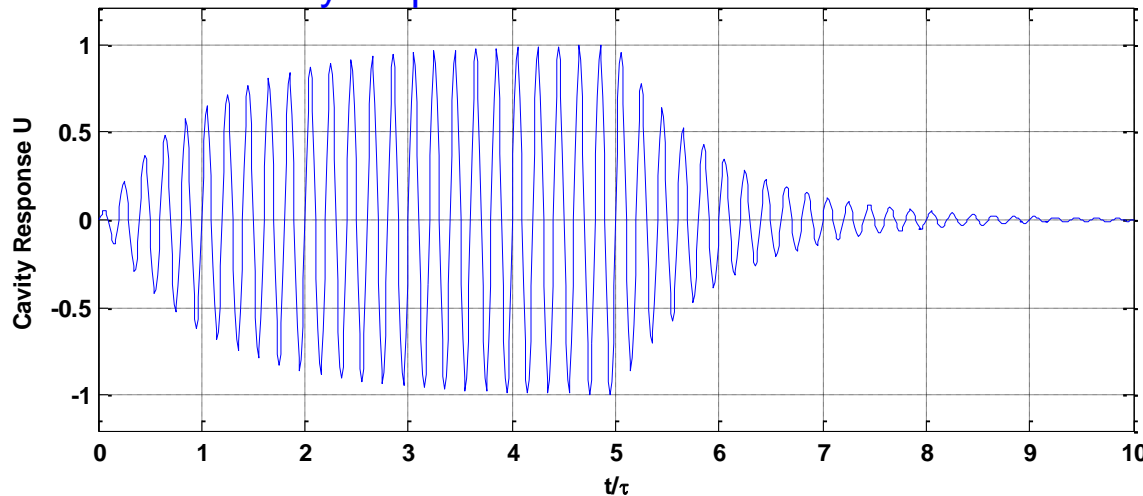

In the stationary regime, the inductive ( $\omega L$ ) and capacitive reactances ( $1/(\omega C)$ ) cancel (operation at resonance frequency!). All the power goes into the shunt impedance  $R \Rightarrow$  no more power reflected, at least for a matched generator...

# Measured time domain response of a cavity

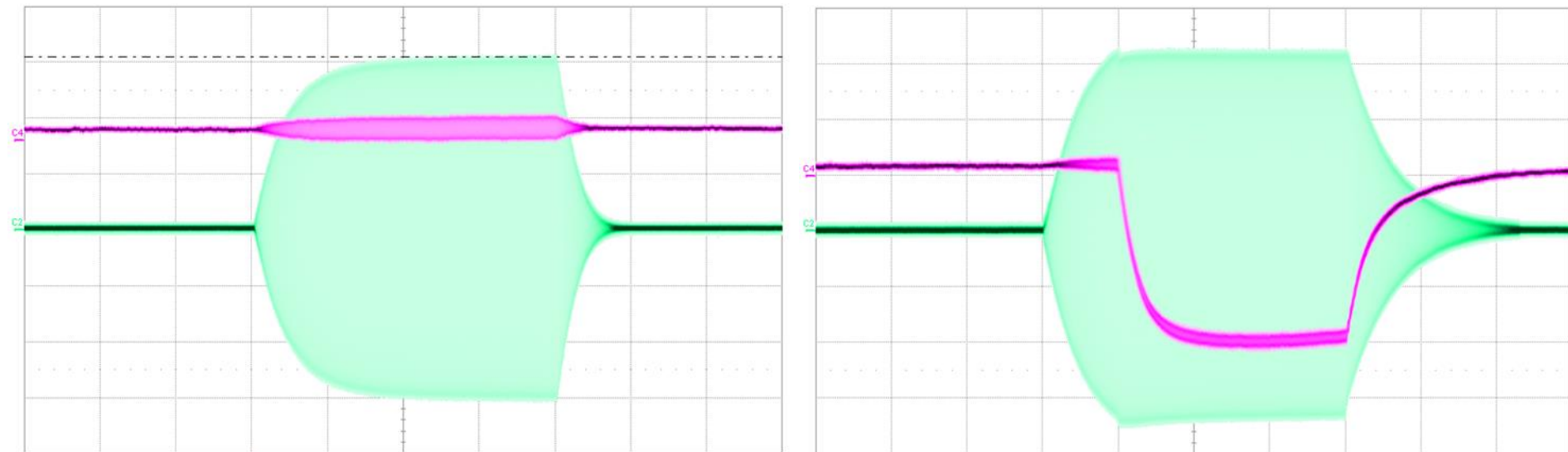

◆ Cavity E field (green trace) and electron probe signal (red trace) with and without multipacting. 200  $\mu$ s RF burst duration.

see: O. Heid, T Hughes, COMPACT SOLID STATE DIRECT DRIVE RF LINAC EXPERIMENTAL PROGRAM, IPAC Kyoto, 2010

# Numerically calculated response of a cavity in the time domain

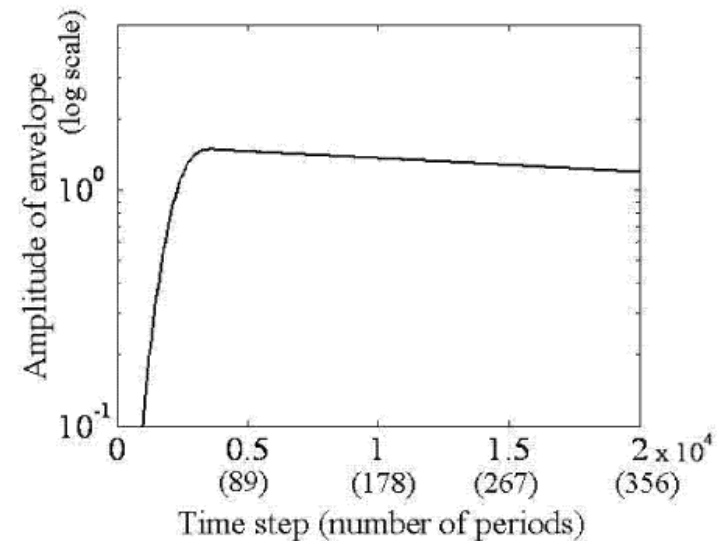
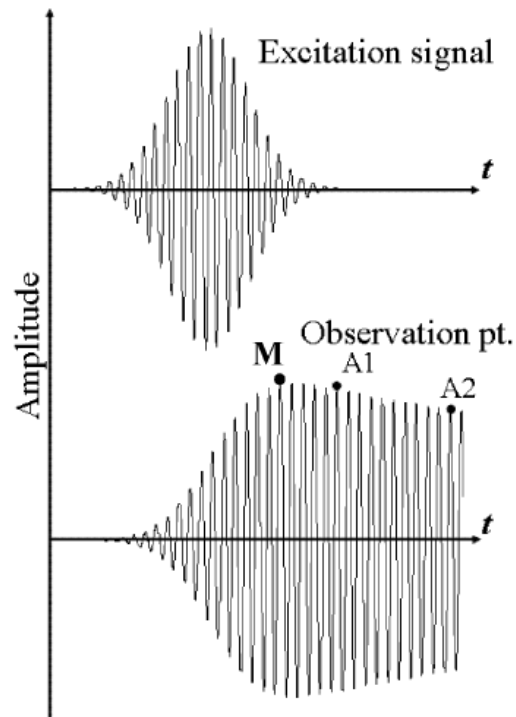

$$E = E_o \sin \omega_c t \cdot e^{-\left(\frac{t-T}{T}\right)^2}$$

$$Q = \frac{\omega_r (t_2 - t_1)}{2 \ln \left( \frac{A_1}{A_2} \right)},$$

see: I. Awai, Y. Zhang, T. Ishida, Unified calculation of microwave resonator parameters, IEEE 2007

# Response of a tuned cavity to sinusoidal drive current (2)

Differential equation of the envelope

(shown without derivation):

$$\dot{V} = \frac{1}{2C} = \left(I - \frac{V}{Z}\right) = \frac{1}{2ZC} (IZ - V)$$

$\dot{V}, V, I, Z$  are complex quantities, evaluated at the stimulus (drive) frequency.

For a tuned cavity all quantities become real. In particular  $Z = R$ , therefore

$$\dot{V} = \frac{1}{2RC} (IR - V)$$

→ time constant becomes

$$\underline{\tau} = 2RC = 2 \frac{R}{Q} Q C = \frac{2Q}{\omega_0} = \frac{Q}{\pi f} = \frac{QT}{\pi}$$

$T = 1/f$

"Q over  $\pi$  periods"

$V$ ... envelope amplitude  
 $C$ ... cavity capacitance  
 $I$ ... drive current  
 $Z$ ... cavity impedance  
 $R$ ... real part of cavity impedance

This  $\tau$  value refers to the 1/e decay of the field in the cavity or the voltage at a lumped element. Sometimes (rarely) one finds  $\tau_w$  referring to the energy with  $2\tau_w = \tau$ .

The **voltage (or current)** decreases to 1/e of the initial value within the time  $\tau$ .

see also: H. Klein, Basic concepts I  
 Proceeding Oxford CAS, April 91  
 CERN Yellow Report 92-03, Vol. I

# Beam-cavity interaction (1)

Cavity response in time domain  $c(t)$  from one very short bunch

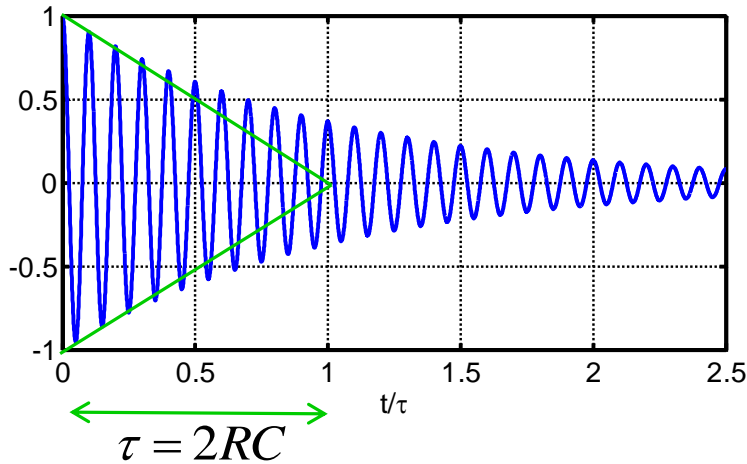

Bunched beam  $b(t)$  with bunch length  $t_b$ , bunch spacing  $T$  and beam current  $I_0$

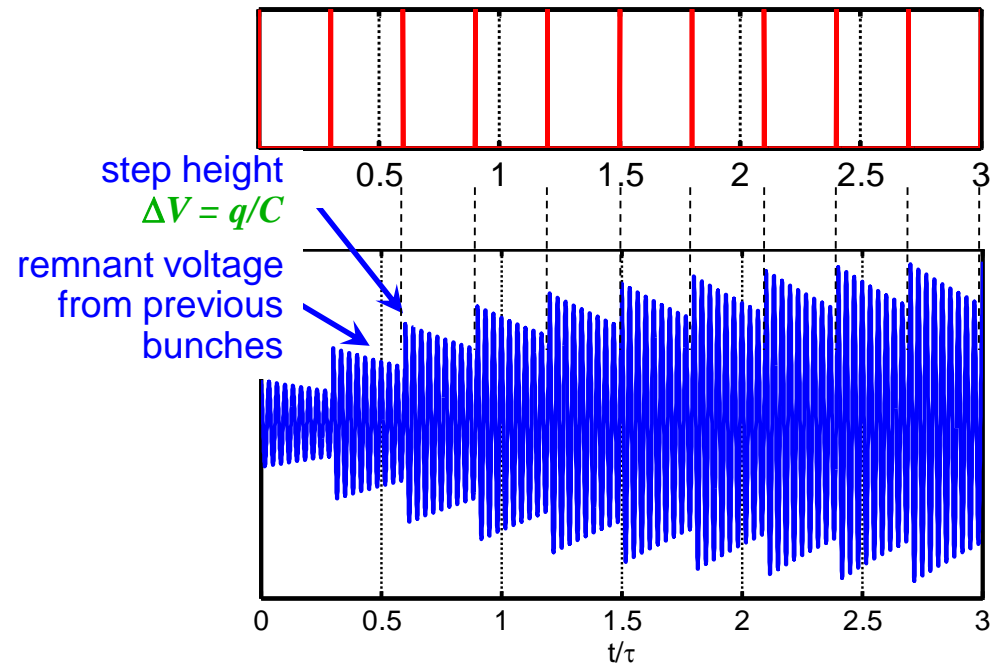

Resulting response for bunched beam obtained by convolution of the bunch sequence with the cavity response  $r(t) = b(t) \otimes c(t)$   
 Condition that the induced signals in the cavity add up:  
 cavity resonant frequency  $f_{res}$  must be an integer multiple of bunch frequency  $1/T$

# Beam-cavity interaction (2)

For a quantitative evaluation the worst case is considered with the induced signals adding up in phase.

Two approaches:

- ◆ Equilibrium condition: Voltage drop between two bunch passages compensated by newly induced voltage

$$V_{end} e^{-T/\tau} = V_{step} = V_{end} - \frac{q}{C} \Rightarrow V_{end} = \frac{q}{C} \frac{1}{1 - e^{-T/\tau}}$$

- ◆ Summing up individual stimuli

$$V_{end} = \frac{q}{C} (1 + e^{-T/\tau} + e^{-2T/\tau} + \dots) = \frac{q}{C} \frac{1}{1 - e^{-T/\tau}}$$

Approximation for  $T/\tau \ll 1$ :

$$1 - e^{-T/\tau} = 1 - (1 - T/\tau + \dots) \approx T/\tau$$

$$\frac{V_{end}}{C} = \frac{q}{C} \frac{1}{T/\tau} = \frac{q}{C} \frac{2RC}{T} = 2R \frac{q}{T} = \frac{2RI_0}{T}$$

where  $I_0$  is the mean beam current.

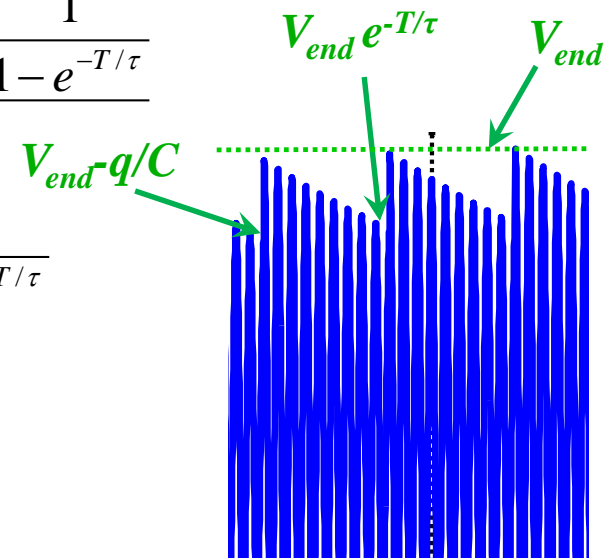



# Beam-cavity interaction in Frequency domain

## ◆ Frequency domain

beam spectrum  $B(f)$

$$B(f) = 2I_0 \frac{\sin(\pi t_b f)}{\pi t_b f}$$

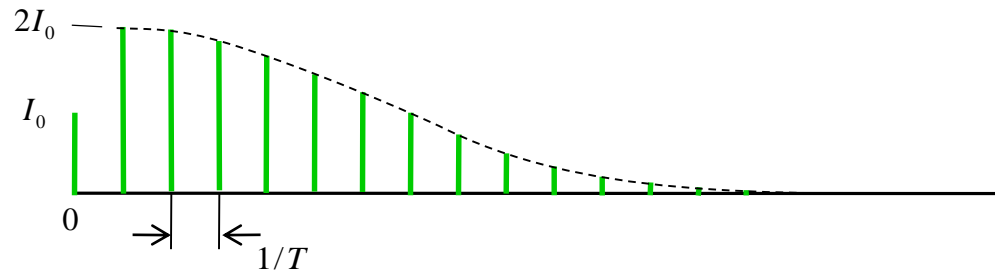

cavity response  $C(f)$



Resulting spectrum  
obtained by multiplication  
 $R(f) = B(f) * C(f)$

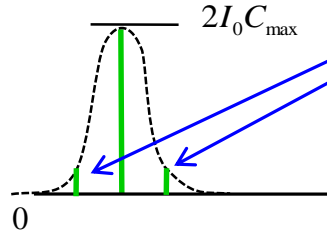

We see strong central line with two sidebands. This is AM modulation. Where do you find this AM modulation in the time domain?

# Typical parameters for different cavity technologies

Cavity type	$R/Q$	$Q$	$R$
Ferrite loaded cavity (low frequency, rapid cycling)	4 k $\Omega$	50	200 k $\Omega$
Room temperature copper cavity (type 1 with nose cone)	192 $\Omega$	$30 * 10^3$	5.75 M $\Omega$
Superconducting cavity (type 2 with large iris)	50 $\Omega$	$1 * 10^{10}$	500 G $\Omega$

# Different definitions of the shunt impedance

Four relevant parameters:

- ◆ Shunt impedance, e.g.:  $r = 3.3 \text{ M}\Omega$

Linac definition:

$$P = \frac{\hat{V}^2}{R} \text{ with } \hat{V} \text{ being the peak voltage}$$

Electrical (or circuit) definition:

for circular machines the effective voltage  $V_{eff}$  is used => factor 2

$$P = \frac{\hat{V}^2}{2r} \Rightarrow 2r = R$$

- ◆ Length of the cavity gap, e.g.:  $L = 0.2 \text{ m}$
  - ◆ Phase between particle (bunch) and RF signal, e.g.:  $\cos(\varphi) = 0.866$
  - ◆ Transit-time factor, e.g.:  $T = 0.756$
- ( $T$  and  $\varphi^1$  defined later in more detail, see transit time factor slides!)

=> confusion can be maximized by using  $2^4 = 16$  different definitions...  
Linac and electrical definition most often used.

-> Typically used shunt impedance definitions for the above cavity example:

$r = 3.3 \text{ M}\Omega$  (using the circuit definition, w/o transit-time factor)

$rT^2 = 1.89 \text{ M}\Omega$  (using the circuit definition, including the transit-time factor)

$R = 6.6 \text{ M}\Omega$  (using the linac definition, w/o transit-time factor)

$RT^2 = 3.77 \text{ M}\Omega$  (using the linac definition, including the transit-time factor)

1:  $\varphi$  refers to the phase of the particle in the centre of the cavity w.r.t. the rf signal. Typically  $\cos(\varphi) = 1$  is used.

# Electromagnetic scaling laws

A cavity of a given geometry can be scaled using three rules:

- ◆ The ratio of any cavity dimension to  $\lambda$  is constant. To put it another way, all cavity dimensions are inversely proportional to frequency
- ◆ Characteristic impedance  $R/Q = \text{const.}$
- ◆  $Q * \delta / \lambda = \text{const.}$

The skin depth  $\delta$  is given by

$$\delta = \sqrt{\frac{2}{\omega \sigma \mu}}$$

with the conductivity  $\sigma$ , the permeability  $\mu$ , and the angular frequency  $\omega = 2\pi f$ .

Note that it is proportional to  $\frac{1}{\sqrt{f\sigma}}$

For instance, in copper ( $\sigma_{\text{copper}} = 5.8 \cdot 10^7 \text{ S/m}$ ) the skin depth is  $\approx 9 \text{ mm}$  at 50 Hz, while it decreases to  $\approx 2 \text{ }\mu\text{m}$  at 1 GHz.

# Scaling of a pillbox-type cavity

Starting point: SUPERFISH simulation results for a cavity of a given geometry with copper walls. Parameters:  $f = 3030$  MHz,  $Q_0 = 9625$  and  $R = 631$  k $\Omega$

Question: What are the characteristic parameters ( $Q$ ,  $R/Q$ ,  $\lambda$ ) of a cavity of similar shape, that operates at a frequency of 814.5 MHz, built with steel walls?  
( $\sigma_{copper} = 58$  MS/m, here we assume  $\sigma_{steel} \approx 2$  MS/m)

Answer: For the first cavity we find

Skin depth  $\delta_1 = 1.195$   $\mu$ m,

Resonant wavelength  $\lambda_1 = c/f_1 = 98.97$  mm,

$Q_1 * \delta_1 / \lambda_1 = 0.1162$

For the larger steel cavity all dimensions have to be scaled by the inverse frequency ratio  $f_1/f_2$ , which gives a factor of  $3030/814.5 = 3.72$

$\Rightarrow \lambda_2 = 3.72 \lambda_1 = \underline{368}$  mm

The characteristic impedance remains unchanged.

$R_2/Q_2 = R_1/Q_1 = 632 * 10^3 / 9625 = \underline{65.56}$   $\Omega$

The skin depth for steel at 814.5 MHz is  $\sigma_2 = 12.5$   $\mu$ m.

Using  $Q_1 * \delta_1 / \lambda_1 = Q_2 * \delta_2 / \lambda_2$  we find  $Q_2 = \underline{3420}$

Finally, the shunt impedance gets

$R_2 = (R_1/Q_1) * Q_2 = 65.56 * 3420 = \underline{224}$  k $\Omega$

# Simulation Tools

- ◆ Poisson Superfish (poisson equation; poisson = fish in French)
- ◆ CST Studio Suite, Mafia (Maxwell's finite integration algorithm), <http://www.cst.com>
- ◆ Ansoft HFSS (High frequency structure simulator), <http://www.ansoft.com>
- ◆ GdfidL (“Gitter drauf fertig ist die Laube” – no joke, really true!)

# Simulation Techniques (1)

## ◆ Frequency domain analysis

- CST Microwave Studio, Ansoft HFSS
- Uses a tetrahedral mesh
- Maxwell's equations solved in frequency domain for *one frequency point at a time*
- Frequency sweeps may take very long time, very powerful PC or computer cluster needed!
- Applications: quite universal

## ◆ Time domain analysis

- CST Microwave Studio
- Space is discretized by a rectangular mesh
- Excitation of structure with time domain pulse
- Transformation to frequency domain by Fourier Transform => entire frequency range with only one run => *fast!!!*
- Bad convergence for resonant structures, since pulse does not decay fast
- Applications: Waveguide transitions, connectors, antennas, but *no resonant structures* such as cavities!!!

# Simulation Techniques (2)

- ◆ Eigenmode analysis
  - Microwave Studio, Mafra, HFSS, Superfish ...
  - Allows to calculate eigenmodes of resonant structures
  - Used for instance to determine resonant frequencies of cavities, including higher order modes

## The Mesh

- ◆ Space discretized by a mesh
- ◆ Mesh width in the order of a tenth of the wavelength in the material
- ◆ Successive mesh refinement to improve precision
- ◆ Expert systems or user determine critical regions where mesh needs to be denser
- ◆ Magic T shown below: Roughly  $10^5$  mesh cells and a few seconds to minutes simulation time on a present-day PC



# 3D Simulation examples

## ◆ A Magic T with Microwave Studio 4.3

- Arrows show the E field of the  $TE_{10}$  mode
- Power goes in at the front port
- How much power gets out by the other ports?

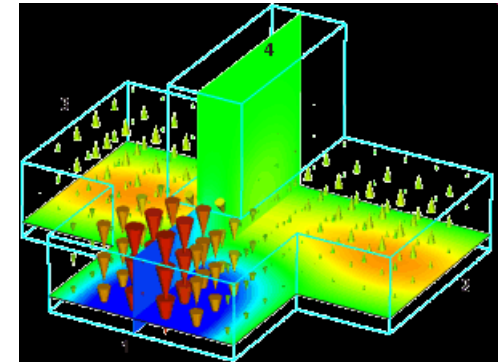
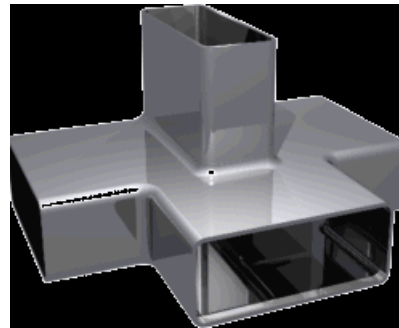

## ◆ A T-junction with HFSS 9.0

- Junction (H-plane) with conducting iris
- Magnitude of  $TE_{10}$  electric field

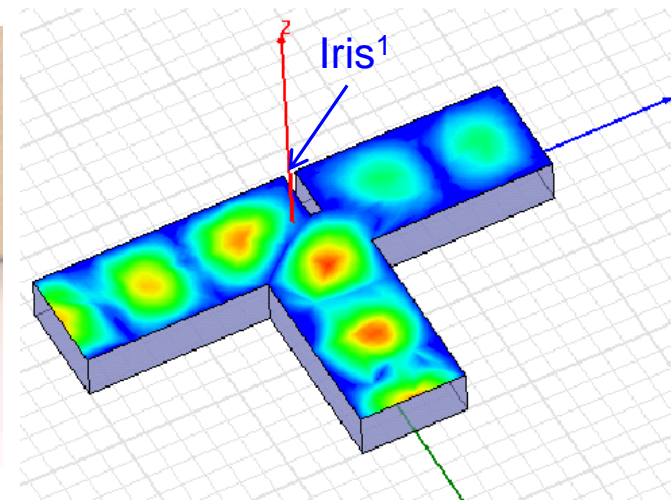

1: Due to the iris, the field is not symmetric!

# Nose cone cavity: field pattern

type-1 cavity with all symmetries exploited

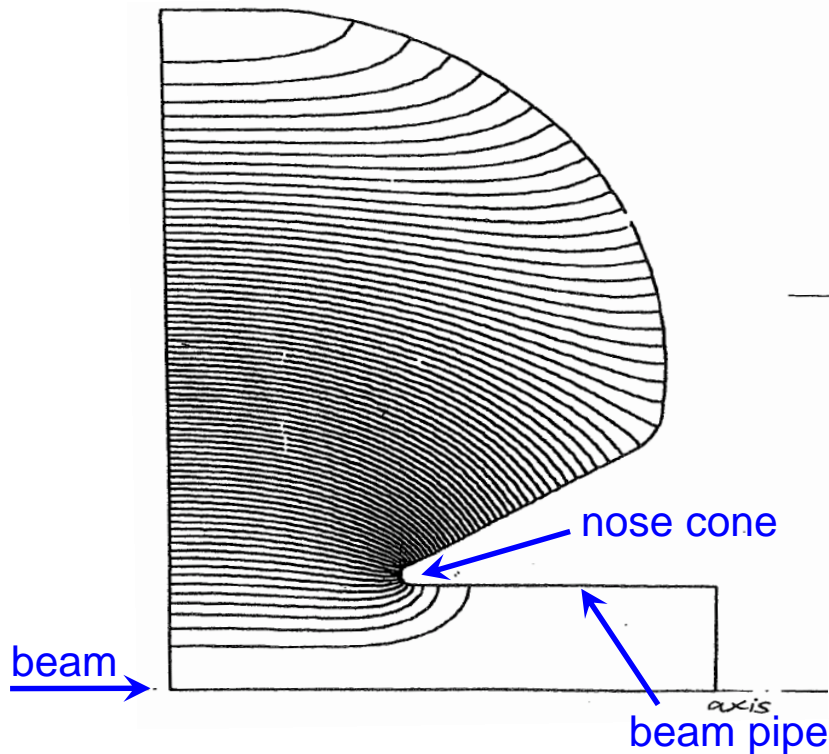

entire type-1 cavity

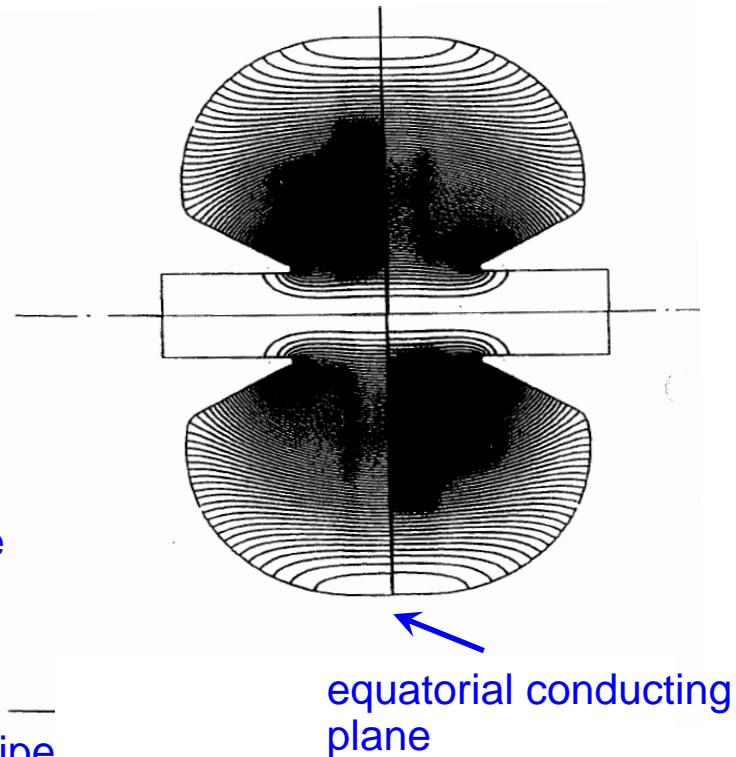

- ◆ The electric field lines are plotted

# Superfish: 2 ½ D simulation<sup>1</sup>

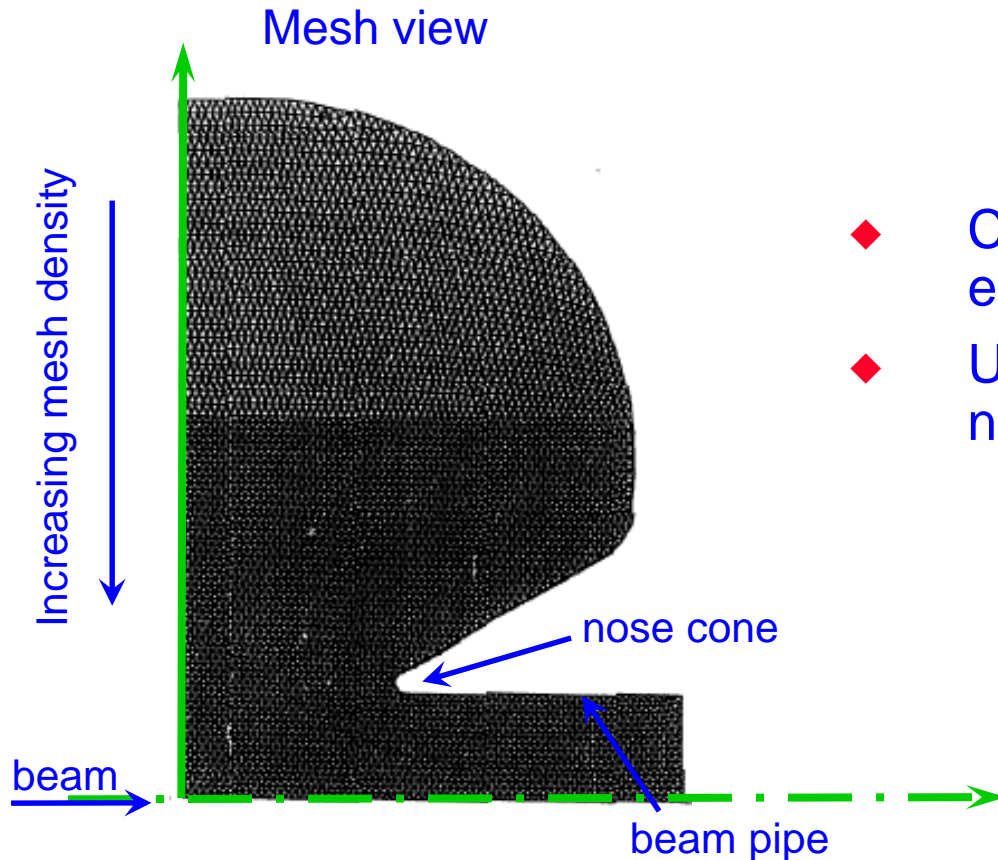

- ◆ Calculate resonant modes using eigenmode analysis
- ◆ Use symmetries to reduce the number of mesh points!!!
  - rotational symmetry around axis
  - left-right symmetry by defining metallic boundary (electric field lines perpendicular to this plane)

1: The name Superfish is derived from the Poisson equation (poisson is French for fish)

Why 2 ½ D? 2 D for the rotational symmetry of the object ½ D for using electric and magnetic symmetry planes

This example is a very old simulation from around 1980

# Higher order modes (HOMs)

Slightly different cavity:

126 MHz

288 MHz

406 MHz

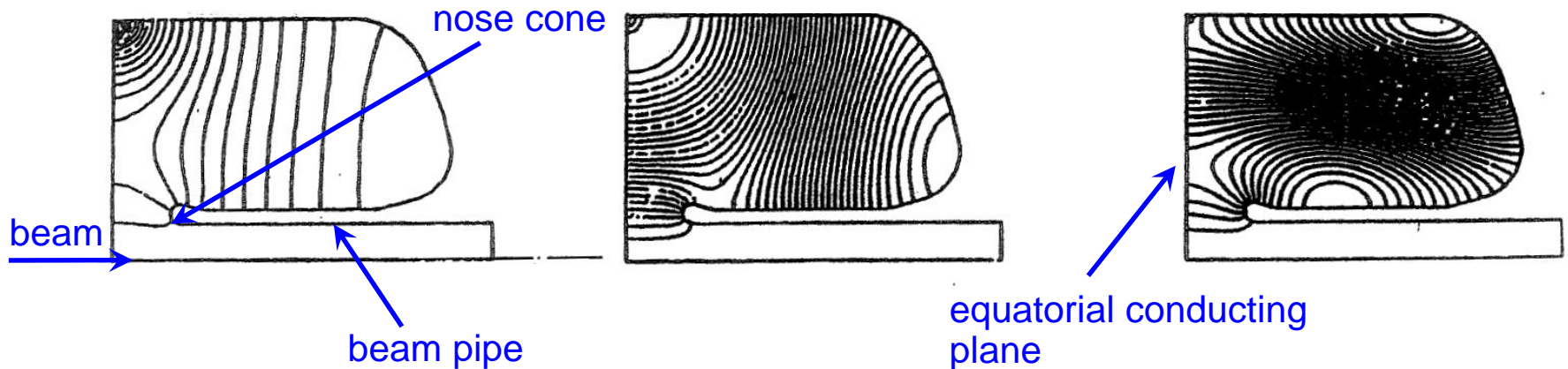

Higher order modes in a 100-MHz cavity.

All these modes are TM type modes. This is due to the boundary condition: electric wall in equatorial plane.

references: G. Rogner, CERN report SPS/SME/Note 86-65

# Transit time factor (1)

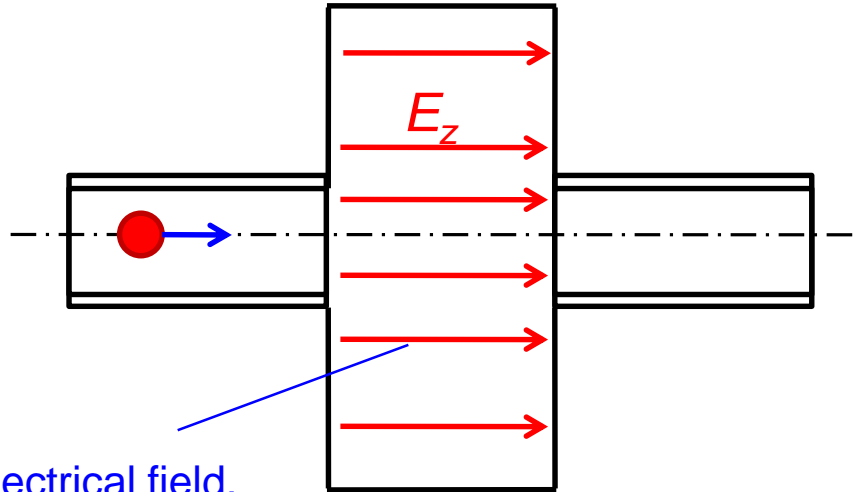

const. electrical field,  
e.g.  $E_{010}$  mode ( $E_r = E_\theta = 0$ )

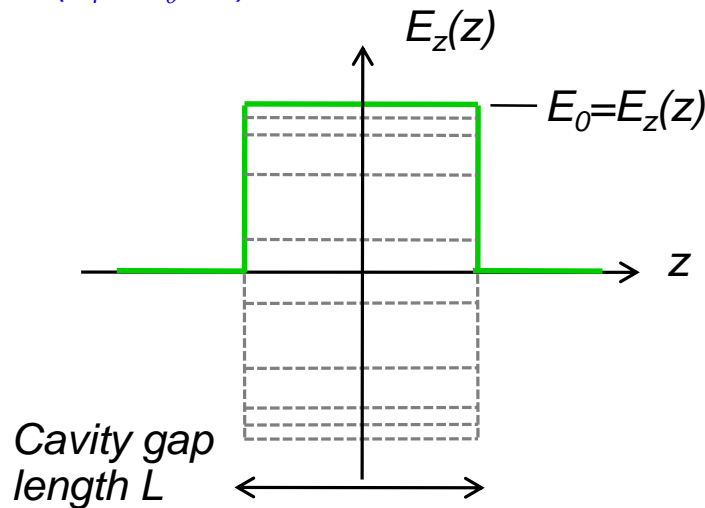

The “voltage” in a cavity along the particle trajectory (which coincides with the axis of the cavity) is given by the integral along this path for a fixed moment in time:

$$V = \int_L E_z(z) dz$$

But: the field in the cavity is varying in time:

$$\begin{aligned} E_z(z, t) &= E_z(z) f(t) \\ &= E_z(z) \cos(\omega t + \varphi) \end{aligned}$$

Thus, the field seen by the particle is

$$V = E_0 \int_{-L/2}^{L/2} \cos(\omega t + \varphi) dz$$

# Transit time factor (2)

The transit time factor describes the amount of the supplied RF-energy that is effectively used to accelerate the traversing particle.

$$T = \frac{V}{\hat{V}}$$

$V$  ... voltage seen by a particle  
 $\hat{V}$  ... reference voltage

→ relative loss in accelerating voltage

Usually, as a reference the moment of time is taken when the longitudinal field strength of the cavity is at its maximum, i.e.  $\cos(\varphi)=1$ . A particle with infinite velocity passing through the cavity at this moment would see

$$\hat{V} = E_0 L$$

Now the particle is sampling this field with a finite velocity. This velocity is given by  $v = \beta c$ . The resulting transit time factor returns therefore as

$$T = \sin\left(\frac{L \omega}{2 \beta c}\right) / \left(\frac{L \omega}{2 \beta c}\right)$$

Transit time factor, p.565f. ,Alexander Wu Chao, Handbook of Accelerator Physics and Engineering

# Transit time factor (3)

Example: Cavity gap length  $L = \lambda_0/2$   
 $\lambda_0 = 1\text{m}$  corresponding to  $f = 300\text{MHz}$   
 particle velocity  $v = c$  or  $\beta = 1$

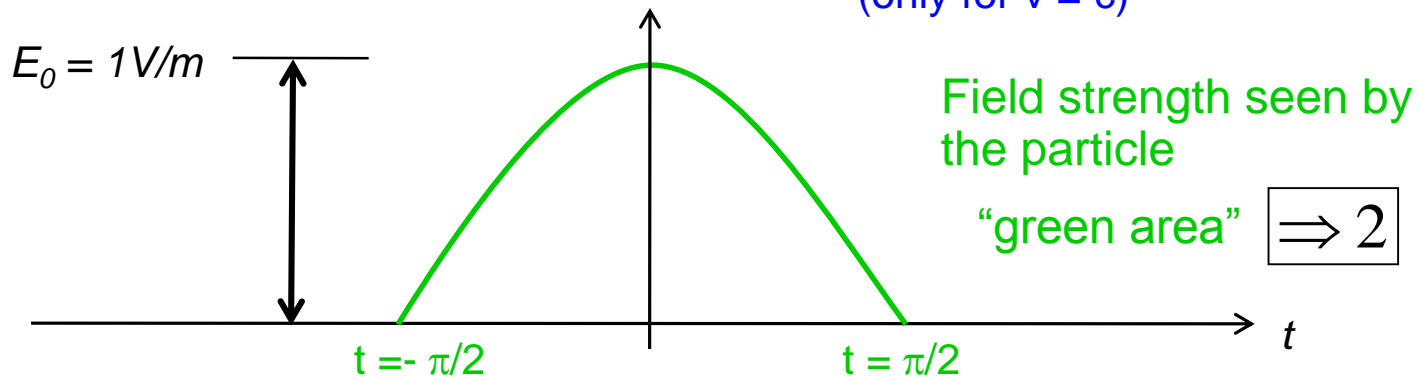
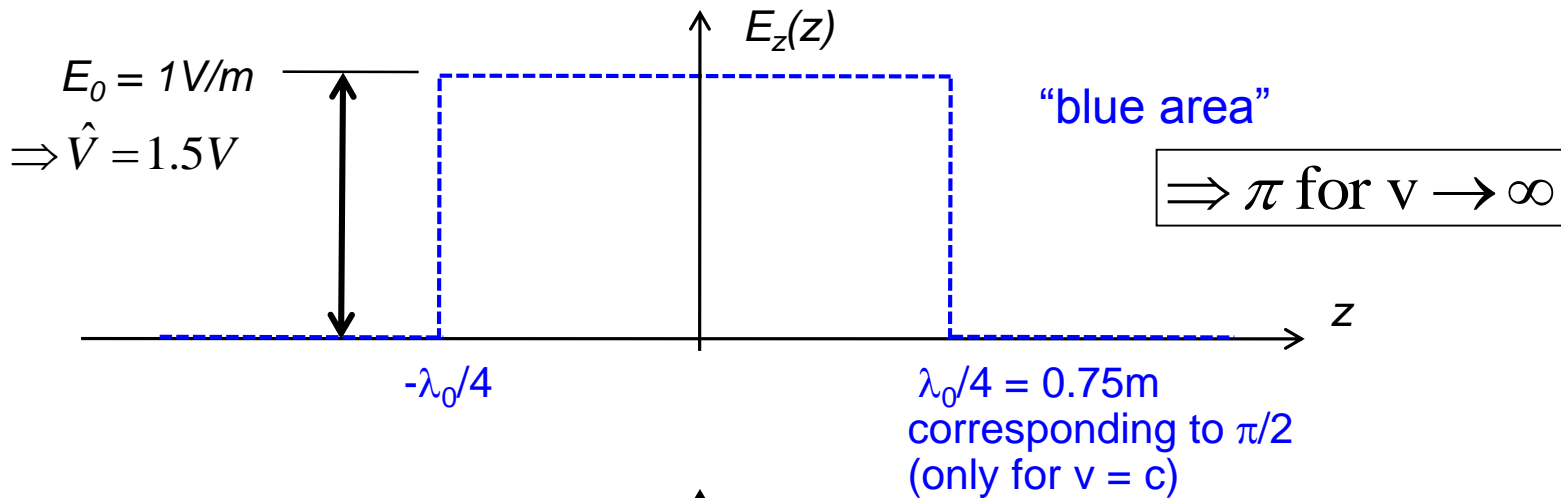

# Acceleration

We have “slow” particles with  $\beta$  significantly below 1. They become faster when they gain energy and in a circular accelerator with fixed radius we must tune the cavity (increase its resonance frequency).

When already highly relativistic particles become accelerated (gaining momentum) they cannot become significantly faster as they are already very close to  $c$ , but they become heavier. Here we can see very nicely the conversion of energy into mass. In this case no or little tuning of the resonance frequency of the cavity is required. It is sufficient to move the frequency of the RF generator within the 3dB bandwidth of the cavity.

Fast tuning (fast cycling machines) can only be done electronically and is implemented in most cases by varying the inductance via the effective  $\mu$  of a ferrite.



# Tuning of cavities (1)

Slater's perturbation theorem: 
$$\frac{\Delta f}{f} = -\frac{1}{2} \frac{\Delta W}{W} = -\frac{1}{2} \frac{\Delta C}{C} = -\frac{1}{2} \frac{\Delta L}{L}$$

with W designating the energy

stored in the cavity (see also slide equivalent circuit (2))

## ◆ Inductive tuner

- In regions of high magnetic field
- increases resonant frequency ( $\Delta W < 0$ )

$$\Delta W = -\frac{\Delta L I^2}{2}; \quad dW = -\frac{\mu_0 \mu_r H^2}{2} dV$$

## ◆ Capacitive tuner

- In regions of high electric field
- decreases resonant frequency ( $\Delta W > 0$ )

$$\Delta W = \frac{\Delta C V^2}{2}; \quad dW = \frac{\varepsilon_0 \varepsilon_r E^2}{2} dV$$

# Tuning of cavities (2)

## ◆ Operational tuning

- paddle tuner
- bulk tuner

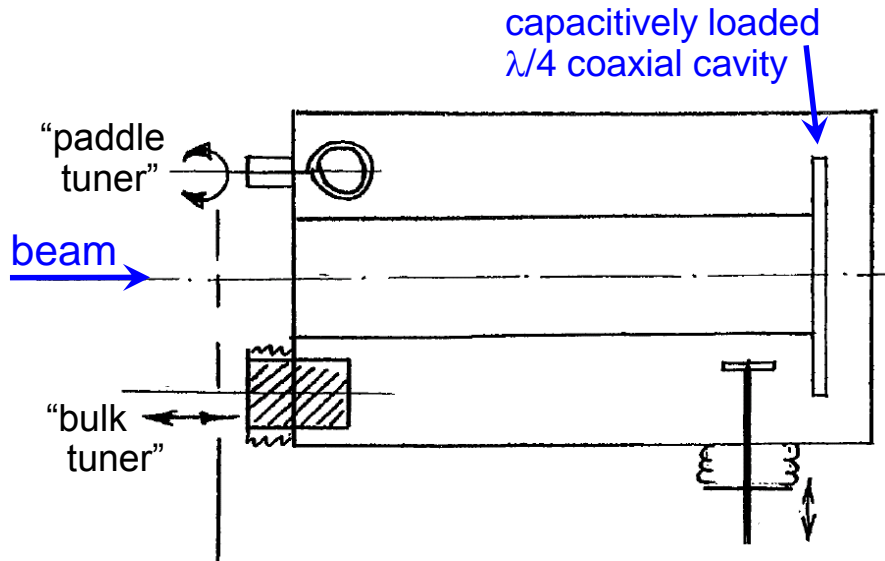

## ◆ Tuning by global deformation

- mechanically (SC cavities)
- thermally

Source of right image: G.R Swain et al., "Cavity tuning for the LAMPF 805 MHz Linac", 1972 Linac Conference, p. 242

## ◆ Initial tuning during manufacture

- Bumping, dummy tuners
- modification of joint sizes or plating thickness

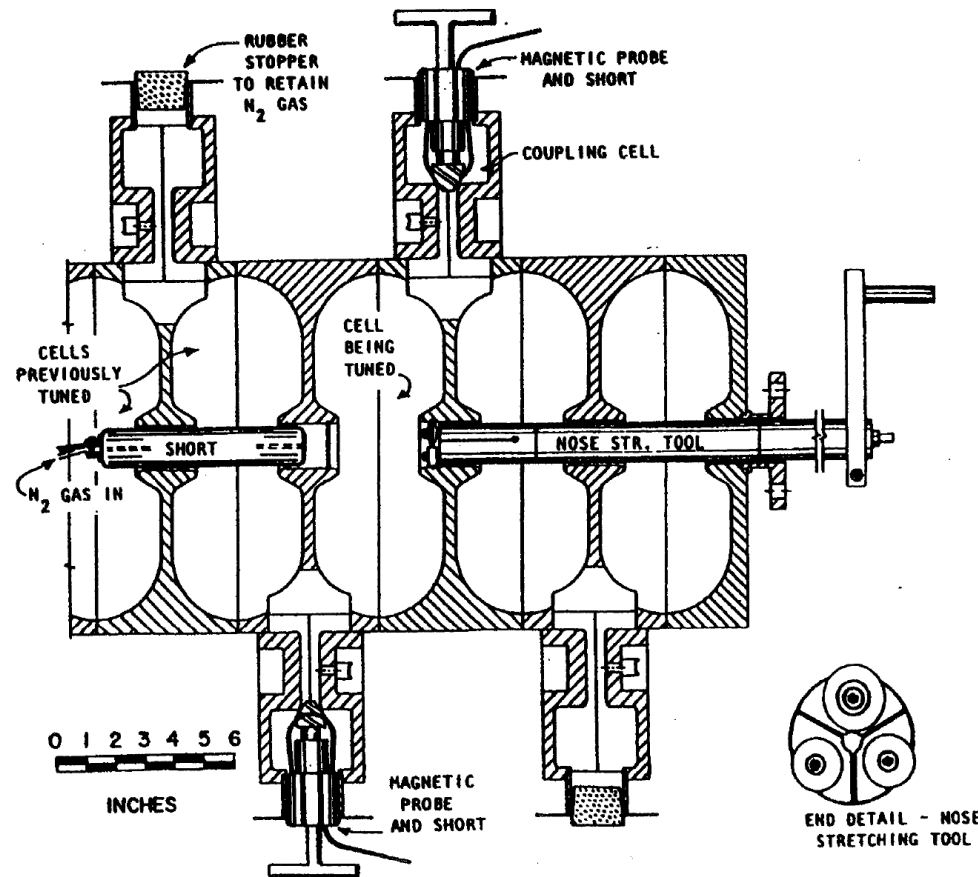

Coupling and Tuning

# Coupling cavities to the outside world (1)

- ◆ Direct coupling (DC coupling)  
Generator (tube) has to "see" a certain voltage  $U$

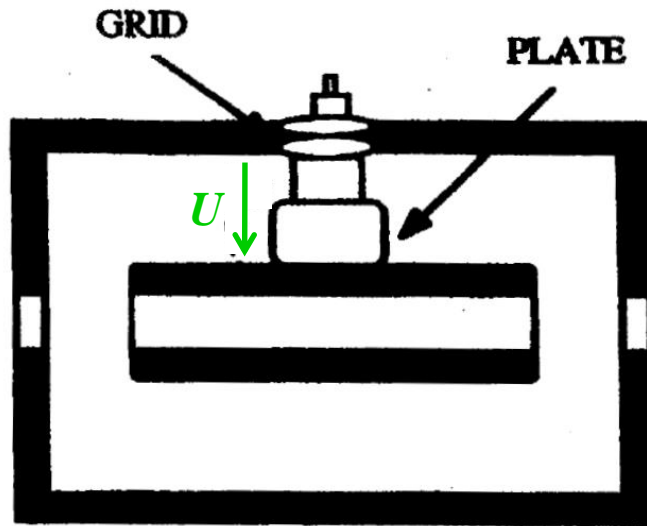

"Wideroe" or  $\lambda/2$  structure

basic  $\lambda/4$  - resonator

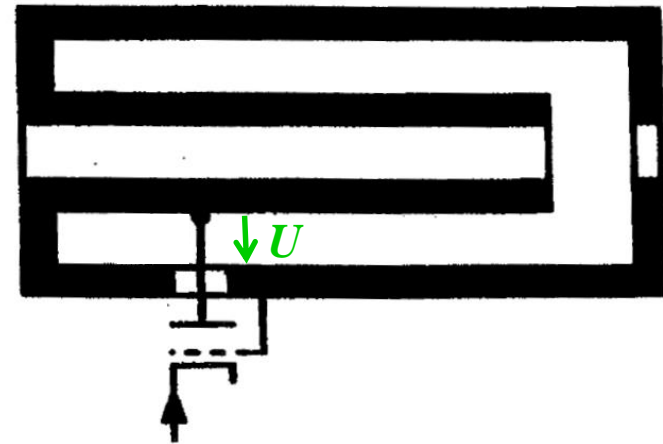

Source: M. Puglisi: "Conventional RF cavity design"  
CAS "RF engineering for Particle Accelerators", CERN 92-03, Vol. 1

# Coupling cavities to the outside world (2)

## Acts as transformer:

### ◆ Inductive coupling

Generator requirement:

P ... required power

Z ... optimum load resistance

Induced voltage in loop:

$$V = \sqrt{2PZ}$$

$$V = \mu_0 \frac{d}{dt} \int_S H ds$$

### ◆ Capacitive coupling

Generator requirement:

Induced displacement current

$$I = \sqrt{2P/Z}$$

$$V = \varepsilon_0 \frac{d}{dt} \int_S E ds$$

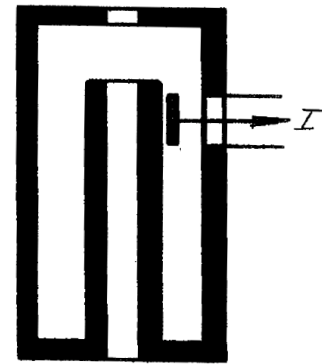
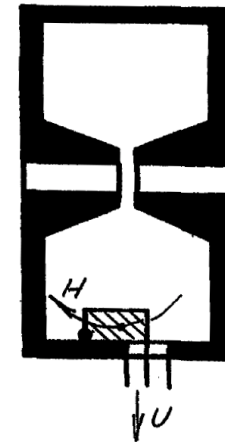
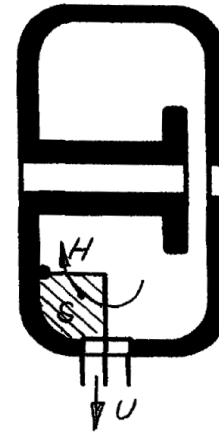

# General example

A single-cell configuration: 114-MHz room temperature cavity of CERN PS. Type I profile with nose-cone to optimize shunt impedance

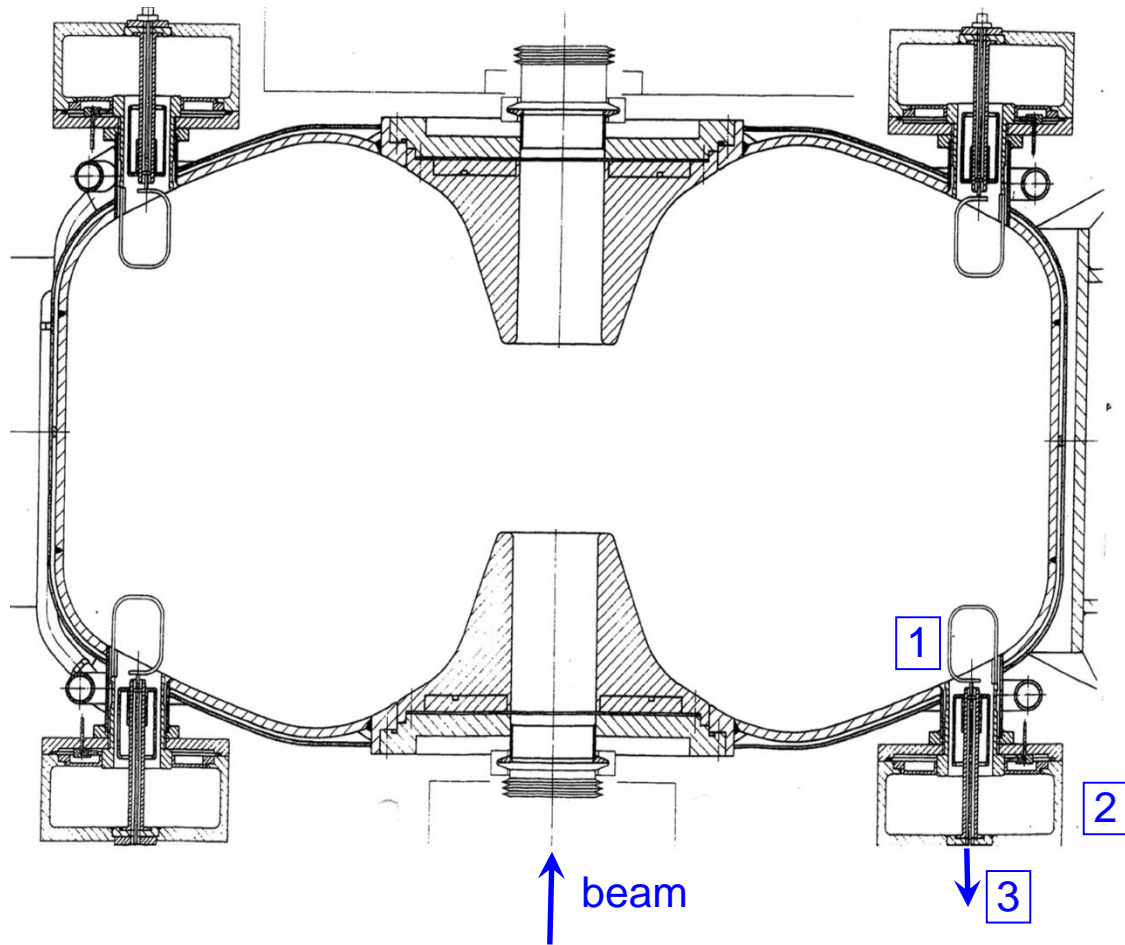

- 1: higher order mode (HOM) coupling loop which serves for eliminating beam-induced power
- 2: HOM filter
- 3: HOM power guided towards load and dissipated

# Different forms of the pillbox cavity

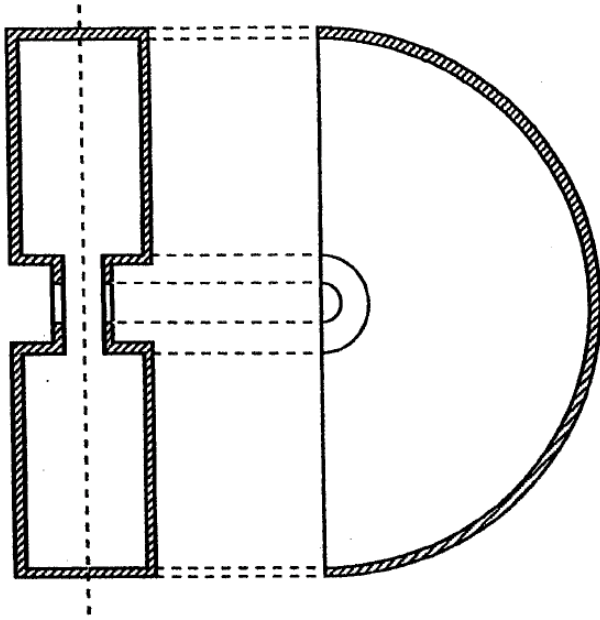

Cross section of a radial cavity

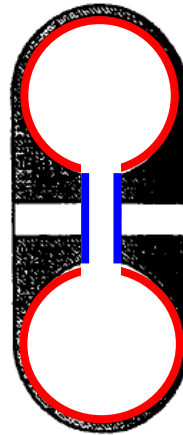

nose-cone cavities

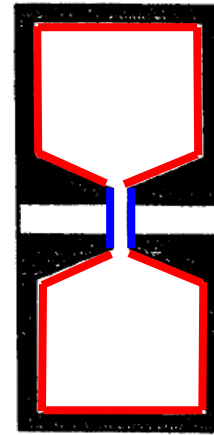

disc-loaded cavities

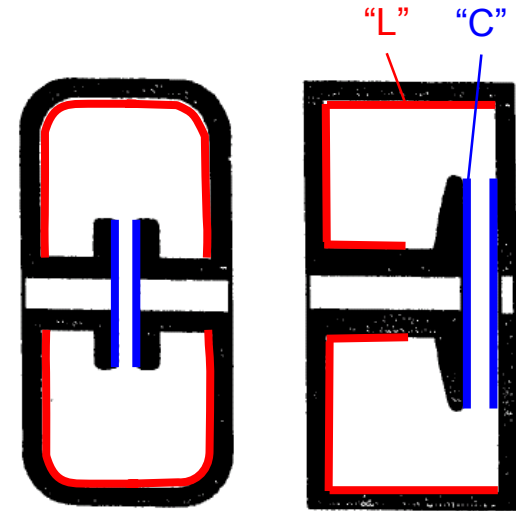

Four different cross sections of fundamentally similar cavities. In spite of their similarity they have been given different names...

Source: M. Puglisi: "Conventional RF cavity design"  
CAS "RF engineering for Particle Accelerators", CERN 92-03, Vol. 1

# The coaxial (TEM-mode) cavity

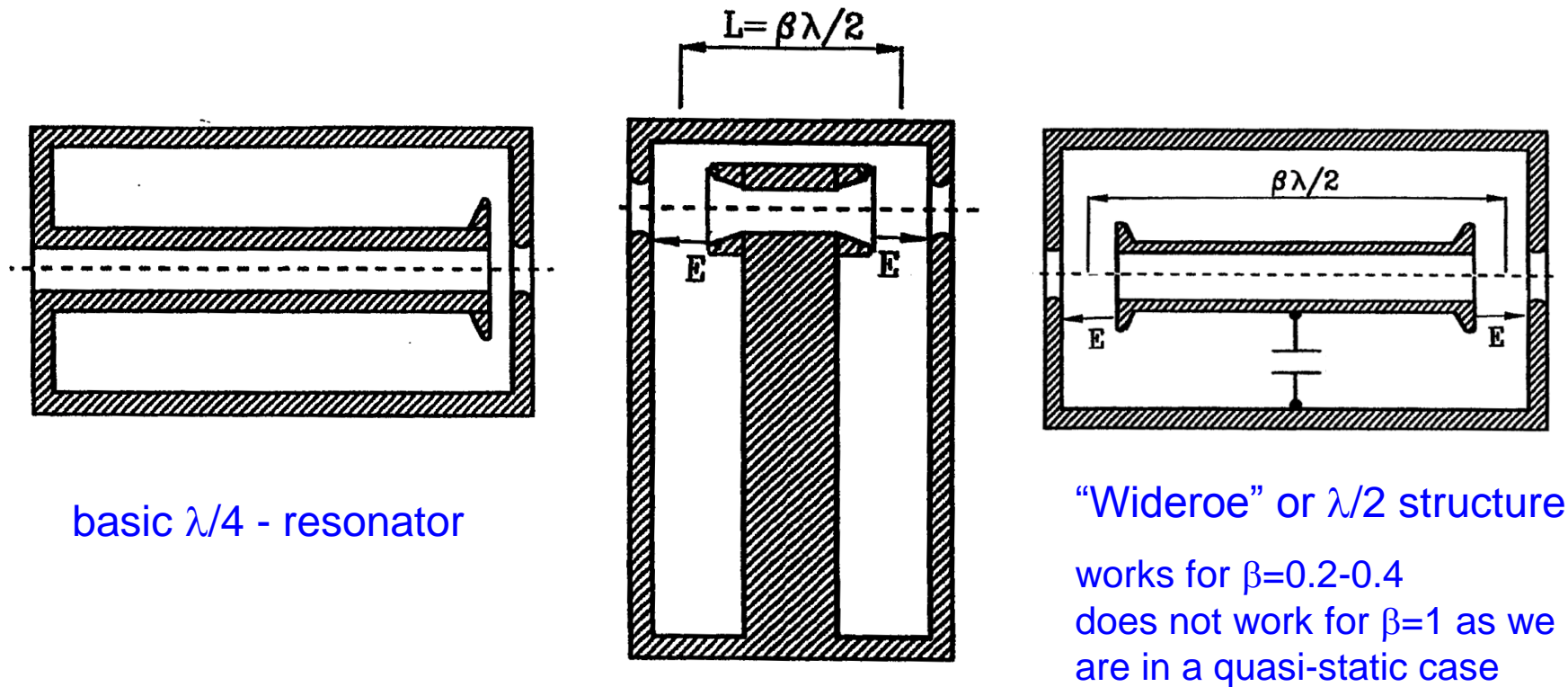

basic  $\lambda/4$  - resonator

modified  $\lambda/4$  - resonator for acceleration in  $\beta\lambda/2$ -mode

"Wideroe" or  $\lambda/2$  structure works for  $\beta=0.2-0.4$  does not work for  $\beta=1$  as we are in a quasi-static case

Source: M. Puglisi: "Conventional RF cavity design"  
CAS "RF engineering for Particle Accelerators", CERN 92-03, Vol. 1

# Spiral resonators

- ◆ For small  $\beta$  relatively low RF frequencies have to be used
- ◆ Drift tubes are mounted on  $\lambda/4$  lines acting as  $\lambda/4$  resonators (will be treated in second part of lectures)
- ◆ Long  $\lambda/4$  lines coiled up to make structure smaller



A  $\beta = 5.4$  % power resonator

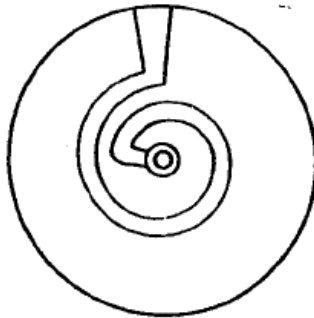

Spiral resonator.

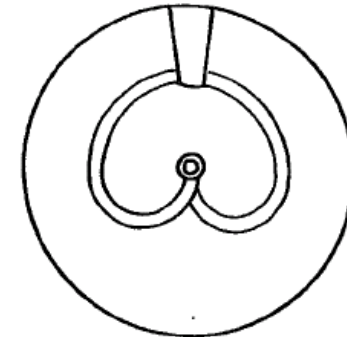
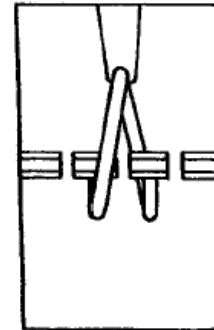
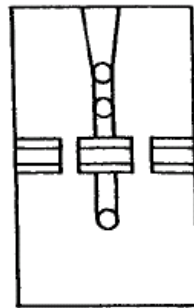

Split-ring resonator.



# Ferrite loaded cavities (1)

- ◆ Tuning possible by choosing an appropriate static or slowly varying magnetic bias field => differential  $\mu$  adjustable. Bias field and RF field are parallel.

$B$  versus  $H$  with added AC field

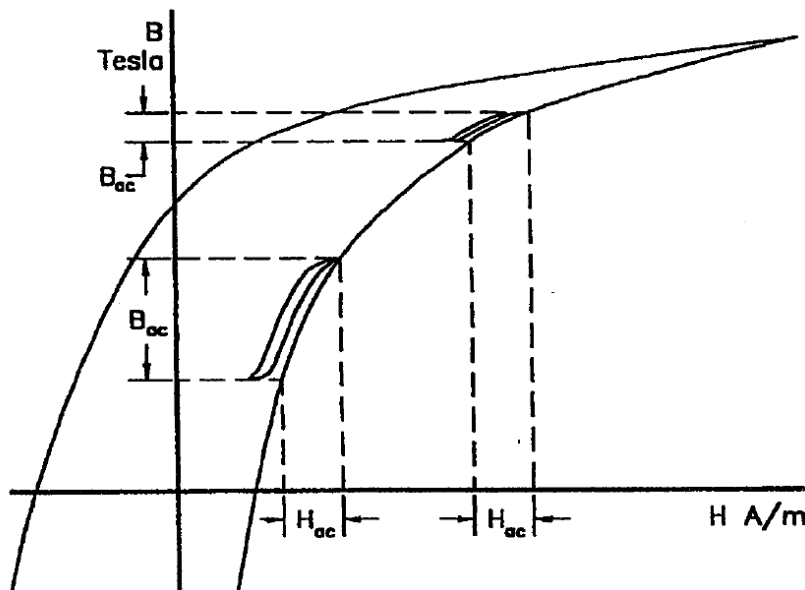

A period of the AC field corresponds to one round in one of the little hysteresis loops.

$\mu_r$  versus  $H$

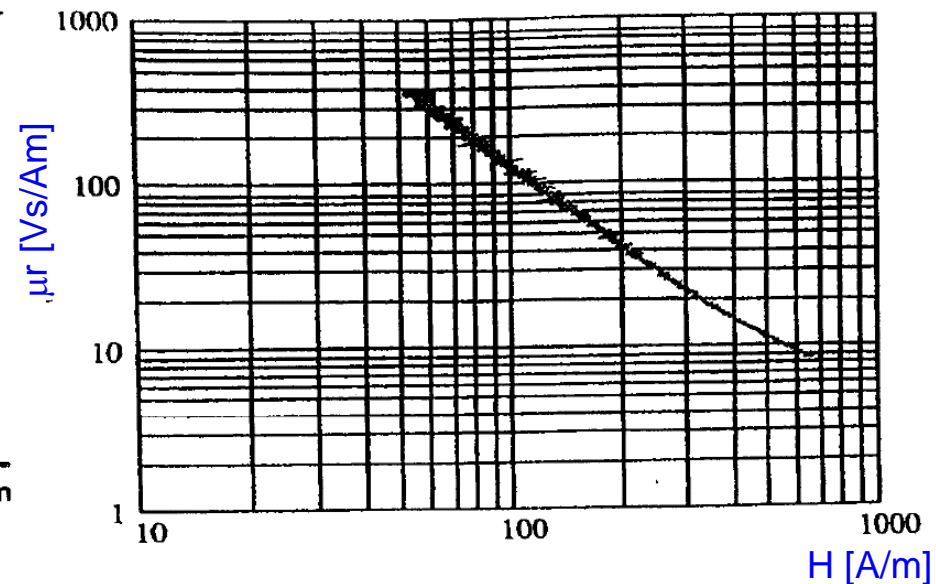

Bias  $B$  field parallel to RF magnetic field in above plot

# Ferrite loaded cavities (2)

This is essentially a  $\lambda/4$  cavity with magnetically variable length.

Ferrite toroidal discs, interleaved with copper sheets on “equipotential lines” for cooling.

ceramic window

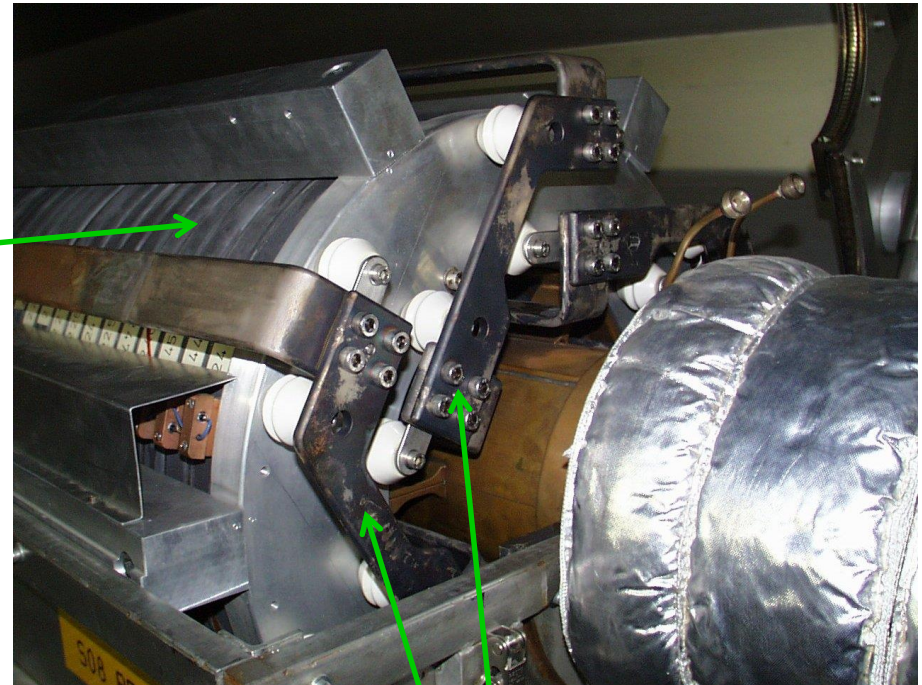
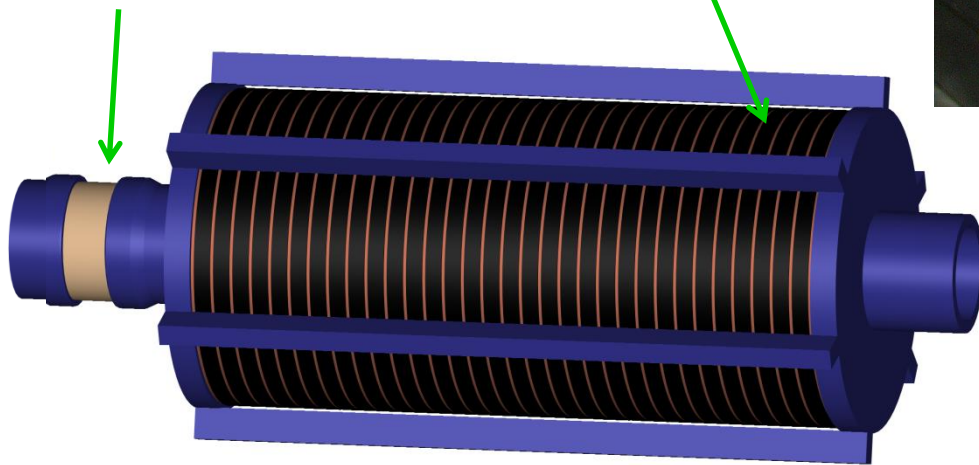

Picture: K. Kasper (GSI)

Bus bars to supply the DC bias, the **DC field is parallel (azimuthally)** to the RF field.

Source: H. Damerou (CERN), private communication  
Cavity in the SIS (Schwerlonen Synchrotron)  
at GSI, frequency range from 0.8 – 5.4 MHz

# Ferrite loaded cavities (3)

- ◆ Ferrite loading makes line electrically longer => cavity size can be reduced
- ◆ Bias  $B$  field in ferrite orthogonal to RF magnetic field
- ◆ tunable between 46 and 61 MHz by variable bias field

In this mode of operation of orthogonal bias, the DC field is orthogonal to the RF field. The  $\mu$  of the ferrite can be varied in a more efficient way as compared to parallel magnetic bias.

Tunable cavity for TRIUMF (Three Universities Meson Facility, Vancouver) designed by LANL (Los Alamos).

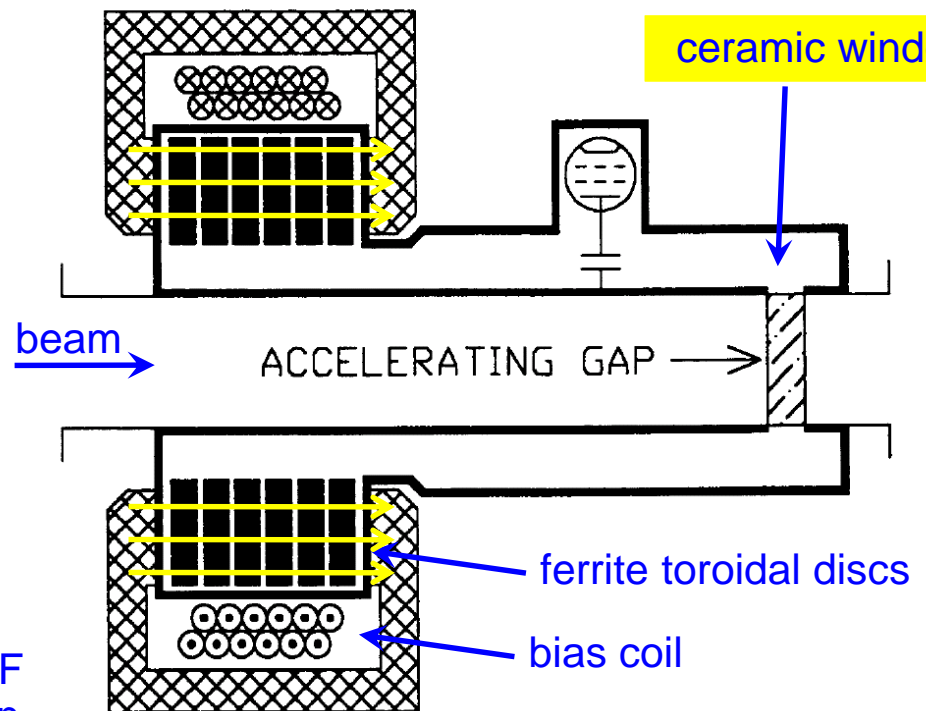

From: ISK Gardner: "Ferrite dominated cavities" CERN 92-03, Vol. II [2]

# RF window

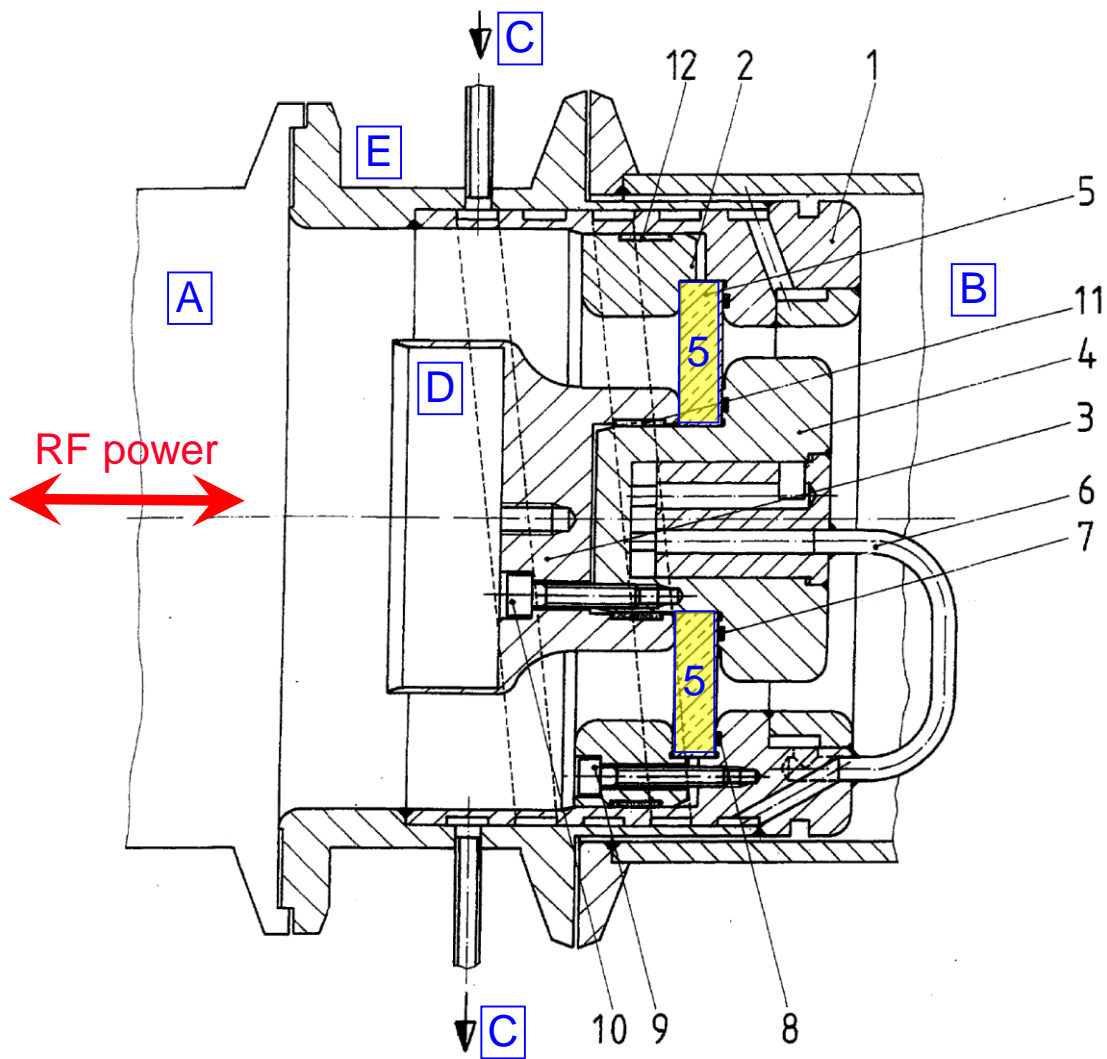

An RF window for a 114 MHz LEP cavity

On which side is the vacuum?

How does the structure continue on the left side?

5: Ceramic disc

6: Coupling loop

7: Vacuum seal

A: Pressurized side (air)

B: Cavity side (vacuum)

C: Cooling water ducts

D: Inner conductor

E: Outer conductor

# “Kilpatrick” voltage breakdown (1)

The maximum E field achievable is limited by a process known as RF **breakdown**.  
The Breakdown voltage is given by

$$W \cdot E^2 \cdot e^{\frac{-1.7 \cdot 10^5}{E}} = 1.8 \cdot 10^{14}$$

where  $W$  [eV] is the impact energy of the electrons and  $E$  the electric field [V/m]  
( $W = E \cdot \text{gap width}$  for DC,  $W < E \cdot \text{gap width}$  for RF).

- ◆ High power effect
- ◆ Destructive!!
- ◆ Breakdown voltage proportional to square root of frequency

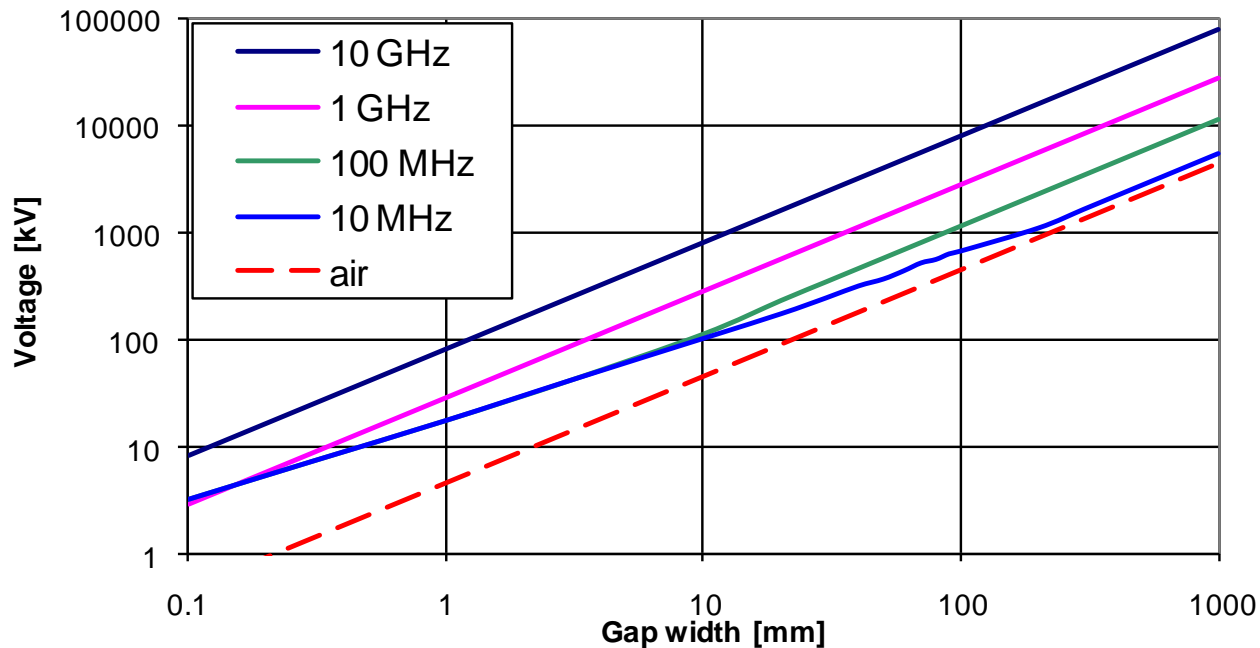

Breakdown voltage given in plot for vacuum (solid lines) and in air (dashed line)

# “Kilpatrick” voltage breakdown (2)

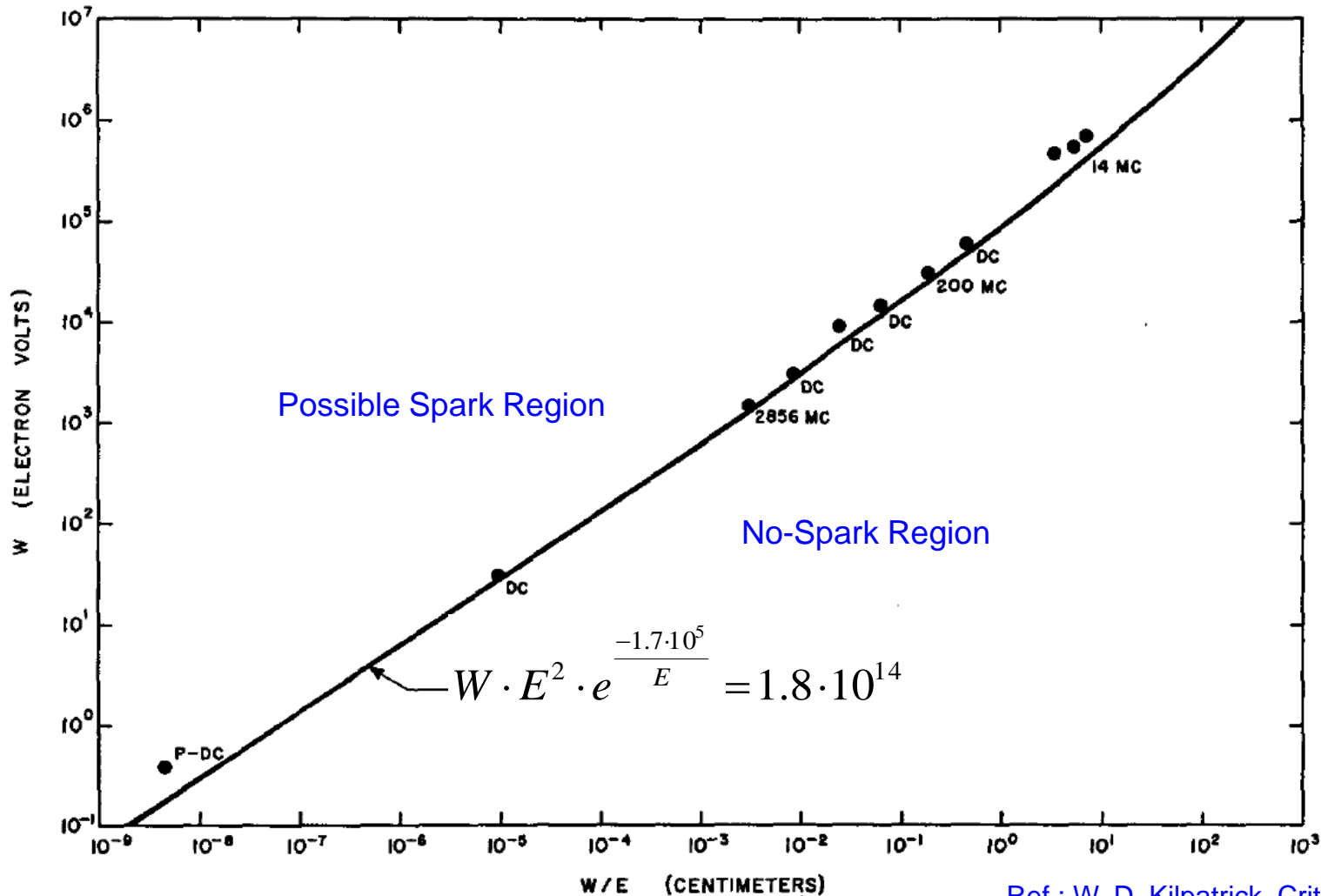
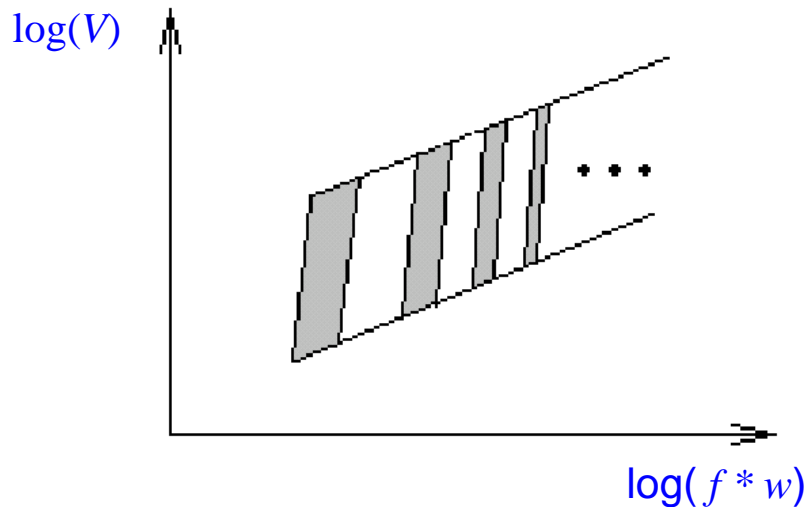
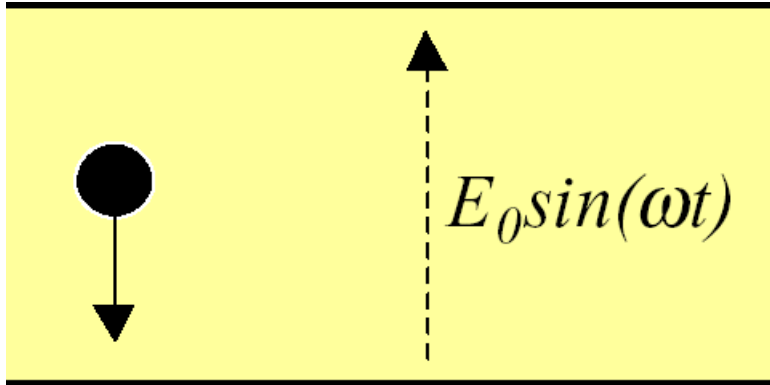

FIG. 1.  $W$  is the maximum ion energy at the cathode, in electron volts. For dc,  $W$  corresponds to the applied voltage, and  $W/E$  is the gap spacing for plane parallel fields. For rf,  $W$  is a function of frequency and gap (see text).

Ref.: W. D. Kilpatrick, Criterion for vacuum sparking designed to include both Rf and DC, The Review of Scientific Instruments, Vol. 28, No. 10, 1957

# Multipactor (1)



Basically,

- ◆ Electrons get accelerated in an electric field
- ◆ When they hit the wall, secondary electrons are freed
- ◆ If the electric field changes sign as it is the case for RF fields, the secondary electrons will eventually see an accelerating field
- ◆ Therefore, at least for some distinct frequency bands and accelerating voltages, resonance effects can be expected

$V$  ... gap voltage  
 $f$  ... RF frequency  
 $w$  ... gap width

No multipactor for very small gap width or very high frequencies

# Multipactor (2)

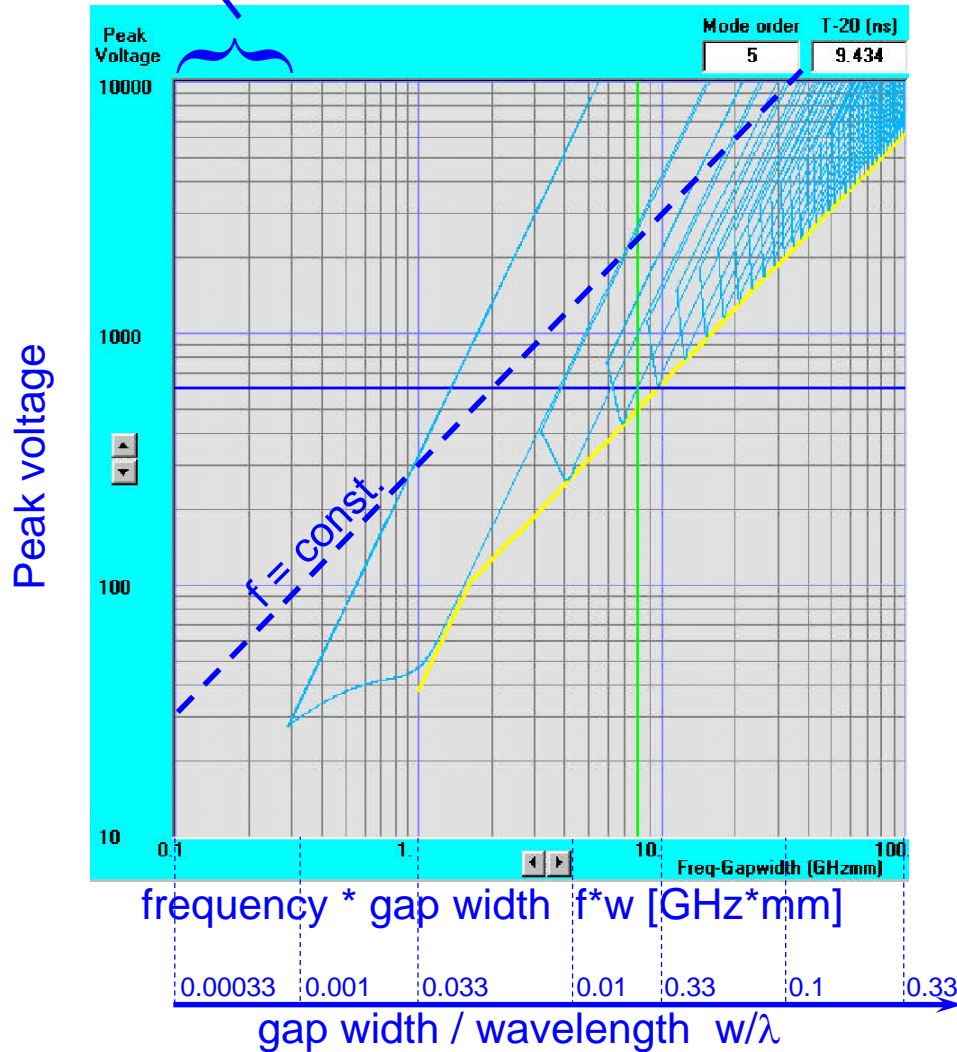

More formally,

- ◆ Multipactor is a resonant avalanche discharge, typically a **low-power effect**.
- ◆ The basic "two-point" resonance condition is met if the time of flight of an electron between electrodes equals an odd number of RF half cycles
- ◆ Other necessary condition: The coefficient of secondary electron emission must be larger than 1. This corresponds to an energy range between 50 eV and 5000 eV for copper surfaces

Multipactor calculator available at <http://www.estec.esa.nl/multipac/>



# RF systems

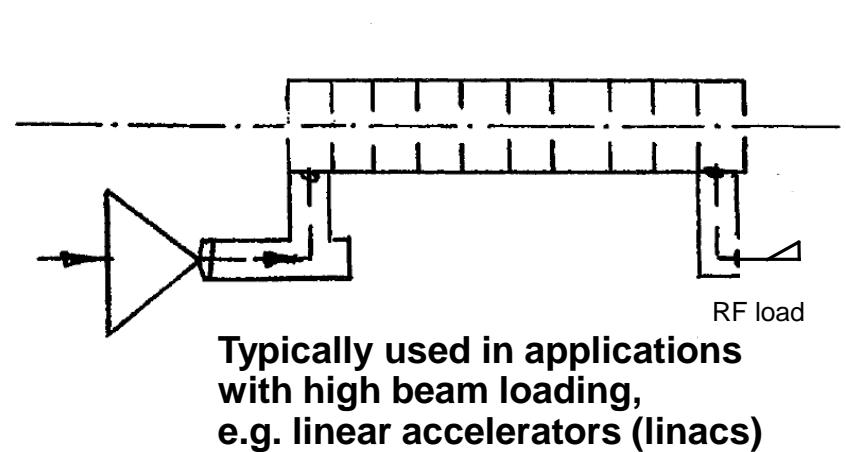
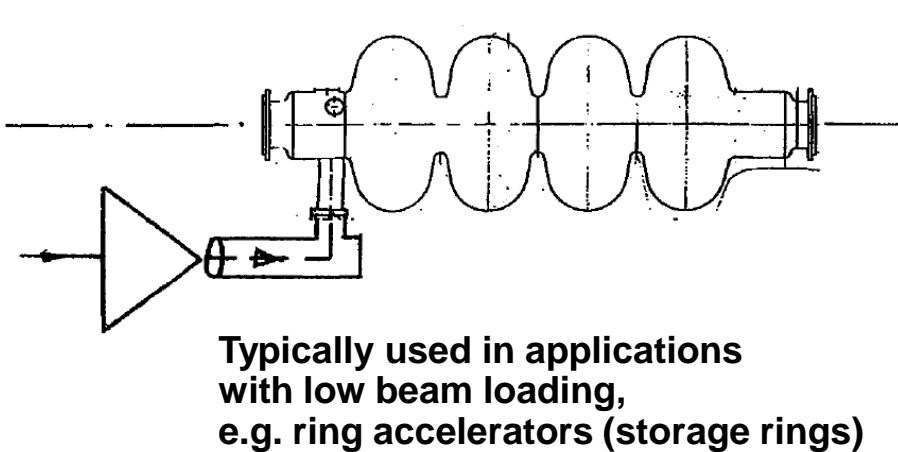
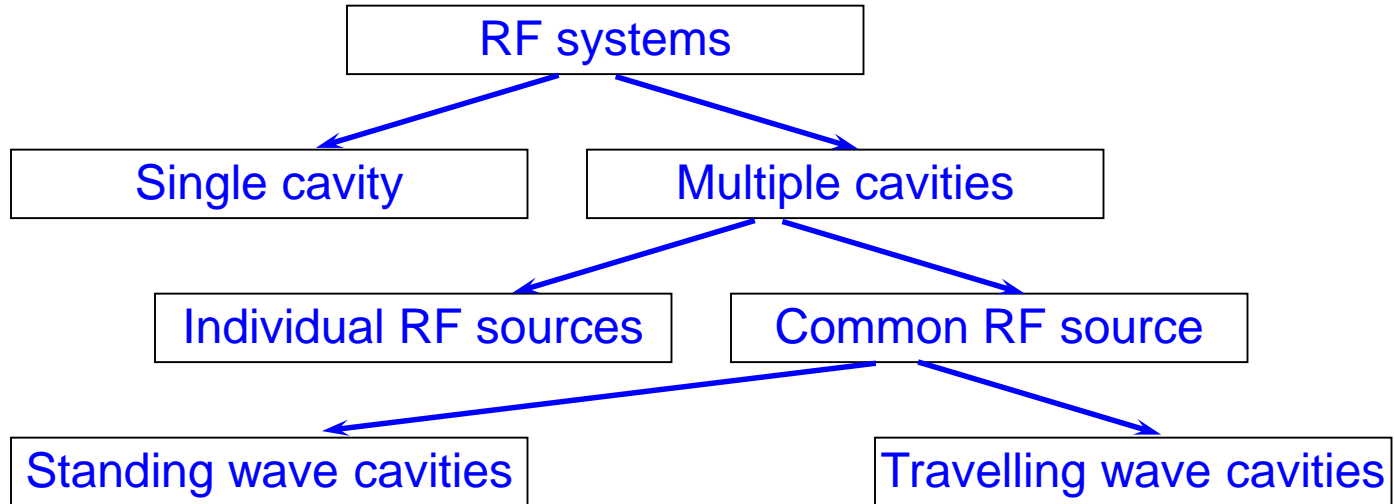

# Standing wave cavities

- ◆ The only possible phase differences between the SW fields in lossless cells are  $0^\circ$  or  $180^\circ$ .
- ◆ For  $N$  cells there are  $N$  possible longitudinal modes. Practically used modes:
  - $0^\circ$  (zero mode): Gap distance  $\beta\lambda$  with  $\beta = v/c$ . Structures: Alvarez Drift Tube Line (DTL)
  - $90^\circ$  ( $\pi/2$  mode): Distance active cell to coupling cell  $\beta\lambda/4$  or  $\beta\lambda/2$ . Structures: Side coupled, Disk and Washer
  - $180^\circ$  ( $\pi$  mode): Gap distance  $\beta\lambda/2$ . Structures: Wideroe, superconducting cavities (LHC, TESLA), Interdigital (IH)

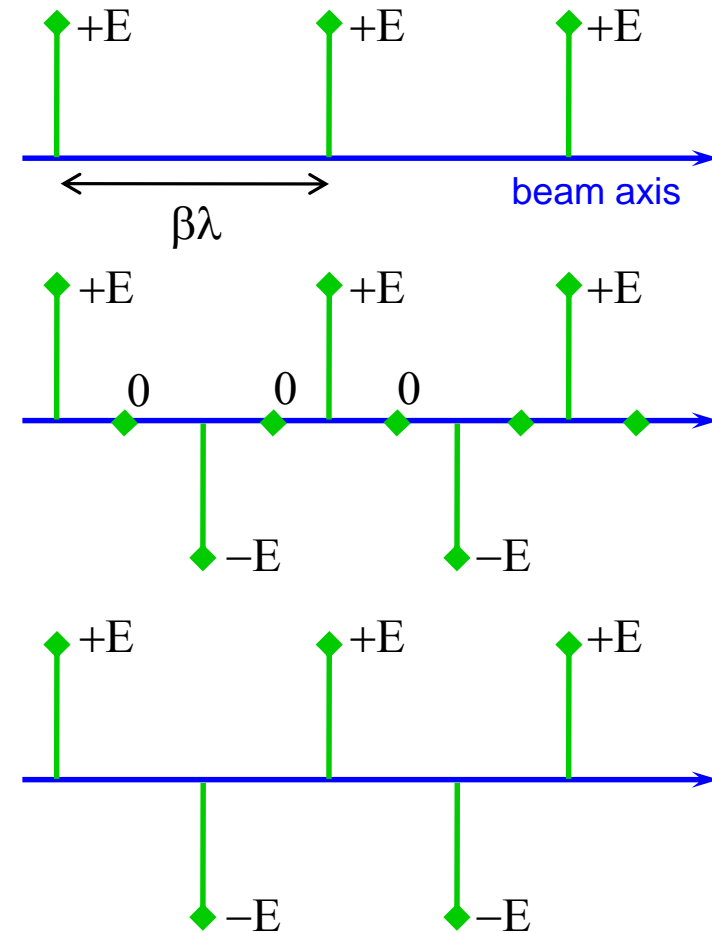

# Travelling wave cavities

- ◆ Phase difference between adjacent cells can be chosen arbitrarily to assure synchronism with beam. Values around  $2\pi/3$  give best compromise between structure length, group velocity (filling time) and overall dissipation.
- ◆ Without beam loading, almost the full input power is dissipated in the absorber.
- ◆ The field decay due to attenuation of the structure can be taken into account by designing "constant gradient" rather than constant geometry structures.
- ◆ There exists a specific amount of beam loading for which all RF power is transmitted to the beam, resulting in zero power dissipated in the absorber =>"fully loaded" structure.
- ◆ Repercussion of beam loading and structure transients on generator is minimized.
- ◆ Structures
- ◆ Loaded waveguide (generally used in electron linacs, e.g. CERN LIL, CLIC ...), Parallel bar

# Examples (1)

- ◆ Standing wave cavity in multicell configuration
- ◆ This superconducting cavity was used in CERN's LEP
- ◆ "Type II" profile without nose-cone to avoid multipactor and reduce  $r/Q$

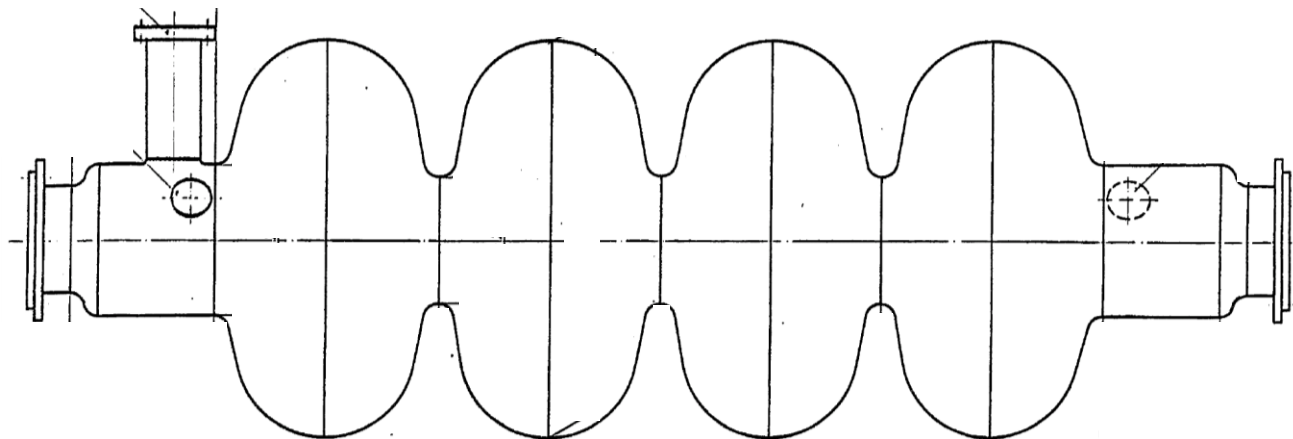
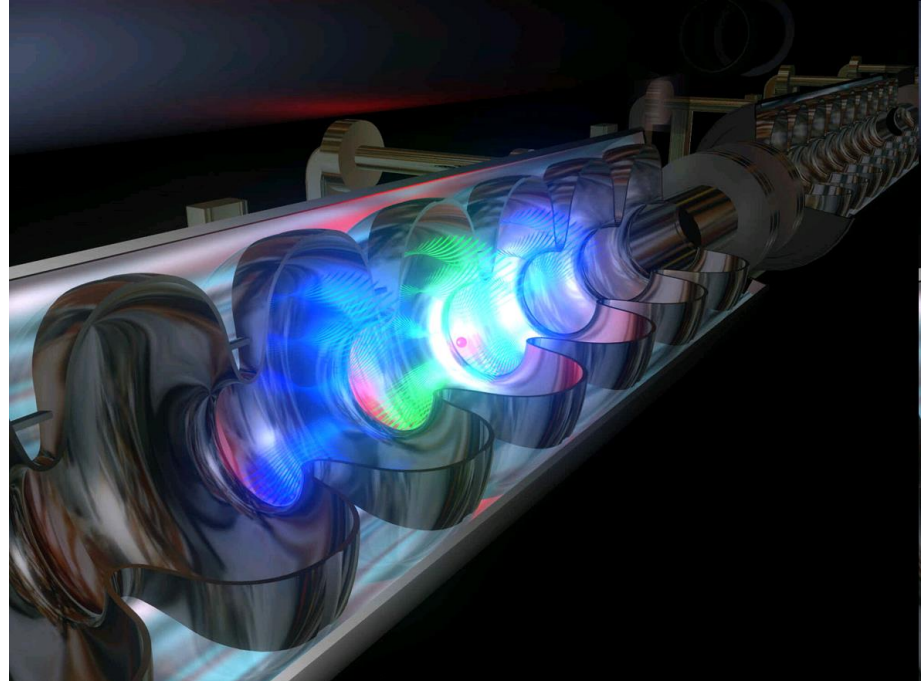

# Examples (2)

- ◆ Standing wave drift tube resonator
- ◆ Below: An ALVAREZ structure (Drift tubes with interposed quadrupole magnets), used in the CERN 50 MeV Proton LINAC  
Frequency: 202.56 MHz

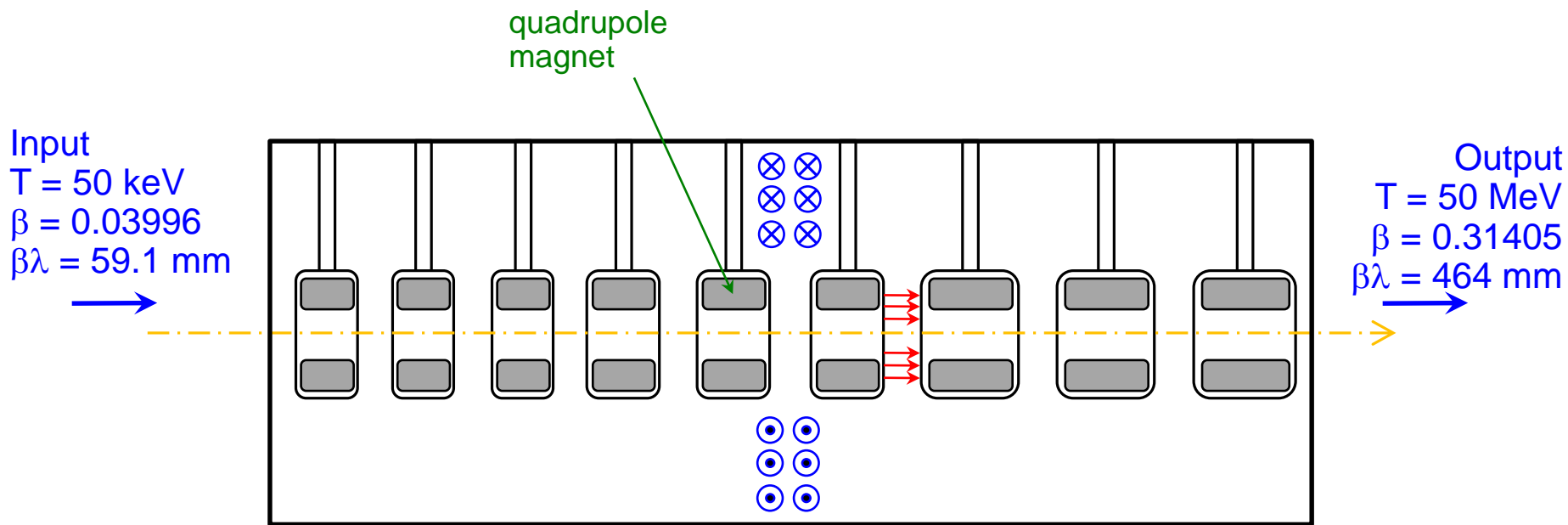
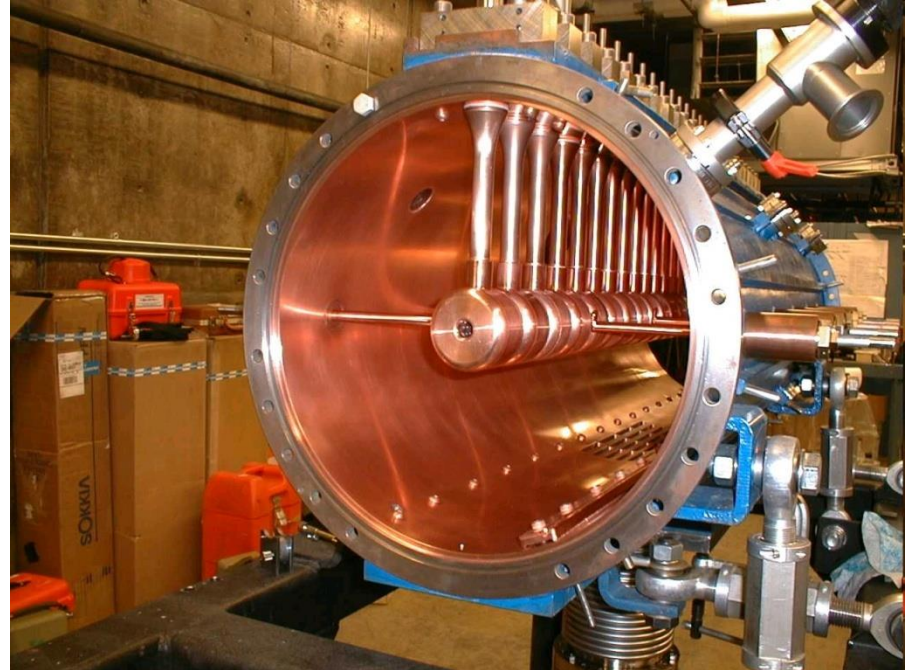

# Examples (3)

- ◆ Travelling wave accelerating structures
- ◆ TW and SW operation of disk-loaded acceleration structures

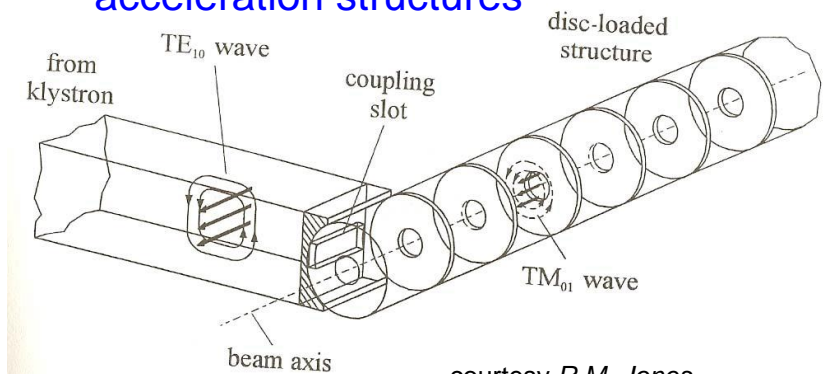

courtesy R.M. Jones  
(Linacs Week, April 2007)

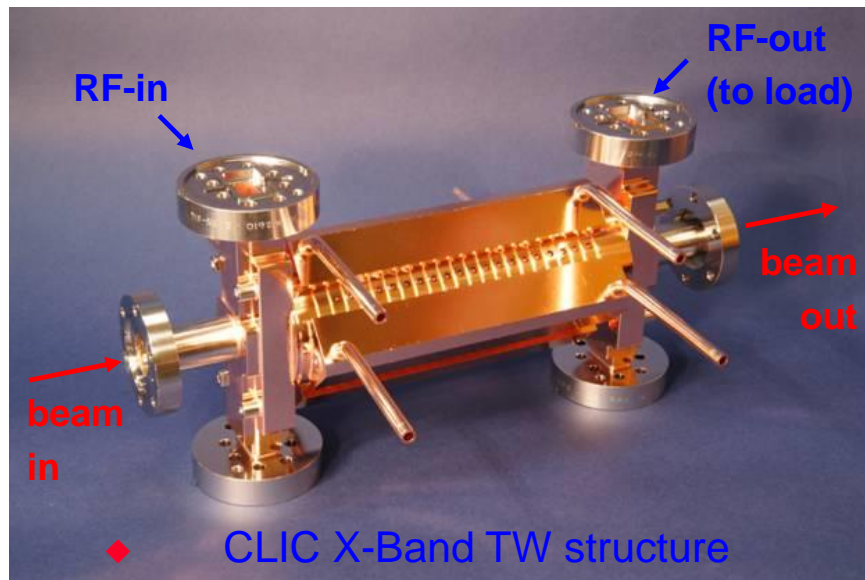
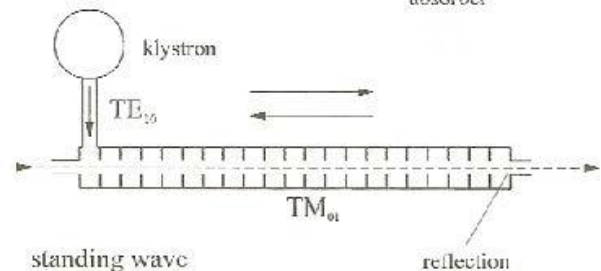
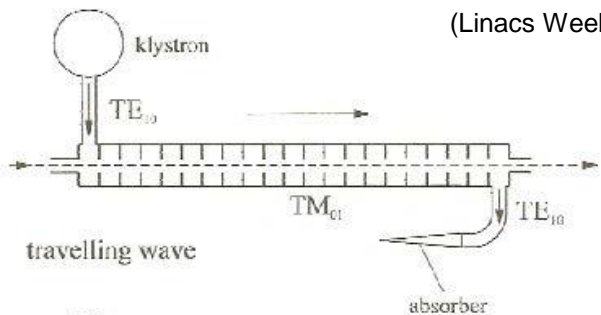

◆ CLIC X-Band TW structure

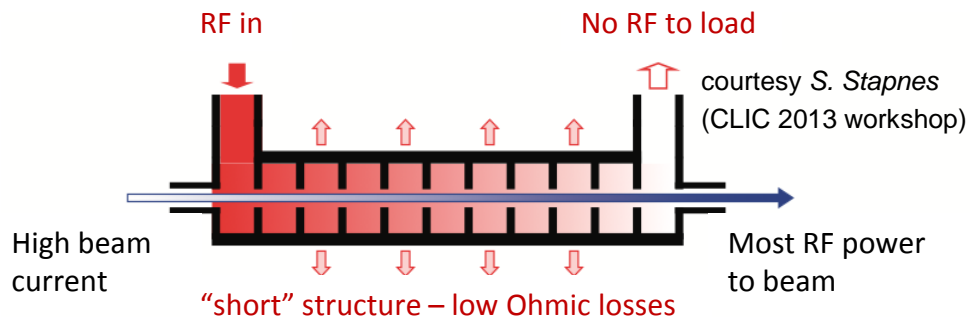

courtesy S. Stapnes  
(CLIC 2013 workshop)

## ◆ 5-cell TW 2/3 π mode Superfish simulation

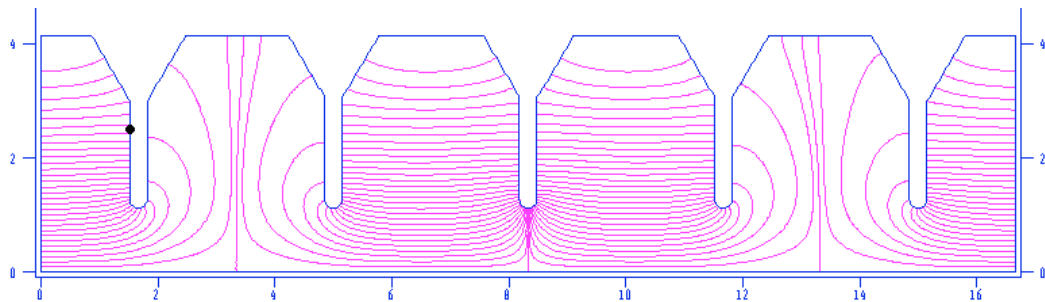

0:\AAAG\FISH\FONTMG.AF 3-09-2011 17:30:24

courtesy A. Setty  
(PAC 2013)

Multiple cell cavities

# Side coupled structures

- ◆ Cavity geometry changes to optimize shunt impedance
- ◆ Higher shunt impedance => higher accelerating gradient
- ◆ Side coupled cavity configuration for optimum shunt impedance

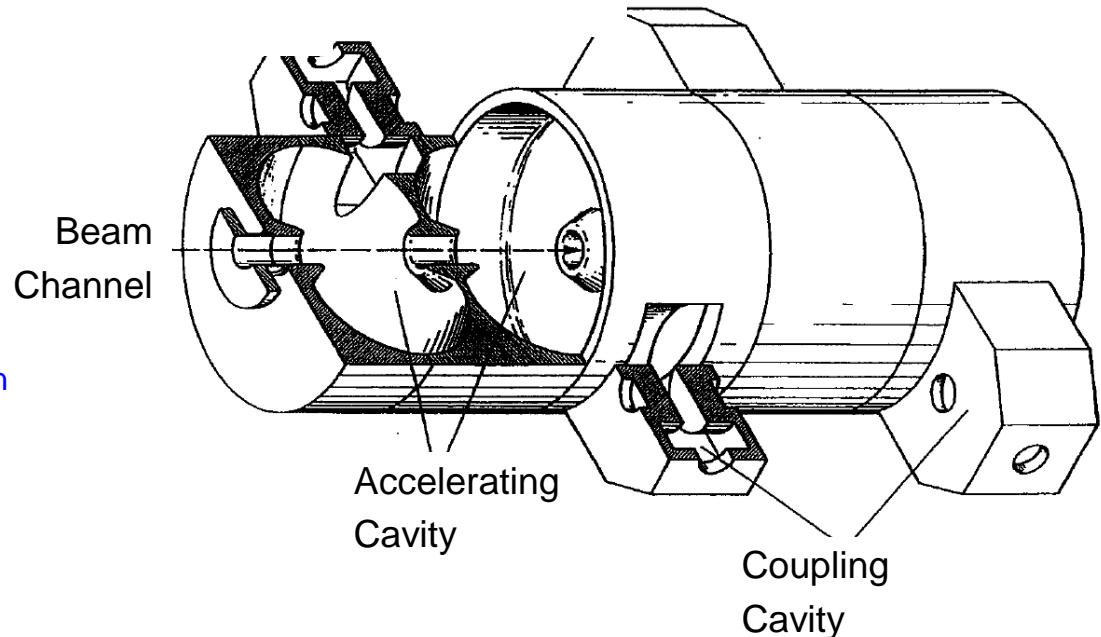
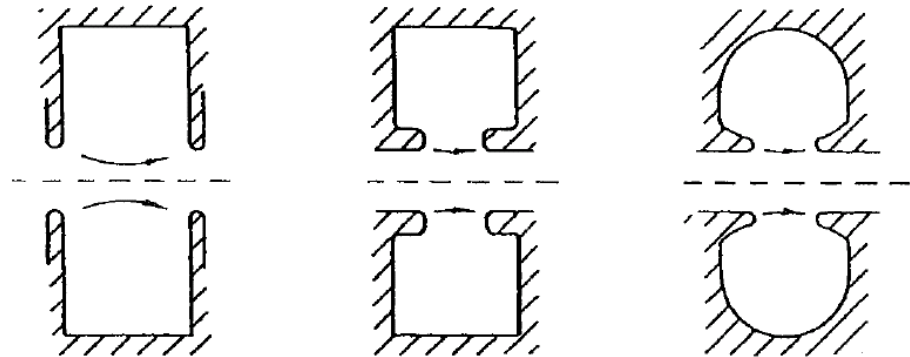

Multiple cell cavities

Source: E.A. Knapp and W Shlaer: Design and initial performance of a 20MeV high-current side-coupled cavity electron accelerator, 1968 Linac Conference Proceedings, p. 635 to 649

# The IH structure

- ◆ IH stands for Interdigital H mode
- ◆ Interleaved fingers “adapt” the deformed H (TE) mode that is usually deflecting
- ◆ Inside the resonator tank cylindrical cavity drift tubes of varying length (matching the ion velocity) are mounted alternating on opposite sides. The magnetic field lines are parallel to the beam axis and the induced currents flow azimuthally on the wall, creating electric fields of alternating direction between the drift tubes. This field forces the ions forward.
- ◆ The big pot is necessary for transverse focusing.

Properties of the structure on the right:  
 $E_{in} = 300 \text{ keV}$ ,  $E_{out} = 1.1\text{-}1.2 \text{ MeV}$   
Electrode voltage  $V_{eff} = 4.05 \text{ MV}$   
Tank length  $L = 1.5 \text{ m}$   
Number of gaps = 20  
Peak power consumption  $W_{peak} = 36 \text{ kW}$

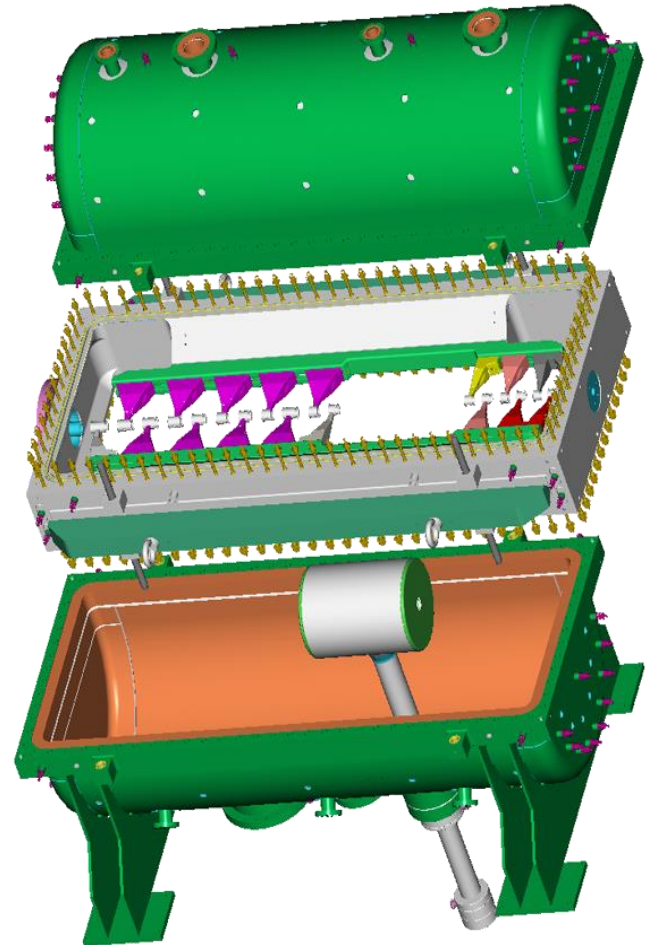

Source: [fy.chalmers.se/subatom/f2bfw/poster97\\_ps\\_pic/ihstructure.ppt](http://fy.chalmers.se/subatom/f2bfw/poster97_ps_pic/ihstructure.ppt)



# A disc loaded waveguide structure

CERN LIL (Linear Injector for LEP), operating frequency 2.98 GHz

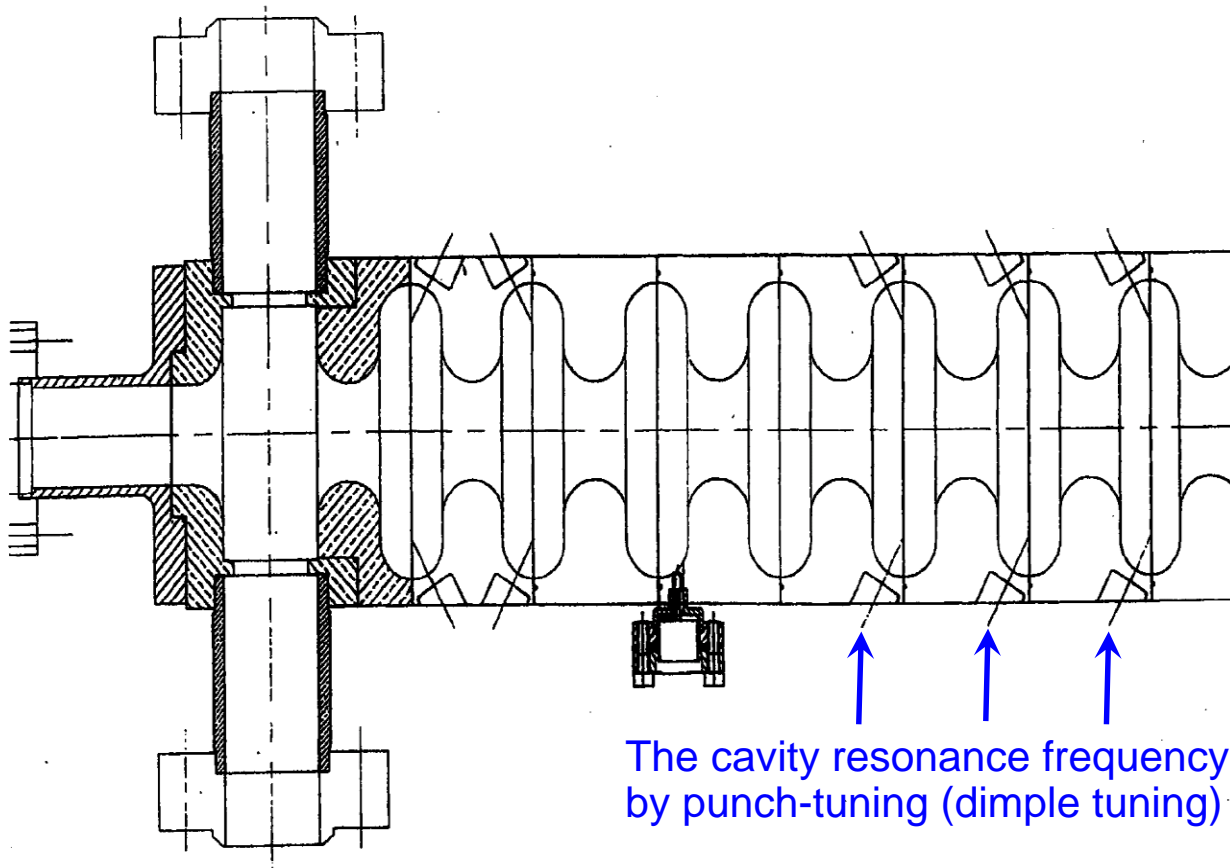

The cavity resonance frequency can be changed by punch-tuning (dimple tuning) at these spots.

# Voltage Standing Wave Ratio (1)

Origin of the term “**VOLTAGE** Standing Wave Ratio – VSWR”:

In the old days when there were no Vector Network Analyzers available, the reflection coefficient of some DUT (device under test) was determined with the coaxial measurement line.

Was is a coaxial measurement line?

This is a coaxial line with a narrow slot (slit) in length direction. In this slit a small voltage probe connected to a crystal detector (detector diode) is moved along the line. By measuring the ratio between the **maximum** and the **minimum voltage** seen by the probe and the recording the **position** of the maxima and minima the **reflection coefficient** of the DUT at the end of the line can be determined.

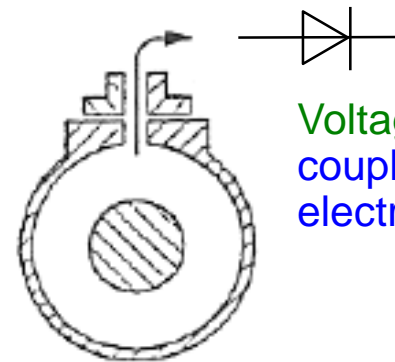
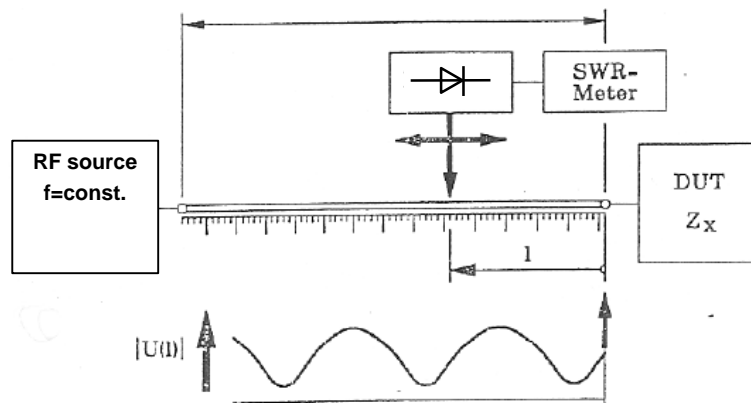

**Voltage probe** weakly coupled to the radial electric field.

Cross-section of the coaxial measurement line

# Voltage Standing Wave Ratio (2)

## VOLTAGE DISTRIBUTION ON LOSSLESS TRANSMISSION LINES

For an **ideally terminated** line the magnitude of voltage and current are **constant** along the line, their phase vary **linearly**.

In presence of a notable load reflection the voltage and current distribution along a transmission line are no longer uniform but exhibit characteristic ripples. The phase pattern resembles more and more to a staircase rather than a ramp.

A frequently used term is the “**Voltage Standing Wave Ratio VSWR**” that gives the ratio between maximum and minimum voltage along the line. It is related to load reflection by the expression

$$V_{\max} = |a| + |b| \quad V_{\min} = |a| - |b| \quad VSWR = \frac{V_{\max}}{V_{\min}} = \frac{|a| + |b|}{|a| - |b|} = \frac{1 + |\Gamma|}{1 - |\Gamma|}$$

Remember: the reflection coefficient  $\Gamma$  is defined via the **ELECTRIC FIELD** of the incident and reflected wave. This is historically related to the measurement method described here. We know that an open has a reflection coefficient of  $\Gamma=+1$  and the short of  $\Gamma=-1$ . When referring to the magnetic field it would be just opposite.

# Voltage Standing Wave Ratio (3)

$\Gamma$	VSWR	Refl. Power $ \Gamma ^2$
0.0	1.00	1.00
0.1	1.22	0.99
0.2	1.50	0.96
0.3	1.87	0.91
0.4	2.33	0.84
<b>0.5</b>	<b>3.00</b>	<b>0.75</b>
0.6	4.00	0.64
0.7	5.67	0.51
0.8	9.00	0.36
0.9	19	0.19
1.0	$\infty$	0.00

With a simple detector diode we cannot measure the phase, only the amplitude.

Why? – What would be required to measure the phase?

Answer: Because there is no reference. With a mixer which can be used as a phase detector when connected to a reference this would be possible.

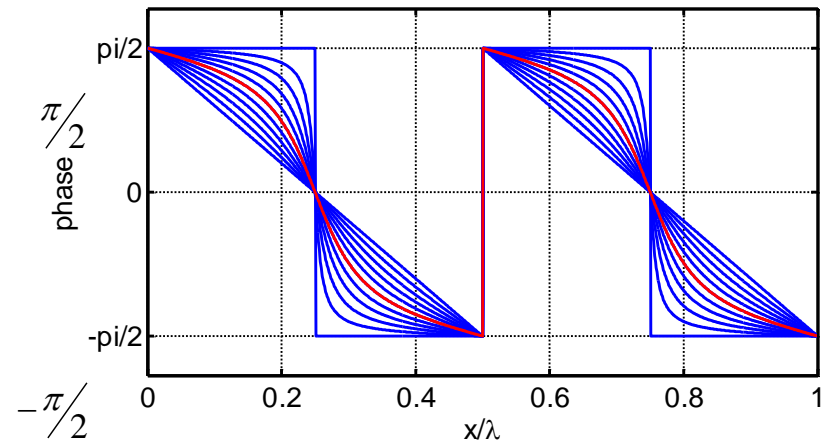
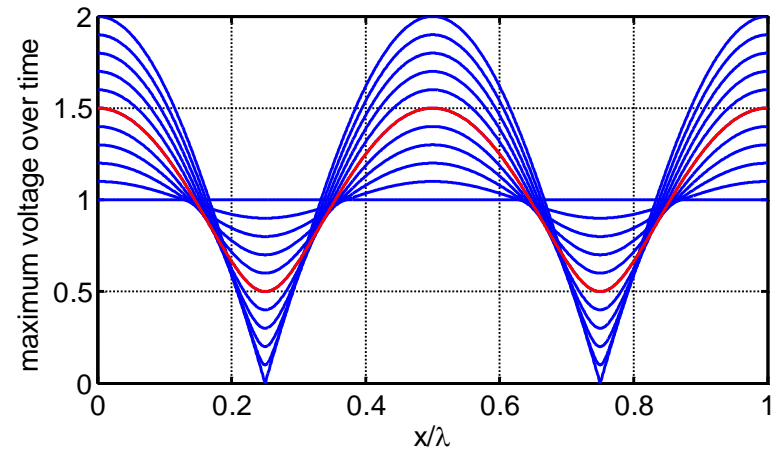

Watch a good old school “visualization” of waves and reflections:

<https://youtu.be/DovunOxIY1k>

# The Smith Chart (1)

The Smith Chart represents the complex  $\Gamma$ -plane within the unit circle. It is a conformal mapping of the complex  $Z$ -plane onto itself using the transformation

$$\Gamma = \frac{Z - Z_0}{Z + Z_0}$$

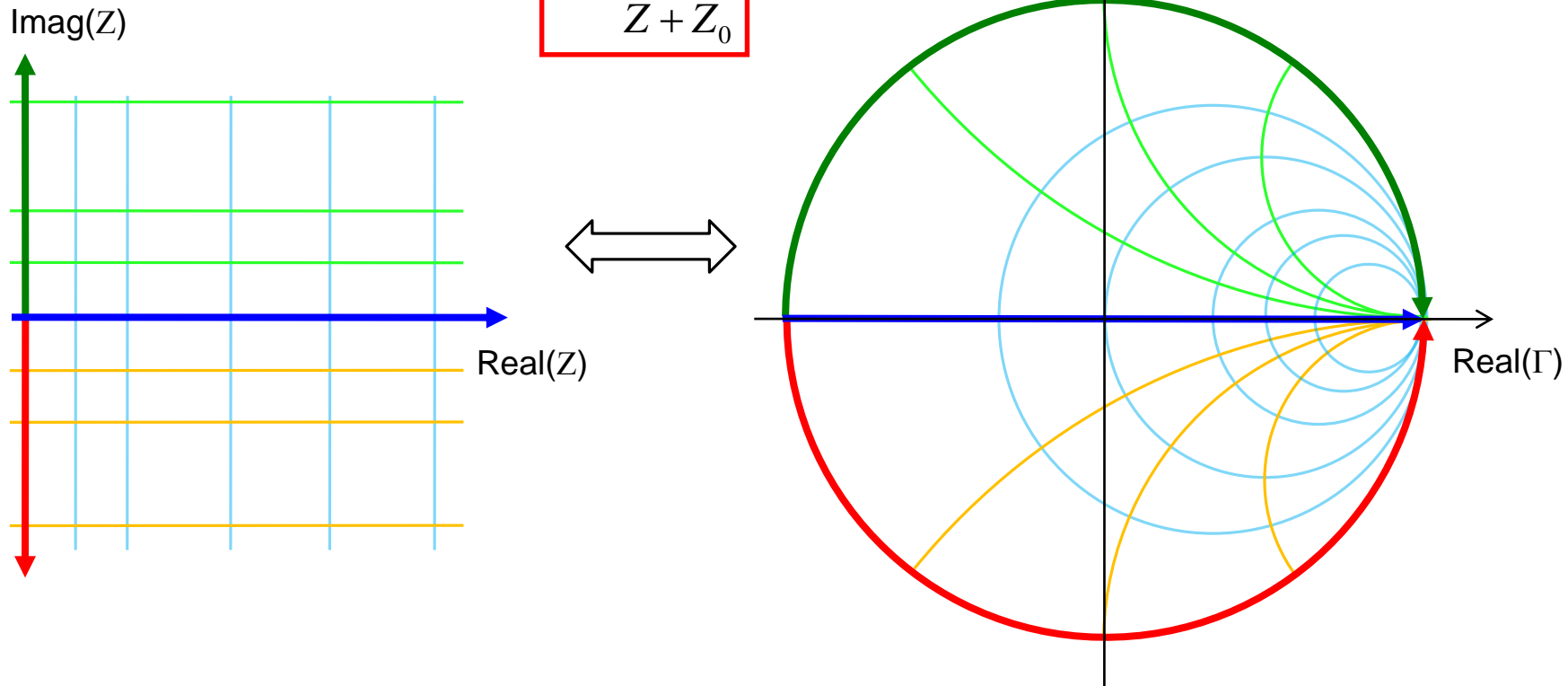

→ The real positive half plane of  $Z$  is thus transformed into the interior of the unit circle!

# The Smith Chart (2)

This is a “bilinear” transformation with the following properties:

- generalized circles are transformed into generalized circles
  - circle  $\rightarrow$  circle
  - straight line  $\rightarrow$  circle
  - circle  $\rightarrow$  straight line
  - straight line  $\rightarrow$  straight line
- angles are preserved locally

a straight line is nothing else than a circle with infinite radius

a circle is defined by 3 points

a straight line is defined by 2 points

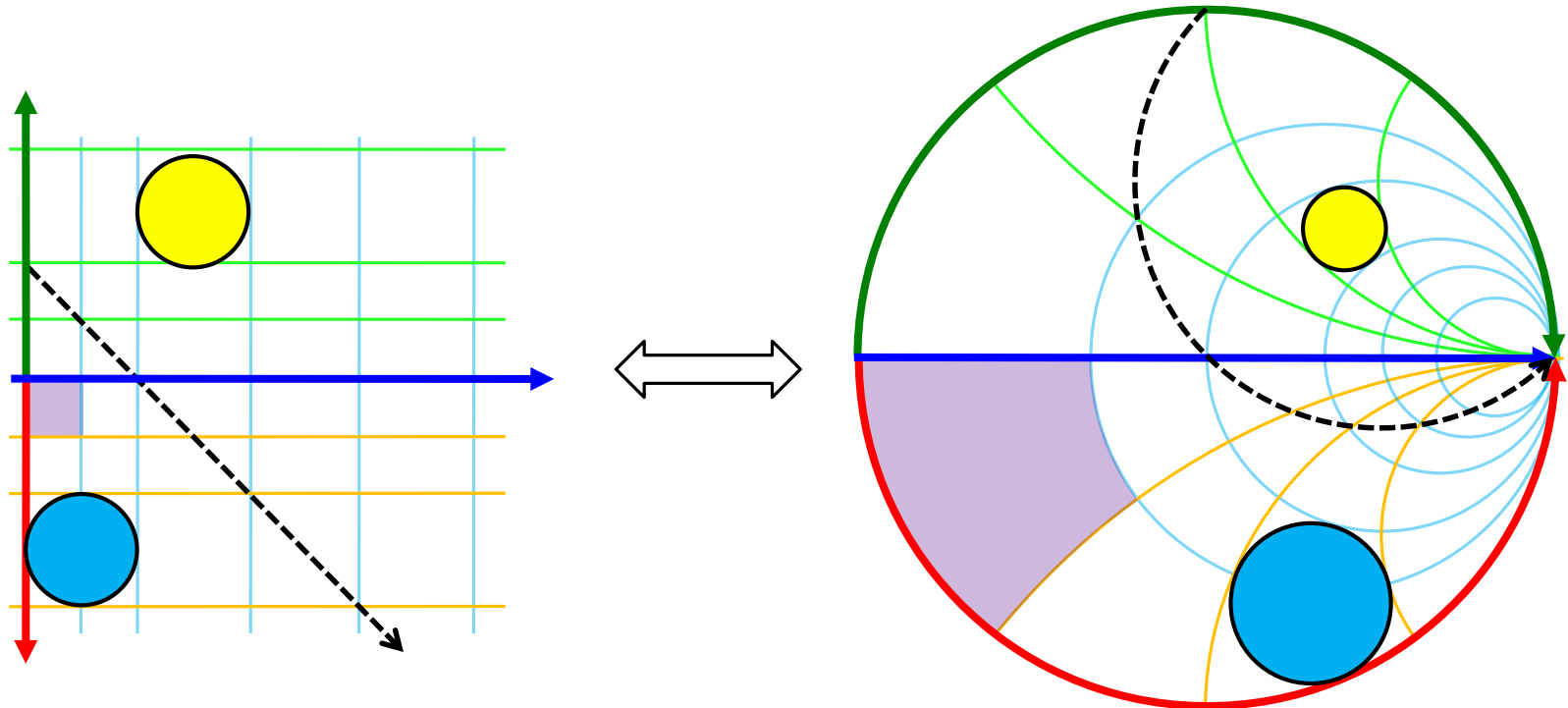

# The Smith Chart (3)

Impedances  $Z$  are usually first normalized by  $z = \frac{Z}{Z_0}$

where  $Z_0$  is some characteristic impedance (e.g. 50 Ohm). The general form of the transformation can then be written as

$$\Gamma = \frac{z-1}{z+1} \quad \text{resp.} \quad z = \frac{1+\Gamma}{1-\Gamma}$$

This mapping offers several practical advantages:

1. The diagram includes all “passive” impedances, i.e. those with positive real part, **from zero to infinity** in a handy format. Impedances with negative real part (“active device”, e.g. reflection amplifiers) would be outside the (normal) Smith chart.
2. The mapping converts impedances or admittances into reflection factors and vice-versa. This is particularly interesting for studies in the radiofrequency and microwave domain where electrical quantities are usually expressed in terms of “**direct**” or “**forward**” waves and “**reflected**” or “**backward**” waves. This replaces the notation in terms of currents and voltages used at lower frequencies. Also the reference plane can be moved very easily using the Smith chart.

# The Smith Chart (4)

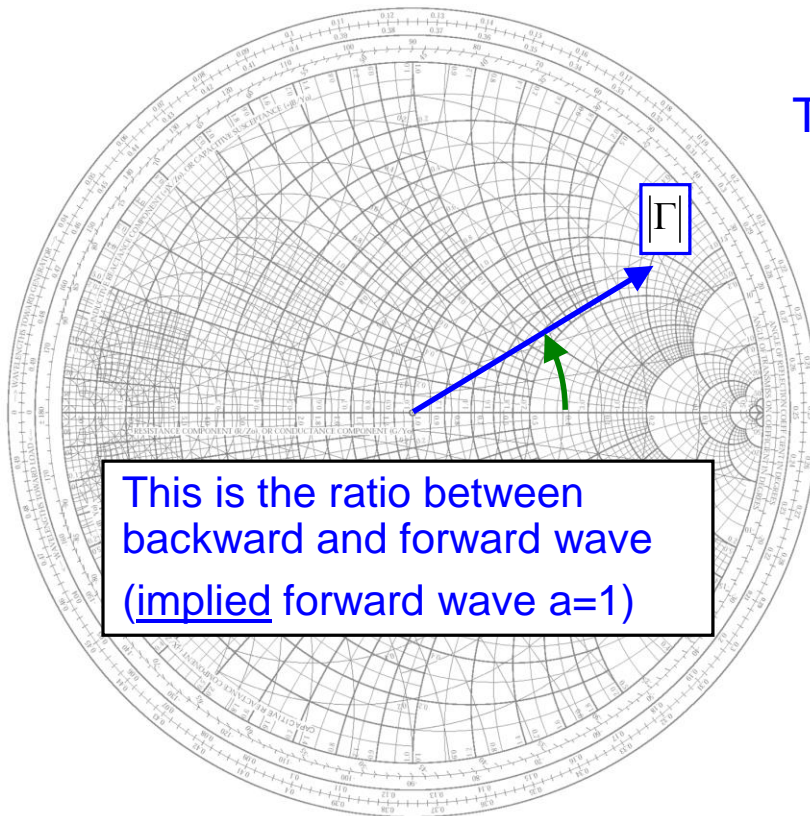

The Smith Chart (*Abaque Smith* in French) is the linear representation of the complex reflection factor

$$\Gamma = \frac{b}{a}$$

i.e. the ratio backward/forward wave.

The upper half of the Smith-Chart is “inductive” = positive imaginary part of impedance, the lower half is “capacitive” = negative imaginary part.



# Important points

## Important Points:

- ◆ Short Circuit  
 $\Gamma = -1, z = 0$
- ◆ Open Circuit  
 $\Gamma = 1, z \rightarrow \infty$
- ◆ Matched Load  
 $\Gamma = 0, z = 1$
- ◆ On circle  $\Gamma = 1$   
lossless element
- ◆ Outside circle  $\Gamma = 1$   
active element, for instance tunnel diode reflection amplifier

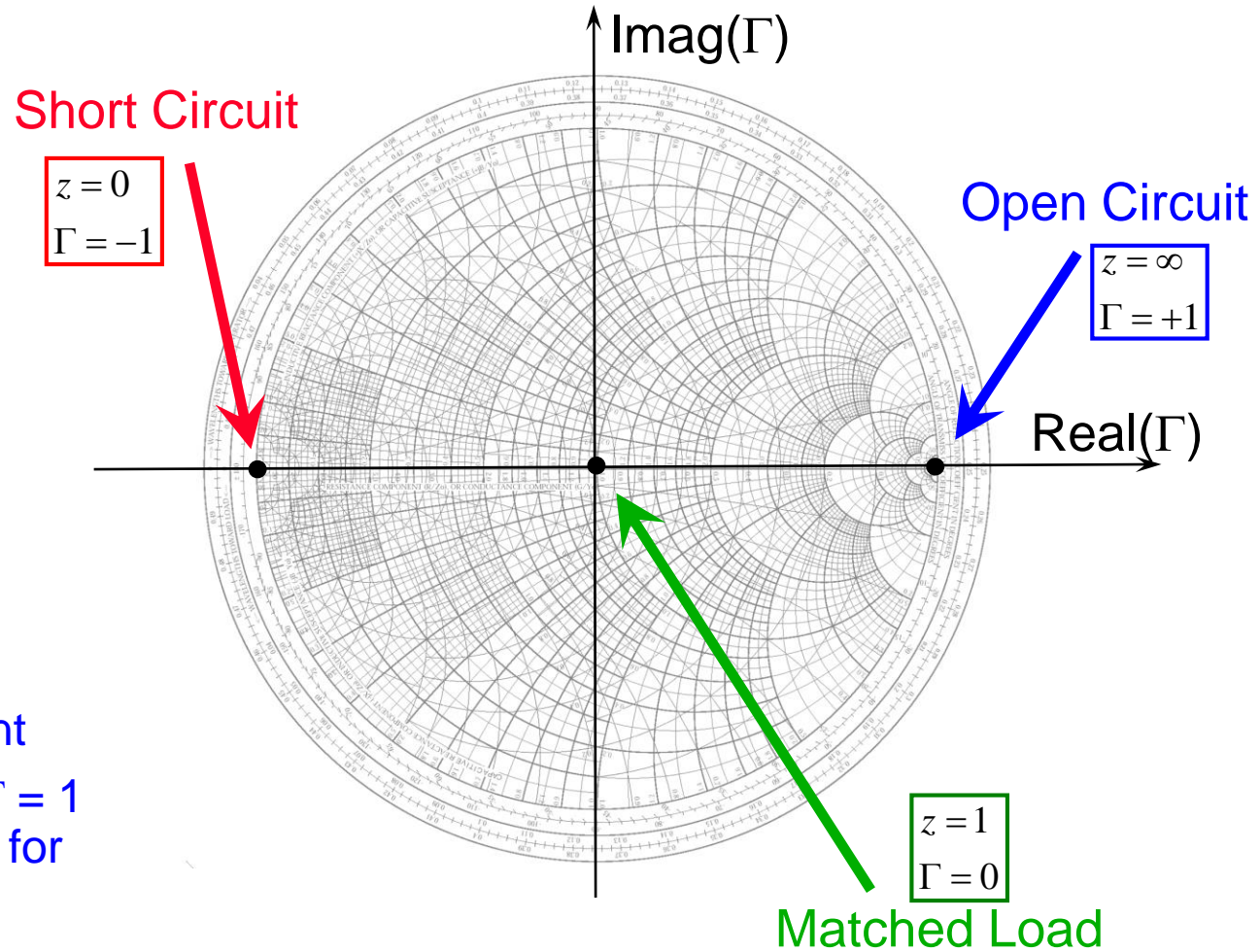

# The Smith Chart (5)

3. The distance from the center of the diagram is directly proportional to the magnitude of the reflection factor. In particular, the perimeter of the diagram represents full reflection,  $|\Gamma|=1$ . Problems of matching are clearly visualize.

Power into the load = forward power – reflected power

$$P = |a|^2 - |b|^2$$
$$= |a|^2 (1 - |\Gamma|^2)$$

max source  
power

“(mismatch)”  
loss

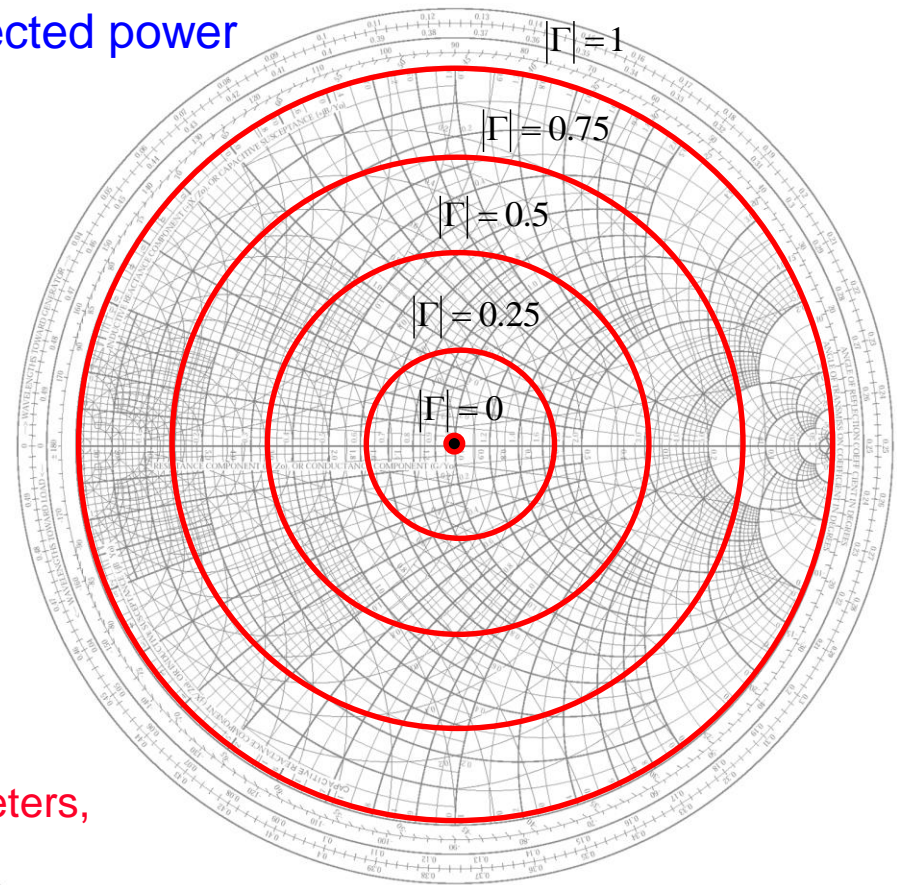

Here the US notion is used, where power =  $|a|^2$ .  
European notation (often): power =  $|a|^2/2$   
These conventions have no impact on S parameters,  
only relevant for absolute power calculation

# The Smith Chart (6)

## 4. The transition

impedance  $\Leftrightarrow$  admittance  
and vice-versa is particularly easy.

$$\Gamma(1/z) = \frac{1/z - 1}{1/z + 1} = \frac{1 - z}{1 + z} = -\left(\frac{z - 1}{z + 1}\right)$$

$$\underline{\Gamma(1/z) = -\Gamma(z)}$$

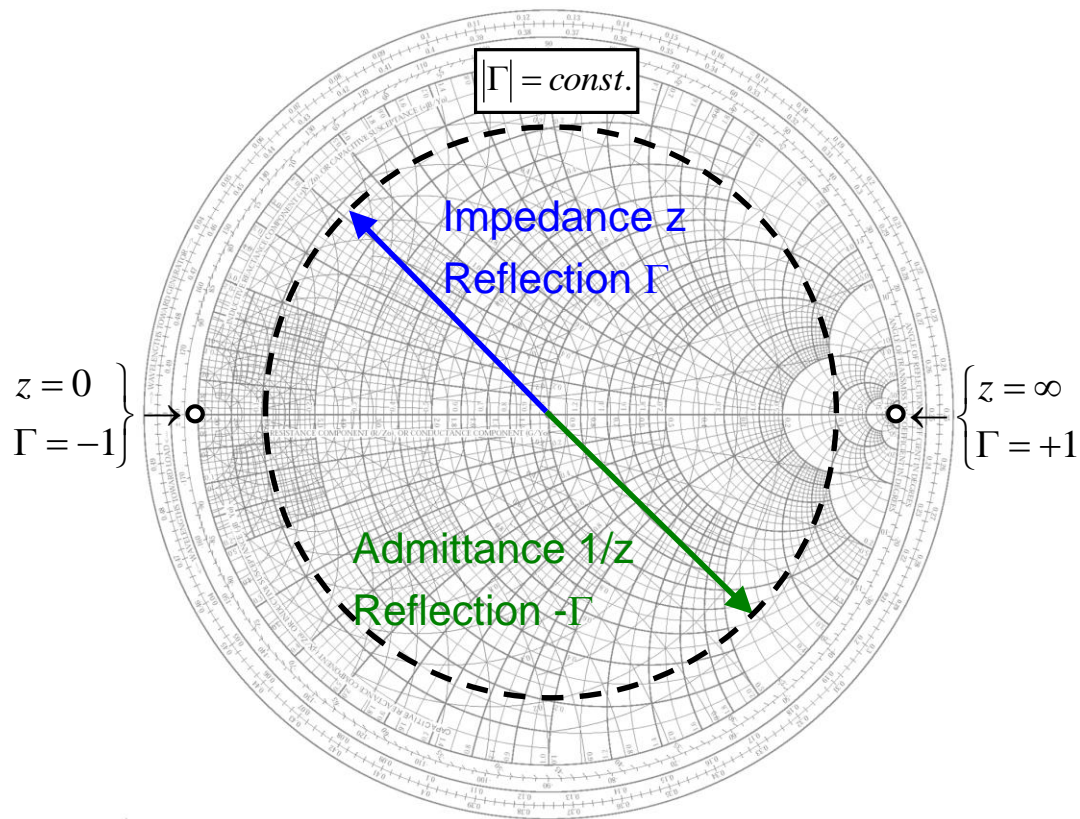

# Navigation in the Smith Chart (1)

in red: Impedance plane ( $=Z$ )

in blue: Admittance plane ( $=Y$ )

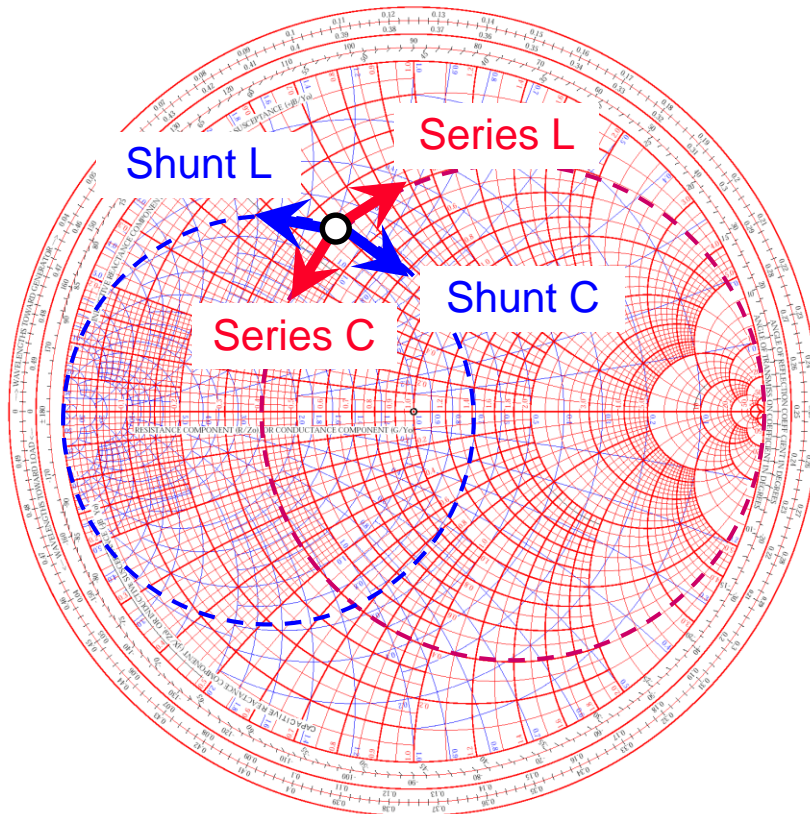

	CW	CCW
Red circles	Series L	Series C
Blue circles	Shunt C	Shunt L

# Navigation in the Smith Chart (2)

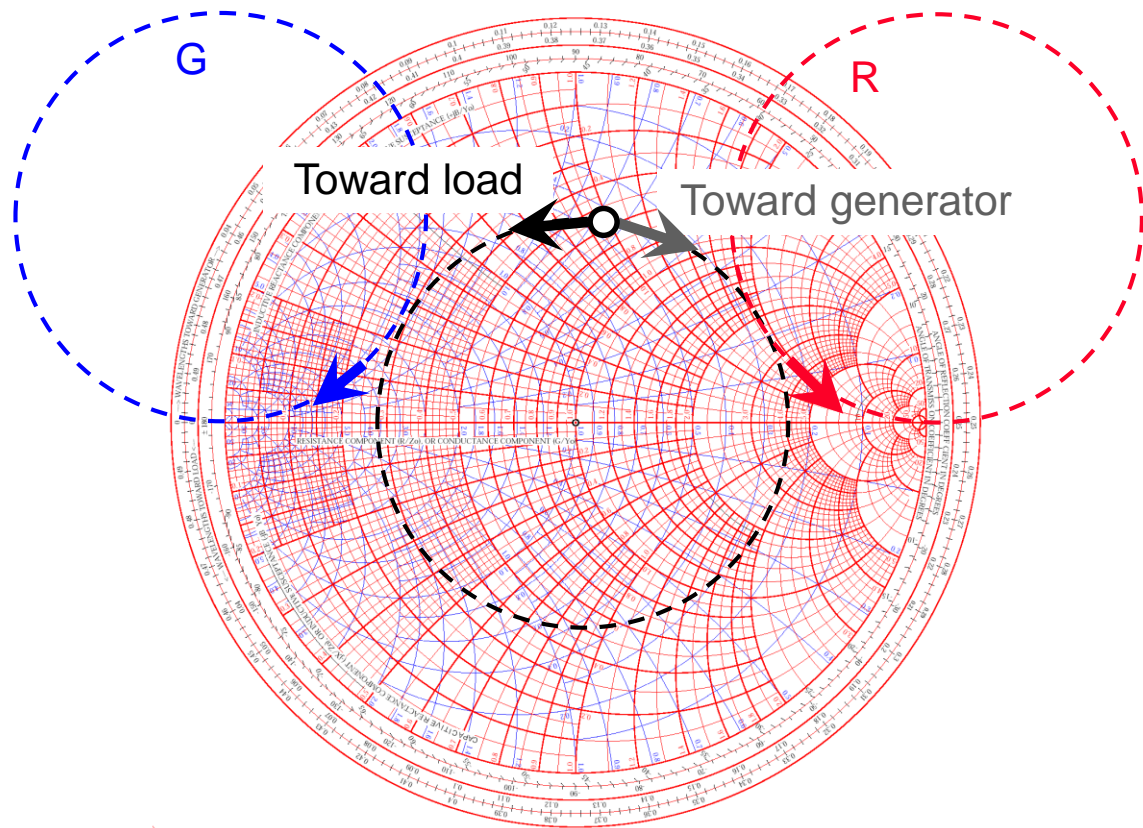

Red arcs	Resistance R
Blue arcs	Conductance G
Concentric circle	Transmission line going Toward load Toward generator

# Impedance transformation by transmission lines

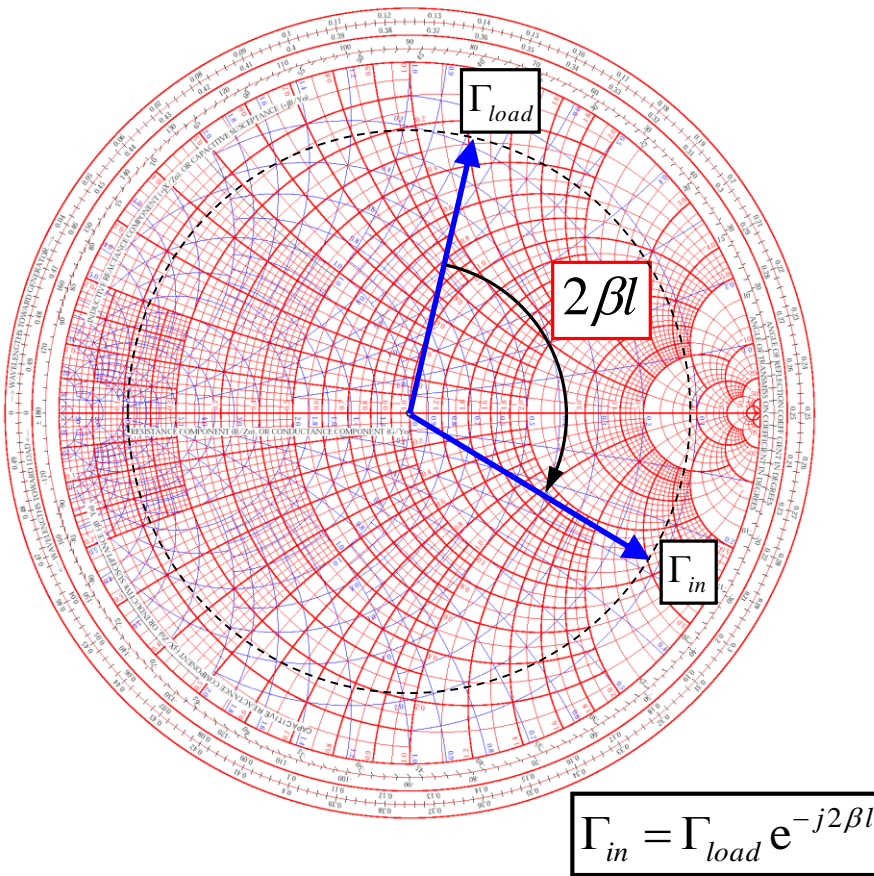

The S-matrix for an ideal, lossless transmission line of length  $l$  is given by

$$\mathbf{S} = \begin{bmatrix} 0 & e^{-j\beta l} \\ e^{-j\beta l} & 0 \end{bmatrix}$$

where  $\beta = 2\pi / \lambda$

is the propagation coefficient with the wavelength  $\lambda$  (this refers to the wavelength on the line containing some dielectric).

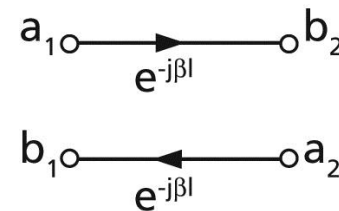

N.B.: It is supposed that the reflection factors are evaluated with respect to the characteristic impedance  $Z_0$  of the line segment.

How to remember that when adding a section of line we have to turn clockwise: assume we are at  $\Gamma = -1$  (short circuit) and add a very short piece of coaxial cable. Then we have made an inductance thus we are in the upper half of the Smith-Chart.

# $\lambda/4$ - Line transformations

A transmission line of length

$$l = \lambda/4$$

transforms a load reflection  $\Gamma_{load}$  to its input as

$$\Gamma_{in} = \Gamma_{load} e^{-j2\beta l} = \Gamma_{load} e^{-j\pi} = \underline{-\Gamma_{load}}$$

This means that normalized load impedance  $z$  is transformed into  $1/z$ .

In particular, a short circuit at one end is transformed into an open circuit at the other. This is the principle of  $\lambda/4$ -resonators.

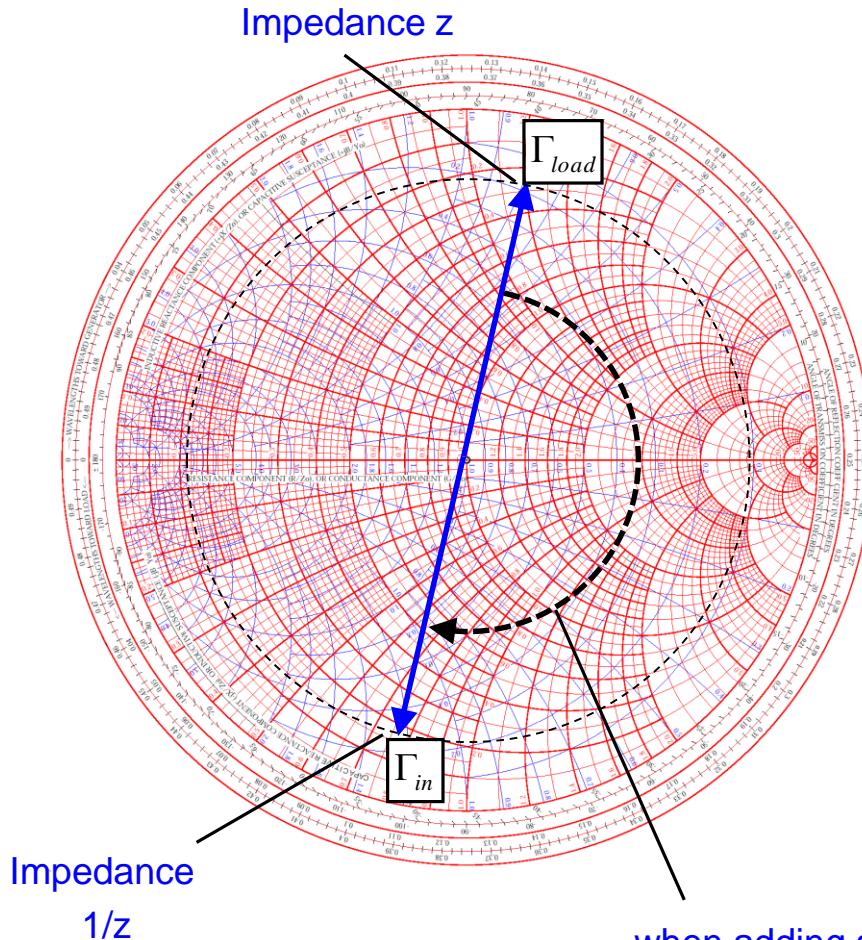

when adding a transmission line to some terminating impedance we move clockwise through the Smith-Chart.

# Example: a Step in Characteristic Impedance (1)

Consider a connection of two coaxial cables, one with  $Z_{C,1} = 50 \Omega$  characteristic impedance, the other with  $Z_{C,2} = 75 \Omega$  characteristic impedance.

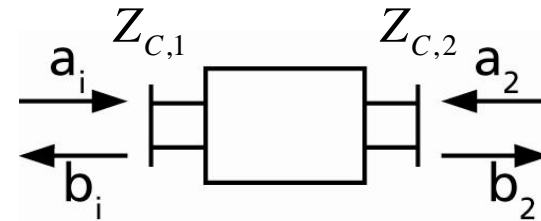
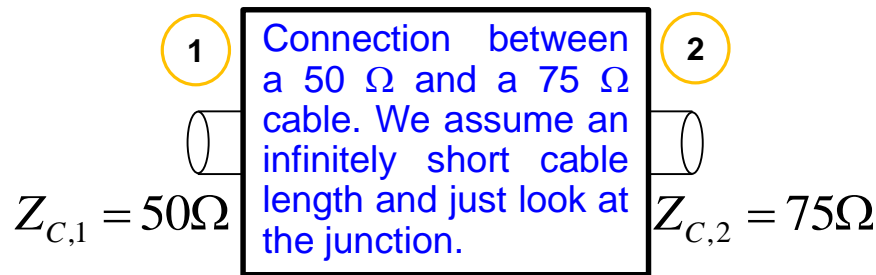

Step 1: Calculate the reflection coefficient and keep in mind: all ports have to be terminated with their respective characteristic impedance, i.e.  $75 \Omega$  for port 2.

$$\Gamma_1 = \frac{Z - Z_{C,1}}{Z + Z_{C,1}} = \frac{75 - 50}{75 + 50} = 0.2$$

Thus, the voltage of the reflected wave at port 1 is 20% of the incident wave and the reflected power at port 1 (proportional  $\Gamma^2$ ) is  $0.2^2 = 4\%$ . As this junction is lossless, the transmitted power must be 96% (conservation of energy). From this we can deduce  $b_2^2 = 0.96$ . **But: how do we get the voltage of this outgoing wave?**



# Example: a Step in Characteristic Impedance (2)

Step 2: Remember, a and b are **power-waves** and defined as voltage of the forward- or backward travelling wave normalized to  $\sqrt{Z_c}$ .

The tangential electric field in the dielectric in the 50  $\Omega$  and the 75  $\Omega$  line, respectively, must be continuous.

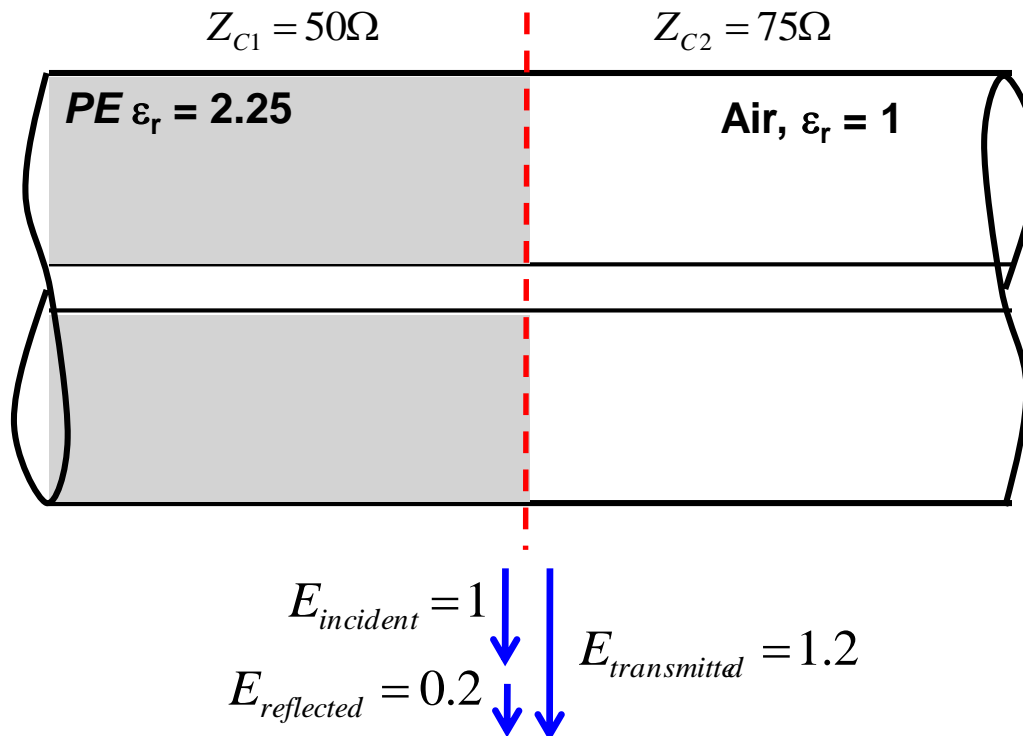

t = voltage transmission coefficient  $t = 1 + \Gamma$  in this case.

This is counterintuitive, one might expect  $1 - \Gamma$ . Note that the voltage of the transmitted wave is higher than the voltage of the incident wave. But we have to normalize to  $\sqrt{Z_c}$  to get the corresponding S-parameter.  $S_{12} = S_{21}$  via reciprocity! But  $S_{11} \neq S_{22}$ , i.e. the structure is **NOT** symmetric.

# Example: a Step in Characteristic Impedance (3)

Once we have determined the voltage transmission coefficient, we have to normalize to the ratio of the characteristic impedances, respectively. Thus we get for

$$S_{12} = 1.2 \sqrt{\frac{50}{75}} = 1.2 \cdot 0.816 = 0.9798$$

We know from the previous calculation that the reflected power (proportional  $\Gamma^2$ ) is 4% of the incident power. Thus 96% of the power are transmitted.

Check done  $S_{12}^2 = 1.44 \frac{1}{1.5} = 0.96 = (0.9798)^2$

$$S_{22} = \frac{50 - 75}{50 + 75} = -0.2 \quad \text{To be compared with } S_{11} = +0.2!$$

# Example: a Step in Characteristic Impedance (4)

Visualization in the Smith chart

As shown in the previous slides the voltage of the transmitted wave is with

$$V_t = 1 + \Gamma$$

$V_t = a + b$  and subsequently the current is  $I_t Z = a - b$ .

Remember: the reflection coefficient  $\Gamma$  is defined with respect to voltages. For currents the sign inverts. Thus a positive reflection coefficient in the normal definition leads to a subtraction of currents or is negative with respect to current.

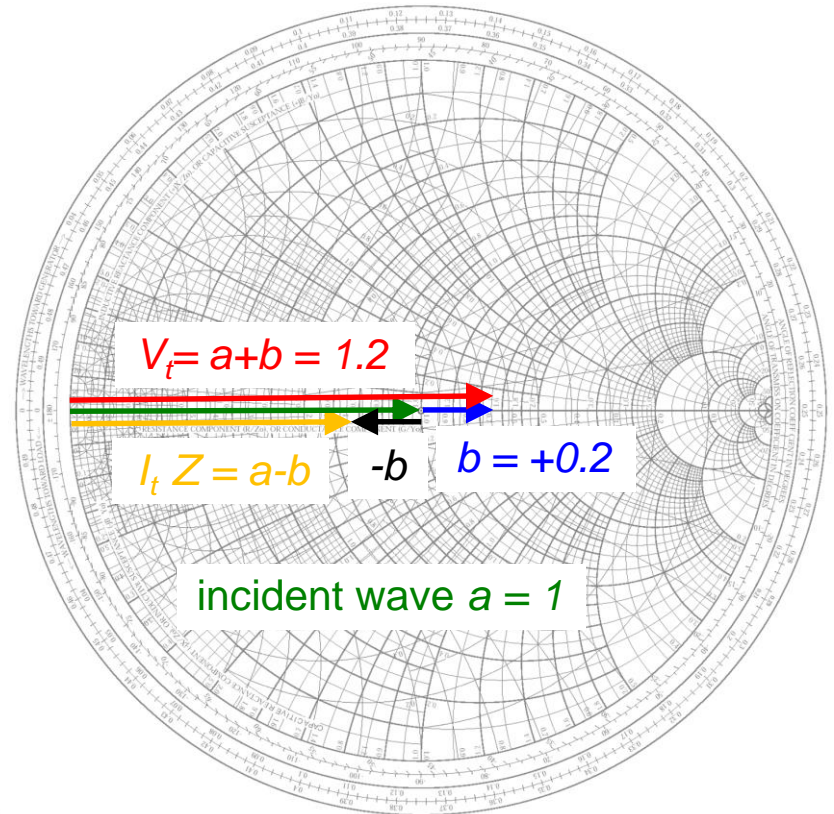

Note: here  $Z_{\text{load}}$  is real

# Example: a Step in Characteristic Impedance (5)

General case

Thus we can read from the Smith chart immediately the amplitude and phase of voltage and current on the load (of course we can calculate it when using the complex voltage divider).

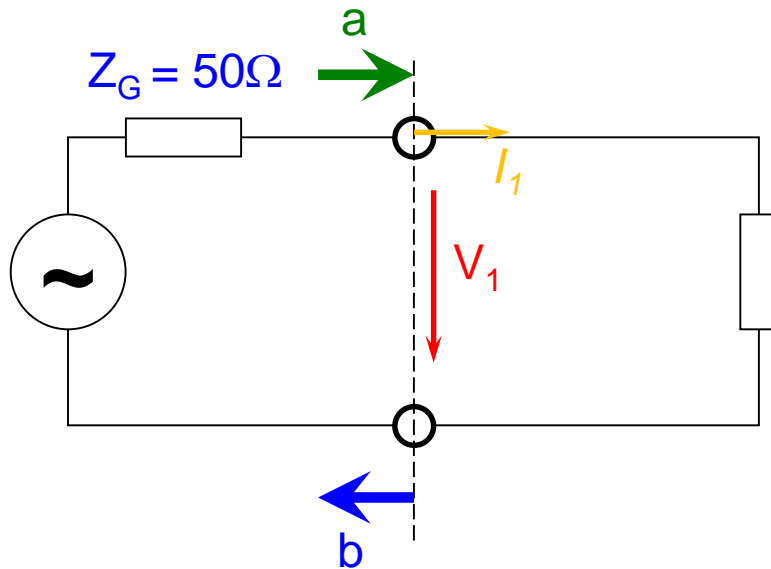

$Z = 50 + j80\Omega$   
(load impedance)

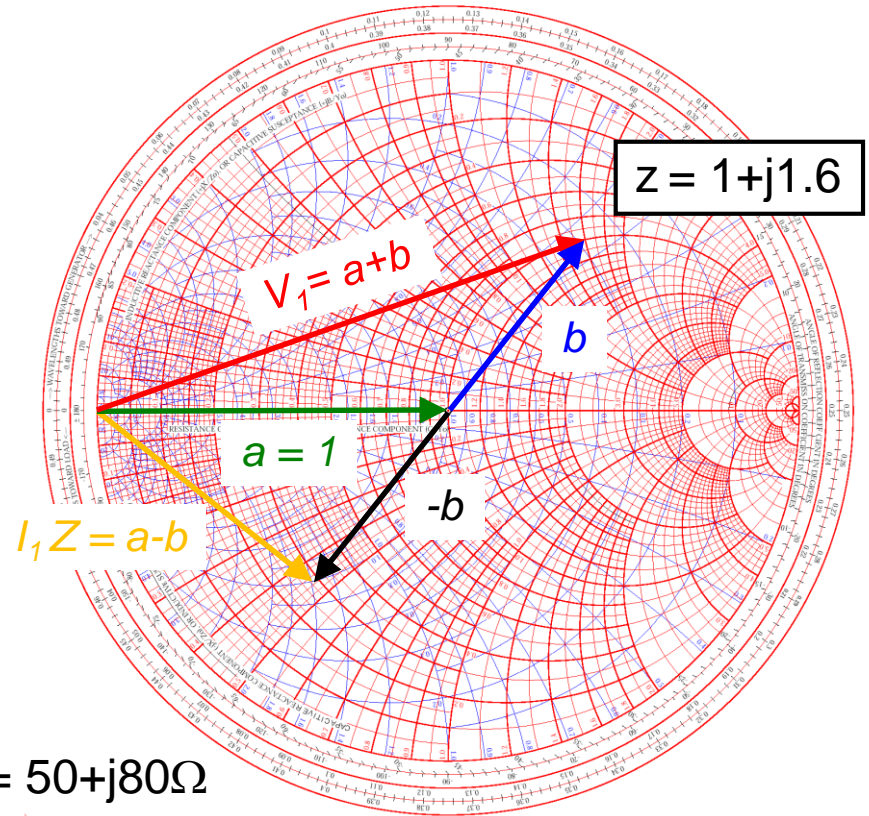

$z = 1 + j1.6$

$V_1 = a + b$

$a = 1$

$b$

$-b$

$I_1 Z = a - b$

# Simulation results of a 1 MHz resonator

Cavity response vs. frequency  
Top: logarithmic magnitude  
Bottom: phase

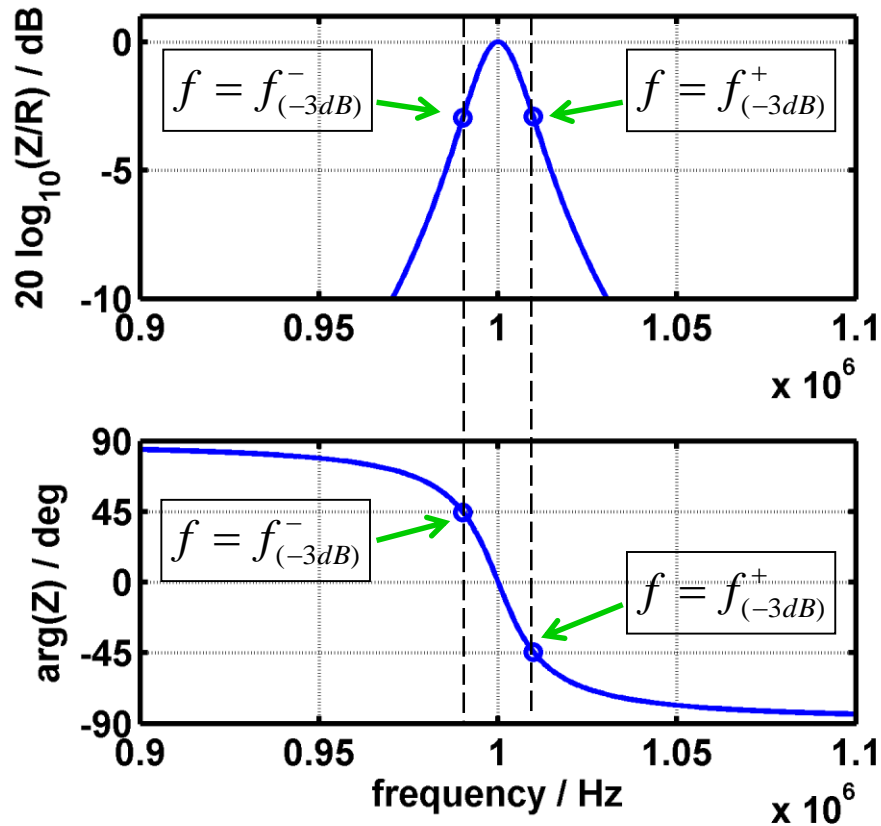

Data represented in Smith Chart

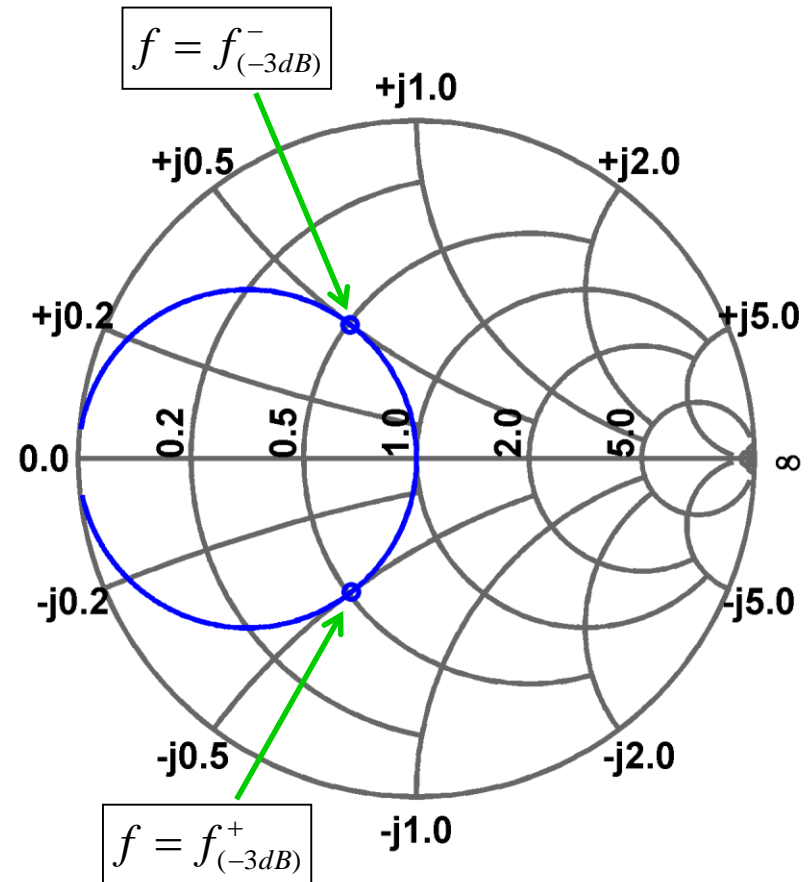

Shown is the model of a Ferrite loaded cavity:  
 $R=200 \text{ k}\Omega$ ,  $Q=50$ ,  $f_{\text{res}}=1 \text{ MHz}$

# Example: Measurement of Q with VNA in Reflection

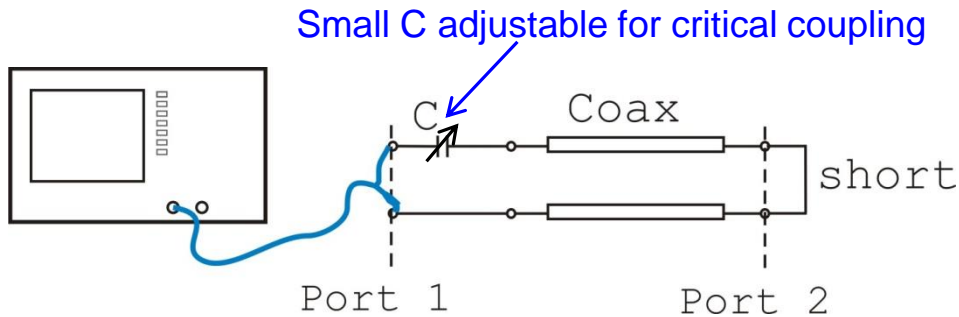

- ◆ But how?
- ◆ This is the recipe:
  - Get the resonance frequency and read out the 3dB-points
  - Calculate  $Q = f_{res}/\Delta f$ .

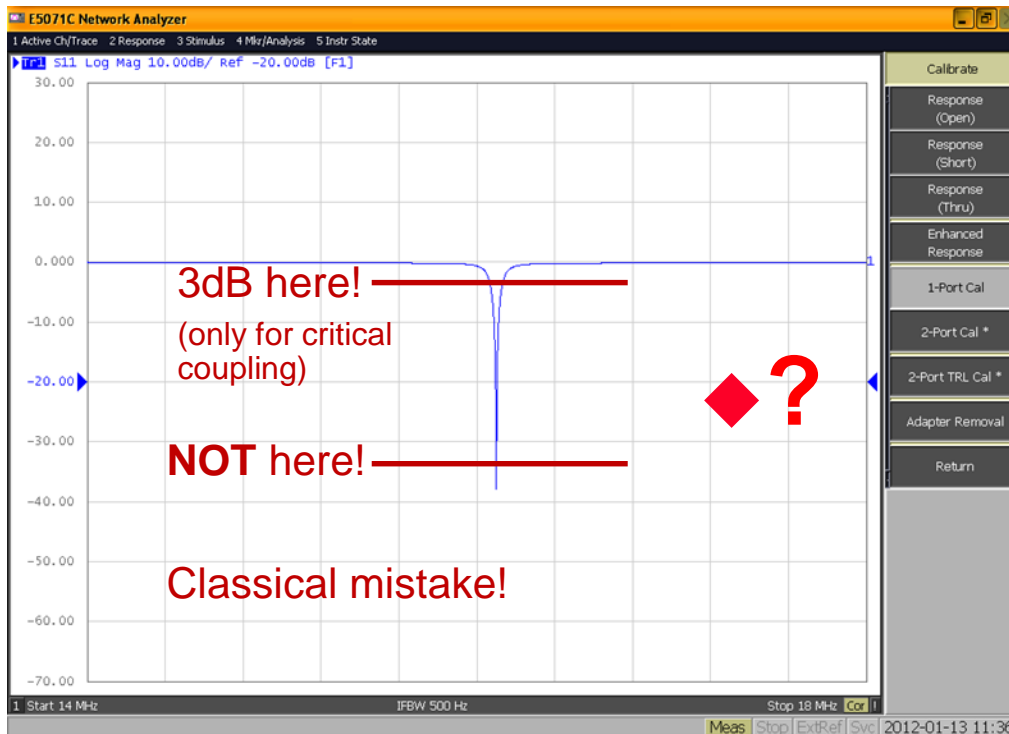

◆ Ooops? Not so straightforward?



# Example: Determination of Q in the Smith chart (1)

- ◆ This is “our” recipe: Put your network analyzer display format in Smith-chart.

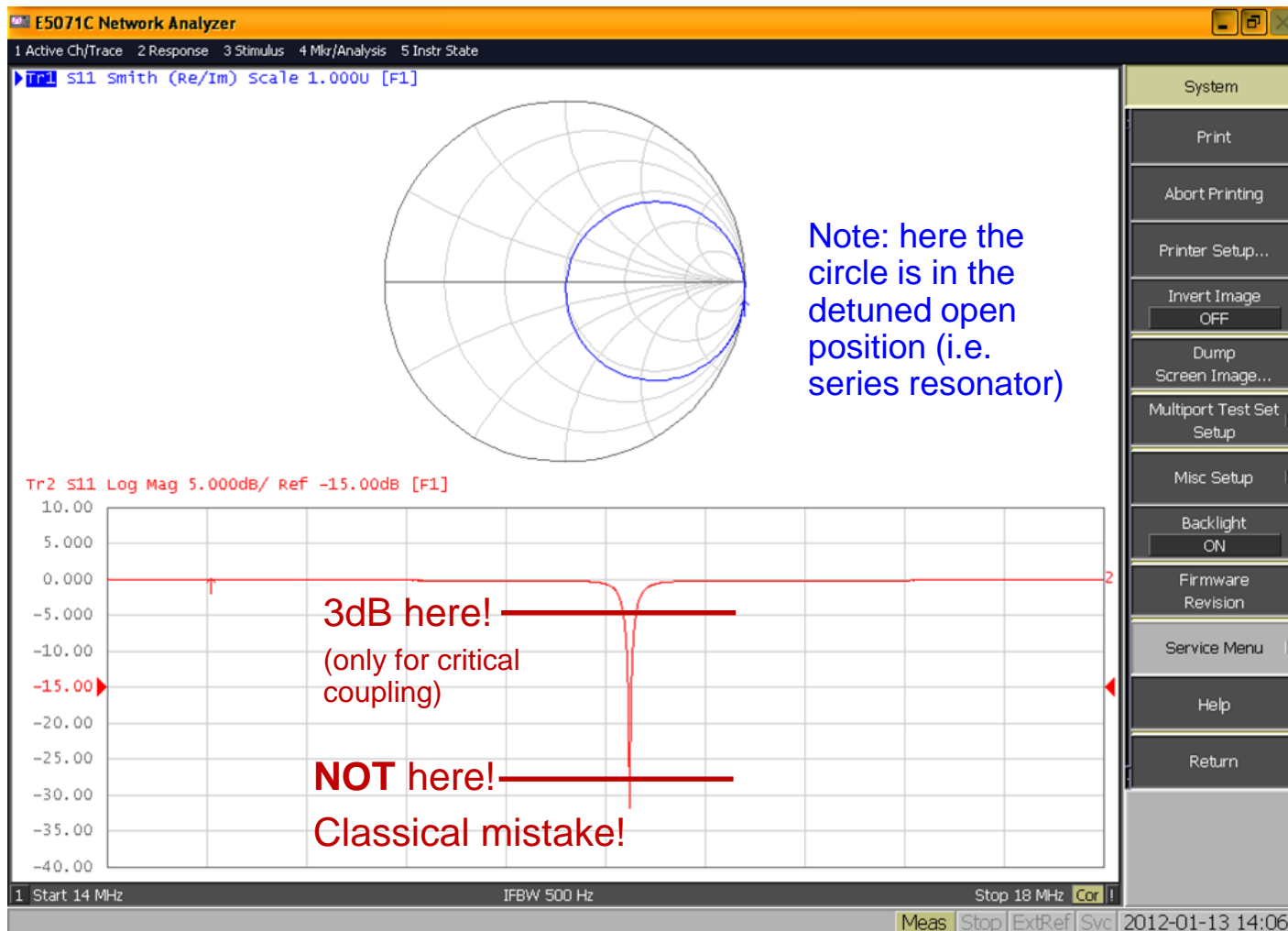

# Example: Determination of Q in the Smith chart (2)

2. Move your graph in the Smith-chart to the so-called “detuned short position”.
3. For this, you display the imaginary part of  $S_{11}$  in Cartesian coordinates (lower part of the display) and change the phase offset and electrical delay such that the graph is symmetric to the abscissa and horizontal.  
Hint: Put Markers on the plot to make sure that your graph is symmetric

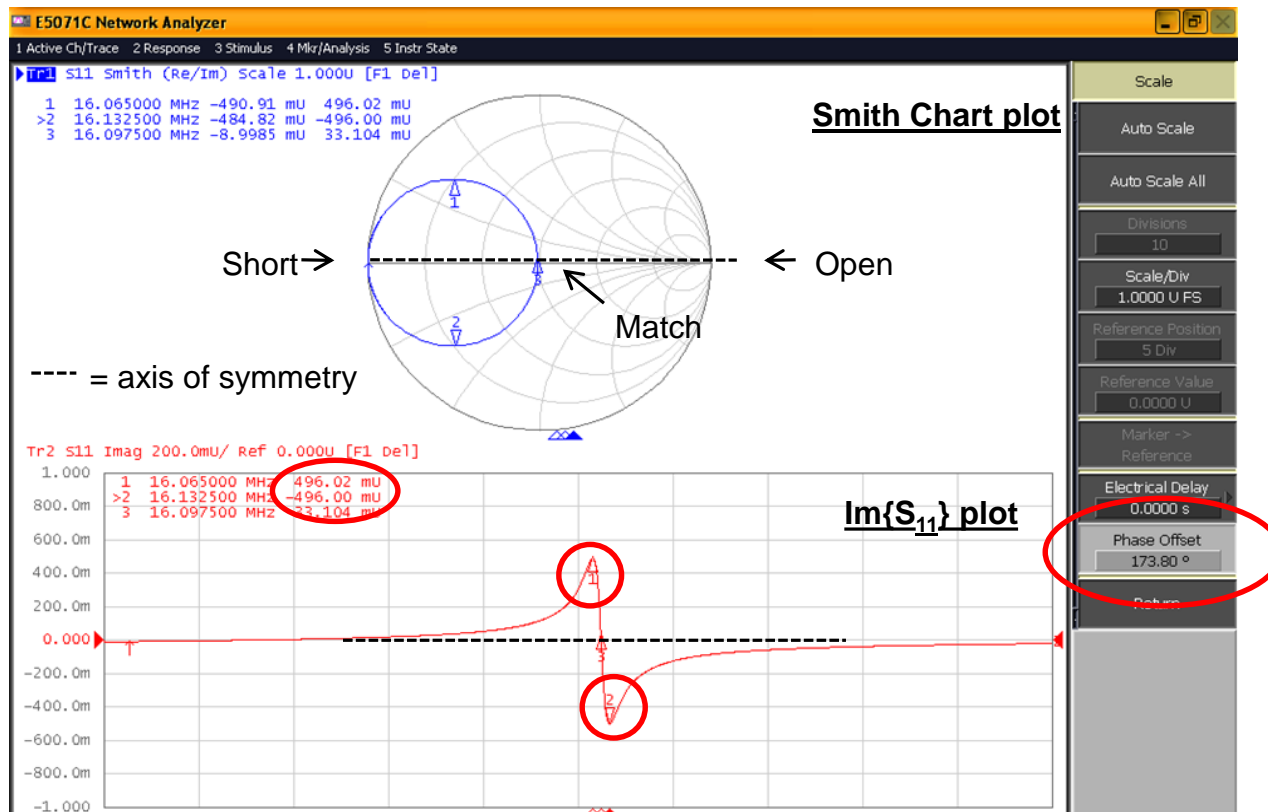



# Example: Determination of Q in the Smith chart (3)

3. Use **markers** (in  $S_{11}$  format) in the Smith-chart to read out the frequencies at points **(1)** and **(2)**, in the upper and lower halves of the circle, this is the **maximum of  $|\text{Im}\{S_{11}\}|$** .
4. Calculate the difference in frequency  $\Delta f$ , this is the 3 dB bandwidth of the loaded cavity.
5. Read-out the resonant frequency  $f_{\text{res}}$  at point **(3)**
4. Now your formulae will give you the loaded Q:  $Q_L = f_{\text{res}}/\Delta f$ .

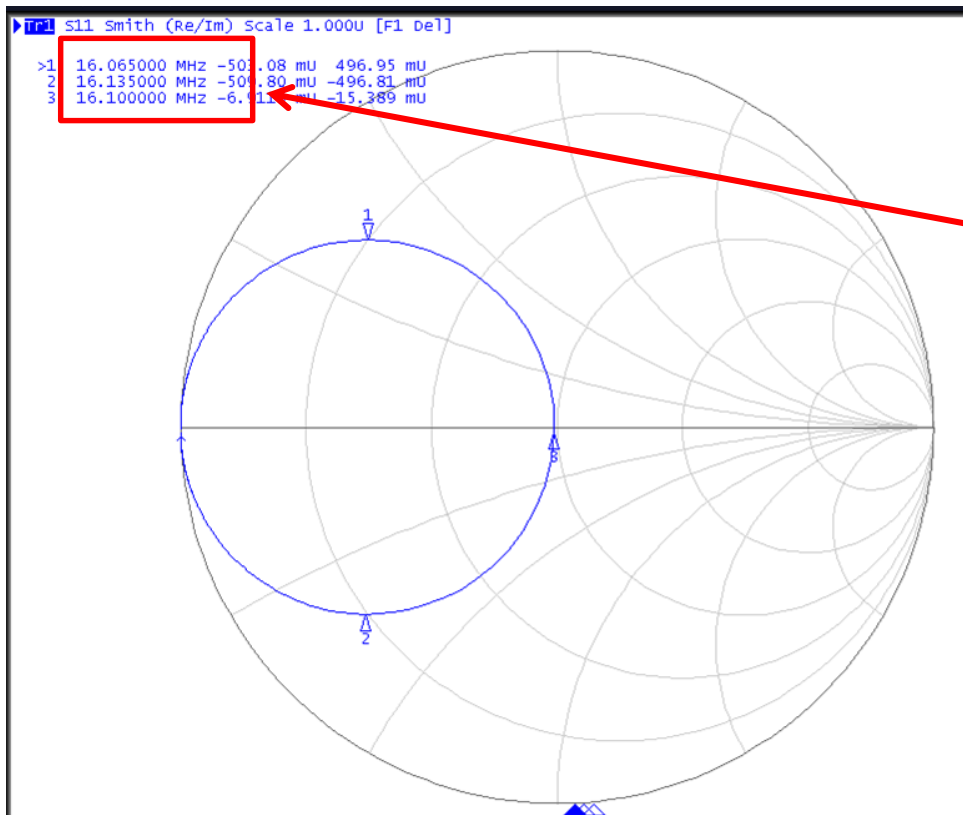

Here:

$$Q_L = 16.1 \text{ MHz} / 70 \text{ kHz}$$

$$Q_L = 230$$

Note:

to determine the unloaded  $Q_0$ , the condition for placing the markers (in impedance format) in Step 3 is:

$$\text{Im}\{Z\} = \text{Re}\{Z\}$$

All other steps stay the same.

# What about all these rulers below the Smith chart (1)

How to use these rulers:

You take the modulus of the reflection coefficient of an impedance to be examined by some means, either with a conventional ruler or better take it into the compass. Then refer to the coordinate denoted to CENTER and go to the left or for the other part of the rulers (not shown here in the magnification) to the right except for the lowest line which is marked ORIGIN at the left.

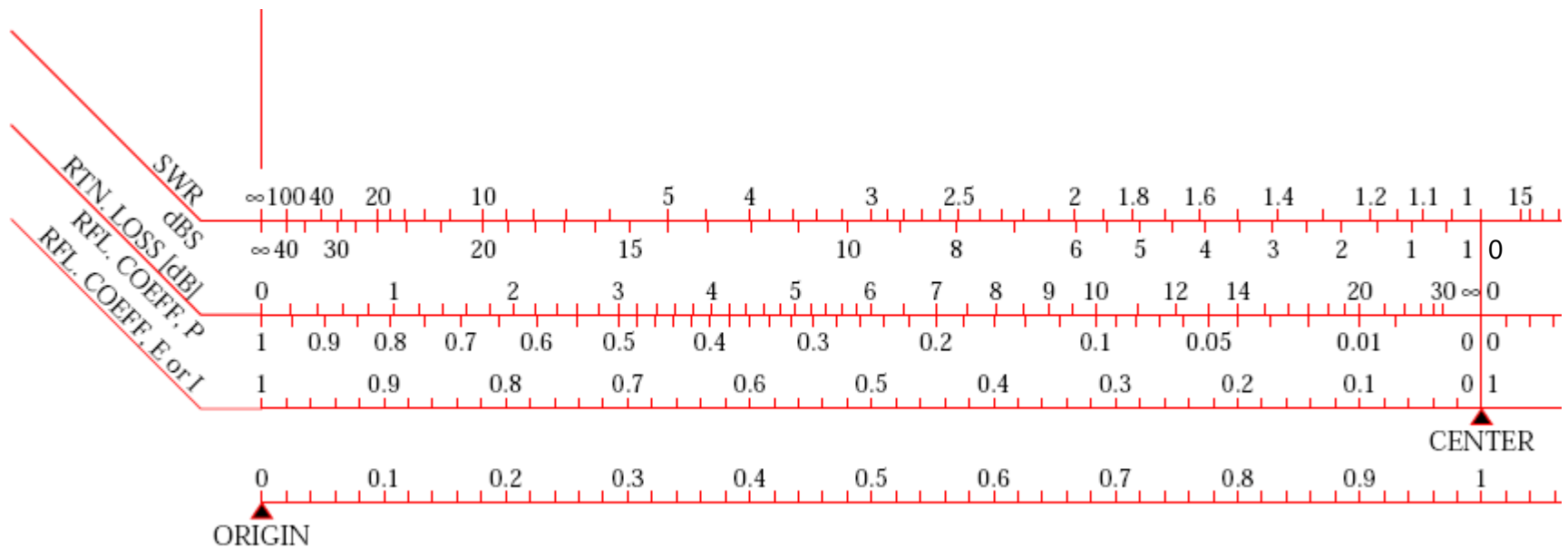

# What about all these rulers below the Smith chart (2)

First ruler / left / upper part, marked SWR. This means VSWR, i.e. Voltage Standing Wave Ratio, the range of value is between one and infinity. One is for the matched case (center of the Smith chart), infinity is for total reflection (boundary of the SC). The upper part is in linear scale, the lower part of this ruler is in dB, noted as dBS (dB referred to Standing Wave Ratio). Example: SWR = 10 corresponds to 20 dBS, SWR = 100 corresponds to 40 dBS [voltage ratios, not power ratios].

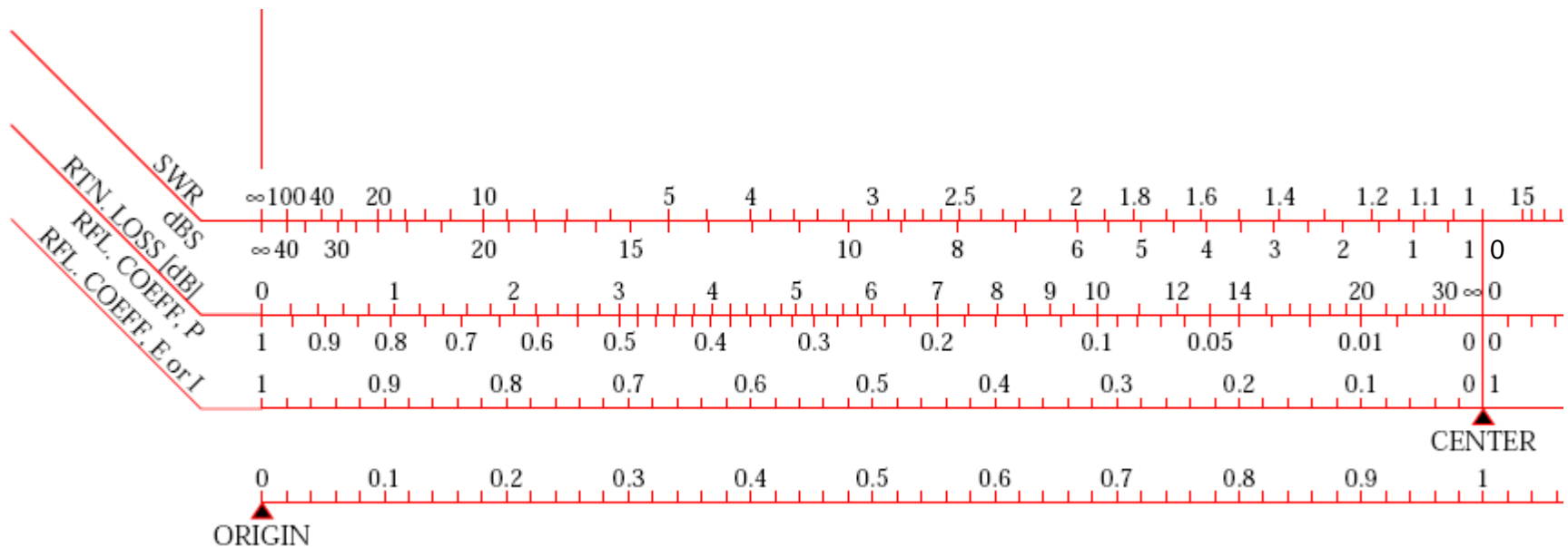

# What about all these rulers below the Smith chart (3)

Second ruler / left / upper part, marked as RTN.LOSS = return loss in dB. This indicates the amount of reflected wave expressed in dB. Thus, in the center of SC nothing is reflected and the return loss is infinite. At the boundary we have full reflection, thus return loss 0 dB. The lower part of the scale denoted as RFL.COEFF. P = reflection coefficient in terms of POWER (proportional  $|\Gamma|^2$ ). No reflected power for the matched case = center of the SC, (normalized) reflected power = 1 at the boundary.

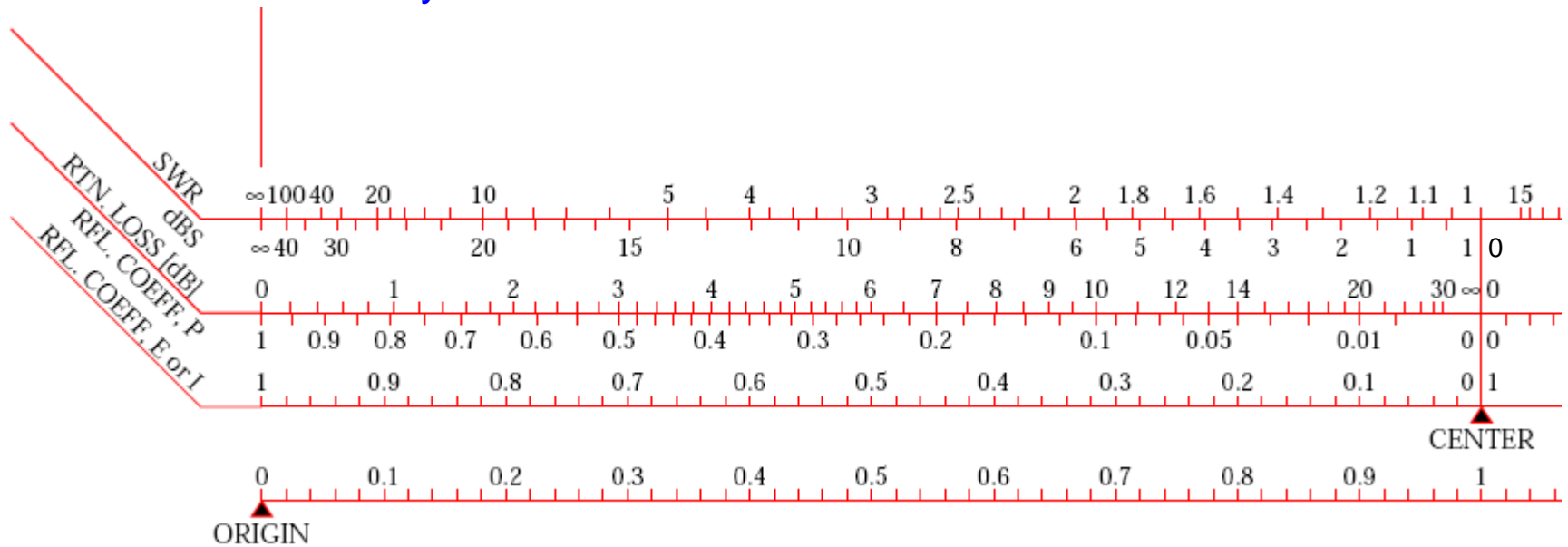

# What about all these rulers below the Smith chart (4)

Third ruler / left, marked as RFL.COEFF,E or I = gives us the modulus (= absolute value) of the reflection coefficient in linear scale. Note that since we have the modulus we can refer it both to voltage or current as we have omitted the sign, we just use the modulus. Obviously in the center the reflection coefficient is zero, at the boundary it is one.

The fourth ruler has been discussed in the example of the previous slides: Voltage transmission coefficient. Note that the modulus of the voltage (and current) transmission coefficient has a range from zero, i.e. short circuit, to +2 (open =  $1+\Gamma$  with  $\Gamma=1$ ). This ruler is only valid for  $Z_{load} = \text{real}$ , i.e. the case of a step in characteristic impedance of the coaxial line.

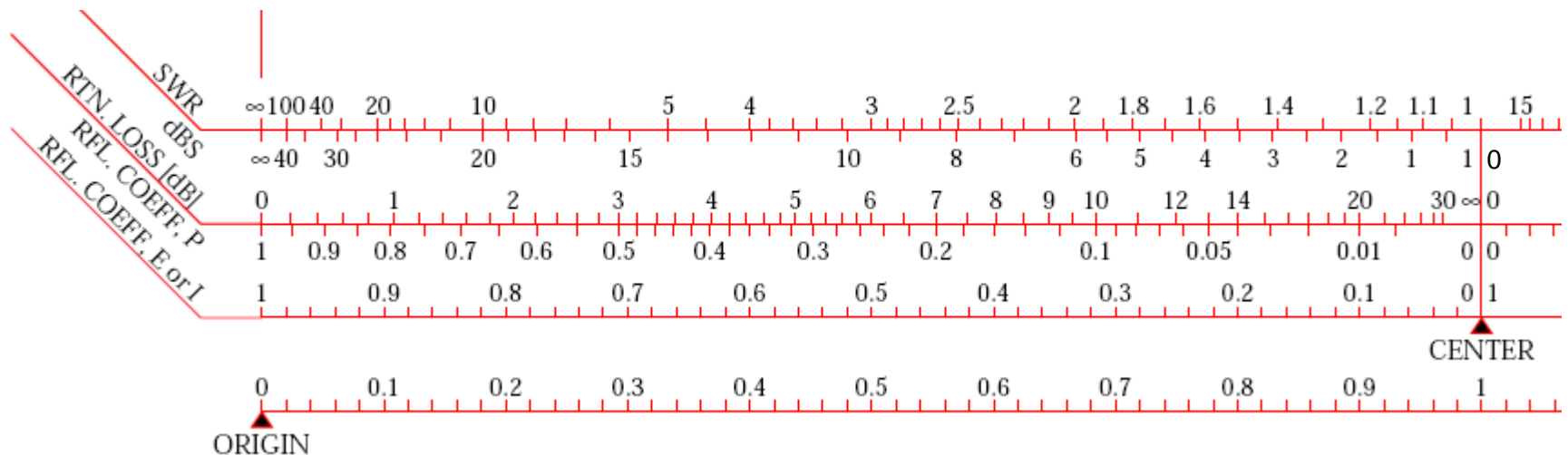

# What about all these rulers below the Smith chart (5)

Third ruler / right, marked as TRANSM.COEFF.P refers to the transmitted power as a function of mismatch and displays essentially the relation  $P_t = P_i (1 - |\Gamma|^2)$ . Thus, in the center of the SC full match, all the power is transmitted. At the boundary we have total reflection and e.g. for a  $\Gamma$  value of 0.5 we see that 75% of the incident power is transmitted.

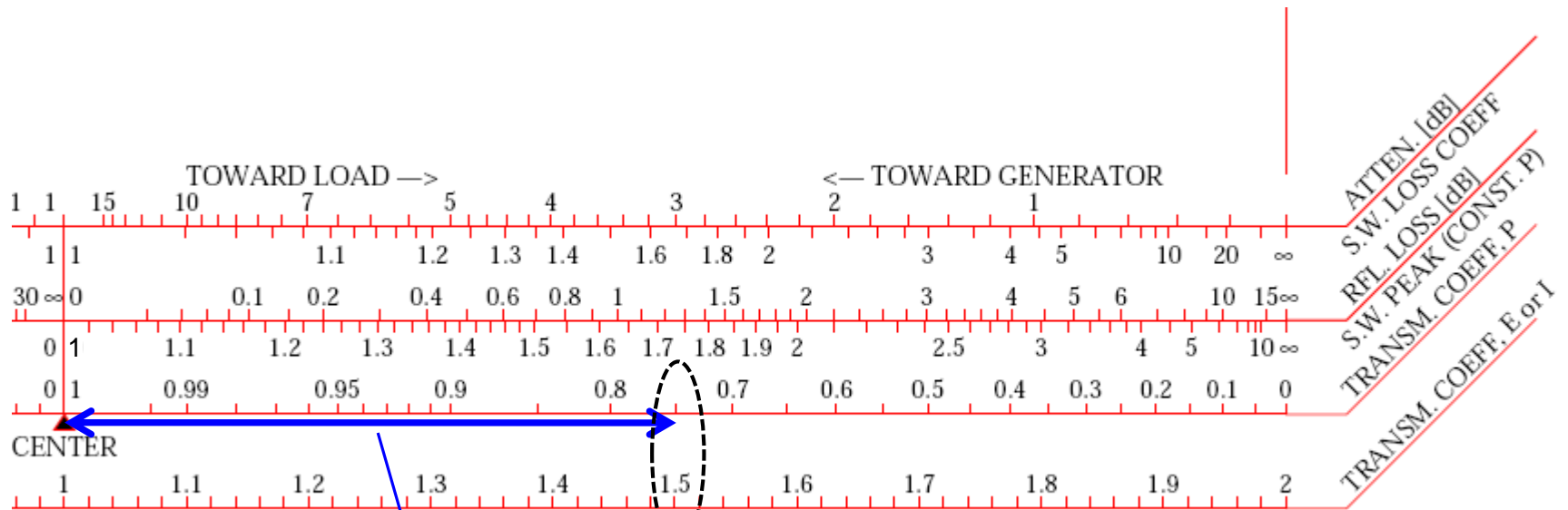

$$|\Gamma|=0.5$$

Note that the voltage of the transmitted wave in this case is 1.5 x the incident wave ( $Z_{load} = \text{real}$ )

# What about all these rulers below the Smith chart (6)

Second ruler / right / upper part, denoted as RFL.LOSS in dB = reflection loss. This ruler refers to the loss in the transmitted wave, not to be confounded with the return loss referring to the reflected wave. It displays the relation  $P_t = 1 - |\Gamma|^2$  in dB.

Example:  $|\Gamma| = 1/\sqrt{2} = 0.707$ , transmitted power = 50% thus loss = 50% = 3dB.

Note that in the lowest ruler the voltage of the transmitted wave ( $Z_{load} = \text{real}$ ) would be  $V_t = 1.707 = 1 + 1/\sqrt{2}$  if referring to the voltage.

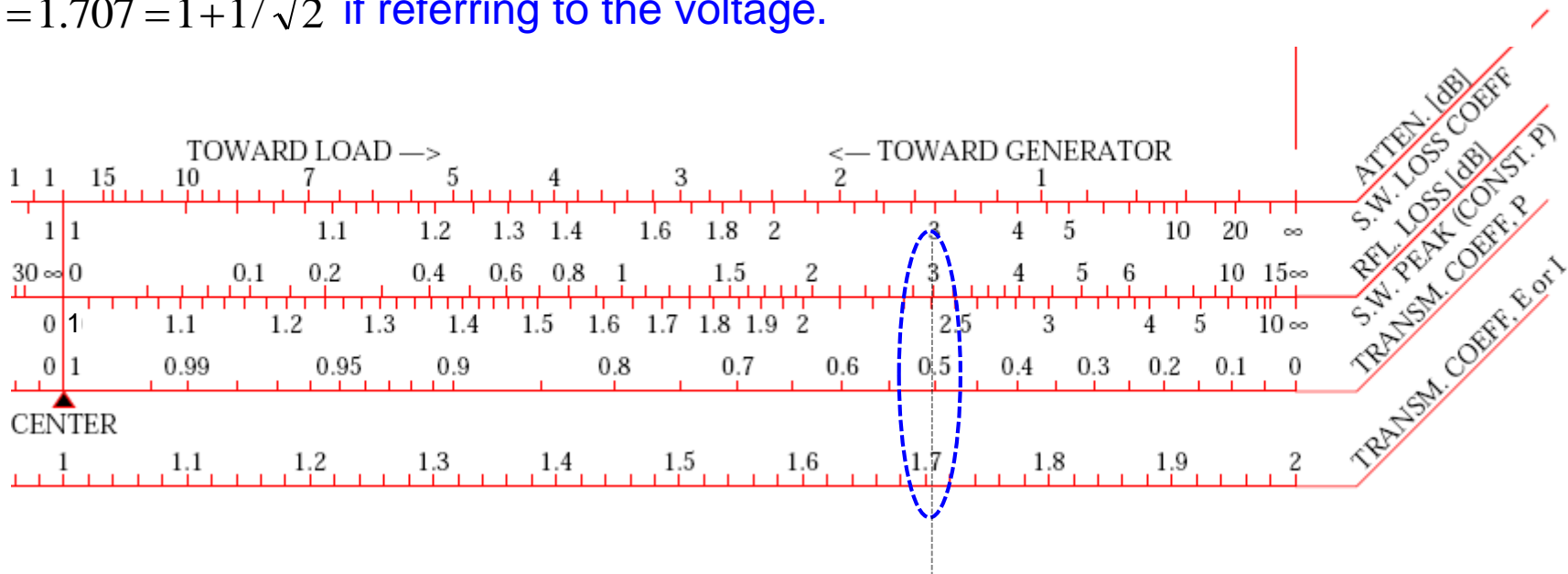

# What about all these rulers below the Smith chart (7)

First ruler / right / upper part, denoted as ATTEN. in dB assumes that we are measuring an attenuator (that may be a lossy line) which itself is terminated by an open or short circuit (full reflection). Thus the wave is travelling twice through the attenuator (forward and backward). The value of this attenuator can be between zero and some very high number corresponding to the matched case.

The lower scale of ruler #1 displays the same situation just in terms of VSWR.

Example: a 10dB attenuator attenuates the reflected wave by 20dB going forth and back and we get a reflection coefficient of  $\Gamma=0.1$  (= 10% in voltage).

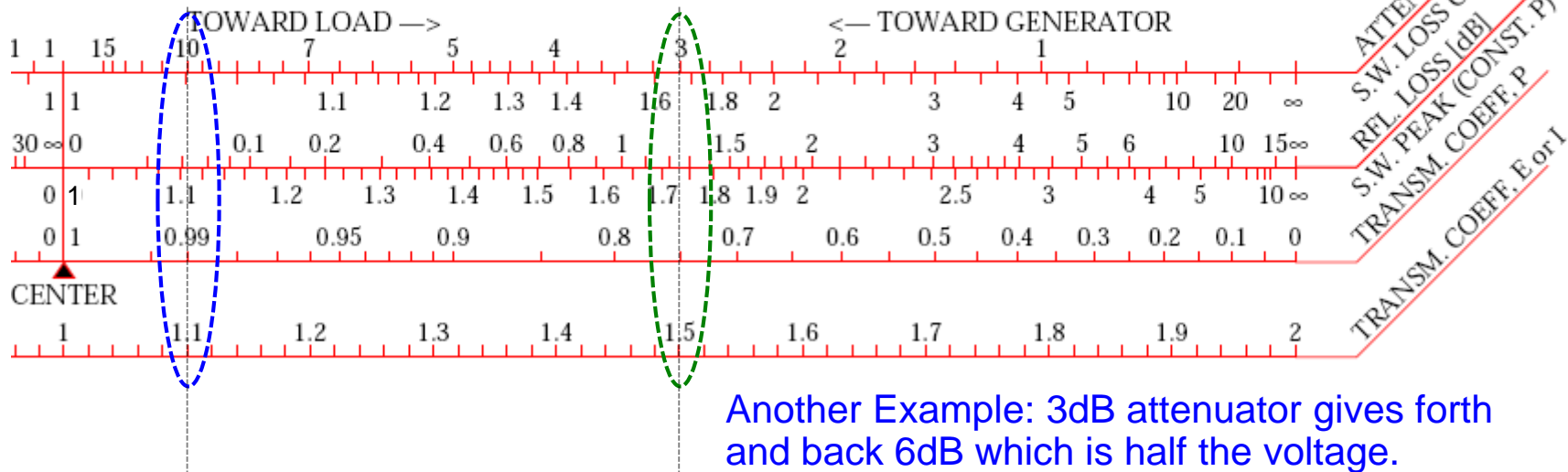



# Introduction of the S-parameters

- ◆ The first paper by Kurokawa
- ◆ Introduction of power waves instead of voltage and current waves using so far (1965)

*Abstract*—This paper discusses the physical meaning and properties of the waves defined by

$$a_i = \frac{V_i + Z_i I_i}{2\sqrt{|\operatorname{Re} Z_i|}}, \quad b_i = \frac{V_i - Z_i^* I_i}{2\sqrt{|\operatorname{Re} Z_i|}}$$

where  $V_i$  and  $I_i$  are the voltage at and the current flowing into the  $i$ th port of a junction and  $Z_i$  is the impedance of the circuit connected to the  $i$ th port. The square of the magnitude of these waves is directly related to the exchangeable power of a source and the reflected power. For this reason, in this paper, they are called the power waves. For certain applications where the power relations are of main concern, the power waves are more suitable quantities than the conventional traveling waves. The lossless and reciprocal conditions as well as the frequency characteristics of the scattering matrix are presented.

Then, the formula is given for a new scattering matrix when the  $Z_i$ 's are changed. As an application, the condition under which an amplifier can be matched simultaneously at both input and output ports as well as the condition for the network to be unconditionally stable are given in terms of the scattering matrix components. Also a brief comparison is made between the traveling waves and the power waves.

K. Kurokawa, 'Power Waves and the Scattering Matrix,'  
IEEE Transactions on Microwave Theory and Techniques,  
Vol. MTT-13, No. 2, March, 1965.

# Example: A generator with a load

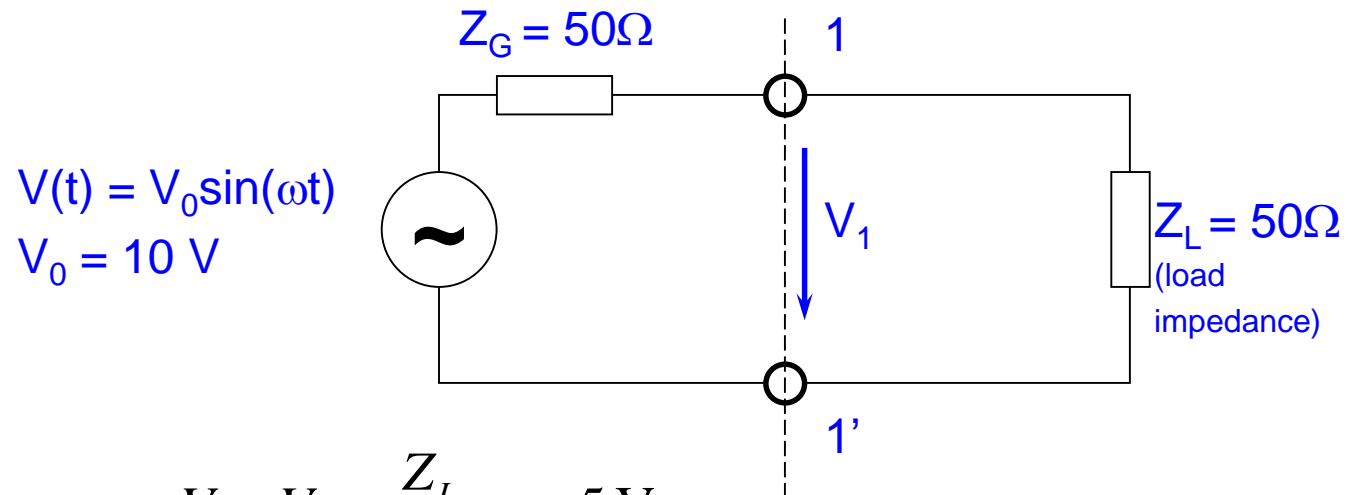

- ◆ Voltage divider:  $V_1 = V_0 \frac{Z_L}{Z_L + Z_G} = 5 \text{ V}$
- ◆ This is the matched case, since  $Z_G = Z_L$ . Thus we have a forward travelling wave only, no reflected wave. Thus the amplitude of the forward travelling wave in this case is  $V_1 = 5 \text{ V}$ ,  $a_1$  returns as  $5 \text{ V} / \sqrt{50\Omega}$  (forward power =  $25 \text{ V}^2 / 50\Omega = 0.5 \text{ W}$ )
- ◆ Matching means maximum power transfer from a generator with given source impedance to an external load
- ◆ In general,  $Z_L = Z_G^*$

# Power waves (1)

$$a_1 = \frac{V_1 + I_1 Z_0}{2\sqrt{Z_0}},$$

$$b_1 = \frac{V_1 - I_1 Z_0}{2\sqrt{Z_0}},$$

where the characteristic impedance  $Z_0 = Z_G$

$$V(t) = V_0 \sin(\omega t)$$

$$V_0 = 10 \text{ V}$$

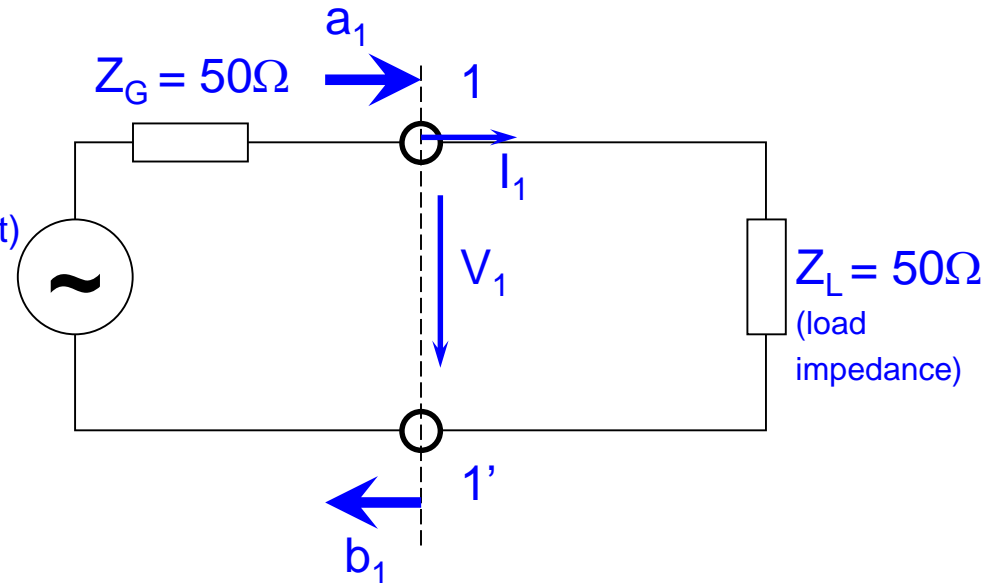

Definition of power waves:

- ◆  $a_1$  is the wave incident on the termination one-port ( $Z_L$ )
- ◆  $b_1$  is the wave running out of the termination one-port
- ◆  $a_1$  has a peak amplitude of  $5 \text{ V}/\sqrt{50\Omega}$
- ◆ What is the amplitude of  $b_1$ ? Answer:  $b_1 = 0$ .
- ◆ **Dimension:**  $[\text{V}/\sqrt{\text{Z}}]$ , in contrast to voltage or current waves

Caution! US notion: power =  $|a|^2$  whereas European notation (often): power =  $|a|^2/2$

# Power waves (2)

This is the definition of  $a$  and  $b$   
(see Kurokawa paper):

$$a_1 = \frac{V_1 + I_1 Z_0}{2\sqrt{Z_0}}$$

$$b_1 = \frac{V_1 - I_1 Z_0}{2\sqrt{Z_0}}$$

Here comes a probably more practical method for determination. Assume that the generator is terminated with an external load equal to the generator impedance. Then we have the matched case and only a forward travelling wave (no reflection). Thus, the voltage on this external resistor is equal to the voltage of the outgoing wave.

$$a_1 = \frac{U_0}{2\sqrt{Z_0}} = \frac{\text{incident voltage wave (port 1)}}{\sqrt{Z_0}} = \frac{U_1^{inc}}{\sqrt{Z_0}}$$

$$b_1 = \frac{U_1^{refl}}{\sqrt{Z_0}} = \frac{\text{reflected voltage wave (port 1)}}{\sqrt{Z_0}}$$

$$U_i = \sqrt{Z_0} (a_i + b_i) = U_i^{inc} + U_i^{refl}$$

$$I_i = \frac{1}{\sqrt{Z_0}} (a_i - b_i) = \frac{U_i^{refl}}{Z_0}$$

**Caution! US notion: power =  $|a|^2$  whereas European notation (often): power =  $|a|^2/2$**

# Analyzing a 2-port

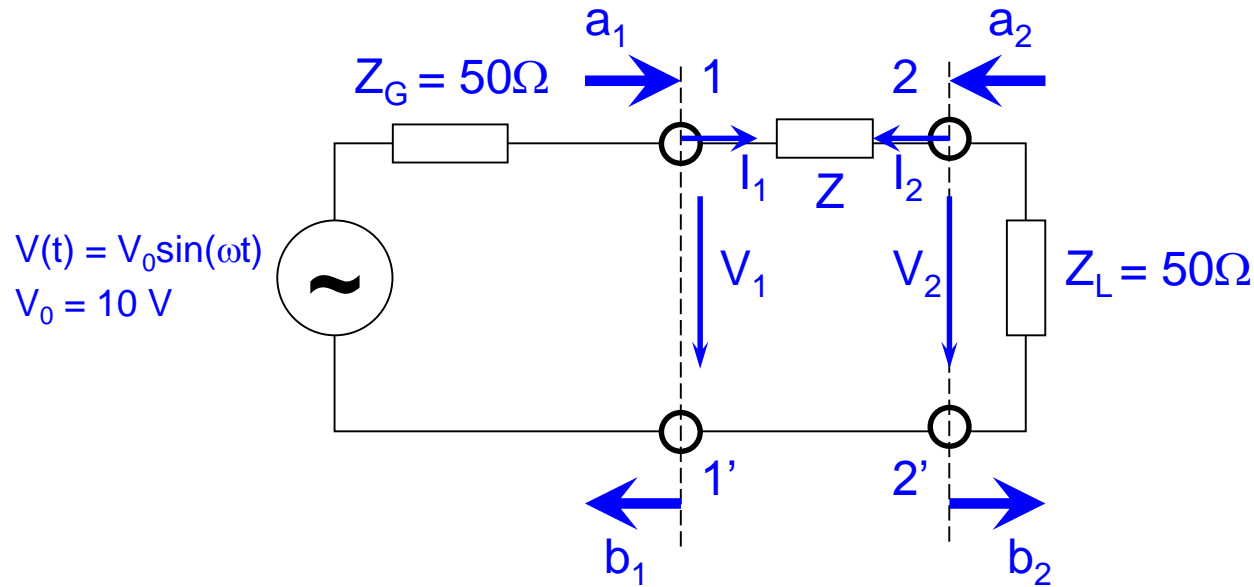

- ◆ A 2-port or 4-pole is shown above between the generator impedance and the load
- ◆ Strategy for practical solution: Determine currents and voltages at all ports (classical network calculation techniques) and from there determine a and b for each port.
- ◆ Important for definition of a and b:  
The wave a always travels towards an N-port, the wave b always travels away from an N-port

# 3 Using S-Parameters

Another important advantage of s-parameters stems from the fact that traveling waves, unlike terminal voltages and currents, do not vary in magnitude at points along a lossless transmission line. This means that scattering parameters can be measured on a device located at some distance from the measurement transducers, provided that the measuring device and the transducers are connected by low-loss transmission lines.

## Derivation

Generalized scattering parameters have been defined by [K. Kurokawa \[Appendix A\]](#). These parameters describe the interrelationships of a new set of variables ( $a_i$ ,  $b_i$ ). The variables  $a_i$  and  $b_i$  are normalized complex voltage waves incident on and reflected from the  $i^{\text{th}}$  port of the network. They are defined in terms of the terminal voltage  $V_i$ , the terminal current  $I_i$ , and an arbitrary reference impedance  $Z_i$ , where the asterisk denotes the complex conjugate:

$$a_i = \frac{V_i + Z_i I_i}{2\sqrt{|\operatorname{Re} Z_i|}} \quad (4) \quad b_i = \frac{V_i - Z_i^* I_i}{2\sqrt{|\operatorname{Re} Z_i|}} \quad (5)$$



### Transmission and Reflection

When light interacts with a lens, as in this photograph, part of the light incident on the woman's eyeglasses is reflected while the rest is transmitted. The amounts reflected and transmitted are characterized by optical reflection and transmission coefficients. Similarly, scattering parameters are measures of reflection and transmission of voltage waves through a two-port electrical network.

# 3 Using S-Parameters

For most measurements and calculations it is convenient to assume that the reference impedance  $Z_i$  is positive and real. For the remainder of this article, then, all variables and parameters will be referenced to a single positive real impedance,  $Z_0$ .

The wave functions used to define s-parameters for a two-port network are shown in Fig. 2.

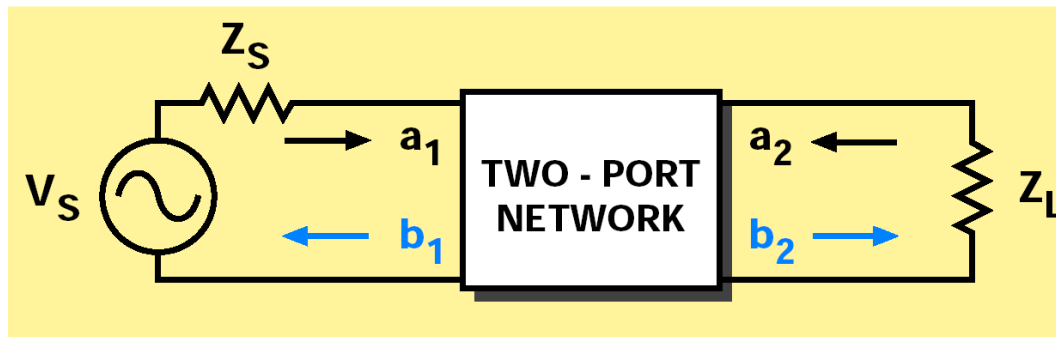

**Figure 2**

Two-port network showing incident waves ( $a_1$ ,  $a_2$ ) and reflected waves ( $b_1$ ,  $b_2$ ) used in s-parameter definitions. The flow graph for this network appears in [Figure 3](#).

**Scattering parameters relationship to optics**  
Impedance mismatches between successive elements in an RF circuit relate closely to optics, where there are successive differences in the index of refraction. A material's characteristic impedance,  $Z_0$ , is inversely related to the index of refraction,  $N$ :

$$Z_0 \sqrt{\frac{\epsilon}{377}} = \frac{1}{N}$$

The s-parameters  $s_{11}$  and  $s_{22}$  are the same as optical reflection coefficients;  $s_{12}$  and  $s_{21}$  are the same as optical transmission coefficients.

# 3 Using S-Parameters

The independent variables  $a_1$  and  $a_2$  are normalized incident voltages, as follows:

$$a_1 = \frac{V_1 + I_1 Z_0}{2\sqrt{Z_0}} = \frac{\text{voltage wave incident on port 1}}{\sqrt{Z_0}} = \frac{V_{i1}}{\sqrt{Z_0}} \quad (6)$$

$$a_2 = \frac{V_2 + I_2 Z_0}{2\sqrt{Z_0}} = \frac{\text{voltage wave incident on port 2}}{\sqrt{Z_0}} = \frac{V_{i2}}{\sqrt{Z_0}} \quad (7)$$

Dependent variables  $b_1$ , and  $b_2$ , are normalized reflected voltages:

$$b_1 = \frac{V_1 - I_1 Z_0}{2\sqrt{Z_0}} = \frac{\text{voltage wave reflected from port 1}}{\sqrt{Z_0}} = \frac{V_{r1}}{\sqrt{Z_0}} \quad (8)$$

$$b_2 = \frac{V_2 - I_2 Z_0}{2\sqrt{Z_0}} = \frac{\text{voltage wave reflected from port 2}}{\sqrt{Z_0}} = \frac{V_{r2}}{\sqrt{Z_0}} \quad (9)$$

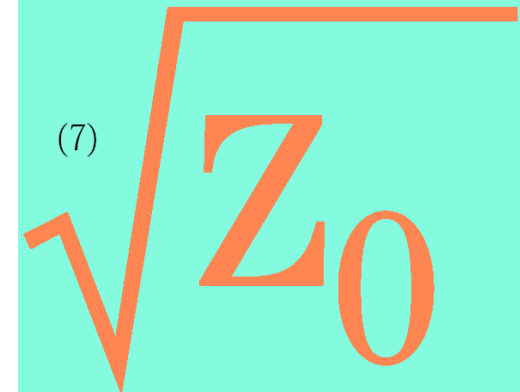



# 3 Using S-Parameters

The linear equations describing the two-port network are then:

$$b_1 = s_{11} a_1 + s_{12} a_2 \quad (10)$$

$$b_2 = s_{21} a_1 + s_{22} a_2 \quad (11)$$

The s-parameters  $s_{11}$ ,  $s_{22}$ ,  $s_{21}$ , and  $s_{12}$  are:

$$s_{11} = \left. \frac{b_1}{a_1} \right|_{a_2=0} = \text{Input reflection coefficient with the output port terminated by a matched load } (Z_L=Z_0 \text{ sets } a_2=0) \quad (12)$$

$$s_{22} = \left. \frac{b_2}{a_2} \right|_{a_1=0} = \text{Output reflection coefficient with the input terminated by a matched load } (Z_S=Z_0 \text{ sets } V_S=0) \quad (13)$$

$$s_{21} = \left. \frac{b_2}{a_1} \right|_{a_2=0} = \text{Forward transmission (insertion) gain with the output port terminated in a matched load.} \quad (14)$$

$$s_{12} = \left. \frac{b_1}{a_2} \right|_{a_1=0} = \text{Reverse transmission (insertion) gain with the input port terminated in a matched load.} \quad (15)$$

**Limitations of lumped models**  
At low frequencies most circuits behave in a predictable manner and can be described by a group of replaceable, lumped-equivalent black boxes. At microwave frequencies, as circuit element size approaches the wavelengths of the operating frequencies, such a simplified type of model becomes inaccurate. The physical arrangements of the circuit components can no longer be treated as black boxes. We have to use a distributed circuit element model and s-parameters.

# 3 Using S-Parameters

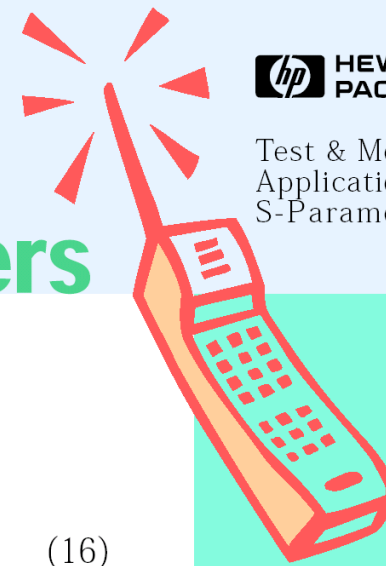

Notice that

$$s_{11} = \frac{b_1}{a_1} = \frac{\frac{V_1}{I_1} - Z_0}{\frac{V_1}{I_1} + Z_0} = \frac{Z_1 - Z_0}{Z_1 + Z_0} \quad (16)$$

$$\text{and } Z_1 = Z_0 \frac{(1 + s_{11})}{(1 - s_{11})} \quad (17)$$

where  $Z_1 = \frac{V_1}{I_1}$  is the input impedance at port 1.

This relationship between reflection coefficient and impedance is the basis of the Smith Chart transmission-line calculator. Consequently, the reflection coefficients  $s_{11}$  and  $s_{22}$  can be plotted on Smith charts, converted directly to impedance, and easily manipulated to determine matching networks for optimizing a circuit design.

## S-parameters

S-parameters and distributed models provide a means of measuring, describing, and characterizing circuit elements when traditional lumped-equivalent circuit models cannot predict circuit behavior to the desired level of accuracy. They are used for the design of many products, such as cellular telephones.

# 3 Using S-Parameters

Another advantage of s-parameters springs from the simple relationship between the variables  $a_1$ ,  $a_2$ ,  $b_1$ , and  $b_2$ , and various power waves:

$|a_1|^2$  = Power incident on the input of the network.  
= Power available from a source impedance  $Z_0$ .

$|a_2|^2$  = Power incident on the output of the network.  
= Power reflected from the load.

$|b_1|^2$  = Power reflected from the input port of the network.  
= Power available from a  $Z_0$  source minus the power delivered to the input of the network.

$|b_2|^2$  = Power reflected from the output port of the network.  
= Power incident on the load.  
= Power that would be delivered to a  $Z_0$  load.

Here the US notion is used, where power =  $|a|^2$ .

European notation (often): power =  $|a|^2/2$

These conventions have no impact on S parameters, only relevant for absolute power calculation

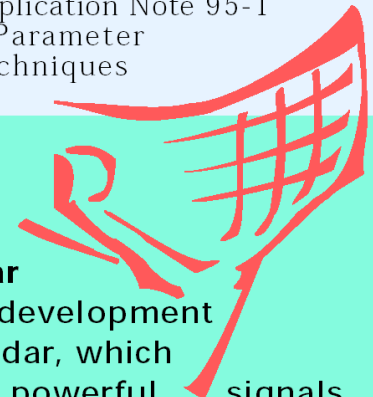

## Radar

The development of radar, which uses powerful signals at short wavelengths to detect small objects at long distances, provided a powerful incentive for improved high frequency design methods during World War II. The design methods employed at that time combined distributed measurements and lumped circuit design. There was an urgent need for an efficient tool that could integrate measurement and design. The Smith Chart met that need.

# 3 Using S-Parameters

The previous four equations show that s-parameters are simply related to power gain and mismatch loss, quantities which are often of more interest than the corresponding voltage functions:

$$|s_{11}|^2 = \frac{\text{Power reflected from the network input}}{\text{Power incident on the network input}}$$

$$|s_{22}|^2 = \frac{\text{Power reflected from the network output}}{\text{Power incident on the network output}}$$

$$|s_{21}|^2 = \frac{\text{Power delivered to a } Z_0 \text{ load}}{\text{Power available from } Z_0 \text{ source}}$$

= Transducer power gain with  $Z_0$  load and source

$$|s_{12}|^2 = \text{Reverse transducer power gain with } Z_0 \text{ load and source}$$

Here the US notion is used, where power =  $|a|^2$ .

European notation (often): power =  $|a|^2/2$

17

These conventions have no impact on S parameters, only relevant for absolute power calculation

# The Scattering-Matrix (1)

The abbreviation S has been derived from the word *scattering*. For high frequencies, it is convenient to describe a given network in terms of **waves** rather than voltages or currents. This permits an easier definition of reference planes. For practical reasons, the description in terms of **in- and outgoing waves** has been introduced.

Waves travelling **towards** the n-port:  $(a) = (a_1, a_2, a_3, \dots, a_n)$

Waves travelling **away** from the n-port:  $(b) = (b_1, b_2, b_3, \dots, b_n)$

The relation between  $a_i$  and  $b_j$  ( $i = 1..n$ ) can be written as a system of n linear equations ( $a_i$  being the independent variable,  $b_j$  the dependent variable):

one - port	$b_1 = S_{11}a_1 + S_{12}a_2 + S_{13}a_3 + S_{14}a_4 + \dots$
two - port	$b_2 = S_{21}a_1 + S_{22}a_2 + S_{23}a_3 + S_{24}a_4 + \dots$
three - port	$b_3 = S_{31}a_1 + S_{32}a_2 + S_{33}a_3 + S_{34}a_4 + \dots$
four - port	$b_4 = S_{41}a_1 + S_{42}a_2 + S_{43}a_3 + S_{44}a_4 + \dots$

In compact matrix notation, these equations are equivalent to

$$\boxed{(b) = (S)(a)}$$

# The Scattering Matrix (2)

The simplest form is a passive **one-port** (2-pole) with some reflection coefficient  $\Gamma$ .

$$(S) = S_{11} \rightarrow b_1 = S_{11}a_1$$

With the reflection coefficient  $\Gamma$  it follows that

$$S_{11} = \frac{b_1}{a_1} = \Gamma$$

Reference plane

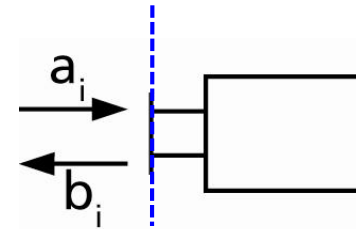

**Two-port** (4-pole)

$$(S) = \begin{bmatrix} S_{11} & S_{12} \\ S_{21} & S_{22} \end{bmatrix} \quad \begin{aligned} b_1 &= S_{11}a_1 + S_{12}a_2 \\ b_2 &= S_{21}a_1 + S_{22}a_2 \end{aligned}$$

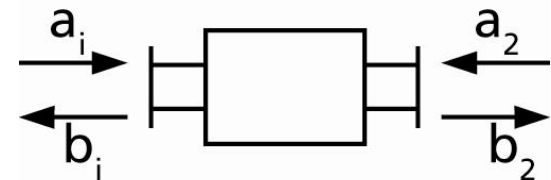

A non-matched load present at port 2 with reflection coefficient  $\Gamma_{load}$  transfers to the input port as

$$\Gamma_{in} = S_{11} + S_{21} \frac{\Gamma_{load}}{1 - S_{22}\Gamma_{load}} S_{12}$$

# Examples of 2-ports (1)

Line of  $Z=50\Omega$ , length  $l=\lambda/4$

$$(S) = \begin{bmatrix} 0 & -j \\ -j & 0 \end{bmatrix} \quad \begin{aligned} b_1 &= -ja_2 \\ b_2 &= -ja_1 \end{aligned}$$

Port 1:

Port 2:

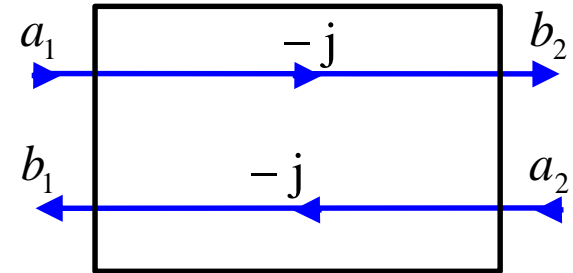

Attenuator 3dB, i.e. half output power

$$(S) = \frac{1}{\sqrt{2}} \begin{bmatrix} 0 & 1 \\ 1 & 0 \end{bmatrix} \quad \begin{aligned} b_1 &= \frac{1}{\sqrt{2}} a_2 = 0.707 a_2 \\ b_2 &= \frac{1}{\sqrt{2}} a_1 = 0.707 a_1 \end{aligned}$$

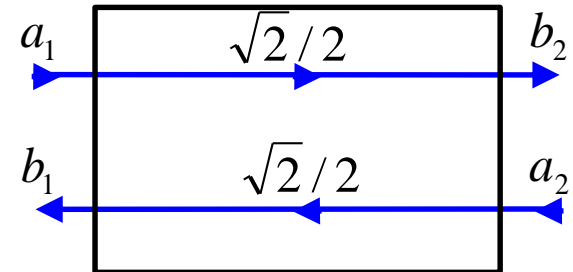

RF Transistor

$$(S) = \begin{bmatrix} 0.277 e^{-j59^\circ} & 0.078 e^{j93^\circ} \\ 1.92 e^{j64^\circ} & 0.848 e^{-j31^\circ} \end{bmatrix}$$

backward transmission

forward transmission

non-reciprocal since  $S_{12} \neq S_{21}$ !  
=different transmission forwards and backwards

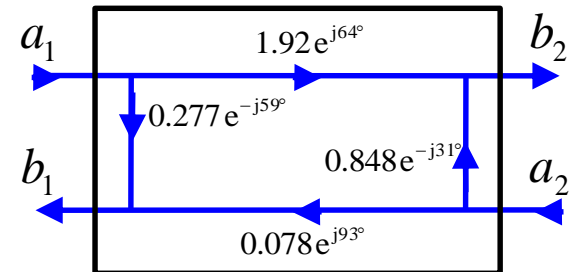

# Examples of 2-ports (2)

Ideal isolator

$$(S) = \begin{bmatrix} 0 & 0 \\ 1 & 0 \end{bmatrix}$$

$b_2 = a_1$

only forward transmission

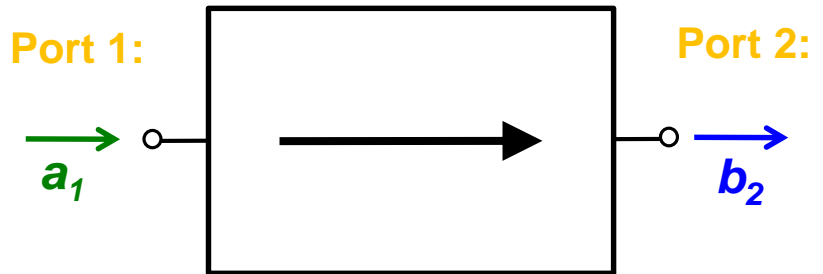

A wave can only pass from left to right through an ideal isolator

A possible implementation is the Faraday rotation isolator presented on the following slide



# Examples of 2-ports (3)

## Faraday rotation isolator

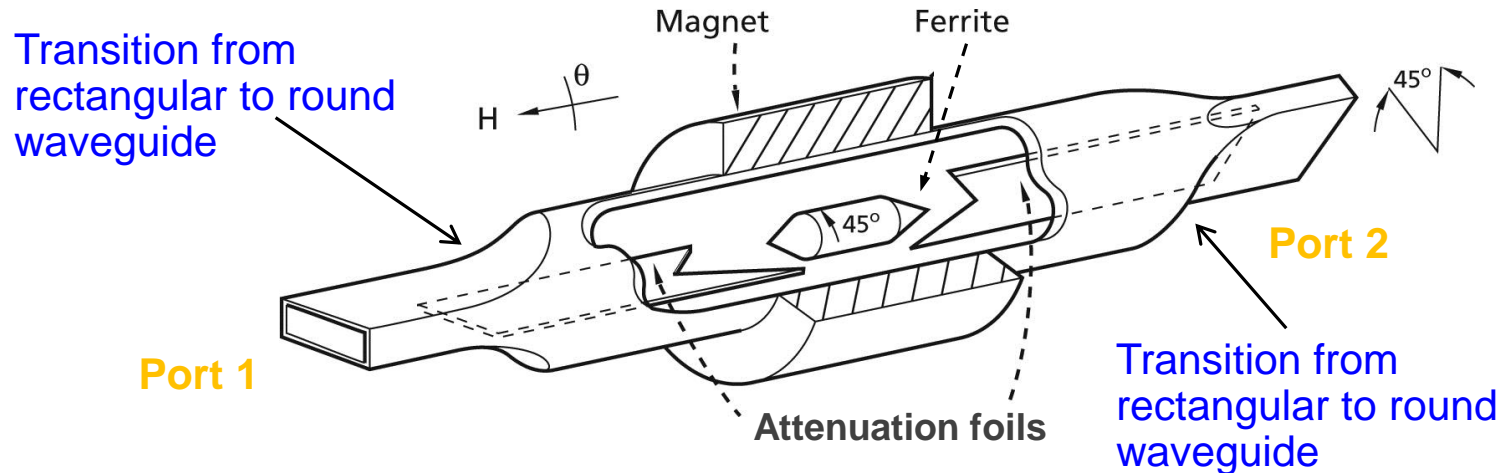

The left waveguide uses a  $TE_{10}$  mode (=vertically polarized H field). After transition to a circular waveguide, the polarization of the mode is rotated **counter clockwise** by  $45^\circ$  by a ferrite.

Then follows a transition to another rectangular waveguide which is rotated by  $45^\circ$  such that the forward wave can pass without reflection or attenuation.

However, a wave coming from the other side will have its polarization rotated by  $45^\circ$  **clockwise** as seen from the right hand side.

# Examples of 3-ports (1)

## Resistive power divider

$$(S) = \frac{1}{2} \begin{bmatrix} 0 & 1 & 1 \\ 1 & 0 & 1 \\ 1 & 1 & 0 \end{bmatrix}$$

$$b_1 = \frac{1}{2}(a_2 + a_3)$$

$$b_2 = \frac{1}{2}(a_1 + a_3)$$

$$b_3 = \frac{1}{2}(a_1 + a_2)$$

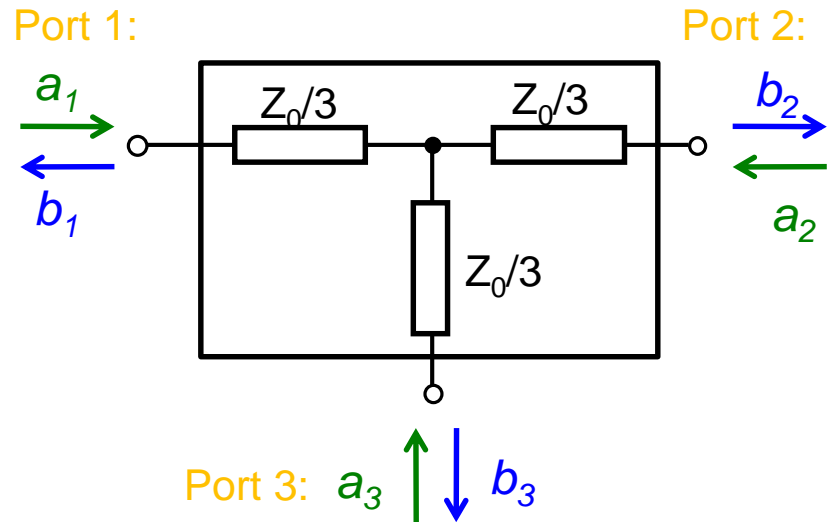

## 3-port circulator

$$(S) = \begin{bmatrix} 0 & 0 & 1 \\ 1 & 0 & 0 \\ 0 & 1 & 0 \end{bmatrix}$$

$$b_1 = a_3$$

$$b_2 = a_1$$

$$b_3 = a_2$$

The ideal circulator is lossless, matched at all ports, but not reciprocal. A signal entering the ideal circulator at one port is transmitted exclusively to the next port in the sense of the arrow.

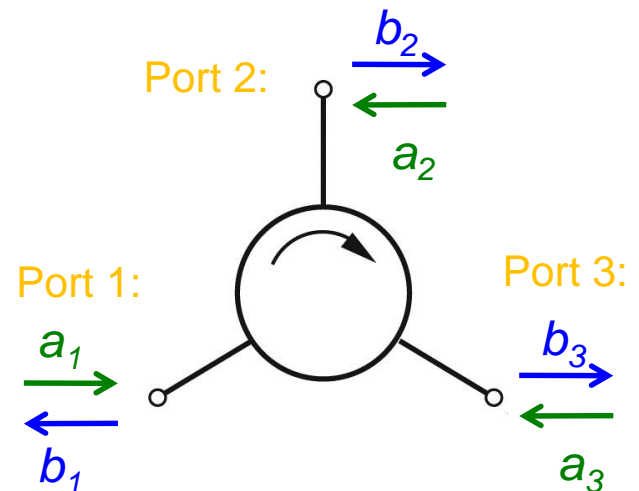

# Examples of 3-ports (2)

Practical implementations of circulators:

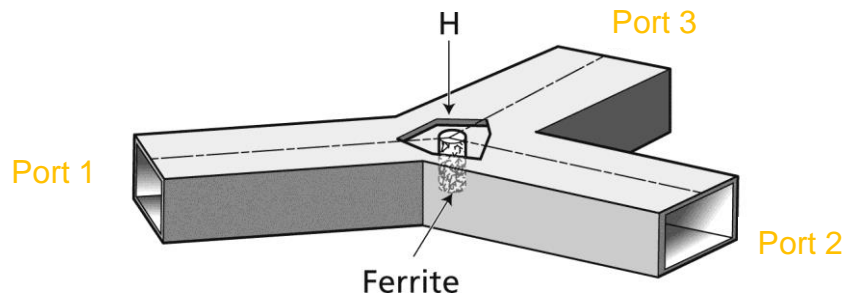

Waveguide circulator

Stripline circulator

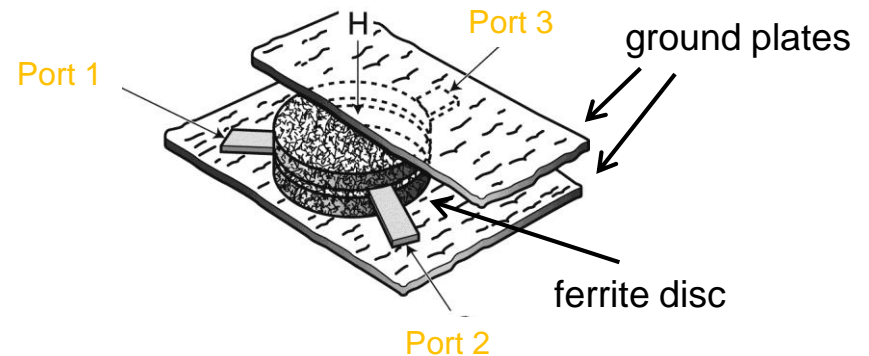

A circulator contains a volume of ferrite. The magnetically polarized ferrite provides the required non-reciprocal properties, thus power is only transmitted from port 1 to port 2, from port 2 to port 3, and from port 3 to port 1.

# Examples of S matrices: 3-ports (3)

- ◆ The T splitter is reciprocal and lossless but not matched at all ports. Using the losslessness condition and symmetry considerations one finds for E and H plane splitters

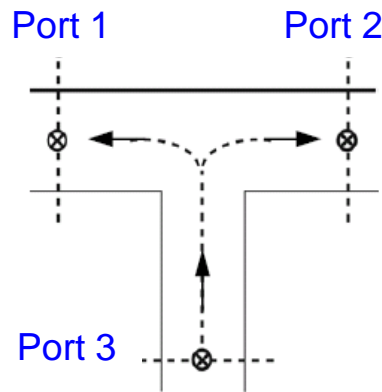
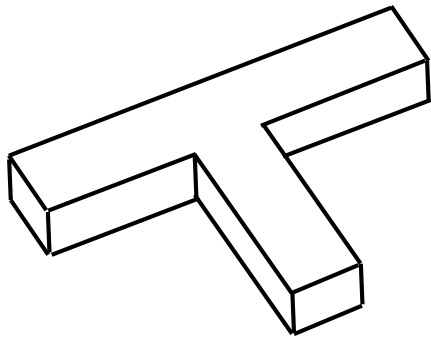
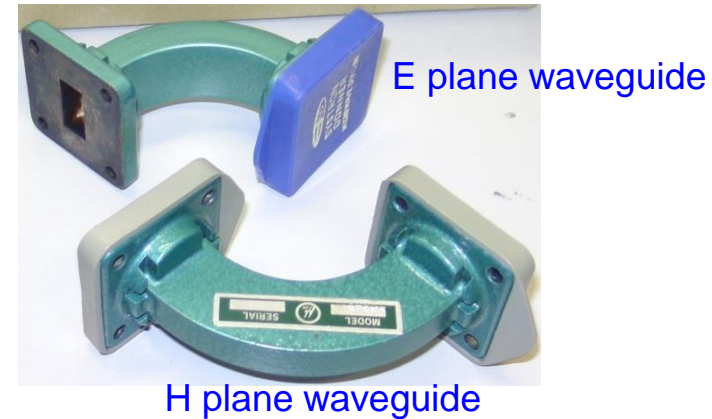

H-plane splitter

$$S_H = \frac{1}{2} \begin{pmatrix} 1 & -1 & \sqrt{2} \\ -1 & 1 & \sqrt{2} \\ \sqrt{2} & \sqrt{2} & 0 \end{pmatrix}$$

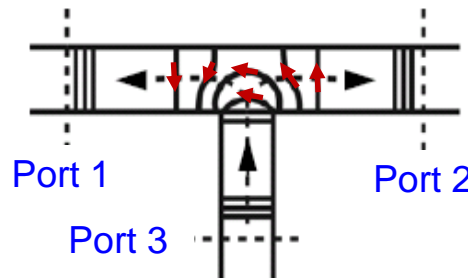
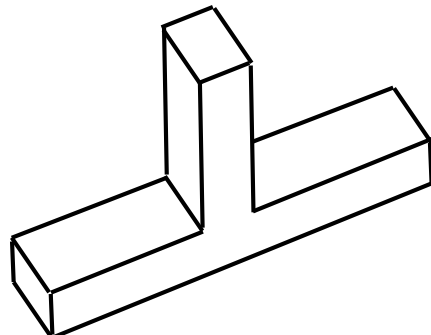

Note: change in sign of wave going left or right

E-plane splitter

$$S_E = \frac{1}{2} \begin{pmatrix} 1 & 1 & \sqrt{2} \\ 1 & 1 & -\sqrt{2} \\ \sqrt{2} & -\sqrt{2} & 0 \end{pmatrix}$$

# Examples of 4-ports (1)

## Ideal directional coupler

$$(S) = \begin{bmatrix} 0 & jk & \sqrt{1-k^2} & 0 \\ jk & 0 & 0 & \sqrt{1-k^2} \\ \sqrt{1-k^2} & 0 & 0 & jk \\ 0 & \sqrt{1-k^2} & jk & 0 \end{bmatrix} \text{ with } k = \left| \frac{b_2}{a_1} \right|$$



Picture from:  
<http://www.thetestequipmentstore.com/waveguide.htm>

To characterize directional couplers, three important figures are used:

the coupling  $C = -20 \log_{10} \left| \frac{b_2}{a_1} \right|$

the directivity  $D = -20 \log_{10} \left| \frac{b_4}{b_2} \right|$

the isolation  $I = -20 \log_{10} \left| \frac{a_1}{b_4} \right|$

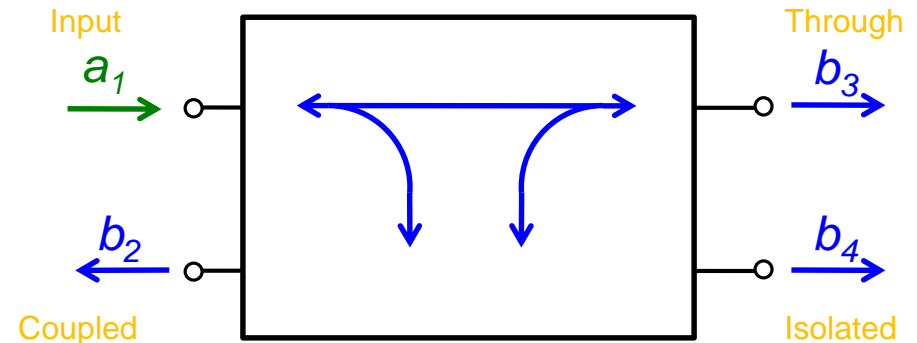

# Examples of 4-ports (2)

Magic-T also referred to as 180° hybrid:

$$(S) = \frac{1}{\sqrt{2}} \begin{bmatrix} 0 & 0 & 1 & 1 \\ 0 & 0 & 1 & -1 \\ 1 & 1 & 0 & 0 \\ 1 & -1 & 0 & 0 \end{bmatrix}$$

The H-plane is defined as a plane in which the magnetic field lines are situated. E-plane correspondingly for the electric field.

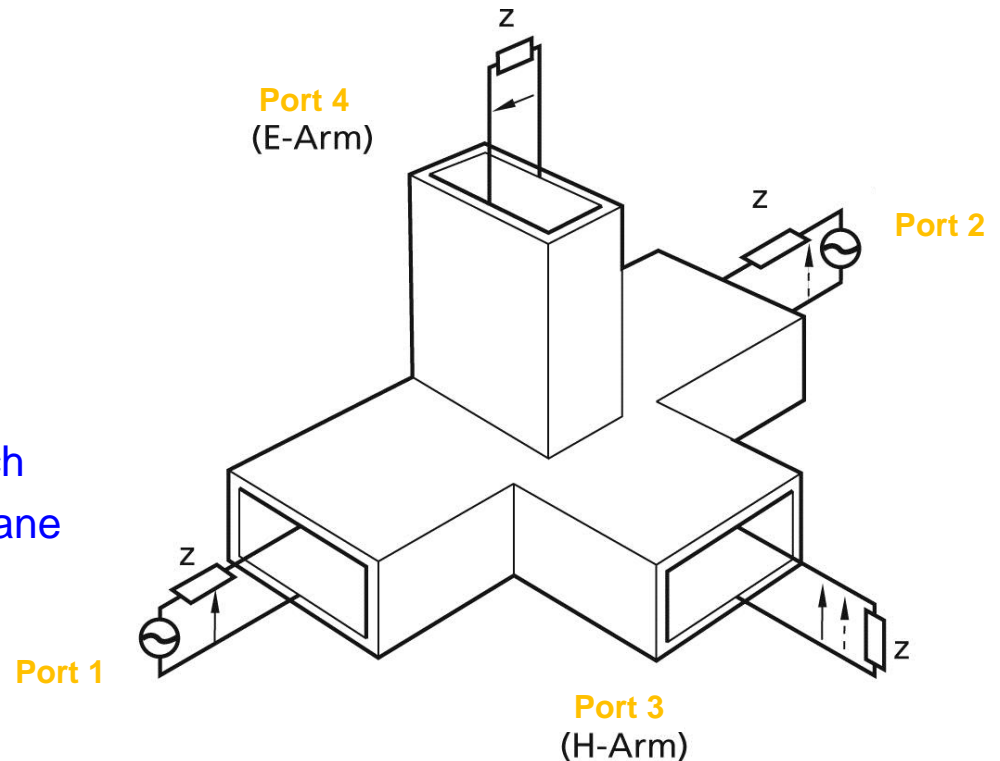

Can be implemented as waveguide or coaxial version. Historically, the name originates from the waveguide version where you can “see” the horizontal and vertical “T”.

# Evaluation of scattering parameters (1)

Basic relation:

$$b_1 = S_{11}a_1 + S_{12}a_2$$

$$b_2 = S_{21}a_1 + S_{22}a_2$$

Finding  $S_{11}$ ,  $S_{21}$ : ("forward" parameters, assuming port 1 = input, port 2 = output e.g. in a transistor)

- connect a generator at port 1 and inject a wave  $a_1$  into it
- connect reflection-free absorber at port 2 to assure  $a_2 = 0$
- calculate/measure
  - wave  $b_1$  (reflection at port 1)
  - wave  $b_2$  (generated at port 2)
- evaluate

$$S_{11} = \left. \frac{b_1}{a_1} \right|_{a_2=0} \quad \text{"input reflection factor"}$$

$$S_{21} = \left. \frac{b_2}{a_1} \right|_{a_2=0} \quad \text{"forward transmission factor"}$$

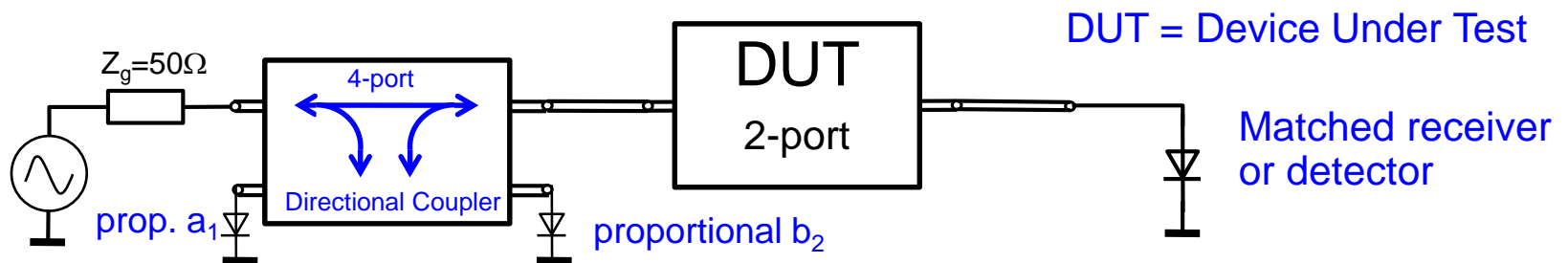

# Evaluation of scattering parameters (2)

Finding  $S_{12}$ ,  $S_{22}$ : ("backward" parameters)

- interchange generator and load
- proceed in analogy to the forward parameters, i.e. inject wave  $a_2$  and assure  $a_1 = 0$
- evaluate

$$S_{12} = \left. \frac{b_1}{a_2} \right|_{a_1=0} \quad \text{"backward transmission factor"}$$

$$S_{22} = \left. \frac{b_2}{a_2} \right|_{a_1=0} \quad \text{"output reflection factor"}$$

For a proper S-parameter measurement all ports of the Device Under Test (DUT) including the generator port must be terminated with their characteristic impedance in order to assure that waves travelling away from the DUT ( $b_n$ -waves) are not reflected back and convert into  $a_n$ -waves.



# Scattering transfer parameters

The T-parameter matrix is related to the incident and reflected normalised waves at each of the ports.

$$\begin{pmatrix} b_1 \\ a_1 \end{pmatrix} = \begin{bmatrix} T_{11} & T_{12} \\ T_{21} & T_{22} \end{bmatrix} \begin{pmatrix} a_2 \\ b_2 \end{pmatrix}$$

T-parameters may be used to determine the effect of a cascaded 2-port networks by simply multiplying the individual T-parameter matrices:

$$[T] = [T^{(1)}][T^{(2)}] \dots [T^{(N)}] = \prod_N [T^{(i)}]$$

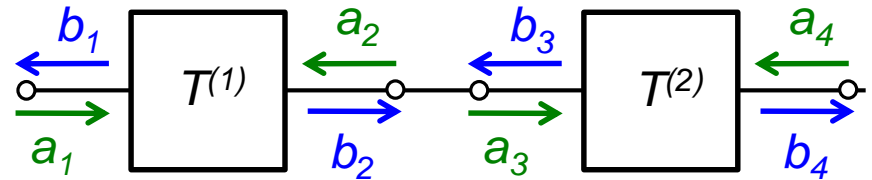

T-parameters can be directly evaluated from the associated S-parameters and vice versa.

From S to T:

$$[T] = \frac{1}{S_{21}} \begin{bmatrix} -\det(S) & S_{11} \\ -S_{22} & 1 \end{bmatrix}$$

From T to S:

$$[S] = \frac{1}{T_{22}} \begin{bmatrix} T_{12} & \det(T) \\ 1 & -T_{21} \end{bmatrix}$$

# Amplifiers (1)

- ◆ **Semiconductors**

- Bipolar transistors
- Field effect transistors
- many others

- ◆ Frequency range: 0...100 GHz

- ◆ Power range: from close to thermal noise level to many kW

- ◆ High reliability, but lifetime not infinite (thermal fatigue, metal migration, etc.)

- ◆ Often unforgiving, failure is normally definitive

- ◆ Inherently low-voltage, high current devices compared to tubes

- ◆ Low to medium gain

# Amplifiers (2)

- ◆ **Gridded Tubes (electron tubes)**
- ◆ Frequency range: 0...0.5 GHz (tetrodes), 0...3 GHz (triodes)
- ◆ Power range:
  - for CW (continuous wave) up to 30 MHz: 1 MW
  - at 300 MHz: 200 kW
  - pulsed at 200 MHz: 4 MW
- ◆ Medium reliability, lifetime cathode limited to 5000...40000 hours
- ◆ Relatively robust
- ◆ Inherently medium to high voltage, low current devices
- ◆ Density modulated
- ◆ High gain at low frequencies, medium gain at high frequencies

# Amplifiers (3)

- ◆ **Klystrons**

- ◆ Frequency range: 0.3...10 GHz

- ◆ Power range:

- CW at 350 MHz: 1 MW
- pulsed at 3 GHz: 30 MW

- ◆ Medium reliability, lifetime cathode limited

- ◆ Needs expert care

- ◆ Inherently very high voltage device

- ◆ Velocity modulated

- ◆ Very high gain ( $\approx 40$  to 60 dB, about 10 dB per passive resonator)

- ◆ Tend to be noisy (acoustically and electrically)

- ◆ **Others**

- ◆ Travelling wave tubes, magnetrons (Microwave ovens!!), Gyrotrons

- ◆ 2-beam accelerators (CLIC)

# Transistors (1)

Example: a field effect transistor (FET)

Structure of an advanced pulse-doped MESFET

High Power and Low Distortion GaAs FET

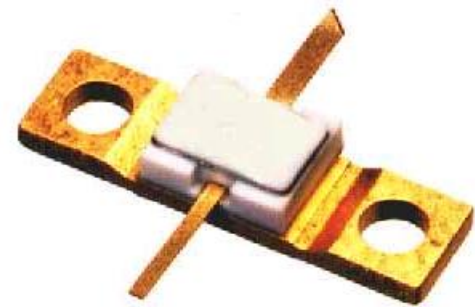
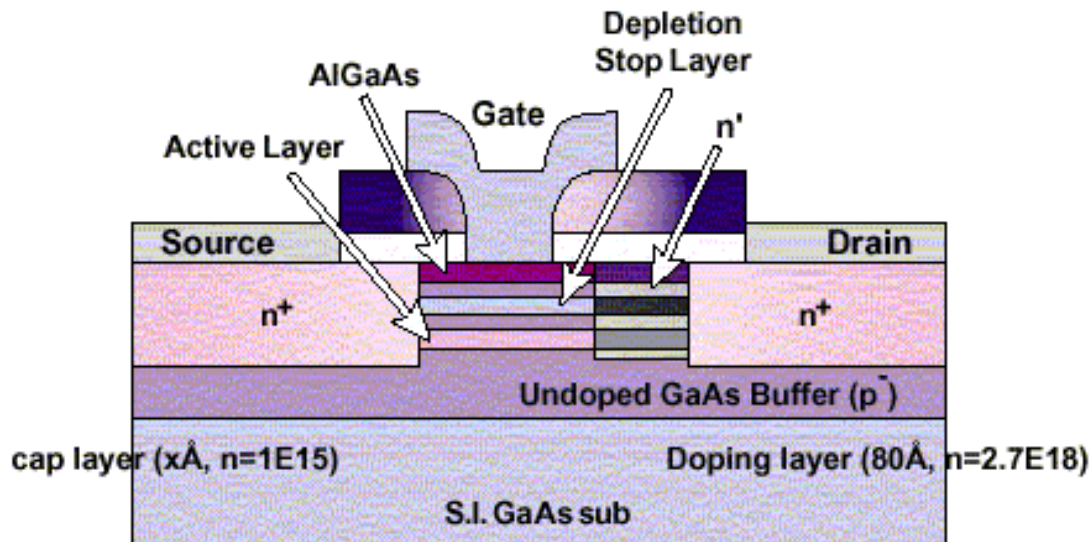

# Transistors (2)

A typical data sheet of a Medium Power GaAs FET

- Up to 2.5 GHz frequency band
- Beyond 22 dBm output power
- Low distortion characteristics
- Low power consumption
- High power gain
- Low-cost plastic mold package
- Low thermal resistance lead

Applications

- Driver amplifier preceding final power amplifier for DECT

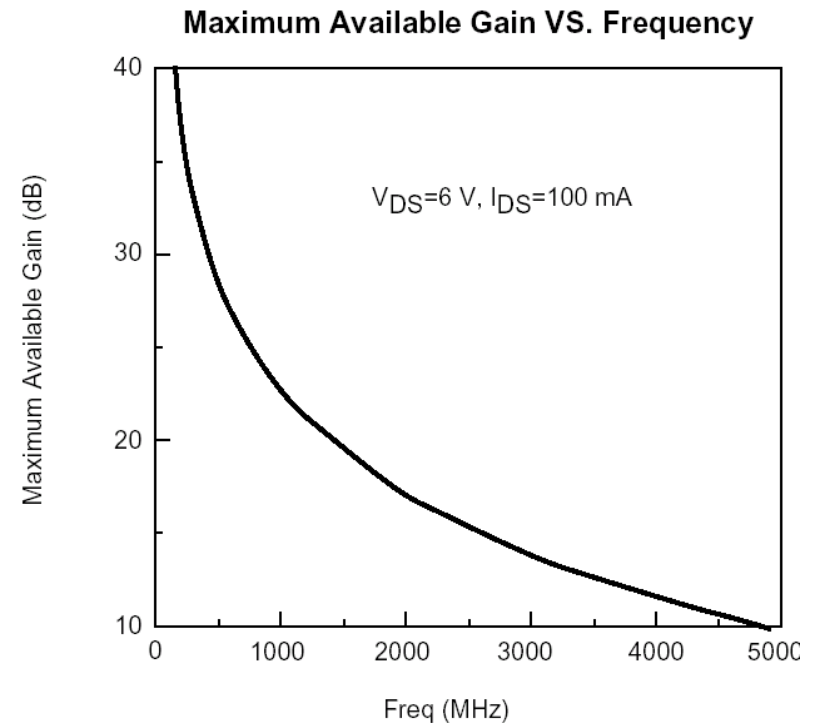
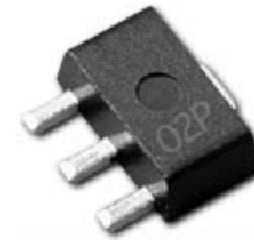

# Transistors (3)

Transistor scattering parameters

They will be covered in detail in the second part of this lecture...

The input and output reflection  
 $S_{11}$  and  $S_{22}$

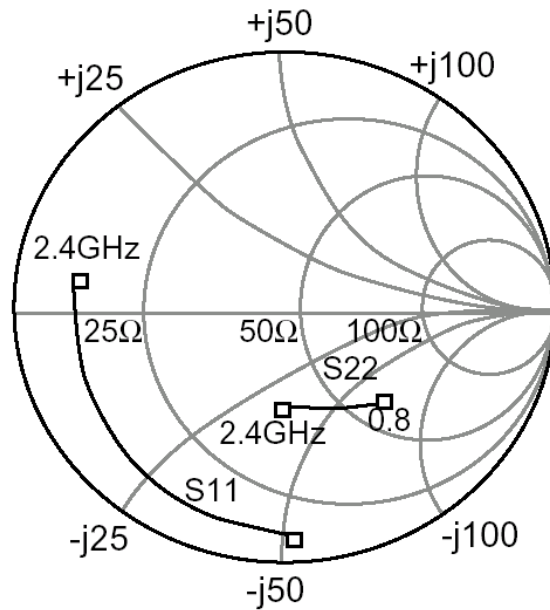

The forward transmission  $S_{21}$  and the  
backward transmission  $S_{12}$

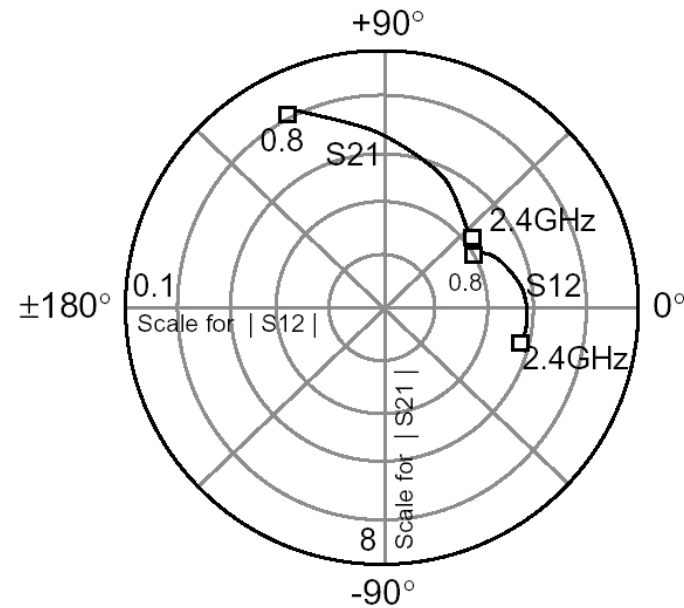

# Gridded tubes

- ◆ Filament burns off electrons
- ◆ acceleration in DC field
- ◆ density modulation by grid
- ◆ => voltage controlled current source

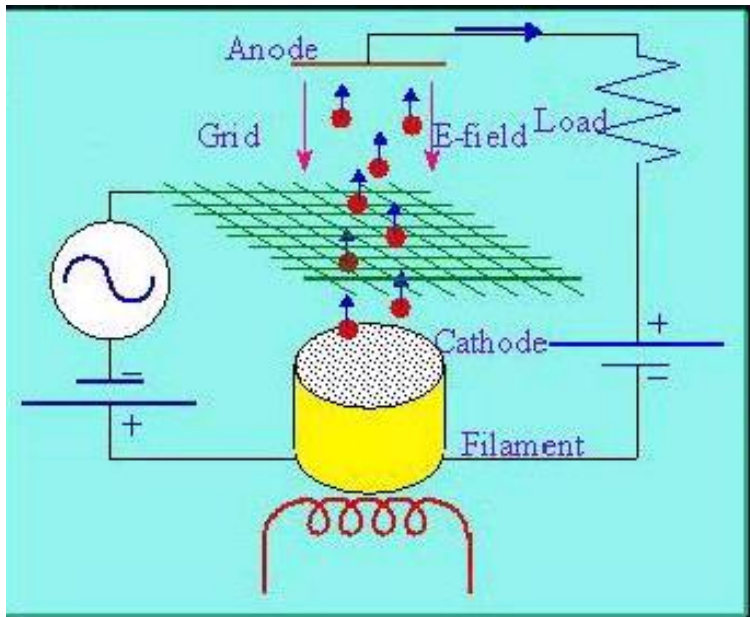

A medium power external anode transmitting tube

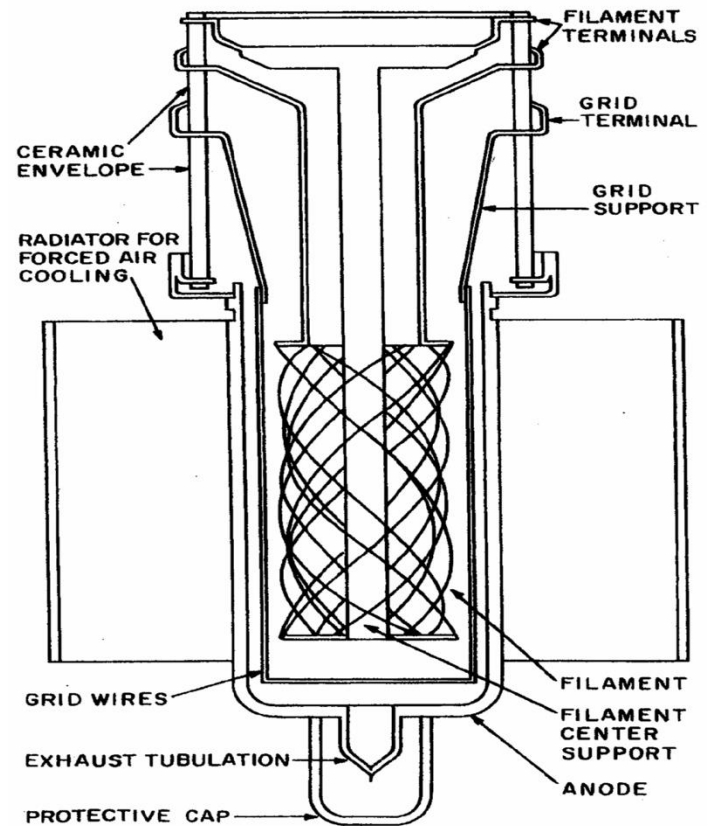



# Klystrons (1)

Filament (electron gun) emits electrons

velocity modulation in first cavity

extraction of high intensity RF field in second cavity

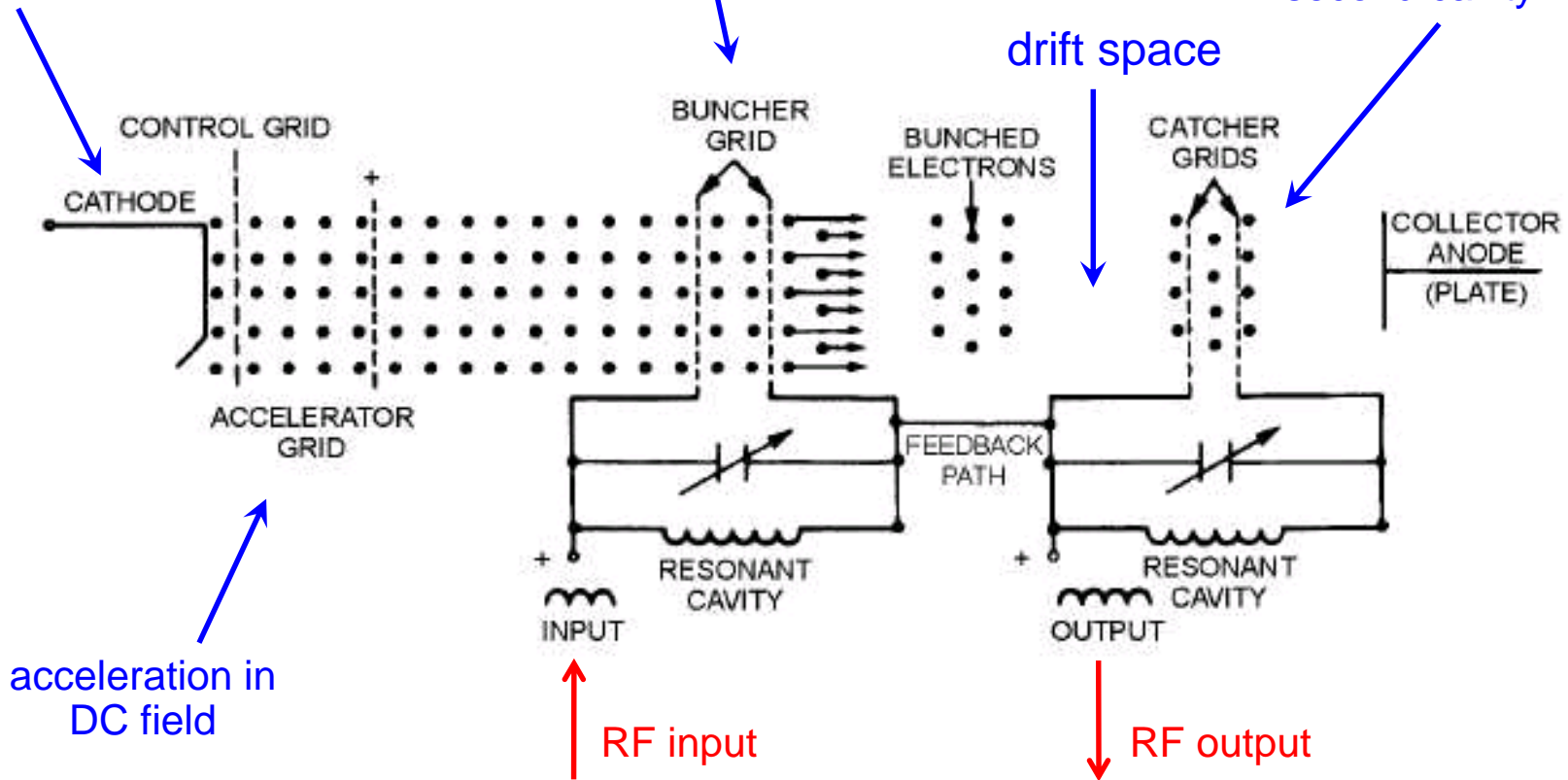

acceleration in DC field

RF input

RF output

# Klystrons (2)

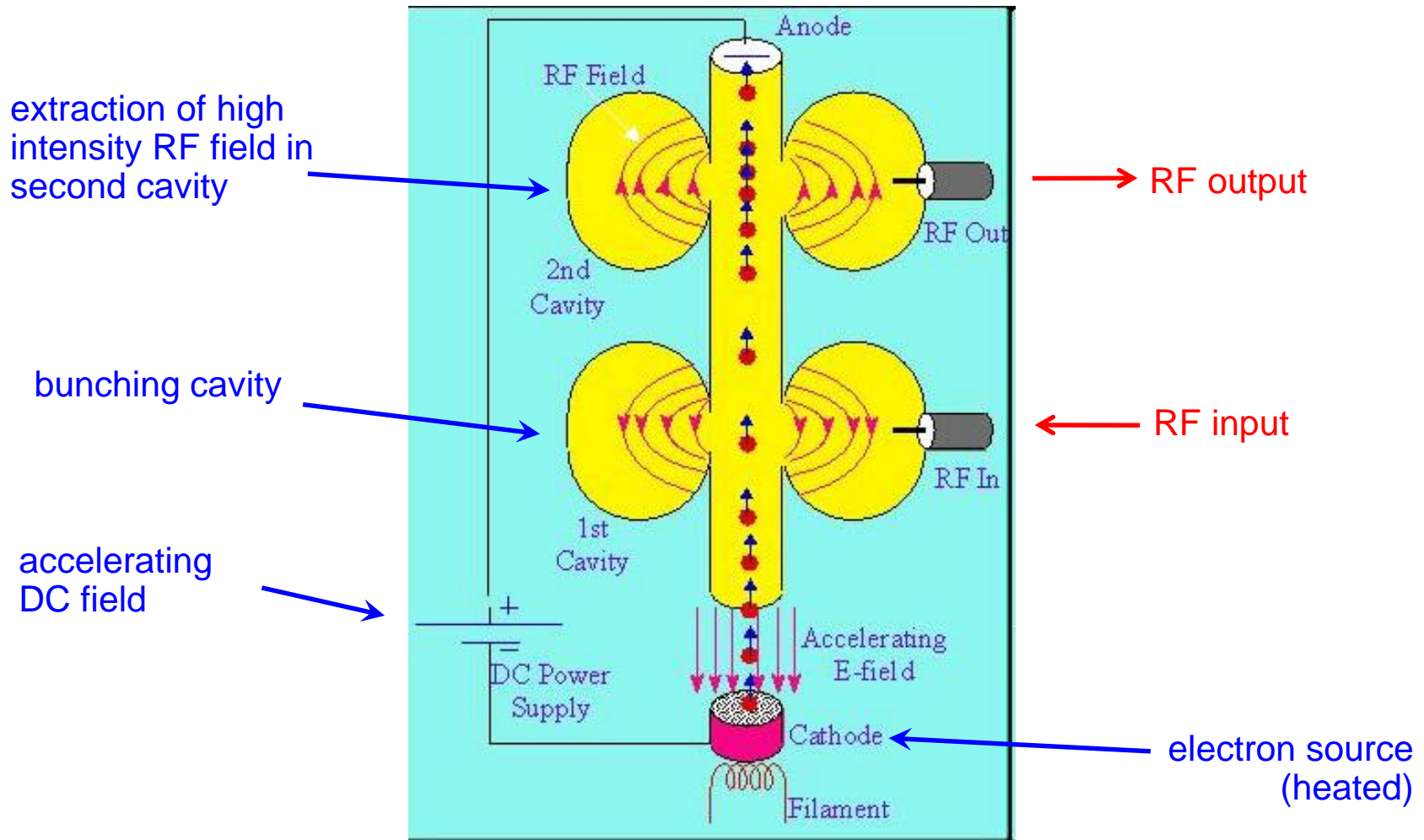

# IOT – Inductive Output Tubes (1)

## IOT - Inductive Output Tubes or klystrodes

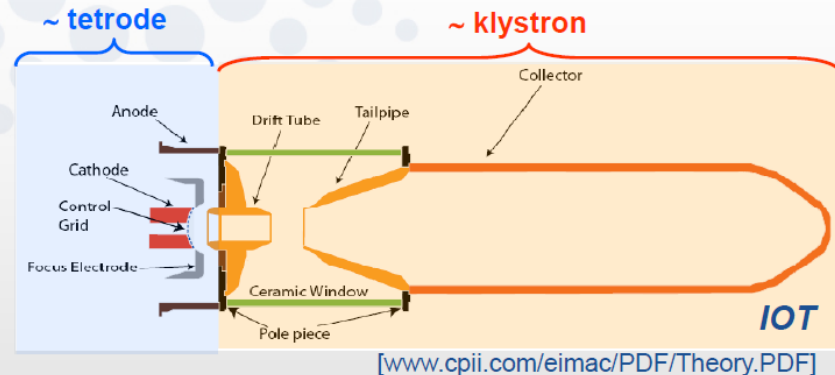

[www.cpii.com/eimac/PDF/Theory.PDF]

☞ Often with external in-air cavities allowing easy IOT exchange

- TV IOT: typically 60 kW at 460 – 860 MHz
- IOT developed for accelerators [Thales, CPI]:
  - 80 kW CW at 470 – 760 MHz
  - $\eta \approx 70\%$  ☞ operation in class B
  - Intrinsic low Gain = 20 ... 22 dB  $\Rightarrow P_{in} = 1$  kW
  - Compact, external cavity  $\Rightarrow$  easy to handle
  - BUT: low unit power  $\Rightarrow$  power combiners

- 1.3 GHz IOT for cw X-FEL Linacs & ERLs
  - 16...20 kW
  - $\eta \approx 55$  to 65% [Thales, CPI, E2V]
  - No adequate klystron on the market
  - Superiority of IOTs:
    - ☞ Higher efficiency
    - ☞ Less amplitude & phase sensitivity to HV ripples
    - ☞ No collector overheating after loss of drive
    - ☞ Expected lower costs

History of the IOT: [www.bext.com/iot.htm](http://www.bext.com/iot.htm)

# IOT – Inductive Output Tubes (2)

## IOT RF Power Sources for Pulsed and CW Linacs

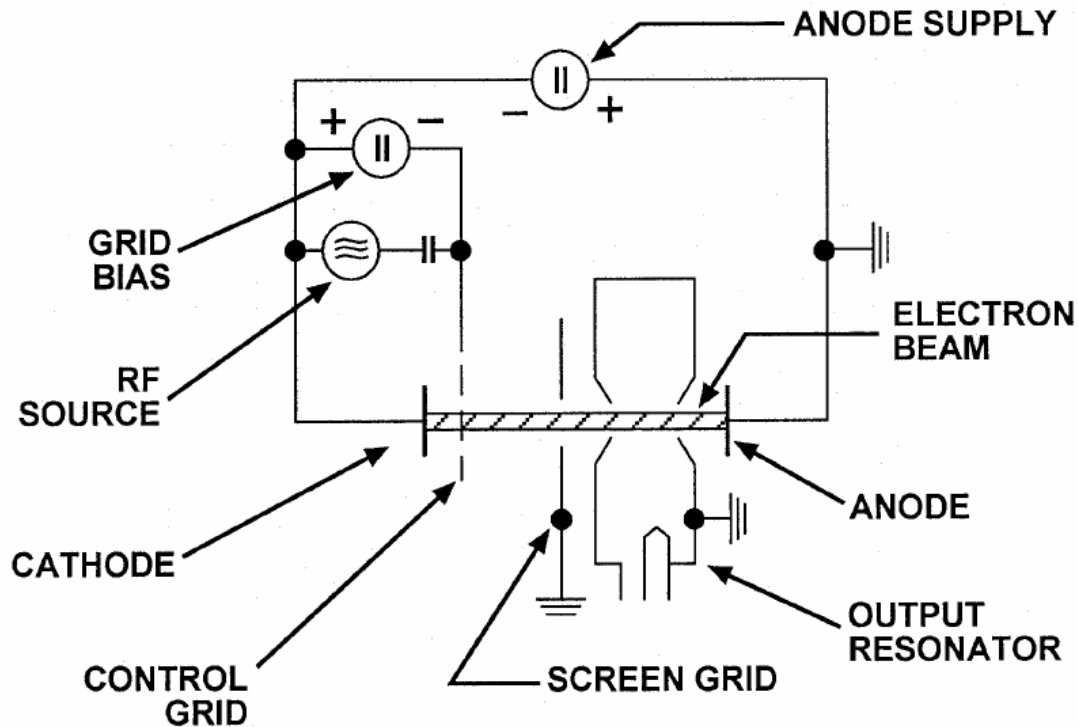

An IOT is a simple device

# IOT – Inductive Output Tubes (3)



## IOT RF Power Sources for Pulsed and CW Linacs



This computer graph shows the equipotential lines inside the collector assembly and the resulting distribution of the spent electron beam.

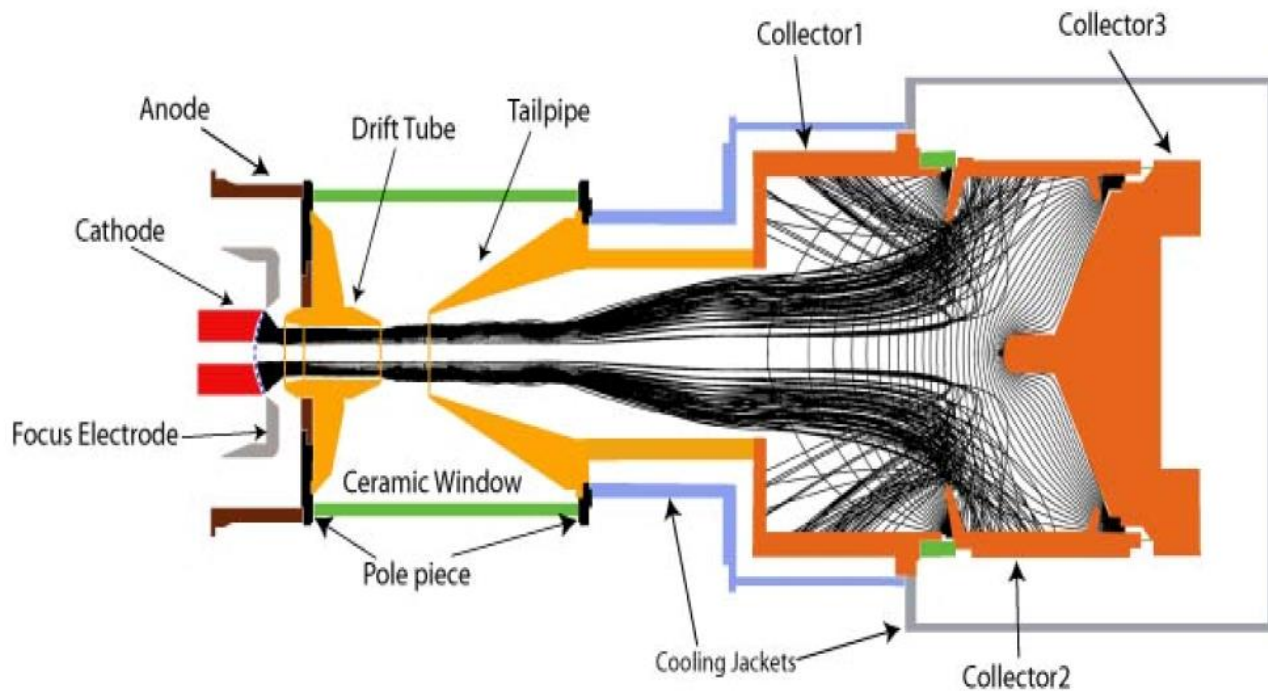

# IOT – Inductive Output Tubes (4)



## IOT RF Power Sources for Pulsed and CW Linacs

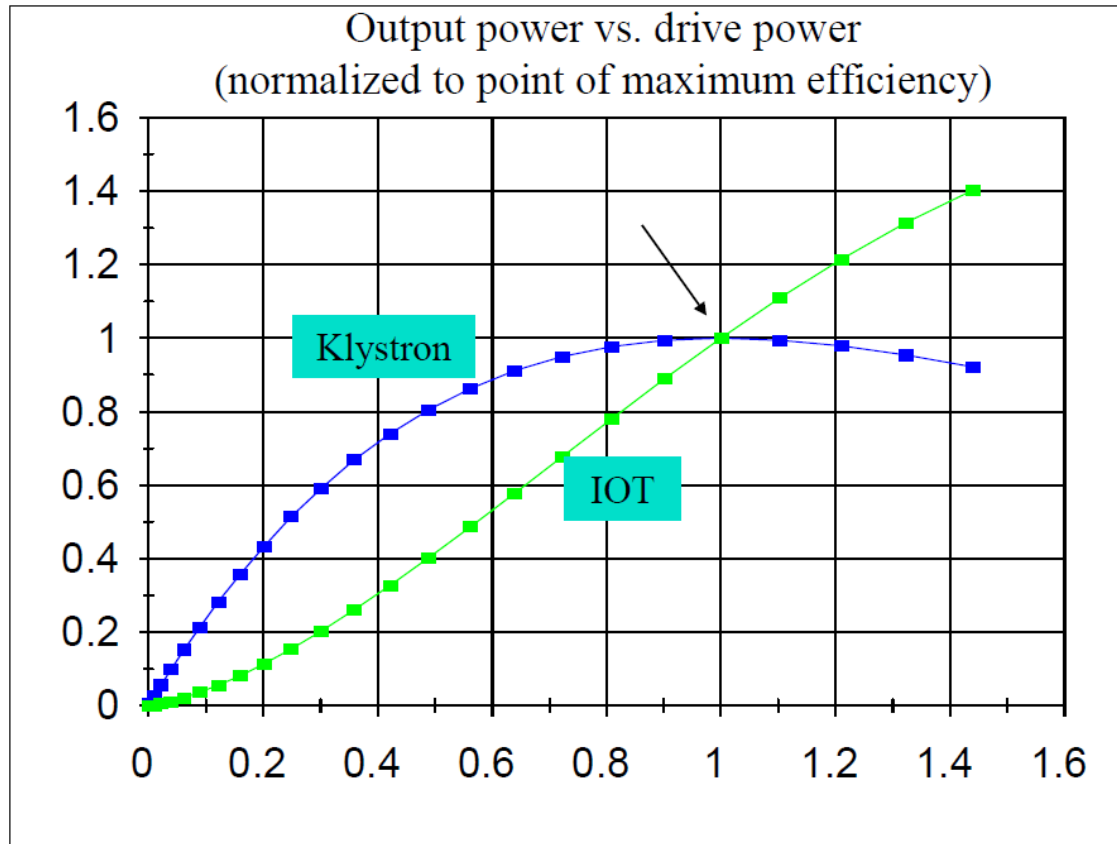

**Comparison of amplifier characteristics:  
IOT vs. klystron**

# Comparison of solid state and vacuum technology for RF power generation (1986)

Solid state devices move steadily up in frequency

Abbreviations:

X Field: crossed field, especially magnetrons

TWT: Travelling wave tubes

CC TWT: coupled cavity TWT

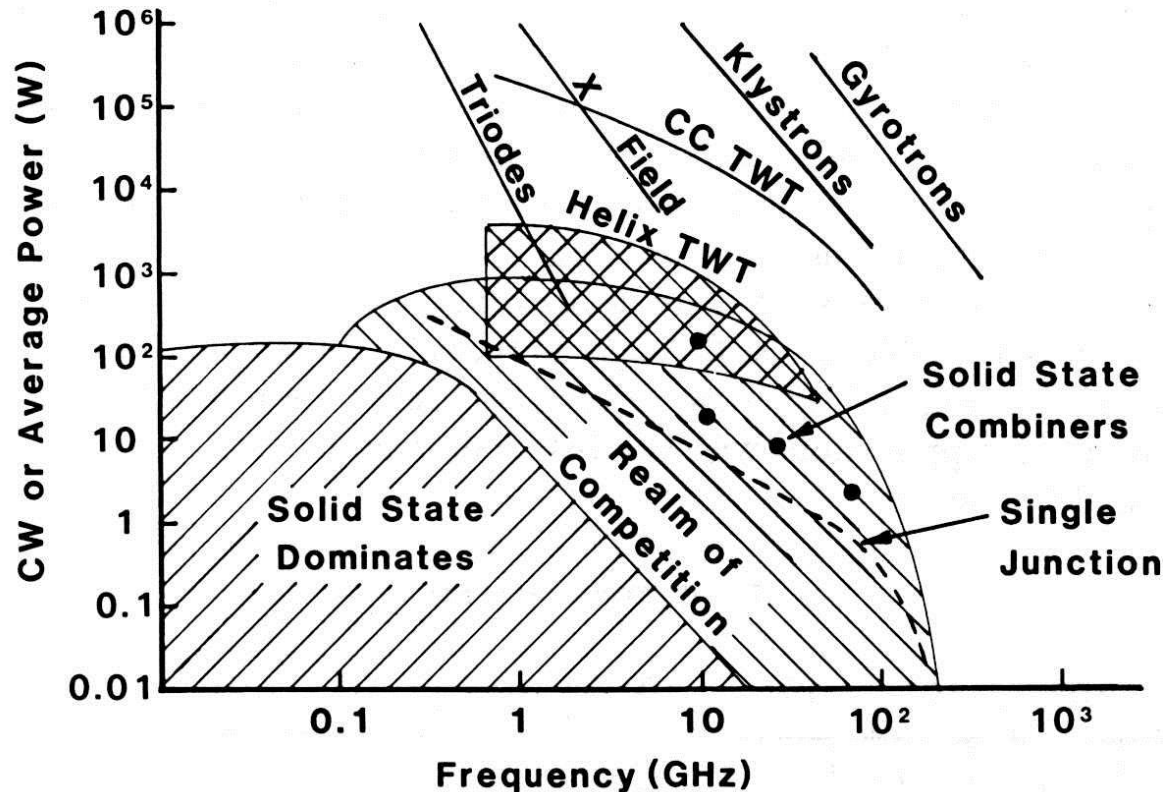

Ref.: Gilmour, A S, *Microwave Tubes*, Artech House, 1986

# Comparison of solid state and vacuum technology for RF power generation (2009)



## RF power sources for accelerating cavities

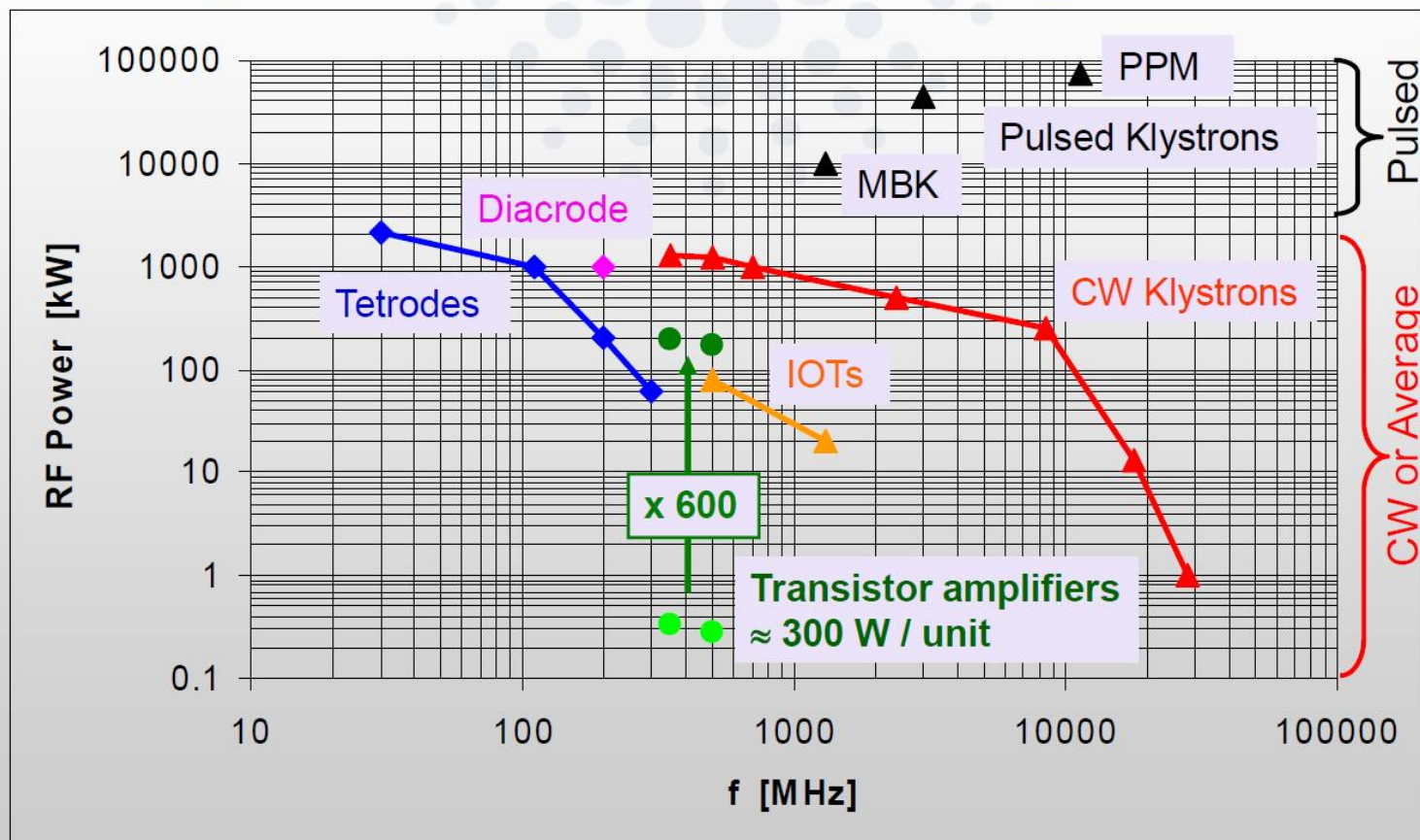



# Measurement devices (1)

- ◆ There are many ways to observe RF signals. Here we give a brief overview of the four main tools we have at hand
  
- ◆ Oscilloscope: to observe signals in **time domain**
  - periodic signals
  - burst signal
  - application: direct observation of signal from a pick-up, shape of common 230 V mains supply voltage, etc.
  
- ◆ Spectrum analyzer: to observe signals in **frequency domain**
  - sweeps through a given frequency range point by point
  - application: observation of spectrum from the beam or of the spectrum emitted from an antenna, etc.

# Measurement devices (2)

- ◆ **Dynamic signal analyzer (FFT analyzer)**
  - Acquires signal in time domain by fast sampling
  - Further numerical treatment in digital signal processors (DSPs)
  - Spectrum calculated using Fast Fourier Transform (FFT)
  - Combines **features of a scope and a spectrum analyzer**: signals can be looked at directly in time domain or in frequency domain
  - Contrary to the SPA, also the spectrum of non-repetitive signals and transients can be observed
  - Application: Observation of tune sidebands, transient behavior of a phase locked loop, etc.
  
- ◆ **Network analyzer**
  - Excites a network (circuit, antenna, amplifier or such) at a given CW frequency and measures response in magnitude and phase => **determines S-parameters**
  - Covers a frequency range by measuring step-by-step at subsequent frequency points
  - Application: characterization of passive and active components, time domain reflectometry by Fourier transforming reflection response, etc.

# Superheterodyne Concept (1)

## Design and its evolution

The diagram below shows the basic elements of a single conversion superhet receiver. The essential elements of a local oscillator and a mixer followed by a fixed-tuned filter and IF amplifier are common to all superhet circuits. [super ετερω δυναμις] a mixture of Latin and Greek ... it means: *another force becomes superimposed*.

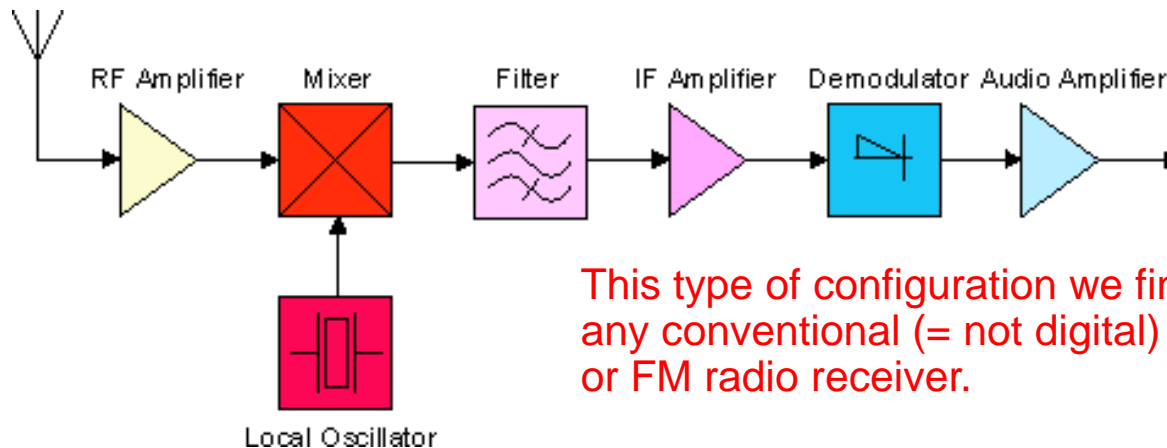

This type of configuration we find in any conventional (= not digital) AM or FM radio receiver.

The advantage to this method is that most of the radio's signal path has to be sensitive to only a narrow range of frequencies. Only the front end (the part before the frequency converter stage) needs to be sensitive to a wide frequency range. For example, the front end might need to be sensitive to 1–30 MHz, while the rest of the radio might need to be sensitive only to 455 kHz, a typical IF. Only one or two tuned stages need to be adjusted to track over the tuning range of the receiver; all the intermediate-frequency stages operate at a fixed frequency which need not be adjusted.

[en.wikipedia.org](http://en.wikipedia.org)

# Superheterodyne Concept (2)

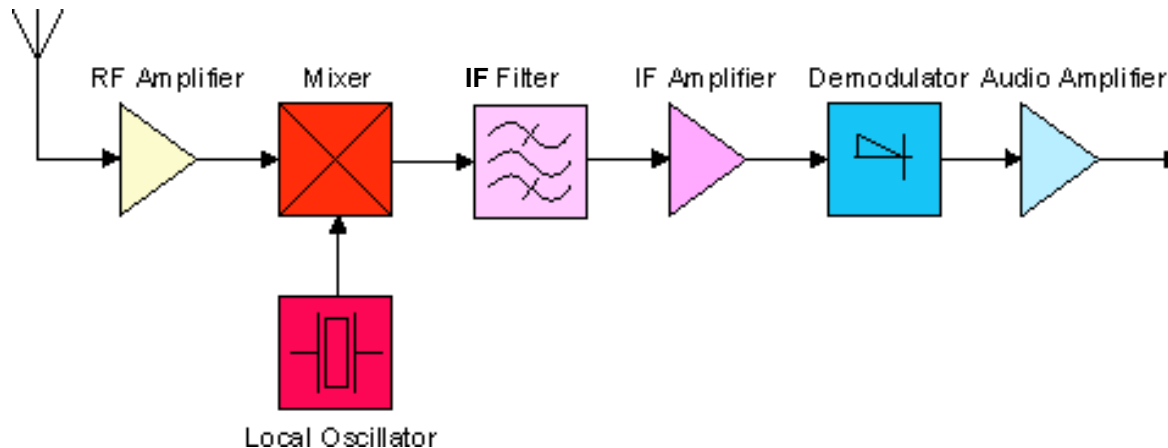

RF Amplifier = wideband frontend amplification (RF = radio frequency)

The Mixer can be seen as an analog multiplier which multiplies the RF signal with the LO (local oscillator) signal.

The local oscillator has its name because it's an oscillator situated in the receiver locally and not far away as the radio transmitter to be received.

IF stands for intermediate frequency.

The demodulator can be an amplitude modulation (AM) demodulator (envelope detector) or a frequency modulation (FM) demodulator, implemented e.g. as a PLL (phase locked loop).

The tuning of a normal radio receiver is done by changing the frequency of the LO, not of the IF filter.

[en.wikipedia.org](http://en.wikipedia.org)

# Example for Application of the Superheterodyne Concept in a Spectrum Analyzer

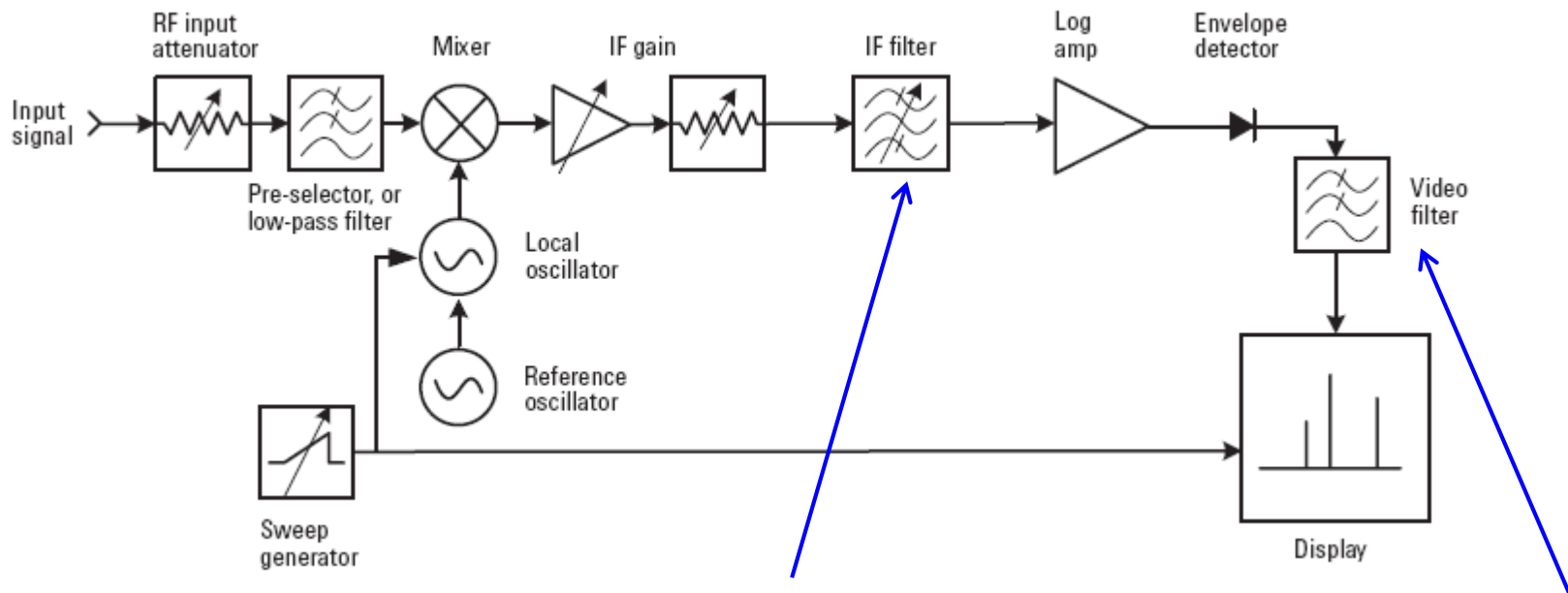

The center frequency is fixed, but the bandwidth of the IF filter can be modified.

The video filter is a simple low-pass with variable bandwidth before the signal arrives to the vertical deflection plates of the cathode ray tube.

Agilent, 'Spectrum Analyzer Basics,'  
Application Note 150, page 10 f.

# Further reading

## Introductory literature

- ◆ A very good general introduction in the context of accelerator physics: CERN Accelerator School: RF Engineering for Particle Accelerators, Geneva
- ◆ The basics of the two most important RF measurement devices: Byrd, J M, Caspers, F, Spectrum and Network Analyzers, CERN-PS-99-003-RF; Geneva

## General RF Theory

- ◆ RF theory in a very reliable compilation: Zinke, O. and Brunswig H., Lehrbuch der Hochfrequenztechnik, Springer
- ◆ Rather theoretical approach to guided waves: Collin, R E, Field Theory of Guided Waves, IEEE Press
- ◆ Another very good one, more oriented towards application in telecommunications: Fontolliet, P.-G.. Systemes de Telecommunications, Traite d'Electricite, Vol. 17, Lausanne
- ◆ And of course the classic theoretical treatise: Jackson, J D, Classical Electrodynamics, Wiley

## For the RF Engineer

- ◆ All you need to know in practice: Meinke, Gundlach, Taschenbuch der Hochfrequenztechnik, Springer
- ◆ Very useful as well: Matthaei, G, Young, L and Jones, E M T, Microwave Filters, Impedance-Matching Networks, and Coupling Structures, Artech House

# Appendix

- ◆ **The RF diode**
- ◆ **The RF mixer**
- ◆ **Backup slides**

# The RF diode (1)

- ◆ We are not discussing the generation of RF signals here, just the detection
- ◆ Basic tool: fast RF\* diode (= Schottky diode)
- ◆ In general, Schottky diodes are fast but still have a voltage dependent junction capacity (metal – semiconductor junction)



Agilent 423B

- ◆ Equivalent circuit:

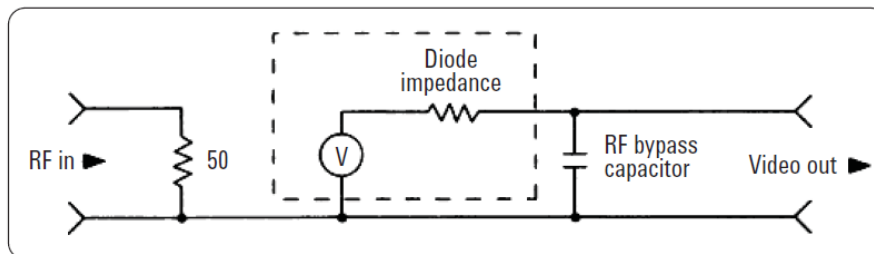

- ◆ A typical RF detector diode

- ◆ Try to guess from the type of the connector which side is the RF input and which is the output

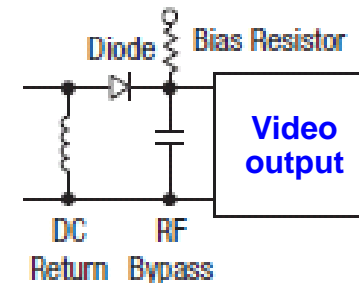

- ◆ \*Please note, that in this lecture we will use RF for both the RF and micro wave (MW) range, since the borderline between RF and MW is not defined unambiguously



# The RF diode (2)

- ◆ Characteristics of a diode:
- ◆ The current as a function of the voltage for a barrier diode can be described by the Richardson equation:

$$I = AA^{**} \exp\left(-\frac{q\phi_B}{kT}\right) \left[\exp\left(\frac{qV}{nKT}\right) - 1\right]$$

where

A = area (cm<sup>2</sup>)

A\*\* = modified Richardson constant (amp/oK)<sup>2</sup>/cm<sup>2</sup>)

k = Boltzman's Constant

T = absolute temperature (°K)

φB = barrier heights in volts

V = external voltage across the depletion layer  
(positive for forward voltage) - V - IR<sub>S</sub>

R<sub>S</sub> = series resistance

I = diode current in amps (positive forward current)

n = ideality factor

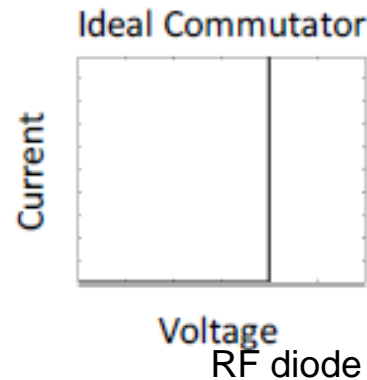
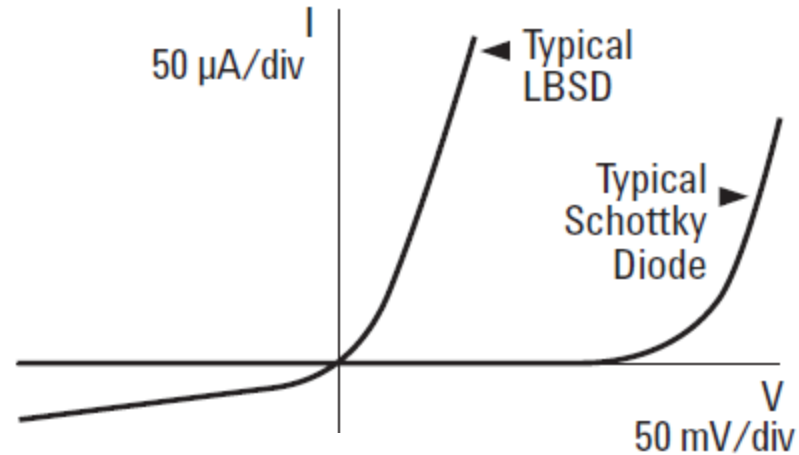

- ◆ The RF diode is NOT an ideal commutator for small signals! We cannot apply big signals otherwise burnout

# The RF diode (3)

- ◆ In a highly simplified manner, one can approximate this expression as:

$$I = I_S \left[ \exp \left( \frac{V_J}{0.028} \right) - 1 \right] \quad \text{◆ } V_J \dots \text{ junction voltage}$$

- ◆ and show as sketched in the following, that the RF rectification is linked to the second derivation (curvature) of the diode characteristics:

If the DC current is held constant by a current regulator or a large resistor, then the total junction current, including RF, is

$$I = I_0 = i \cos \omega t$$

and the I-V relationship can be written

$$\begin{aligned} V_J &= 0.028 \text{Ln} \left( \frac{I_S + I_0 + i \cos \omega t}{I_S} \right) \\ &= 0.028 \text{Ln} \left( \frac{I_0 + I_S}{I_S} \right) + 0.028 \text{Ln} \left( \frac{i \cos \omega t}{I_0 + I_S} \right) \end{aligned}$$

If the RF current,  $i$ , is small enough, the LN-term can be approximated in a Taylor series:

$$\begin{aligned} V_J &\approx 0.028 \text{Ln} \left( \frac{I_0 + I_S}{I_S} \right) + 0.028 \left[ \frac{i \cos \omega t}{I_0 + I_S} - \frac{i^2 \cos^2 \omega t}{2(I_0 + I_S)^2} + \dots \right] \\ &= V_{DC} + V_J \cos \omega t + \text{higher frequency terms} \end{aligned}$$

If you use the fact that the average value of  $\cos^2$  is 0.50, then the RF and DC voltages are given by the following equations:

$$V_J = \frac{0.028}{I_0 + I_S} \quad i = R_S i$$

$$V_{DC} = 0.028/n \left( 1 + \frac{I_0}{I_S} \right) - \frac{0.028^2}{4(I_0 + I_S)^2} = V_0 - \frac{V_J^2}{0.112}$$

RF diode

# The RF diode (4)

- ◆ This diagram depicts the so called square-law region where the output voltage ( $V_{\text{Video}}$ ) is proportional to the input power

Since the input power is proportional to the square of the input voltage ( $V_{\text{RF}}^2$ ) and the output signal is proportional to the input power, this region is called square-law region.

In other words:

$$V_{\text{Video}} \sim V_{\text{RF}}^2$$

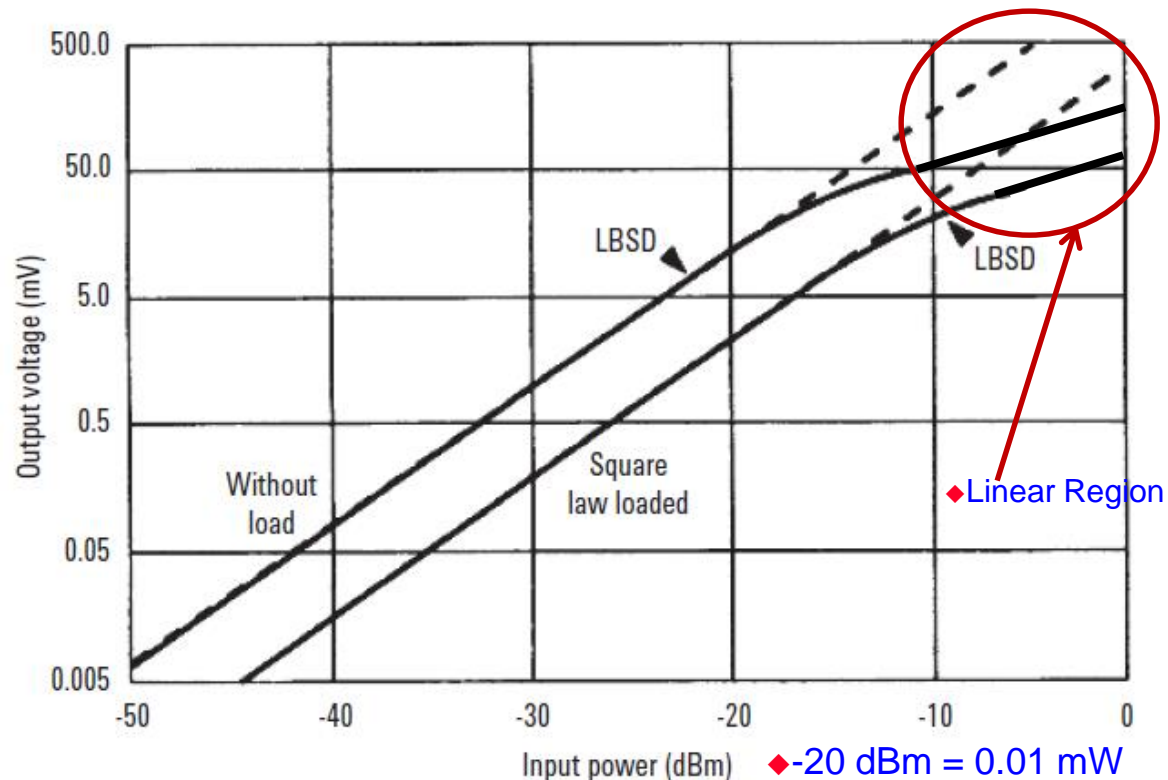

- ◆ The transition between the linear region and the square-law region is typically between -10 and -20 dBm RF power (see diagram)

# The RF diode (5)

- ◆ Due to the square-law characteristic we arrive at the thermal noise region already for moderate power levels (-50 to -60 dBm) and hence the  $V_{\text{Video}}$  disappears in the thermal noise
- ◆ This is described by the term *tangential signal sensitivity* (TSS) where the detected signal (Observation BW, usually 10 MHz) is 4 dB over the thermal noise floor

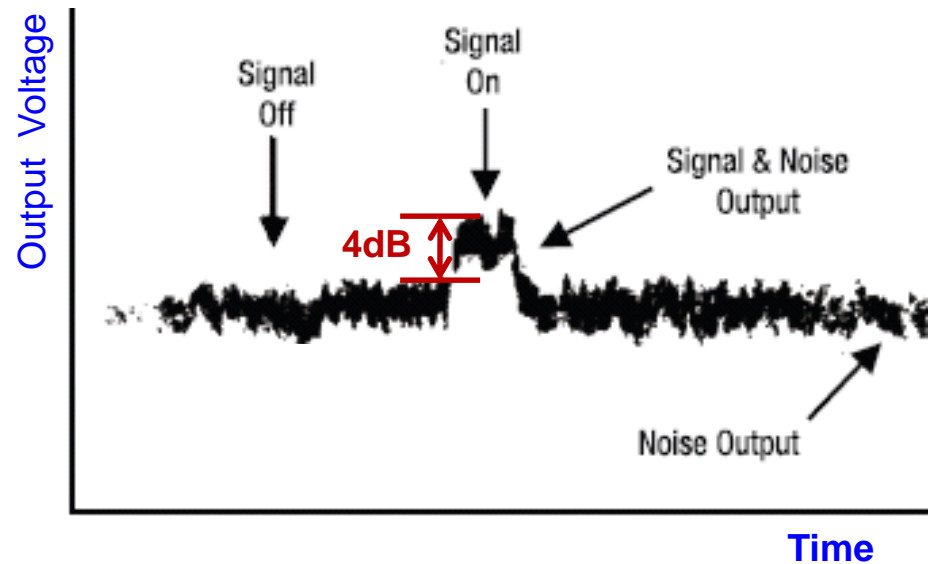

If we apply an RF-signal to the detector diode with the same power as its TSS, its output voltage will be 4 dB over the thermal noise floor.

# The RF mixer (1)

- ◆ For the detection of very small RF signals we prefer a device that has a linear response over the full range (from 0 dBm (= 1mW) down to thermal noise (= -174 dBm/Hz =  $4 \cdot 10^{-21}$  W/Hz)
- ◆ This is the RF mixer which is using 1, 2 or 4 diodes in different configurations (see next slide)
- ◆ Together with a so called LO (local oscillator) signal, the mixer works as a signal multiplier with a very high dynamic range since the output signal is always in the “linear range” provided, that the mixer is not in saturation with respect to the RF input signal (For the LO signal the mixer should always be in saturation!)
- ◆ The RF mixer is essentially a multiplier implementing the function

$f_1(t) \cdot f_2(t)$  with  $f_1(t)$  = RF signal and  $f_2(t)$  = LO signal

$$a_1 \cos(2\pi f_1 t + \varphi) \cdot a_2 \cos(2\pi f_2 t) = \frac{1}{2} a_1 a_2 [\cos((f_1 + f_2)t + \varphi) + \cos((f_1 - f_2)t + \varphi)]$$

- ◆ Thus we obtain a response at the IF (intermediate frequency) port that is at the sum and difference frequency of the LO and RF signals

# The RF mixer (2)

## ◆ Examples of different mixer configurations

### A. Single-Ended Mixer

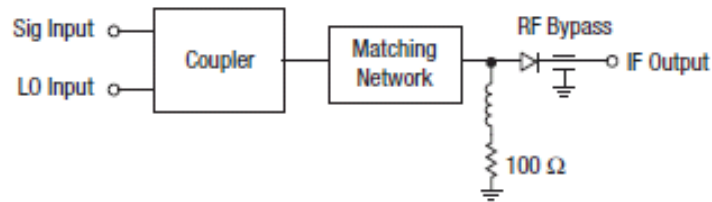

### B. Balanced Mixers

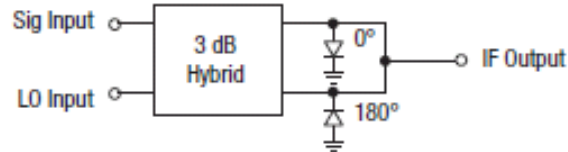
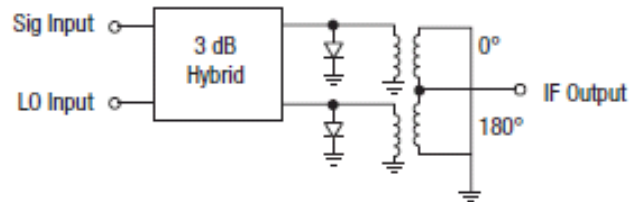

### C. Double-Balanced Mixer

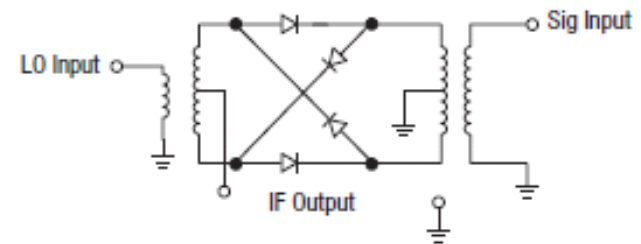

A typical coaxial mixer (SMA connector)

# The RF mixer (3)

- ◆ Response of a mixer in time and frequency domain:

Input signals here:

LO = 10 MHz

RF = 8 MHz

Mixing products at

2 and 18 MHz

plus higher order terms  
at higher frequencies

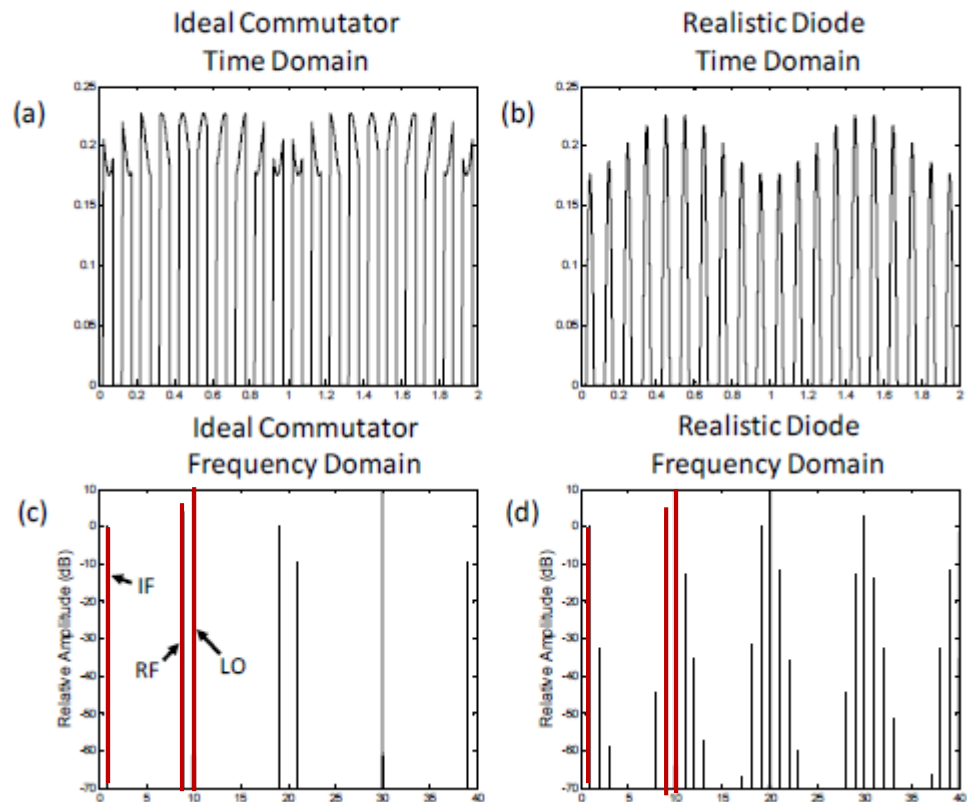

# Dynamic range and IP3 of an RF mixer

- ◆ The abbreviation IP3 stands for the third order intermodulation point where the two lines shown in the right diagram intersect.
- ◆ Two signals ( $f_1, f_2 > f_1$ ) which are closely spaced by  $\Delta f$  in frequency are simultaneously applied to the DUT.
- ◆ The intermodulation products appear at  $+\Delta f$  above  $f_2$  and at  $-\Delta f$  below  $f_1$
- ◆ This intersection point is usually not measured directly, but extrapolated from measurement data at much smaller power levels in order to avoid overload and damage of the DUT

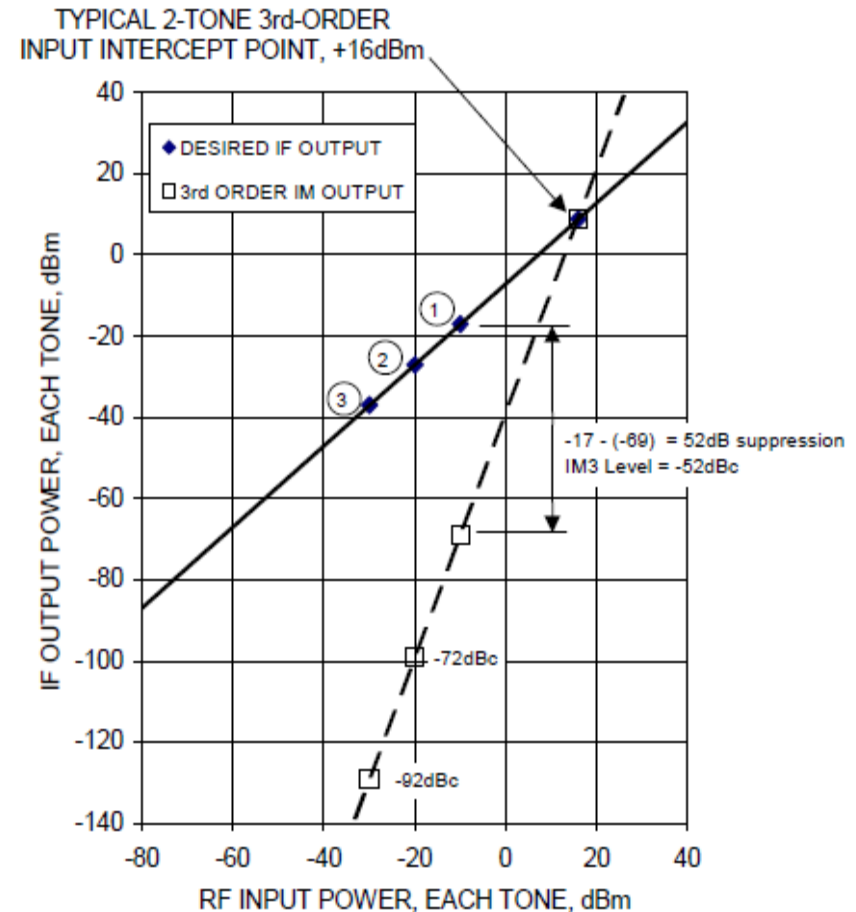



# Solid state diodes used for RF applications

- ◆ There are many other diodes which are used for different applications in the RF domain

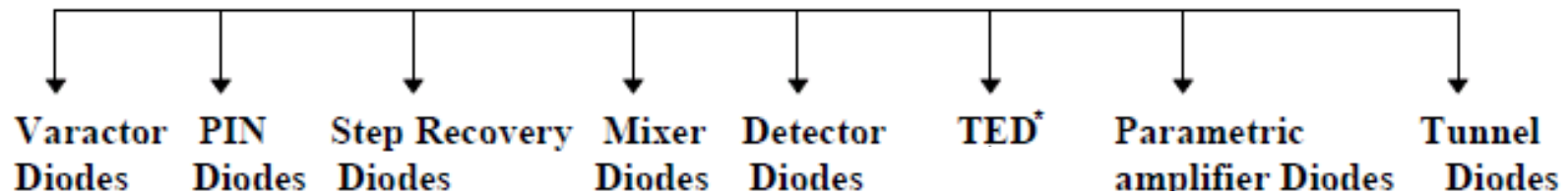

\* Transferred Electron Devices

- ◆ Varactor diodes: for tuning applications
- ◆ PIN diodes: for electronically variable RF attenuators
- ◆ Step Recovery diodes: for frequency multiplication and pulse sharpening
- ◆ Mixer diodes, detector diodes: usually Schottky diodes
- ◆ TED (GUNN, IMPATT, TRAPATT etc.): for oscillator
- ◆ Parametric amplifier Diodes: usually variable capacitors (vari caps)
- ◆ Tunnel diodes: rarely used these days, they have negative impedance and are usually used for very fast switching and certain low noise amplifiers

# Looking through a 2-port (1)

In general:

$$\Gamma_{in} = S_{11} + \frac{S_{12}S_{21}\Gamma_L}{1 - S_{22}\Gamma_L}$$

where  $\Gamma_{in}$  is the reflection coefficient when looking through the 2-port and  $\Gamma_{load}$  is the load reflection coefficient.

Line  $\lambda/16$ :

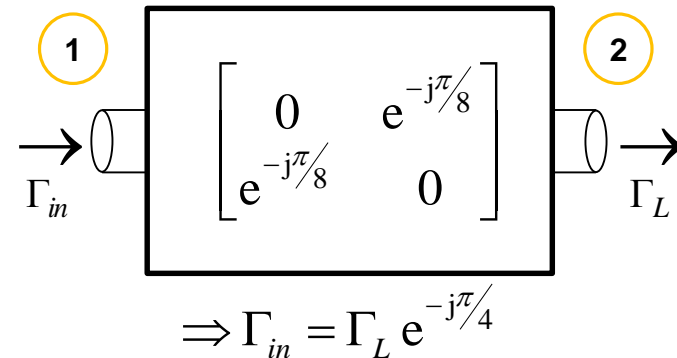
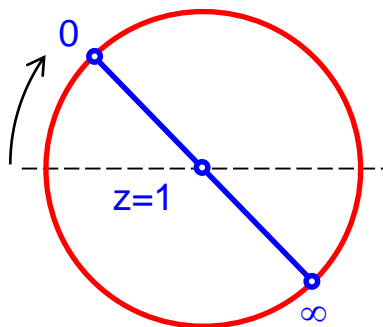

The outer circle and the real axis in the simplified Smith diagram below are mapped to other circles and lines, as can be seen on the right.

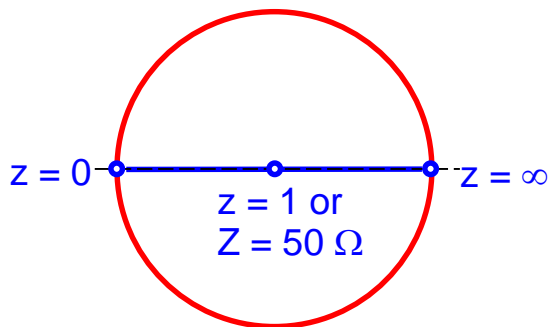

Attenuator 3dB:

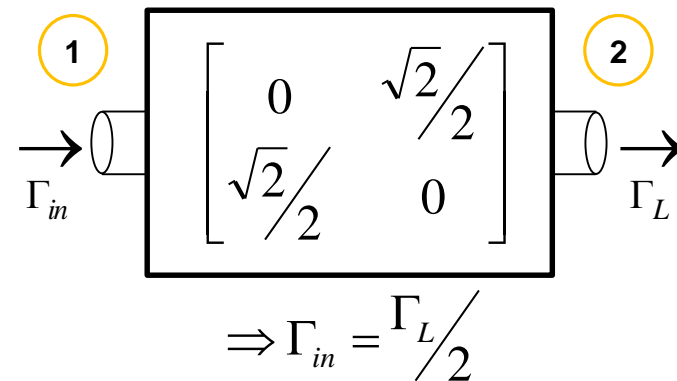
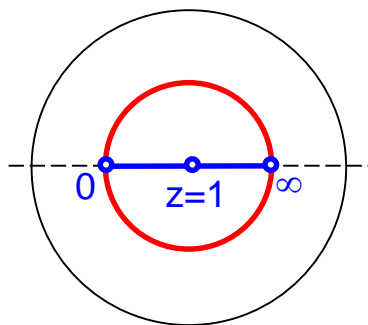

# Looking through a 2-port (2)

Lossless  
Passive  
Circuit

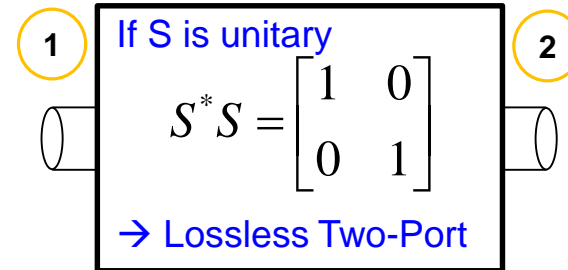
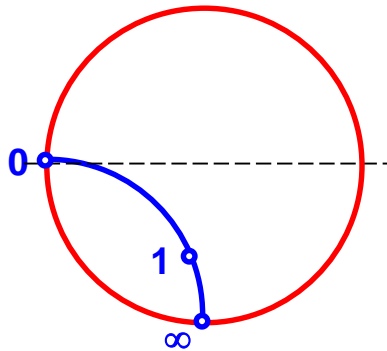

Lossy  
Passive  
Circuit

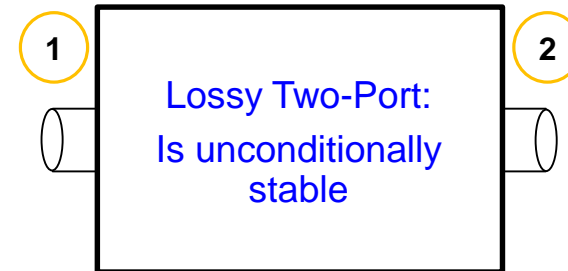
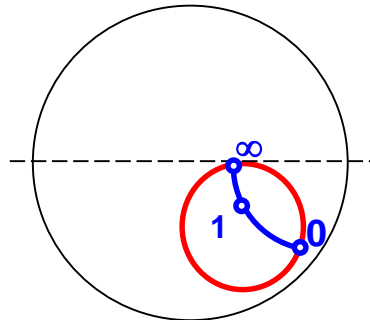

Active  
Circuit

