

FÍSICA DE PARTÍCULAS

(Y COSMOLOGÍA, Y ONDAS GRAVITACIONALES...)

EN EL AULA

¿SE PUEDE? ¿SE DEBE?

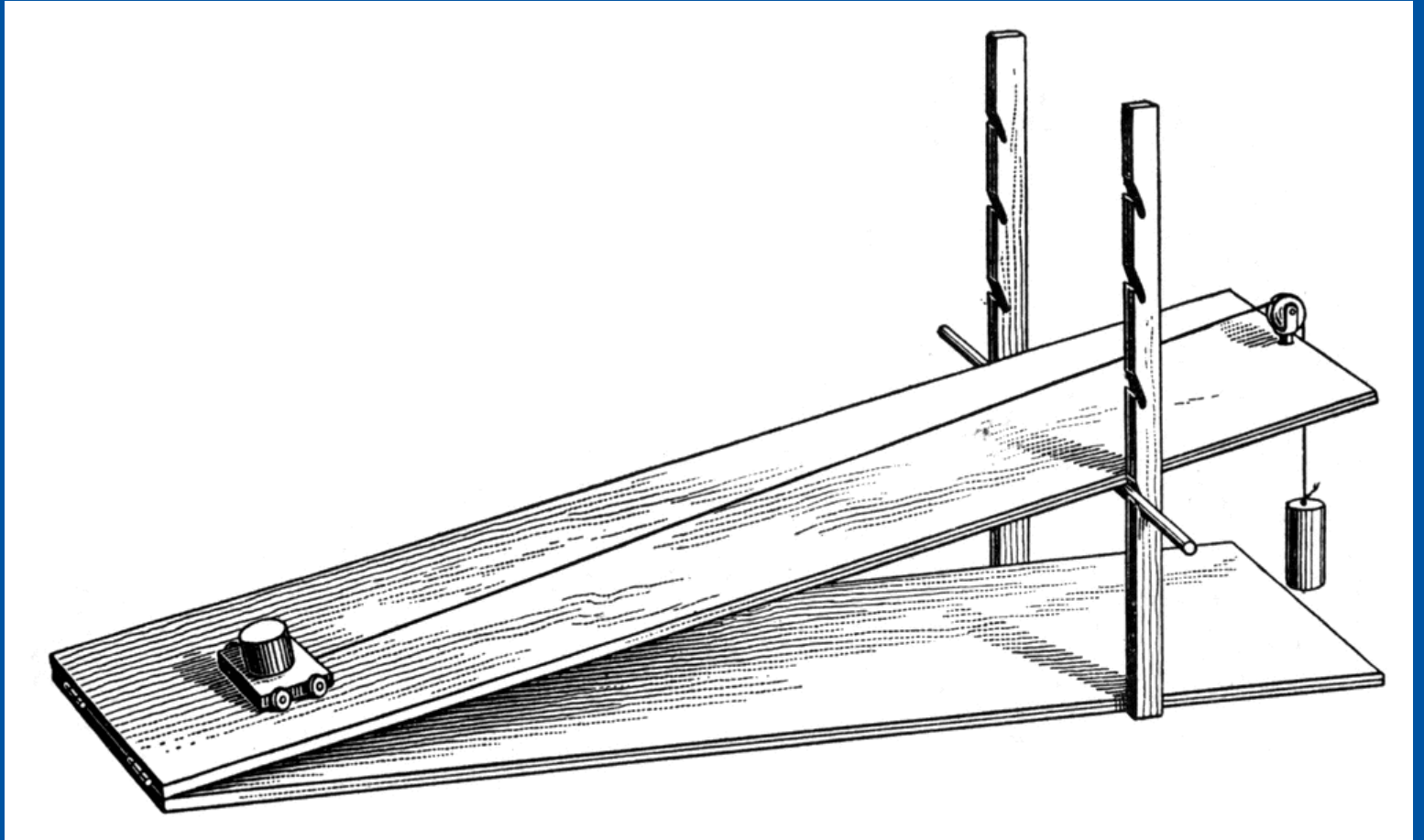
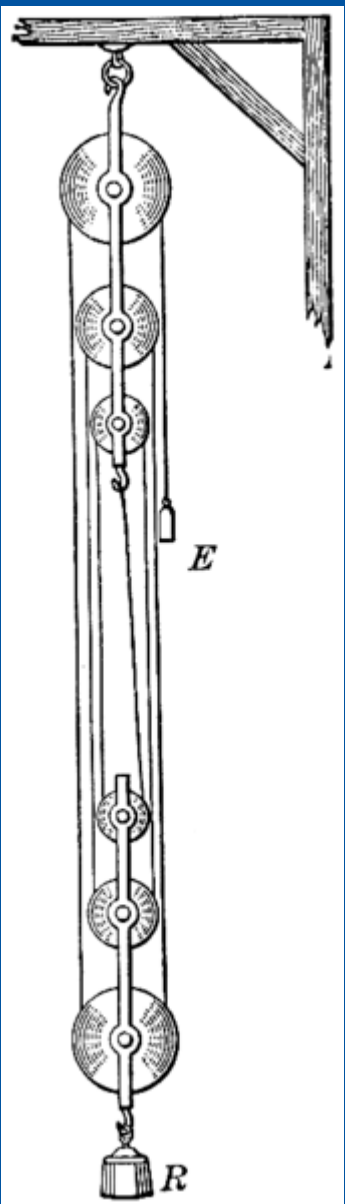

**AUNQUE EL CERN NO SEA EL
MEJOR SITIO PARA HABLAR
DE ESTO...**

¡PARECE MENTIRA!



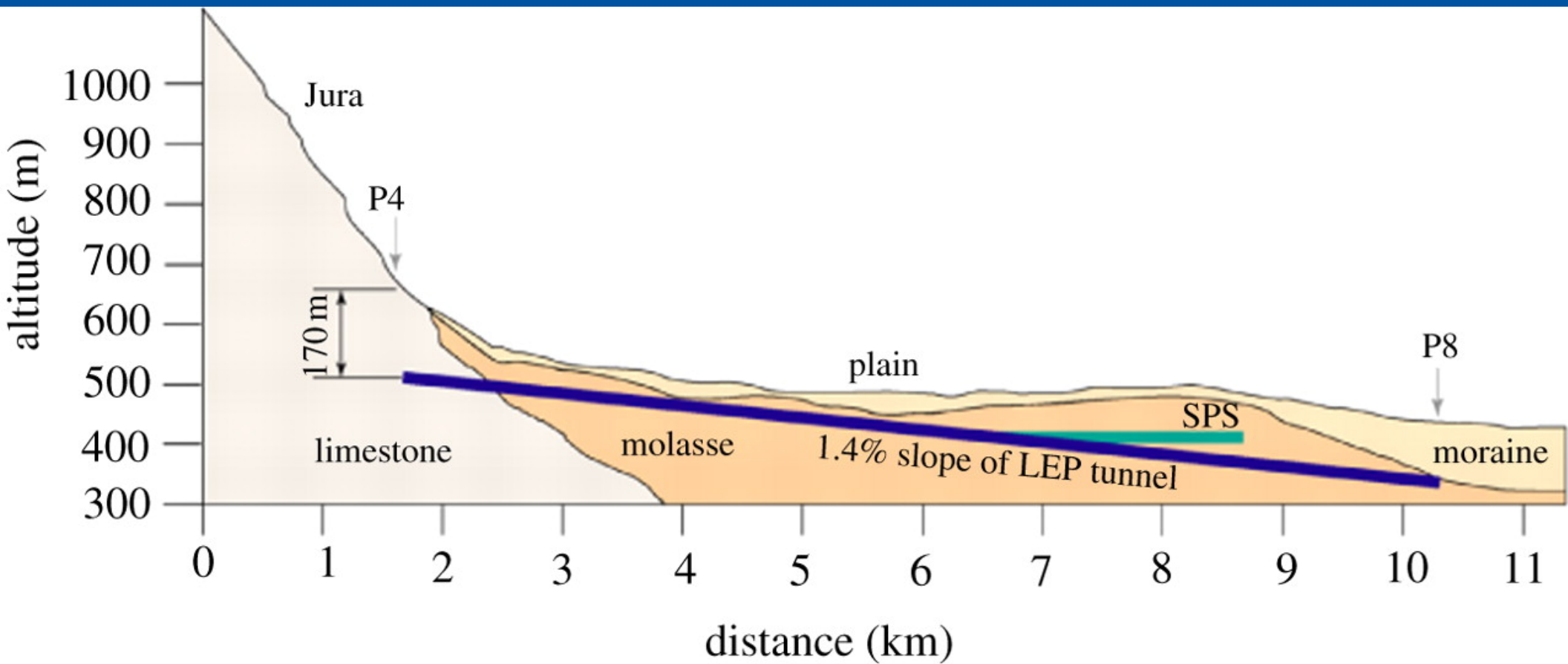

CMS Heavy Lowering

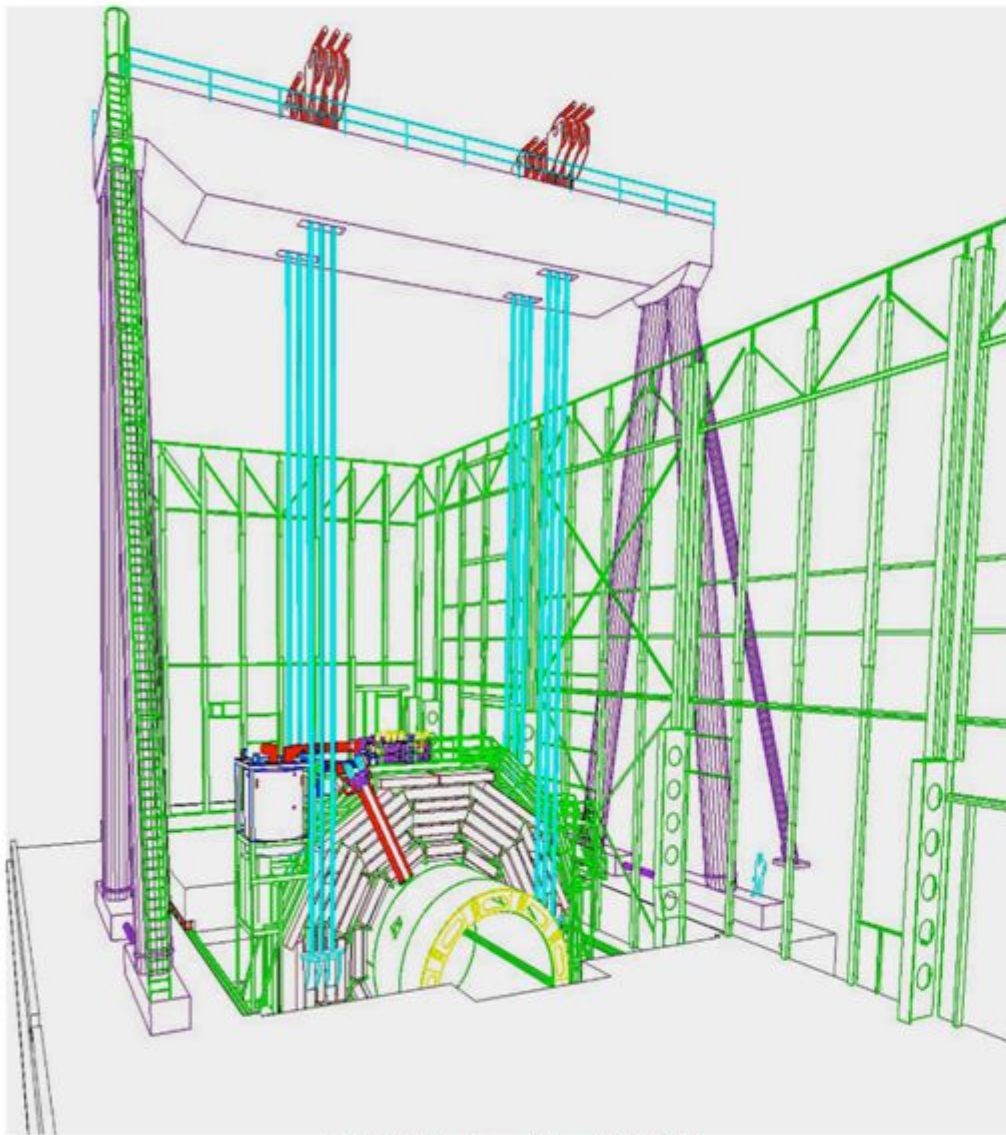

Gigi Rolandi - CERN

303

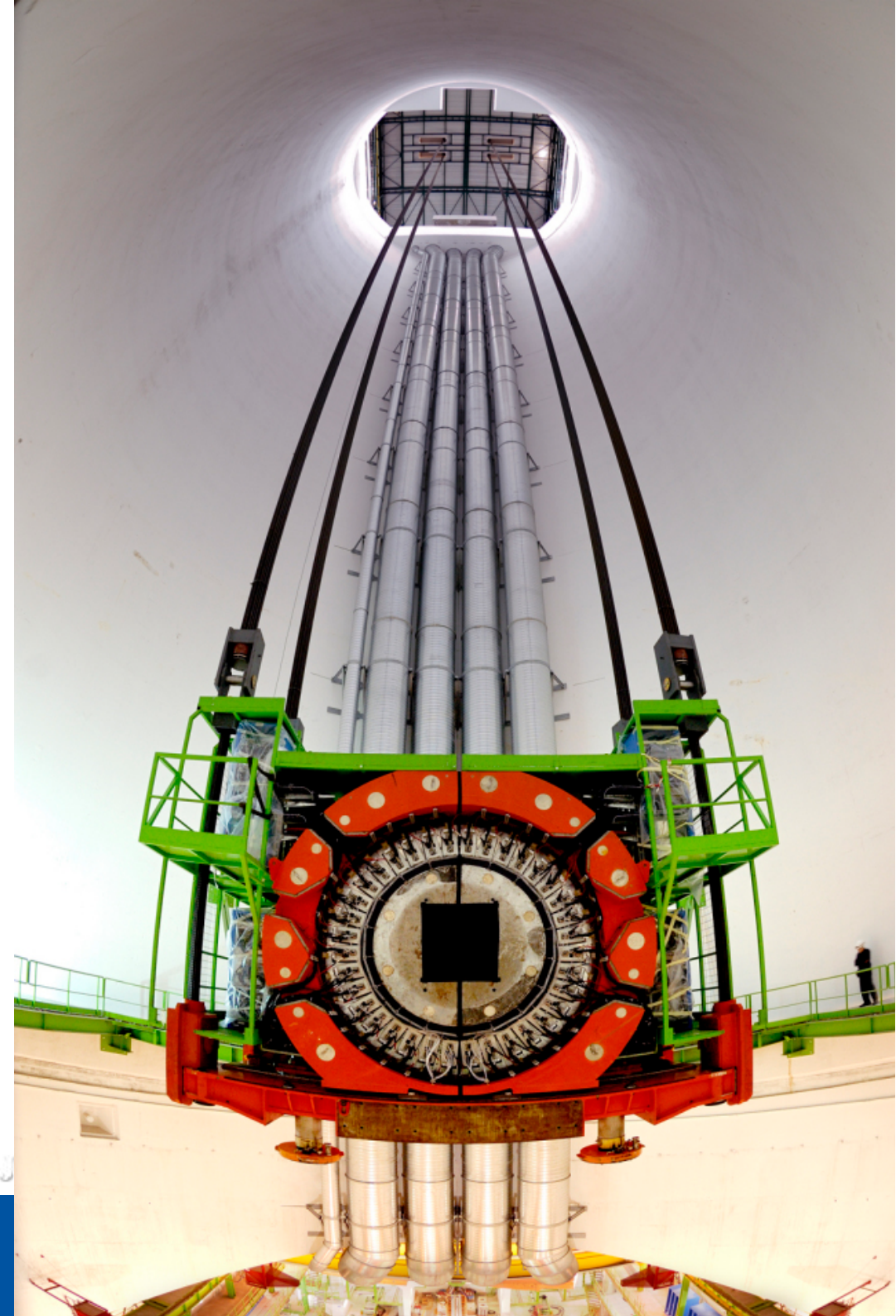

What if you had to take an art class in which you were taught only how to paint a fence, but were never shown the paintings of van Gogh or Picasso?

Alas, this is how math is taught, and so for most of us it becomes the intellectual equivalent of watching paint dry.

How our 1,000-year-old math curriculum cheats America's kids

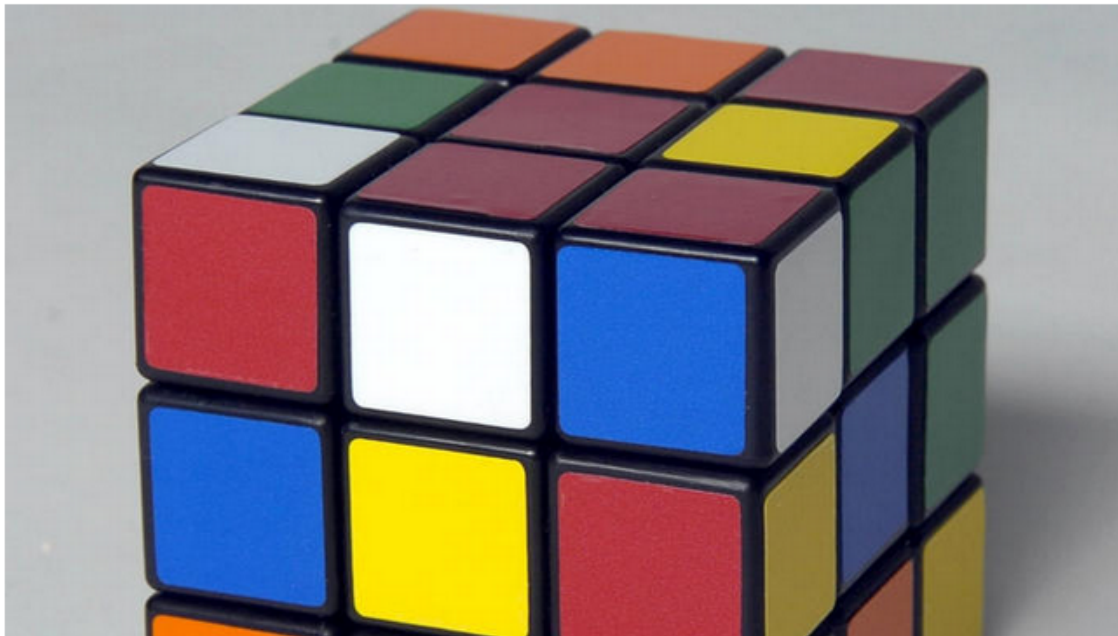

Ed Frenkel

You can use a Rubik's Cube to explain symmetry groups: Every rotation of the cube is a "symmetry," and these combine into what mathematicians call a group. (Jeffrey F. Bill / The Baltimore Sun)

By [Edward Frenkel](#)

MARCH 2, 2014

Imagine you had to take an art class in which you were taught how to paint a fence or a wall, but you were never shown the paintings of the great masters, and you weren't even told that such paintings existed. Pretty soon you'd be asking, why study art?

That's absurd, of course, but it's surprisingly close to the way we teach children

ibreOffice Impress

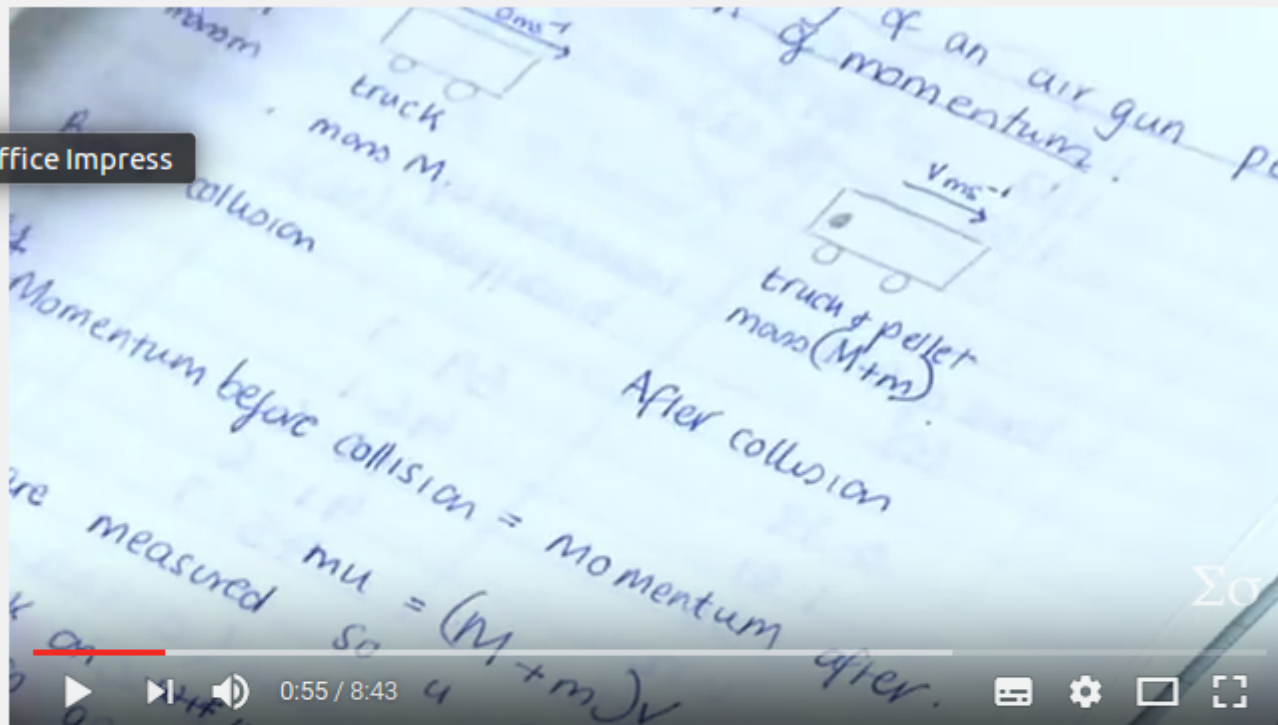

Problems with High School Physics - Sixty Symbols

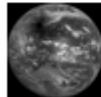

Sixty Symbols ✓

Suscribirse 644 K

594.500 visualizaciones

+ Añadir a ➦ Compartir ... Más

👍 12.451 🗨️ 130

Publicado el 11 nov. 2012

Minute Physics video at: <http://youtu.be/BGL22PTIOAM>

More from Ed, Phil and Tony's interviews at: <http://bit.ly/SO4Hrh>

<https://youtu.be/Xzn2ecB4Hzs>





0:46 / 3:48

▶ ⏩ 🔊

📄 ⚙️ 📺 🗉

Open Letter to the President: Physics Education

 MinutoDeFísica

 **Suscribirse** 3,8 M

1.819.272 visualizaciones

✚ Añadir a ➡️ Compartir ⋮ Más

👍 41.894 🗨️ 887

Muy bonito, sí, pero y ahora...

¿qué?

**FÍSICA
DE PARTÍCULAS
EN EL
INSTITUTO**

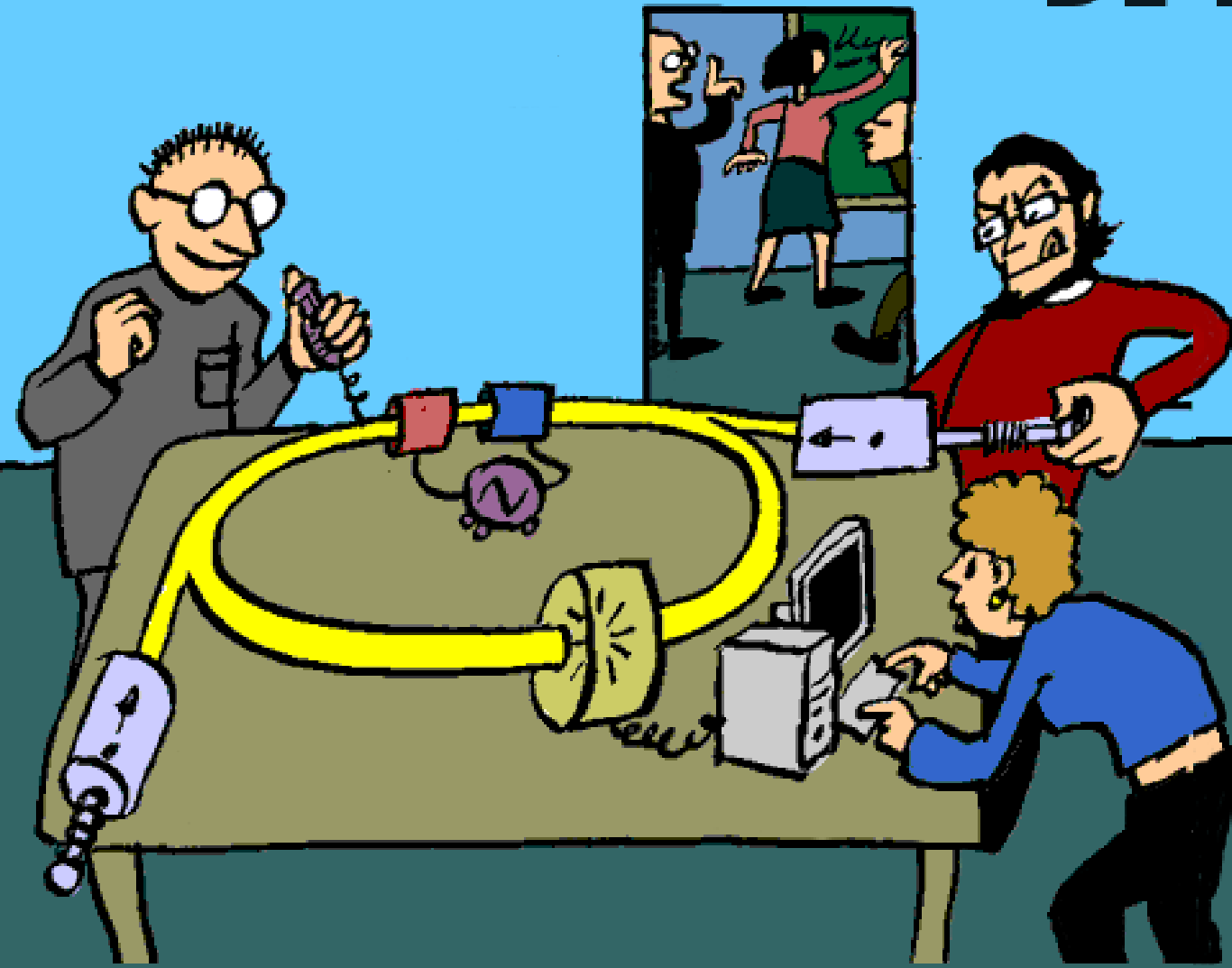

FÍSICA DE
PARTÍCULAS PARA
PROFESORES DE
CIENCIAS Y
TECNOLOGÍA

**Lo que podemos
hacer**

EN EL AULA (y más allá)

¿Hay para todos
los que enseñan ciencias y
tecnología?

Run:event 4177:115034 Date 930612 Time 10314 Ctrk(N= 0 Sump= 0.0) Ecal(N= 8 SumE= 97.4) Hcal(N= 1 SumE= 2.5)
Ebeam 45.861 Evis 99.6 Emiss -8.3 Vtx (-0.04, 0.08, 0.45) Muon(N= 0) Sec Vtx(N= 0) Fdet(N= 0 SumE= 0.0)
Bz=4.350 Thrust=0.9957 Aplan=0.0000 Oblat=0.6285 Spher=0.0006

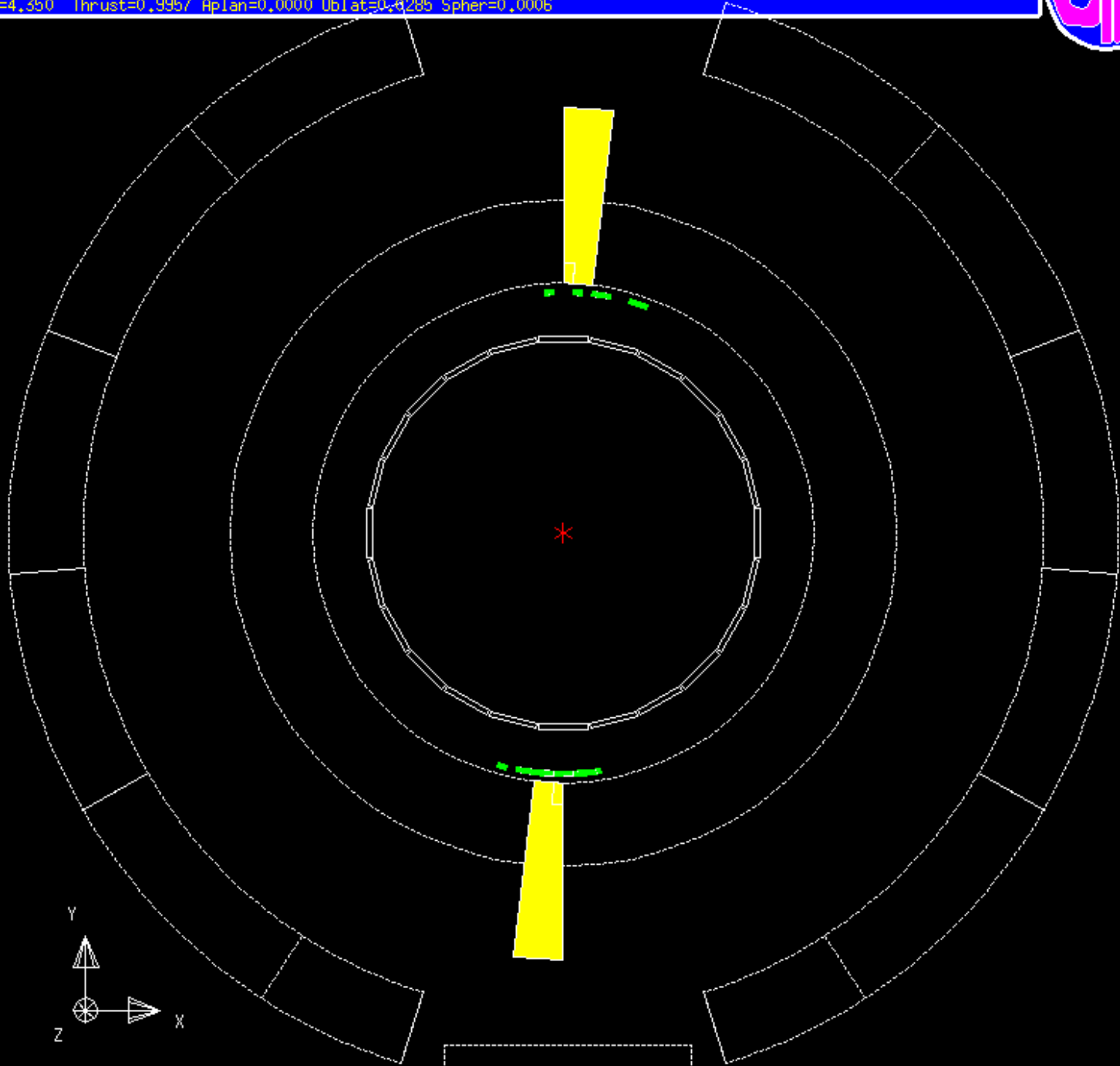

5 10 20 50 GeV

Centre of screen is (0.0000, 0.0000, 0.0000)

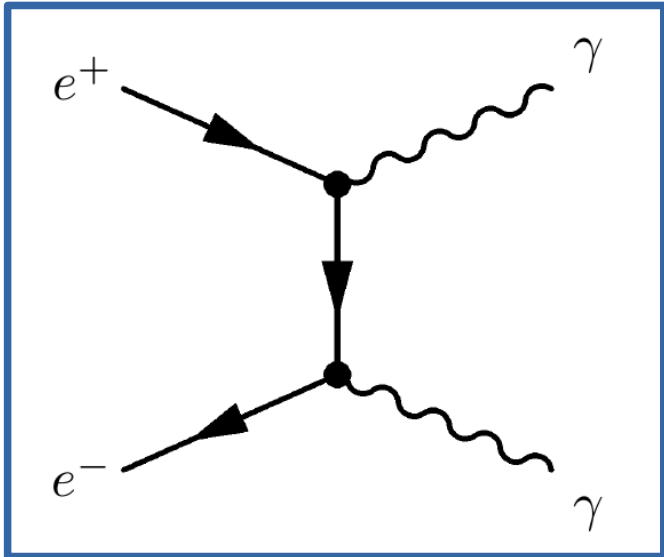

Article | 9 March 2015

Whole-body immunoPET reveals active SIV dynamics in viremic and antiretroviral therapy-treated macaques

Philip J Santangelo *et al.*

ImmunoPET/CT imaging using a labeled simian immunodeficiency virus (SIV)-specific antibody can identify sites of viral infection in SIV-infected

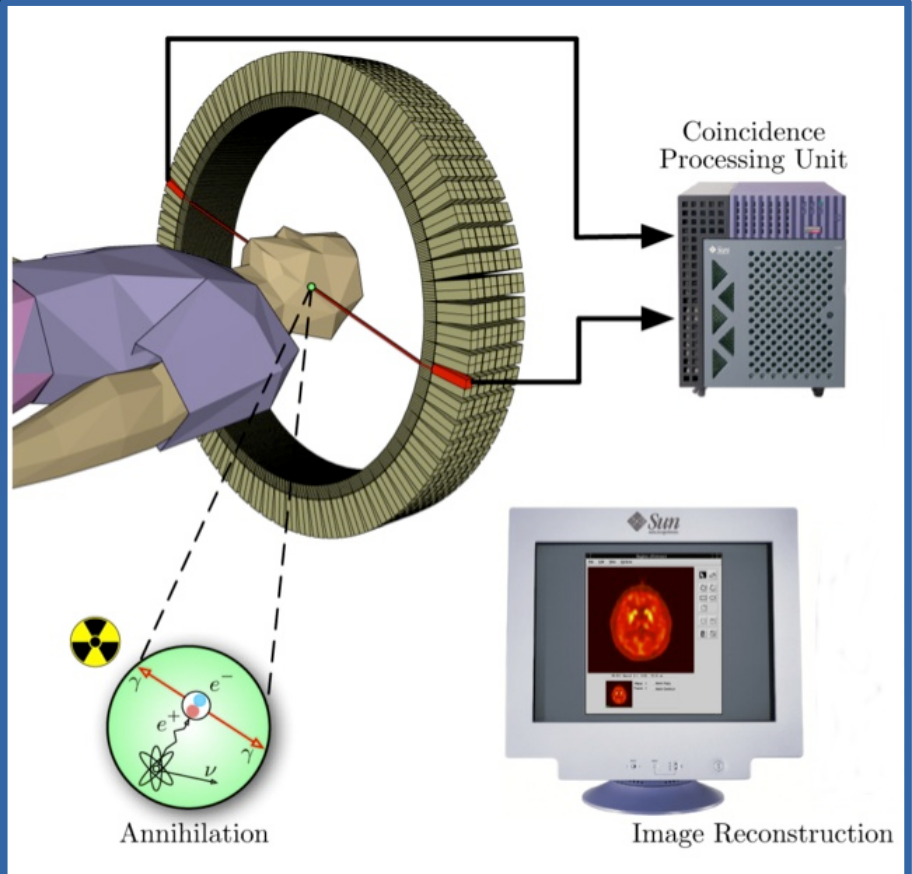
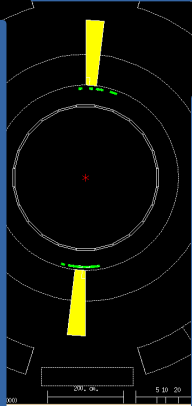
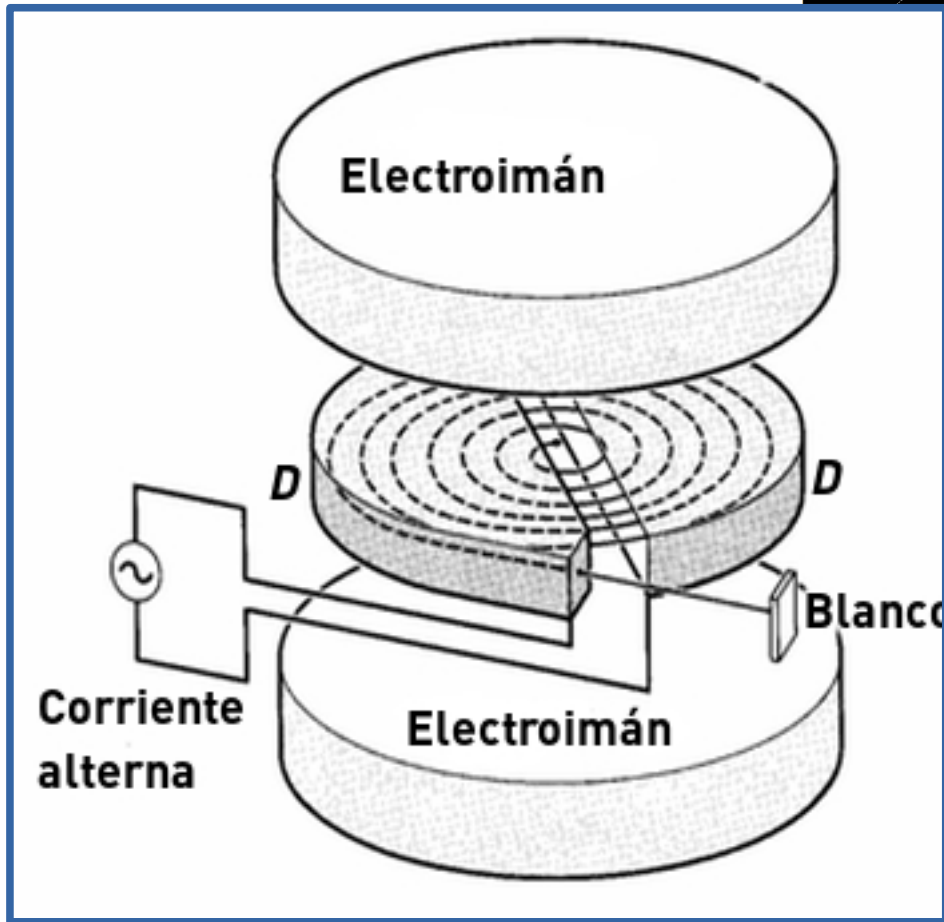
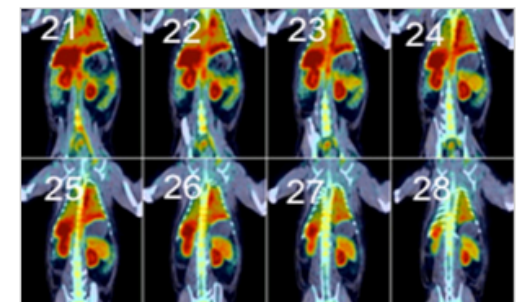

Pues sí...

con diferentes enfoques

**Y al menos por dos
motivos:**

**La importancia
“cultural” de la física
fundamental**

Las “aplicaciones”

Lo que podemos hacer en el aula

1. El *programa mínimo*.
2. Adaptarlo al currículo existente.
3. Introducirlo en el currículo.

**¿SE ACABÓ LA CIENCIA
EN EL SIGLO XIX?**

¿O SIQUIERA EN 1905 O EN LOS
AÑOS 1930?

**PUES A VECES LO
PARECE,**

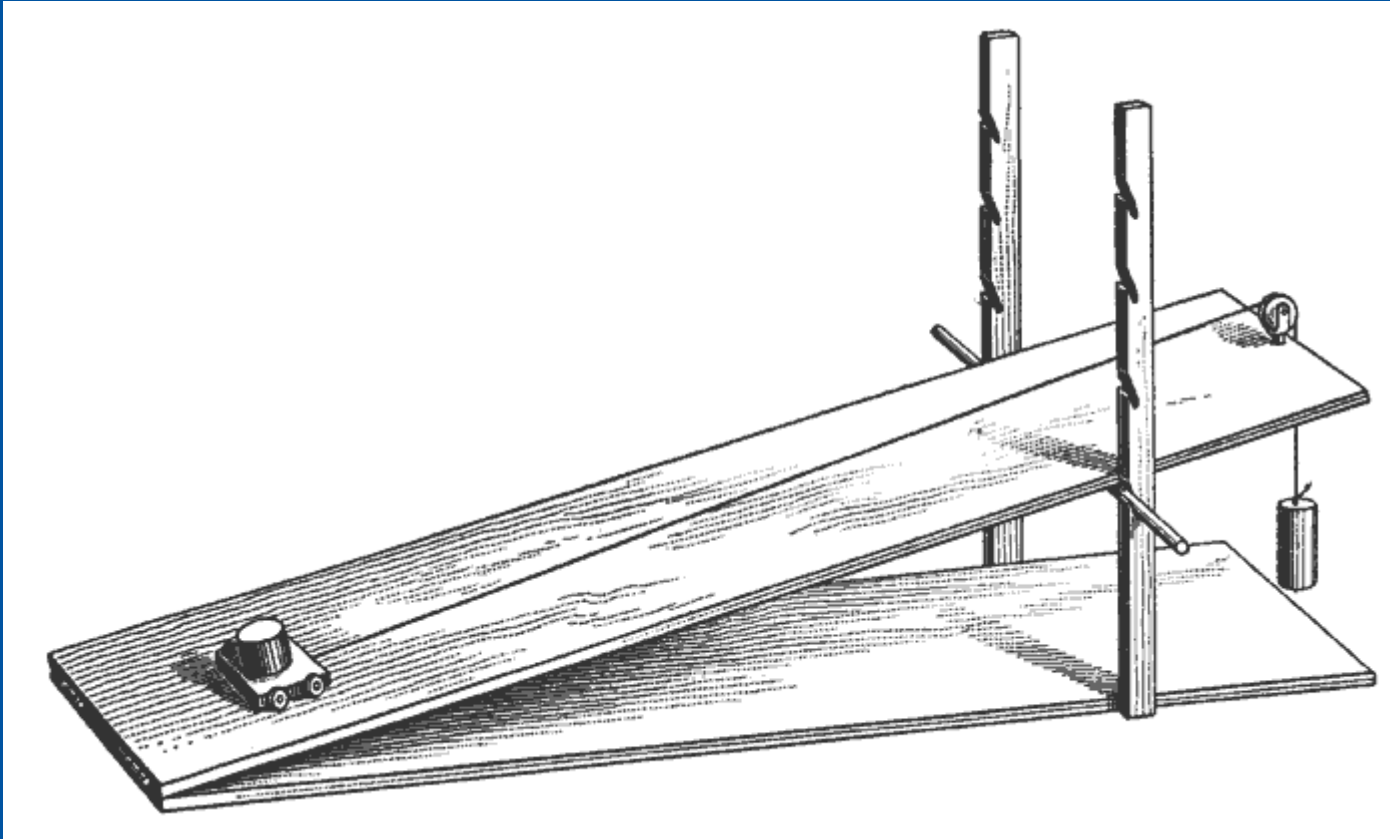

pero...

PROTON PHYSICS: STABLE BEAMS

Energy:

6499 GeV

I(B1):

1.78e+14

I(B2):

2.02e+14

Inst. Lumi [(ub.s)⁻¹]

IP1: 5986.83

IP2: 2.59

IP5: 6037.74

IP8: 446.13

FBCT Intensity and Beam Energy

Updated: 11:36:06

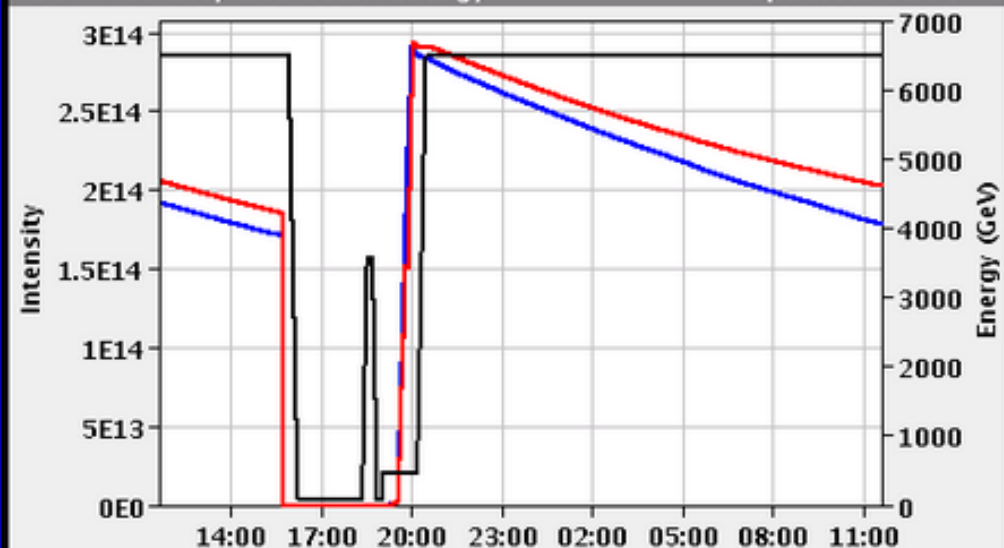

Instantaneous Luminosity

Updated: 11:36:06

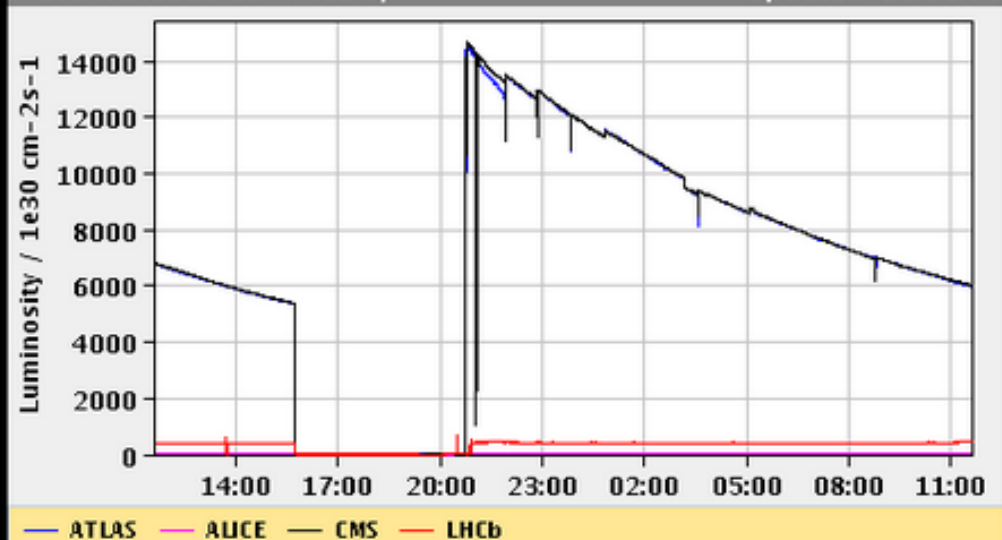

BIS status and SMP flags

B1

B2

Link Status of Beam Permits

true

true

Global Beam Permit

true

true

Setup Beam

false

false

Beam Presence

true

true

Moveable Devices Allowed In

true

true

Stable Beams

true

true

Comments (31-Jul-2017 09:42:08)

Fill for physics (XING at 120urad)

Dump planned around 12noon

AFS: 25ns_2556b_2544_2215_2332_144bpi_20inj

PM Status B1

ENABLED

PM Status B2

ENABLED



CMS DAQ Status

Running

LHC Status

STABLE

Beam Energy

6499 GeV

Intensity

Beam1: 1.8×10^{14} Beam2: 2.0×10^{14} 

History of Data-taking with Stable Beams for Last 24 Hours

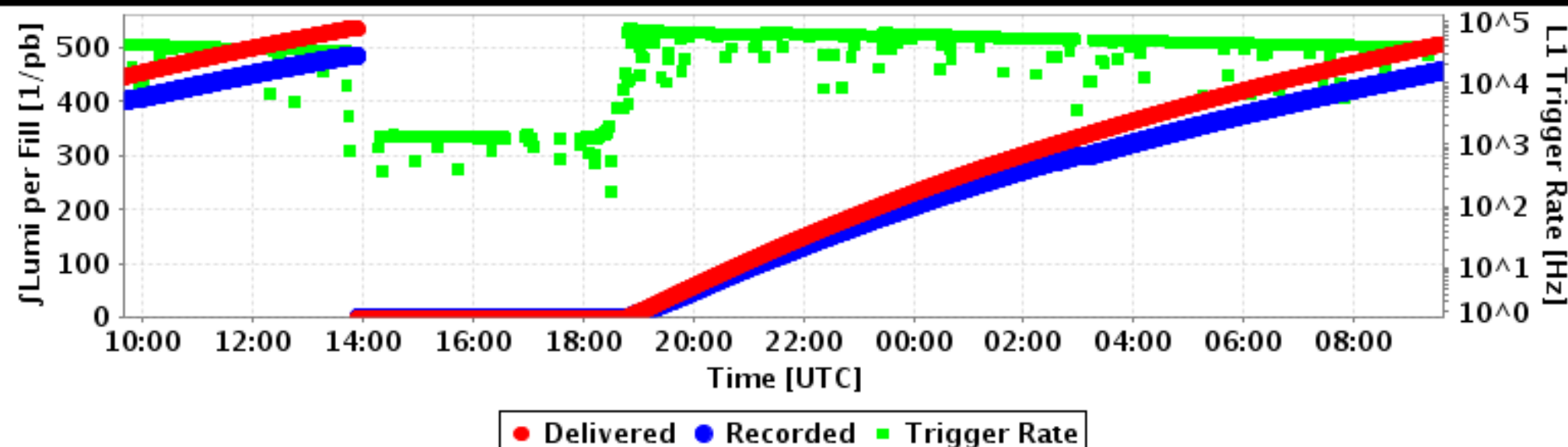

CMS Comments Sun 30-07-2017 18:54:29 UTC

happily taking pp collisions !

Sub-System DAQ / DCS

CSC	IN	ON
DT	IN	ON
ECAL	IN	ON
ES	IN	ON
HCAL	IN	ON
HF	IN	ON
PIXEL	IN	ON
RPC	IN	ON
TRACKER	IN	ON

Run/Trigger/DAQ Status

Fill Number	6026
Run Number	300157
LumiSection	996
Physics Bit Set	ON
Magnet [T]	3.801
Total L1 Rate [Hz]	38429
Total L1 Triggers	983258531
Instant Lumi[E30]	6024.07
∫Lumi Rec[1/pb]	457.72
Tier0 Transfer	ON

LHC Page1 Comments Mon 31-07-2017 07:42:08 UTC

Fill for physics (XING at 120urad)

Dump planned around 12noon

DAQ	IN
DQM	IN
SCAL	IN
TRG	IN
CTPPS_TOT	IN



CMS Experiment at LHC, CERN
Data recorded: Mon Jul 31 11:43:16 2017 CEST
Run/Event: 300157 / 994864223
Lumi section: 1009

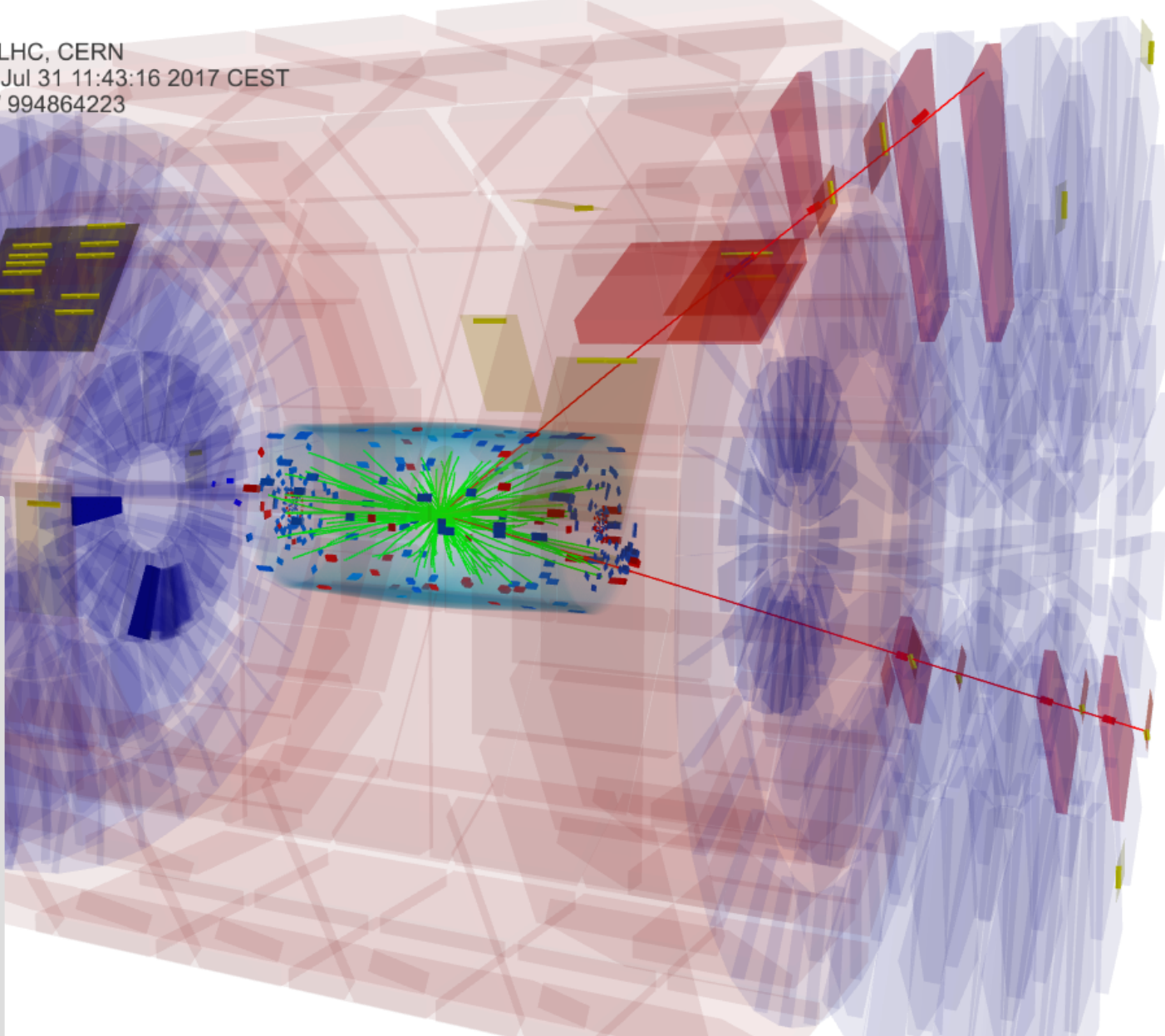

<http://mcmstv.web.cern.ch/mcmstv/#evd>

<https://op-webtools.web.cern.ch/op-webtools/vistar/vistars.php>

EL PROGRAMA MÍNIMO

No se puede ignorar lo que estamos aprendiendo aquí...

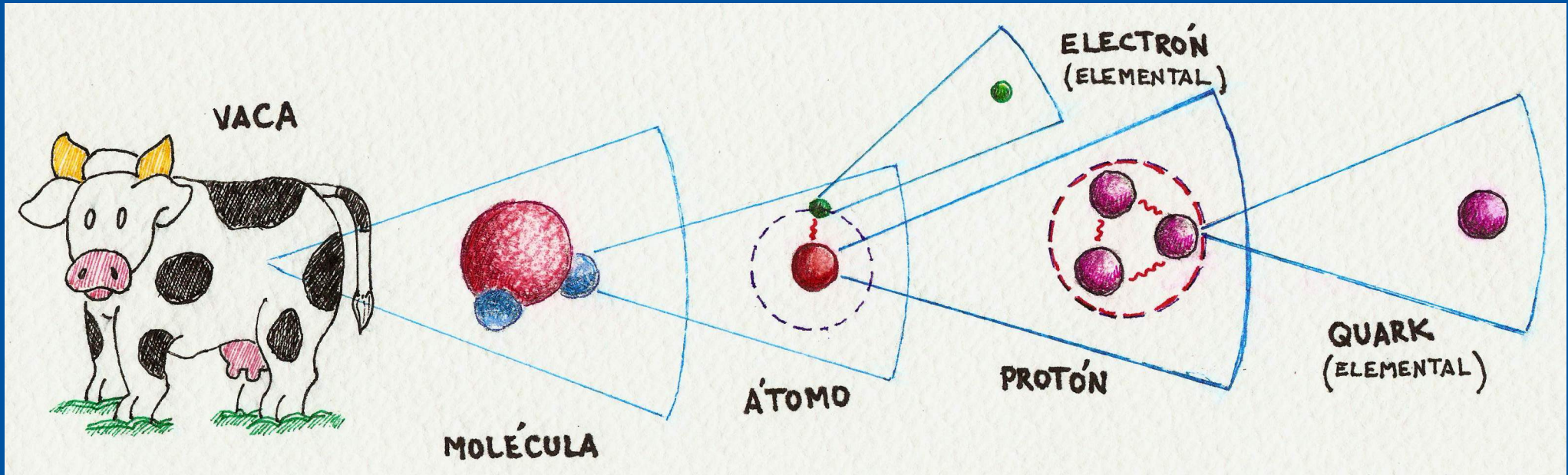

AHORA HAY QUE DEFINIR ESOS
ELEMENTOS MÍNIMOS

EXPERIMENTO ACCELERADOR INTERACCIONES PARTICULAS COLISIONES DETECTOR

$E=mc^2$

TEÓRICOS ELECTRÓN DATOS MEDIADORAS FUERZAS METODOS FÍSICA UNIDAS TEORÍA DOS ELECTROMAGNÉTICA BÁSICOS TOTAL QUARKS INTERCAMBIO COMPONENTES EXPRESIÓN GENERAL SI GRÁFICO RESULTARÍA COMPORTAMIENTO ELECTRÓNICO HACEN HACER RESULTADO CERTA PUEDEN

FOTONES MODELO ELEMENTALES FUERZA UNIVERSO PROCESOS NEUTRÓN ESTÁNDAR PROTÓN COSAS NEUTRONES METODO DIAGRAMA GLUONES FAMILIAR POSIBLE ESTUDIA

QUARKS: u, c, t, d, s, b
 LEPTONS: e, μ , τ , ν_e , ν_μ , ν_τ
 FORCES: Z, γ , W, g
 Higgs boson

Quarks

u up	c charm	t top
d down	s strange	b bottom

Forces

Z Z boson	γ photon
W W boson	g gluon

Leptons

e electron	μ muon	τ tau
ν_e electron neutrino	ν_μ muon neutrino	ν_τ tau neutrino

H
Higgs boson

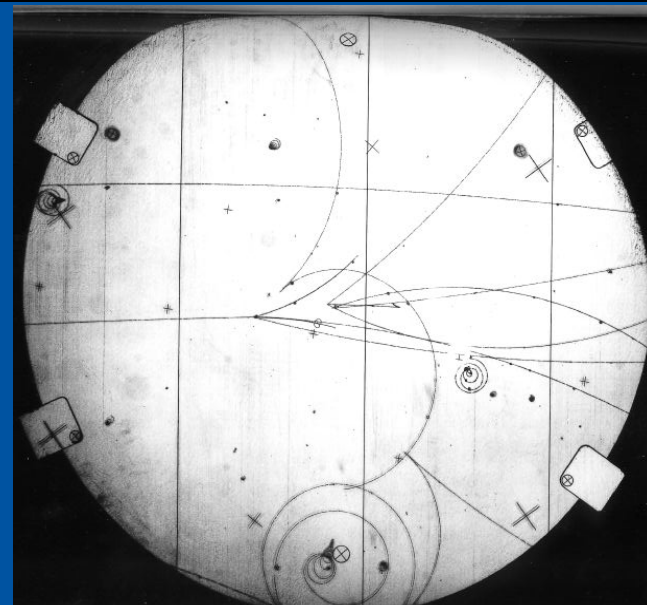

DOS CANDIDATOS CLAROS PARA EL PROGRAMA MÍNIMO:

A) Las partículas NO son bolitas

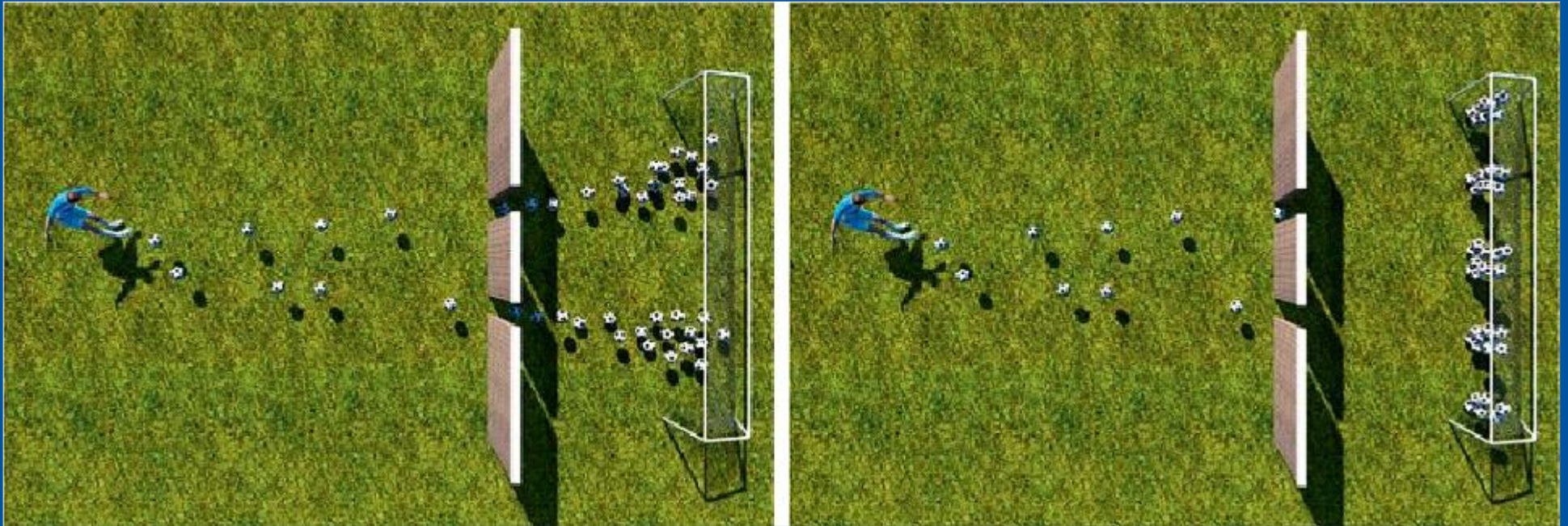

y hacen algunas cosas propias de las ondas



a

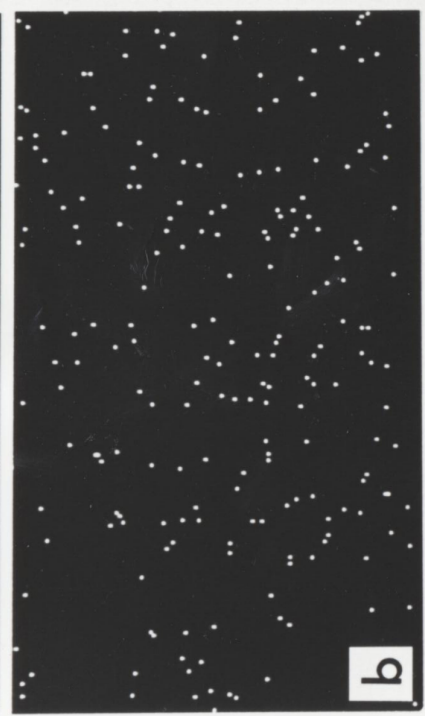

b

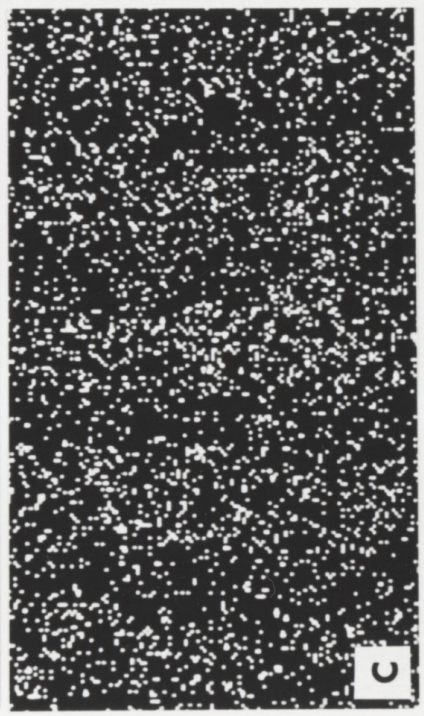

c

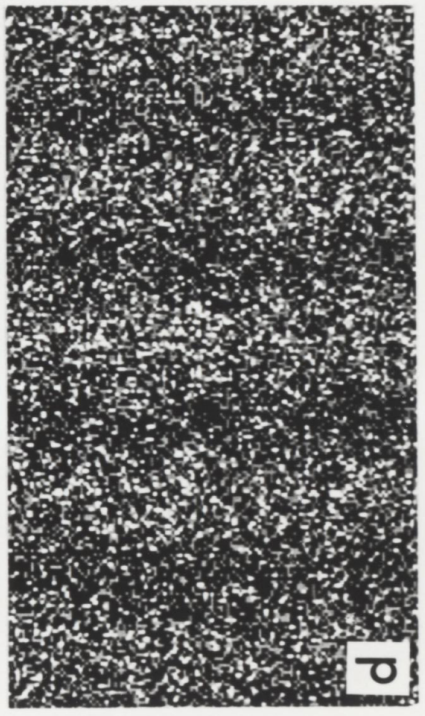

d

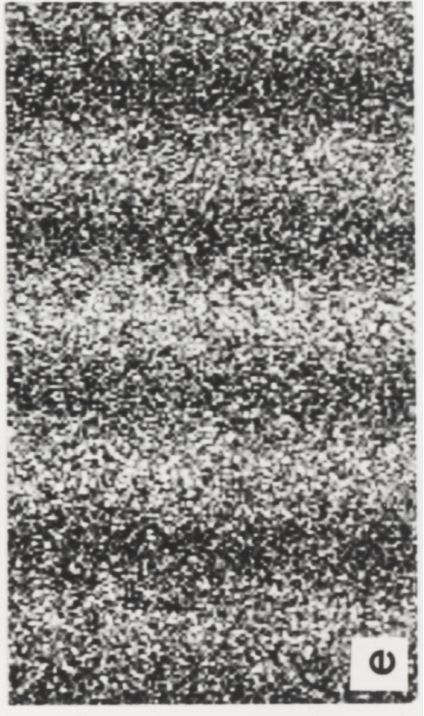

e

B) La física NO se acabó en los años 1930 cuando los átomos parecían estar compuestos de protones, neutrones y electrones

Por ejemplo, los quarks se descubrieron experimentalmente hace más de cuarenta años

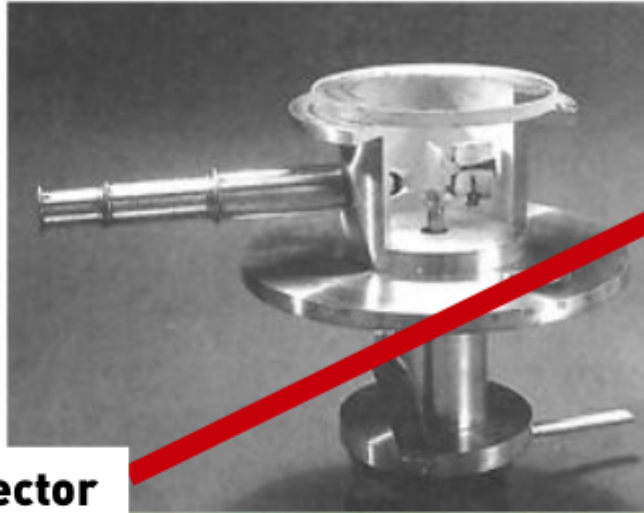

detector

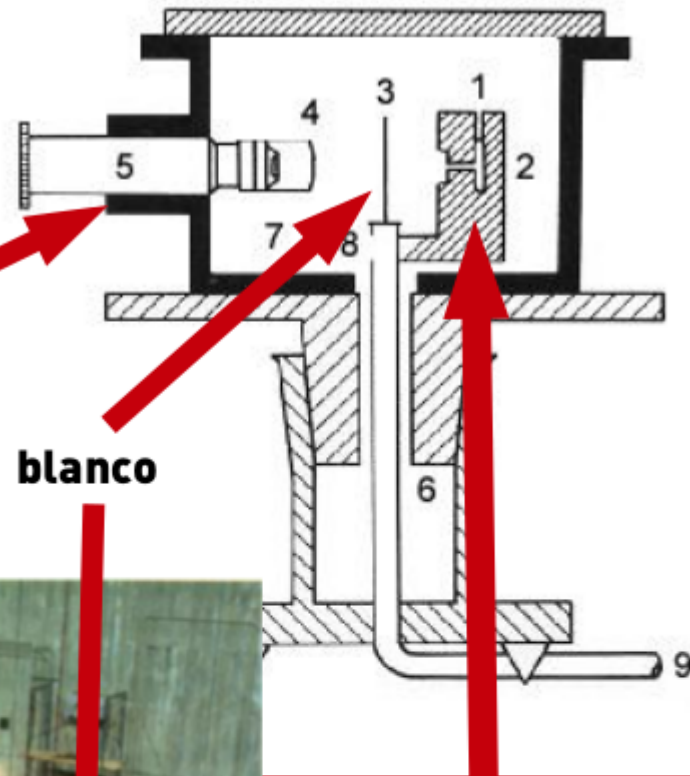

blanco

partículas



**Curioso,
¿no?**

Physics Education

PAPER • OPEN ACCESS

Introducing 12 year-olds to elementary particles

Gerfried J Wiener^{1,2}, Sascha M Schmeling¹ and Martin Hopf²

Published 8 May 2017 • © 2017 IOP Publishing Ltd

Physics Education, Volume 52, Number 4

Focus on Nuclear and Particle Physics



Article PDF

Figures ▾

References ▾

+ Article information

Abstract

We present a new learning unit, which introduces 12 year-olds to the subatomic structure of matter.

The learning unit was iteratively developed as a design-based research project using the technique of

<http://iopscience.iop.org/article/10.1088/1361-6552/aa6cfe/meta>
(cuasi) independiente del currículo...

Análisis de la enseñanza de la estructura e interacciones de la materia según la física moderna en primero de bachillerato

Study of the teaching process about the structure and interactions of matter through modern physics at the second-to-last year of high school

Paula Tuzón
Jordi Solbes

Universitat de València

<https://ojs.uv.es/index.php/dces/article/viewFile/3599/4238>



RESEARCH ARTICLE

Particle Physics in High School: A Diagnose Study

Paula Tuzón*, **Jordi Solbes**

Science Education Department, Facultat de Magisteri, Universitat de València, 46022 València, Spain

<http://roderic.uv.es/bitstream/handle/10550/54324/113222.pdf?sequence=1&isAllowed=y>

El texto del manual escolar de ciencias: ¿puente u obstáculo para el aprendizaje?

The text of the science textbook: bridge or obstacle for learning?

Carla Maturano, Carina Rudolph, María Amalia Soliveres
*Instituto de Investigaciones en Educación en las Ciencias
Experimentales (I.I.E.C.E.). Facultad de Filosofía, Humanidades y
Artes, Universidad Nacional de San Juan, Av. J.I. de La Roza 230
(Oeste). Capital, CP 5400, San Juan, Argentina.*

E-mail: cmatur@ffha.unsj.edu.ar

REVISTA
DE
ENSEÑANZA
DE LA
FÍSICA

<https://revistas.unc.edu.ar/index.php/revistaEF/article/view/15620>



SEDICI
REPOSITORIO INSTITUCIONAL DE LA UNLP

Home Search Upload Material Institutional Frequentes questions Cont

Unidades académicas → Facultad de Ciencias Exactas → Tesis

Evolución del concepto de elementalidad
Una propuesta de enseñanza basada en el uso de herramientas TIC

Author: Ozores Paci, Agustín Nicolás

Document type: Tesis de maestria

Abstract
Se presenta en este trabajo una propuesta didáctica con uso de TIC's que abor

<http://sedici.unlp.edu.ar/handle/10915/61193>

ADAPTAR LA PROGRAMACIÓN

SIN IR MUCHO MÁS ALLÁ DEL
programa mínimo

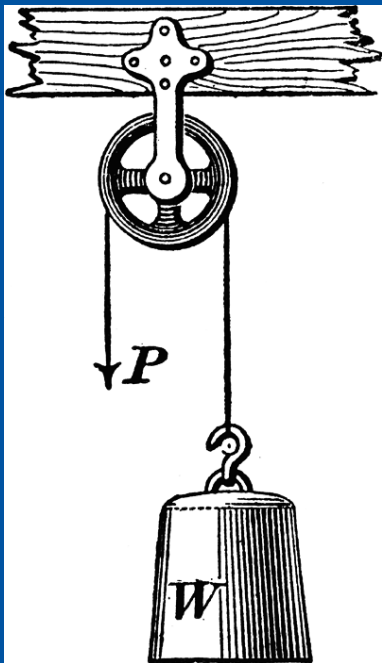

LA CONSIGNA ES
**sustituir choques
de coches por
colisiones de
partículas**

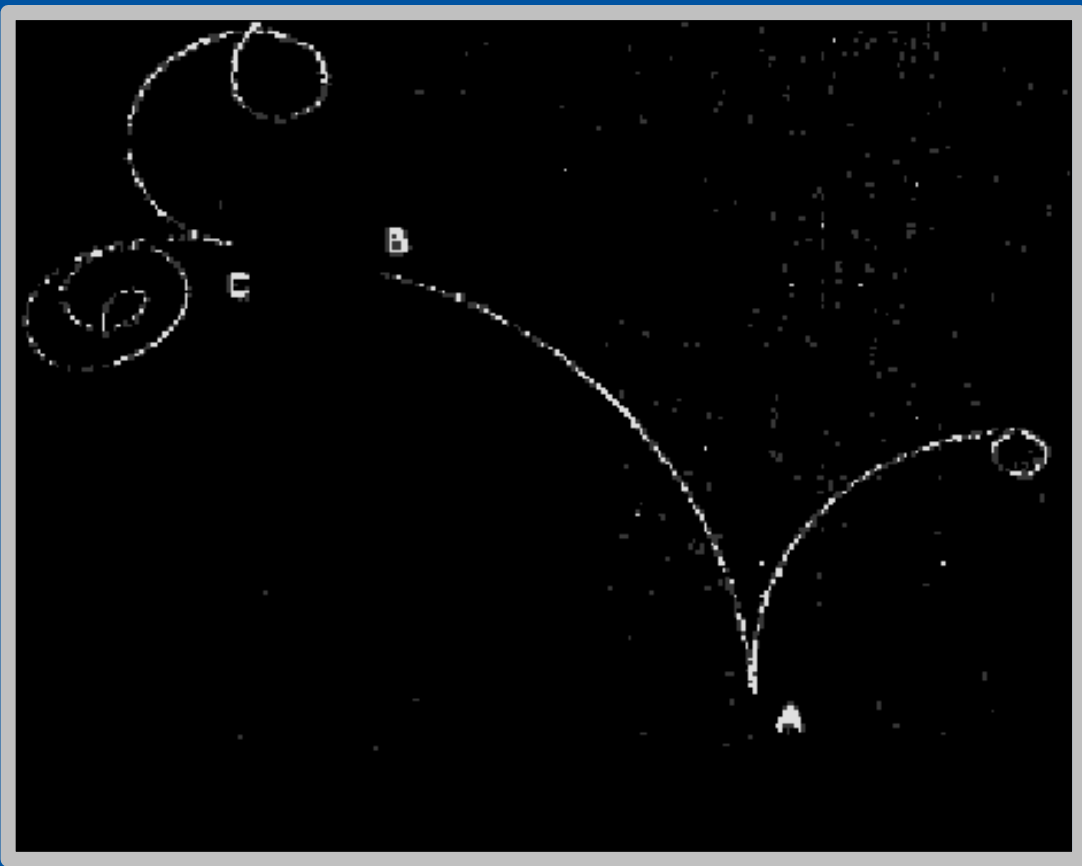
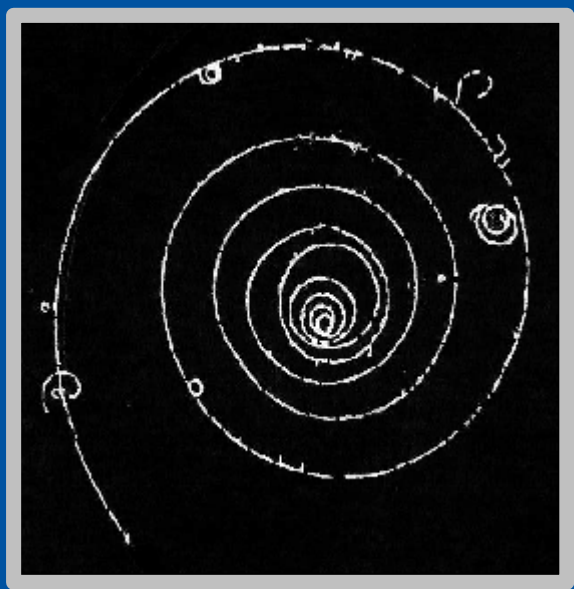
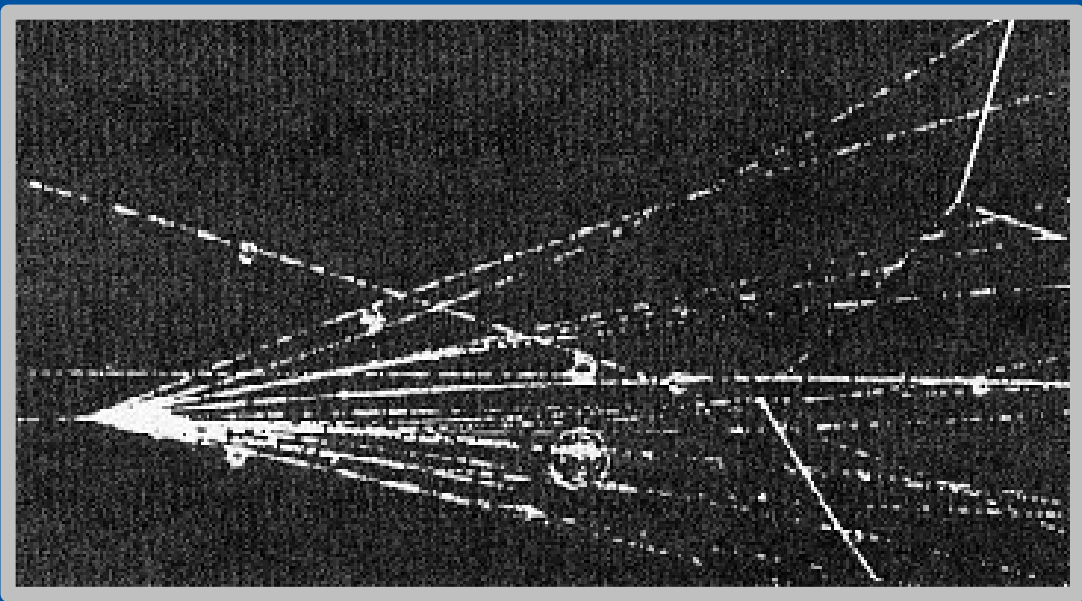
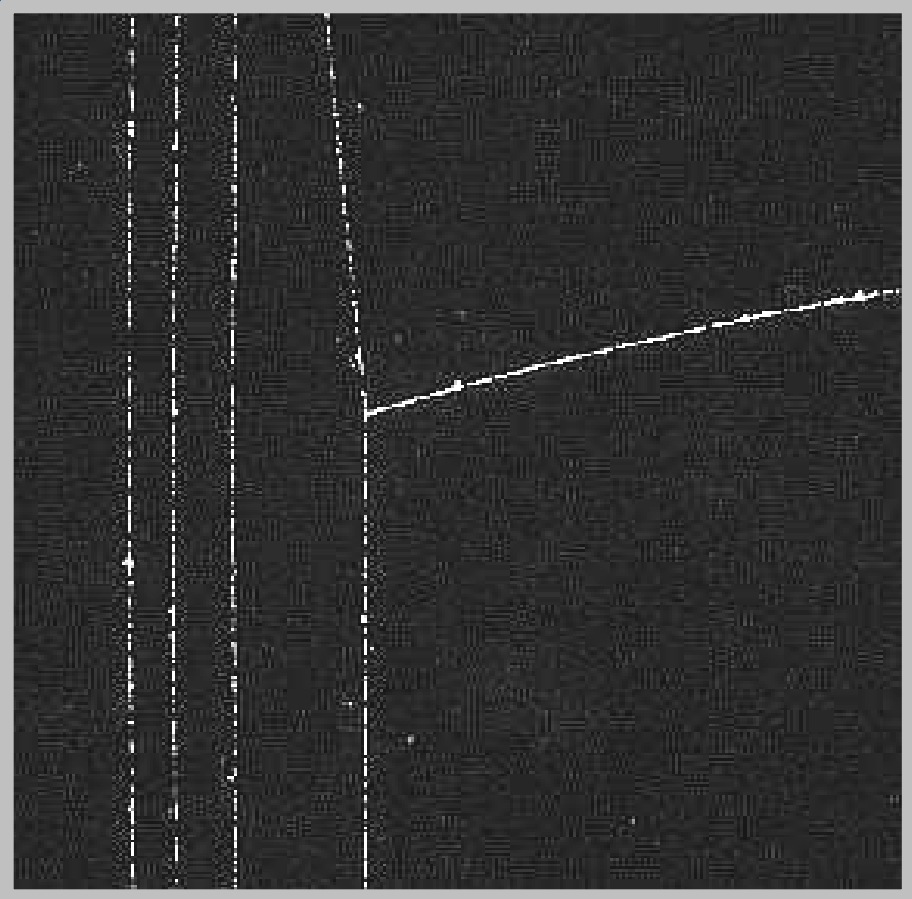

Movimiento de partículas cargadas en campos magnéticos

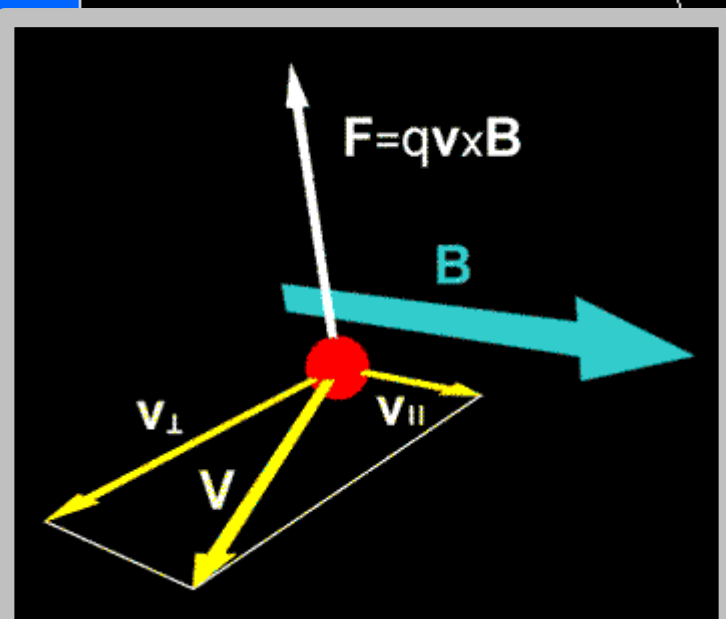
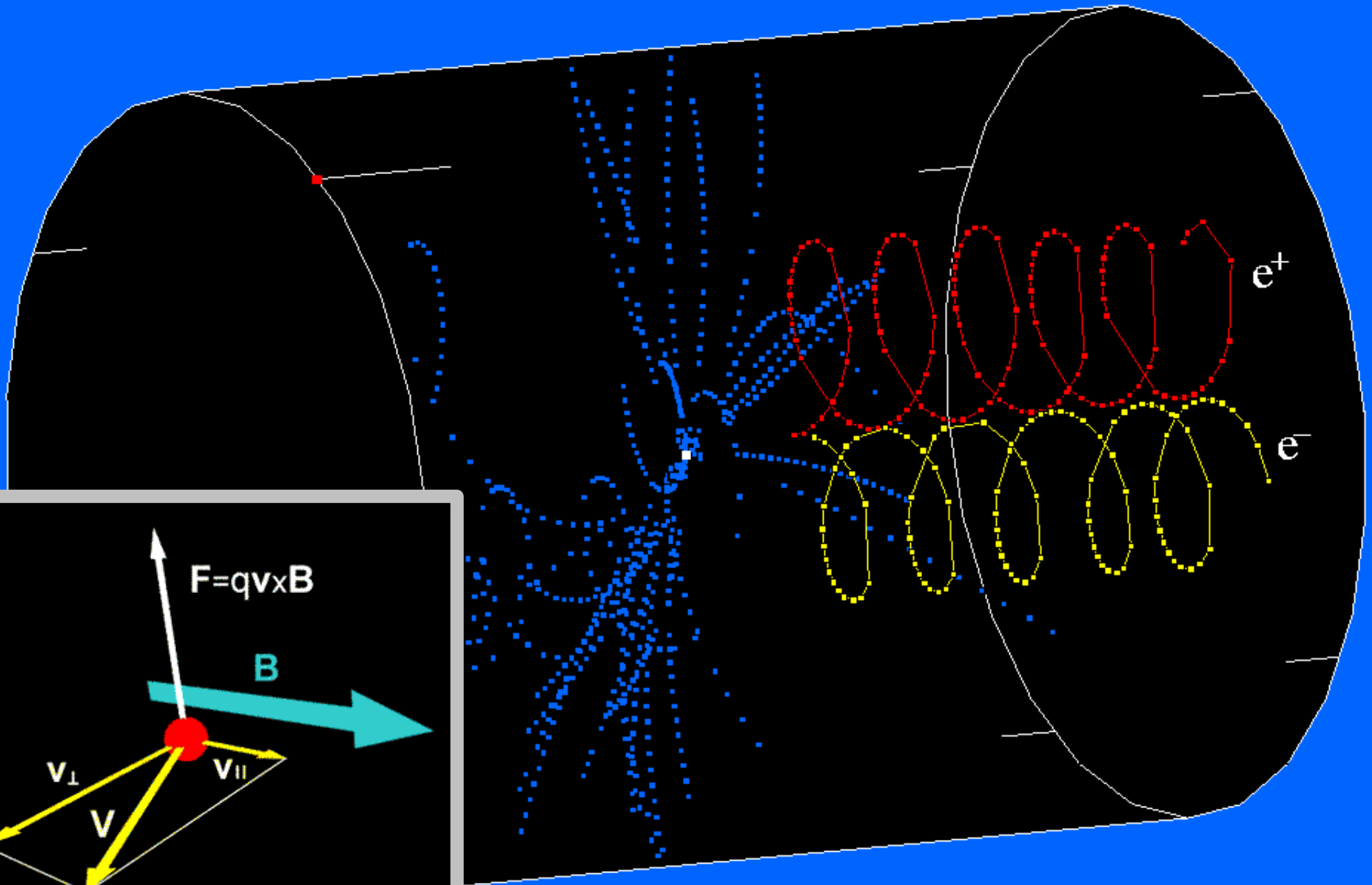

Conservación del momento lineal. Detector *ALEPH*, LEP

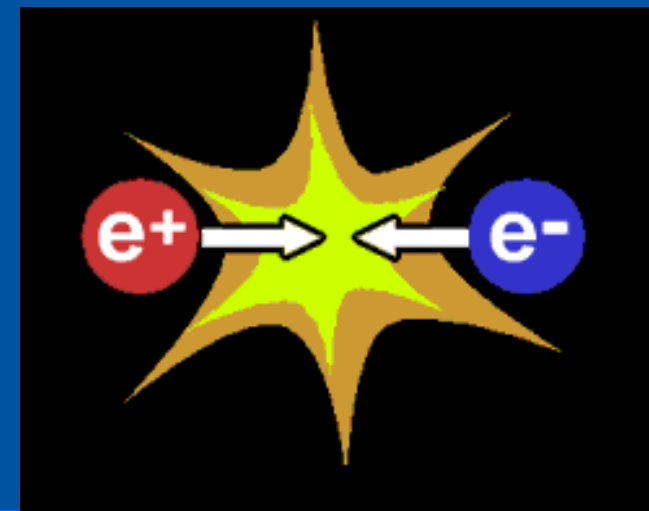

 **ALEPH** DALI

Run=15995 Evt=5435

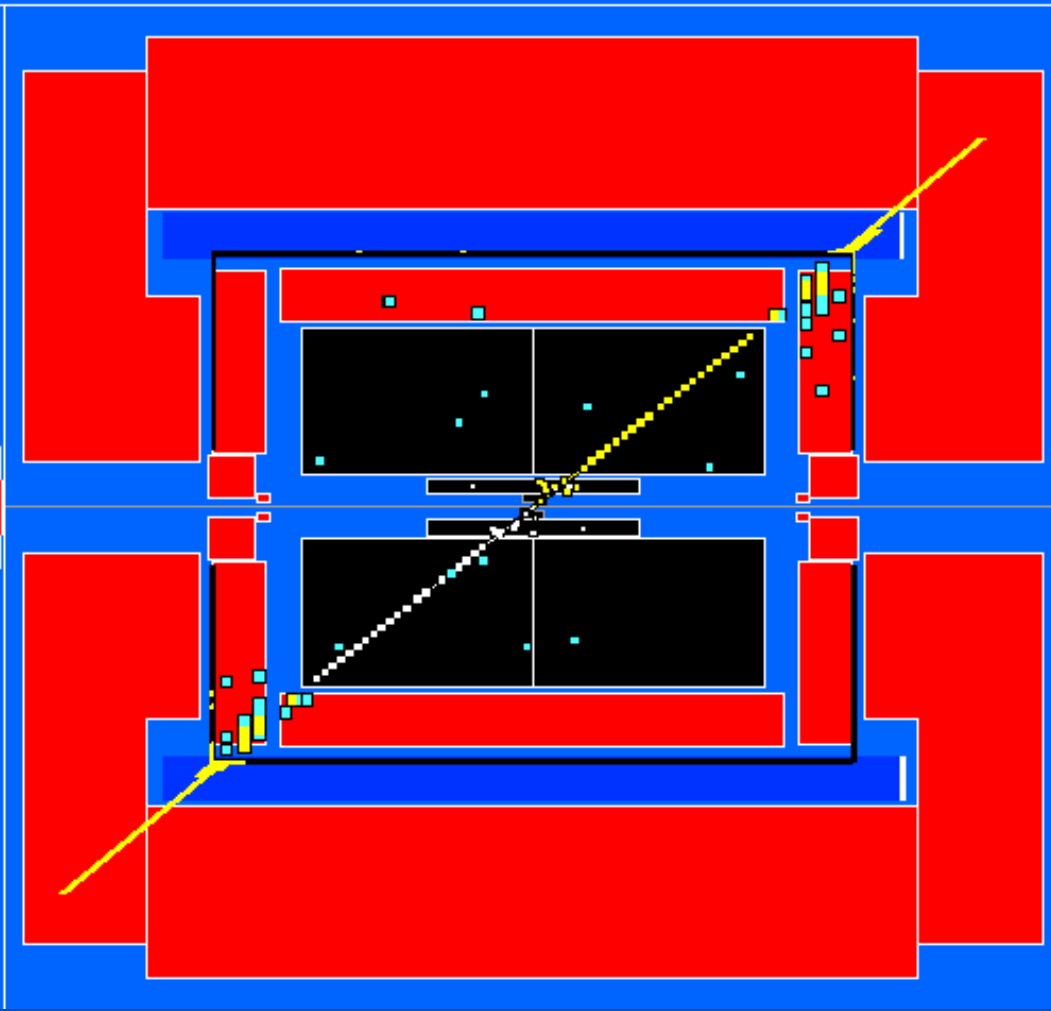
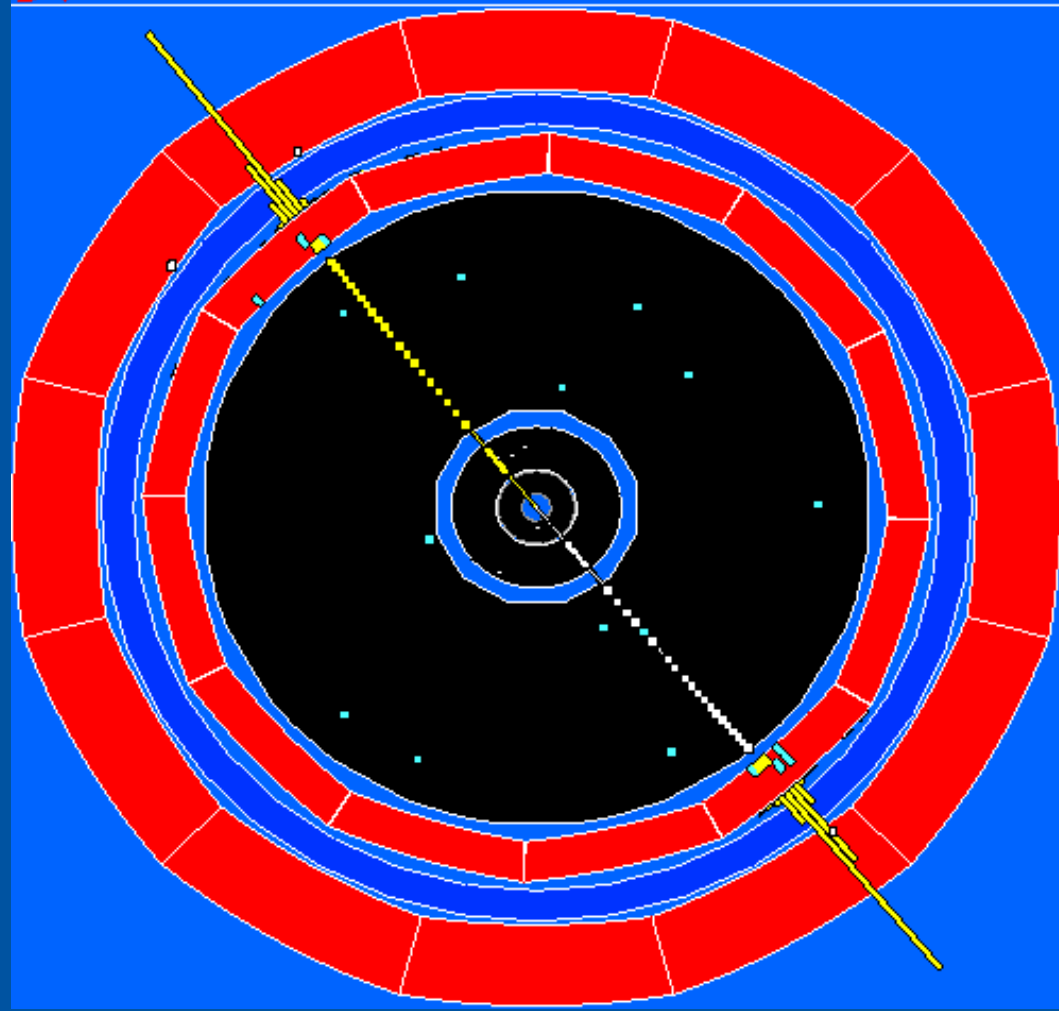

Otra de conservación del momento lineal

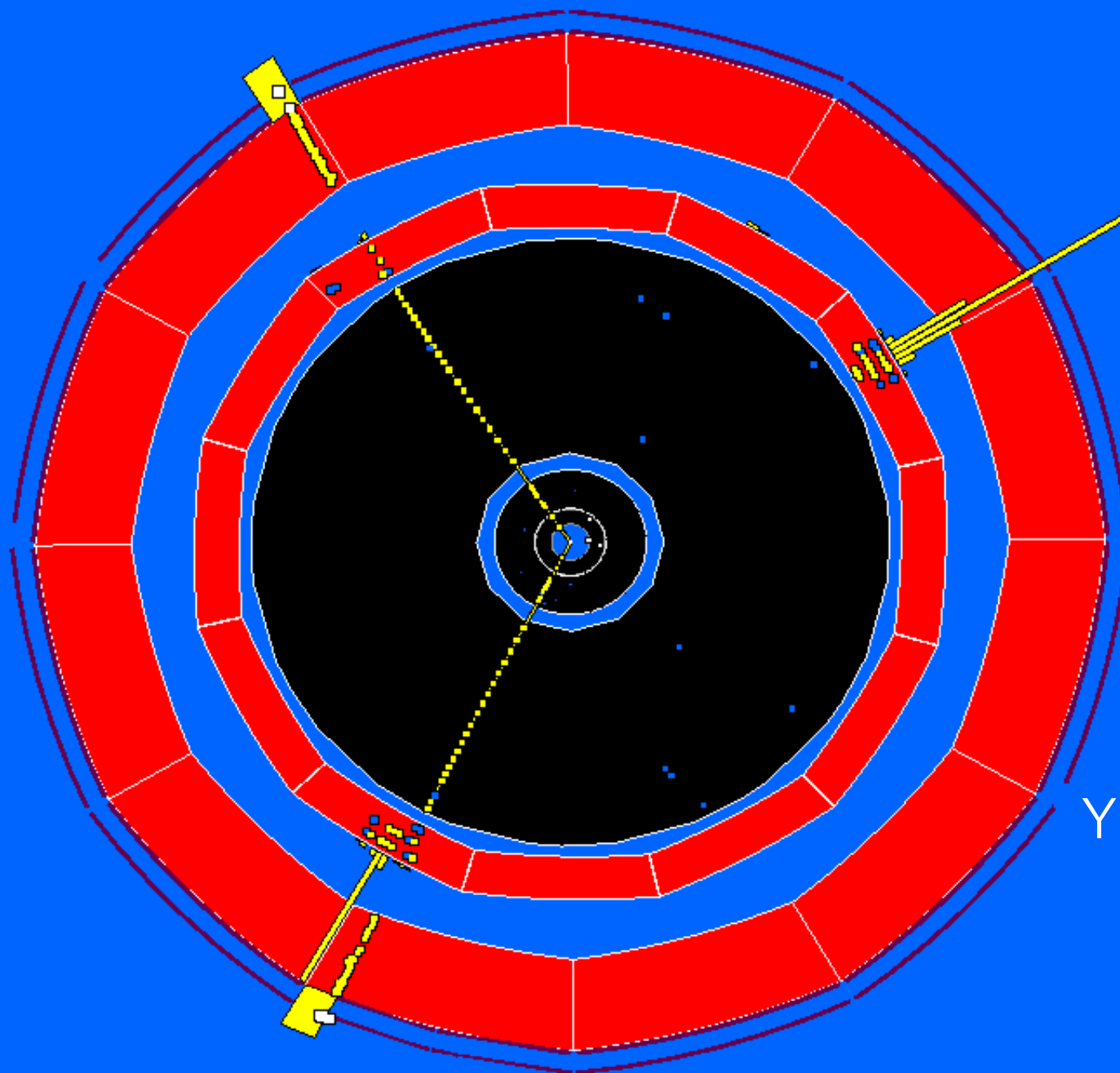

Y en muchos
casos
tenemos
datos
numéricos

Hay mucho material disponible y probado:

CINEMÁTICA, DINÁMICA, ENERGÍA, LEYES DE CONSERVACIÓN, GASES, ELECTRICIDAD Y MAGNETISMO, GASES...

**PARA TODOS LOS NIVELES DESDE SECUNDARIA,
(no con la misma abundancia)
CUALITATIVO Y CUANTITATIVO**

POR EJEMPLO:

Viaje al corazón de la materia: <http://palmera.pntic.mec.es/~fbarrada/>

Física de partículas en el Instituto: <http://www.educa2.madrid.org/web/fbarradas/inicio>

Acercándonos la LHC http://www.lhc-closer.es/pages_es/phy_1.html

Bibliografía de urgencia: <http://goo.gl/txNNz>

ESO SIN CONTAR CON QUE -NECESARIAMENTE
EN ALGUNAS MATERIAS NECESARIAMENTE
TENDREMOS QUE ADOPTAR UN

Enfoque curricular

Bloque 6. Física del siglo XX

Contenidos

- Introducción a la Teoría Especial de la Relatividad.
- Energía relativista. Energía total y energía en reposo.
- Física Cuántica.
- Insuficiencia de la Física Clásica.
- Orígenes de la Física Cuántica. Problemas precursores.
- Interpretación probabilística de la Física Cuántica.
- Aplicaciones de la Física Cuántica. El Láser.
- Física Nuclear.
- La radiactividad. Tipos.
- El núcleo atómico. Leyes de la desintegración radiactiva.
- Fusión y Fisión nucleares.
- Interacciones fundamentales de la naturaleza y partículas fundamentales. Las cuatro interacciones fundamentales de la naturaleza: gravitatoria, electromagnética, nuclear fuerte y nuclear débil.
- Partículas fundamentales constitutivas del átomo: electrones y quarks.
- Historia y composición del Universo. Fronteras de la Física.

Estándares **(PRINCIPALES)** de aprendizaje evaluables

16.1. Compara las principales características de las cuatro interacciones fundamentales de la naturaleza a partir de los procesos en los que éstas se manifiestan.

19.1. Describe la estructura atómica y nuclear a partir de su composición en quarks y electrones, empleando el vocabulario específico de la física de quarks.

20.2. Explica la teoría del Big Bang y discute las evidencias experimentales en las que se apoya, como son la radiación de fondo y el efecto Doppler relativista.

OTROS ENFOQUES:

- A través de la ficción**
- A través de aplicaciones biomédicas (u otras)**
- Construir detectores caseros**
- "Ciencia ciudadana"**

A través de la ficción

European Organization for Nuclear Research

SCIENCE AND FICTION: FLASHFORWARD

CERN > FlashForward

Two minutes and seventeen
that changed the world...

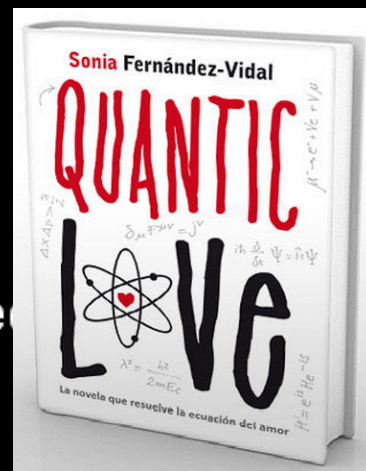

Robert Sawyer's novel FlashForward is currently being transformed into a big budget ABC TV series. Sawyer's story follows a research team using the particle accelerator at CERN in pursuit of the elusive Higgs Boson, a theoretical subatomic particle. But instead of finding the Higgs, the consciousness of the entire human race is thrown ahead by twenty-one years.



SCIENCE BEHIND THE STORY



European Organization for Nuclear Research

ANGELS & DEMONS

the science behind the story



Français

English

Física de partículas y (bio)medicina:

<http://palmera.pntic.mec.es/~fbarrada/aula/aula0.html>

– Física de partículas y medicina

Se trata de encontrar la relación entre una noticia de prensa que habla de la extensión de la tomografía de emisión de positrones como técnica diagnóstica y las dificultades que supone su coste con la imagen de un suceso en el colisionador LEP del CERN.



Foto CERN

Reconstrucción de un suceso en el colisionador LEP del CERN. En el punto rojo del centro se han hecho chocar un electrón y un positrón.

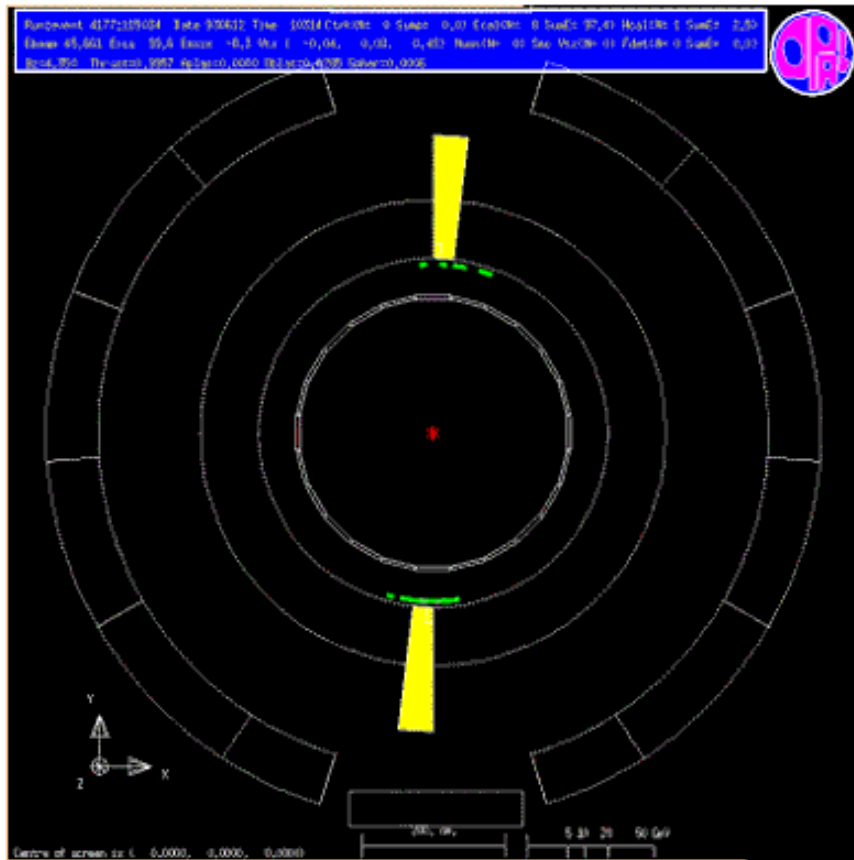

Foto Brunel University

Imagen del cerebro por escáner PET. Se usan para el diagnóstico médico y para investigar, por ejemplo, cómo cambia cuando se piensa o se lee.

Y quien dice medicina dice tecnología o computación o tantas cosas que salen en los medios...

A primera vista, la relación puede no existir, pero cuando se rasca un poco la superficie, sí aparece un enlace directo y natural... Tal como se empleó en el aula, los alumnos sabían interpretar las imágenes del detector (ver la sección 2.4 de la Introducción para alumnos y las secciones 4.2.2b y 3.2 de la Introducción para profesores)

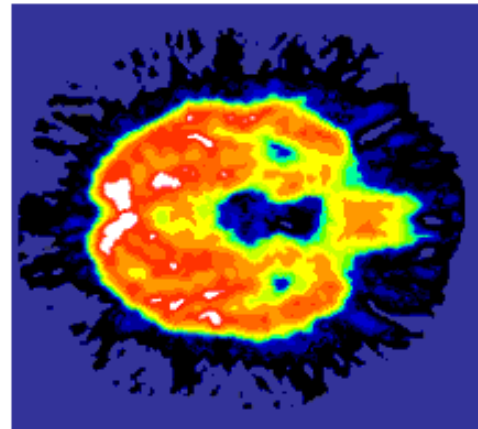
DEMUESTRAN LA EFICACIA DE UNA PROTEÍNA QUE PUEDE INHIBIR EL VIRUS DEL VIH-1

INICIO / ACTUALIDAD / NOTICIAS / DEMUESTRAN LA EFICACIA DE UNA PROTEÍNA QUE PUEDE INHIBIR EL VIRUS DEL VIH-1

Utilizando los brillantes rayos X del Sincrotrón ALBA, un grupo de investigadores ha resuelto la estructura cristalina de una cadena proteica sintética que puede evitar la infección del **VIH-1**.

La glicoproteína gp41 forma parte de la envoltura del virus de la inmunodeficiencia humana. Durante la infección del **VIH-1**, dos regiones de gp41 (la repetición NHR y CHR respectivamente) pueden ser accesibles a inhibidores de manera temporal.

Los investigadores diseñaron una **cadena proteica simple que imita la superficie de NHR**. De esta manera, esta cadena evita que el virus se pliegue e infecte a la célula huésped, tal y como ocurre con los pseudovirus y virus aislados. El siguiente paso fue **hacer crecer la proteína en cristales** generados en el [Sincrotrón ALBA](#).

Los experimentos de difracción de rayos X realizados en la **línea de luz XALOC** han permitido **confirmar su capacidad de imitar a la perfección la superficie de NHR** en la región de la proteína.

Esta proteína - que es muy estable y precisa - tiene un **gran potencial para el desarrollo de fármacos, vacunas o microbicidas contra el VIH-1**.

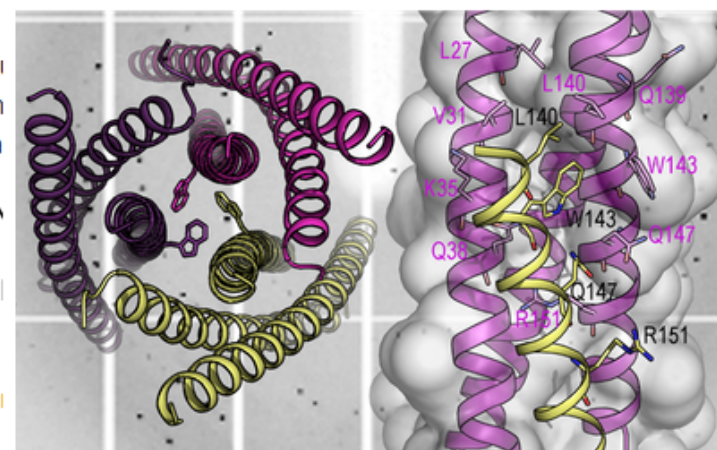

PARTÍCULAS DE VERDAD

DETECTORES CASEROS

“Ver” para creer

LETRA PEQUEÑA:

Pero cuidado, que ni “vemos” ni se trata de “creer” en sentido estricto.

Tira de fieltro empapada de alcohol

Placa metálica

Burlete de goma

CO₂ sólido

La cámara de niebla

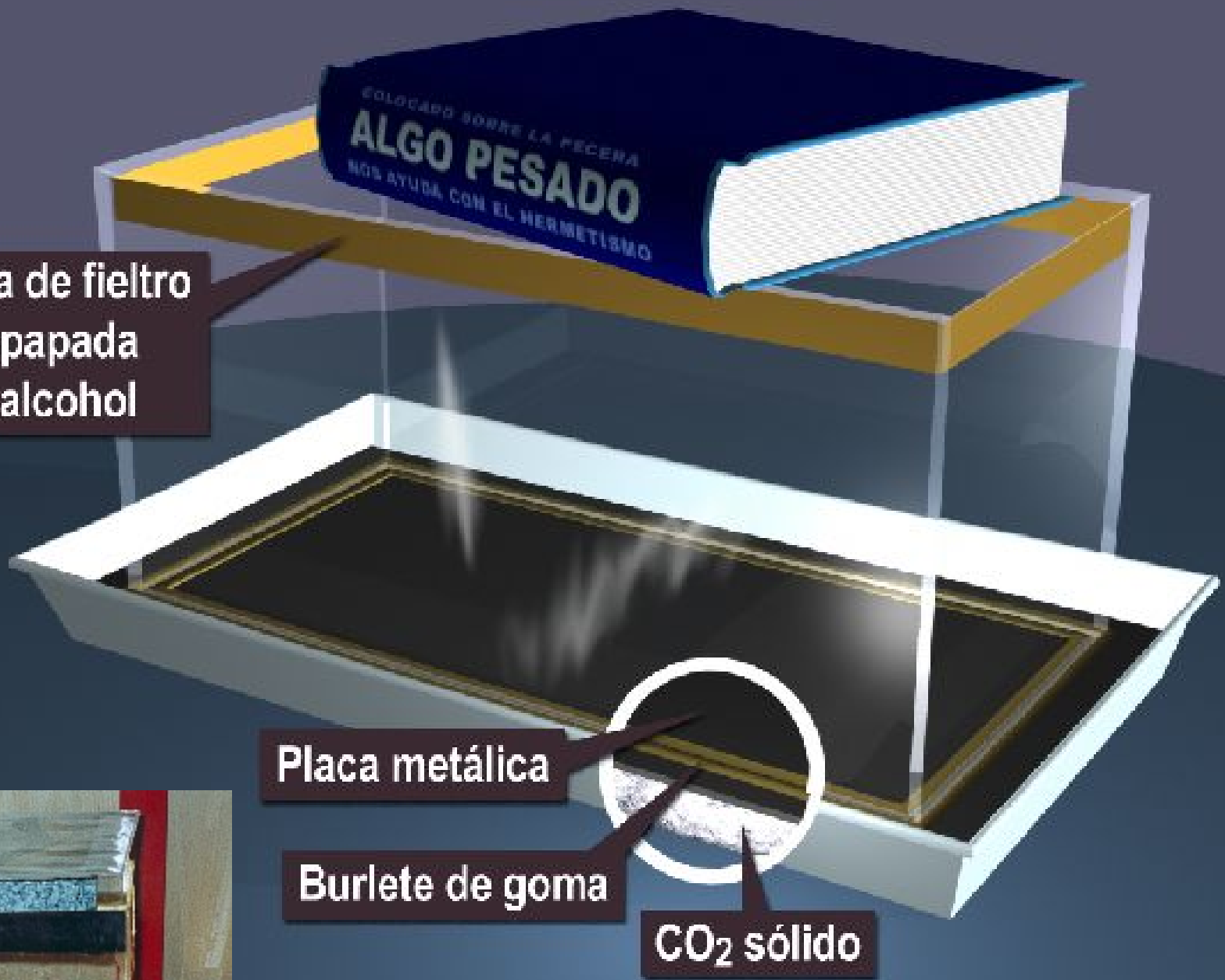

Se puede comprobar (*¡vaya frase!*) que la mayoría de las partículas detectadas son **muones (μ)** de los rayos cósmicos secundarios

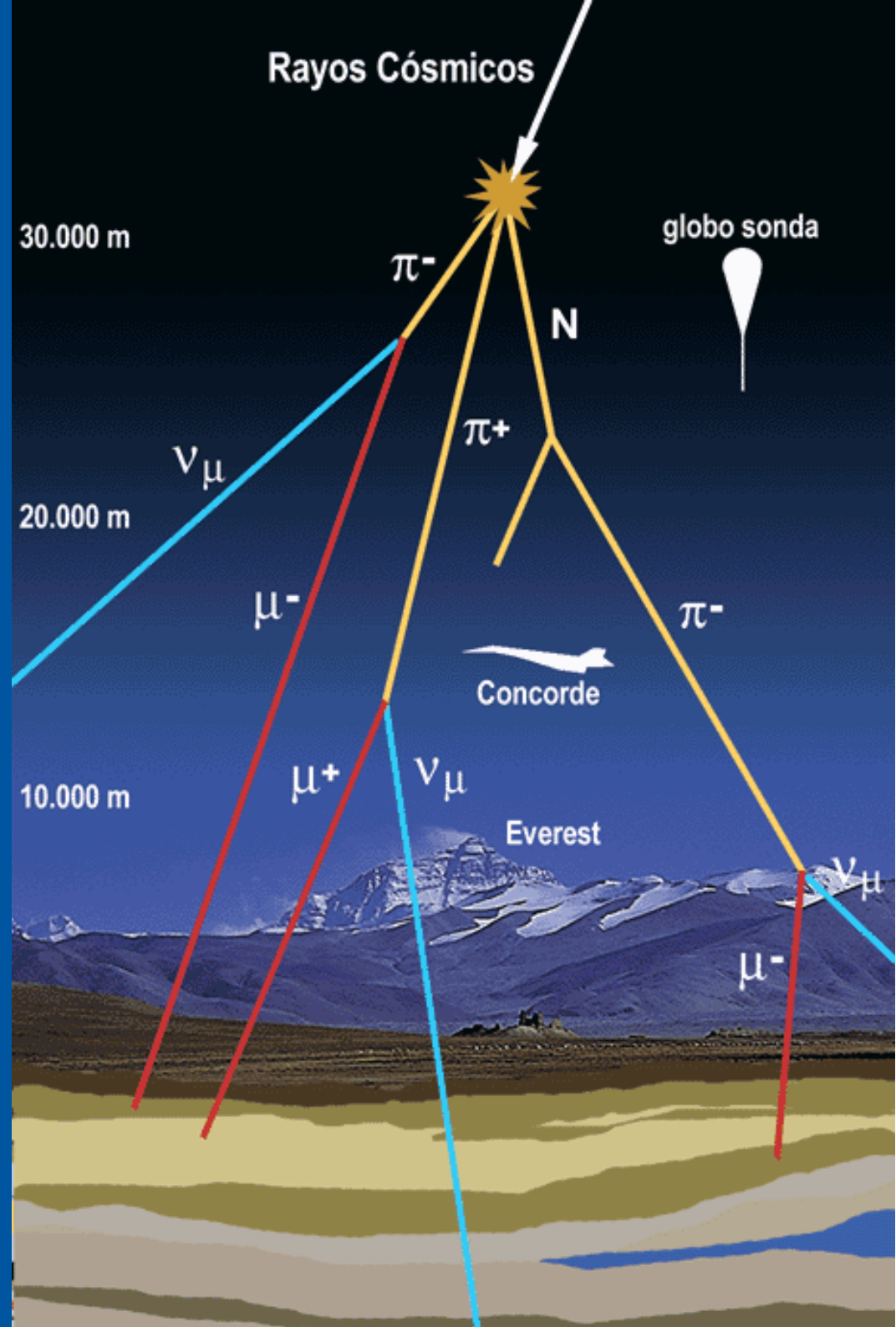

**También se pueden
construir
otras cosas en el taller:**

Opciones más avanzadas, que permiten medir cosas sobre los rayos cósmicos...



Home Buy Download Products ▾ Learning ▾ Forum Support ▾ Blog

« Speed Trap! A GPS-Based Speeding Alert

Cubeduino »

"BUILD YOUR OWN" GEIGER COUNTER [2 PART TUTORIAL]

Daide Gomba — April 13th, 2010

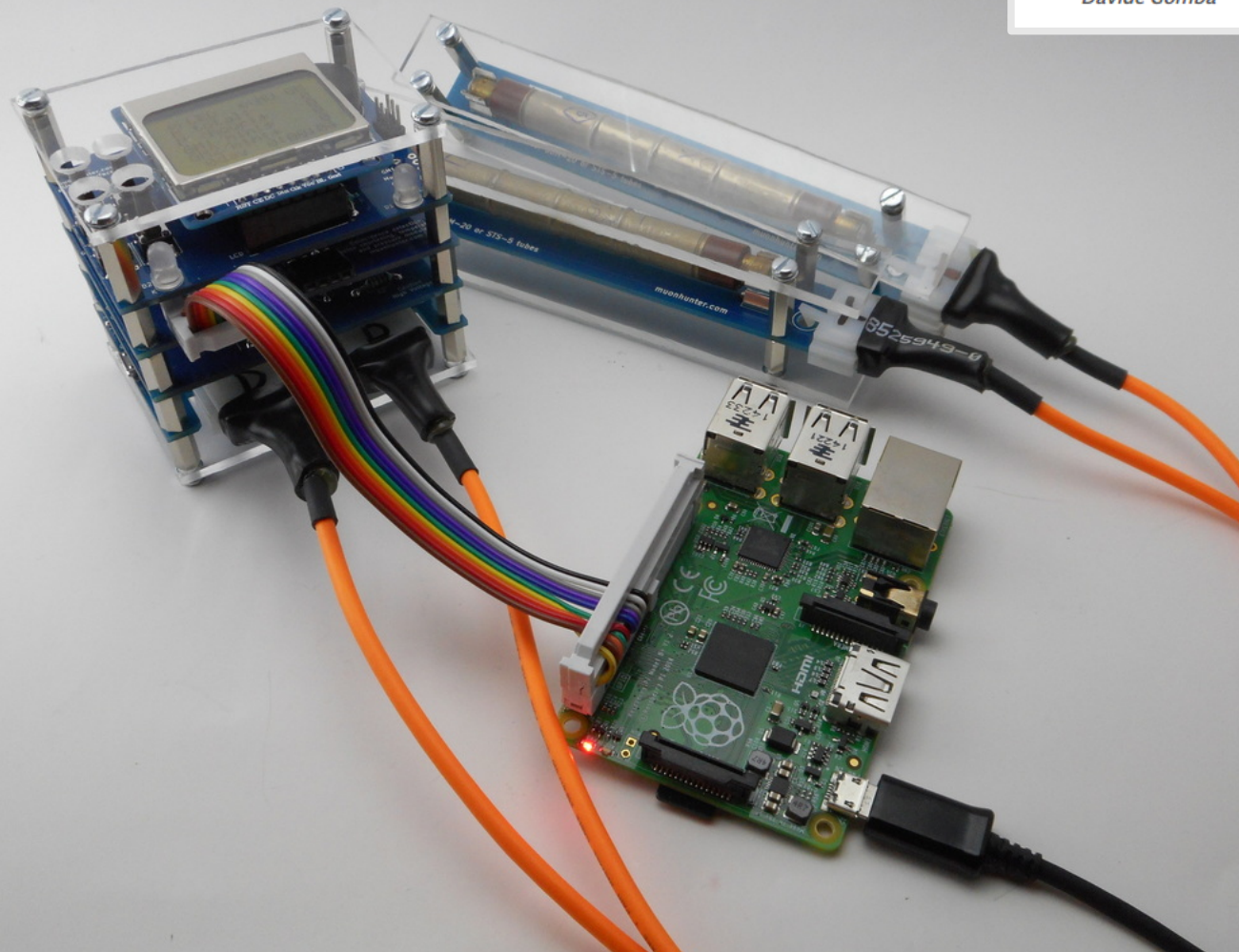

Arduino muon detector

September 3, 2009 By Zach Banks · 22 Comments

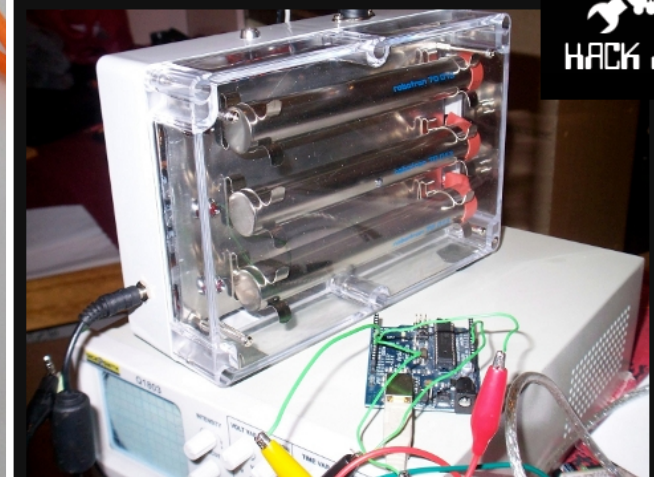

HACK A DAY

GM COUNTER READINGS MAD --> GVA FLIGHT

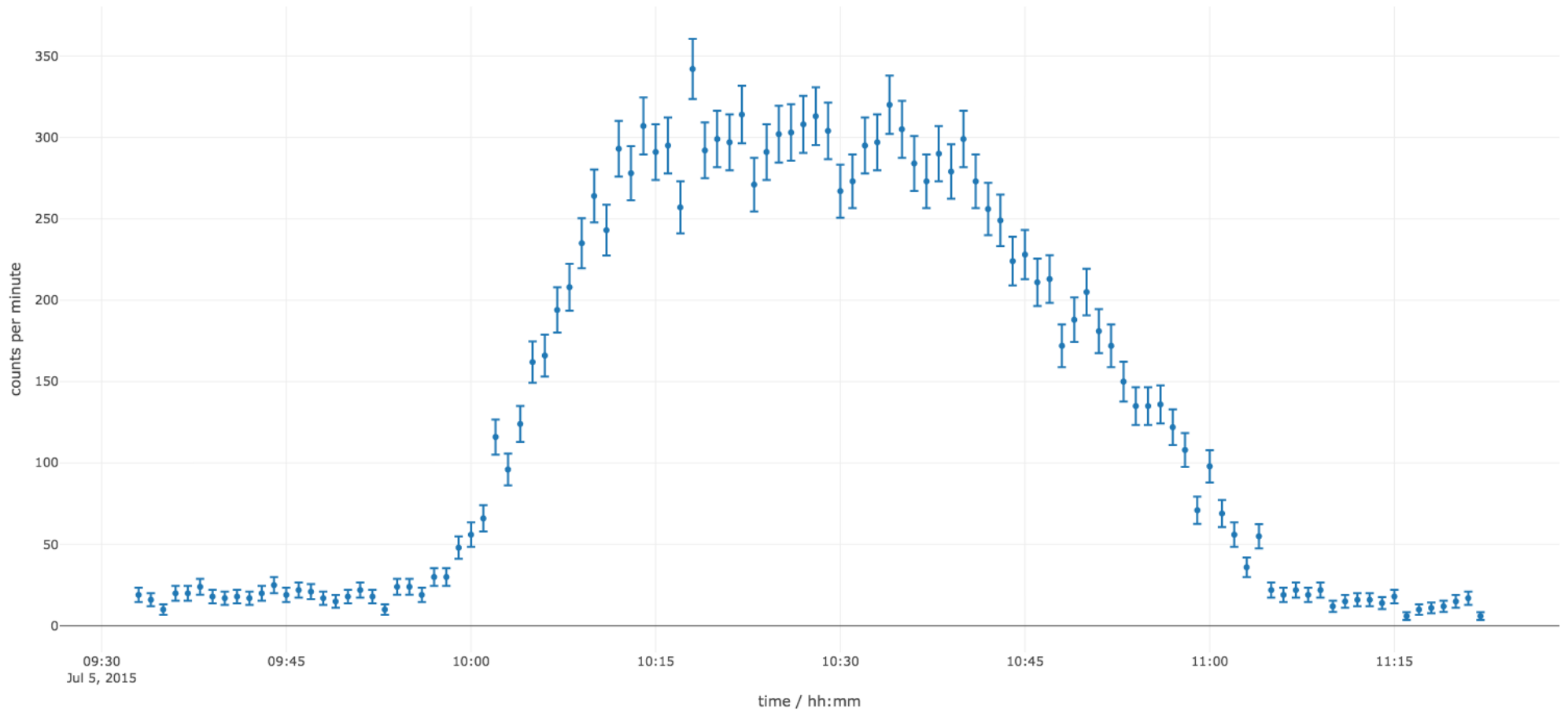

Geiger cpm (10 s) in 12 hours: Madrid v Alicante

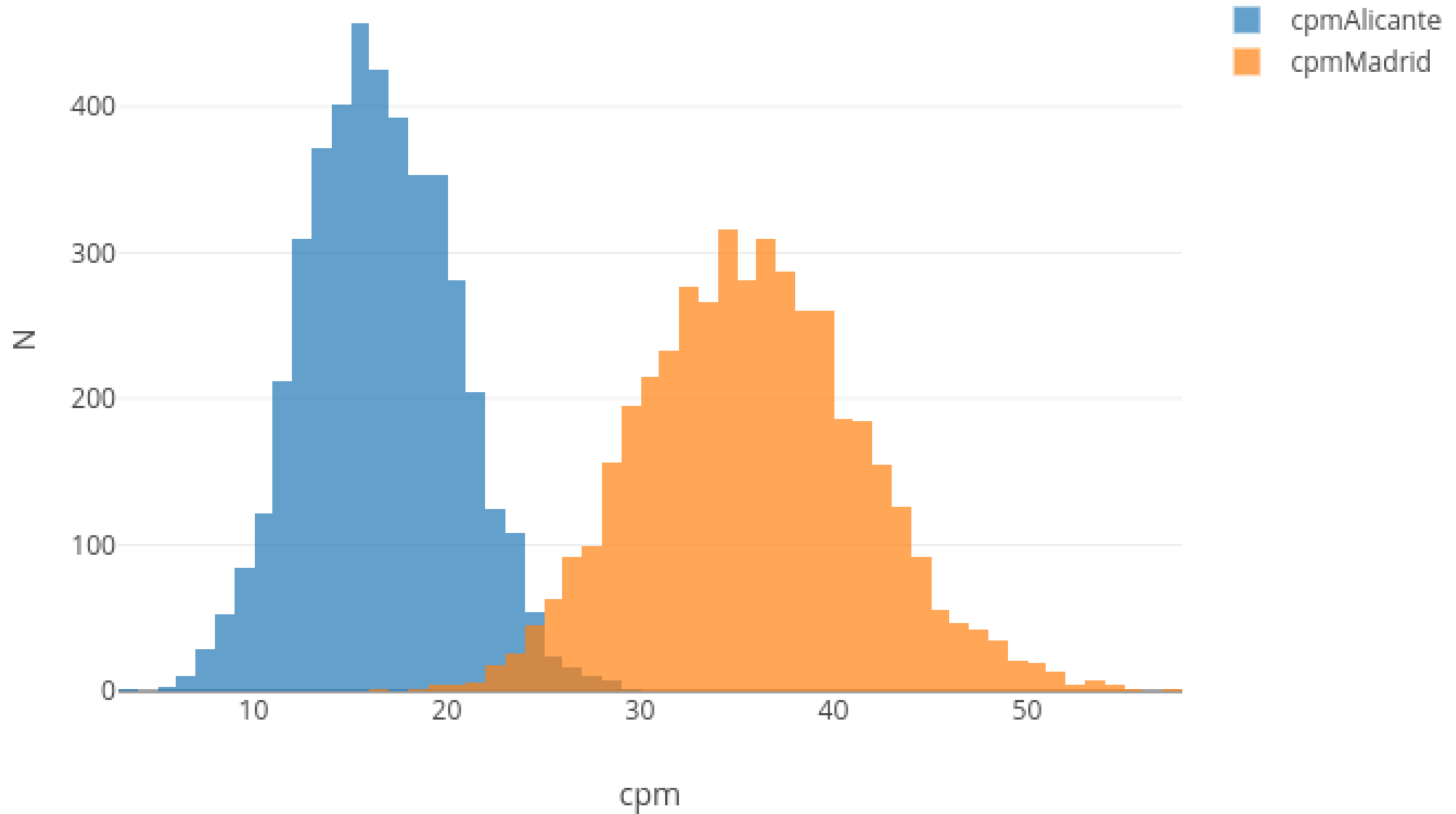

frecuencia / 1 cpm

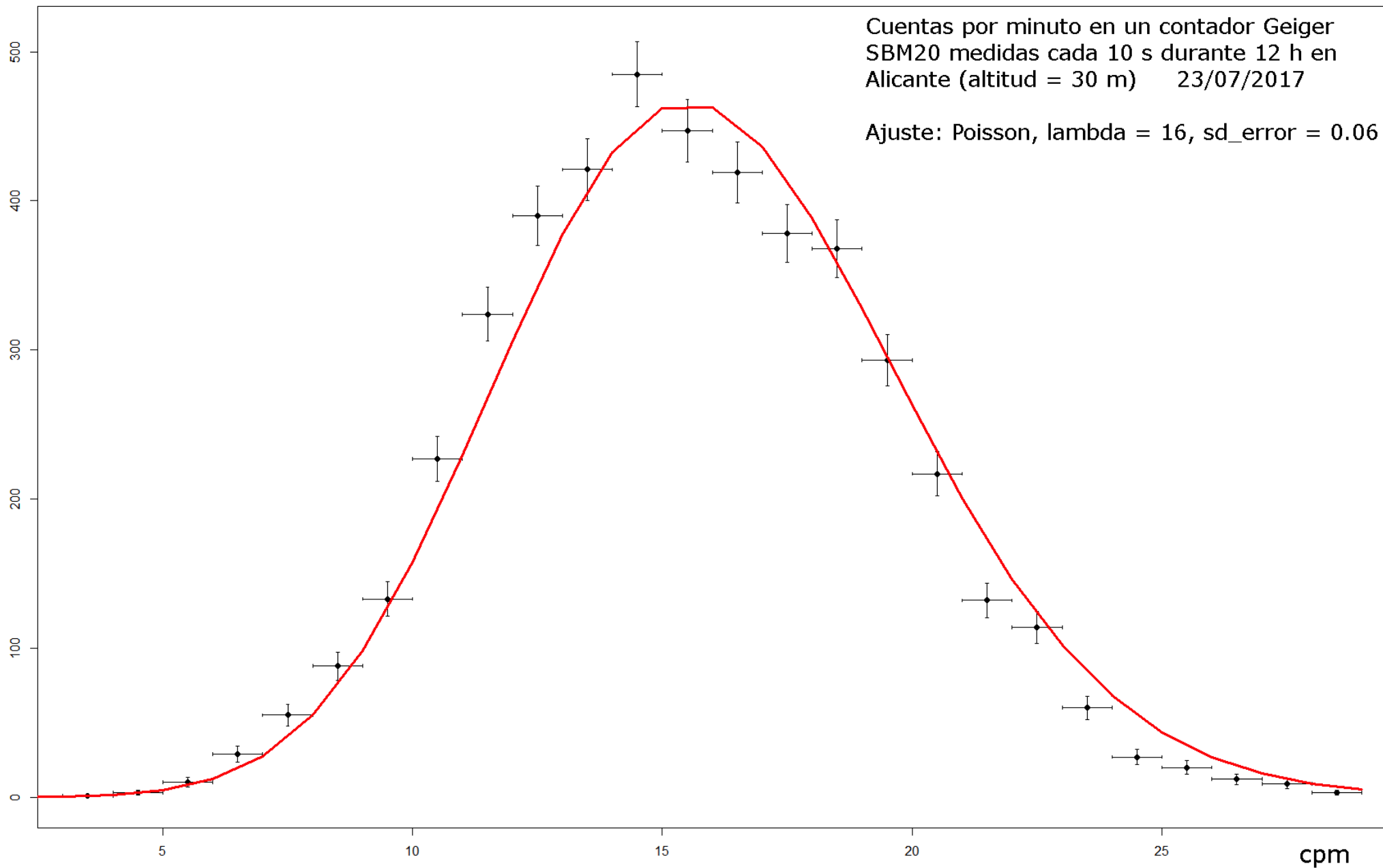



An Inexpensive Cosmic Ray Detector for the Classroom

Jeffrey D. Goldader and Seulah Choi

Citation: *The Physics Teacher* **48**, 594 (2010); doi: 10.1119/1.3517025

View online: <http://dx.doi.org/10.1119/1.3517025>

View Table of Contents: <http://scitation.aip.org/content/aapt/journal/tpt/48/9?ver=pdfcov>

Published by the [American Association of Physics Teachers](#)

Articles you may be interested in

Walther Bothe and Bruno Rossi: The birth and development of coincidence methods in cosmic-ray physics
Am. J. Phys. **79**, 1133 (2011); 10.1119/1.3619808

Student Projects in Cosmic Ray Detection

Phys. Teach. **47**, 494 (2009); 10.1119/1.3246465

Astroparticle Physics: Detectors for Cosmic Rays

AIP Conf. Proc. **857**, 382 (2006); 10.1063/1.2359423

Educational Cosmic Ray Arrays

AIP Conf. Proc. **828**, 271 (2006); 10.1063/1.2197427

Measuring and modeling cosmic ray showers with an MBL system: An undergraduate project

Am. J. Phys. **69**, 896 (2001); 10.1119/1.1370236

[arXiv.org](#) > [physics](#) > [arXiv:physics/0701015](#)

[Physics](#) > [Physics Education](#)

Educational cosmic ray experiments with Geiger counters

F.Blanco, F.Fichera, P.La Rocca, F.Librizzi, O.Parasole, F.Riggi

(Submitted on 31 Dec 2006)

"CIENCIA CIUDADANA"

Particularmente usando
métodos propios de la *grid*

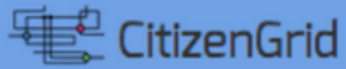

CitizenGrid Application Directory

Find applications to run or contribute resources to

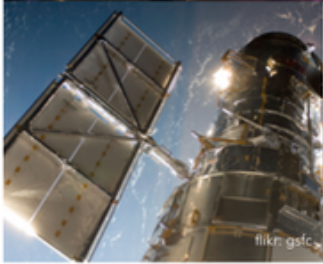
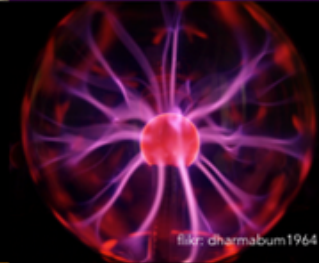
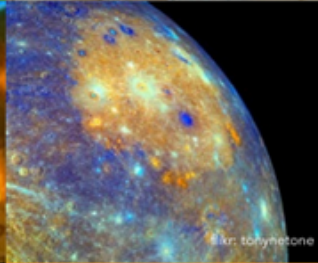
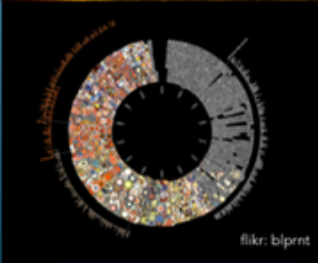
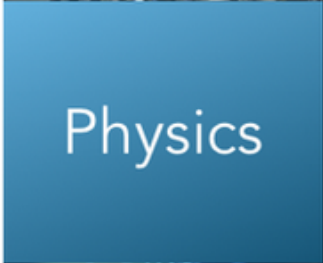
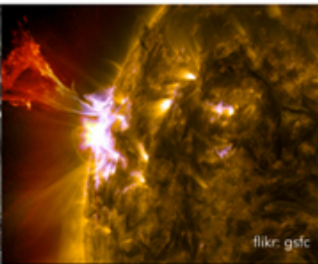

En su computadora

Citizen Science Grid ▾

Information ▾

Top Lists ▾

Message Boards

Citizen Science Grid

The University of North Dakota Citizen Science Grid is run by [Travis Desell](#), an Assistant Professor in UND's Computer Science Department. It is hosted by UND's Computational Research Center and Information Technology Systems and Services. The CSG is dedicated to supporting a wide range of research and educational projects using volunteer computing and citizen science, which you can read about and visit below.

[Volunteer Your Computer](#)

[Volunteer Your Brain](#)

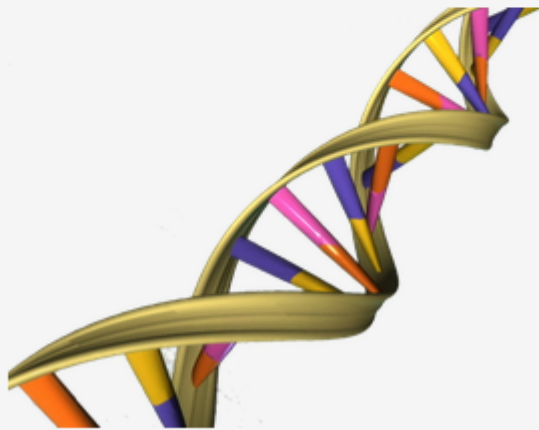

DNA@Home

The goal of DNA@Home is to discover what regulates the genes in DNA. Ever notice that skin cells are different from a muscle cells, which are different from a bone cells, even though all these cells have every gene in your genome? That's because not all genes are "on" all the time. Depending on the cell type and what the cell is trying to do at any given moment, only a subset of the genes are used, and the remainder are shut off. DNA@home uses statistical algorithms to unlock the key to this differential regulation, using your volunteered computers.



¡Con teléfonos celulares!



DECO is a citizen science project that enables users around the world to detect cosmic rays and other energetic particles with their cell phones and tablets. The recorded events are automatically uploaded to a central database. In addition to detecting particle events, users can analyze the data produced by their own or other users' phones.

Getting started with DECO: The Distributed Electronic Cosmic-ray Observatory

J. Vandenbroucke (vandenbrouck@wisc.edu)
May 19, 2014 (Revised October 10, 2014)



About CRAYFIS

The CRAYFIS project is a novel approach to observing cosmic ray particles at the highest energies. It uses the world-wide array of existing smartphones instead of building an expensive dedicated detector.

[Learn more ↓](#)

[Join!](#)

[arXiv.org](#) > [astro-ph](#) > [arXiv:1410.2895](#)

[Astrophysics](#) > [Instrumentation and Methods for Astrophysics](#)

Observing Ultra-High Energy Cosmic Rays with Smartphones

[Daniel Whiteson](#), [Michael Mulhearn](#), [Chase Shimmin](#), [Kyle Brodie](#), [Dustin Burns](#)

(Submitted on 10 Oct 2014)



Search this site

Search

[HOME](#)

[ABOUT](#) ▾

[PROJECTS](#) ▾

[JOIN US!](#)

[HELP & FAQ](#)

[CONTACT](#)

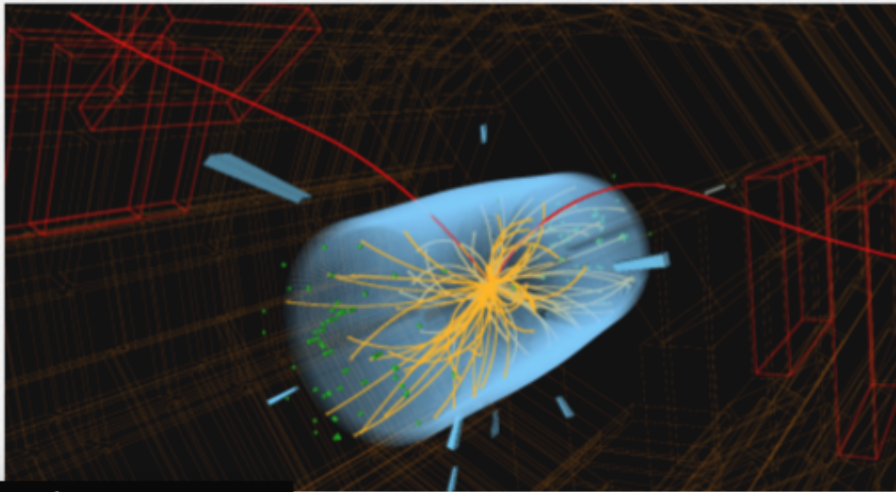

CERN's Teacher Programmes

CMS@Home

Open a window to theories beyond the Standard Model.

Help CMS search for extra dimensions and particles that could make up dark matter.

[Tell me more](#)

O contribuyendo con nuestras habilidades humanas

AEGIS EXPERIMENT

TESTING GRAVITY WITH ANTIMATTER AT CERN

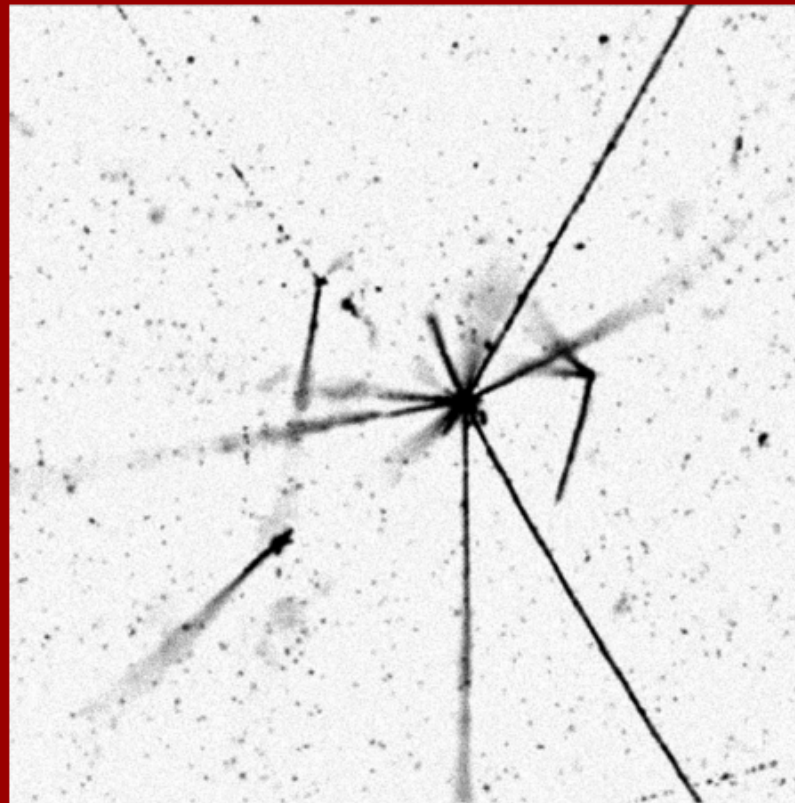

CERN's Teacher Programmes

WHAT IS AEGIS?

IN THE NEWS

MULTIMEDIA

BLOGS

HELP US

PUBLICATIONS

JOBS

CONTACT

COLLABORATION

Copyright 2014 - AEgIS Collaboration - CERN

FINALMENTE,

hay muchas otras
cosas en las que
pueden participar →

Más información



VIAJE AL CORAZÓN DE LA MATERIA
Física de partículas en el Instituto

Introducción e instrucciones de uso

Física de partículas para profesores

Actividades en el aula

Recursos y noticias

Vd. puede conocer el CERN

Índice

Autor **LHC: El blog del profesor**

Financiado por  

FÍSICA DE PARTÍCULAS EN EL INSTITUTO
Una guía práctica

<http://palmera.pntic.mec.es/~fbarrada/>

**Y recordad; me podéis
preguntar por lo que sea...**

Paco Barradas

@fbarradass

fbarradas@educa.madrid.org

FIN

¡Gracias!

Francisco Barradas Solas
Coordinador del programa español del CERN para profesores

Subdirección General de Formación del Profesorado
Consejería de Educación
Comunidad de Madrid

EXTRAS y ESPAÑA

My trip to CERN



Before



After

DESPUÉS DEL CERN

Experiencias de los participantes en los programas de formación para profesores de la Comunidad de Madrid

¿Y cómo me sigo yo informando...?

@fbarradass

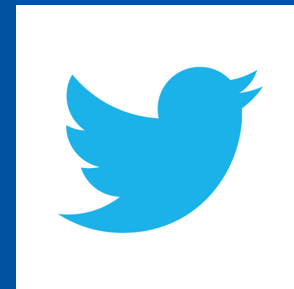

En casa también
tenemos física
de partículas...



Los
datos
son de



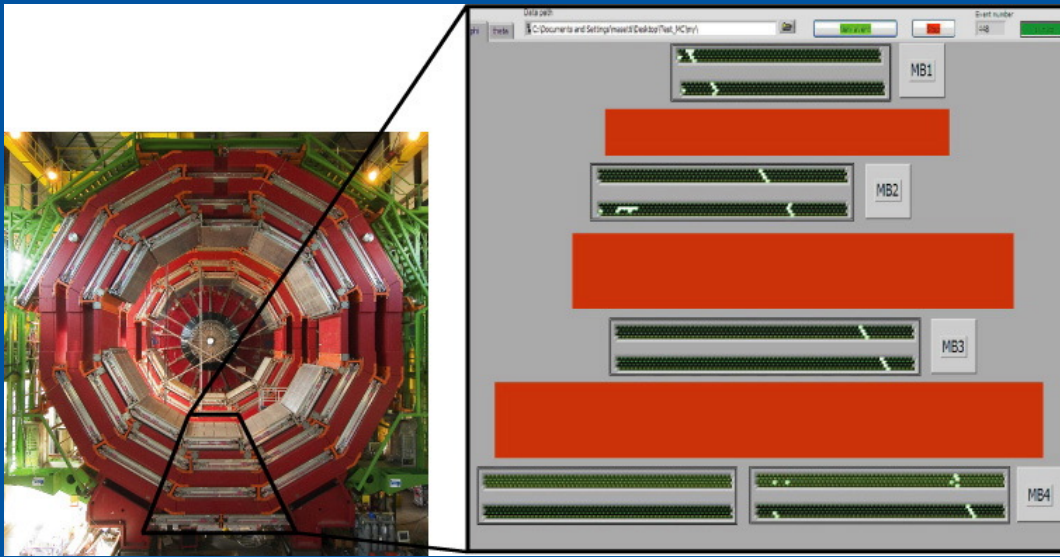

**Por ejemplo
está el CIEMAT,
donde hay un
grupo que
trabaja en CMS**

**Y además son
bastante activos
en
divulgación**

(gracias, Pablo)

**También hay otros (IFT, UAM, etc):
Aquí se hace física de partículas...**



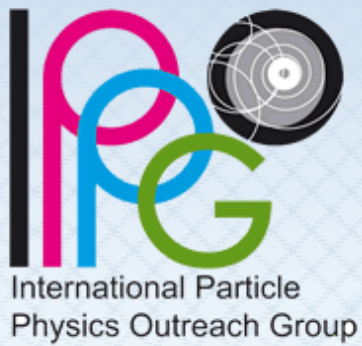

INTERNATIONAL



MASTERCLASSES

hands on particle physics

- Home
- Participate!
- Schedule
- My Country
- Physics
- Local Organisation
- In the Media
- Archive
- Contributors
- Contact Us



International Masterclasses 9th International Masterclasses 2013

Each year about 10.000 high school students in 37 countries come to university centres for one day in order to unravel the mysteries of particle physics. In the topics and methods of basic research at the fundamentals of measurements on real data from particle physics experiments then through their research collaboration, the participants join in a video conference for

Ciemat
Centro de Investigaciones
Energéticas, Medioambientales
y Tecnológicas



Instituto de Física Teórica UAM/CSIC

facebook
Name:
International
Particle Physics

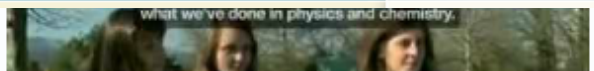

... were organized from 9.3.
... get out of school for one day and come to a nearby university or research centre

Vosotros, y luego vuestros alumnos, hacéis física de partículas con vuestras propias manos.
¡Con datos reales!

Se pueden buscar recursos a través del CPAN:

https:



The screenshot shows the CPAN Ingenio 2010 website. The header features the CPAN logo and the 'MasterC' title in large purple letters. A search bar and social media icons are visible in the top right. The main content area displays an article titled 'El CPAN en el Instituto' under the 'Bachillerato' category. The article text describes CPAN activities, including Higgs boson discovery, dark matter search, neutrino studies, and nuclear physics advances. It also mentions CPAN's role in organizing talks and masterclasses for secondary schools. A sidebar on the left lists various categories like 'Noticias', 'Convocatorias y Eventos', and 'Divulgación'.

CPAN Ingenio 2010

MasterC

Google™ Búsqueda Buscar

Twitter Facebook YouTube g+

Seguir a @CPAN_Ingenio

Noticias

Convocatorias y Eventos

Divulgación

La física en nuestras vidas

Aplicaciones de la física de partículas

Pregunta a un experto

Concurso de divulgación CPAN

El CPAN en el instituto

El CERN a través de los ojos de Peter Ginter, la visión de un poeta

El instrumento científico más grande jamás construido: Una exposición del CERN

LHC España

Rincón de prensa

Boletín

Material de divulgación

Semana de la ciencia

Enlaces

Bachillerato / Ver Editar Historial Imprimir

El CPAN en el Instituto

El CPAN en el Instituto Charlas Masterclass

'El CPAN en el Instituto' es una actividad organizada por el Centro Nacional de Física de Partículas, Astropartículas y Nuclear (CPAN). Con ella queremos acercar a los centros educativos la investigación que realizan los grupos del CPAN: el descubrimiento del **bosón de Higgs** o la búsqueda de **materia oscura** en el LHC; los estudios sobre **neutrinos**, la 'partícula fantasma'; los avances en física nuclear para conocer los límites del átomo; y las **aplicaciones** de todo esto, como las técnicas de Física Médica contra el cáncer.

Esta actividad consiste en dos acciones. El CPAN ofrece una serie de **charlas** divulgativas a demanda para Institutos de Educación Secundaria, donde expertos del CPAN se desplazan a los centros educativos en una fecha acordada para dar una charla a los alumnos sobre uno de los temas propuestos.

Por otra parte, se organiza un taller práctico o **masterclass** para alumnos de Bachillerato en el marco de la Semana de la Ciencia y la Tecnología en España. Un grupo de alumnos se desplaza a los centros CPAN participantes para realizar un ejercicio práctico con datos obtenidos del Gran Colisionador de Hadrones (**LHC**), el mayor acelerador de partículas del mundo.

El CPAN en el Instituto no se limita a la realización de las conferencias y al taller práctico. Queremos establecer un canal de comunicación entre los centros de investigación y los centros educativos que pueda

erato



Algunos fotos de la edición de 2009/2010.

El año próximo vuestros alumnos podrían participar

Public Data

Data Samples

Analysis Tools &

Formats

CMS Masterclass

Useful links

CMS Public Data

The CMS experiment at the LHC has release education and outreach. Explore this page and analyse it yourself.

Try the online event display below.

Use the Mouse to rotate.

Ctrl+Mouse or Ctrl +  to pan x/y.

Shift+Mouse or Shift +  to zoom.

Follow the links at left to access the full version of the display.

Click on the diagrams below to access the data:

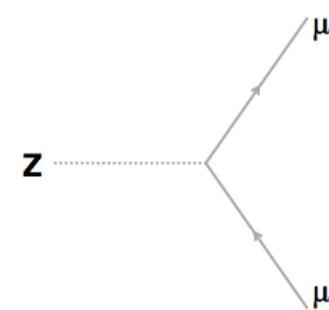
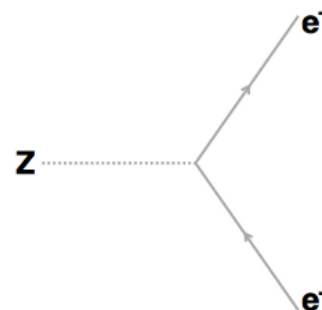
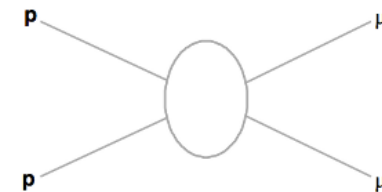
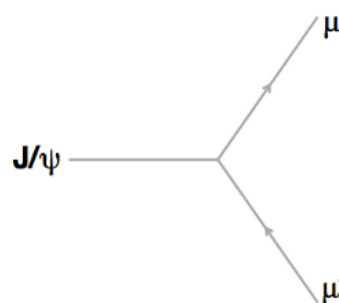

Y no hace falta participar en las masterclasses

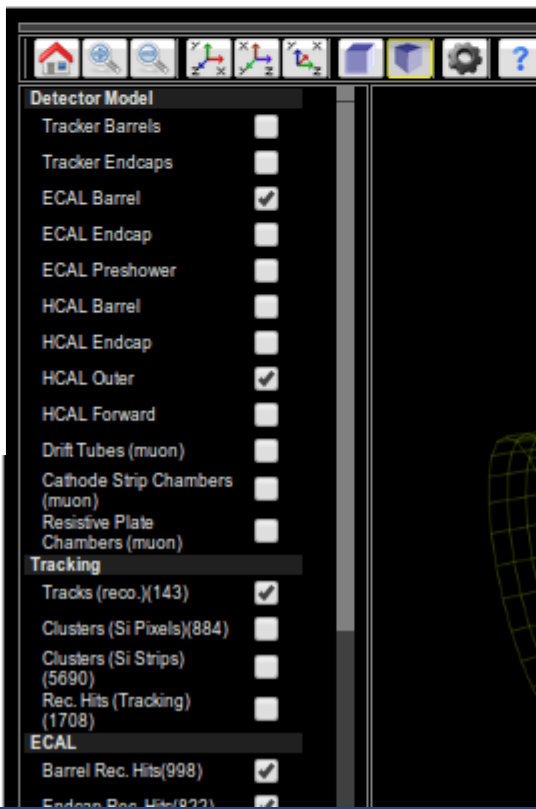

Detector Model

- Tracker Barrels
- Tracker Endcaps
- ECAL Barrel
- ECAL Endcap
- ECAL Preshower
- HCAL Barrel
- HCAL Endcap
- HCAL Outer
- HCAL Forward
- Drift Tubes (muon)
- Cathode Strip Chambers (muon)
- Resistive Plate Chambers (muon)

Tracking

- Tracks (reco.)(143)
- Clusters (Si Pixels)(884)
- Clusters (Si Strips)(5690)
- Rec. Hits (Tracking)(1708)

ECAL

- Barrel Rec. Hits(998)
- Endcap Rec. Hits(822)

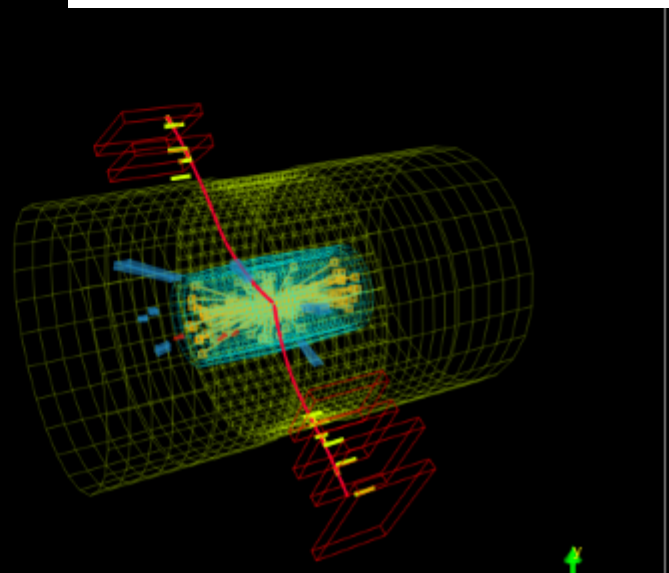

Education

http://opendata.cern.ch/

Firefox Web Browser



The CMS (Compact Muon Solenoid) experiment is one of two large general-purpose detectors built on the Large Hadron Collider (LHC). Its goal is to investigate a wide range of physics such as the characteristics of the Higgs boson, extra dimensions or dark matter.

[Explore CMS >](#)



ALICE (A Large Ion Collider Experiment) is a heavy-ion detector designed to study the physics of strongly interacting matter at extreme energy densities, where a phase of matter called **quark-gluon plasma** forms. More than 1000 scientists are part of the collaboration.

[Explore ALICE >](#)



The ATLAS (A Toroidal LHC ApparatuS) experiment is a general purpose detector exploring topics like the properties of the Higgs-like particle, extra dimensions of space, unification of fundamental forces, and evidence for dark matter candidates in the Universe.

[Explore ATLAS >](#)



The LHCb (Large Hadron Collider beauty) experiment aims to record the decay of particles containing b and anti-b quarks, known as B mesons. The detector is designed to gather information about the identity, trajectory, momentum and energy of each particle.

[Explore LHCb >](#)

For education purposes, the complex primary data need to be processed into a format (examples below) that is good for simple applications. Get in touch if you wish to build your own applications similar to those shown here

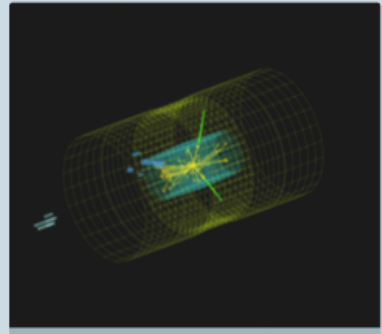

[Visualise events >](#)

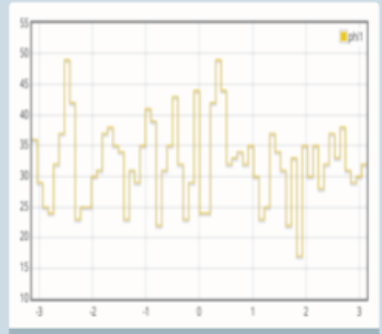

[Visualise histograms >](#)



[Learning Resources >](#)

Otros programas del CERN para profesores

 CERN — European Organization for Nuclear Research

CERN Programme for Physics High School Teachers

This 3-week residential programme, which has been taking place every year since 1998 at CERN during the month of July, is open to Physics High School Teachers from all CERN member and observer States, as well as from other countries subject to funding availability, who would like to update their knowledge of particle physics, its associated technologies and related subjects.

Goals of the High School teachers' programme:

- To promote the teaching of physics and, in particular of particle physics, in high schools
- To promote the exchange of knowledge and experience among teachers of different nationalities
- To expose teachers to the world of research
- To stimulate activities related to the popularization of physics within and beyond the classroom
- To help CERN establish closer links with European schools
- To encourage the cooperation between CERN and existing programs sponsored by the European Union in the area of scientific education

The work produced during the 3-week programme is documented and collected by the participants at -

<http://teachers.cern.ch/>.

Please consult this site for more details about the programme, and for a good collection of materials to be used in the class-room.

Merece la pena...

Visitas al CERN con alumnos



The screenshot shows the CERN Visits website. The browser address bar displays 'http://outreach.web.cern.ch/outreach/visits/'. The page features the CERN logo and the title 'Come to CERN'. A search bar is located in the top right corner. Below the header, there are navigation tabs for 'Events and exhibitions', 'Visits', 'The Globe', and 'Contact'. A large banner image shows a group of people in hard hats and safety vests standing near a large orange industrial machine. The word 'VISITS' is overlaid on the banner. On the left side, there is a vertical menu with links: 'General information', 'Itineraries', 'Safety', and 'Booking form'. The main content area on the right has the heading 'General information' and a sub-heading 'Organising a tour of an experiment'. Below this, there is a paragraph of text starting with 'CERN's Visits Service organises tours of its experimental areas and facilities, which are free of charge. Tours in several languages are organised on Mondays to Saturdays starting at 9...

Solicitud

Alojamiento y transporte

Posibles visitas en la zona

Podemos preguntar a bastantes profes ya