

# **La fisica delle astroparticelle e l'esperimento AMS-02 sulla ISS**

**CERN Teacher Programme  
22 Novembre 2017**

**Sonia Natale**

# 1912 - 2012: 100 anni di scoperte



La rivelazione della radiazione cosmica puo' essere considerata la scoperta del secolo e ha modificato la nostra visione del cosmo.

**A ragione puo' essere considerata una pietra miliare degli inizi della fisica delle particelle**

Prima dello sviluppo della fisica degli acceleratori, la ricerca sui raggi cosmici ha portato alla scoperta di molte importanti particelle elementari come ad esempio l'anti-particella dell'elettrone, il positrone, cosi' come il muone ed il pione.

# Scoperte dal 1898 al 1964

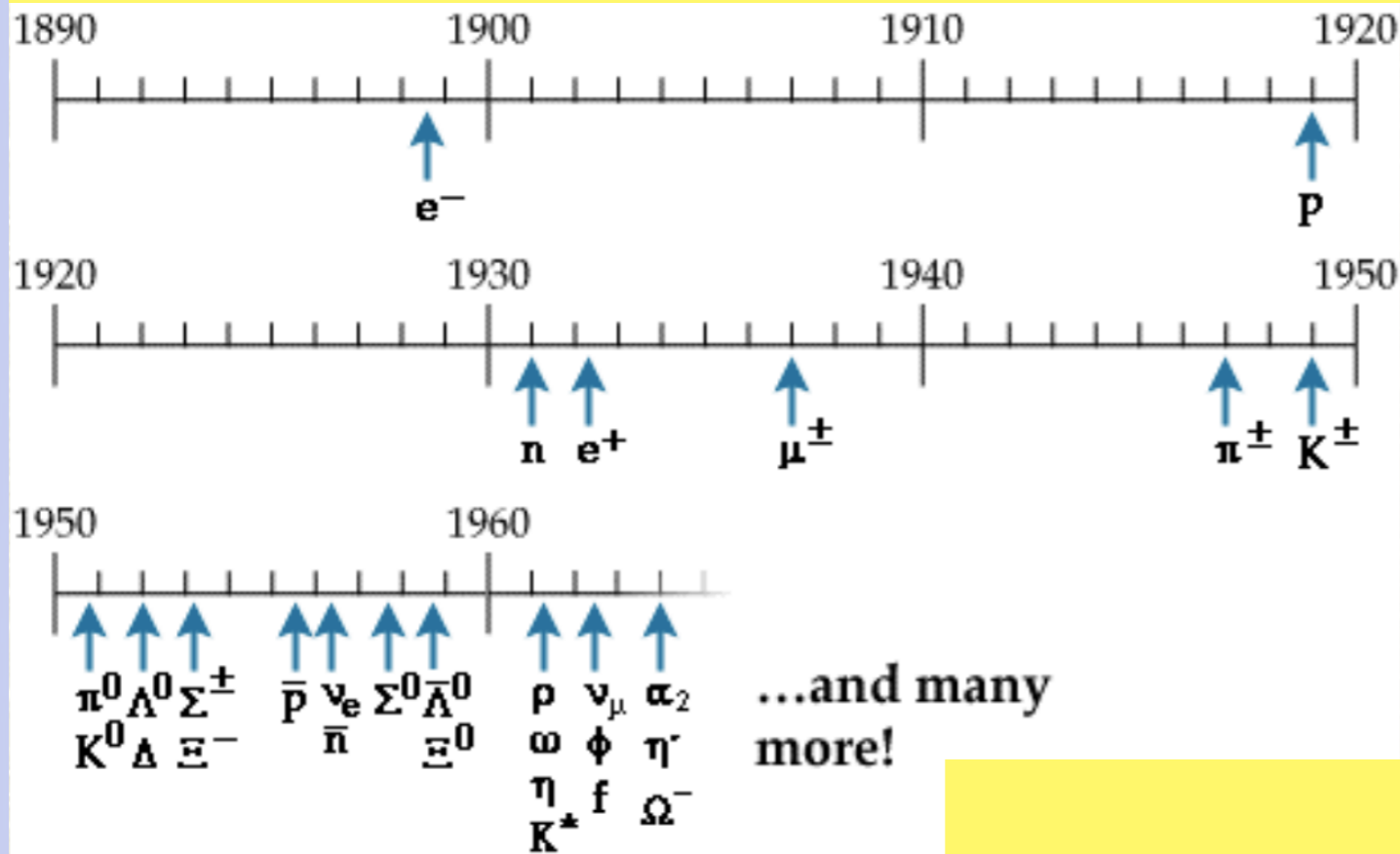

# Cronologia della scoperta delle particelle

# Scoperte dal 1964

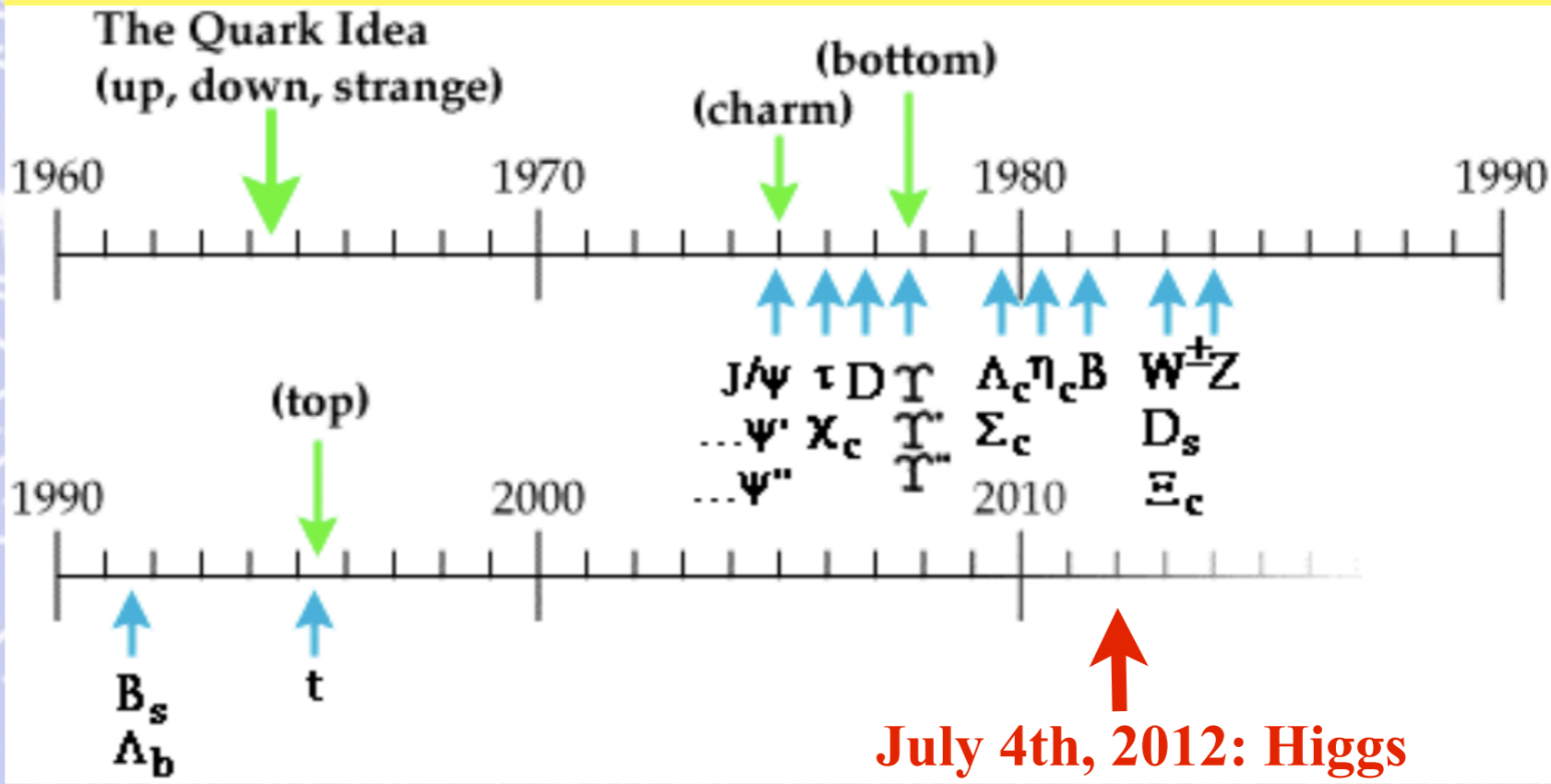

July 4th, 2012: Higgs

# Cronologia delle Fisica delle Particelle

**Gli inizi:  
sinergia tra l'infinitamente piccolo e  
l'infinitamente grande**

**1895 Scoperta dei raggi X (W. Roentgen)**

**1896 Scoperta della radioattività (H. Becquerel)**

**1897 Scoperta dell'elettrone (J.J. Thomson)**

**1898 Isolamento del radio (M. Curie and P. Curie)**

**1905 Teoria della relatività speciale (A. Einstein)**

**1909 La particella  $\alpha$  è un nucleo di elio (Rutherford and Royds)**

**1911 Scoperta del nucleo dell'atomo (E. Rutherford)**

**1912 Scoperta della radiazione cosmica (Victor Hess)**

**1913 Modello atomico planetario (N. Bohr)**

**1915 Teoria della relatività generale (forma finale) (A. Einstein)**

**1919 Eddington osserva deviazione della luce in una eclisse totale del Sole**

**1926 Meccanica quantistica (E. Schrodinger)**

**1927 Equazione di Dirac e predizione delle anti particelle (P. Dirac)**

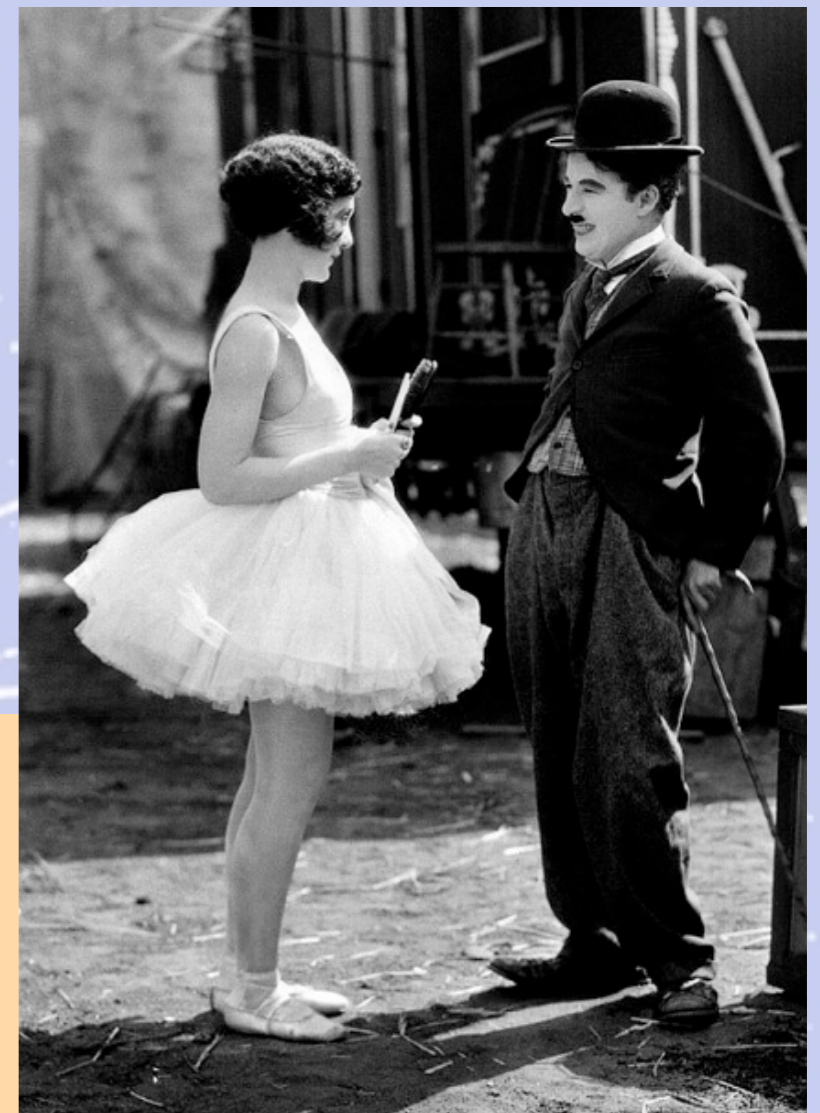

# Cronologia delle Fisica delle Particelle

Il periodo intermedio:  
i tempi d'oro dell'infinitamente grande



1928 Teoria della radioattività  $\alpha$  (Gamow, Gurney, Condon)

1930 Hubble scopre L'espansione dell'universo

1930 Ipotesi esistenza neutrino (W. Pauli)

1930 Invenzione del ciclotrone (E.O. Lawrence)

1932 Scoperta del neutrone (Chadwick)

1933 Scoperta del positrone nei raggi cosmici (Anderson)

1934 Teoria della radioattività  $\beta$  (E. Fermi)

1935 Ipotesi dei mesoni (Yukawa)

1937 Scoperta del muone nei raggi cosmici (Neddermeyer, Anderson)

1947 Scoperta del pione nei raggi cosmici (Powell)

1947 Scoperta kaone e "particelle strane" nei raggi cosmici (Rochester & Butler)

1950 Scoperta del barione "strano"  $\Lambda$  (Hopper & Biswas)

# Cronologia delle Fisica delle Particelle

**Tempi Moderni:  
l'era d'oro dell'infinitamente piccolo**

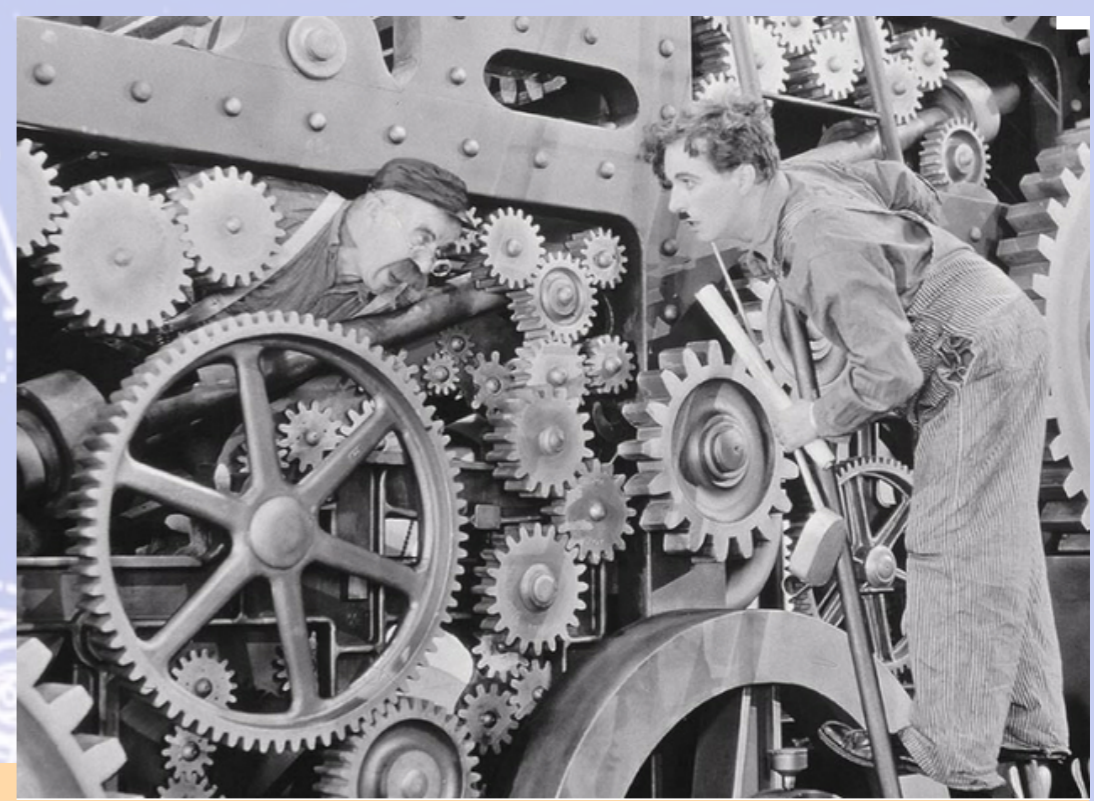

**1952 Altre particelle “strane” ( $\Xi$ ,  $\Sigma$ ) scoperte nei raggi cosmici.**

**1955 Scoperta dell'antiprotone al Bevatron (Chamberlain & Segre)**

**1956 Scoperta dell'antineutrone al Berkeley Bevatron**

**1956 Rivelazione sperimentale del neutrino (Reines, Cowan @ Los Alamos)**

**1974 Scoperta della risonanza  $J/\psi$  (quark Charm) (Richter & Ting)**

**1975 Scoperta del leptone  $\tau$  (Perl SLAC-LBL)**

**1977 Scoperta del quark bottom (E288 Fermilab)**

**1983 Scoperta dei bosoni W e Z (Rubbia & Van der Meer)**

**1995 Scoperta del quark top (D0 e CDF)**

**2000 Scoperta del neutrino  $\tau$  (DONUT)**

**1995- Scoperta delle oscillazioni e della massa del neutrino (neutrino solare ed atmosferico) (Homestake, GALLEX, SAGE, Super-K, SNO, ...)**

**2012 Scoperta del bosone di Higgs all' LHC (ATLAS, CMS)**

# Cronologia della Fisica delle Particelle

Per risolvere il “puzzle” delle particelle, i fisici richiedono delle energie sempre maggiori di quelle che la odierna tecnologia degli acceleratori e' in grado di offrire.  
Ecco perche' alcuni di essi hanno deciso di



## TORNARE ALLA RICERCA NEL COSMO !

Sin dalla meta' degli anni '80 fino ad ora, la fisica delle **ASTRO-PARTICELLE** e' stata un campo di attivita' sempre crescente.

Infatti, qualsiasi sia il metodo utilizzato per ricercare le particelle (dai raggi cosmici o utilizzando la tecnologia degli acceleratori) **la maggior parte delle domande e' comune ad entrambi i campi.**

# Il Modello Standard della Fisica delle Particelle



100 anni per svilupparlo!

Verificato con incredibile precisione!

Tiene conto di tutti i dati raccolti della fisica delle particelle!

**Il bosone di Higgs era il solo "pezzo del puzzle" rimasto inosservato e rappresenta un portale verso settori nascosti di nuova fisica**



**Ci sono due osservazioni non ancora spiegate dal Modello Standard che potrebbero essere correlate con nuova fisica alla scala elettrodebole**

## **Materia Oscura nell'Universo**

**Un tipo di materia invisibile e trasparente (non interagisce con i fotoni) la cui presenza e' dedotta attraverso i suoi effetti gravitazionali.**

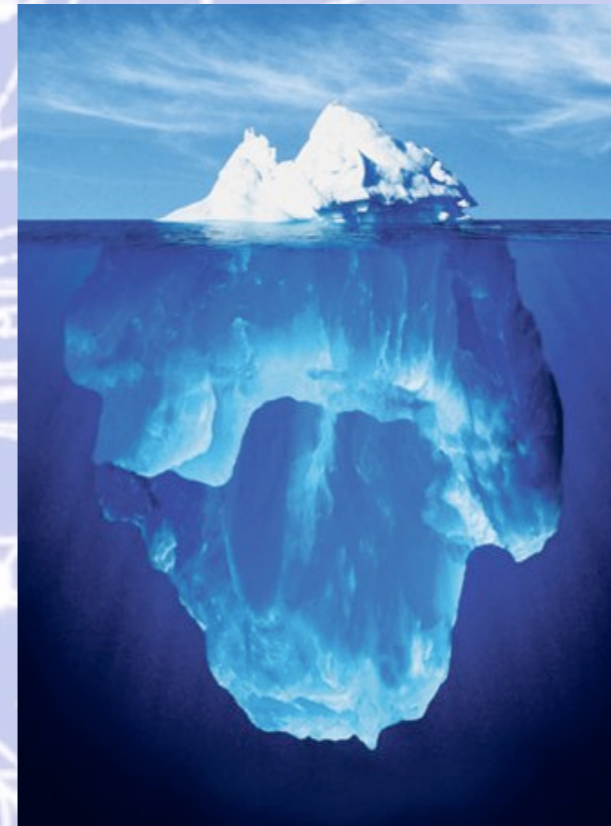

**15% materia barionica  
(1% stelle, 14% gas)**

**85% materia "oscura"  
sconosciuta**

*G. Servant*

## **(Quasi) assenza di antimateria nell' Universo**

**Asimmetria barionica:  $\frac{n_B - \bar{n}_B}{n_B + \bar{n}_B} \sim 10^{-10}$**

# Candidati della Materia Oscura: due principali possibilita'

molto leggera & accoppiamento solo gravitazionale → stabile su scale cosmologiche

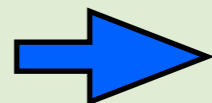

Long-lived  
(stabile su scale cosmologiche)

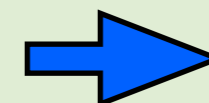

$\tau_{DM} > \tau_{universe} \sim 10^{18} \text{ s}$

DM = Dark Matter

OR

interazione misurabile (ma non per via forte) con lo SM → simmetria necessaria per garantire a stabilita'

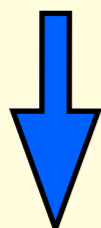

stabile rispetto ad una simmetria

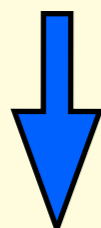

WIMP

WIMP = Weak Interactive Massive Particle

La restante abbondanza di un tipo di particella stabile segue dal generico meccanismo di "freeze-out" termico dell'espansione dell'universo.

Thermal relic:  $\Omega_{DM} \propto 1/\sigma_{annih}$

$\sigma_{annih} \approx 1\text{pb}$  conduce alla corretta abbondanza di DM

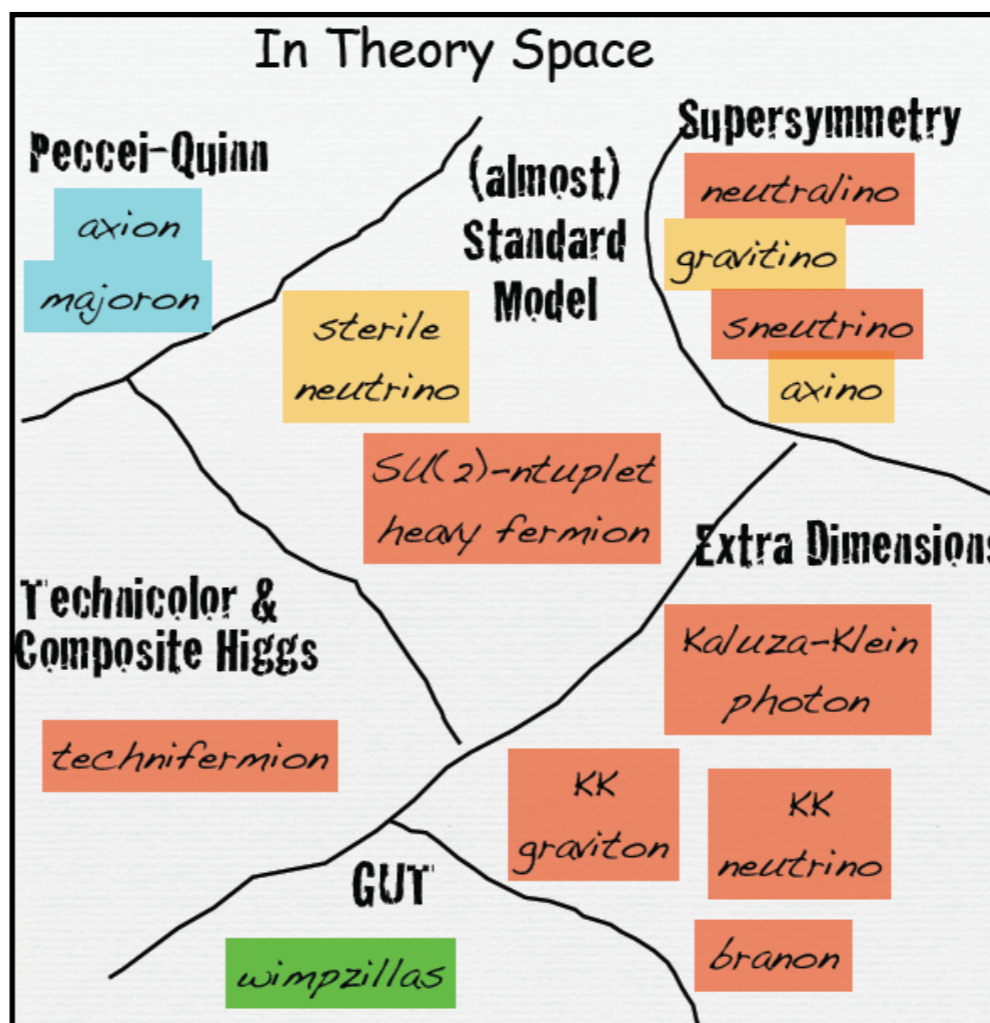

Candidati della Materia Oscura con  $\Omega_{DM} \sim 1$

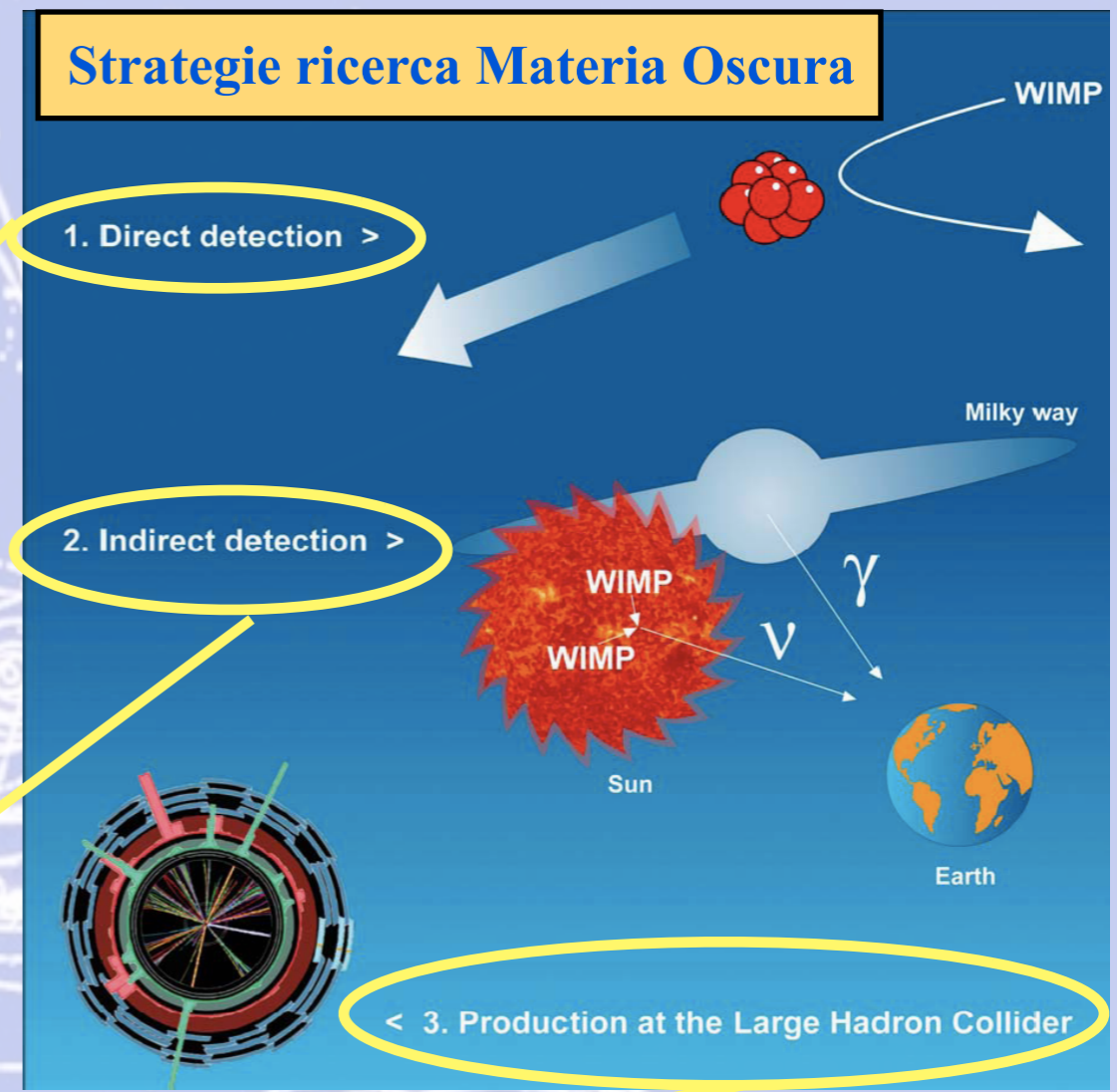
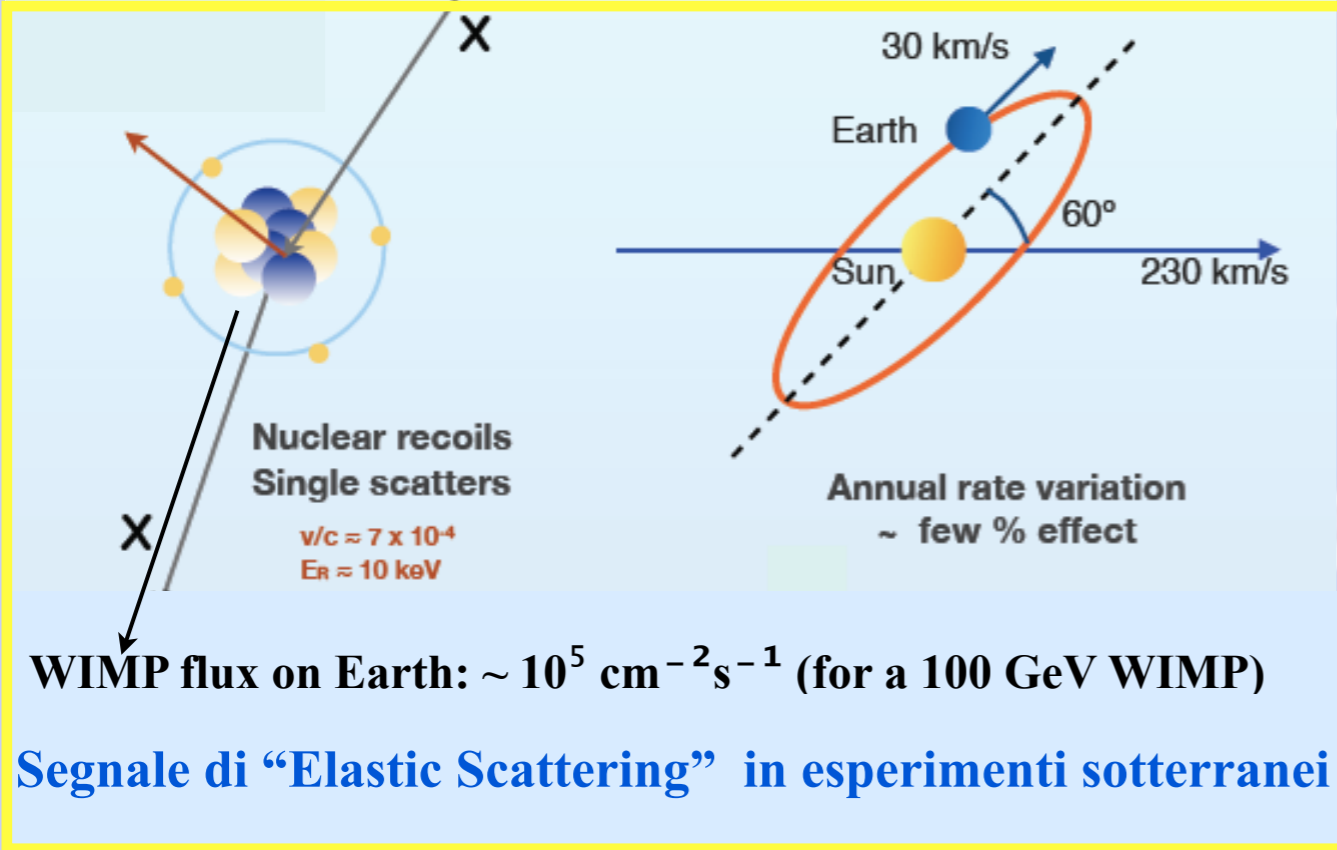

### Segnale di annichilazione nello spazio

La Materia Oscura puo' produrre fotoni, elettroni, protoni, neutrini, antiprotoni, positroni

**Raggi gamma primari (Linee monoenergetiche o spettro continuo)**

**Raggi gamma secondari (Spettro Continuo)**

WIMP Dark Matter Particles  $E_{CM} \sim 100 \text{ GeV}$

Neutrinos

+ a few  $p/\bar{p}$ ,  $d/\bar{d}$  Anti-matter

### Produzione Materia Oscura all' LHC

7 TeV

Interaction

hadronic jets

leptons

Visto nel rivelatore

Missing energy

Segnale di energia mancante in acceleratori di alta energia

# Antimateria: problemi e domande

**La Teoria del Big Bang richiede una uguale abbondanza di materia e antimateria.**

Dopo l'inizio dell' "era" delle particelle, non si è trovato alcun processo che possa cambiare il numero netto di particelle dell'universo.

A partire da un millisecondo dopo il Big Bang, il bilancio tra materia ed antimateria è stato fissato per sempre.

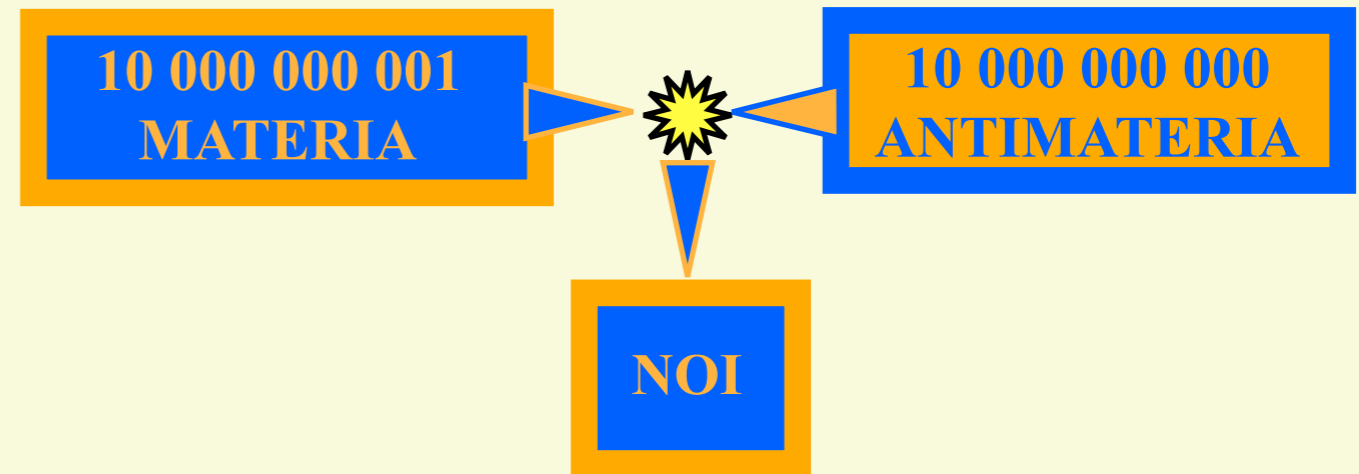

**Esiste una qualche ASIMMETRIA nel modo in cui la natura tratta materia e antimateria?**

**Una linea di investigazione molto promettente è quella delle CP violazioni della simmetria CP nei decadimenti di particelle via interazione debole.**

**La principale evidenza sperimentale proviene dal decadimento del kaone neutro, che mostra una piccola violazione della simmetria CP. Nel decadimento dei kaoni in elettroni, abbiamo una netta distinzione tra materia e antimateria, e ciò potrebbe essere almeno una delle spiegazioni della predominanza di materia rispetto all'antimateria nell'universo.**

**Una prima evidenza ( $3.5\sigma$ ) si è avuta a LHCb con 0.8% di differenza nel tasso di decadimento del mesone D e della sua antiparticella (2011).**

**Questo potrebbe essere un altro contributo alla soluzione del problema dell'antimateria.**

# Antimateria: problemi e domande

**La presenza di antimateria entro il nostro gruppo di galassie  
e' esclusa:  
il segnale di annichilazione e' troppo piccolo.**

**...ma se una volta e' esistita, dov'e' ora ?**

**Lontano da noi ?**

**Esiste un qualche resto di antimateria nell'Universo vicino?**

**Singolo nucleo di anti-He nei raggi cosmici:  
Agglomerati di Antimateria**

**Singolo nucleo di anti-C nei raggi cosmici:  
Stelle di Antimateria**

# NON conosciamo ancora la fisica dei primi istanti dopo il Big Bang !

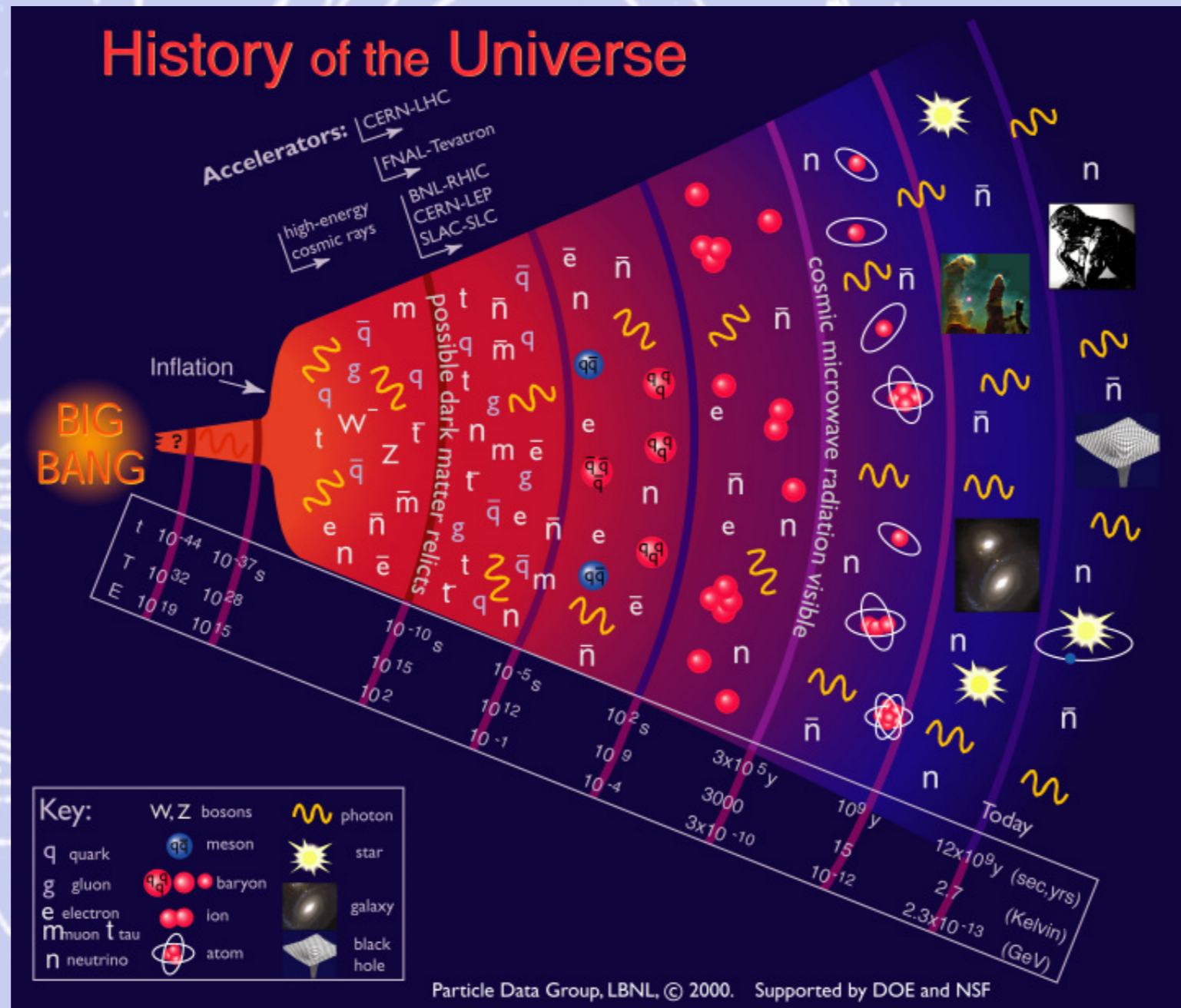

.... Materia Oscura e Antimateria sono solo due esempi tra i tanti segreti dell' Universo!

# Perche' investigare nello spazio?

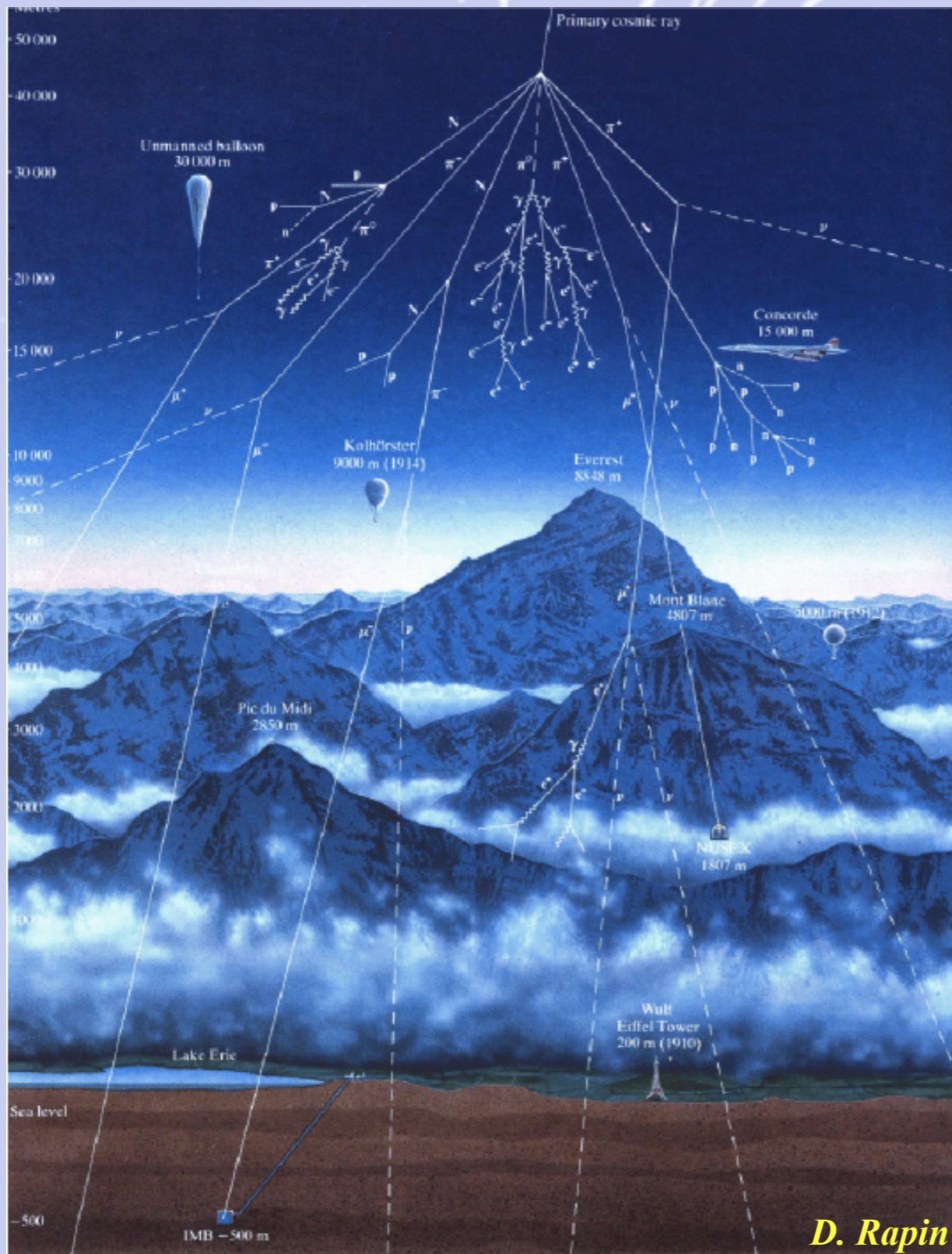

**L'atmosfera non e' trasparente alle particelle cariche o ai raggi X e gamma: le interazioni degradano l'informazione della particella iniziale.**

**Il suo spessore in termini di massa ( $1\text{kg}/\text{cm}^2$ ) e' equivalente ad uno schermo di 4 m di cemento.**

**Palloni aerostatici a 35 km ( $5\text{g}/\text{cm}^2$ ) ma il tempo di esposizione e' limitato a ~20 giorni.**

**I rivelatori su satellite hanno un tempo di esposizione piu' lungo dell'ordine di qualche anno (3→15).**

*D. Rapin*

# Qual e' la composizione dei Raggi Cosmici primari?

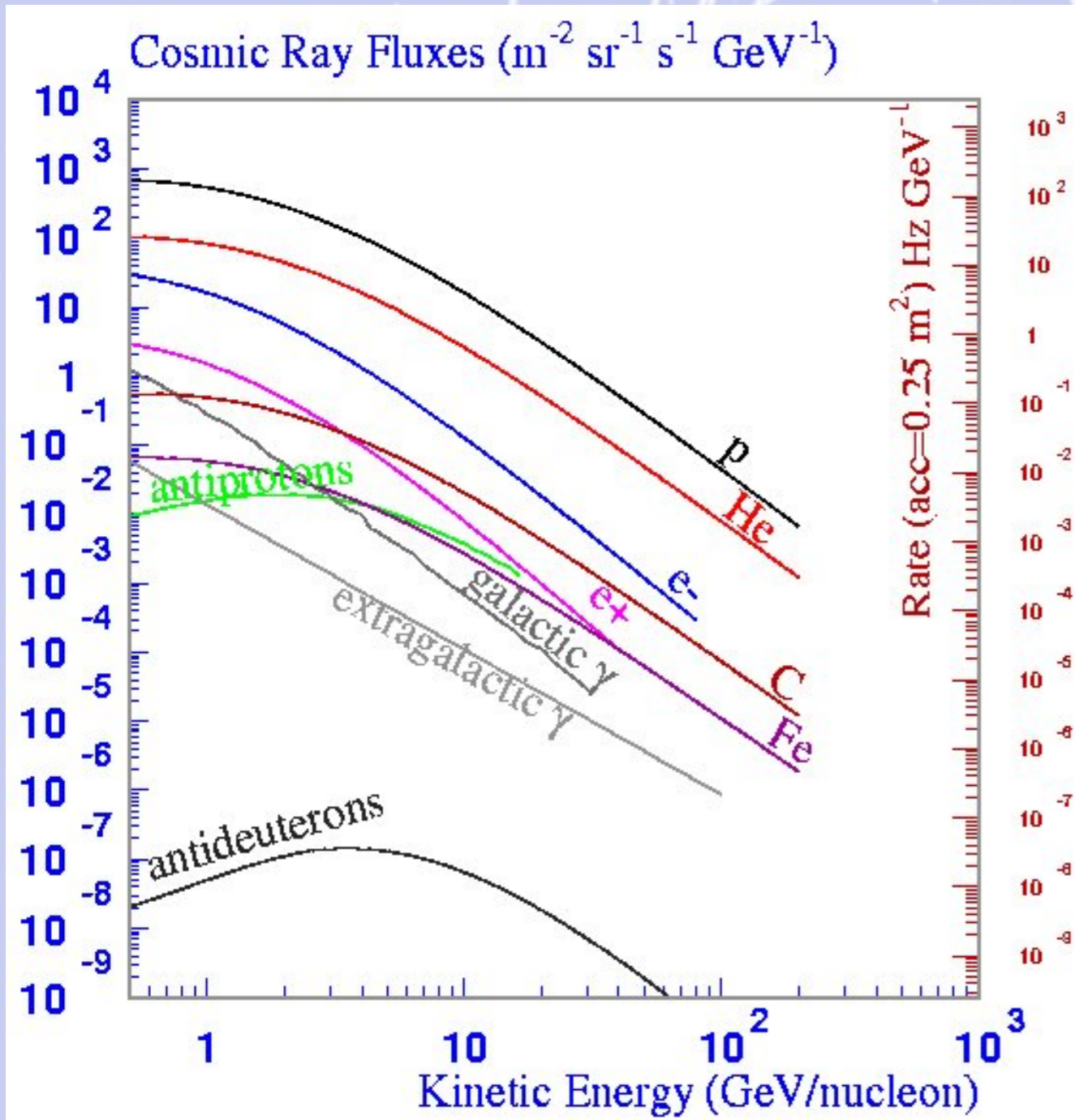

- **p**: componente dominante
- **He**: 5% del flusso p @ 10GeV
- **D, Li, Be, B e C**
- **Anti-protoni**:  $\sim 10^{-4}$  del flusso p

**Protoni**: un modo per misurare l'attivita' solare

**Isotopi**: informazioni sulla propagazione dei Raggi Cosmici nella Galassia.

**$^{10}\text{Be}/^9\text{Be}$  ratio ( $^{10}\text{Be}$ ,  $\tau_{1/2}=1.6 \times 10^6 \text{yrs}$ ):**

- Tempo di confinamento dei Raggi Cosmici nella Galassia.
- Densita' media del materiale interstellare attraversato.



# L' esperimento AMS-02 sulla ISS



# AMS-02: un esperimento "multipurpose" di fisica delle particelle operante nello spazio

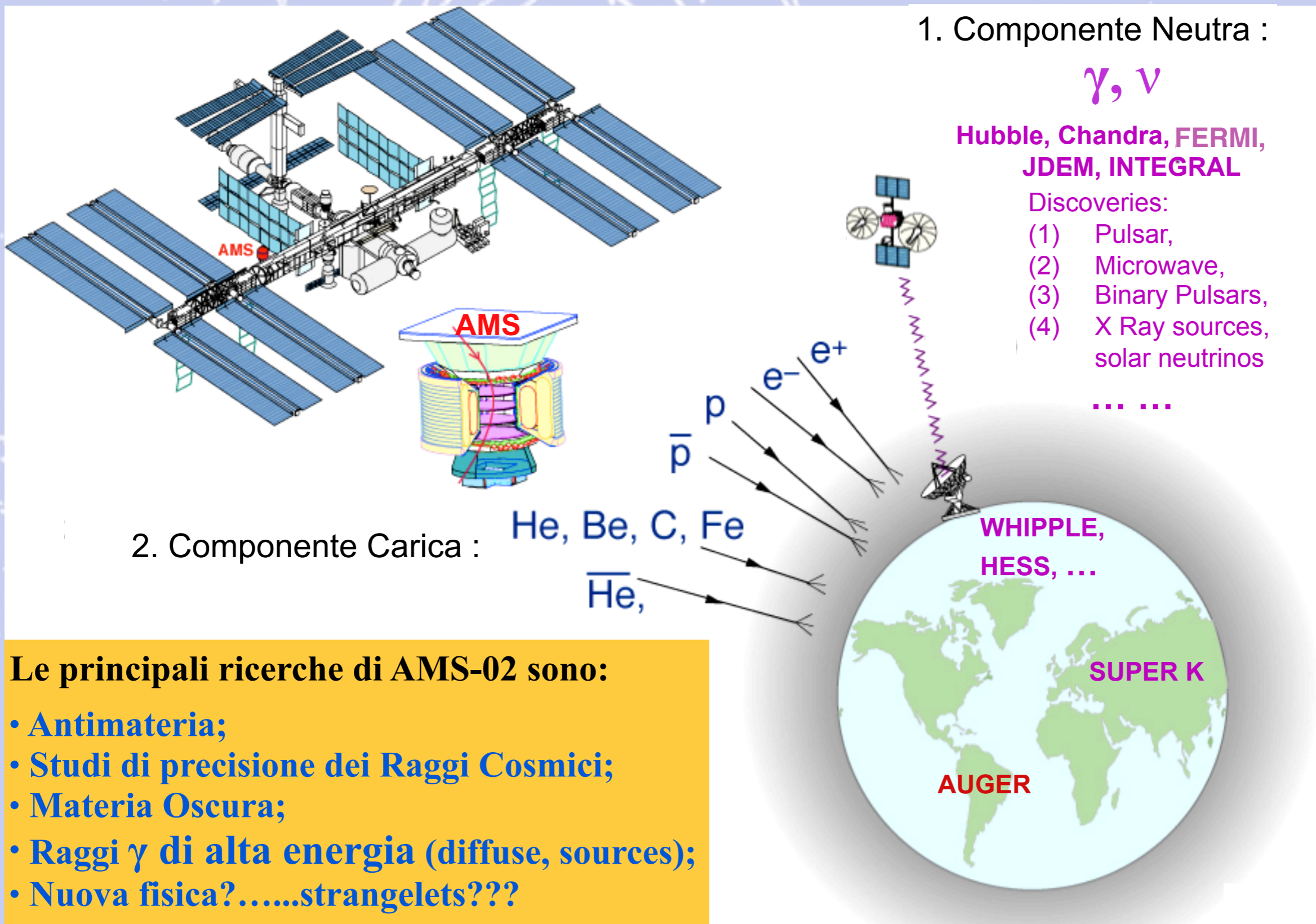

- Le principali ricerche di AMS-02 sono:**
- Antimateria;
  - Studi di precisione dei Raggi Cosmici;
  - Materia Oscura;
  - Raggi  $\gamma$  di alta energia (diffuse, sources);
  - Nuova fisica?.....strangelets???



**Peso Totale: 2008 t**

**Peso AMS-02: 7.5 t**

**Preso dati iniziata alle 9:35 AM**



**Lancio: 16 Maggio 2011, 08:56 AM**



**Installazione: 19 Maggio 2011, 05:15 AM**

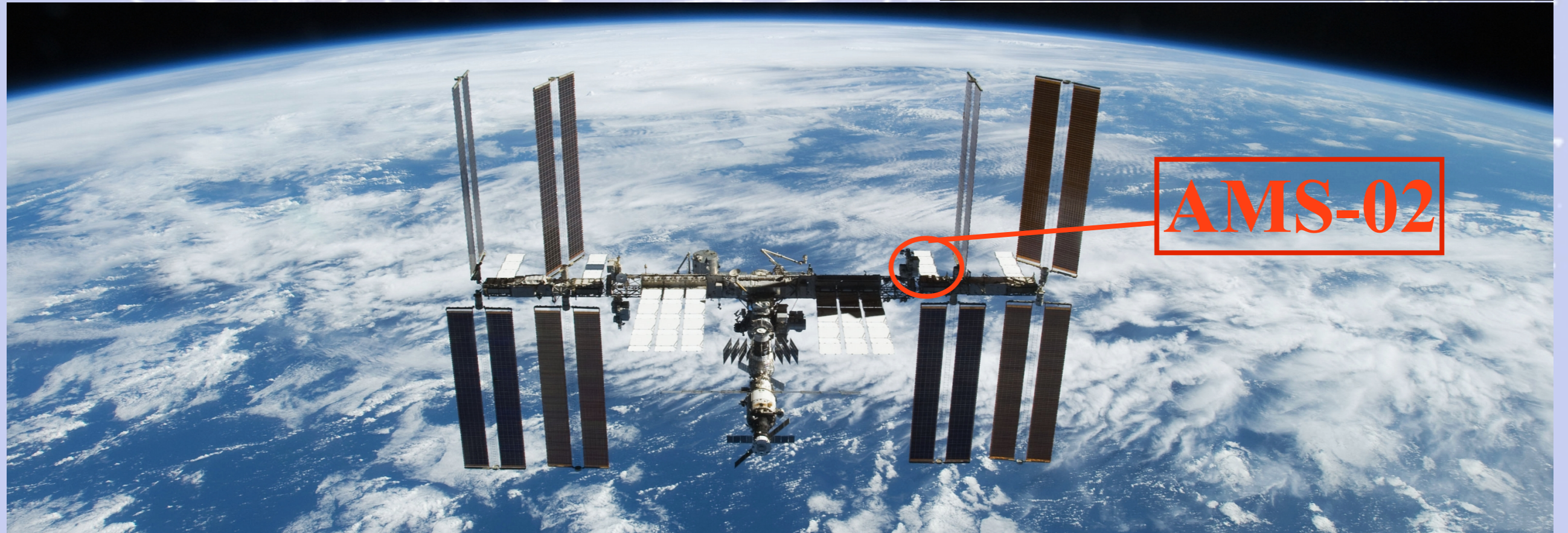

# Come opera AMS-02 in volo e a terra



# Parametri orbitali del DAQ di AMS-02

## Acquisition rate [Hz]

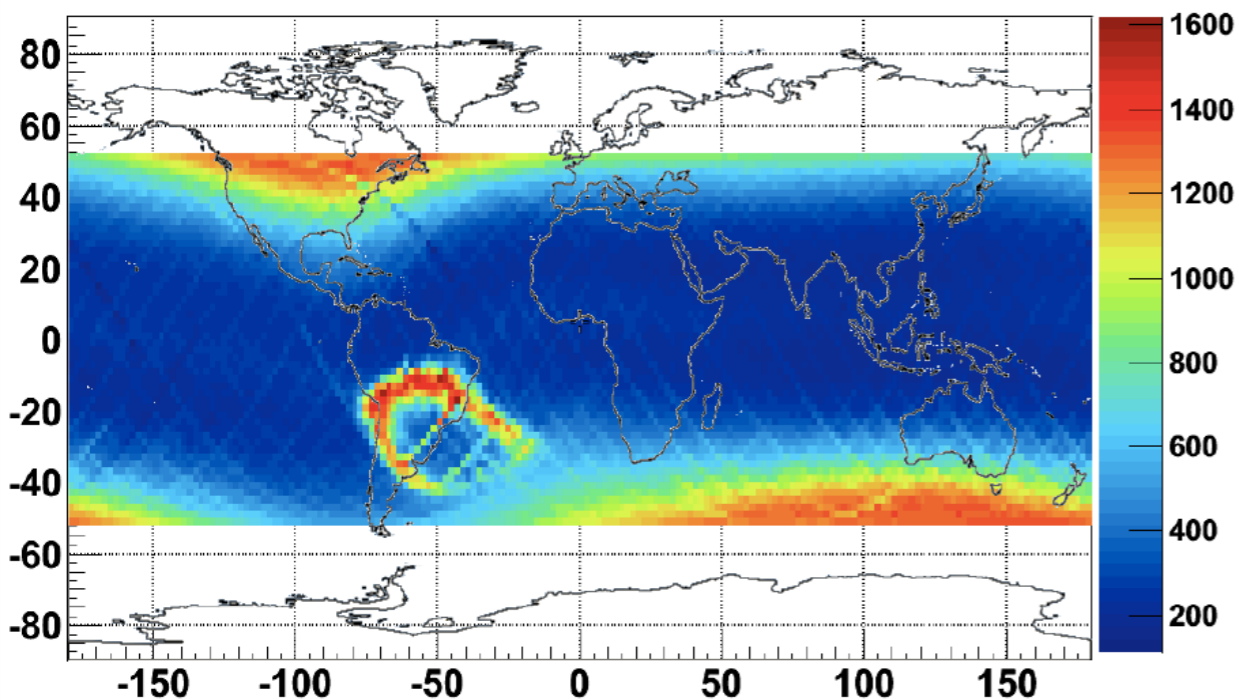

## Time at location [s]

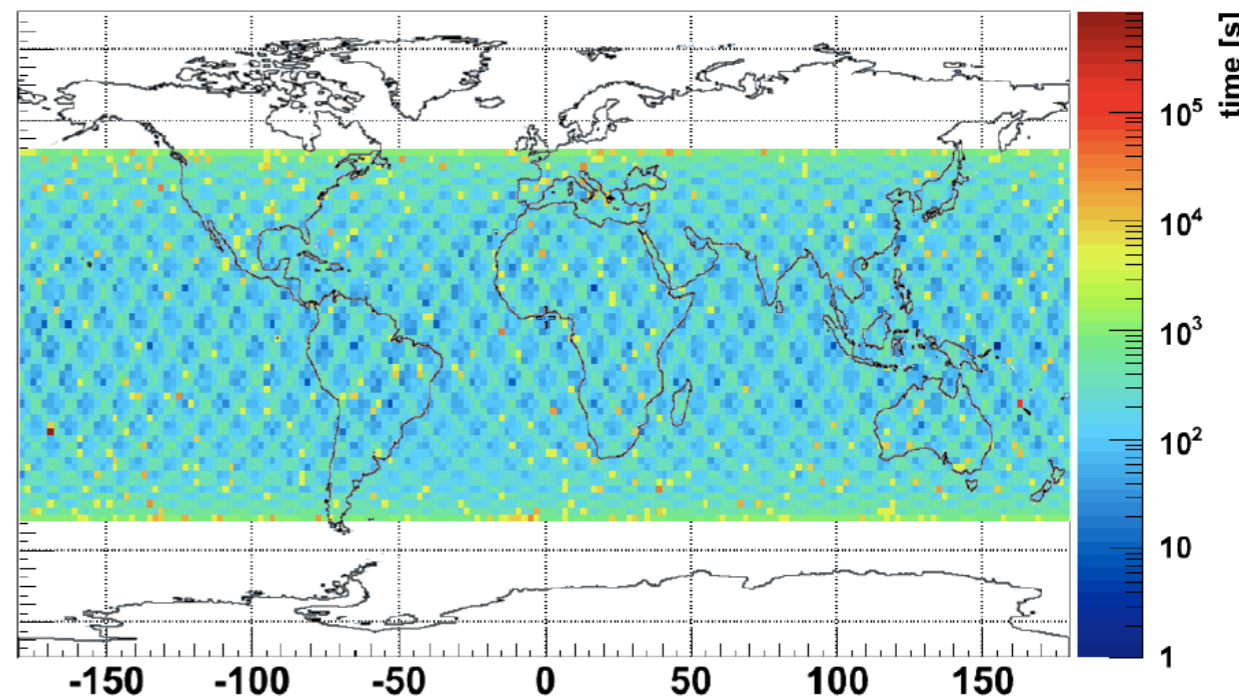

## DAQ efficiency

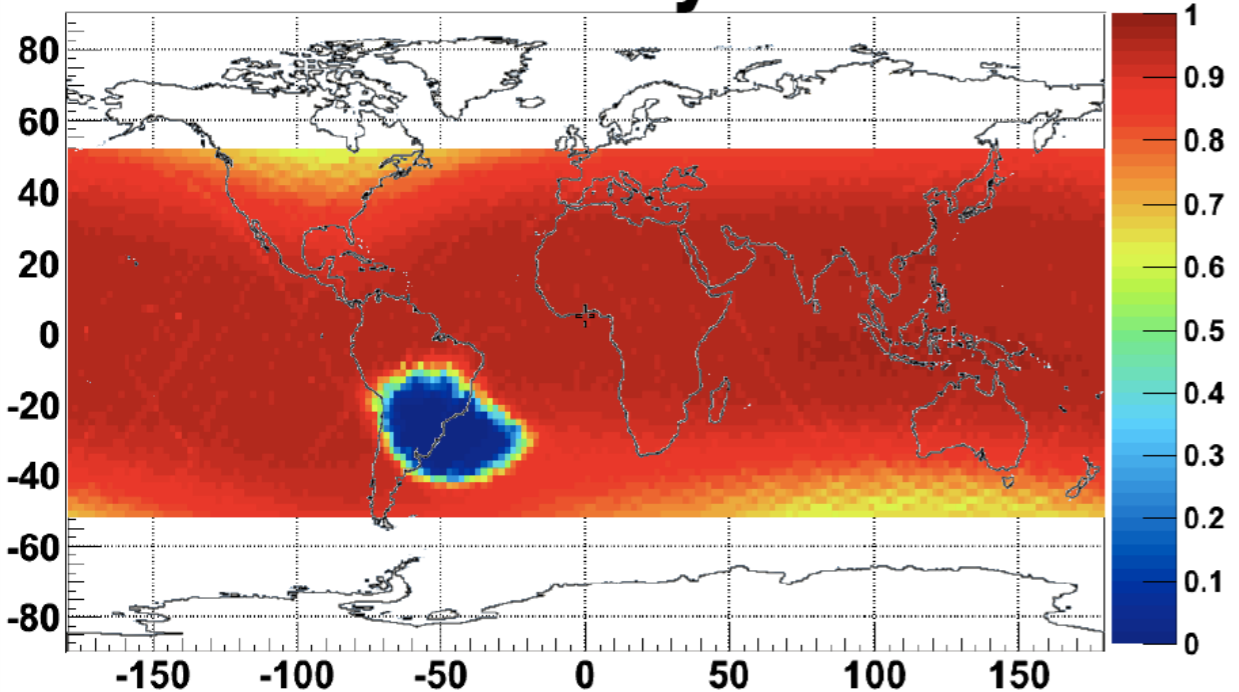

“Particles rate” varia da 200 to 2000 Hz per orbita

In media:  
DAQ efficiency 85%  
DAQ rate ~700Hz

# AMS-02: uno spettrometro di precisione per energie GeV/TeV

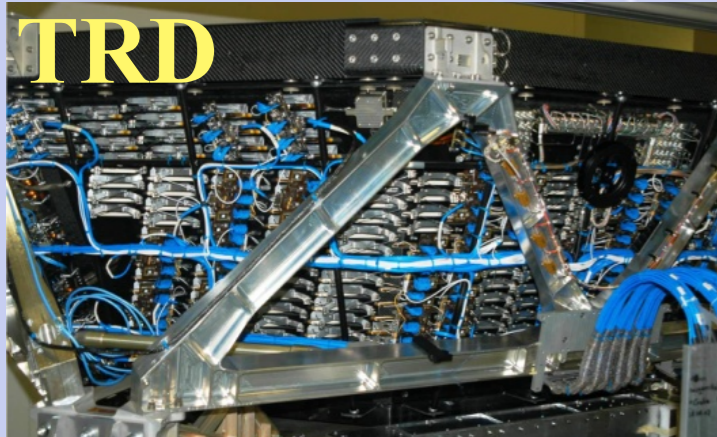

**TRD**

Identify  $e^+$ ,  $e^-$ ,  $Z$

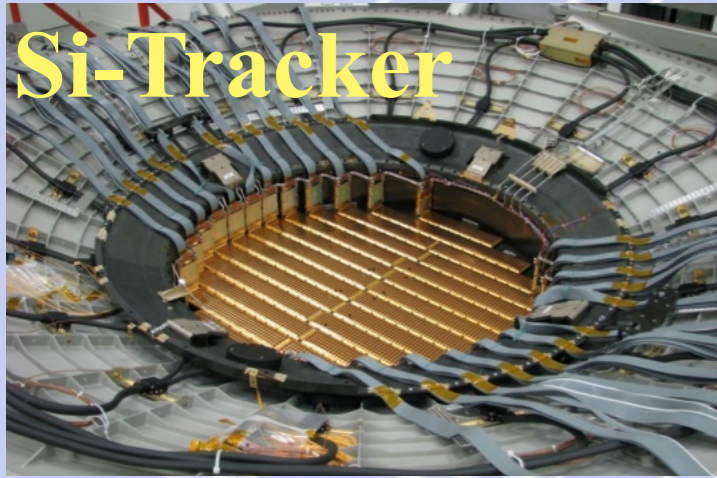

**Si-Tracker**

Identify  $Z$ , Measure  $P$

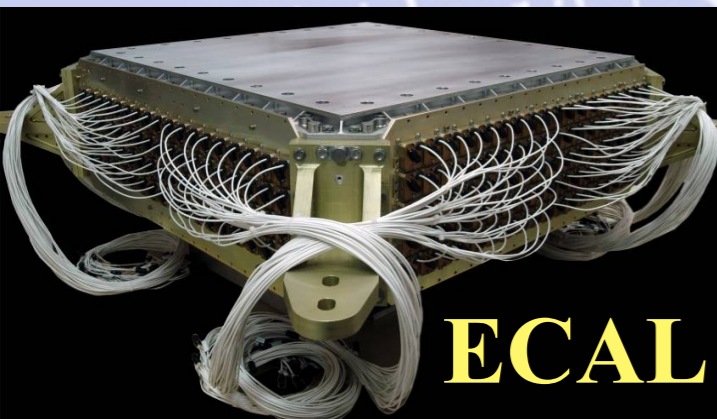

**ECAL**

Measure  $E$  of  $e^+$ ,  $e^-$ ,  $\gamma$

Le particelle ed i nuclei sono definiti dalla loro carica ( $Z$ ) e dall'energia ( $E \sim P$ )

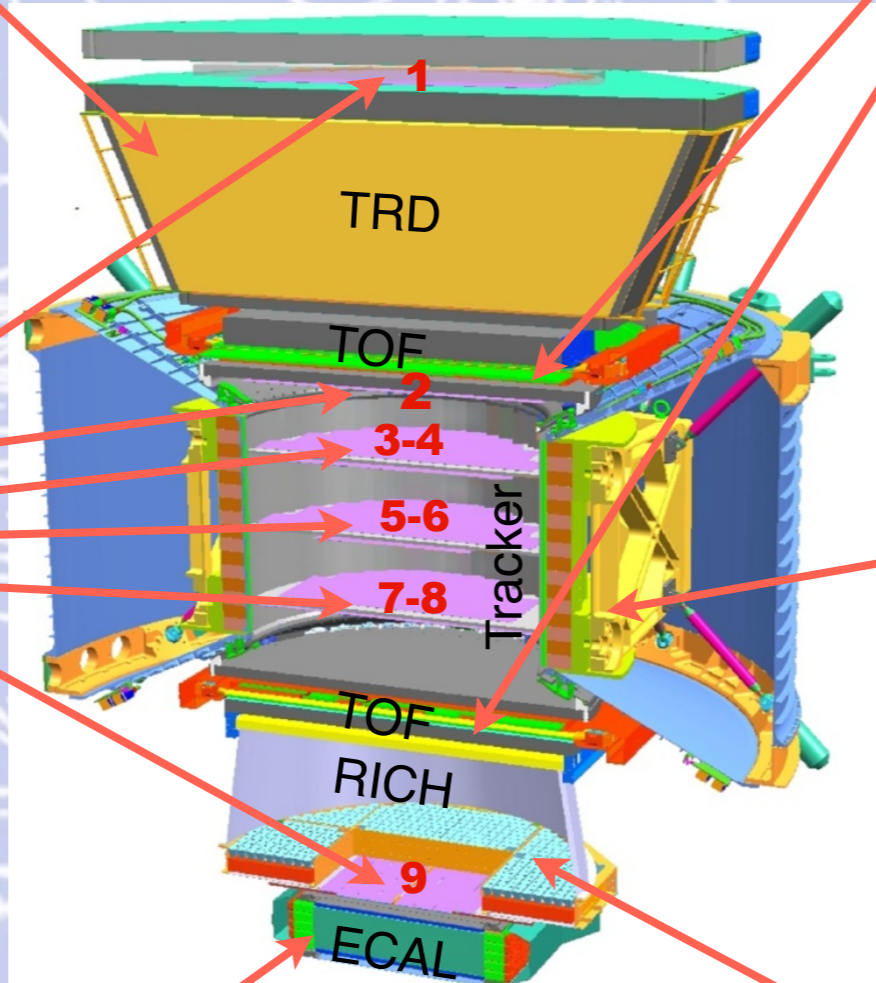

$Z$ ,  $P$  sono misurati indipendentemente dal Tracker, RICH, TOF e ECAL



**TOF**

Identify  $Z$ , Measure  $E$

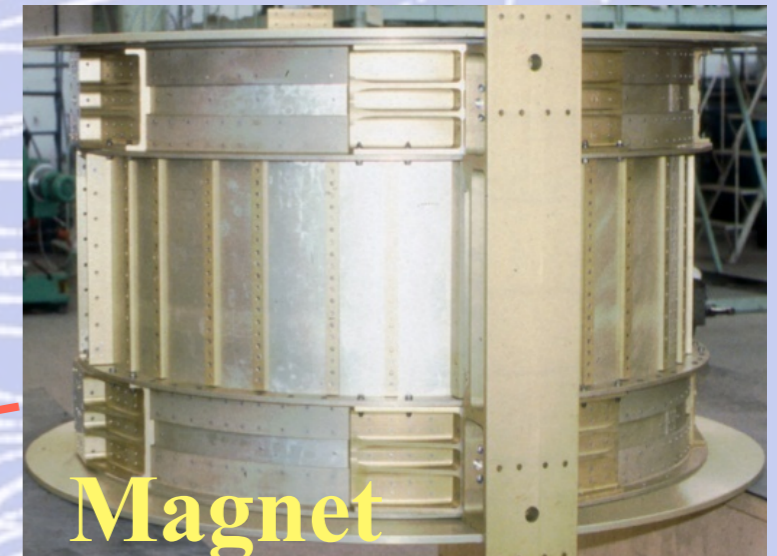

**Magnet**

Identify  $\pm Z$



**RICH**

Identify  $Z$ , Measure  $E$

# Potenziale di fisica di AMS-02

## Ricerca dell'antimateria primordiale:

- anti-nuclei:  $\overline{\text{He}}$ , ... ;

## Ricerca della Materia Oscura:

- $e^+$ ,  $e^\pm$ ,  $\overline{p}$ ,  $\gamma$ , ... ;
- osservazione simultanea di diversi canali di segnale ;

## Ricerca di nuove forme di materia :

- strangelets, ... ;

## Misura degli spettri dei CR - “fine tuning” del modello di propagazione:

- D, He, Li, Be, B, C.....Fe....Ni;

## Studi di sorgenti locali (astrofisica dei raggi $\gamma$ ):

- SuperNovae Remnants, Pulsars, Primordial Black Holes, .....

Studio degli effetti della modulazione solare sugli spettri dei CR lungo tutto il ciclo solare (11 anni) ;

.....



# Sensitivita' della ricerca dell'Antimateria: $\text{He}/\bar{\text{He}} > 10^{10}$

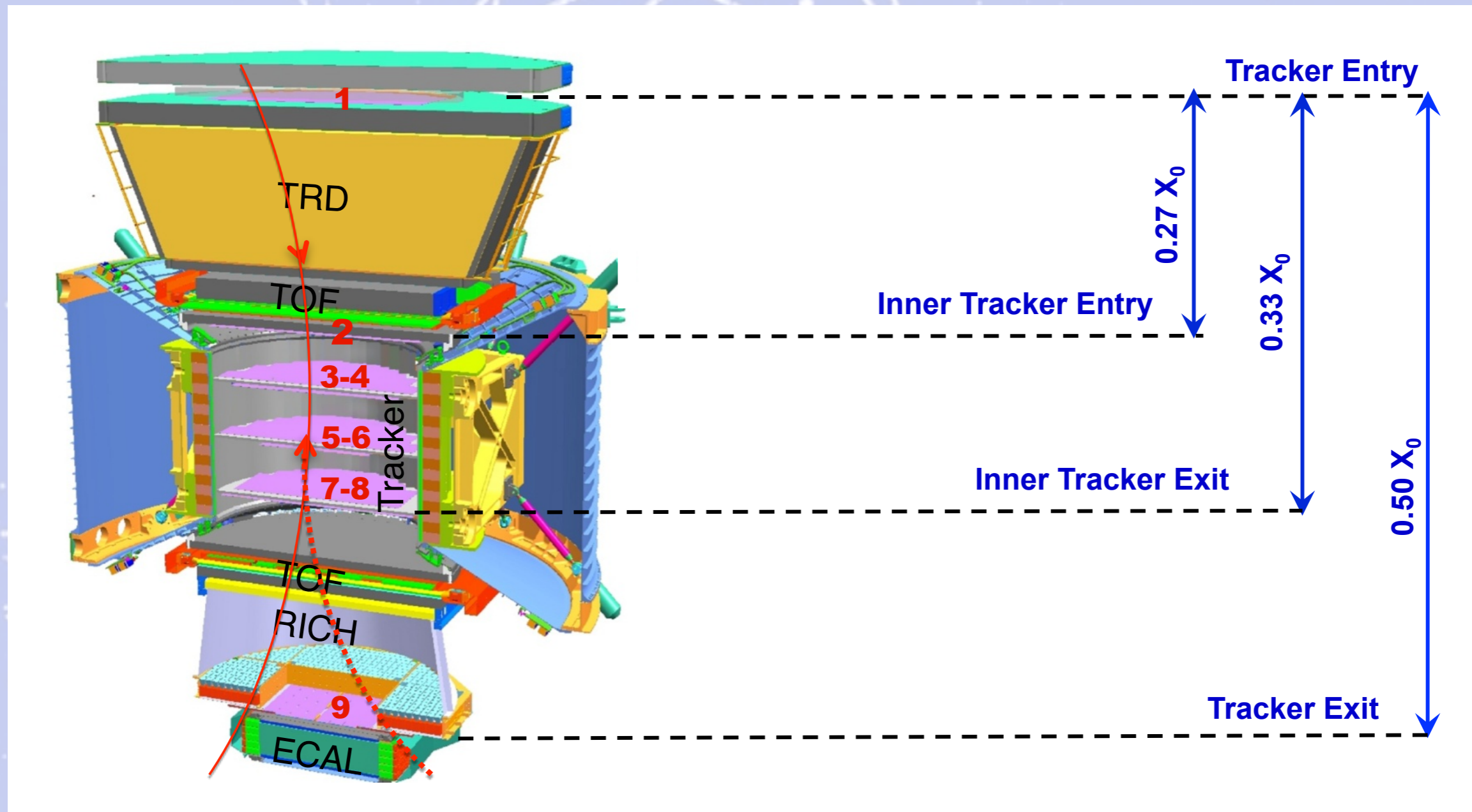

**a) Minimo materiale nel rivelatore:**

quindi il rivelatore **NON** diventa una sorgente di “large angle scattering”;

**b) Misure ripetute dell'impulso:**

per assicurare che le particelle con “large angle scattering” non siano confuse con il segnale.

# Sensitivita' della ricerca dell'origine della materia Oscura: $p/e^+ > 10^6$

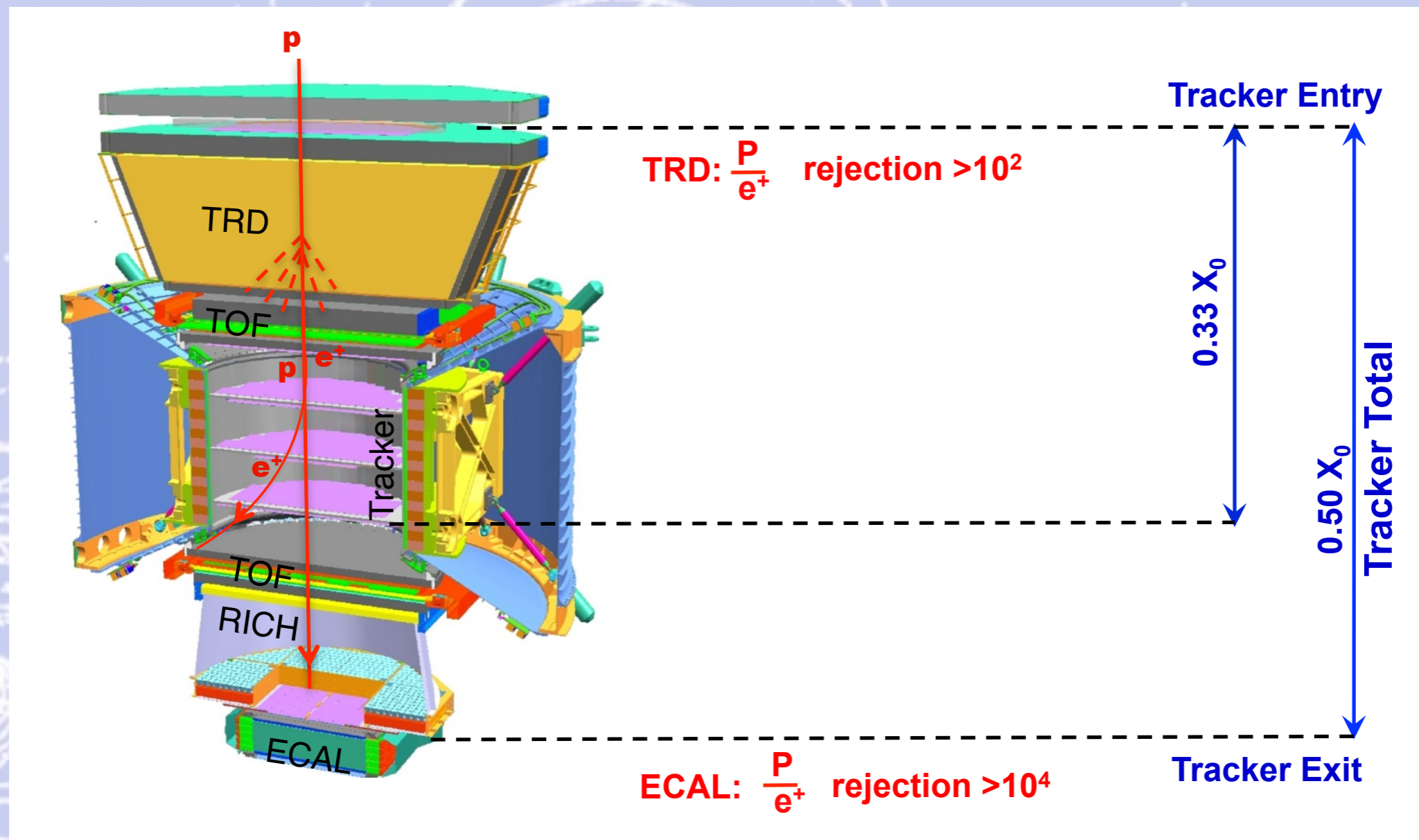

a) **Minimo materiale nel TRD e nel TOF:**

quindi il rivelatore **NON** diventa una sorgente di  $e^+$  ;

b) Il magnete separa il TRD e ECAL cosi' gli  $e^+$  prodotti nel TRD sono deviati e non entrano nell'ECAL:

in tal modo il "rejection power" del TRD e dell' ECAL sono indipendenti;

c) "Matching" dell'impulso dai 9 piani del Tracker con le misure di energia dell' ECAL.

# Multiple Measurements of Charge

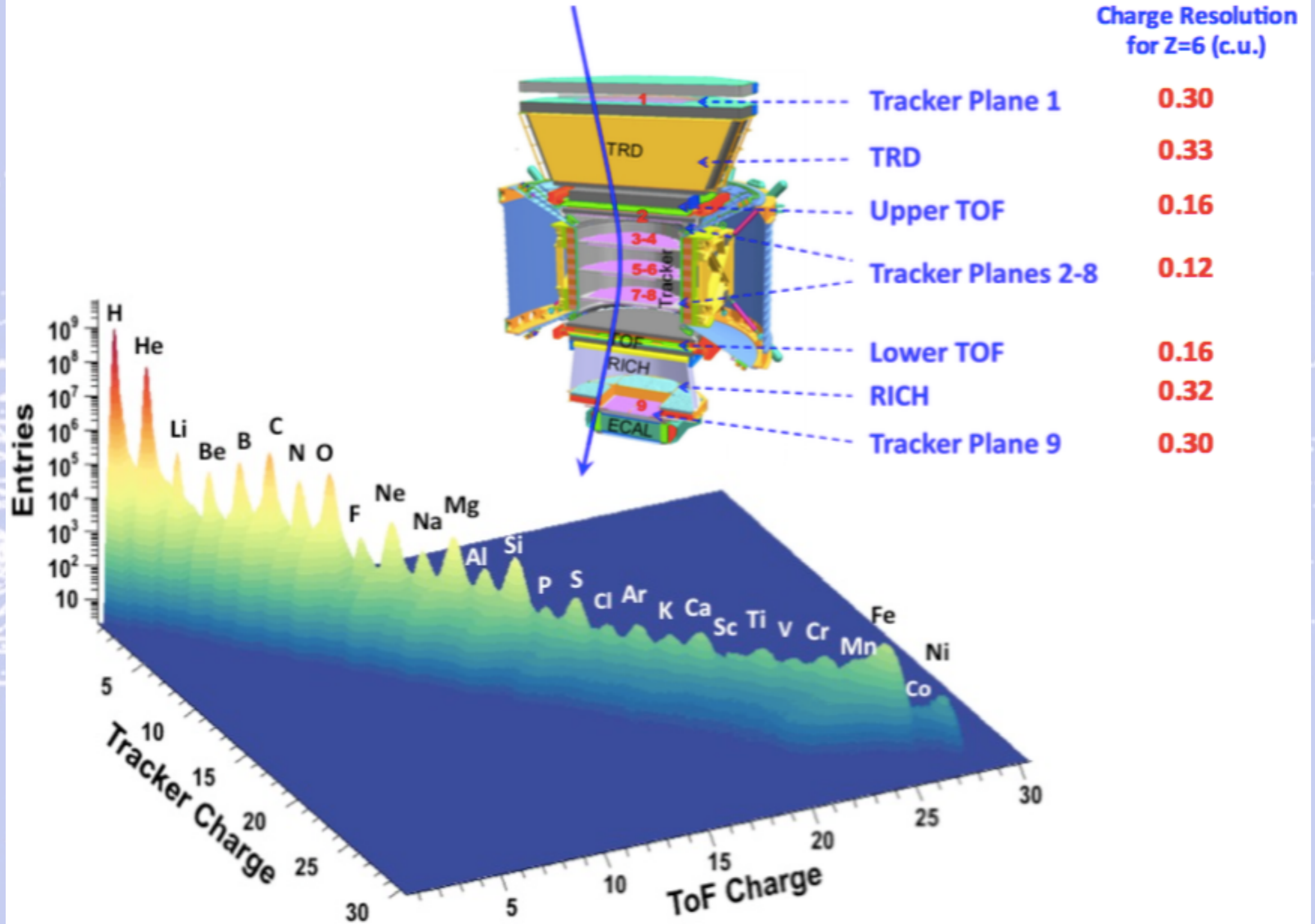

La precisa identificazione delle particelle si ha combinando le risposte dei diversi sotto rivelatori (ridondanza ...utile anche per eventi rari)

→TeV	$e^-$	P	He, Li, Be, ... Fe	$\gamma$	$e^+$	$\bar{P}, \bar{D}$	$\bar{He}, \bar{C}$
TRD							
TOF							
Tracker							
RICH							
ECAL							
Physics example	Cosmic Ray Physics Strangelets				Dark matter		Antimatter

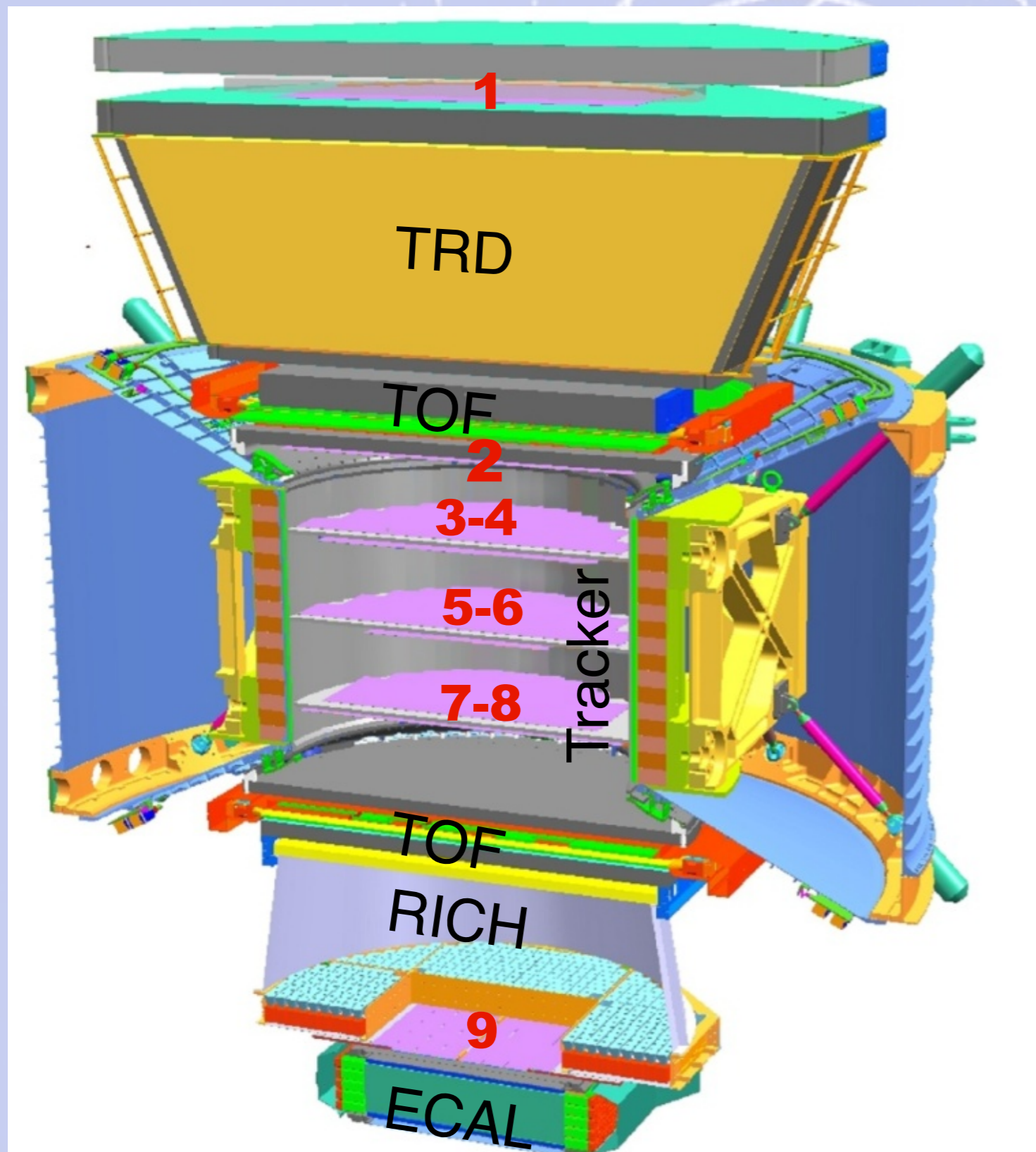

**Ulteriori dettagli sui rivelatori di AMS-02**

**saranno/sono stati**

**forniti durante la visita**

**(vedi appendice)**

# Performance del rivelatore AMS-02 sulla ISS

**L'esperimento AMS-02 sta operando senza particolari problemi. In oltre 75 mesi di attività ha raccolto più di 100 miliardi di particelle.**

**Ogni anno si raccolgono circa  $16 \times 10^9$  eventi che in 10-20 anni saranno  $160-320 \times 10^9$ .**

**Questa capacità AMS-02 fornisce una sensibilità senza precedenti per la ricerca di nuova fisica.**

The background of the slide is a light blue color with a complex pattern of white lines and dots. These lines represent particle tracks, some straight and some spiraling, set against a grid of faint white dots, suggesting a detector or particle physics environment.

**Risultati dell'esperimento AMS-02  
e "physics expectations"  
dal maggio 2011 a settembre 2016**

**(Vedi appendice 13)**

The background of the slide is a light blue color with a complex pattern of white lines and dots. These lines represent particle tracks, some of which are straight and others are curved or spiraling. The dots represent detector components or interaction points. The overall appearance is that of a particle detector's internal structure or a visualization of particle paths.

**Risultati dell'esperimento AMS-02  
e “physics expectations”  
aggiornati a Settembre 2017**



# Produzione di CR

**Acceleration of  $p$ ,  $e^-$ , nuclei in SNRs**

**Diffusion (scattering off magnetic turbulence)**

**Production of secondary particles**

**Energy losses + gains**

Secondary particles:  
**positrons**, electrons,  
protons, **antiprotons**, nuclei  
**photons**

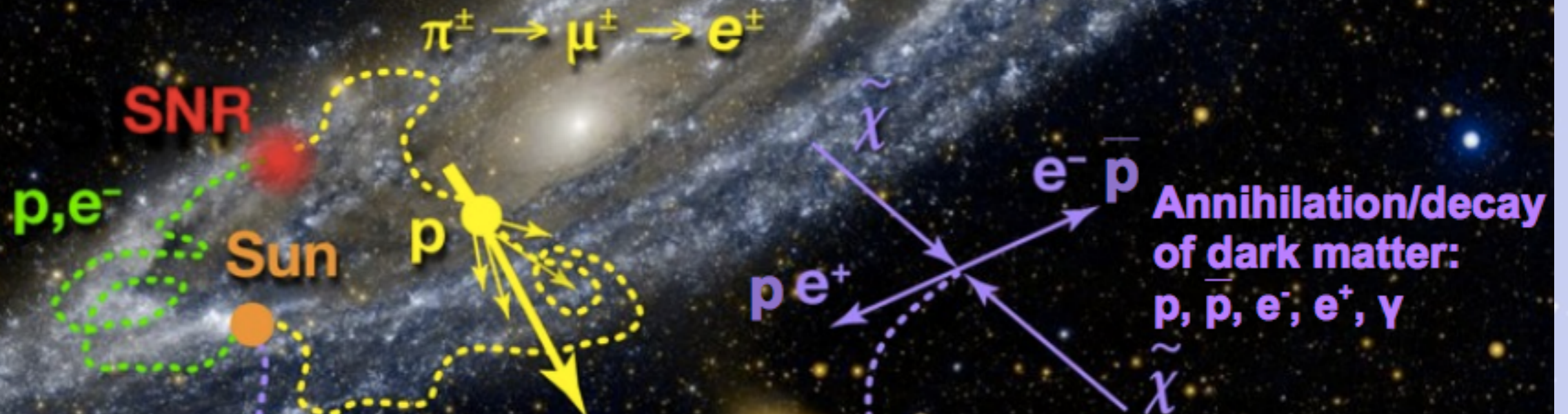

Such an excess of  $e^+$ ,  $\bar{p}$  from Dark Matter annihilation can be measured by magnetic spectrometers like AMS

# Flusso di $e^-$ ed $e^+$ prima di AMS

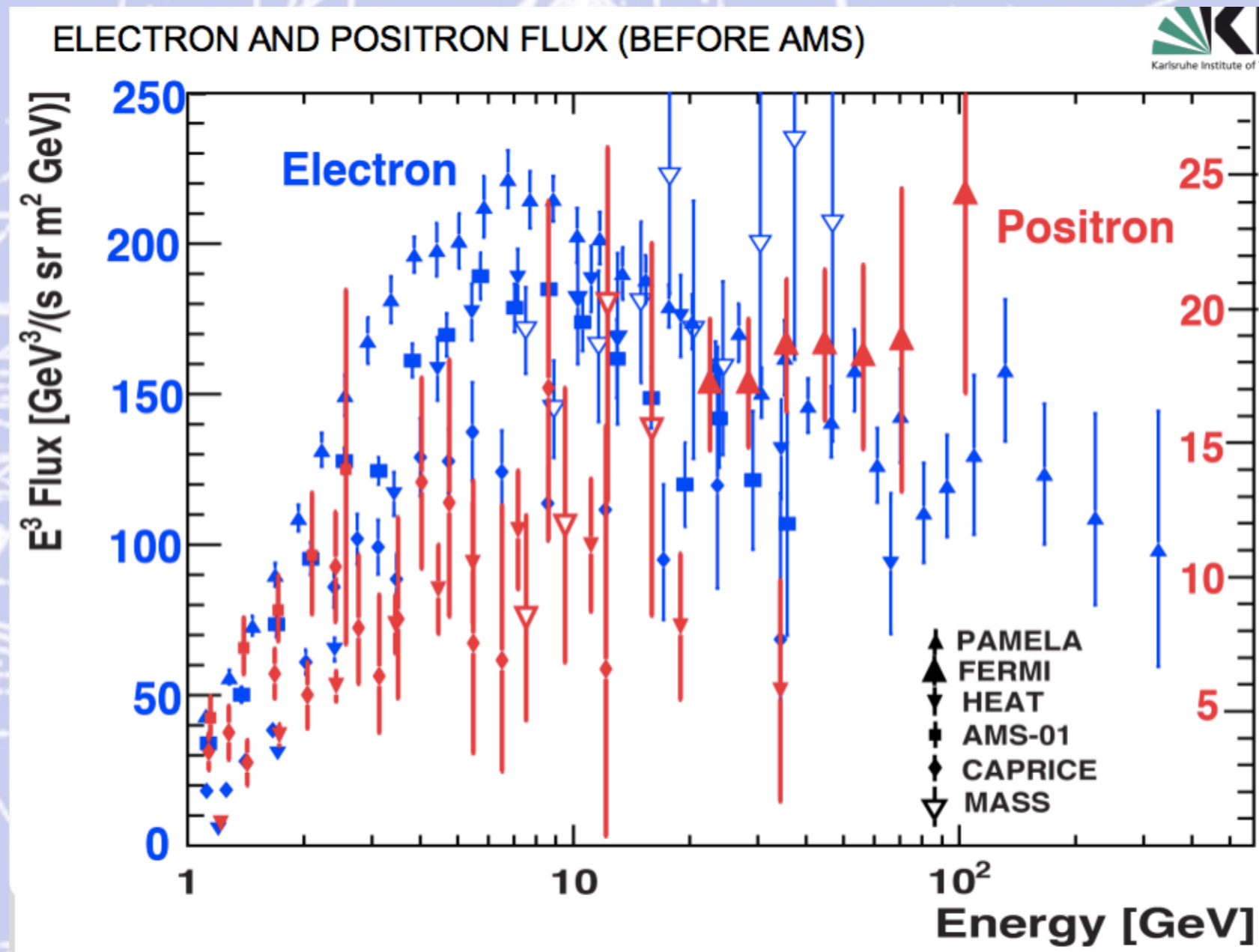

# Flusso di e- ed e+ con AMS

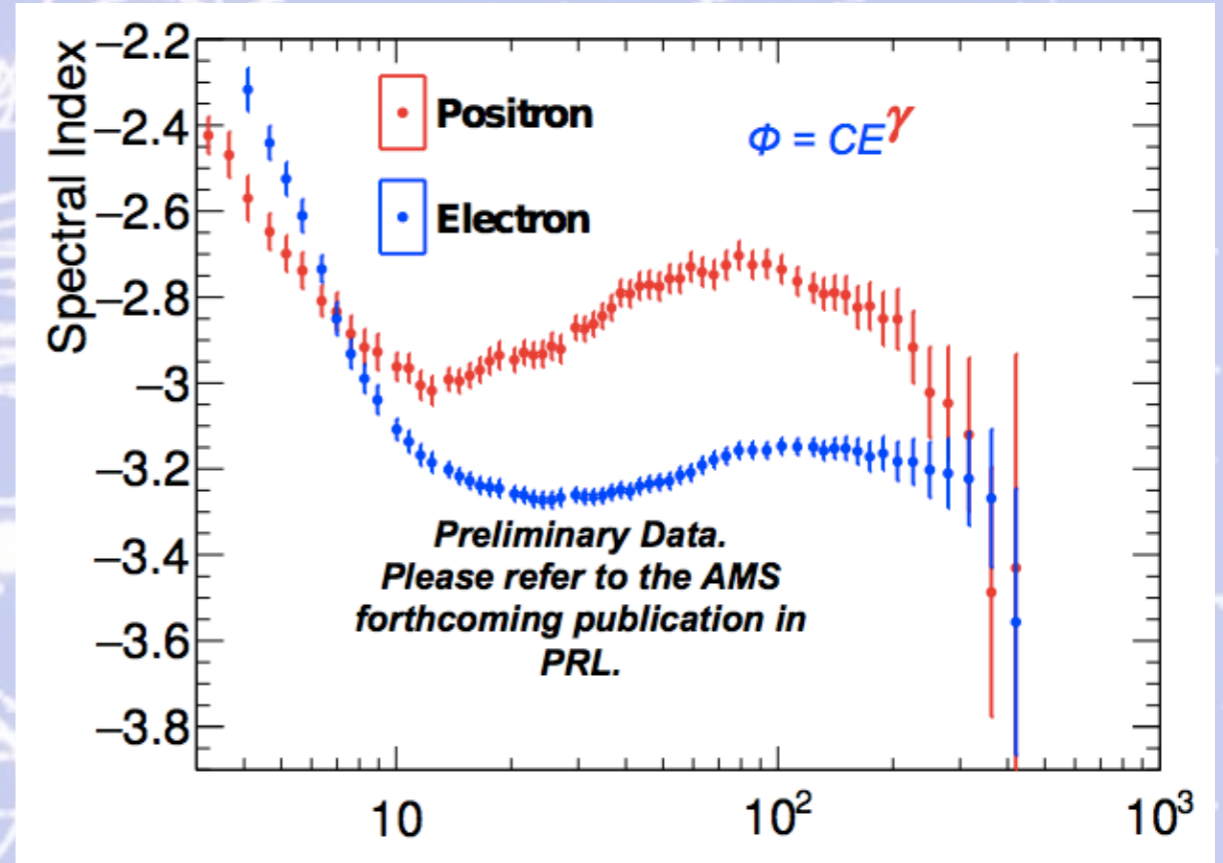
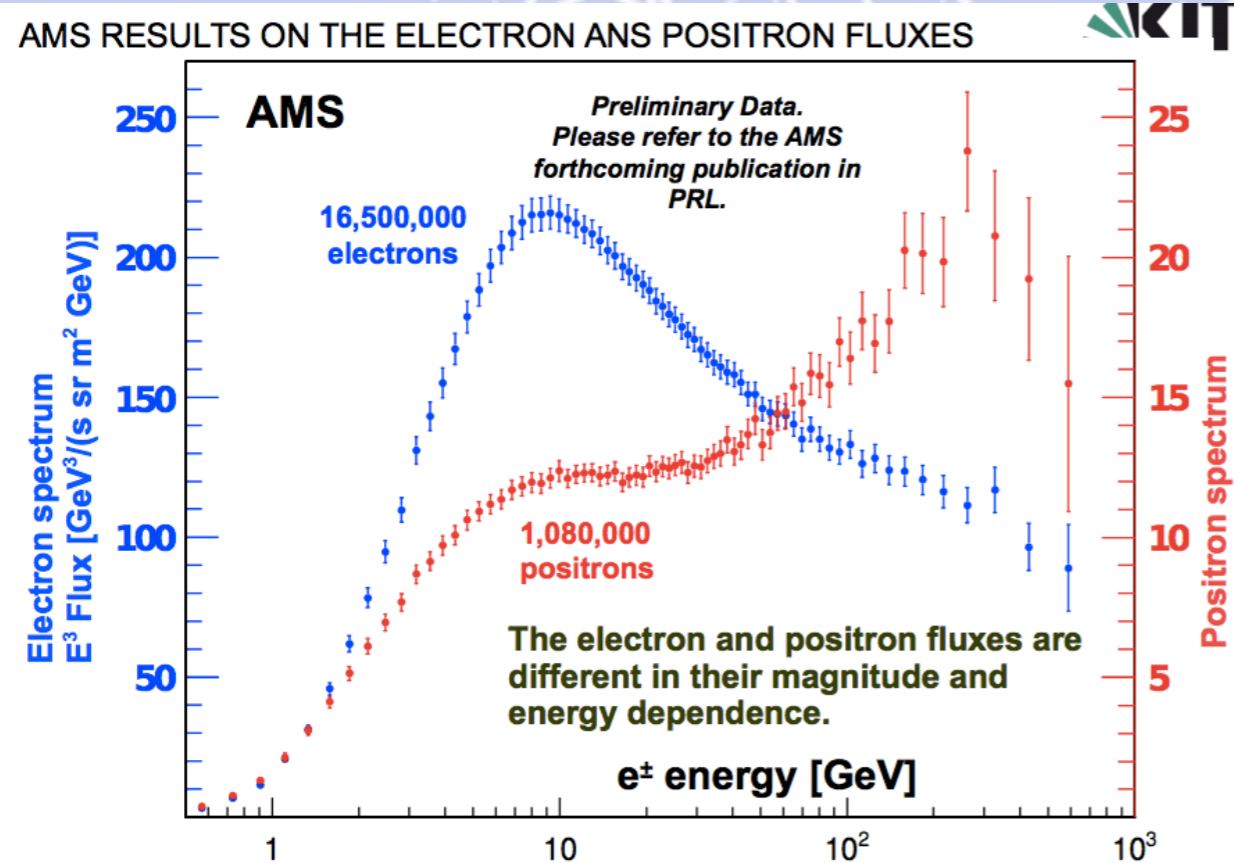

$$\Phi_{e^\pm}(E) = \frac{E^2}{\hat{E}^2} \left[ C_{e^\pm} \hat{E}^{\gamma_{e^\pm}} + C_S \hat{E}^{\gamma_S} \exp(-\hat{E}/E_S) \right]$$

with  $E_S = 530$  GeV from the  $e^+/(e^+ + e^-)$  fit  
and  $\hat{E} = E + \Psi$  as the energy scale of the LIS

The spectral index of the diffuse term has to become energy dependent:

$$\Phi_{e^-}(E) = \frac{E^2}{\hat{E}^2} \left[ C_e \hat{E}^{\gamma_e(\hat{E})} + C_S \hat{E}^{\gamma_S} \exp(-\hat{E}/E_S) \right]$$

The source term parameters are constrained from the positron flux fit.

# Ricerca di Materia oscura

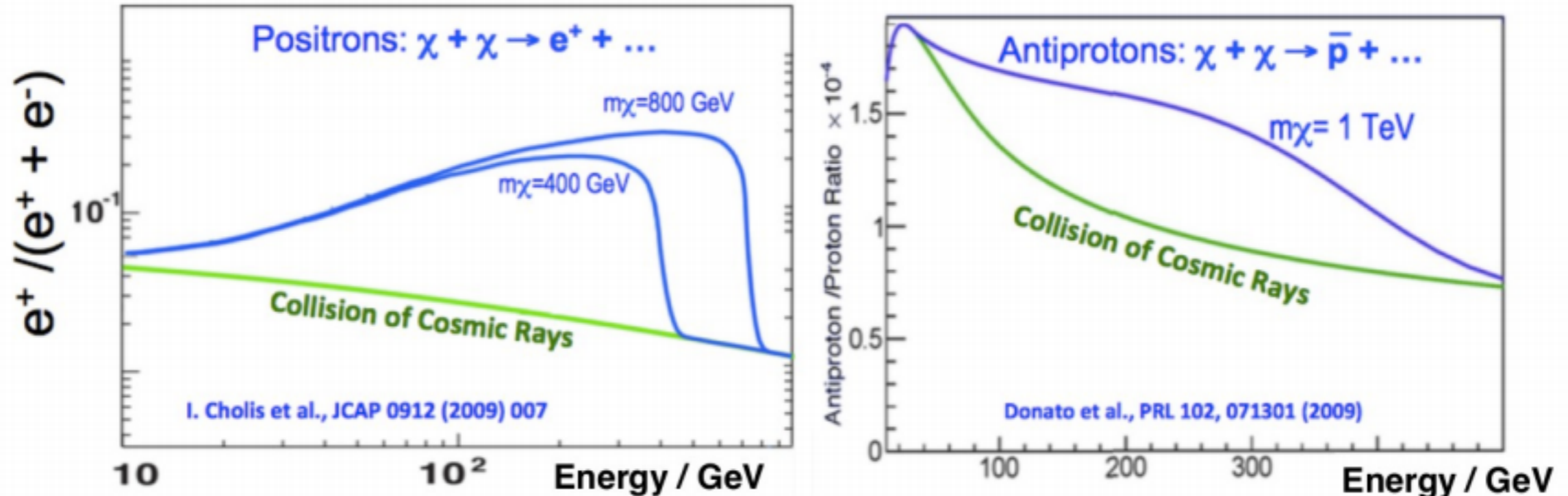

$e^+/\bar{p}$  are sensitive probes for dark matter....

...BUT: “collision of cosmic rays” needs to be understood.

# The AMS results are in excellent agreement with a Dark Matter Model

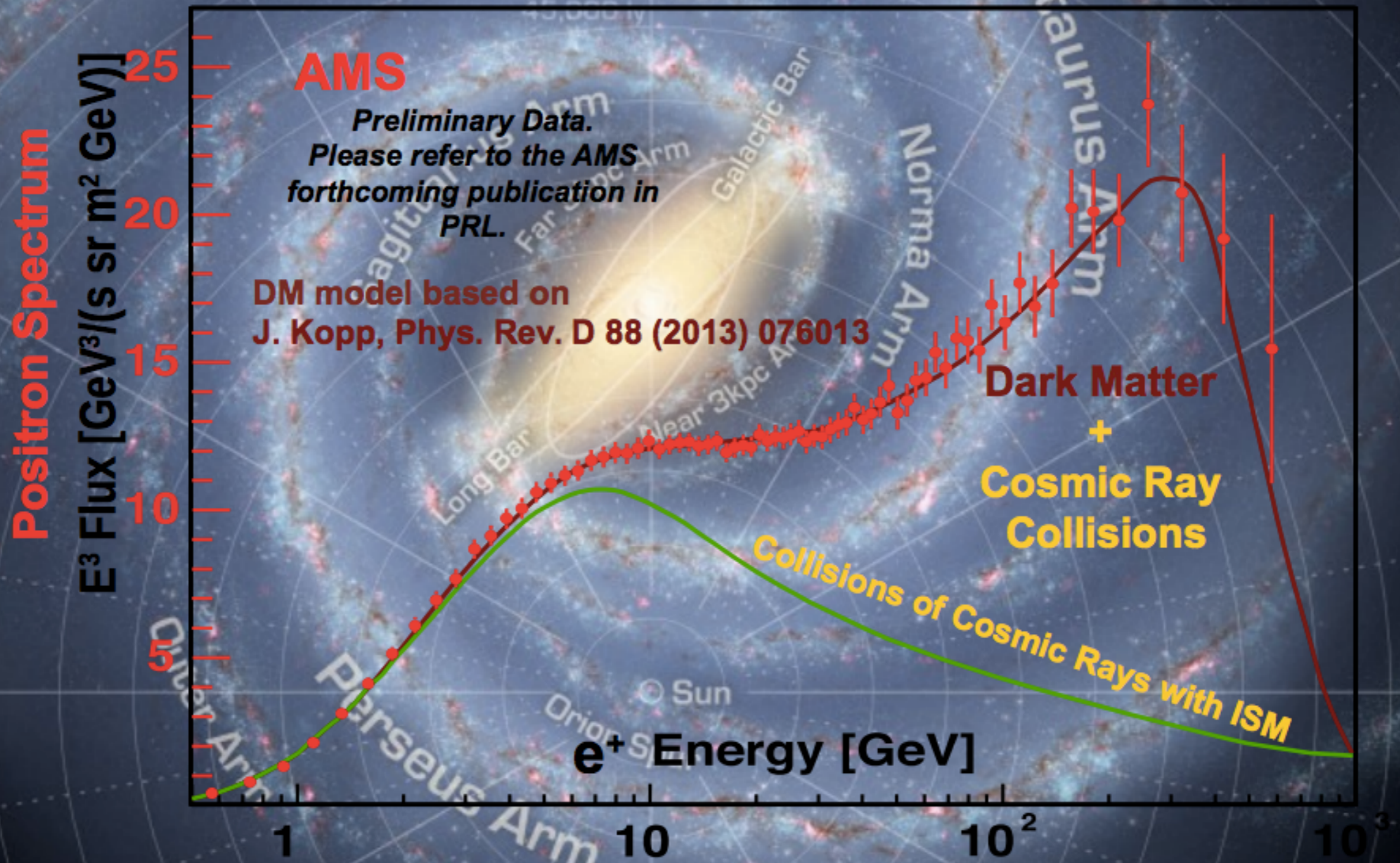

# Flusso antiprotone/protone

If  $\bar{p}$  are secondaries, their rigidity dependence should be different from p:

$$p + \text{ISM} = \bar{p} + \dots$$

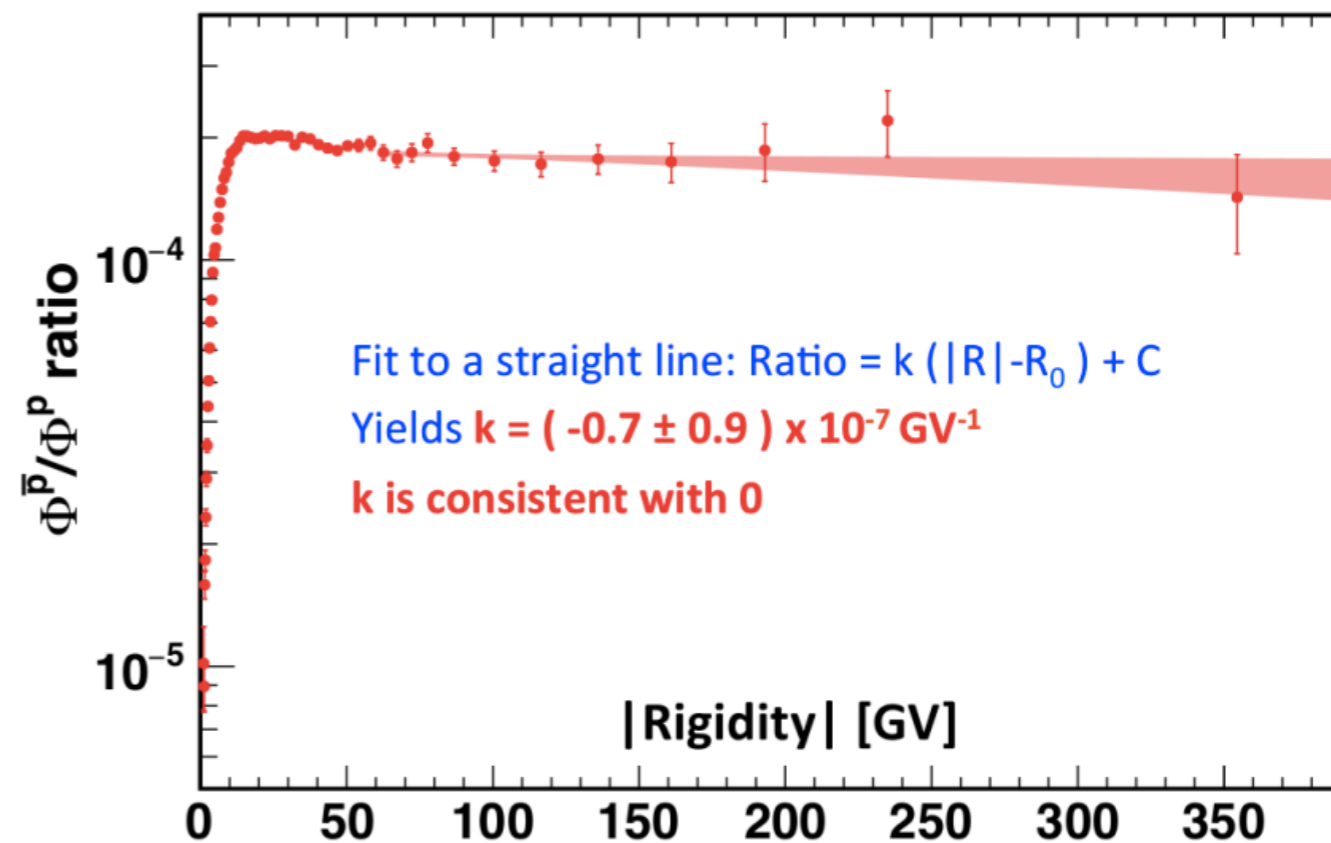
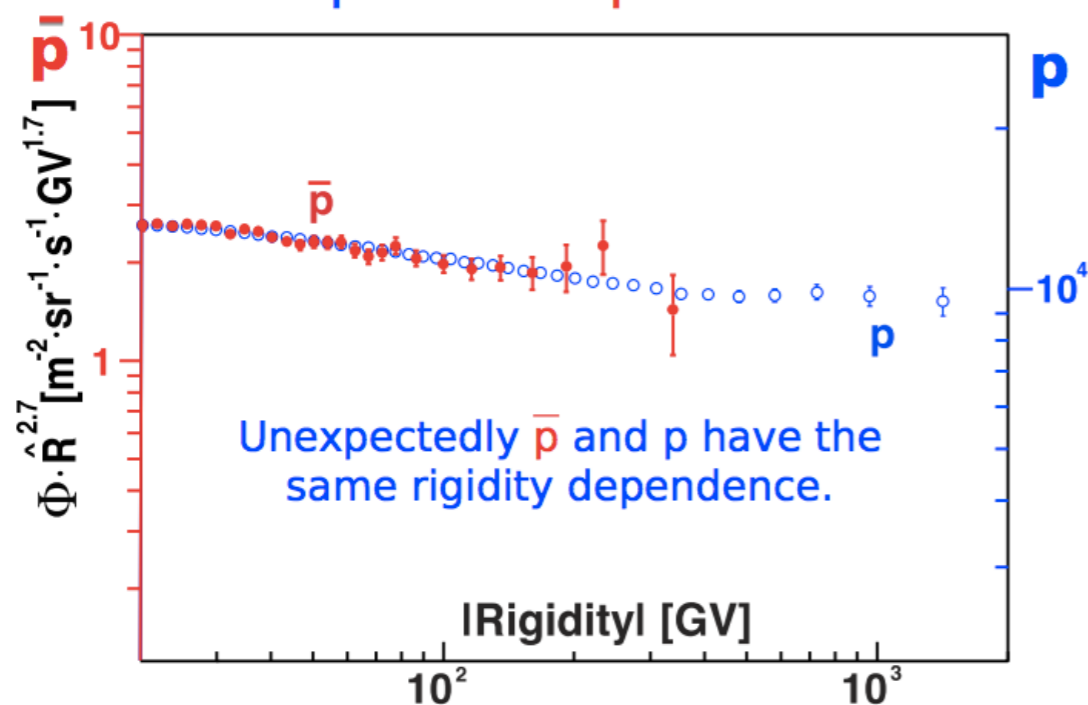

# Flusso protone/elio

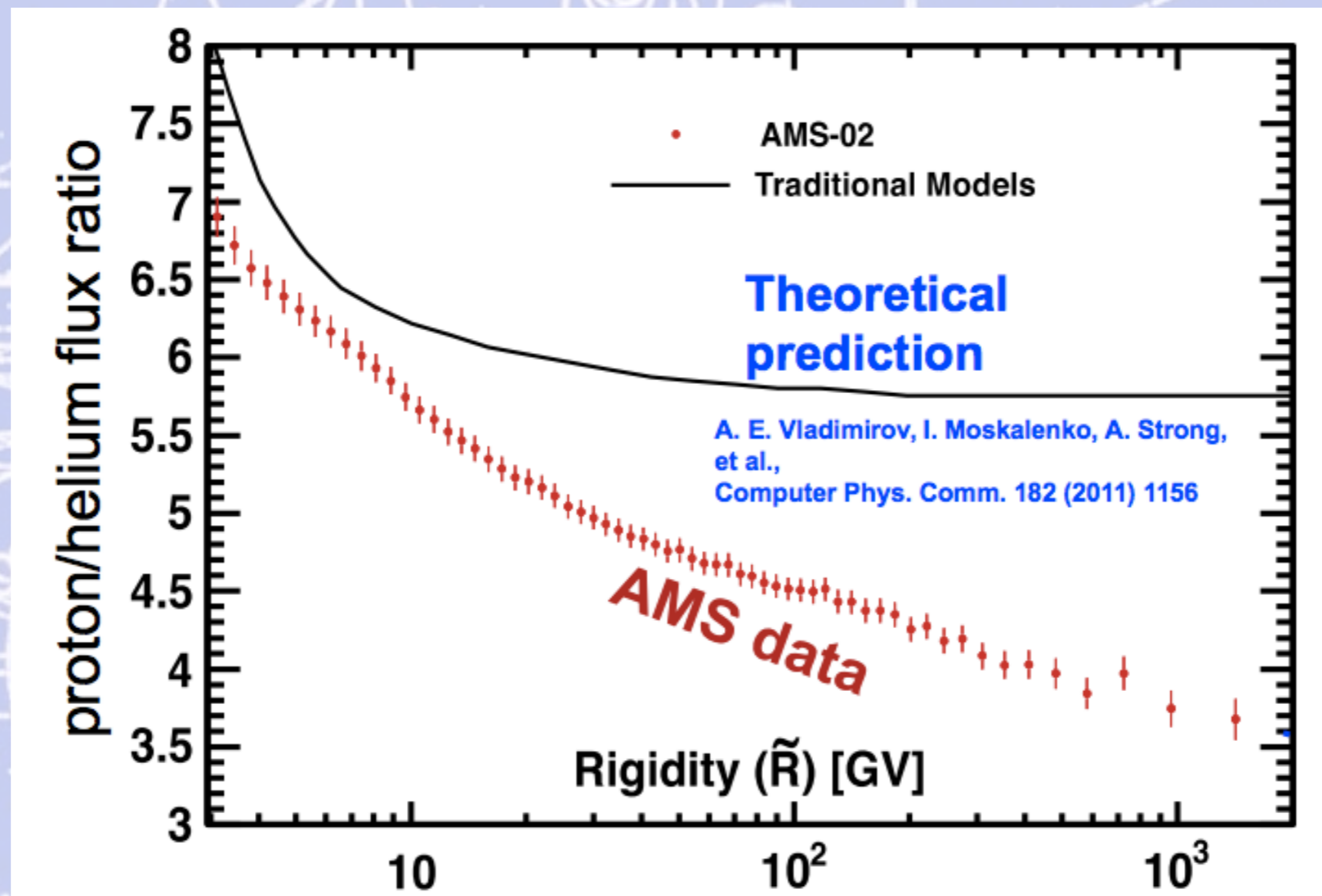

# Quindi in generale.....

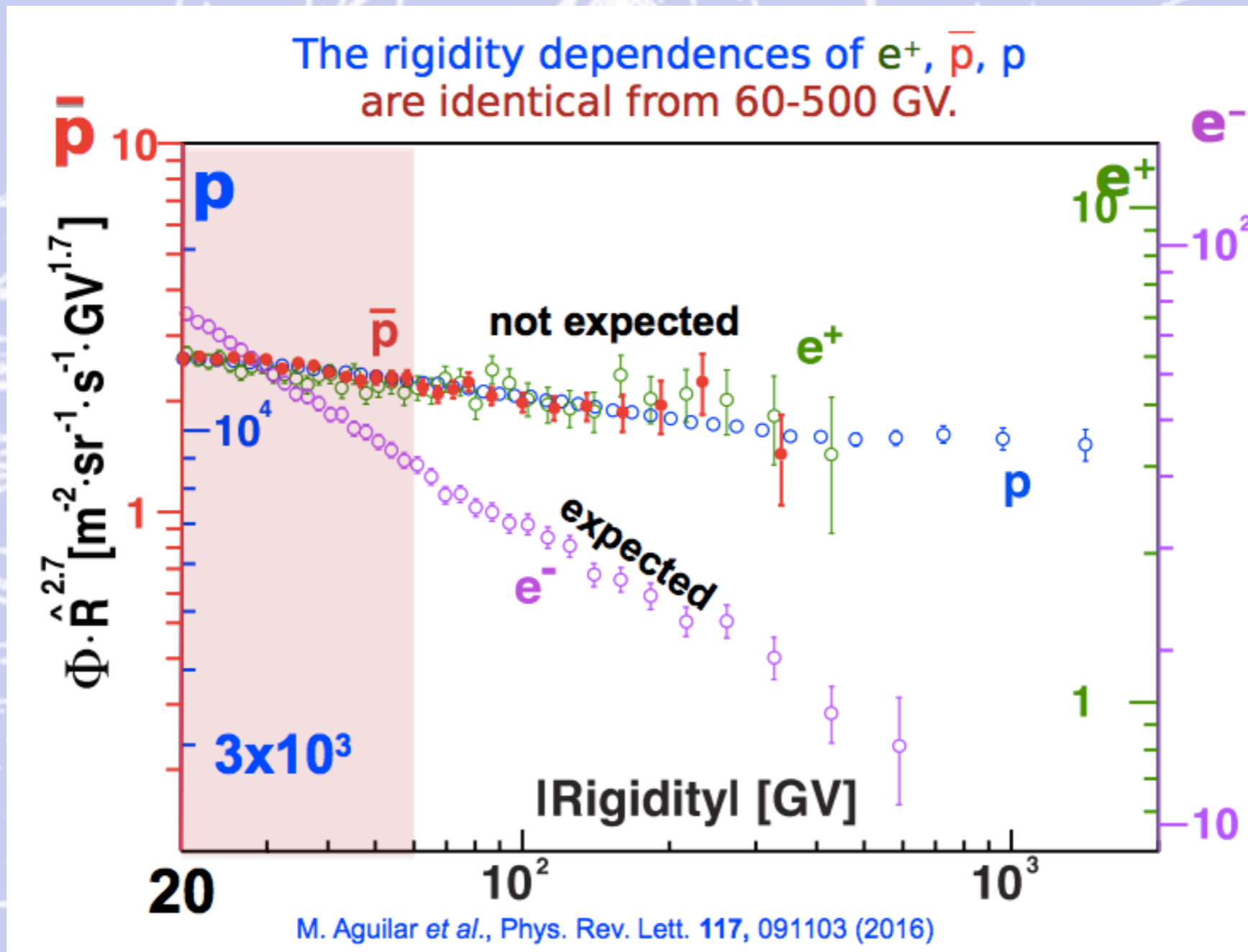



# Inoltre il flusso di H, He, Li, O, C, N ....

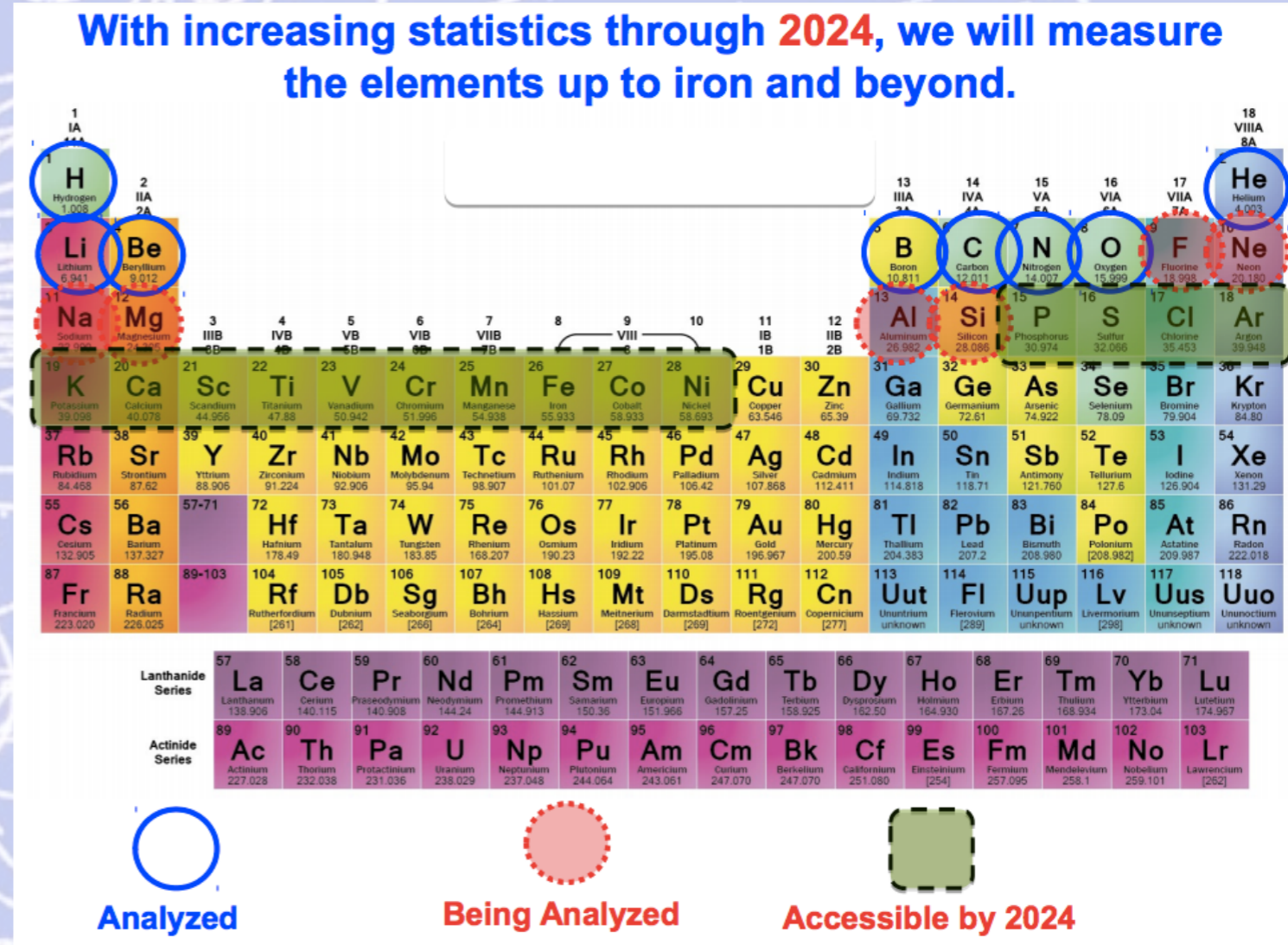
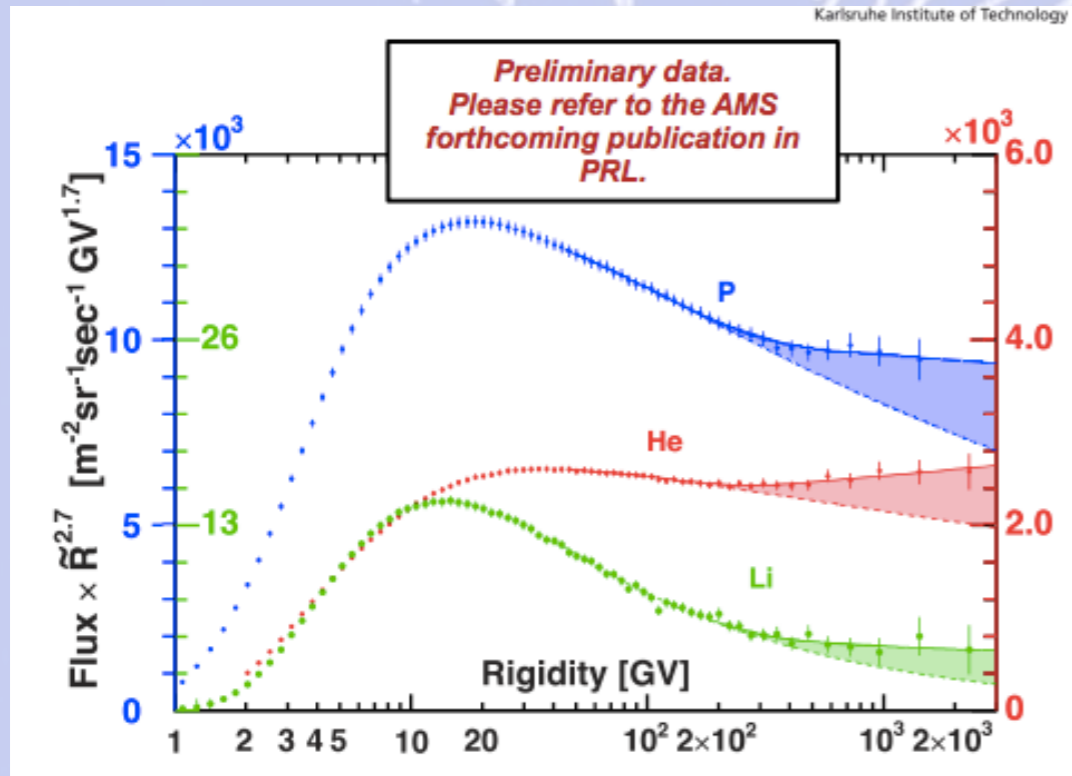

The spectra of oxygen, carbon and nitrogen do not follow the traditional single power law.

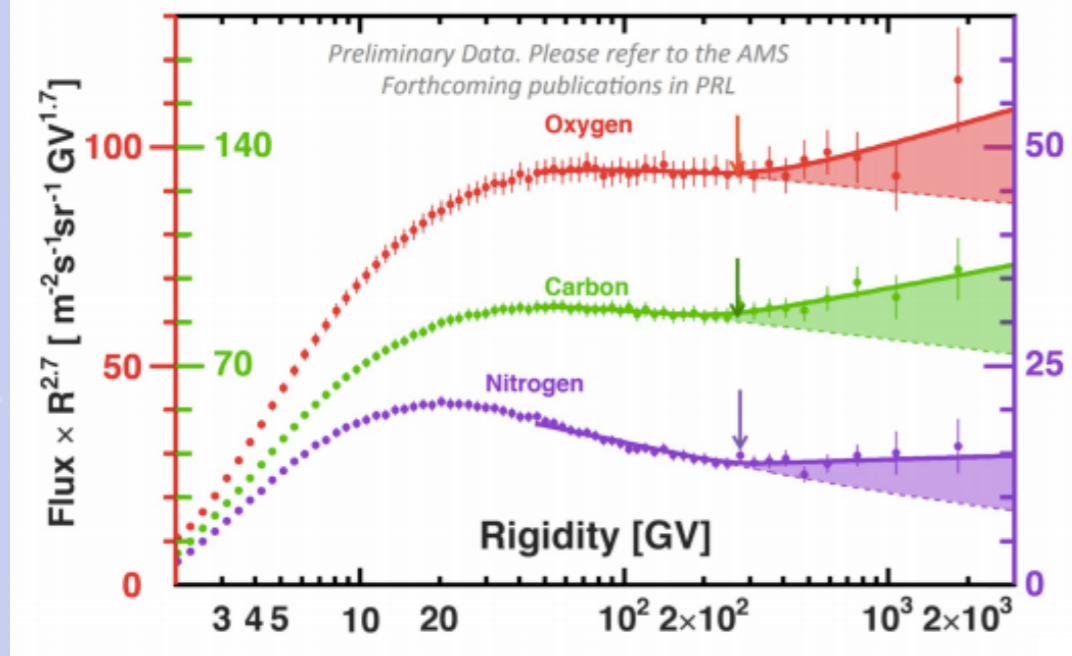

# Ciclo solare: inversione del campo magnetico solare +...

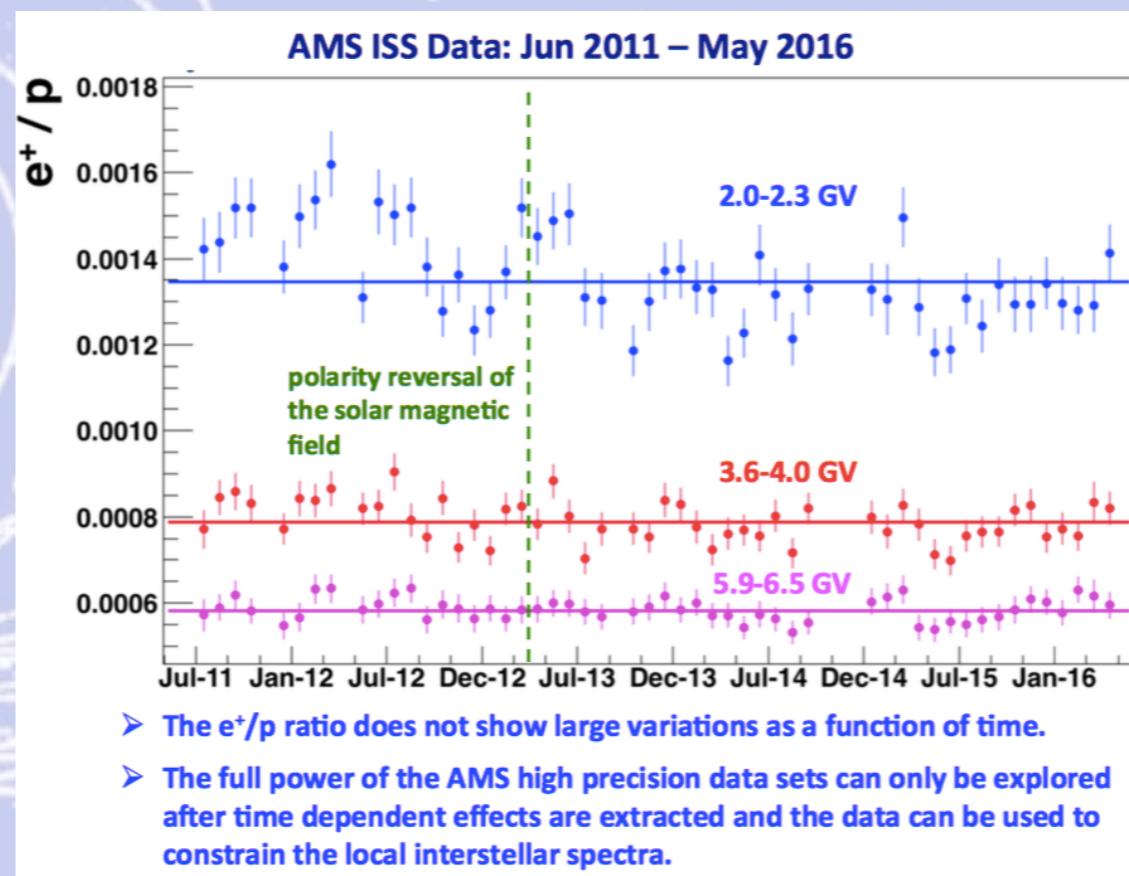
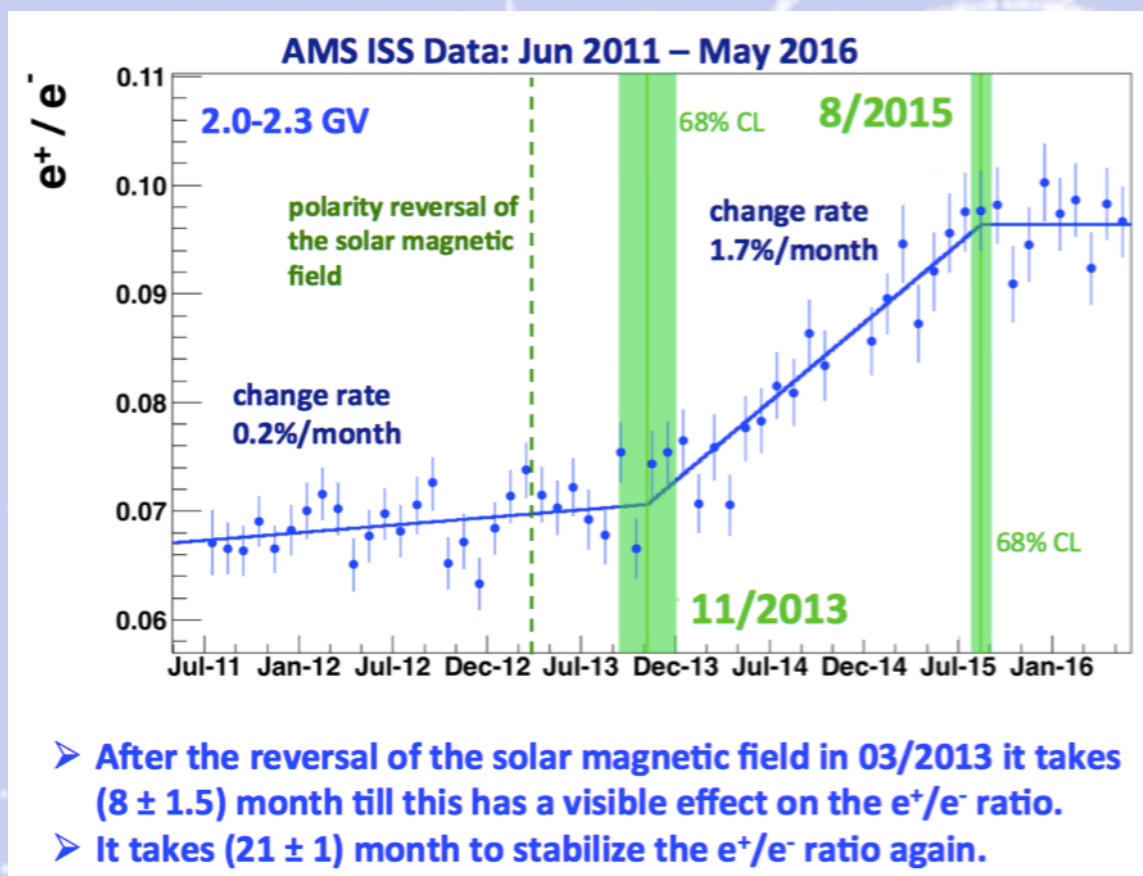

## AMS Solar Modulation for a full cycle: Cycle 24 - Cycle 25

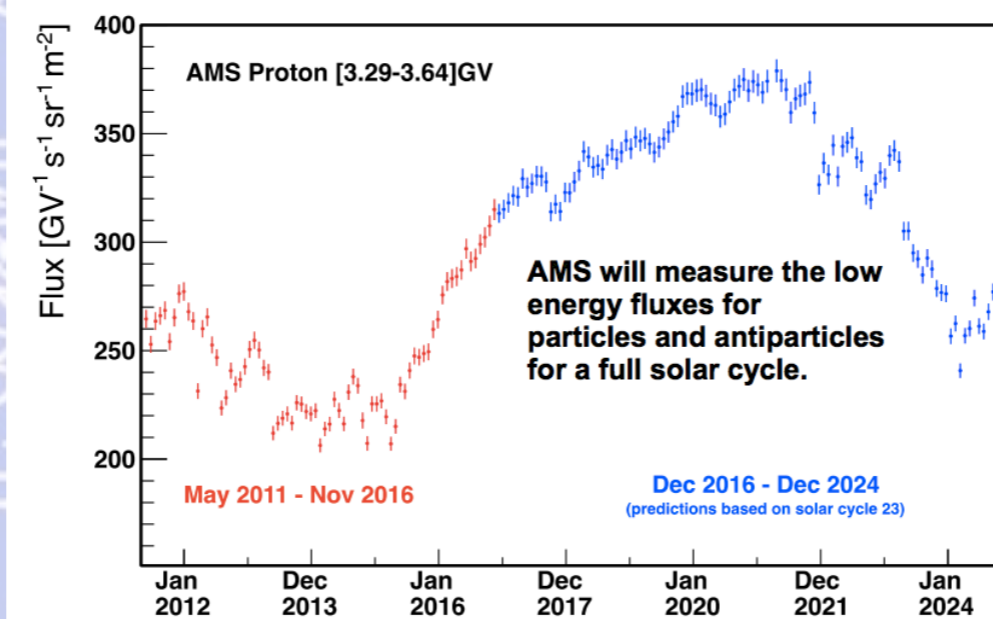

**AMS ed il monitoraggio continuo intorno alla Terra**

# **L'Universo e' il vero laboratorio !**

**I raggi cosmici sono accelerati ad energie enormemente maggiori di quelle raggiungibili da un qualsiasi dispositivo umano.**

**L'obiettivo principale di AMS e' di investigare l'ignoto, ricercare fenomeni naturali che non abbiamo ancora immaginato o per i quali non abbiamo ancora sviluppato i mezzi per riprodurli e capirli.**

Questa, perciò, non è la fine della storia!  
Siamo solo all'inizio dei  
*“Tempi Moderni”*

*Grazie!*

Ringraziamenti;  
I. Gebauer, A. Kounine,  
II. V. Kudryavtsev,  
D. Rapin, P. Salati,  
S. Schael, G. Servant

# Link utili:

## Generalita':

<http://math.ucr.edu/home/baez/physics/>  
<http://home.web.cern.ch/topics>  
<https://cds.cern.ch/collection/Videos> (*cercare poi l'argomento specifico in "search"*)  
<http://www.windows2universe.org/>  
<http://www.cernland.net/>

## Astroparticelle:

<http://www.astroparticelle.it/>  
<http://www.aspera-eu.org/>

## Raggi Cosmici:

<http://scienzagiovane.unibo.it/100RC.html>  
<http://scienzagiovane.unibo.it/100RC/2/AlbumFoto-IIF.html>  
<http://scienzagiovane.unibo.it/100RC/3/AlbumFoto-IIIF.html>  
<http://www.palazzosomeda.it/Osservatorio/Raggicosmicieattivitsolare.htm>

## Materia Oscura:

[http://www.ge.infn.it/~pesce/research/dm\\_tesina.pdf](http://www.ge.infn.it/~pesce/research/dm_tesina.pdf)  
<http://ned.ipac.caltech.edu/level5/Bosma2/frames.html>

## Antimateria:

[http://www.nationalgeographic.it/scienza/spazio/2012/02/16/news/nell\\_antimateria\\_il\\_segreto\\_dell\\_energia\\_oscura\\_-855266/](http://www.nationalgeographic.it/scienza/spazio/2012/02/16/news/nell_antimateria_il_segreto_dell_energia_oscura_-855266/)  
[http://planet.racine.ra.it/testi/mat\\_osc.htm](http://planet.racine.ra.it/testi/mat_osc.htm)  
[http://scienzapertutti.lnf.infn.it/index.php?option=com\\_content&view=article&id=7:materia-e-antimateria&catid=5&Itemid=79](http://scienzapertutti.lnf.infn.it/index.php?option=com_content&view=article&id=7:materia-e-antimateria&catid=5&Itemid=79)  
<http://home.web.cern.ch/topics/antimatter/matter-antimatter-asymmetry-problem>

## AMS e NASA:

<http://www.ams02.org/> (*in "Multimedia" ci sono filmati interessanti*)  
<http://ams.nasa.gov/>  
<http://www.ustream.tv/NASAHDV> (*in "Videos" sono disponibili diversi filmati*)

## Lavori didattici:

[http://try.iprase.tn.it/old/in05net/upload/doc/libri/U1011t3n729\\_Raggi\\_cosmici.pdf](http://try.iprase.tn.it/old/in05net/upload/doc/libri/U1011t3n729_Raggi_cosmici.pdf)  
[http://www.liceogioberti.it/didattica/prog\\_EEE\\_articoloCeresole.pdf](http://www.liceogioberti.it/didattica/prog_EEE_articoloCeresole.pdf)  
[http://eee.centrofermi.it/component/k2/item/download/1\\_80cbadb159b503626a30e04b169f2372](http://eee.centrofermi.it/component/k2/item/download/1_80cbadb159b503626a30e04b169f2372)  
[http://appunti.studentville.it/appunti/tesine-6/tesina\\_antimateria\\_realta\\_o\\_fantasia-3391.htm](http://appunti.studentville.it/appunti/tesine-6/tesina_antimateria_realta_o_fantasia-3391.htm) (*scaricare il file*)

The background of the slide is a light blue color with a complex pattern of white lines. These lines represent particle tracks, featuring a mix of straight paths, spirals, and circular loops, typical of tracks from a particle detector. The tracks are scattered across the entire page, creating a sense of dynamic movement and scientific exploration.

# Appendice 1

(I rivelatori di AMS-02)

# Transition Radiation Detector (TRD)

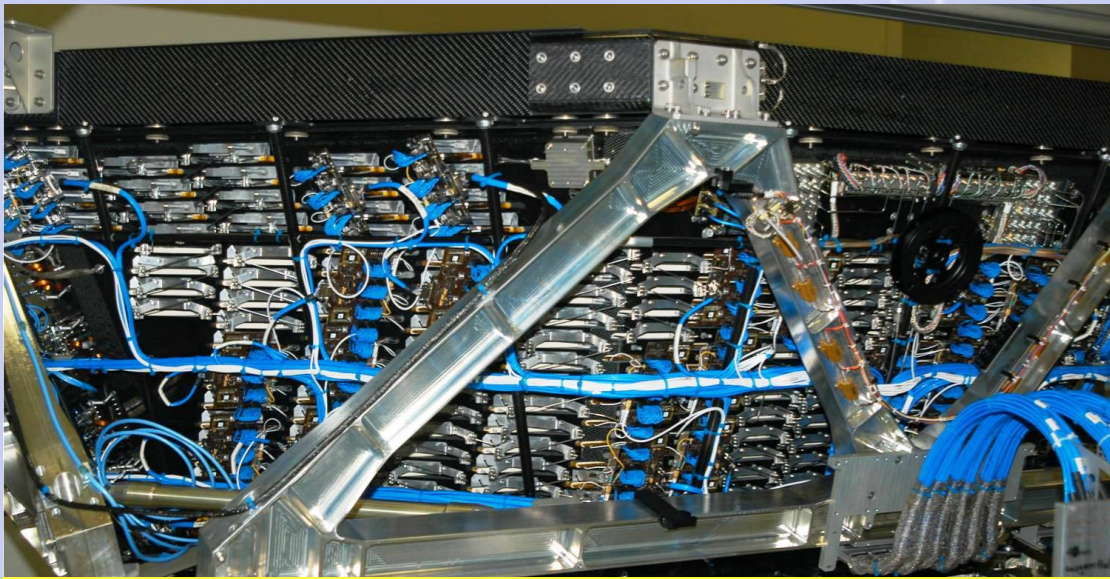

20 layers assembled in octagonal structure;  
328 modules of fleece and straw tubes;  
Gas mixture: 80% Xe – 20% CO<sub>2</sub>;

Leakrate of 5 μg/s, caused by CO<sub>2</sub> diffusion,  
corresponds to a lifetime ~20 years in Space

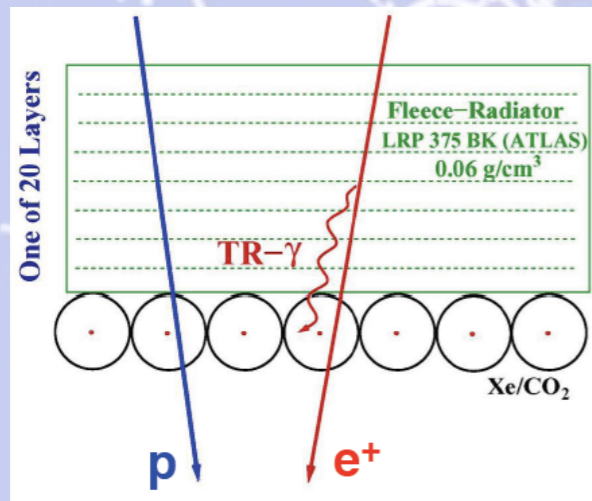
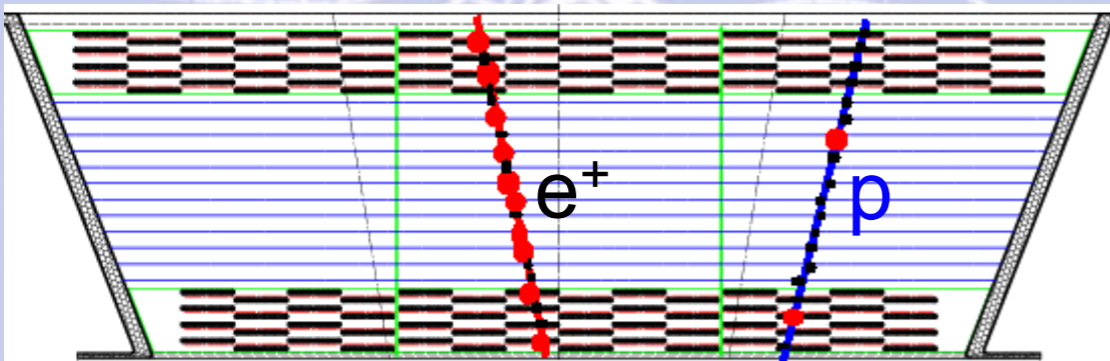

identifies  $e^\pm$  by transition radiation  
and Nuclei by  $dE/dX$

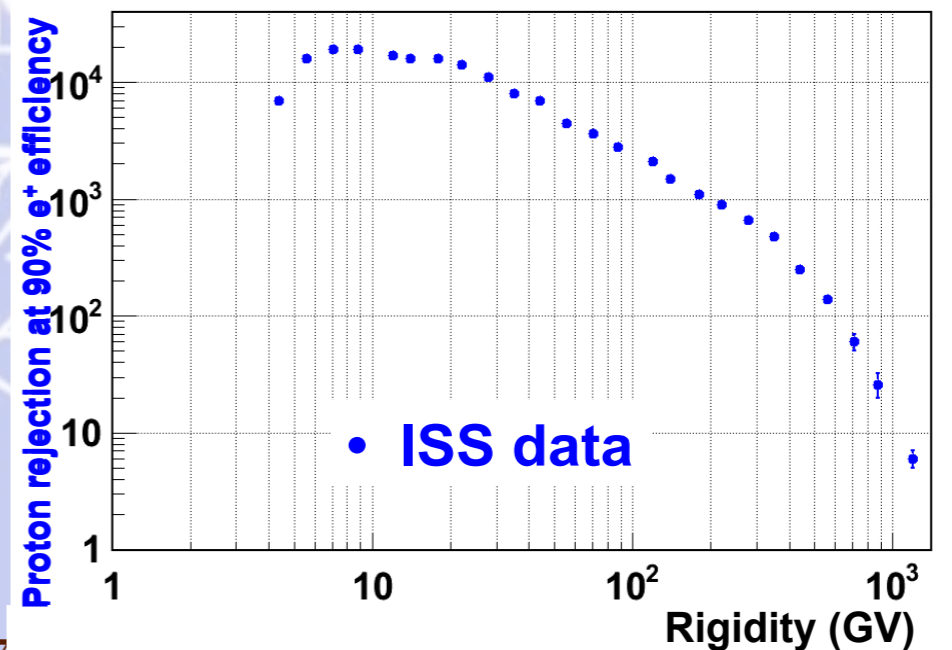
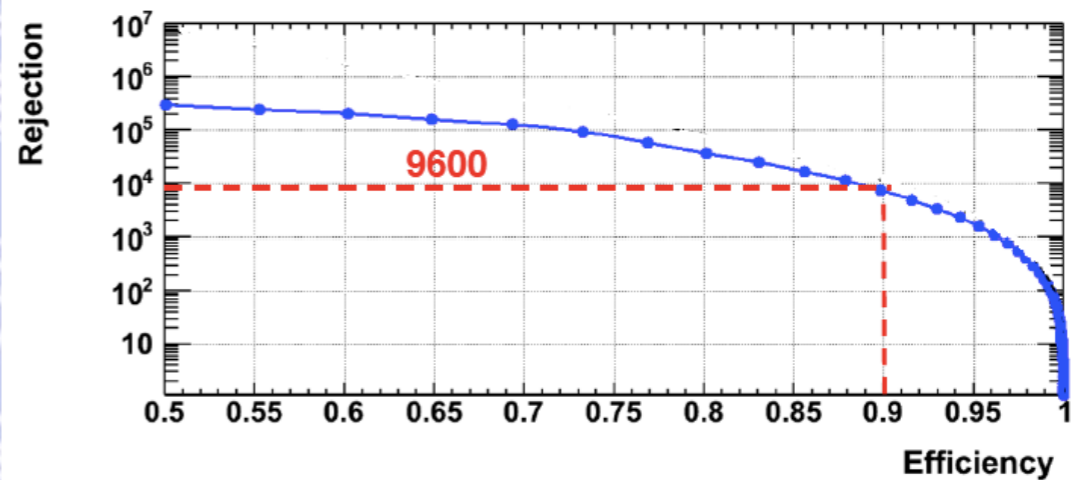
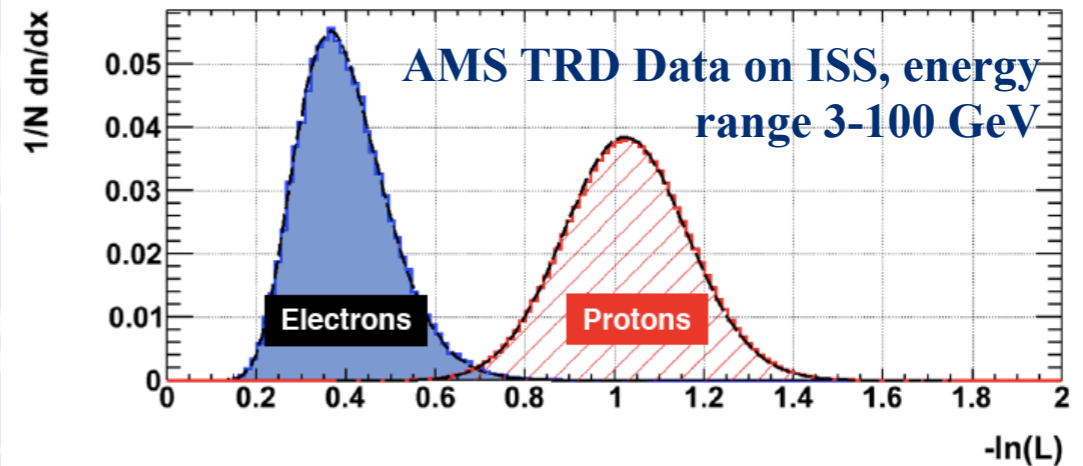

# Time of Flight (TOF)

Measures Velocity and Charge of particles

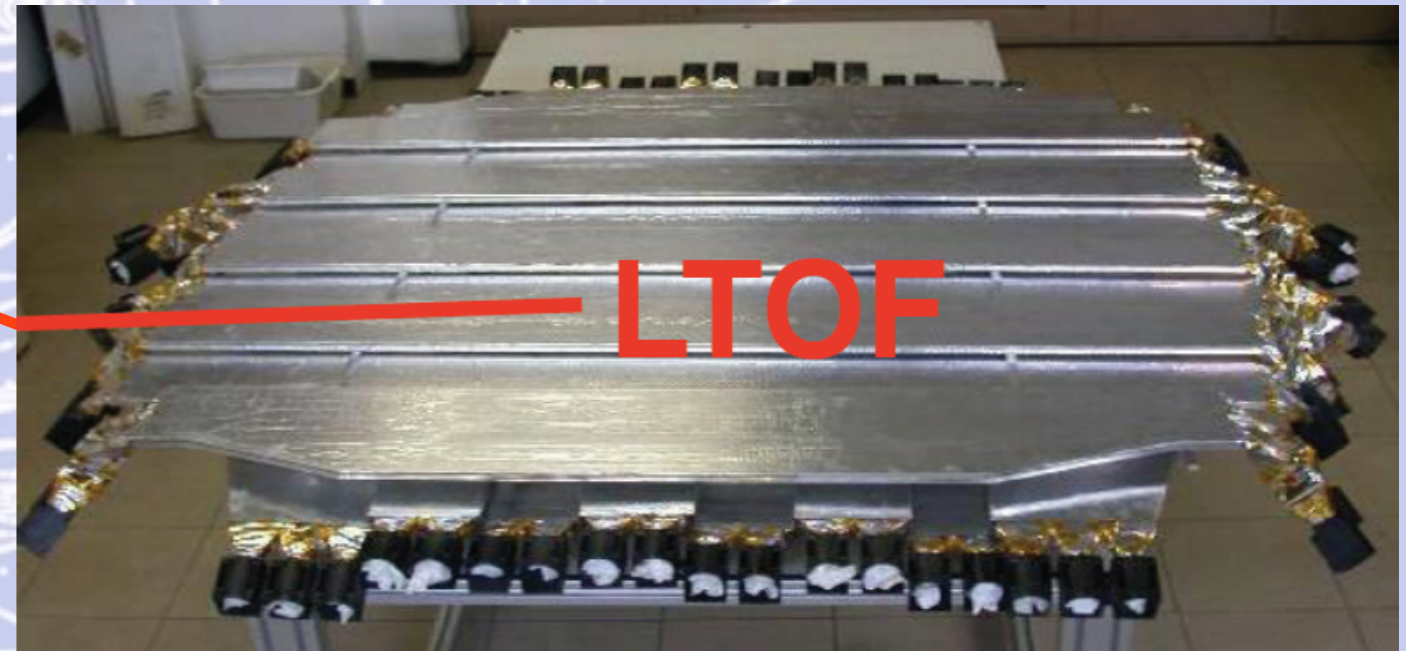
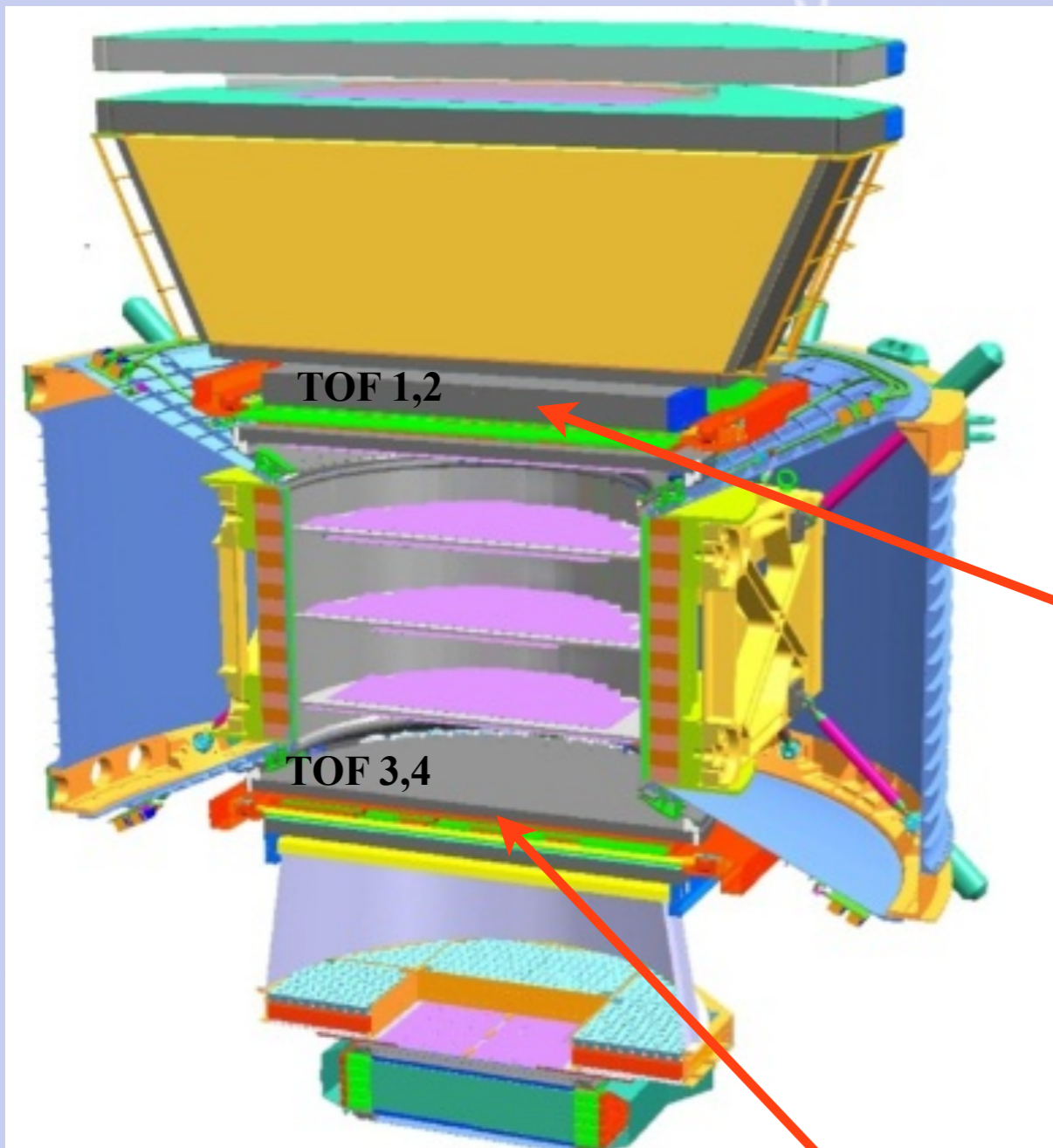

LTOF

2x2 planes + total of 34 scintillator paddles  
(seen by 2 (or 3) PMTs on each side);



UTOF

Measures the time of relativistic protons to 160 picoseconds  
Provides trigger for charged particles  
Trigger time is synchronized to UTC time to  $1\mu\text{s}$



# Time of Flight (TOF):

Measures Velocity and Charge of particles

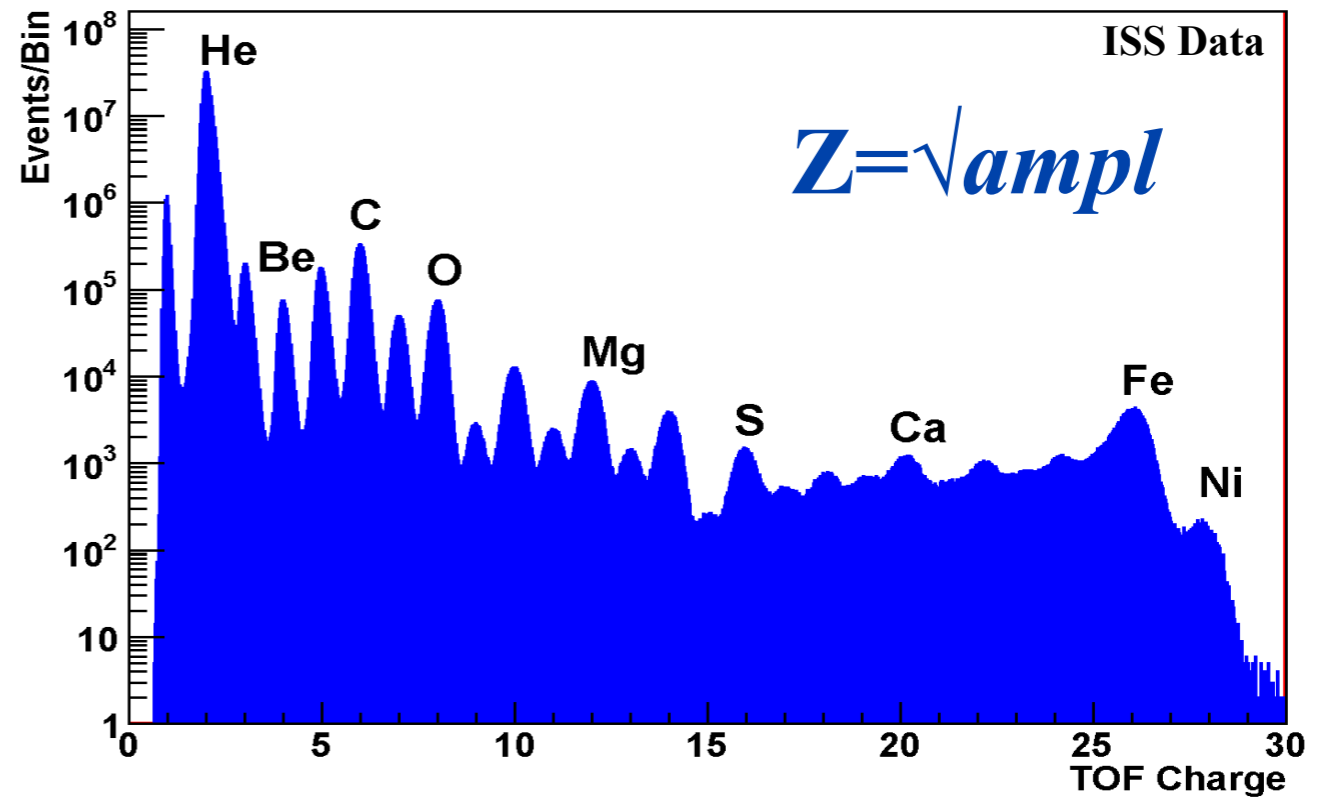
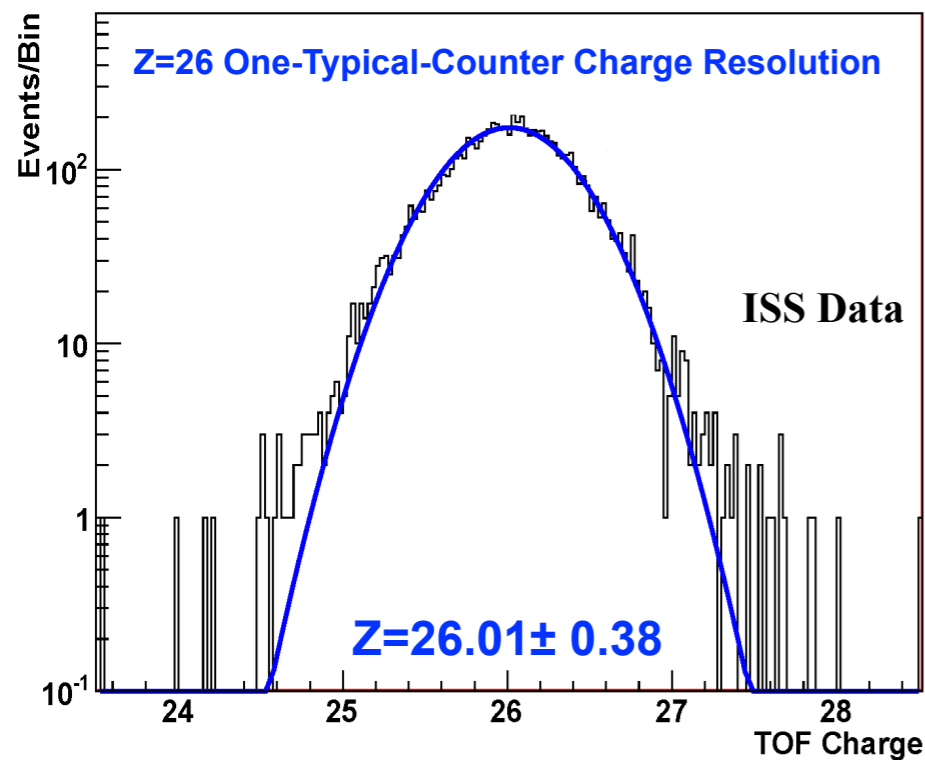
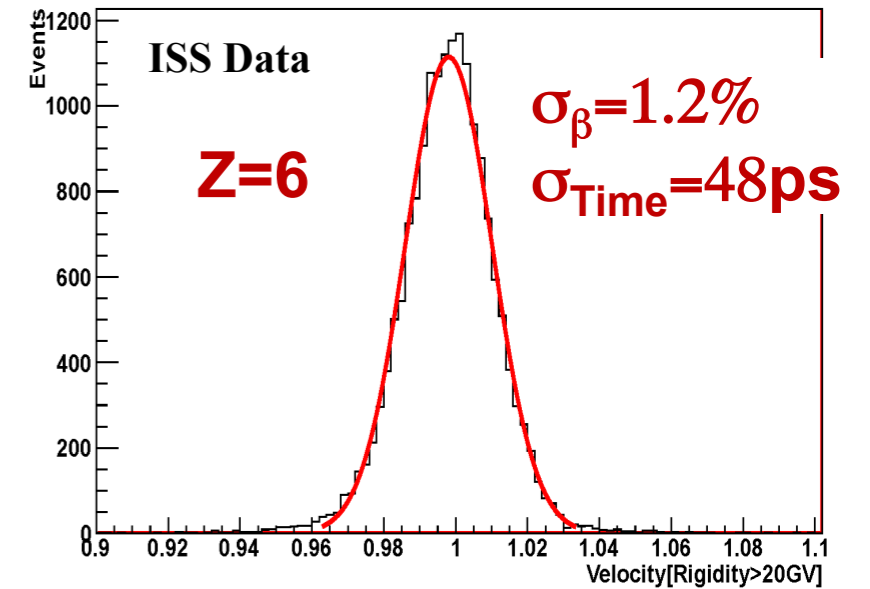
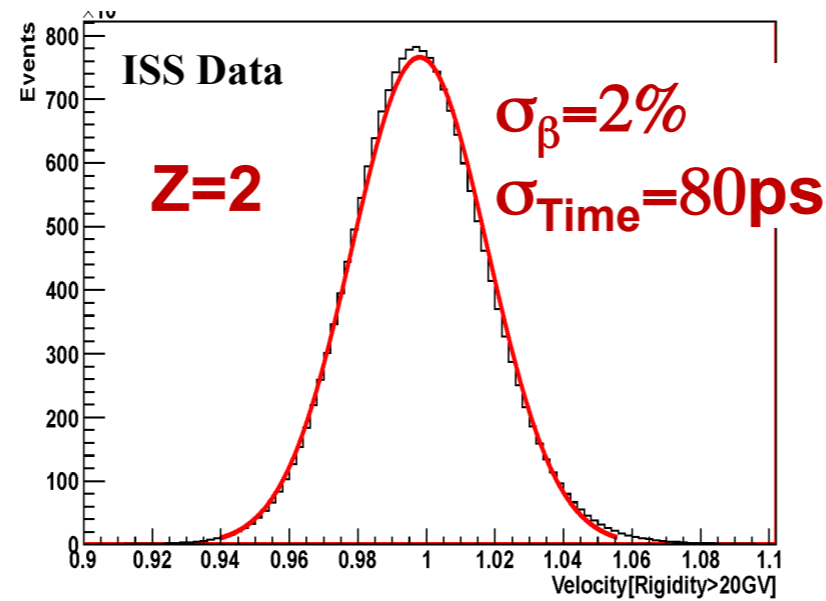
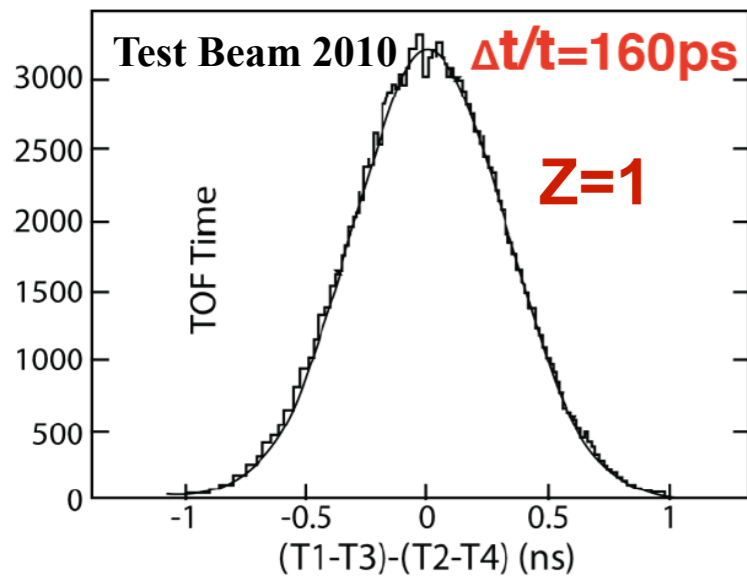

# Tracker

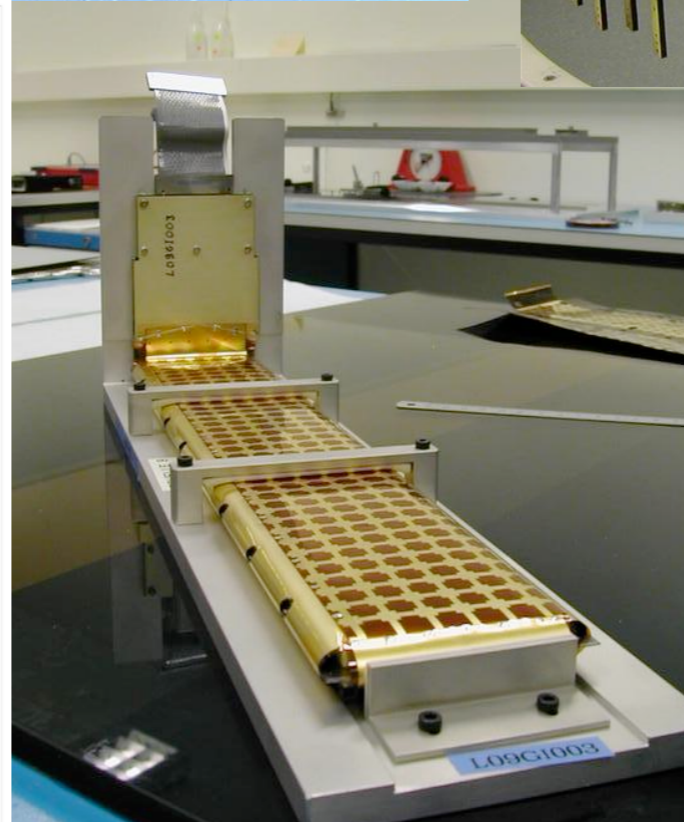
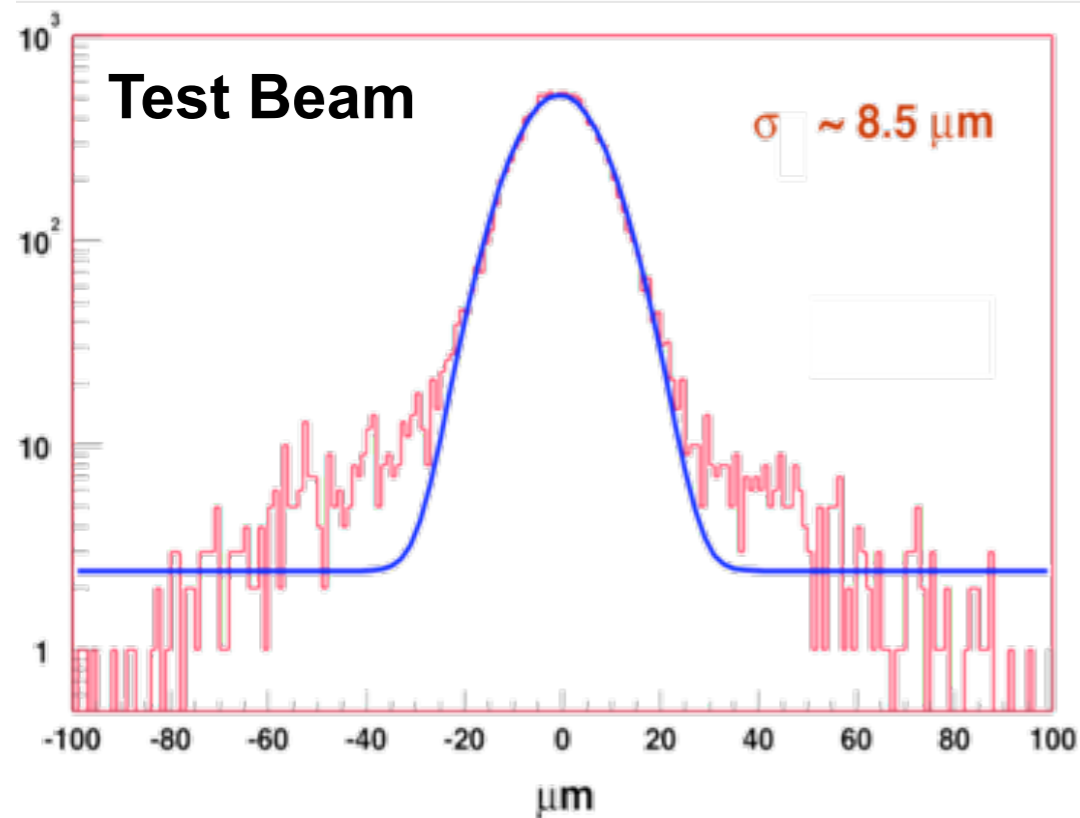
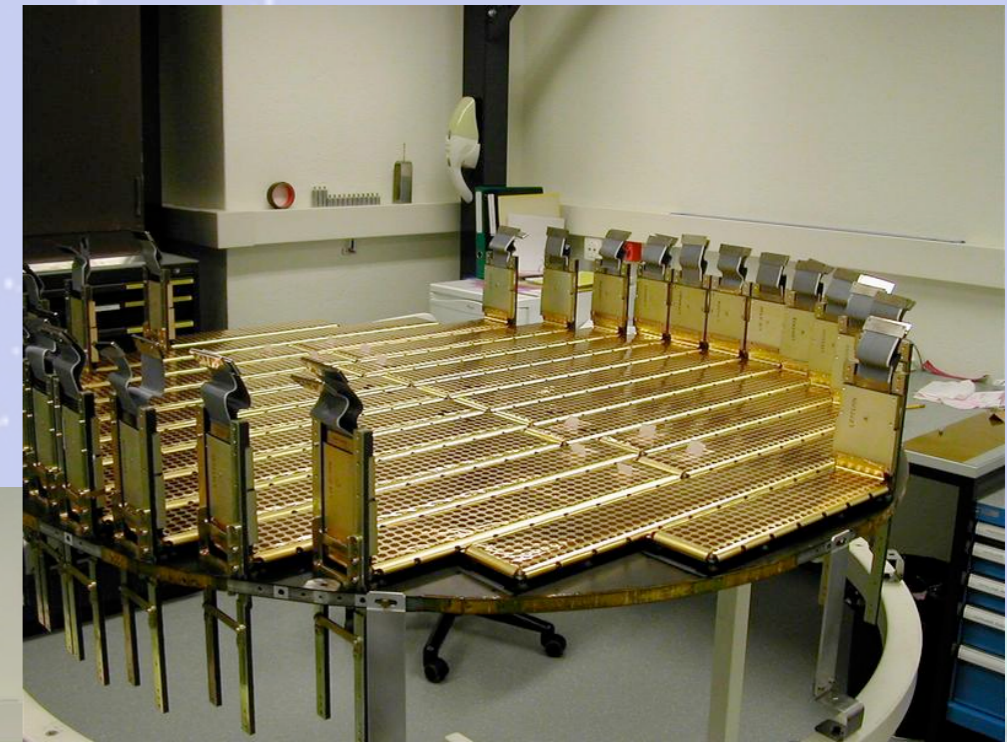
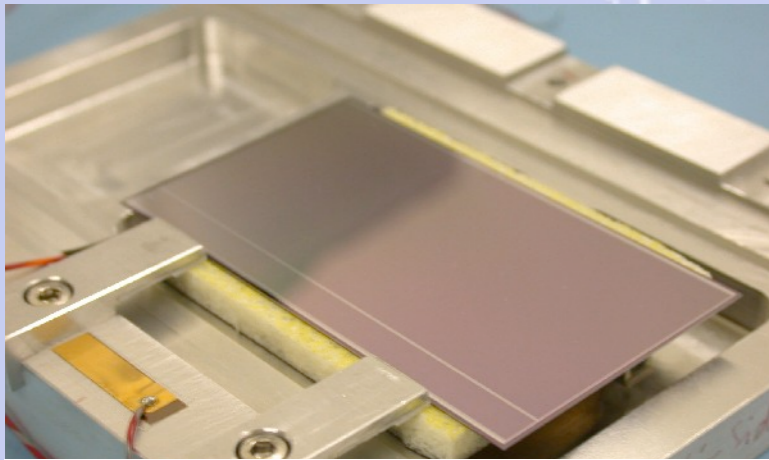

**9 layers of double sided silicon sensors (detector material  $\sim 0.04 X_0$ )  
6.6m<sup>2</sup>  $\rightarrow$  192 Ladders  $\rightarrow$  196k channels  $\rightarrow$  192 Watts dissipated**

**Spatial resolution:**

- ( $\sigma$ )  $\sim 8\mu\text{m}$  (bending plane)
- ( $\sigma$ )  $\sim 30\mu\text{m}$  (non bending plane)

**Momentum resolution  $\sim 10\%$  at 10 GV**

**Wide temperature range  
(-20/+40 survival, -10/+25 oper.)**

**High dynamic range front end for  
charge measurement**

# Tracker

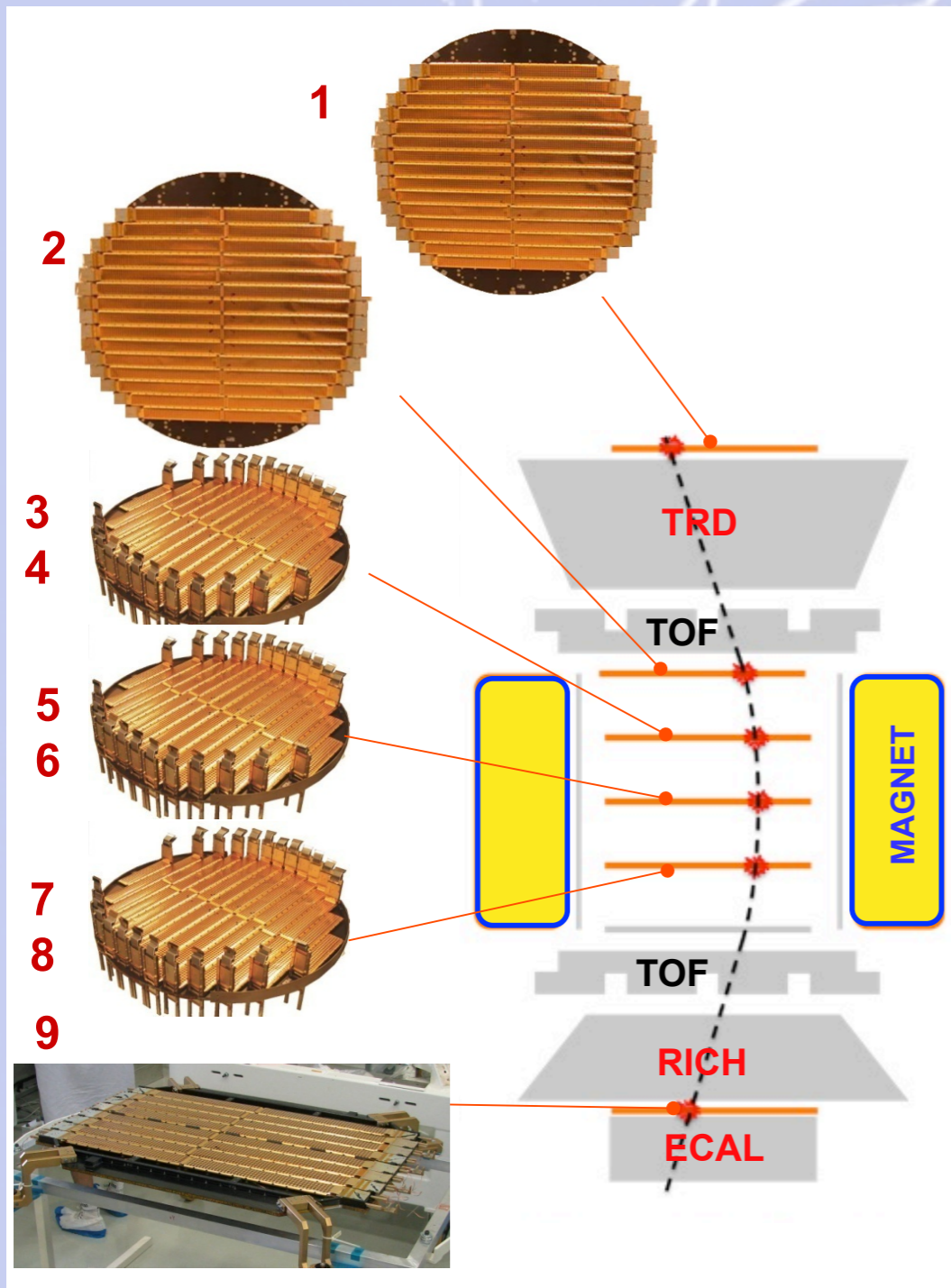

The particle trajectory is measured on several points (9) by its intersection with silicon microstrips detector layers.

## Nuclei identification

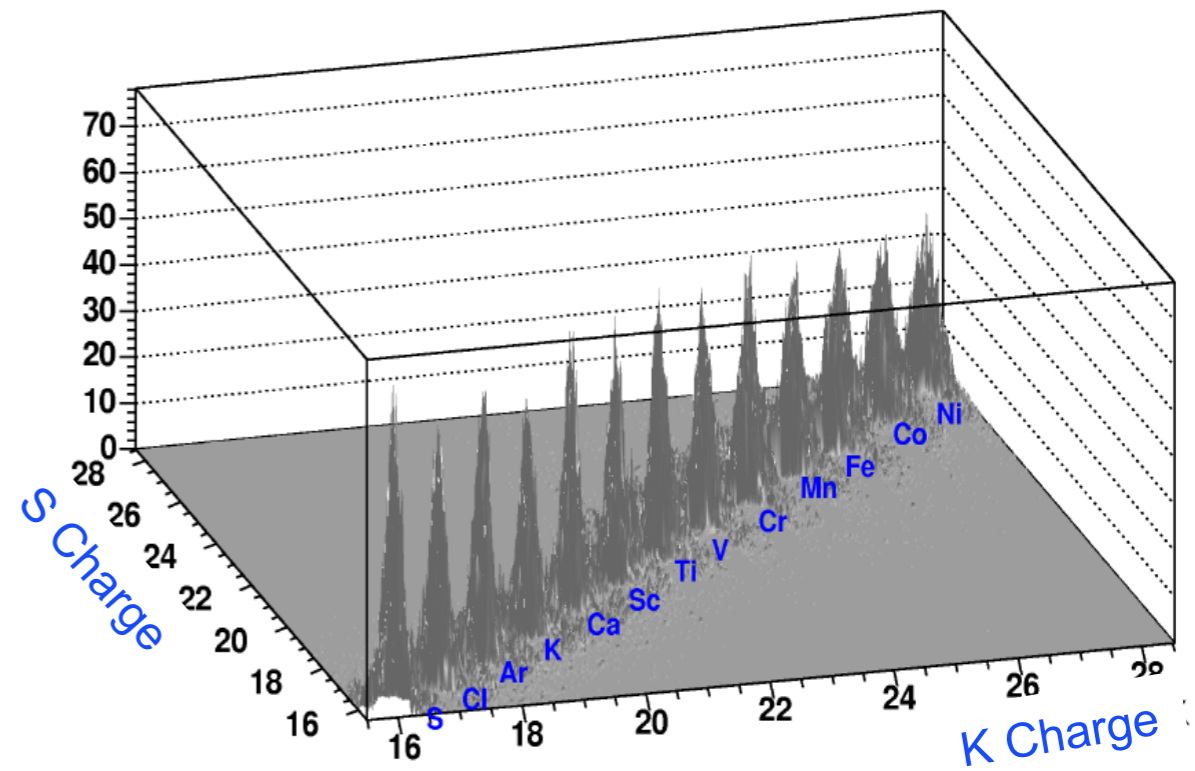
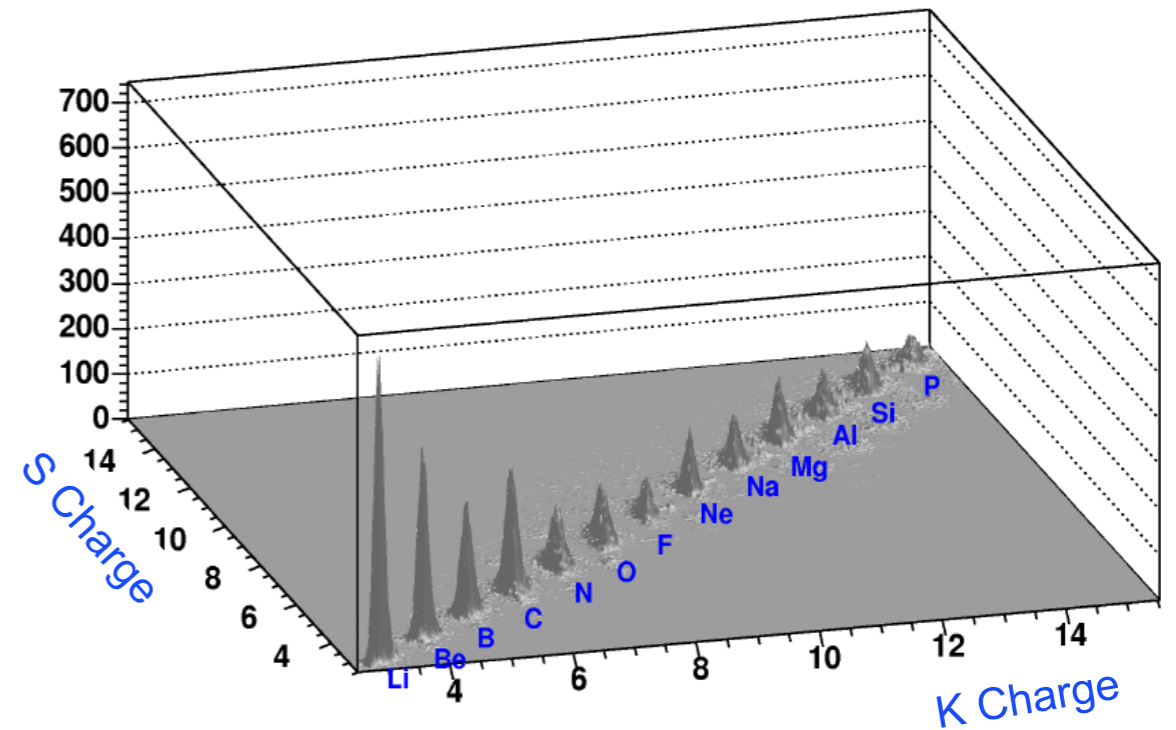

# Tracker Performance on ISS

The alignment stability ( $3\mu\text{m}$ ) of the uppermost Tracker plane (L1)

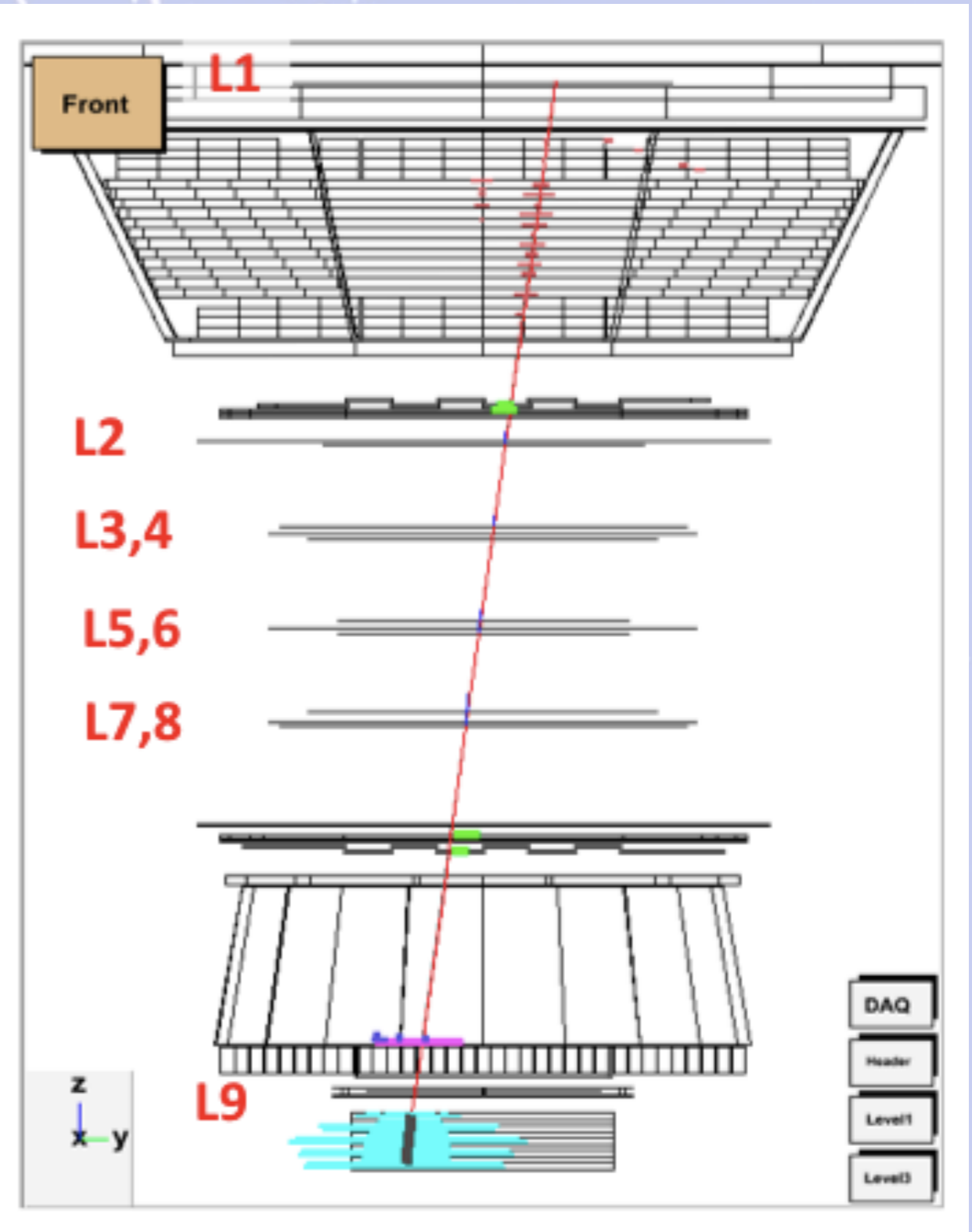
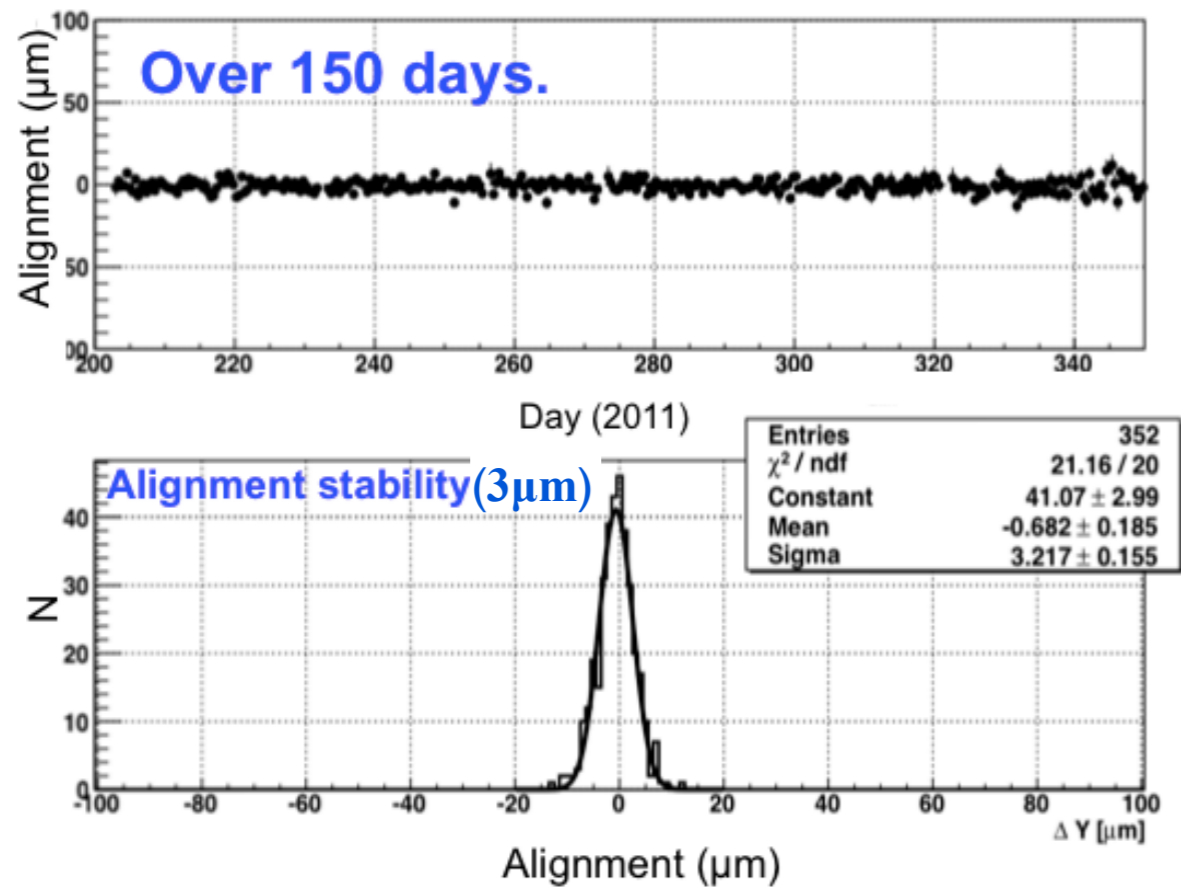

Stability of the temperature of Tracker planes 5

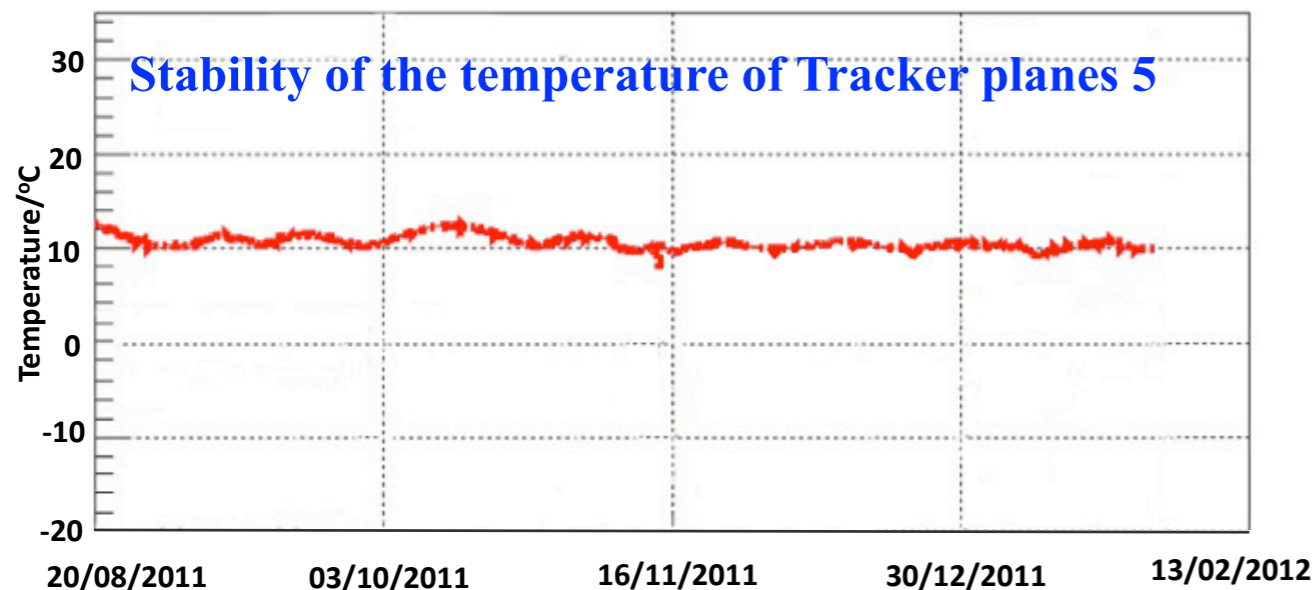

# The AMS-02 permanent Magnet

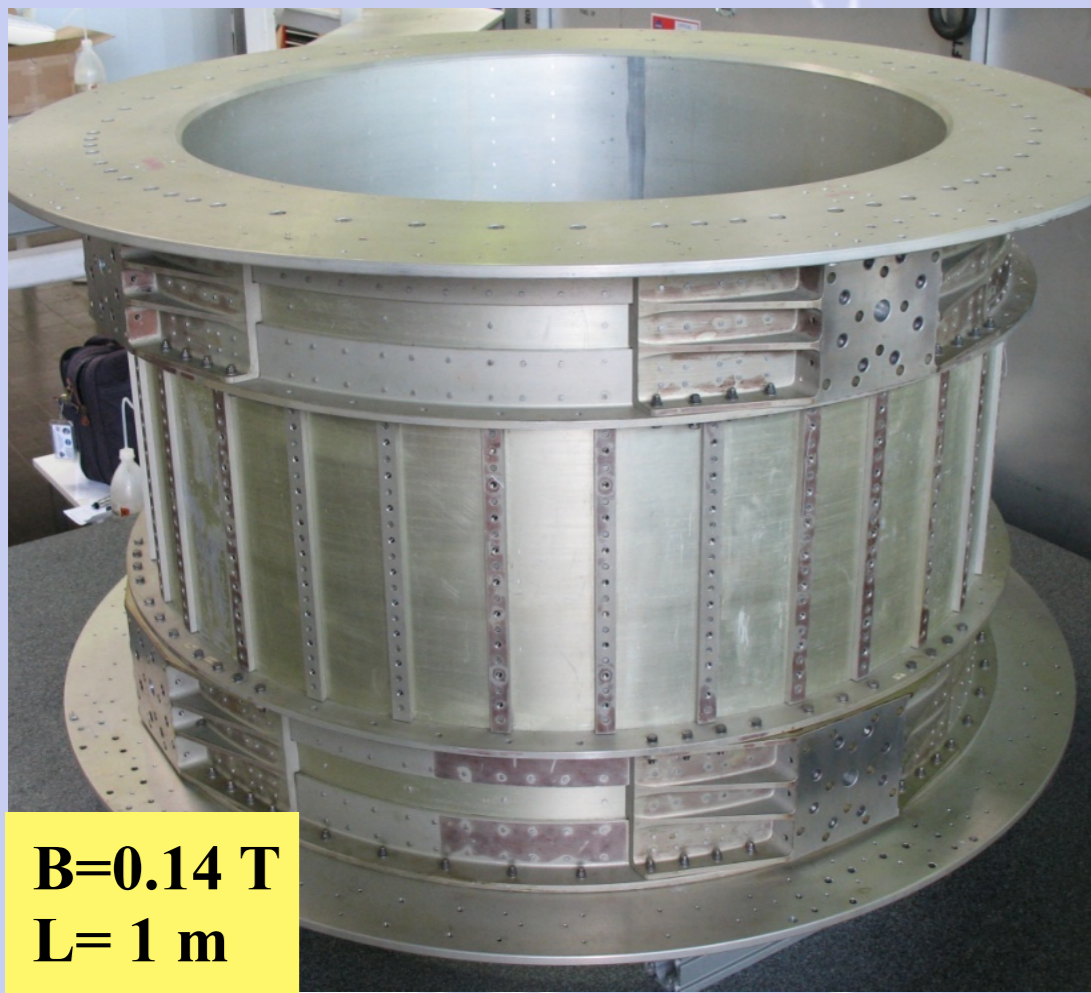

**B=0.14 T**  
**L= 1 m**

Torques are forbidden in space so the total magnetic torque of the AMS-02 magnet must be zero!

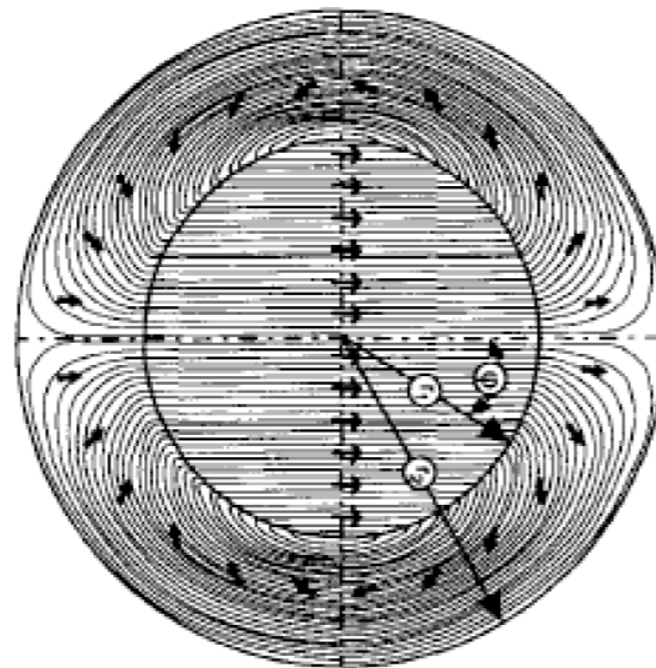
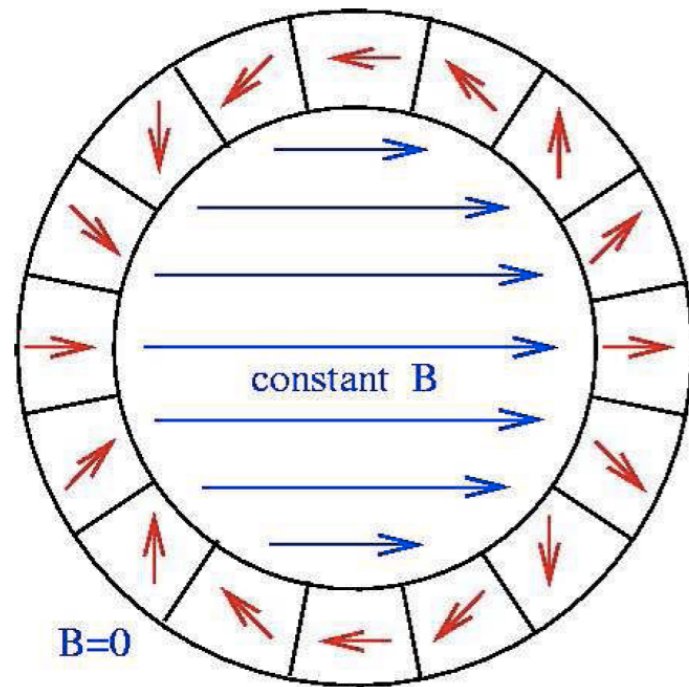

**Magnetic field distribution at a cross-section of the centre of the magnet**

**The detailed 3D field map (120k locations)**

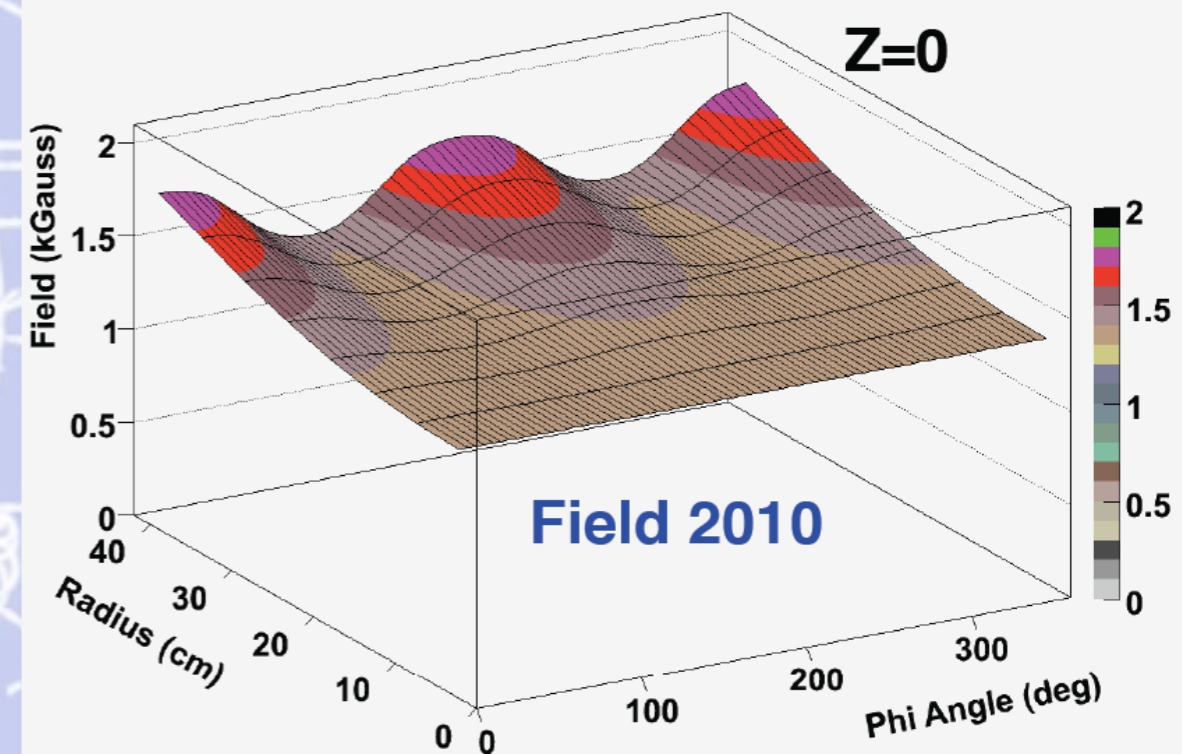

# The AMS-02 Spectrometer modifications

Deviation from 1997 measurements

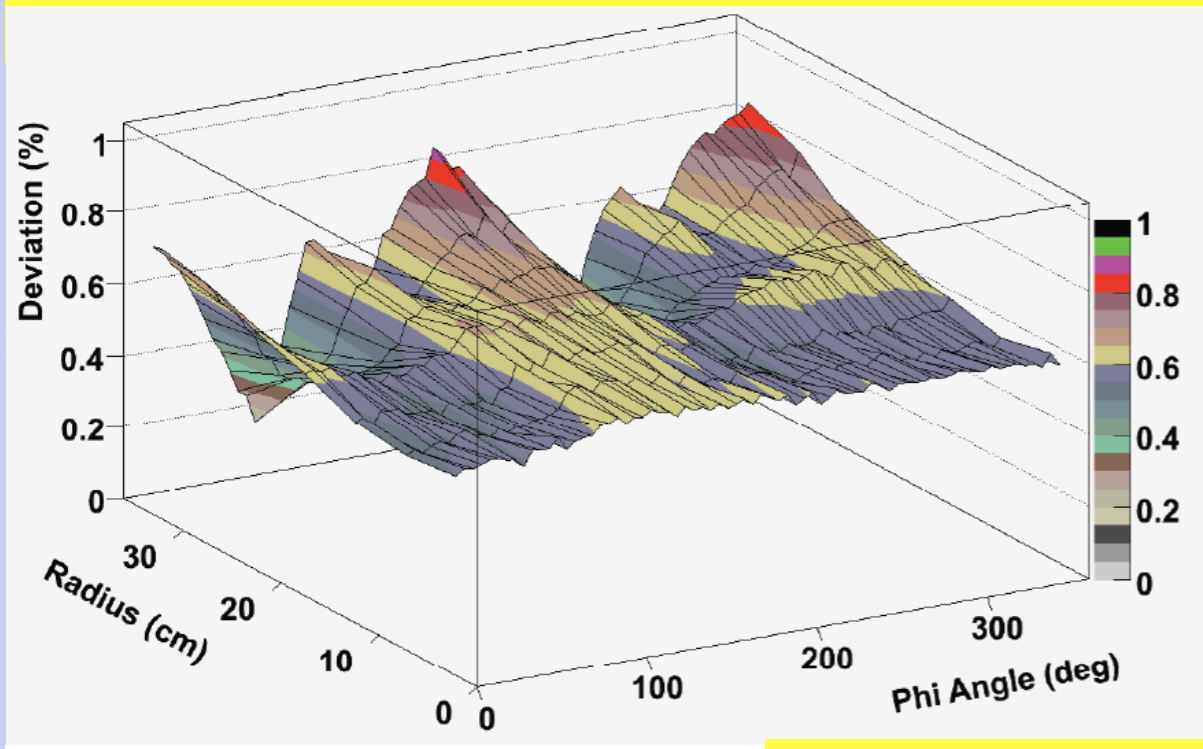

In 12 years the field has remained the same to <1%

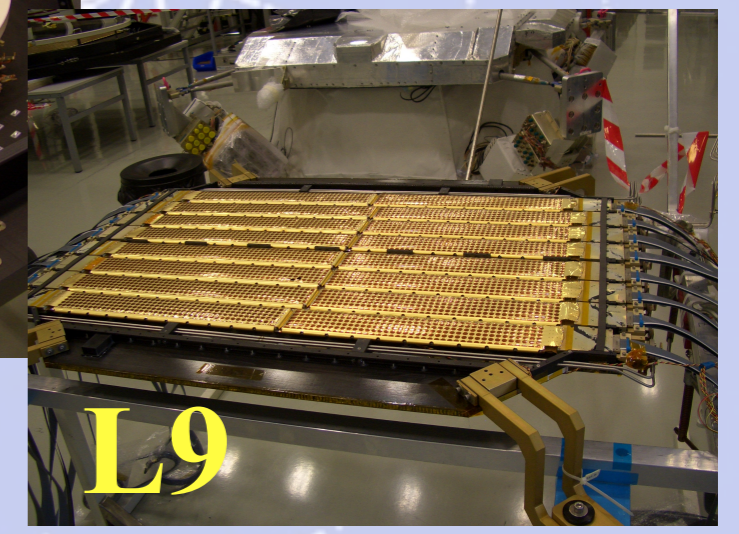
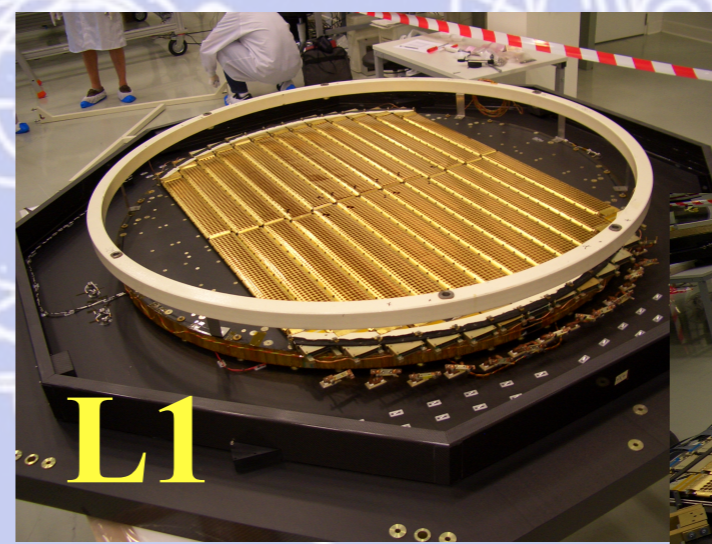
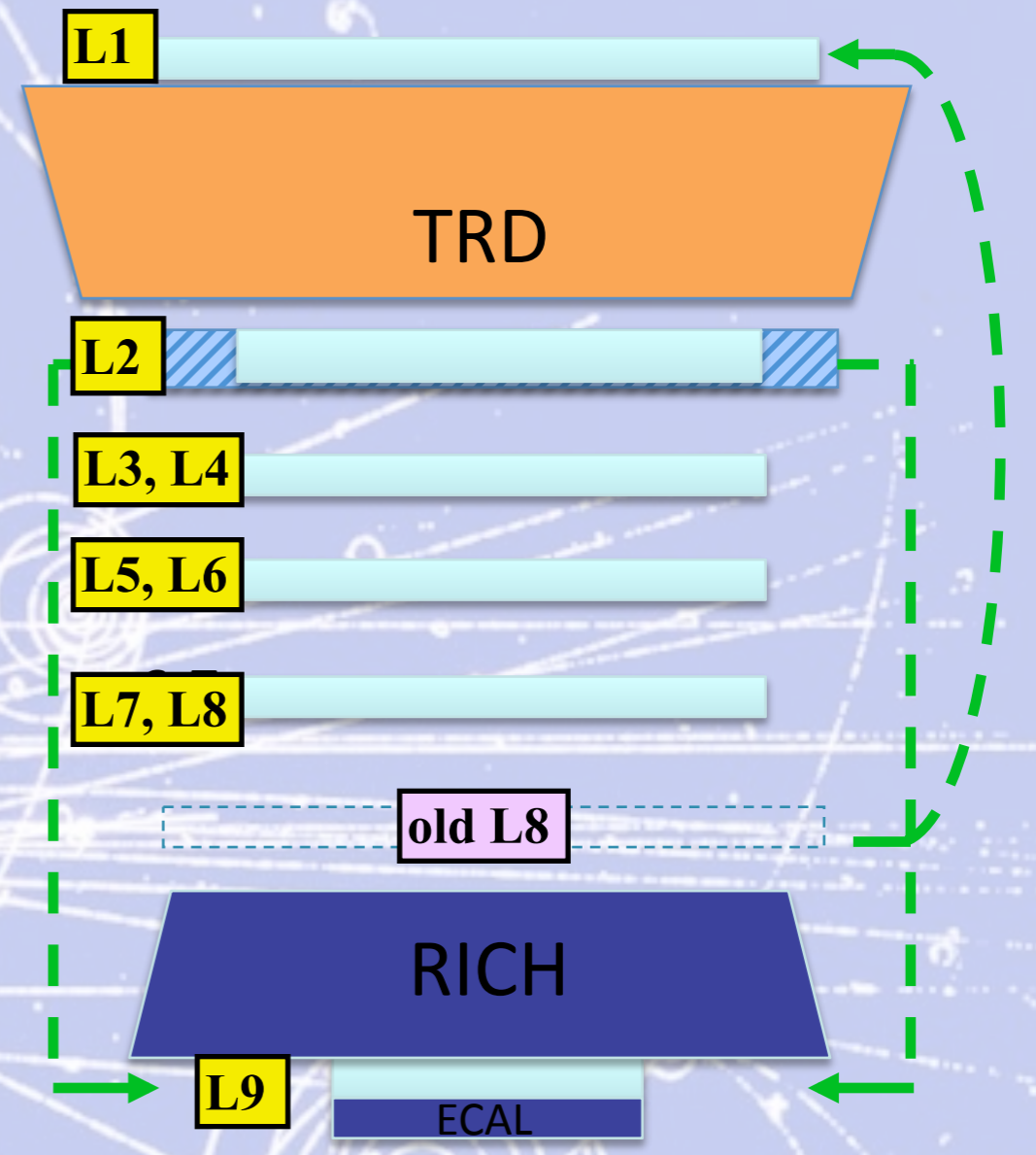
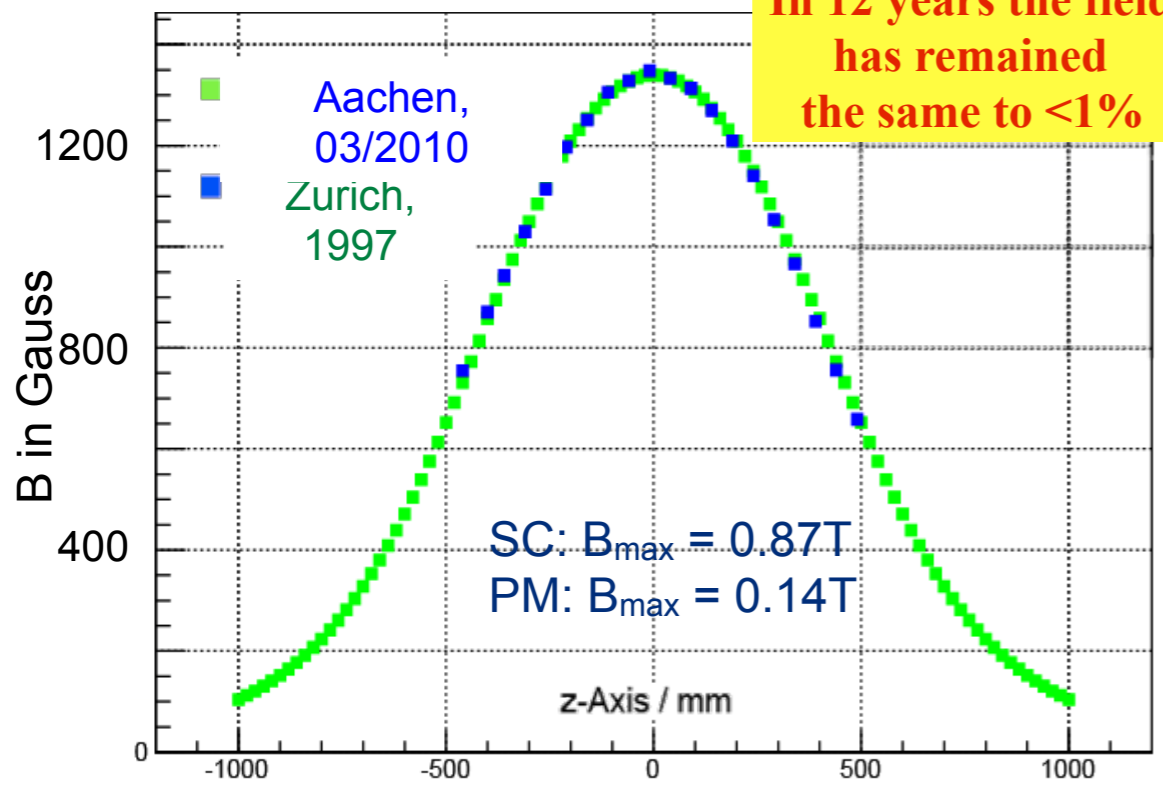

# The AMS-02 Spectrometer performance

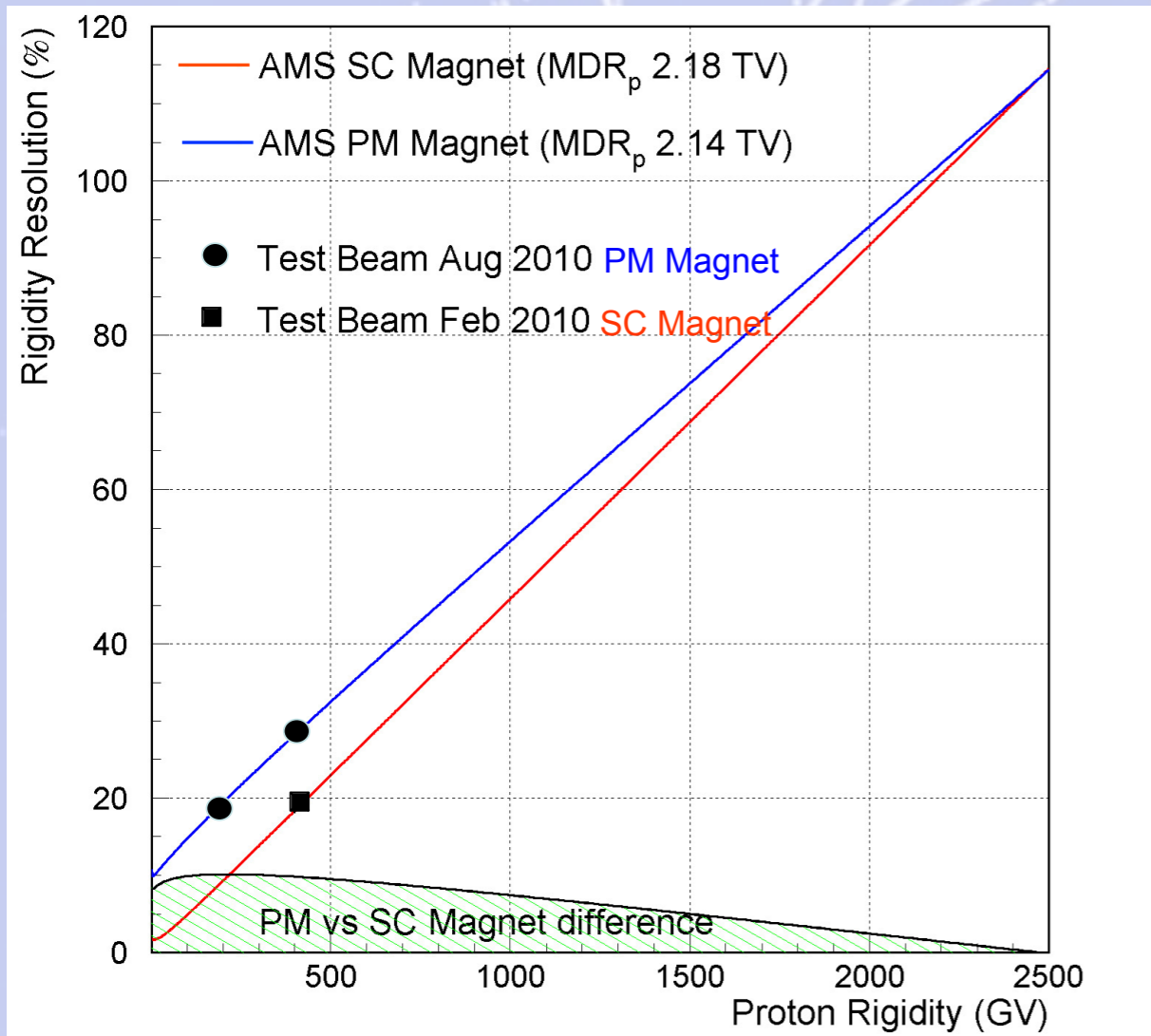

- For helium nuclei, the  $MDR^{(*)}$  for the permanent magnet is 3.75 TV.
- Alignment will be done with 10'000 CR tracks per minute in orbit.

(\*) Max detectable rigidity ( $R=pc/Ze$ )

With 9 tracker planes in the new configuration, the rigidity resolution of AMS with the permanent magnet is equal (within 10%) to that of the superconducting magnet.

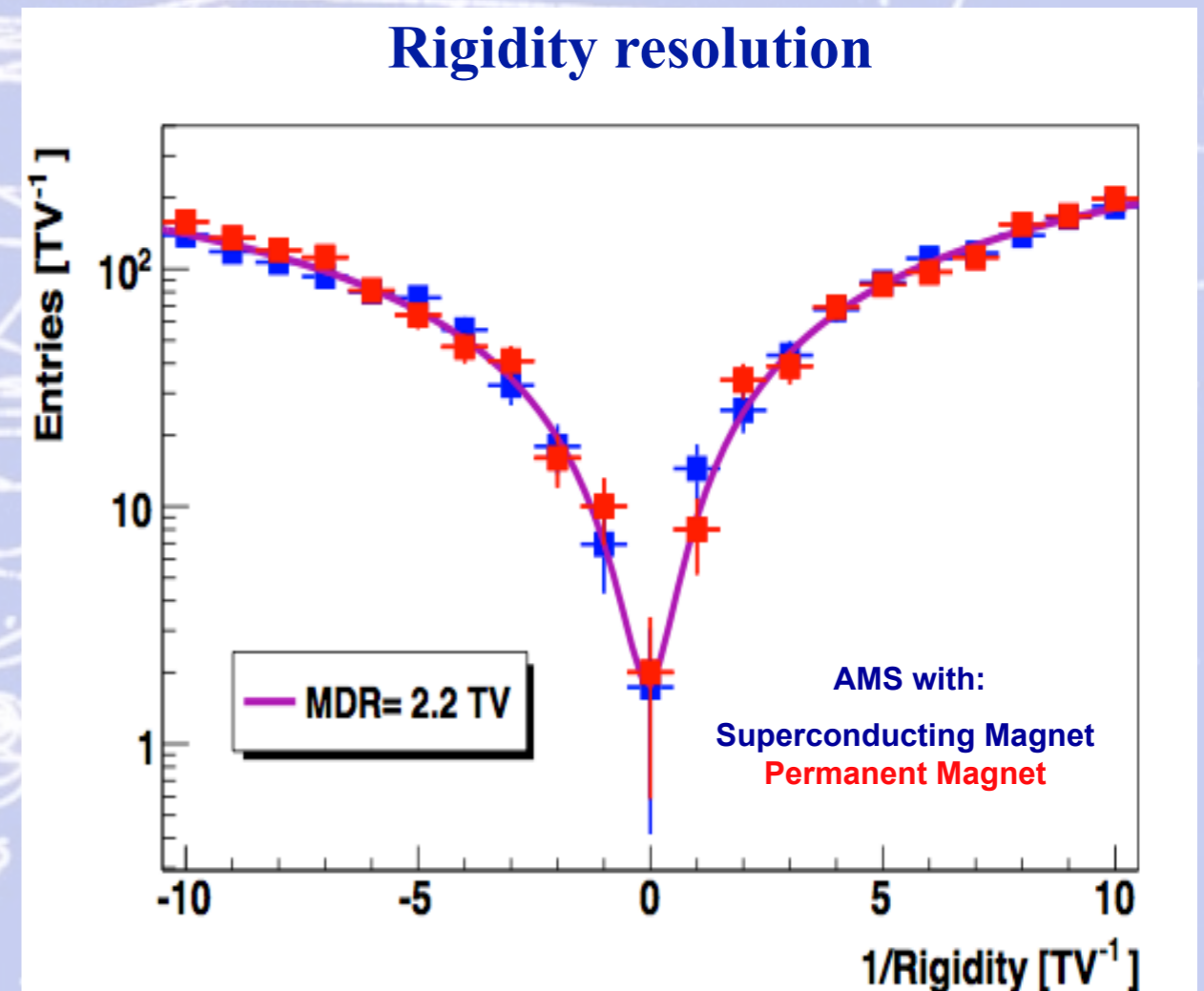

# The AMS-02 Tracker Alignment System Layout

## Front-End Electronics

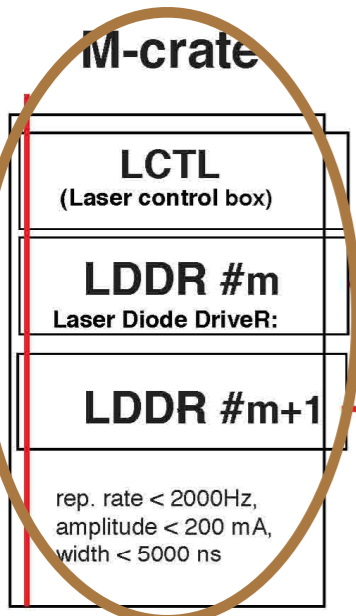

## Laser Diodes ( $\lambda=1082$ nm)

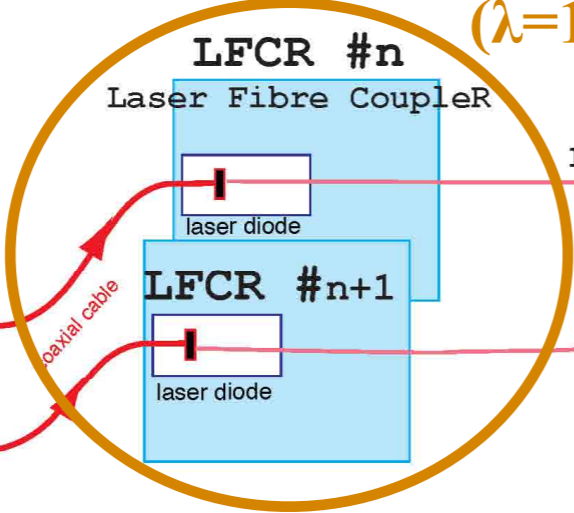

- 20 laser beams top-to-bottom
- ~~20 laser beams bottom-to-top~~

## Optical Fibers

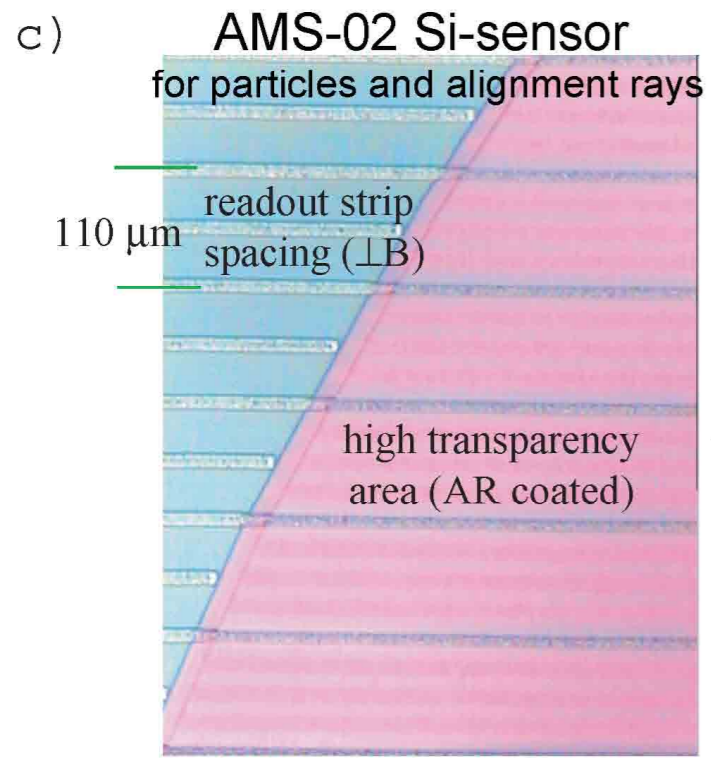
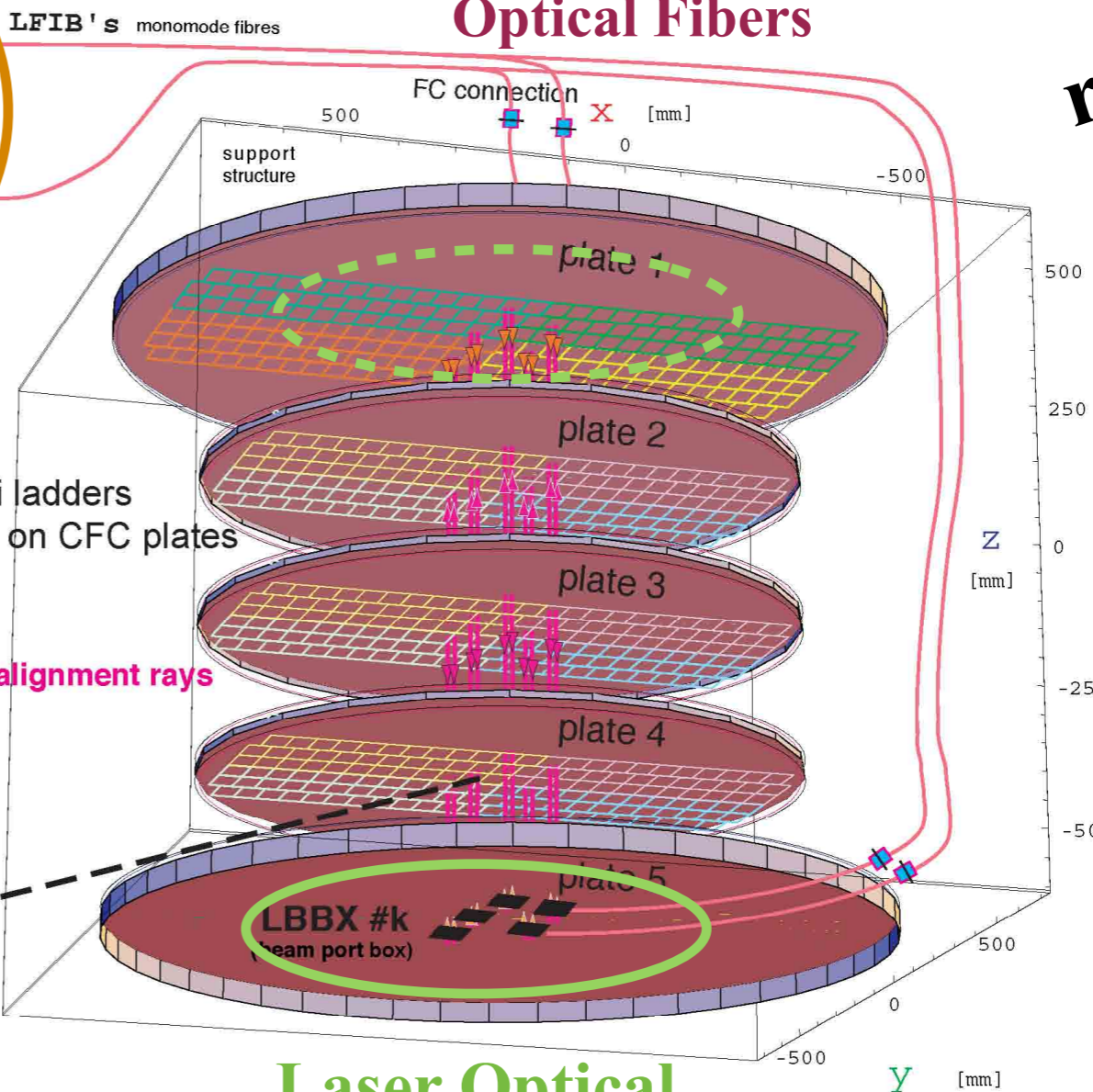

**removed!**

## Laser Optical Beam Port Boxes



# Ring Imaging Cherenkov (RICH)

identify nuclei and their energy

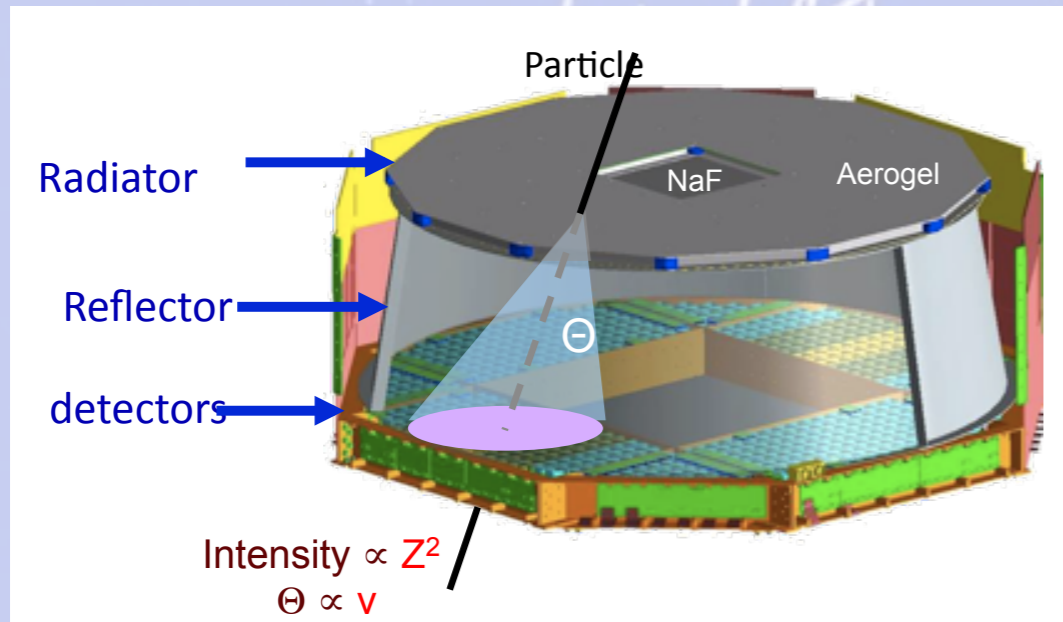

3cm silica Aerogel( $n=1.05$ ) +NaF ( $n=1.33$ ) radiator;

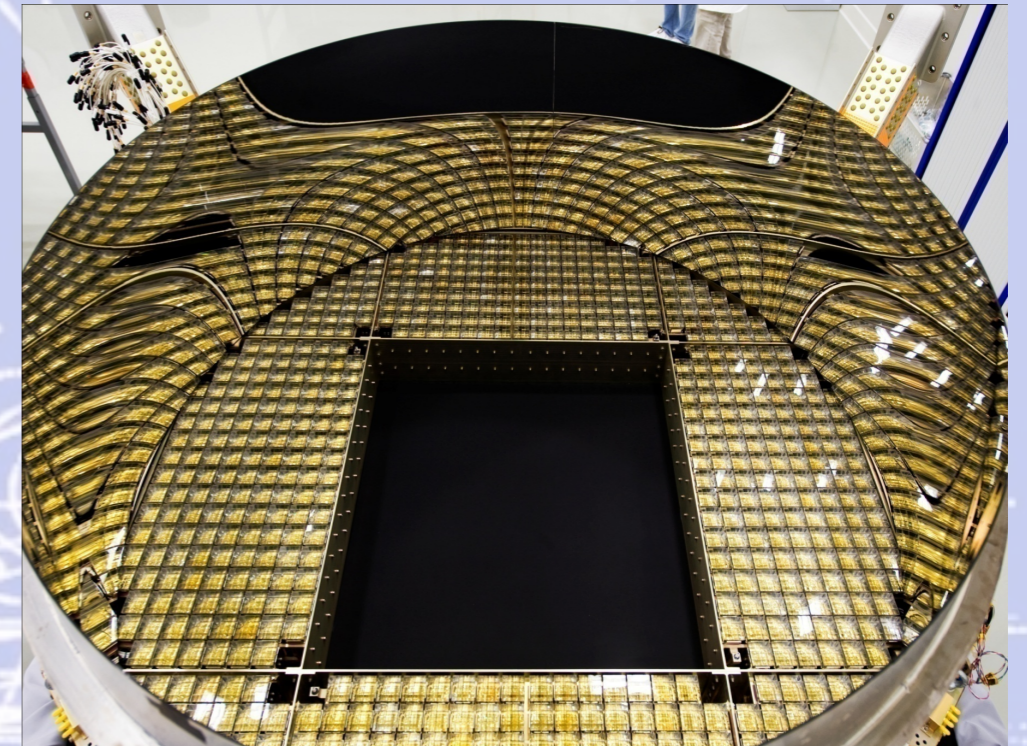

10,880 photosensors  
21,760 Signal Pulses

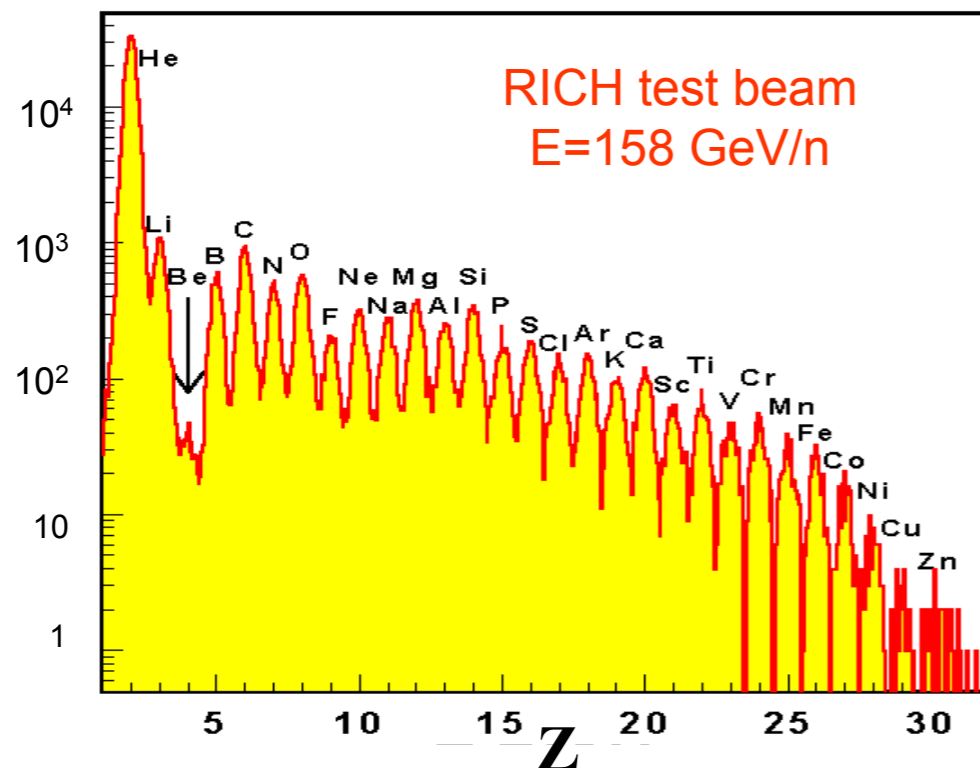

Single Event Displays from  
RICH test beam  $E=158 \text{ GeV/n}$

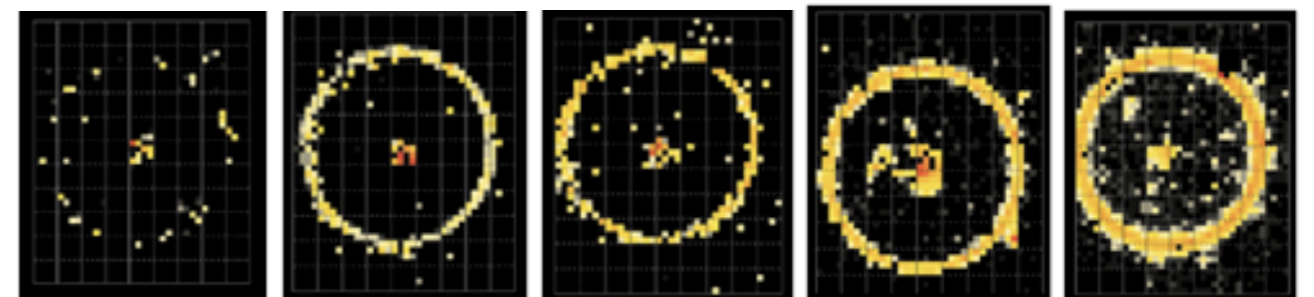

He

Li

C

O

Ca

$\sigma(\beta)/\beta=0.1\% @ \beta=1$  (protons)

$\Delta Z \sim 0.2$  up to Fe

# Data from ISS: Nuclei identification from RICH

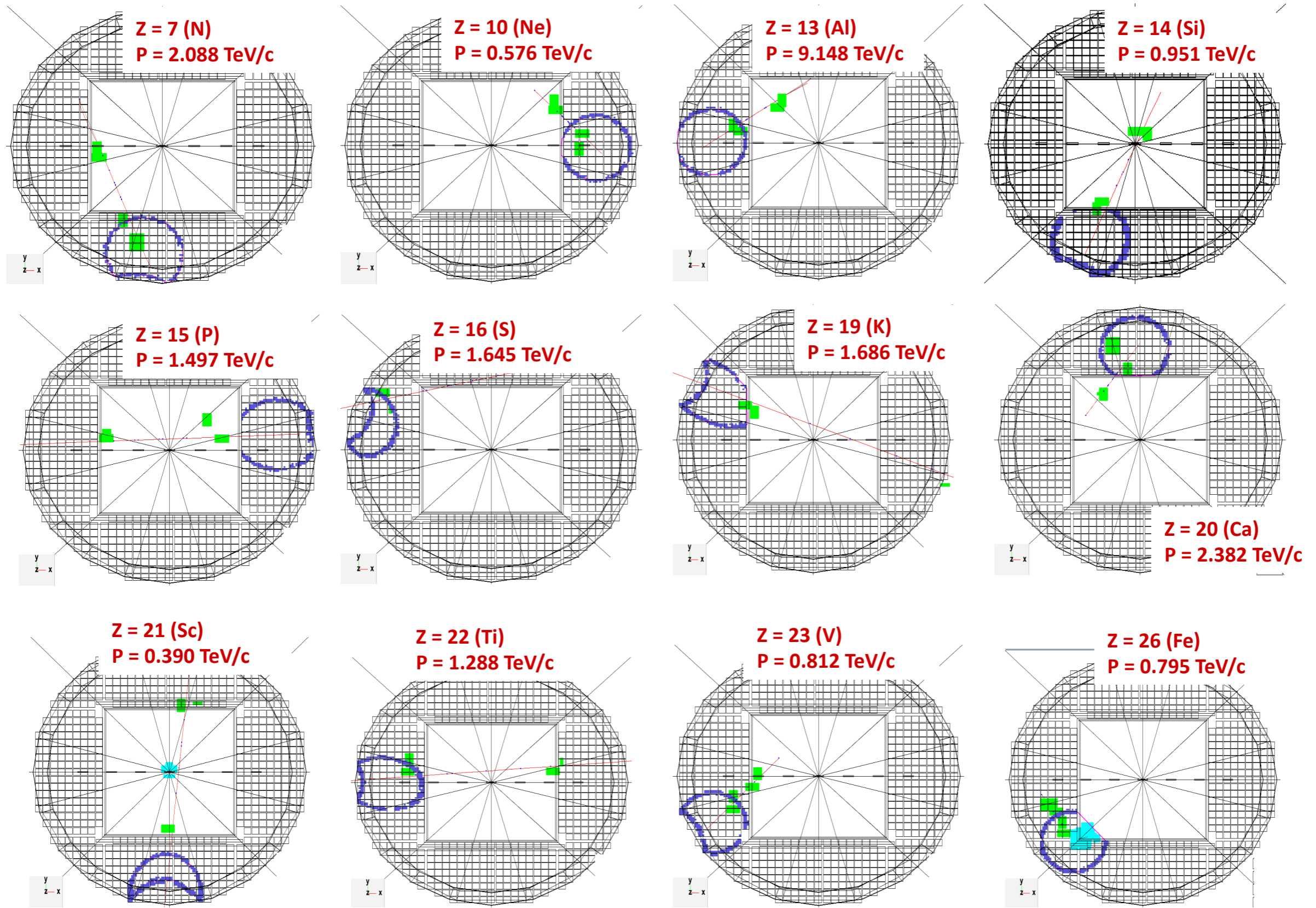

# Calorimeter (ECAL)

A precision,  $17 X_0$ , TeV,  
3-dimensional measurement of the  
directions and energies of light rays  
and electrons

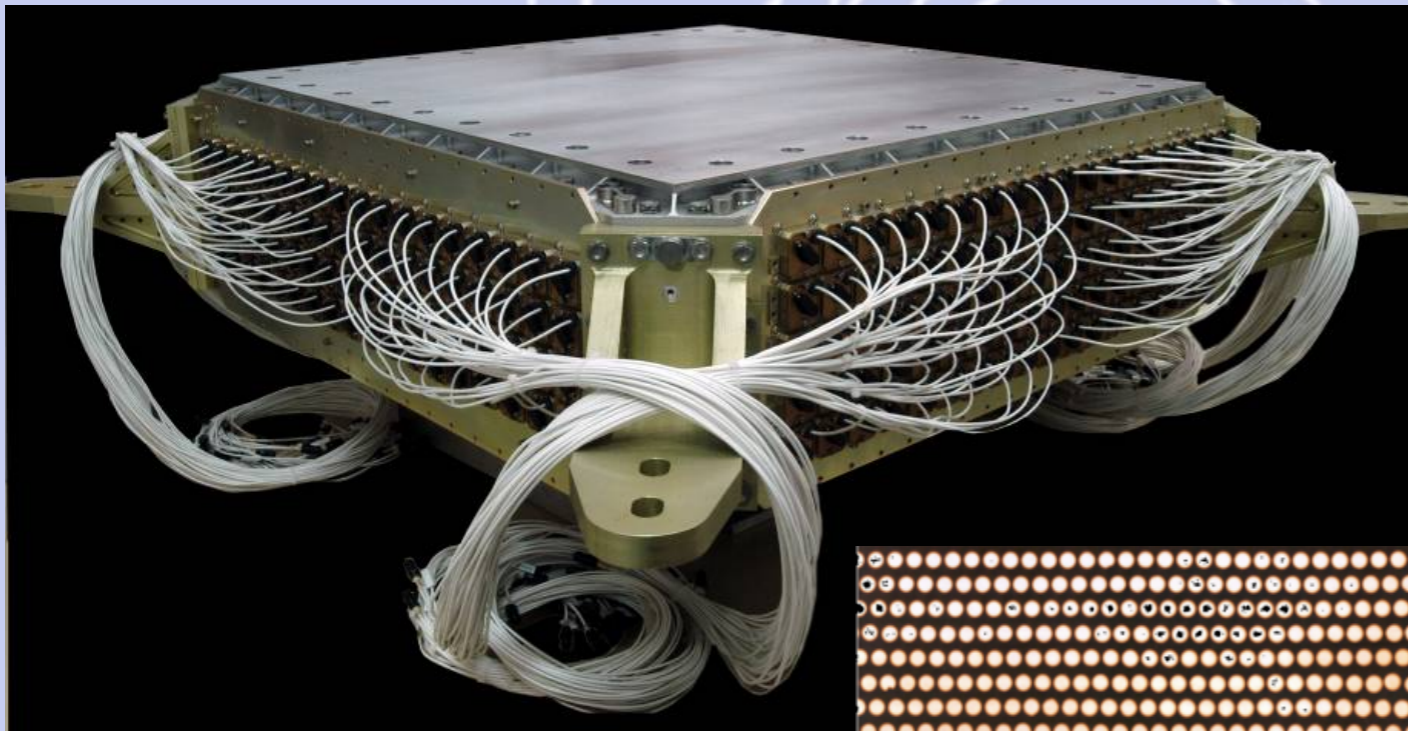

10 000 fibers,  $\phi = 1$  mm distributed uniformly  
inside 1,200 lb of lead

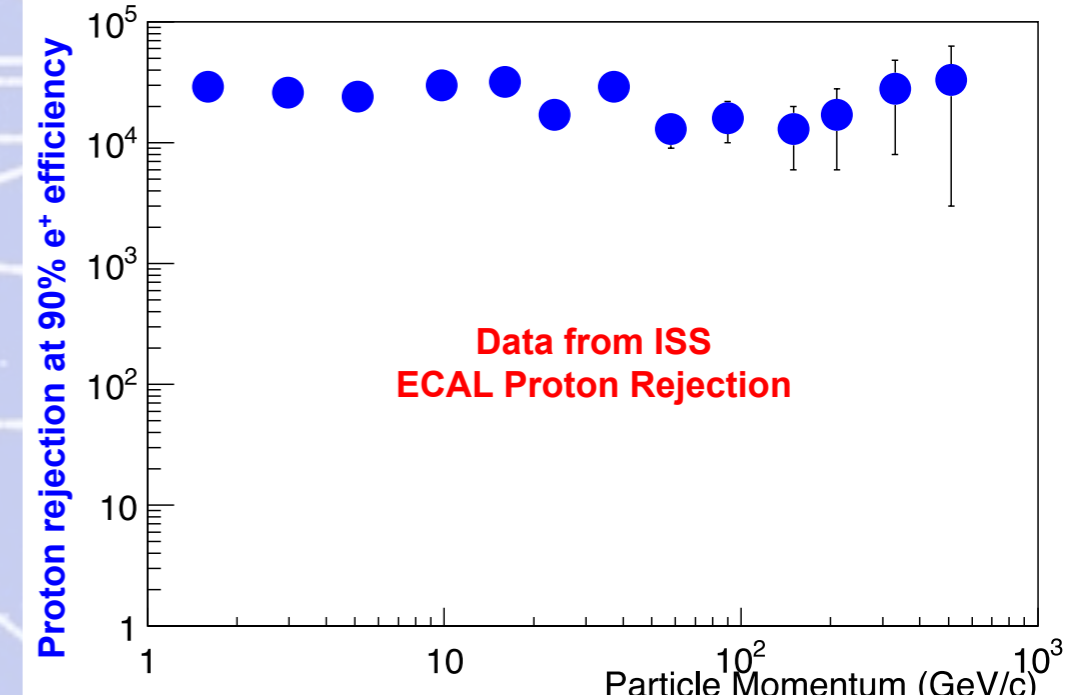
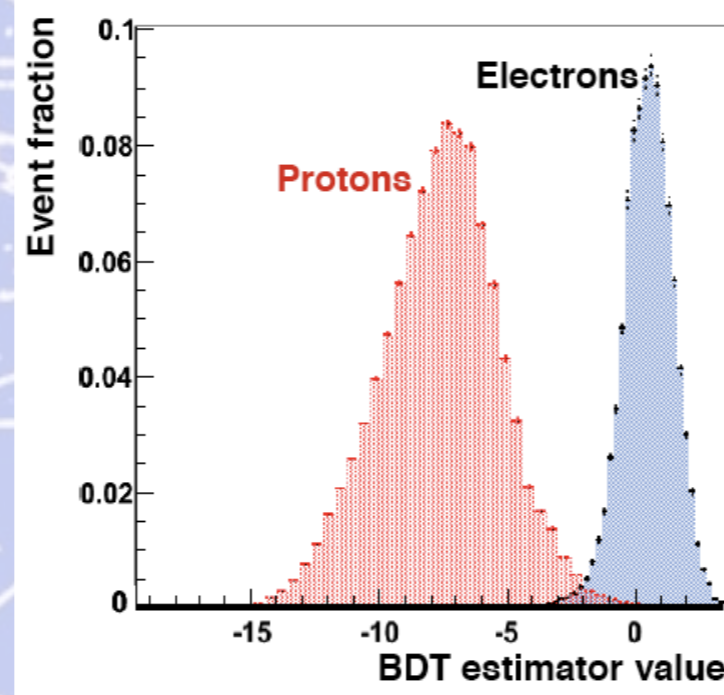
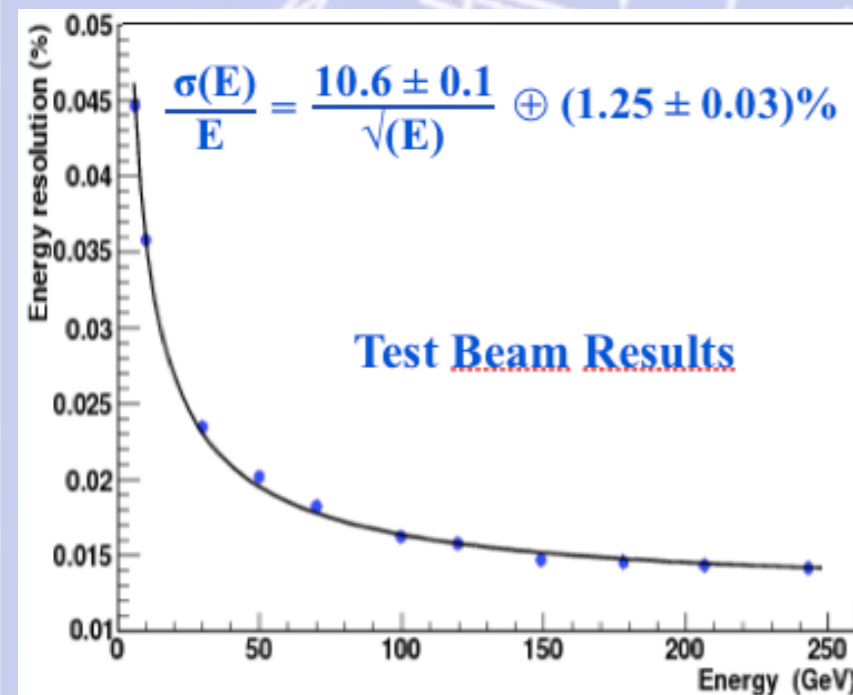
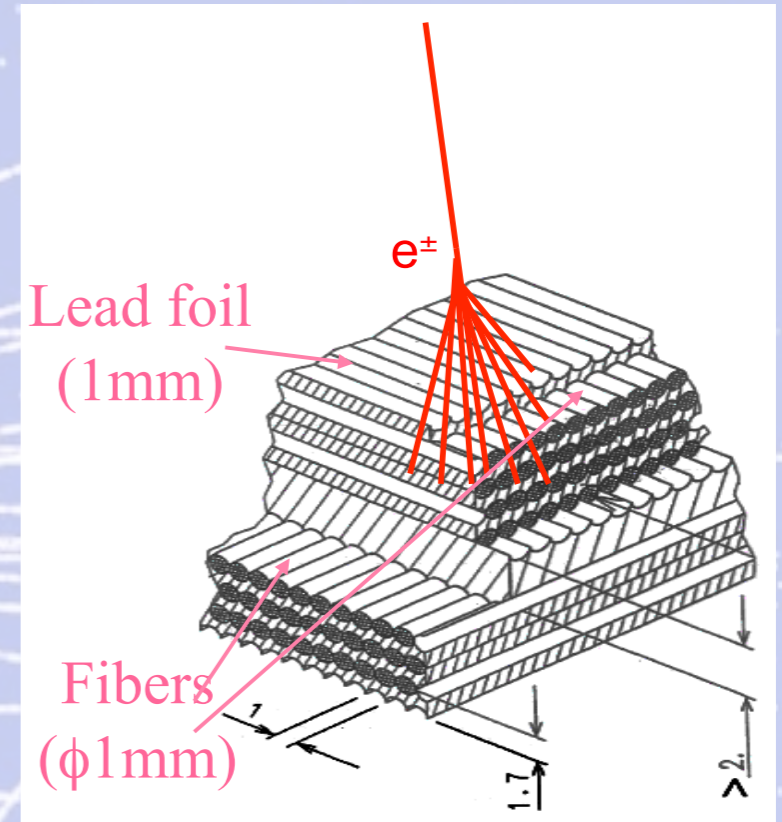

# AMS electronics

**650** processors,  
**300,000** channels.  
up to **400%** redundancy

Reduce data volume  
**7 Gbit/s** to **10 Mbit/s**

To read out 300,000 channels at up to 2 KHz, a large set of **computers (650)** which are **programmable from the POCC** have been developed.

All the different detectors are readout with up to 400% redundancy.

Hundreds of these computers are interconnected in a tree like structure with an 100 MBit/s serial link.

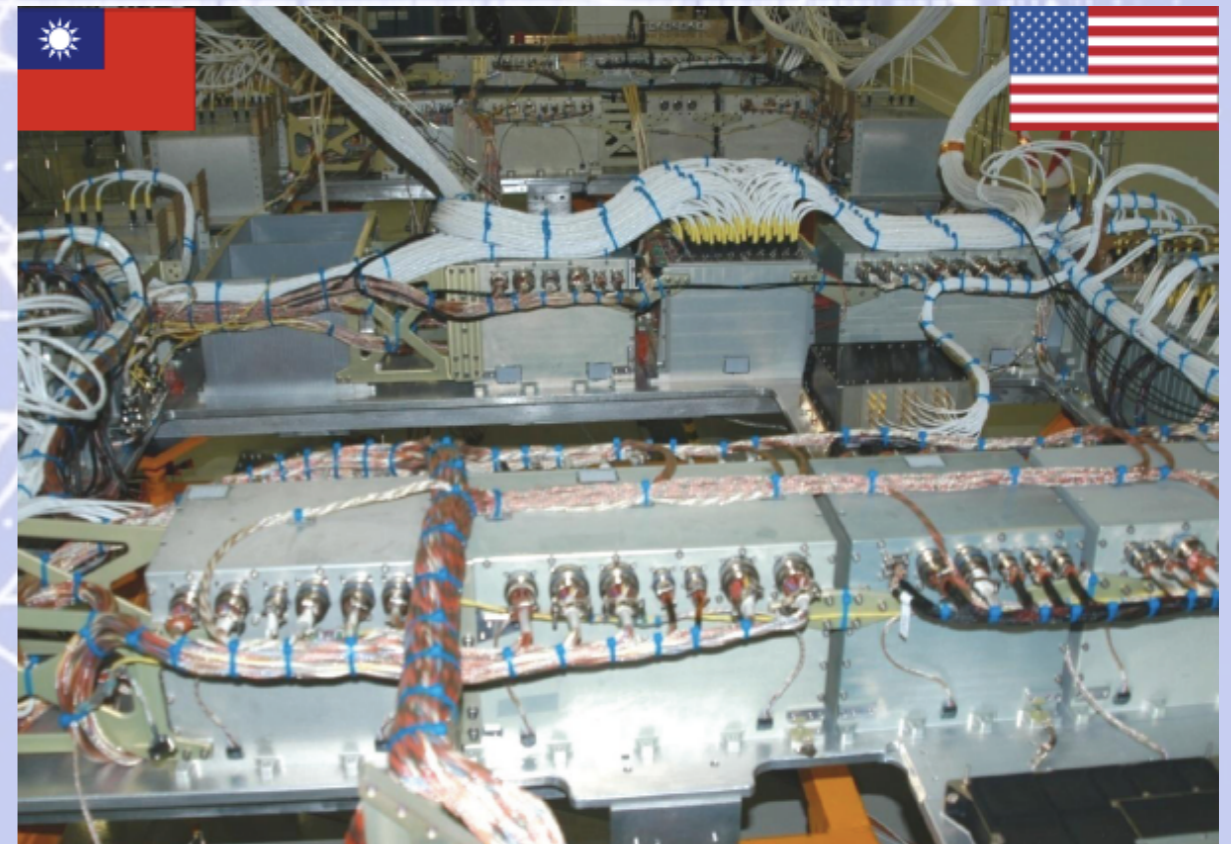

# AMS electronics

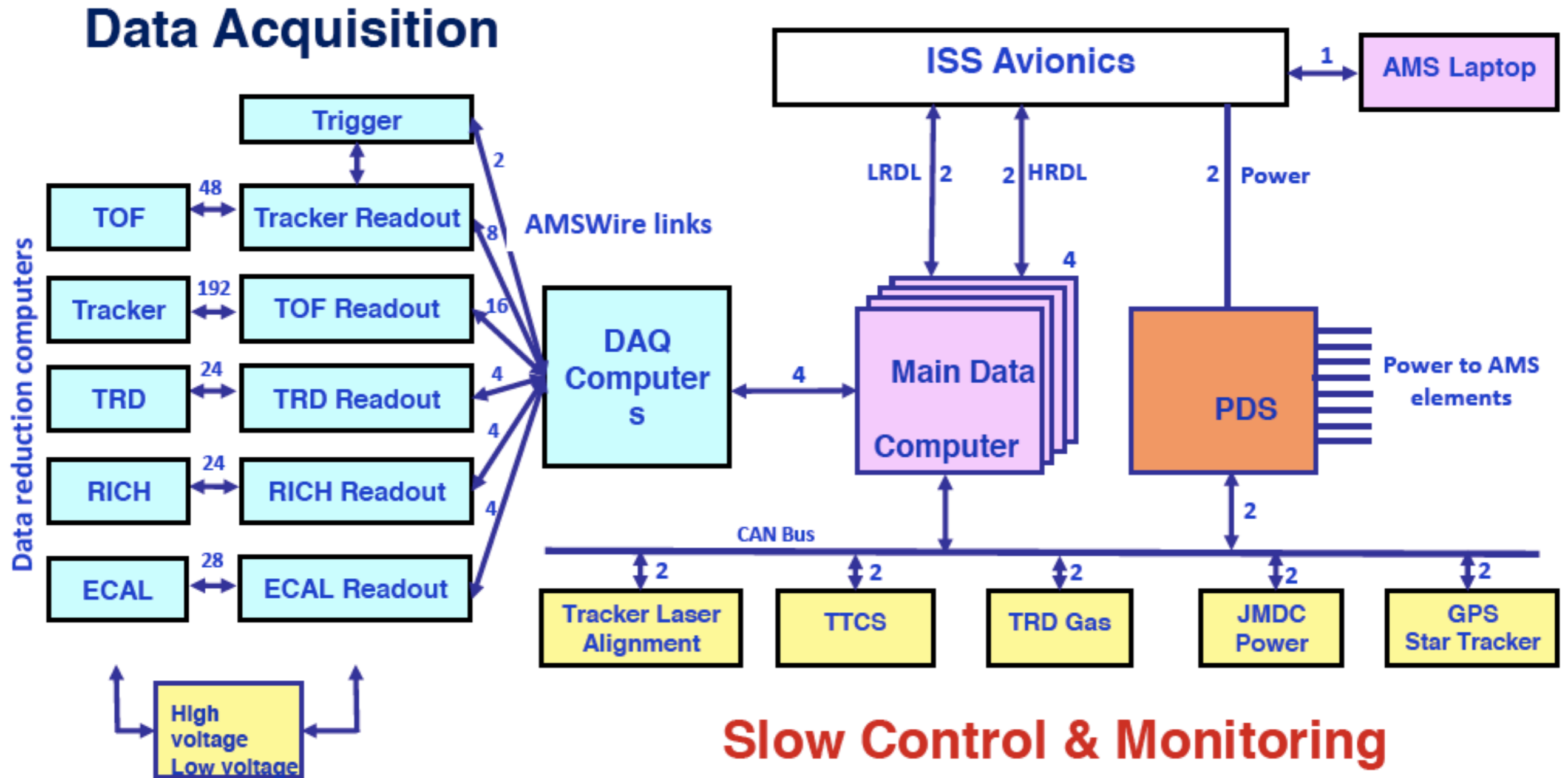

# Thermal Control is the most challenging task in the operation of AMS

The thermal environment on ISS is constantly changing due to:

- Solar Beta Angle ( $\beta$ )
- Position of the ISS Radiators and Solar Arrays
- ISS Attitude

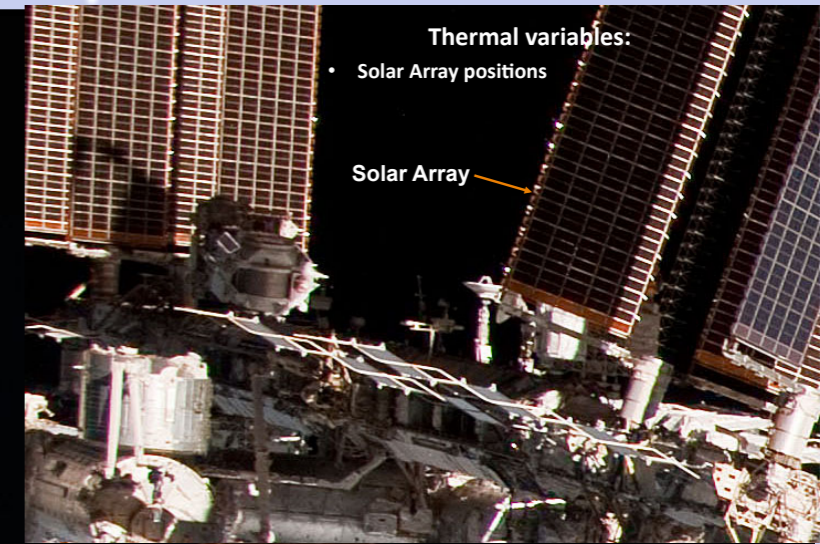

- Thermal variables:
- ISS Radiator positions
  - ISS attitude changes (primarily for visiting vehicles)

Visiting Vehicles  
(Soyuz or Progress)

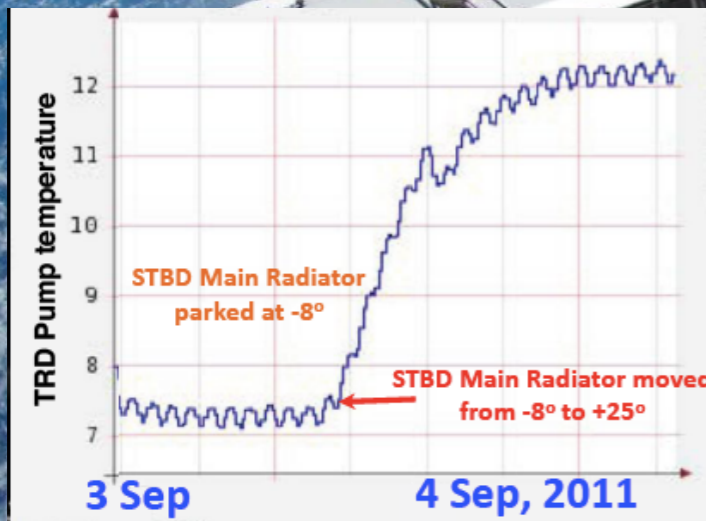

STBD Main Radiator

# AMS Flight Electronics for Thermal Control

**TRD**

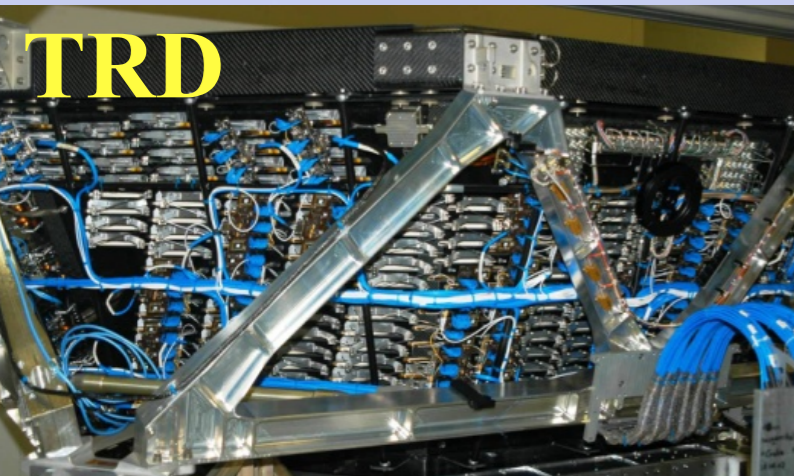

**24 Heaters, 8 Pressure Sensors**  
**482 Temperature Sensors**

**Tracker**

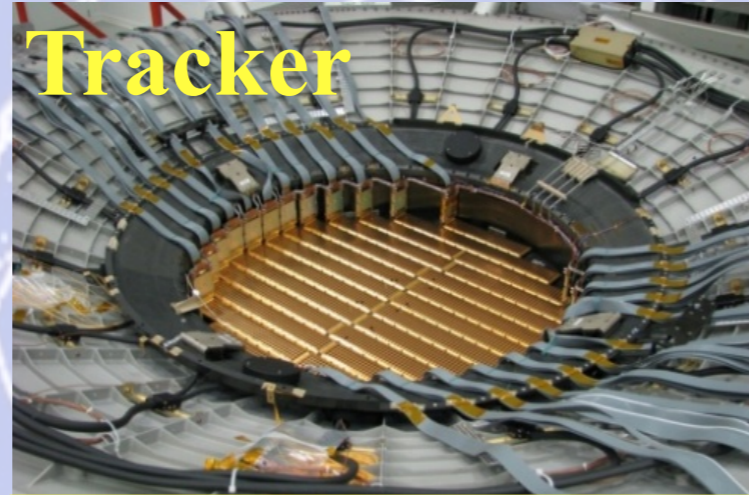

**4 -Pressure Sensors, 32 Heaters**  
**142 Temperature Sensors**

**ECAL**

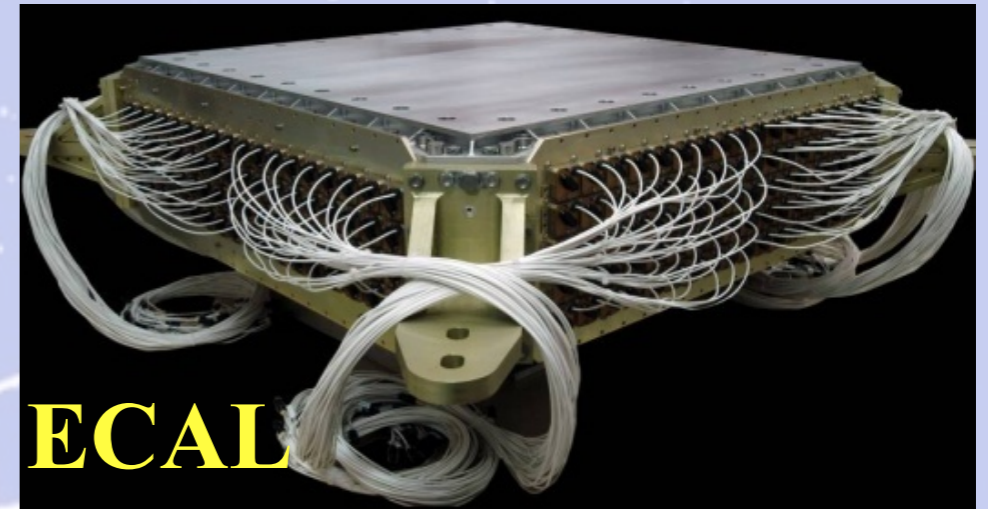

**80 Temperature Sensors**

**TOF & ACC**



**64 Temperature Sensors**

**Magnet**

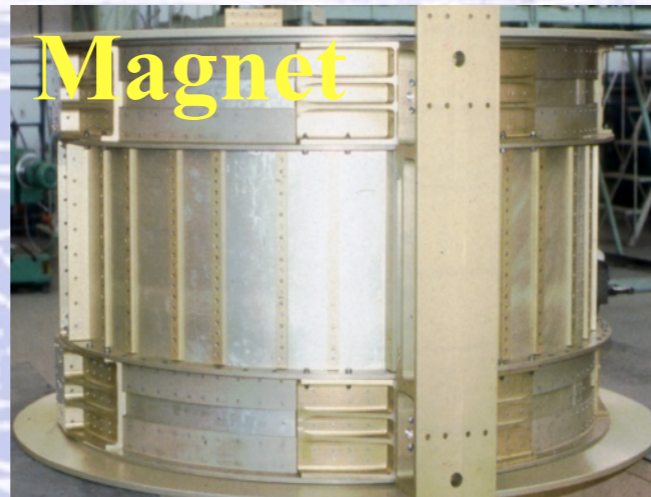

**68 Temperature Sensors**

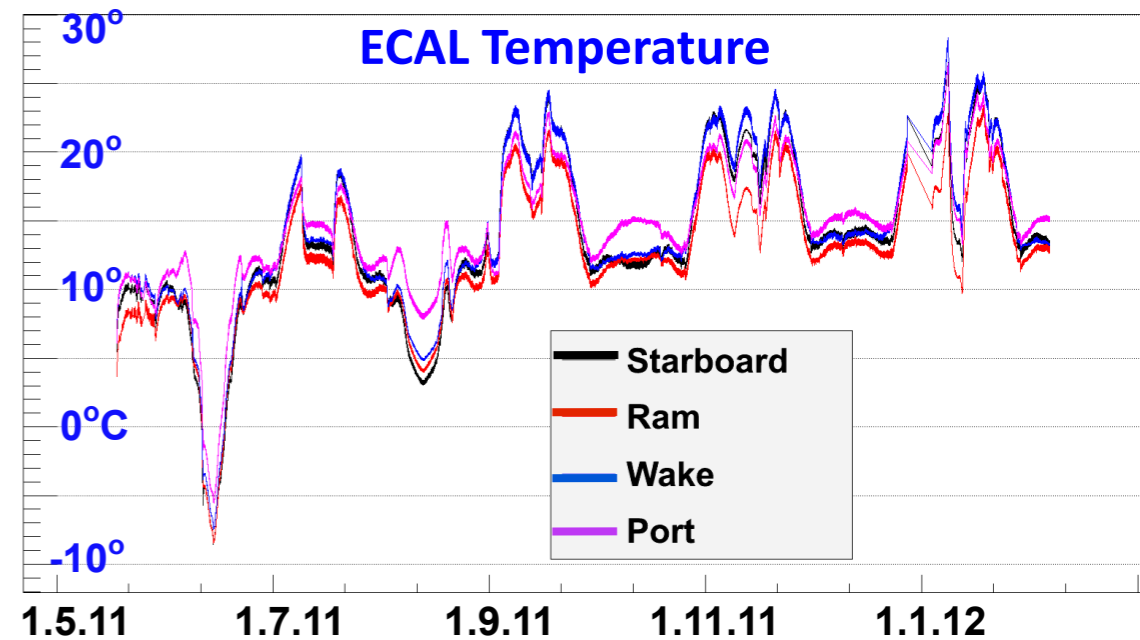

**RICH**



**96 Temperature Sensors**

Over **1,100** temperature sensors and **298** heaters are monitored around the clock in the AMS POCC to assure components stay within thermal limits and avoid permanent damage.

The background of the slide is a light blue color with a complex pattern of white lines and dots. These lines represent particle tracks, with some forming spirals and others being straight or slightly curved. The dots are scattered throughout, representing individual particles or interaction points.

# Appendice 2

(Un po' di teoria)



# Particle Physics Timeline

For over two thousands years people have thought about fundamental particles from which all matter is made.

Starting with the gradual development of atomic theory, followed by a deeper understanding of the quantized atom, leading to the recent theory of the Standard Model.



Earliest times - 1550 AD: The Ancients



1550 - 1900 : The Scientific Revolution and Classical Mechanics

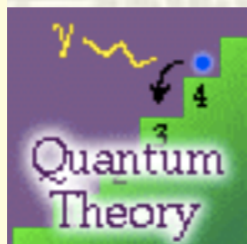

1900 - 1964 : Quantum Theory



1964 - Present: The Modern View (the Standard Model)

# The (ad hoc) Higgs Mechanism (a model without dynamics)

EW symmetry breaking is described by the condensation of a scalar field

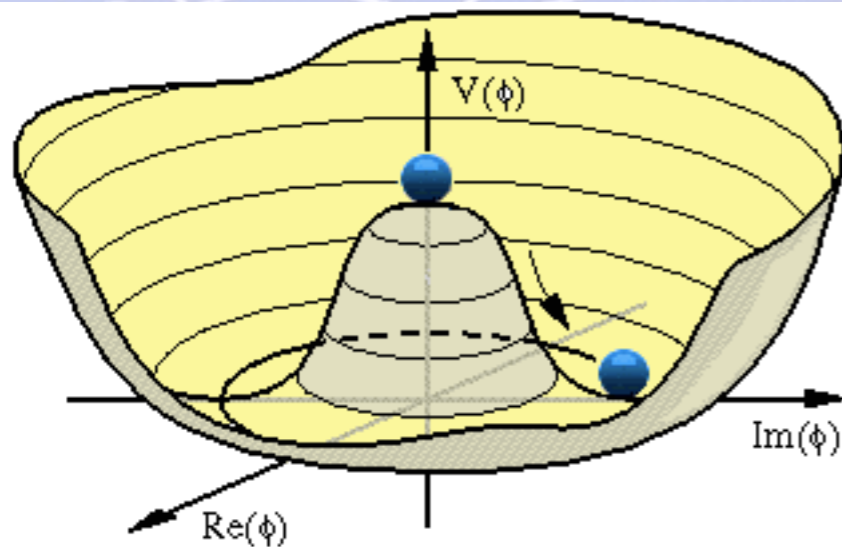
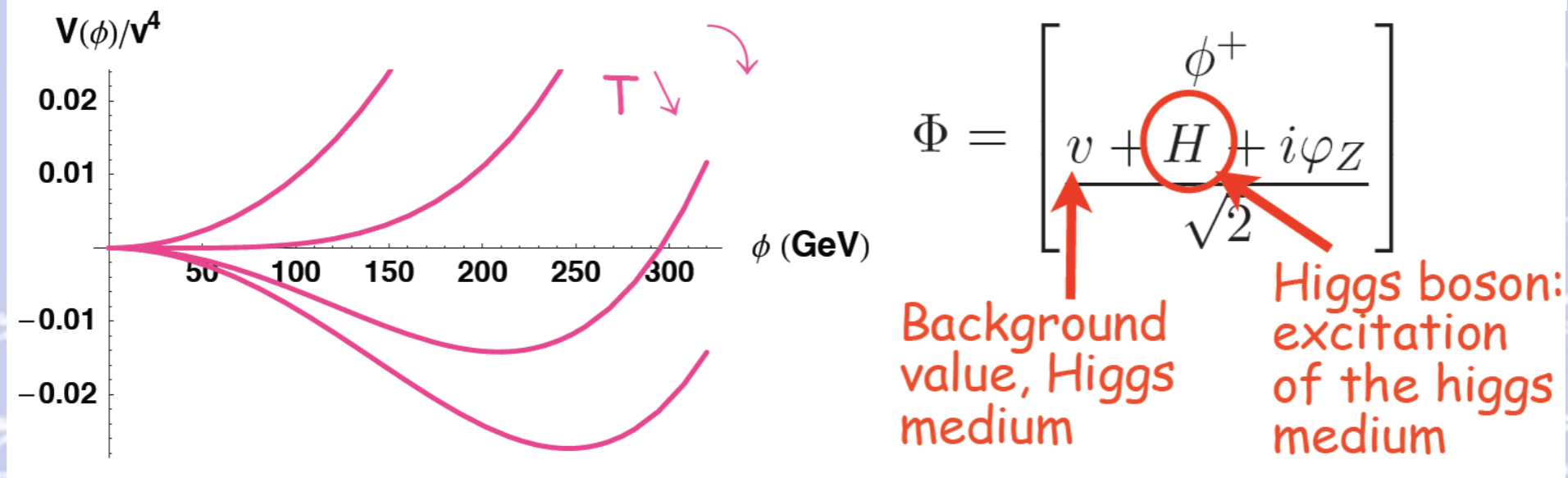

$$V(\Phi) = \frac{\mu^2}{2} \Phi^\dagger \Phi + \frac{\lambda}{4} (\Phi^\dagger \Phi)^2 \quad \text{Why is } \mu^2 \text{ negative?}$$

The Higgs selects a vacuum state by developing a non zero background value.

When it does so, it gives mass to SM particles it couples to.

**We do not know what makes the Higgs condensate.  
We ARRANGE the Higgs potential so that the Higgs condensates but this is just a parametrization that we are unable to explain dynamically.**

# $D^0$ meson decay at LHCb

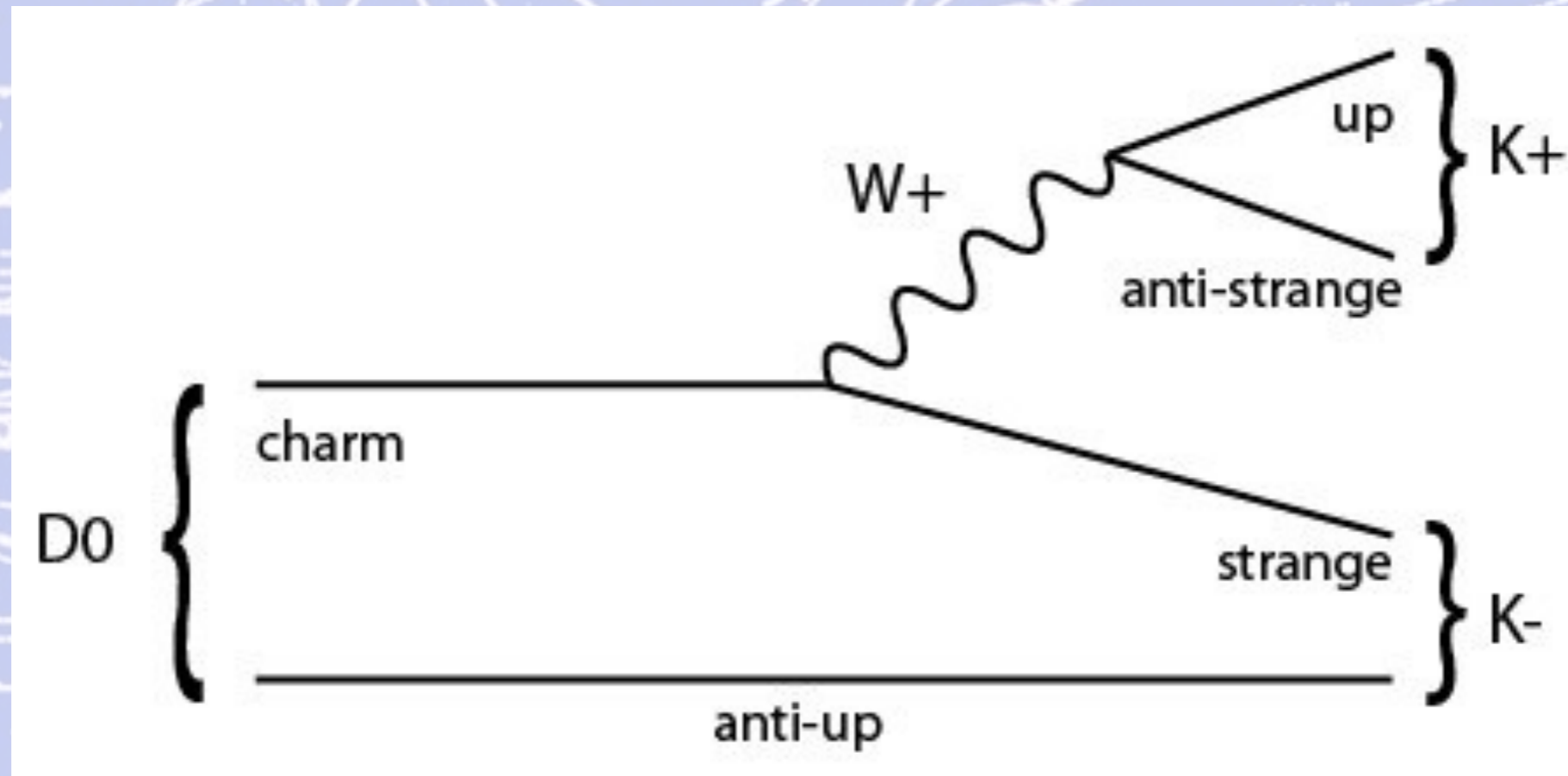



# Appendice 3

(I raggi cosmici)

# Abundance of different particles ( $\rightarrow$ *identification*)

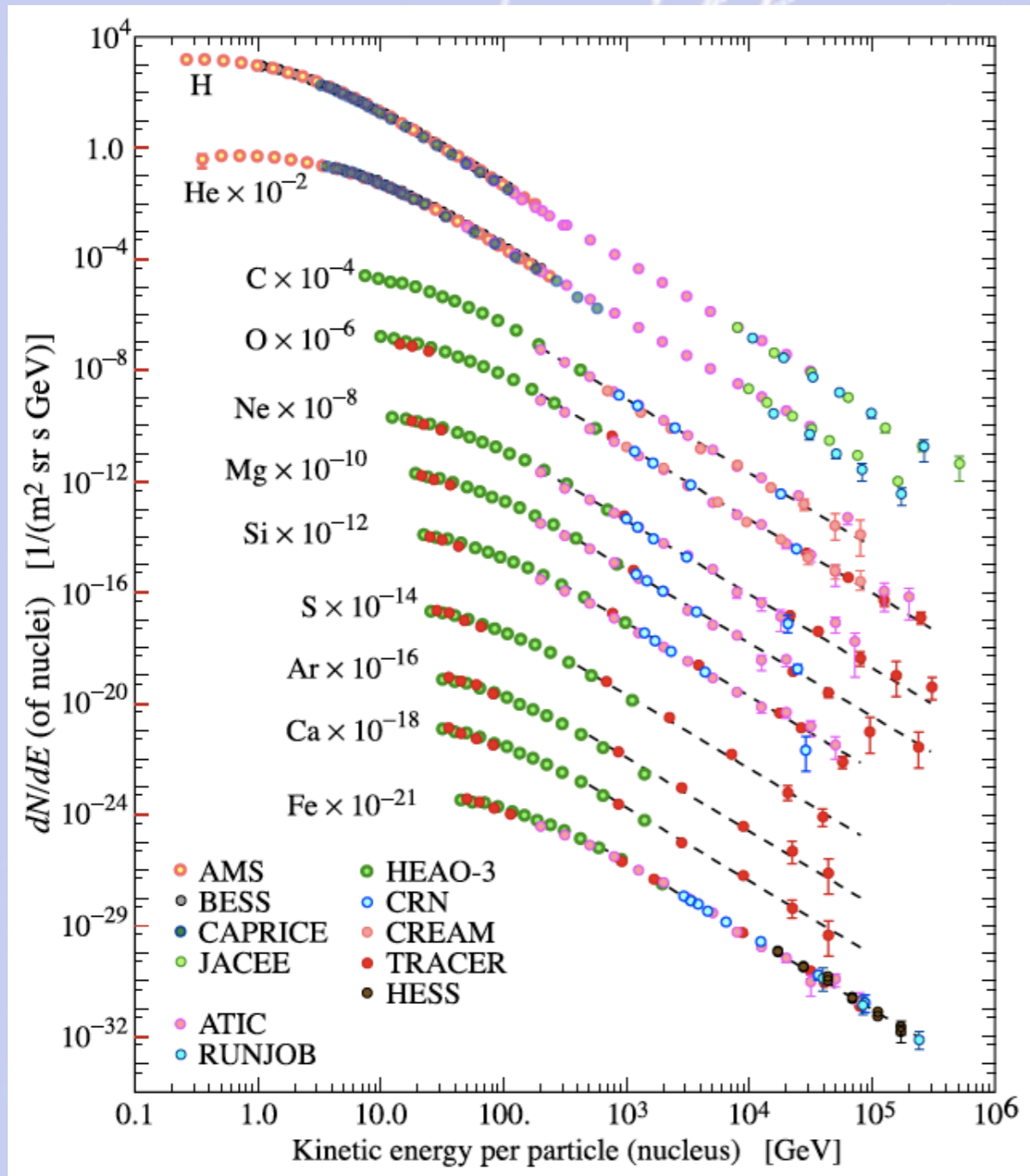

# Abundance of different nuclei (elements)

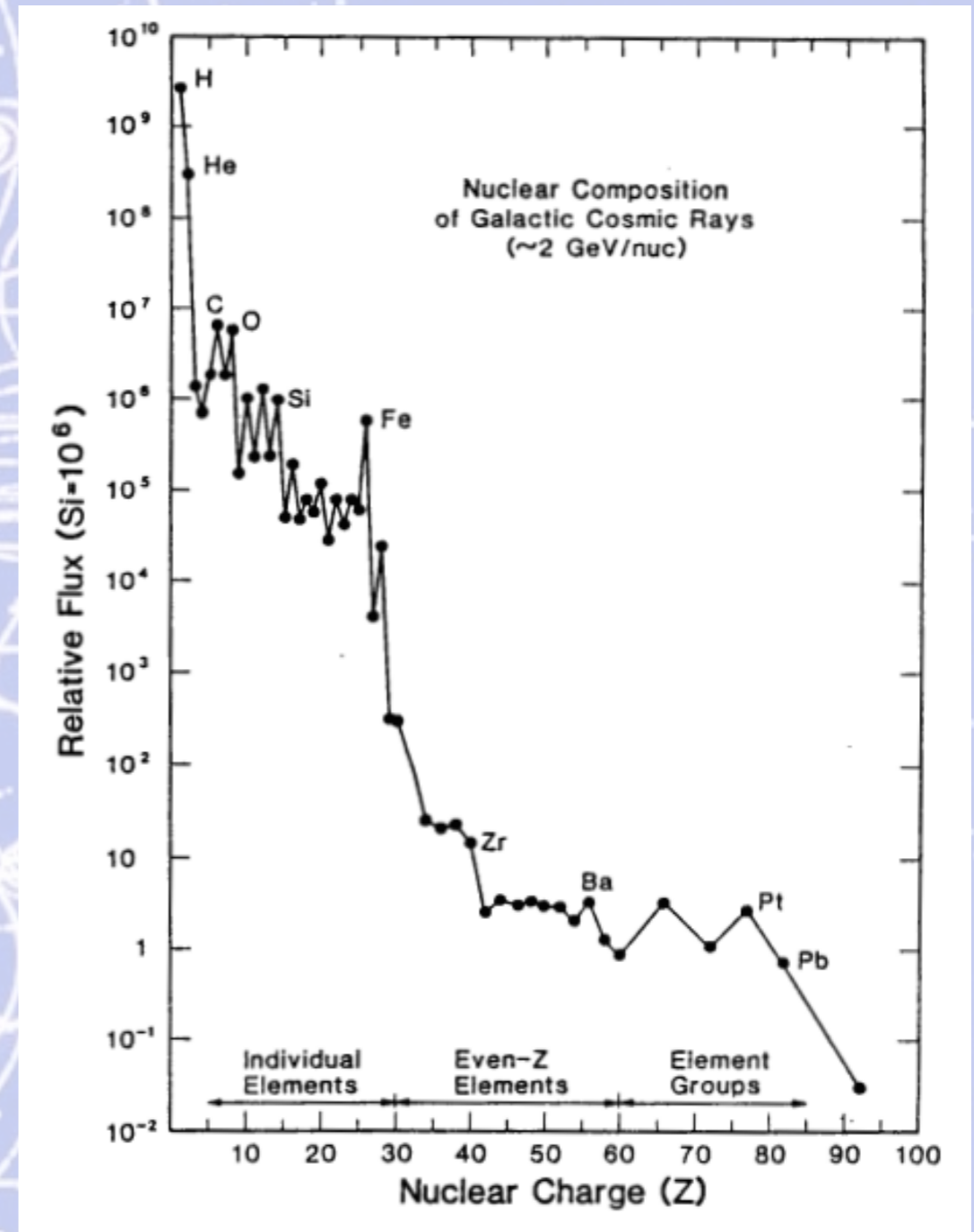

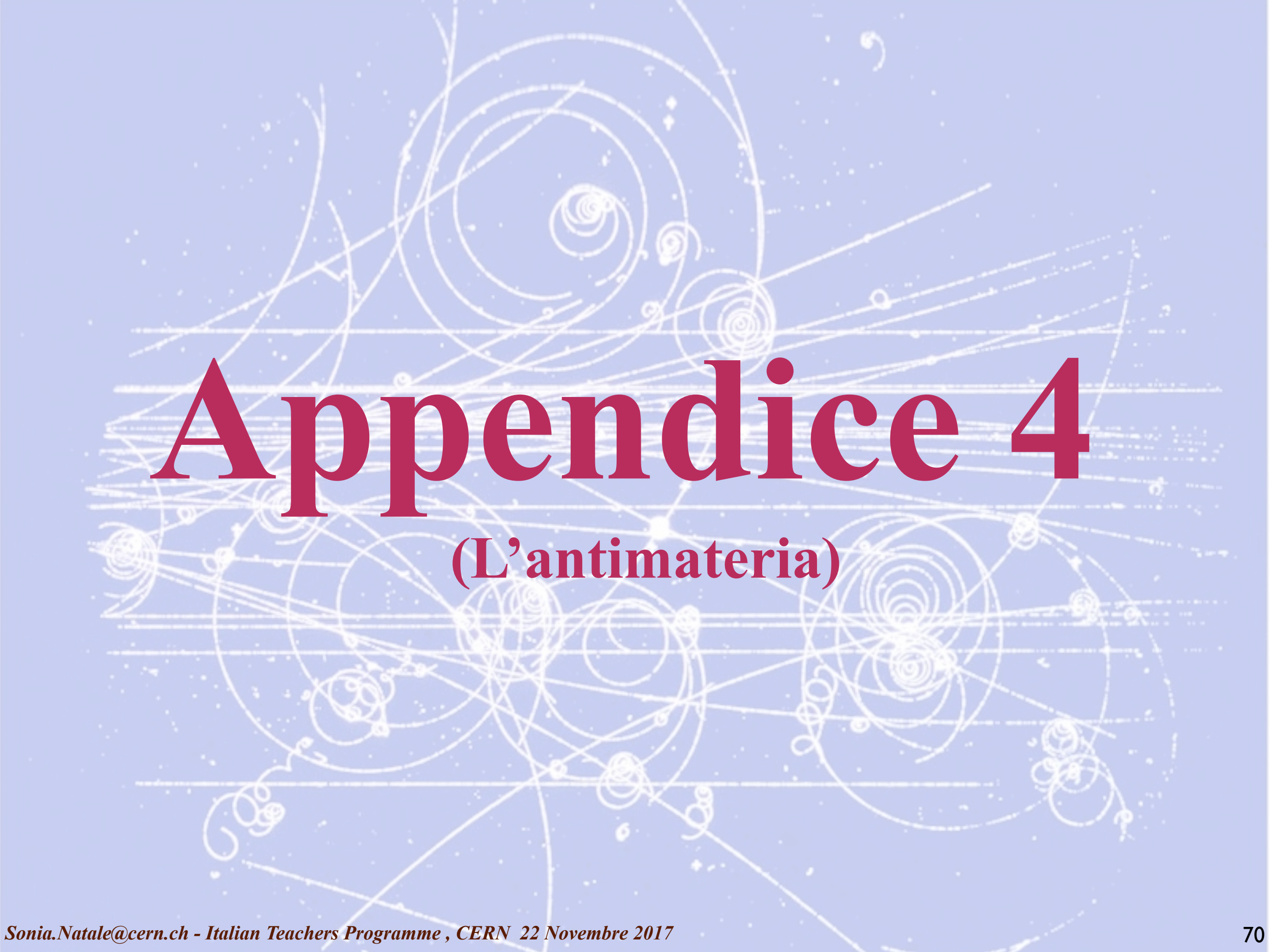
The background features a complex pattern of white lines on a light blue field, resembling particle tracks or a network diagram. The lines are of varying thickness and form, including straight lines, spirals, and overlapping loops. Some lines are solid, while others are dashed. The overall effect is that of a dynamic, interconnected system.

# Appendice 4

(L'antimateria)

# Physics of AMS: Search for Antimatter

in space

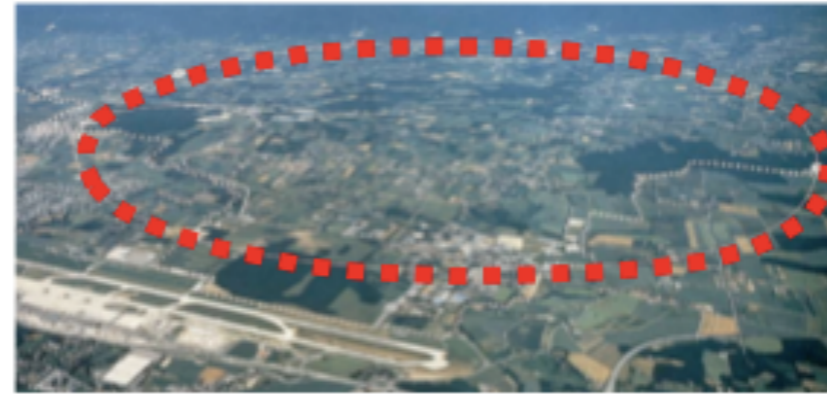

The Big Bang origin of the Universe requires Matter and Antimatter to be equally abundant at the very beginning

# Physics of AMS: Search for Antimatter Universe

## Experimental work on Antimatter in the Universe

Direct  
search

Search for  
Baryogenesis

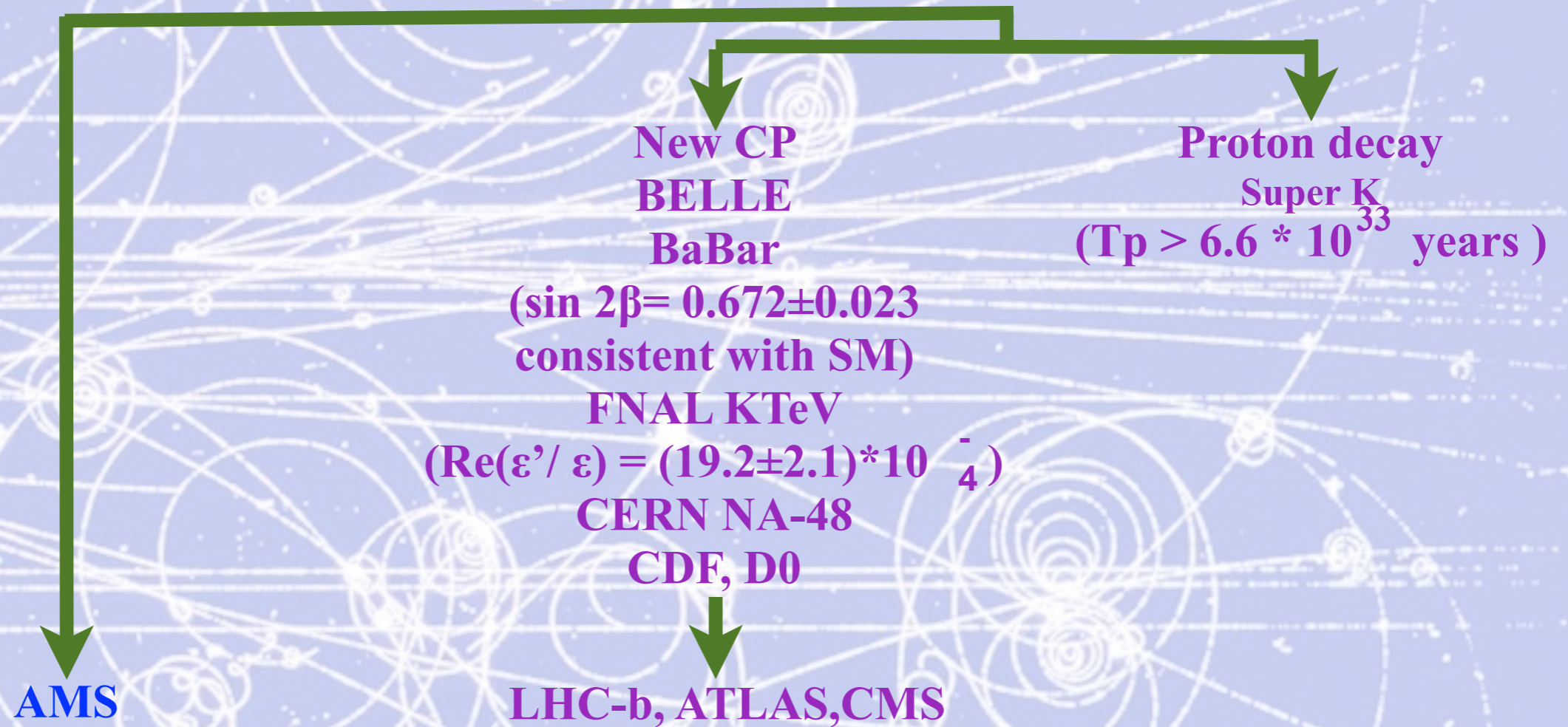

Increase in sensitivity:  $\times 10^3 - 10^6$   
Increase in energy to  $\sim \text{TeV}$

No explanation found for the absence  
of antimatter (no reason why  
antimatter should not exist)



# Are Dark Matter and baryon abundances related ?

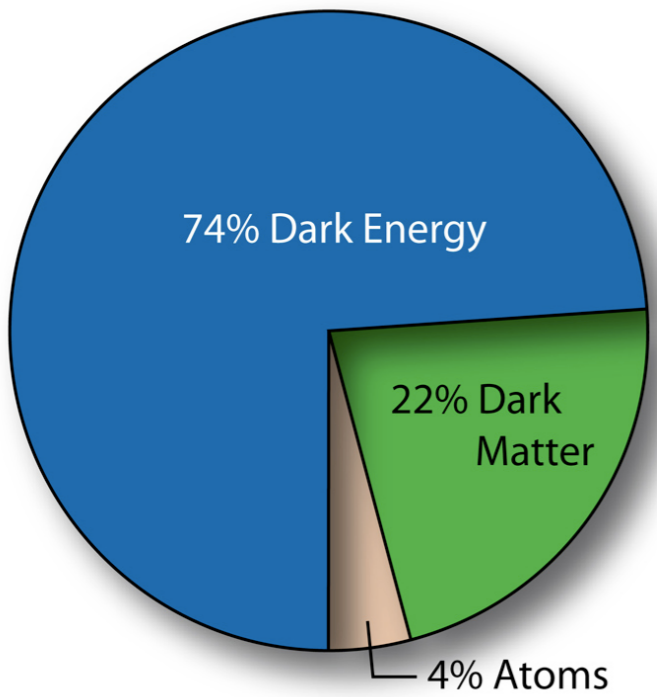

## Sakharov's conditions for baryogenesis (1967)

- 1) **Baryon number violation**  
(we need a process which can turn antimatter into matter)
- 2) **C (charge conjugation) and CP (charge conjugation × Parity) violation.**  
(we need to prefer matter over antimatter)
- 3) **Loss of thermal equilibrium**  
(we need an irreversible process since in thermal equilibrium, the particle density depends only on the mass of the particle and on temperature, particles & antiparticles have the same mass , so no asymmetry can develop)

Baryonic asymmetry characterized in terms of the baryon to photon ratio

$$\frac{n_B - \bar{n}_B}{n_\gamma} \sim 6 \times 10^{-10}$$

$$\Omega_{DM} \approx 5-6 \Omega_{baryons}$$

if  $n_{DM} - \bar{n}_{DM} \sim n_B - \bar{n}_B$

$$\frac{\Omega_{DM}}{\Omega_{baryons}} \sim C \frac{m_{DM}}{m_{baryons}}$$

Does this indicate a common dynamics?

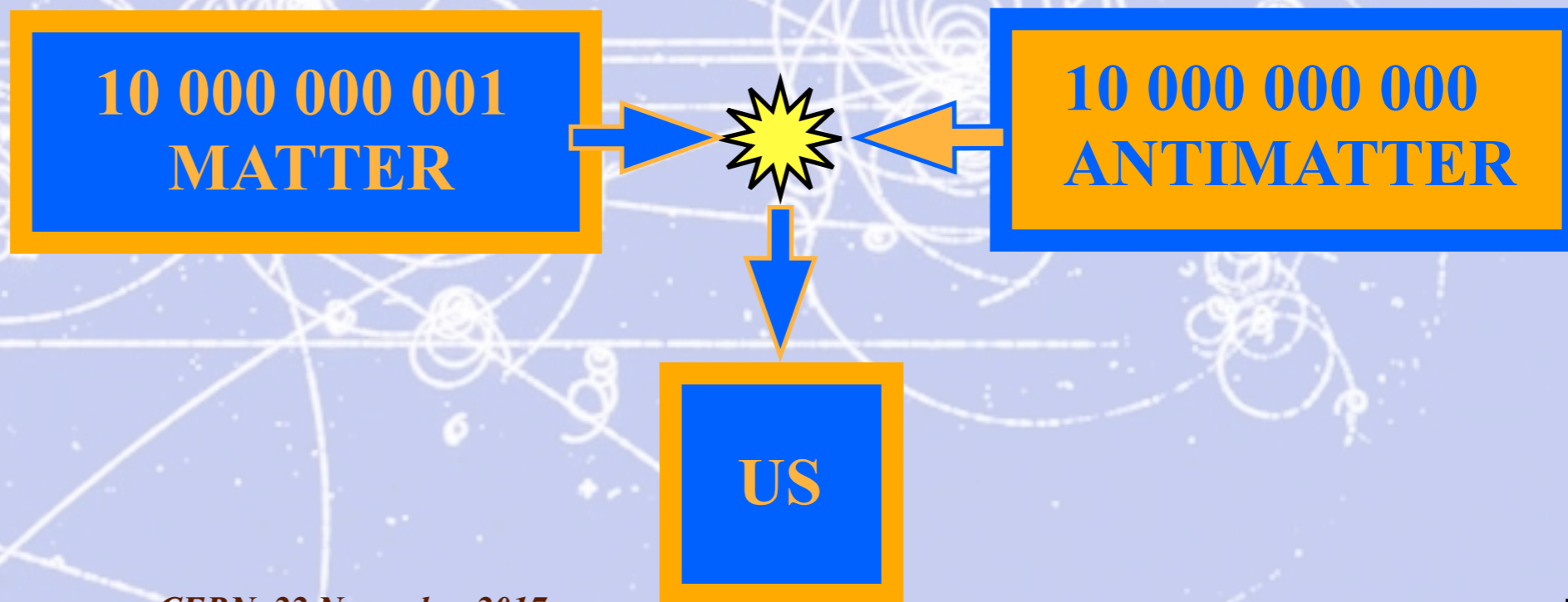

The background of the slide is a light blue color with a complex pattern of white lines. These lines represent particle tracks, consisting of various shapes such as spirals, circles, and straight lines, some of which are interconnected. The overall appearance is that of a scientific visualization, possibly from a particle detector.

# Appendice 5

(Rapporto Boro/Carbonio)

# Carbon Fragmentation to Boron in Upper TOF

## Rigidity 10.6 GV

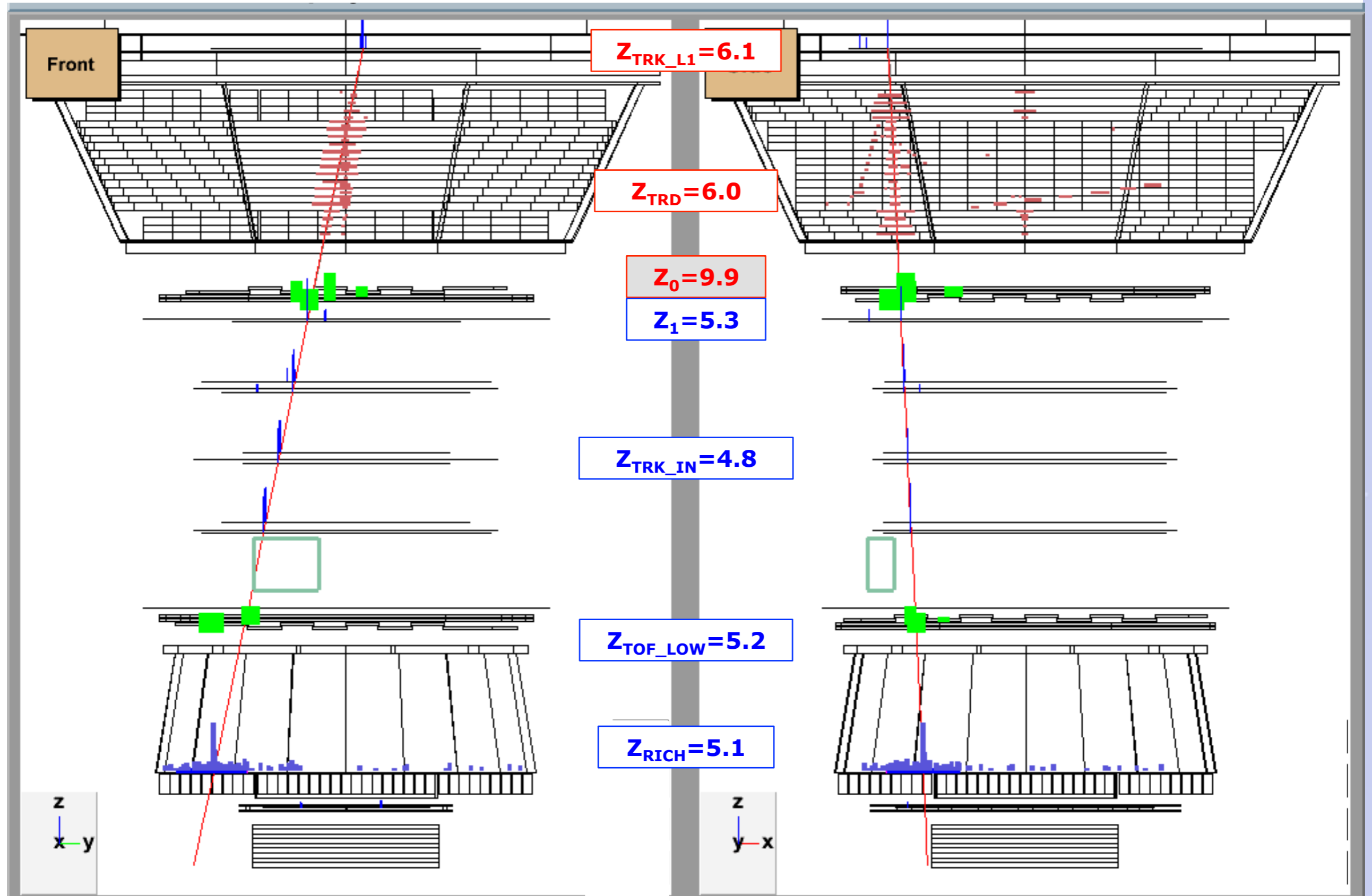

The background of the slide is a deep blue space filled with numerous white star trails of varying lengths and directions. Several prominent spiral galaxies are visible, their arms winding outwards. The overall effect is a sense of vastness and cosmic activity.

# Appendice 6

(La materia Oscura)

# Dark Matter

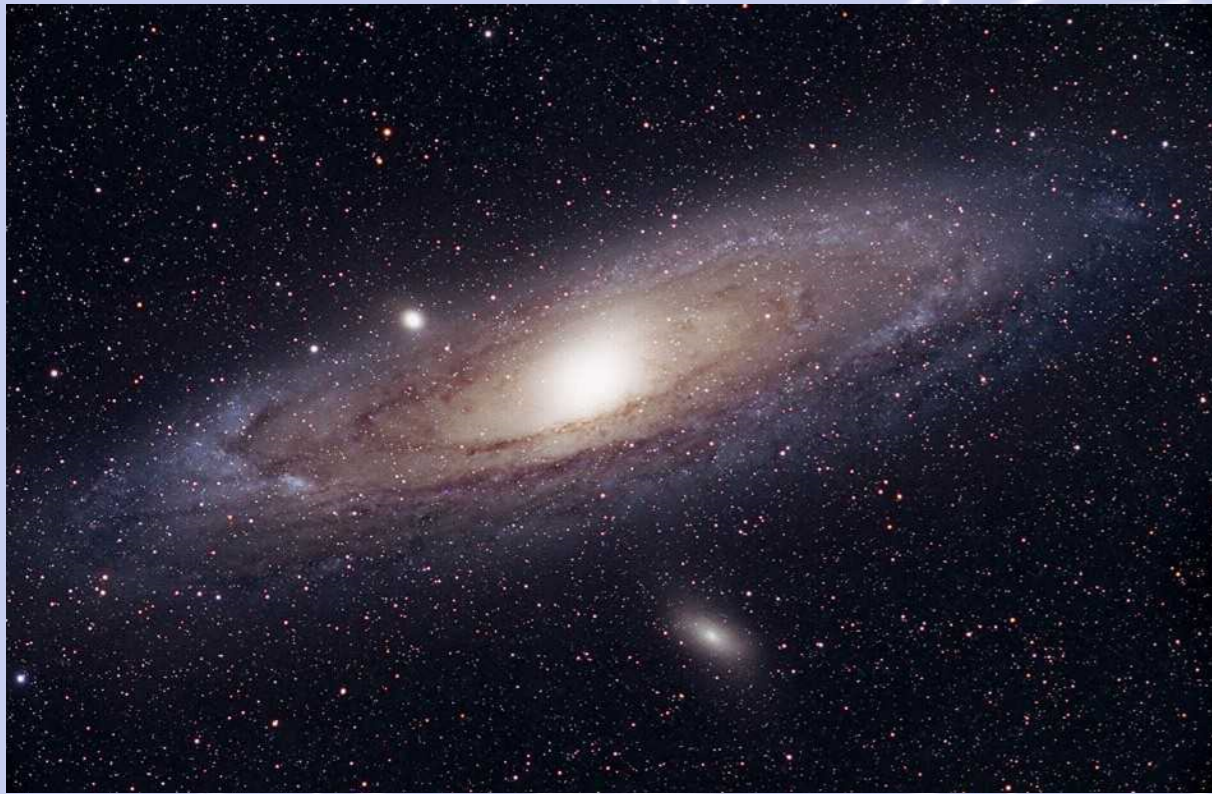

The velocity of stars lying at galaxies periphery indicate that there is much more matter in the galaxy than what we measure from visible stars.

We don't know the nature of this new kind of matter we can only detect from its gravitational effects.

Several hypothesis exist to explain it.

One of them tells that Dark Matter should be composed by supersymmetric particles not yet detected nowadays.

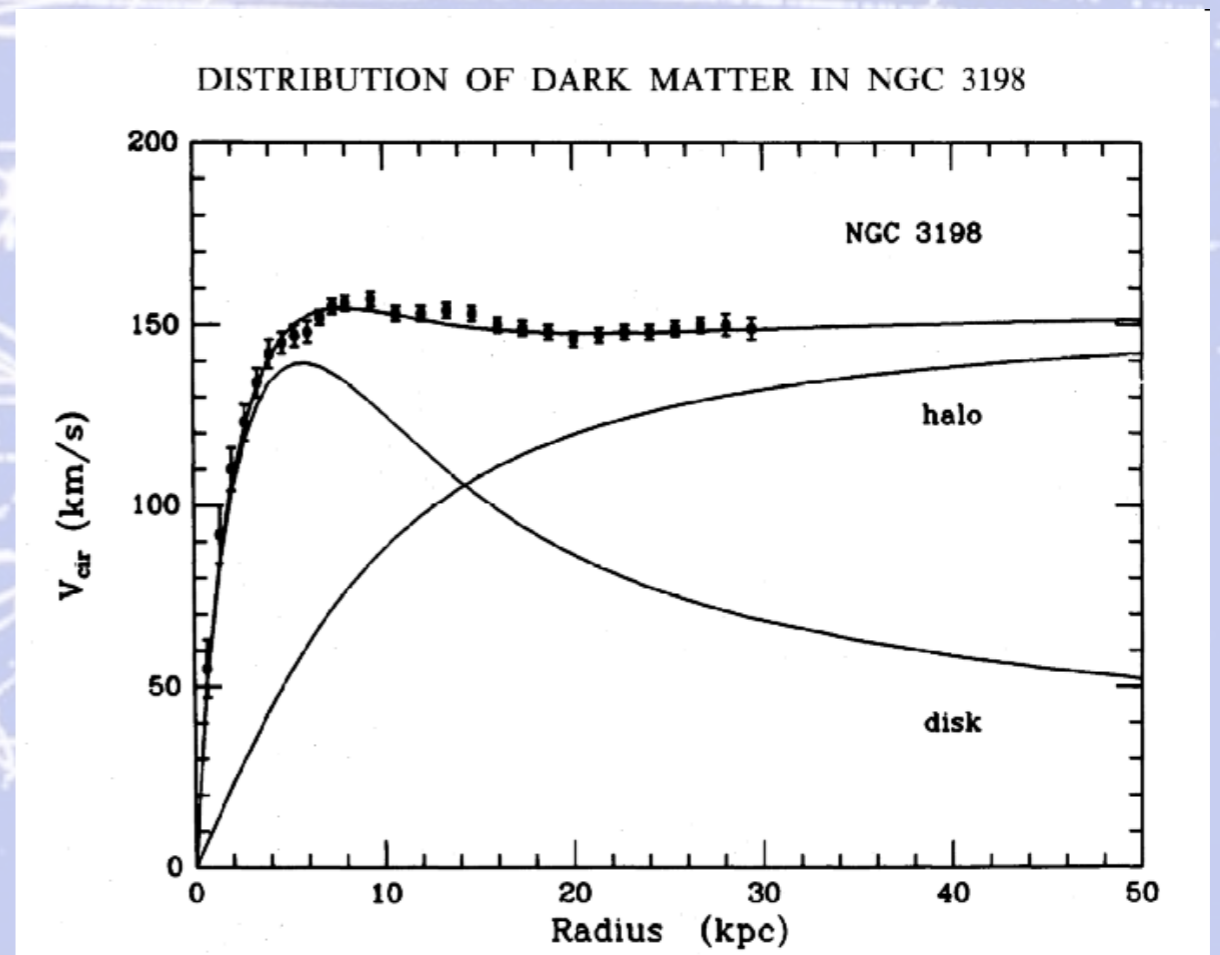

# Dark Matter detection

- **WIMPs**
  - **Neutralinos**
  - **Kaluza-Klein particles**
  - .....
- **Axinos**
- **Super-WIMPs**
- **Axions**
- **Axion-like light bosons**
- **Sterile neutrinos**
- **Q-balls**
- **WIMPzillas**
- **Elementary BHs**

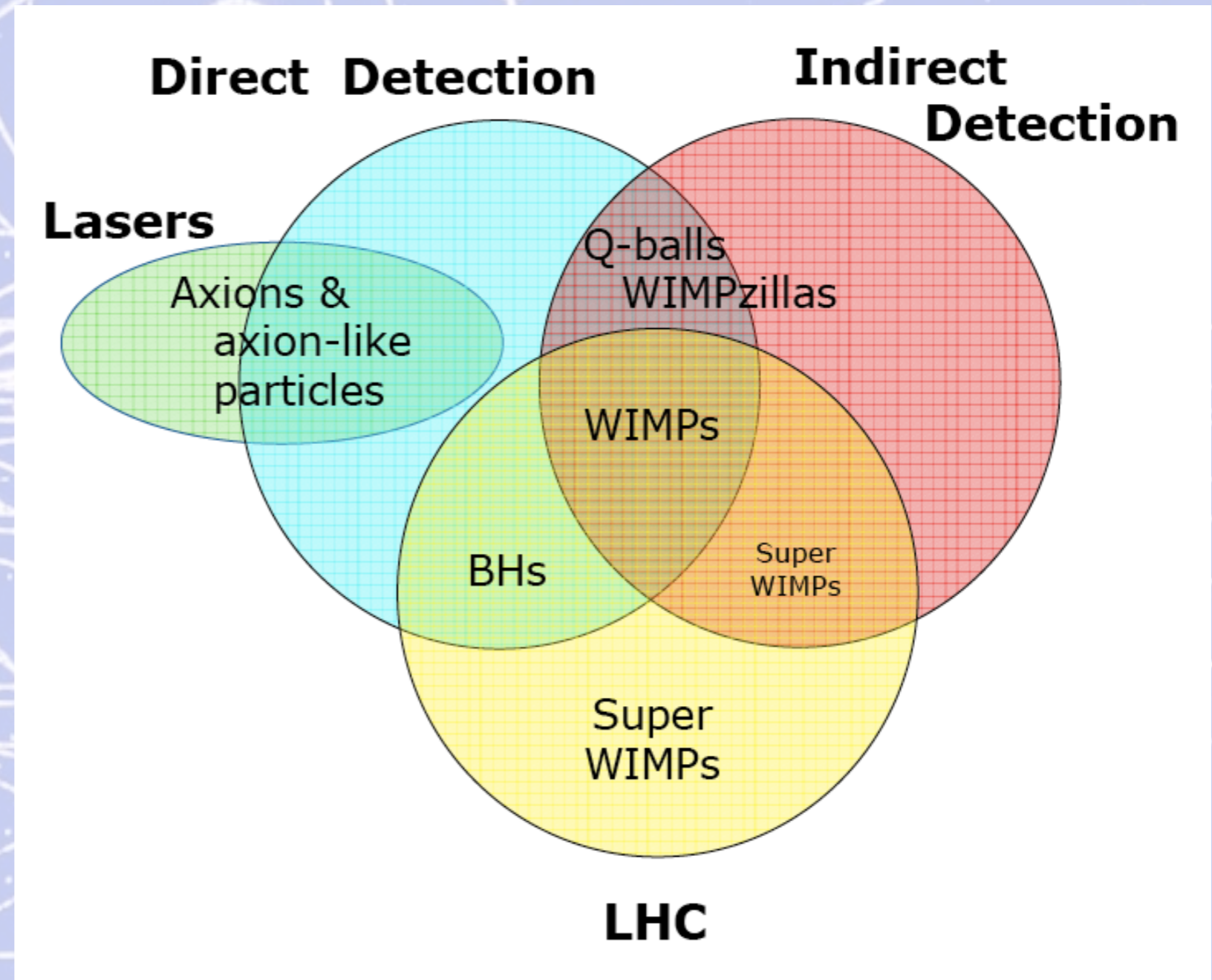

# Ways of detecting dark matter

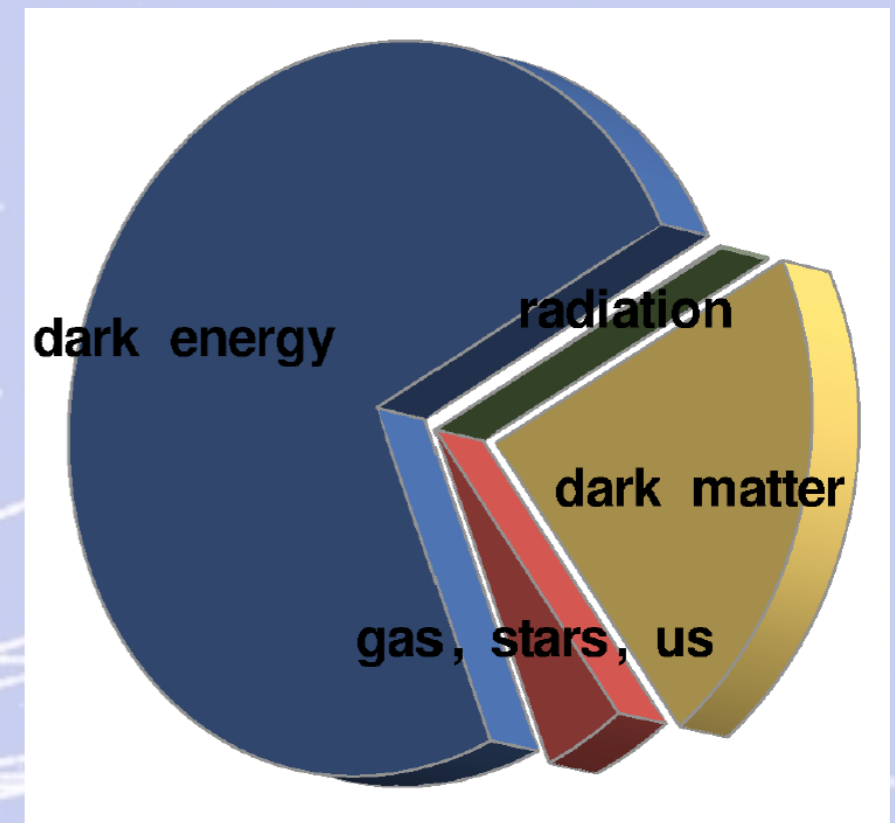
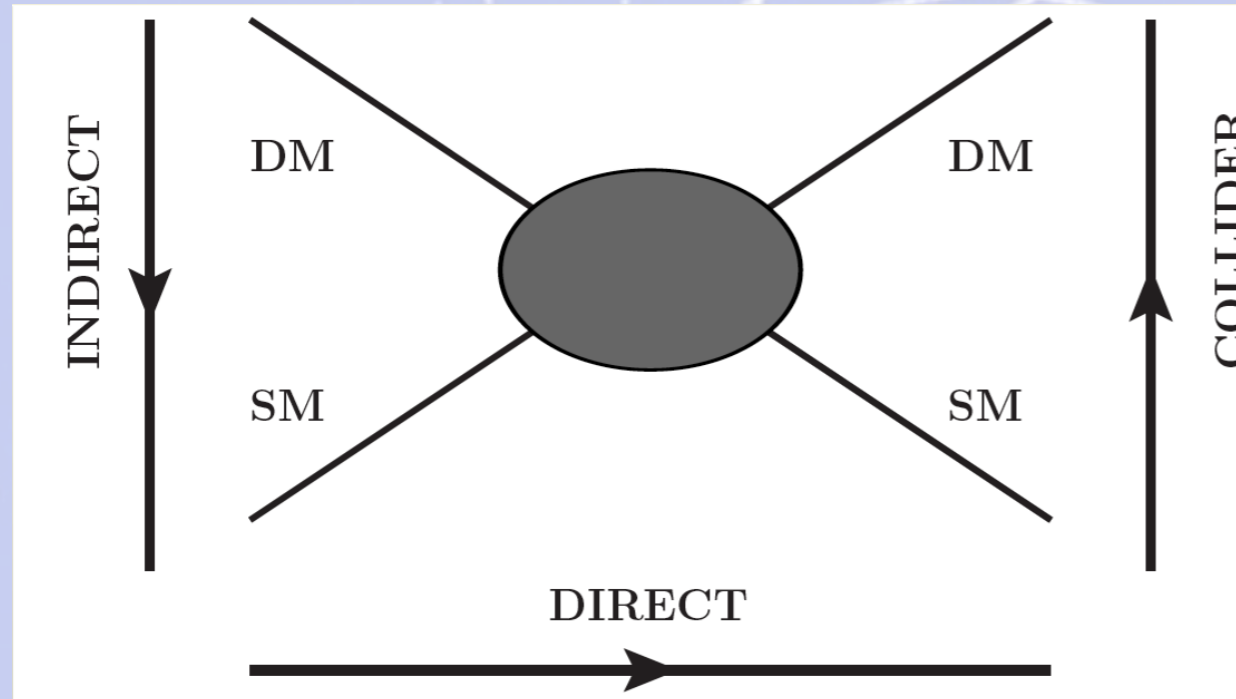

**1 Direct detection.**

**2 Indirect detection: searching for products of annihilation.**

**High energy photons**

- Space telescopes: COMPTEL, Fermi-LAT, AMS

- ACTs: HESS, Veritas, Magic.

**Electrons/positrons:** PAMELA, ATIC, Fermi-LAT, AMS, HESS, MAGIC.

**Antiprotons:** PAMELA, AMS.

**Neutrinos:** ANTARES, IceCube.

**3 Collider searches: LHC.**

**4 Indirect2: CMB optical depth and anisotropies, IGM temperature and 21 cm - recombination and reionization observables, BBN.**

# Dark Matter: neutralino annihilation

Lets suppose the existence of massive particles ( $\chi$ ) which are their own anti-particles.  
If they meet they annihilate producing other particles and anti-particles  
thanks to the available energy.

As a consequence, the cosmic rays  
spectrum will be modified.  
These anomalies can be searched in  
positrons or anti-protons spectra.

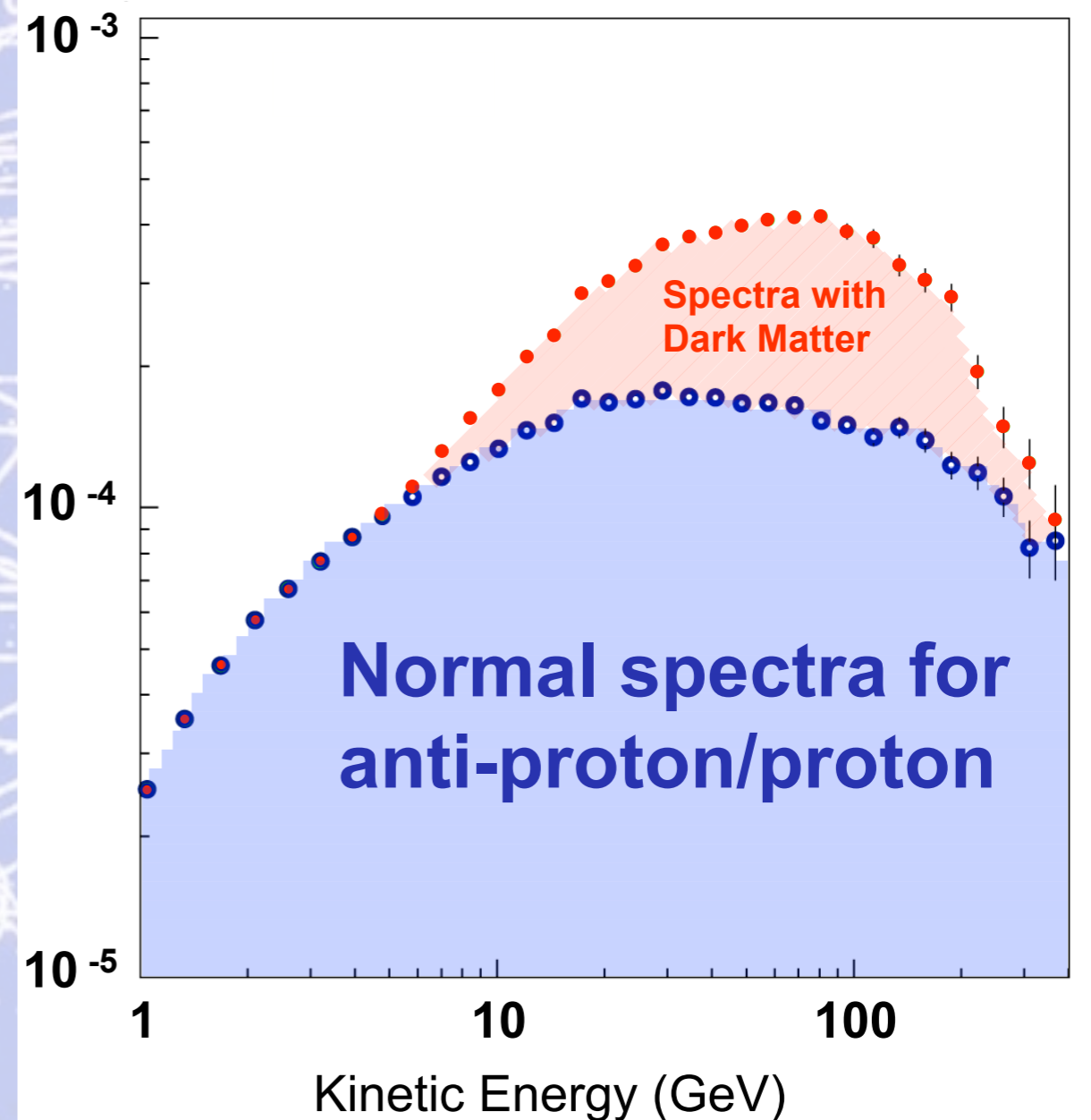
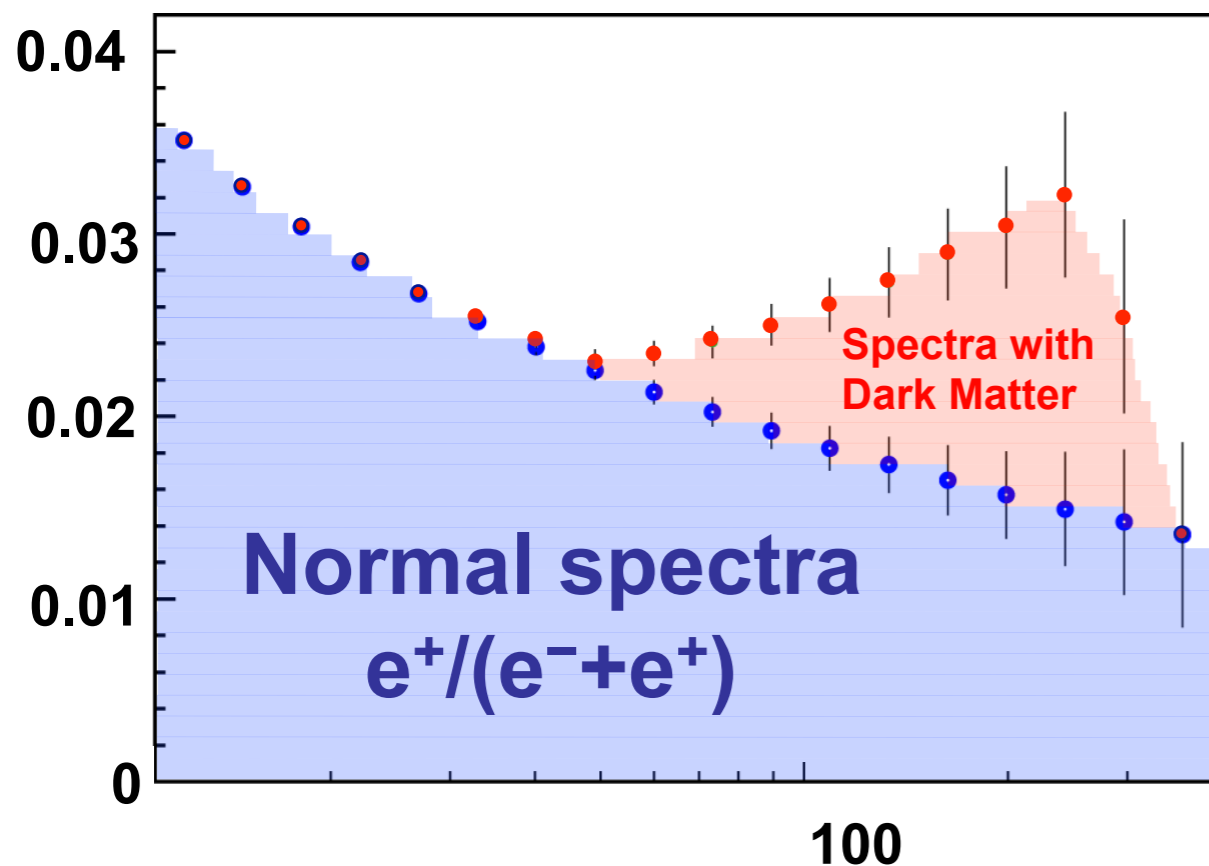



# Physics of AMS: Search for Dark Matter

The lightest Kaluza-Klein state is an excellent dark matter candidate if standard model particles propagate in extra dimensions (universal extra dimensions)

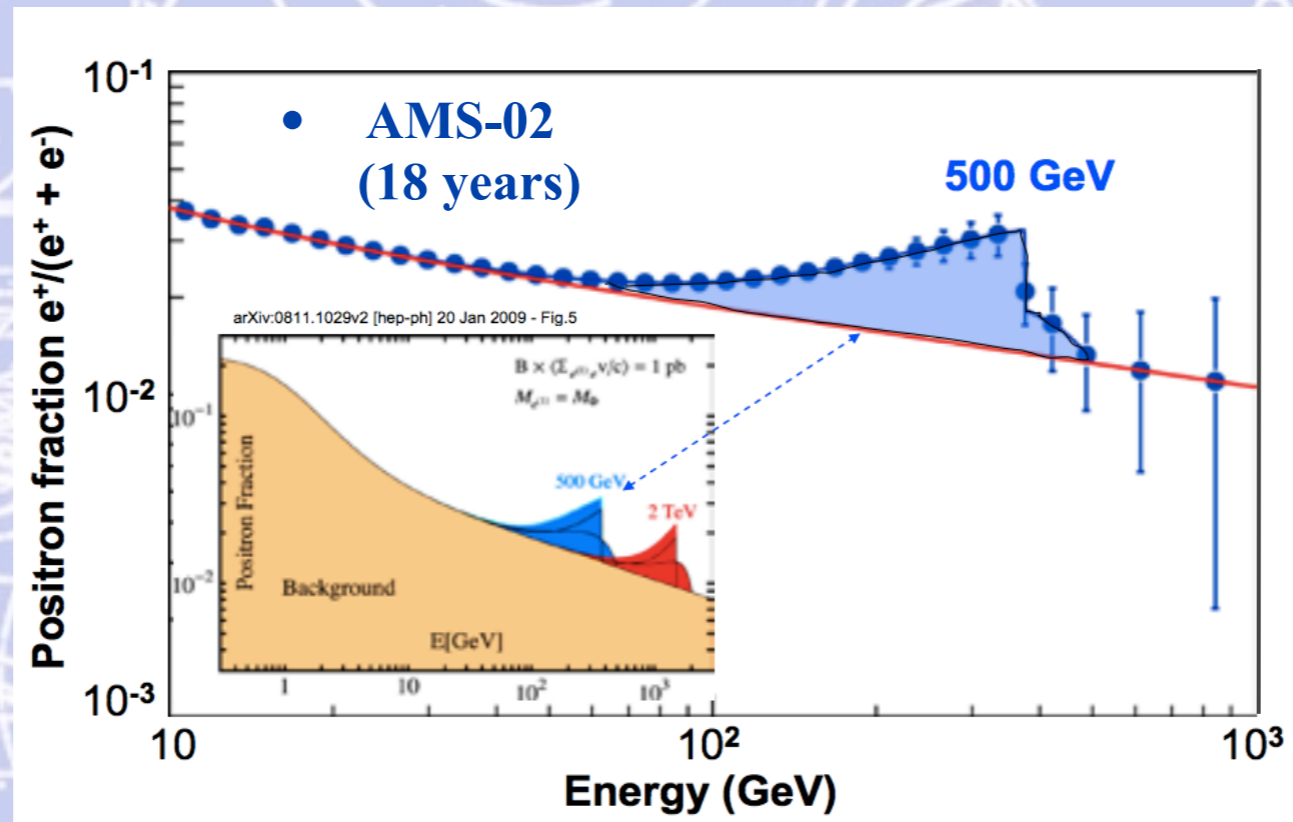

Expected spectrum from collisions of 500 GeV Kaluza-Klein bosons based on Pontón and Randall model

E.Pontón and L.Randall, preprint  
arXiv:0811.1029v2 (2009)

# Un esempio di modello (1)

**Theoretical models to explain the AMS positron fraction.**

**Among the 100's of models there are three classes:**

- a) dark matter
- b) new forms of propagation
- c) pulsars.

**b) An example of new propagation:**

R. Cowsik, B. Burch, and T. Madziwa-Nussinov, *Ap. J.* 786 (2014) 124

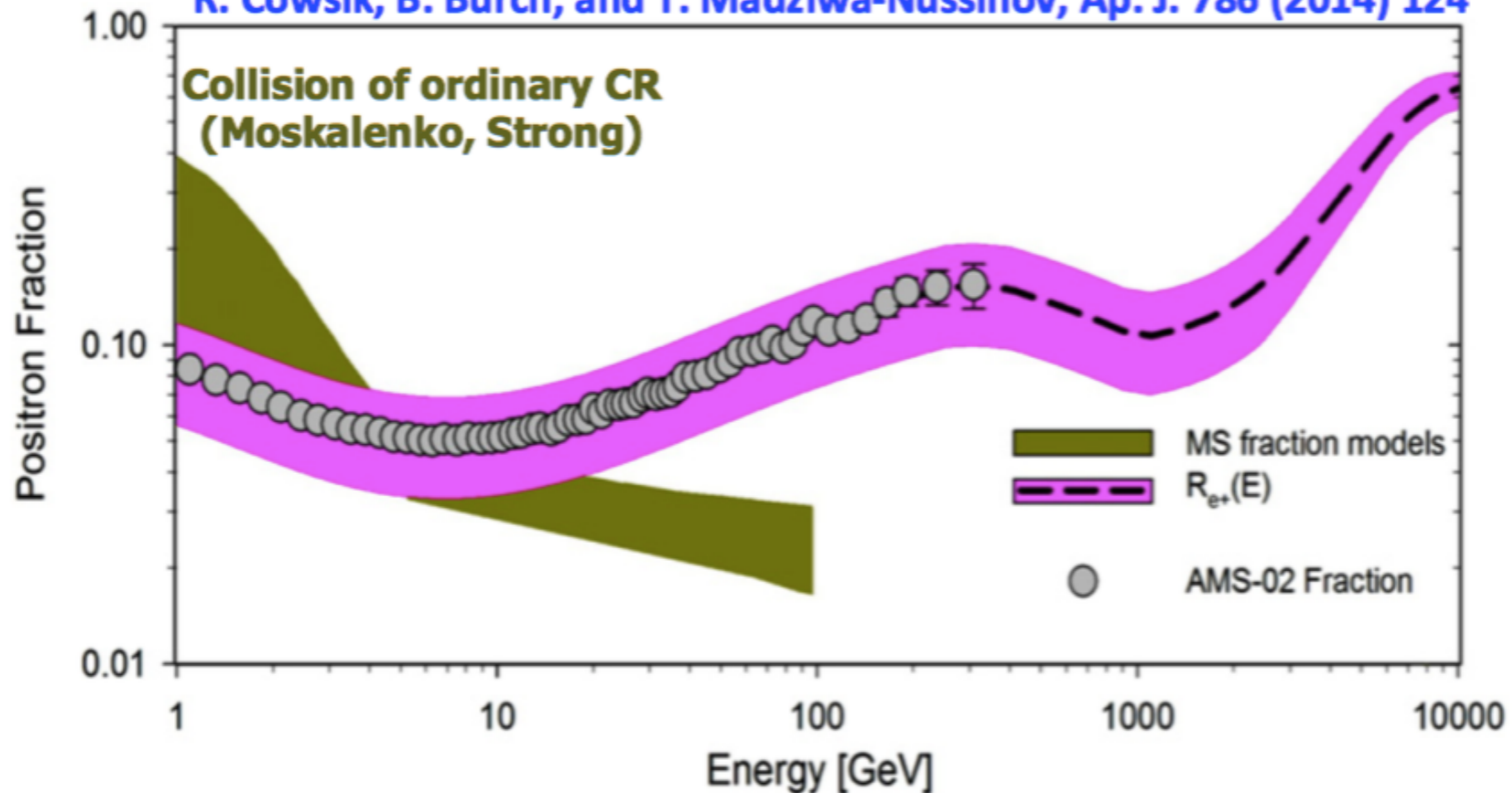

# Un esempio di modello (2)

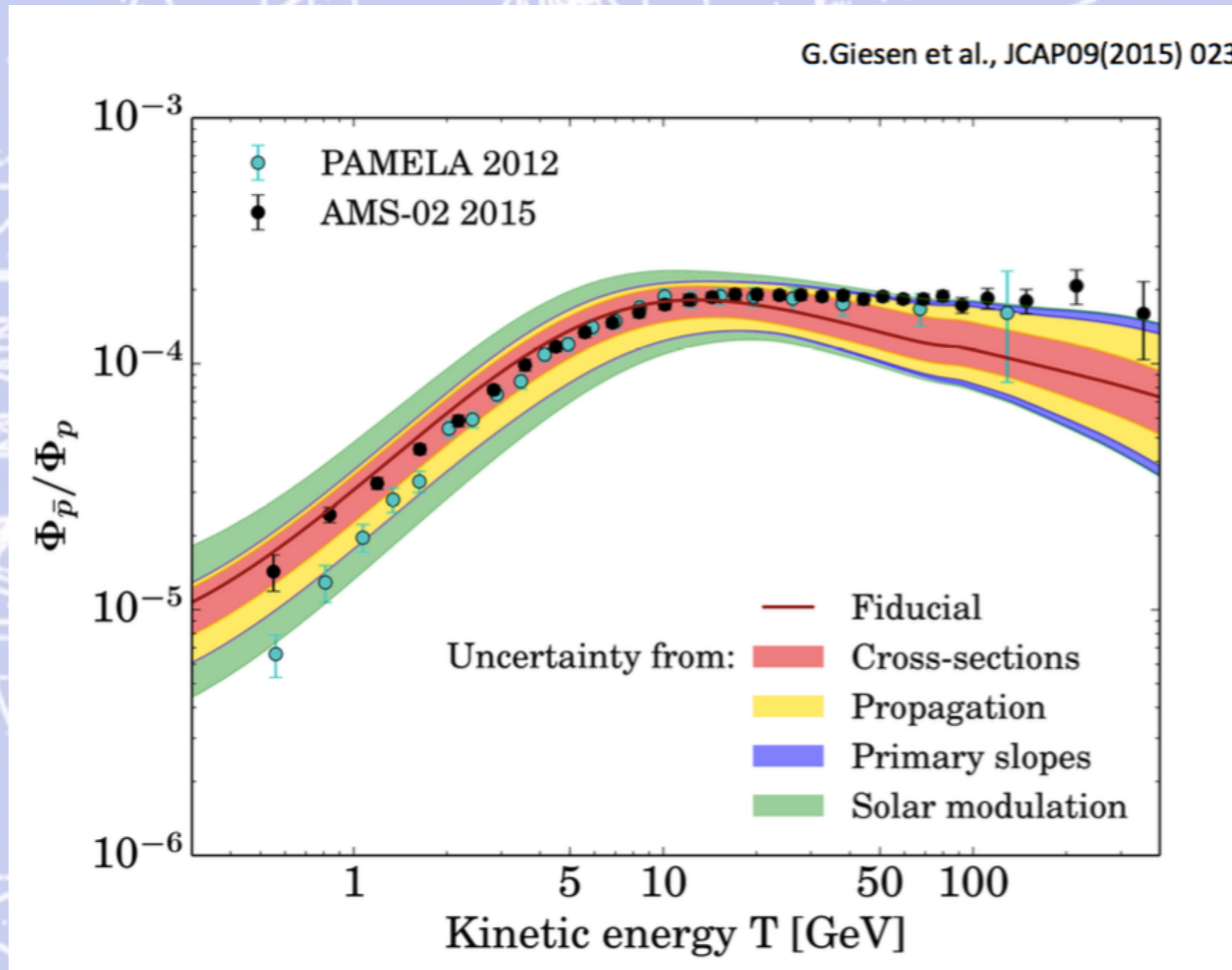

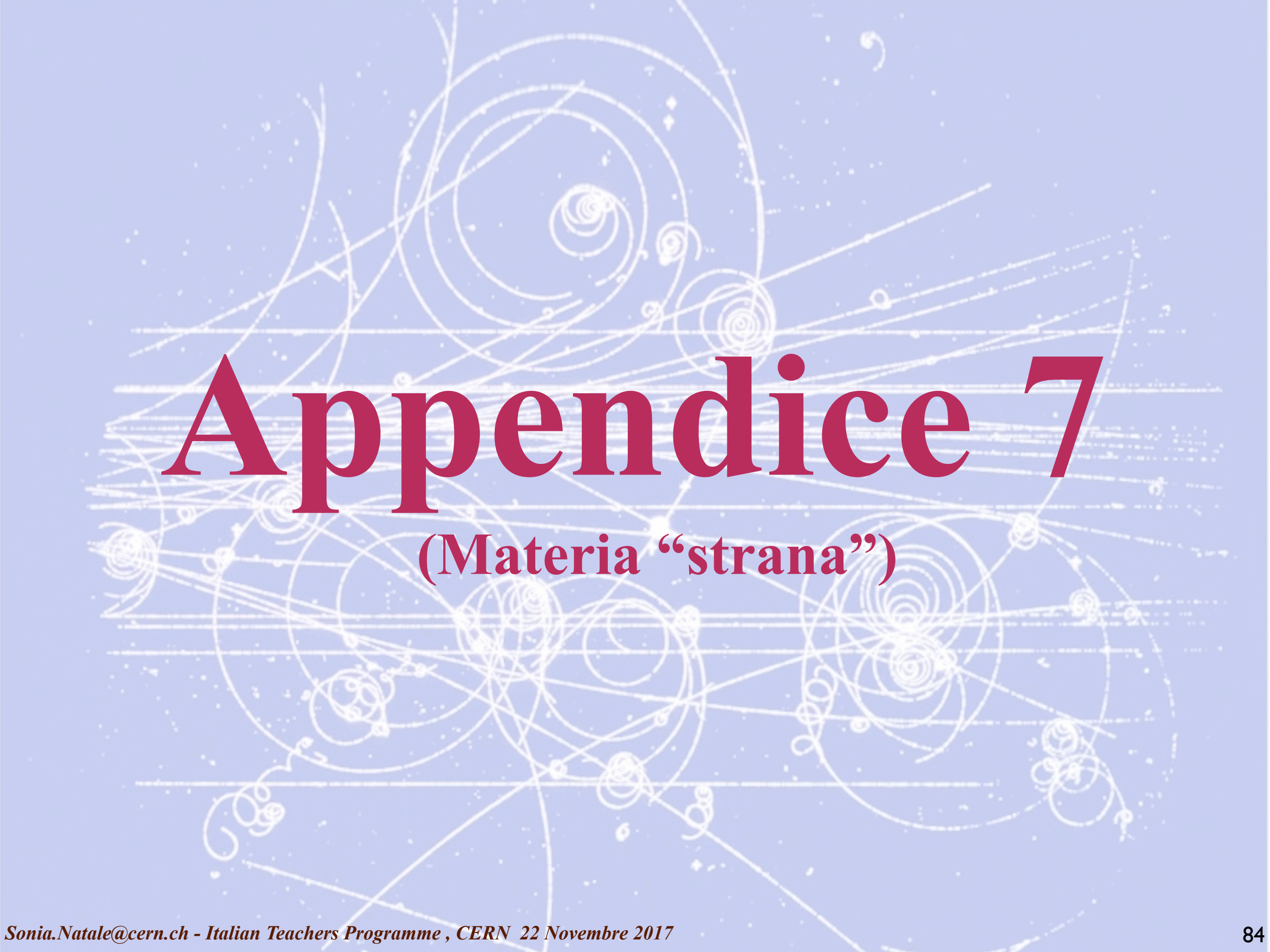

# Appendice 7

(Materia “strana”)

# Search for Strangelets

All the known material on Earth is made out of u and d quarks

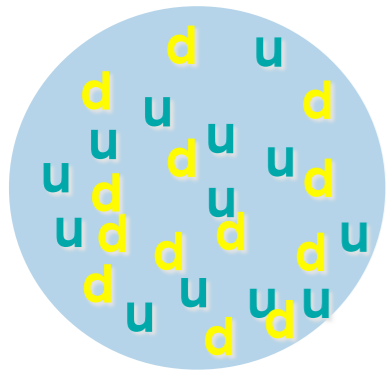

Diamond ( $Z/A \sim 0.5$ )

Is there material in the universe made up of u, d, & s quarks?

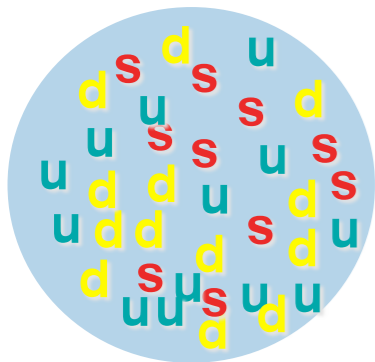

Strangelet ( $Z/A < 0.1$ )

This can be answered definitively by AMS.

Candidate observed with AMS-01  
5 June 1998 11:13:16 UTC

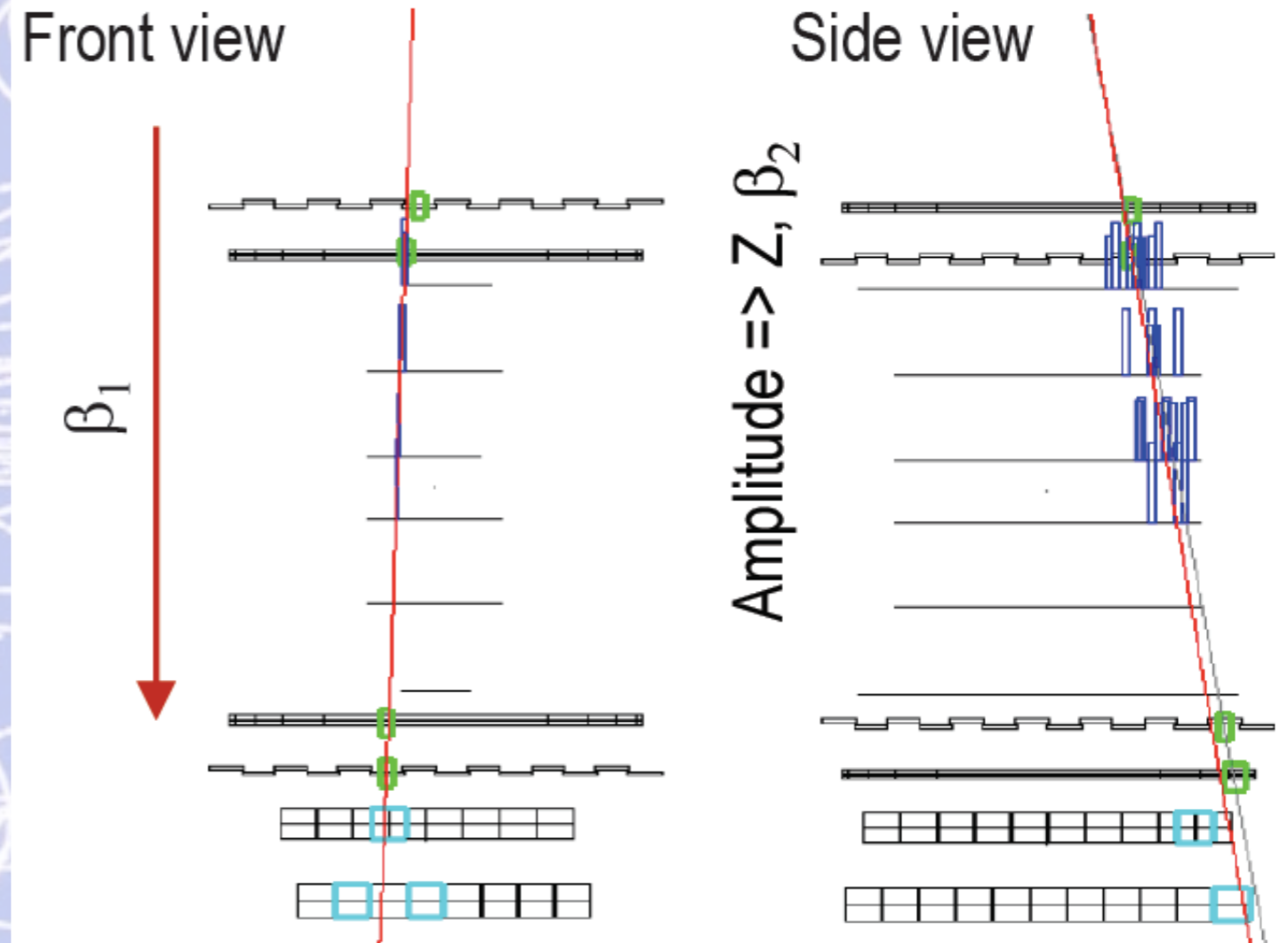

Rigidity =  $4.31 \pm 0.38$  GV

Charge  $Z = 2$

$\beta_1 = \beta_2 = 0.462 \pm 0.005$

Mass =  $16.45 \pm 0.15$  GeV/c<sup>2</sup>

$Z/A = 0.114 \pm 0.01$

Flux ( $1.5 < E_K < 10$  GeV) =  $5 \times 10^{-5}$  (m<sup>2</sup>sr sec)<sup>-1</sup>

# Search for Strangelets

E. Witten, Phys. Rev. D, 272-285 (1984)

Candidate observed with AMS-01  
5 June 1998 11:13:16 UTC

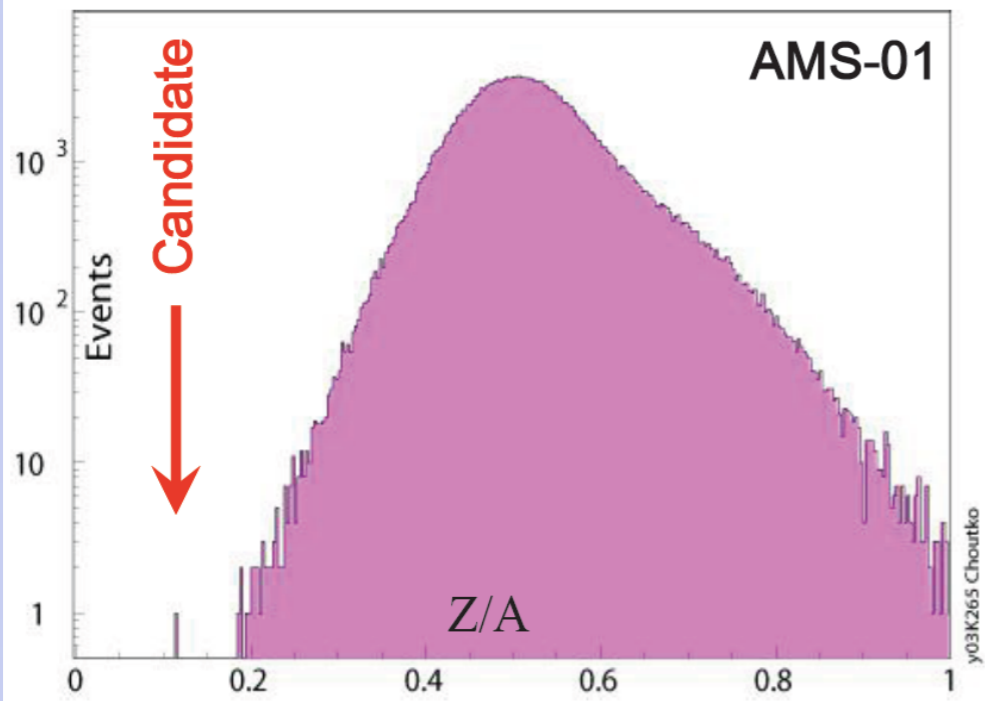

$$\Phi_s = 5 \times 10^{-10} (\text{cm}^2 \text{s sr})^{-1}$$

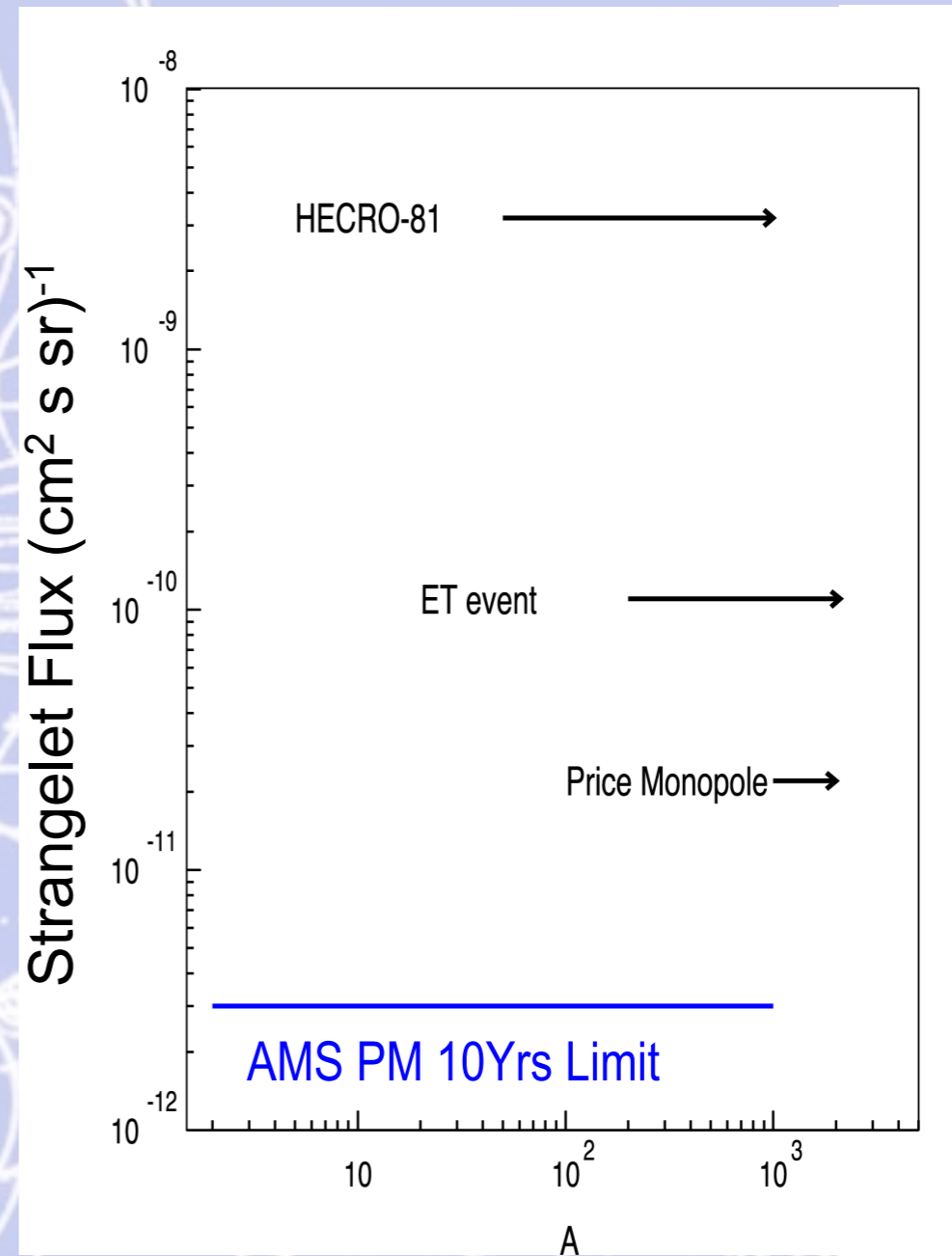
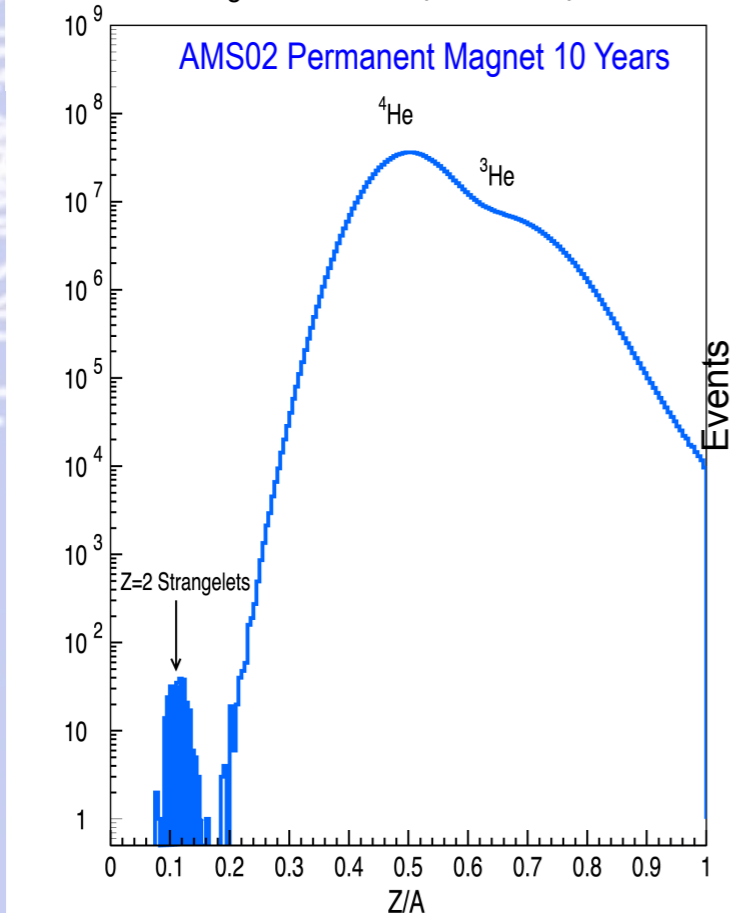

Background probability  $< 10^{-3}$

$\Phi_{\text{strangelets}} = 5 \times 10^{-10} (\text{cm}^2 \text{s sr})^{-1}$   
or ~30 in 1st year for AMS-02

The background of the slide features a light blue sky filled with numerous small white stars. Overlaid on this are several complex, white, glowing particle tracks. These tracks consist of multiple overlapping circles and spirals of varying sizes, some appearing as straight lines or slightly curved paths. The overall effect is that of a particle detector's output, showing the paths of particles as they interact or decay.

# Appendice 8

(Condizioni termiche di AMS-02: angolo beta)

# Thermal Control is the most challenging task in the operation of AMS

The thermal environment on ISS is constantly changing due to:

- Solar Beta Angle ( $\beta$ )
- Position of the ISS Radiators and Solar Arrays
- ISS Attitude

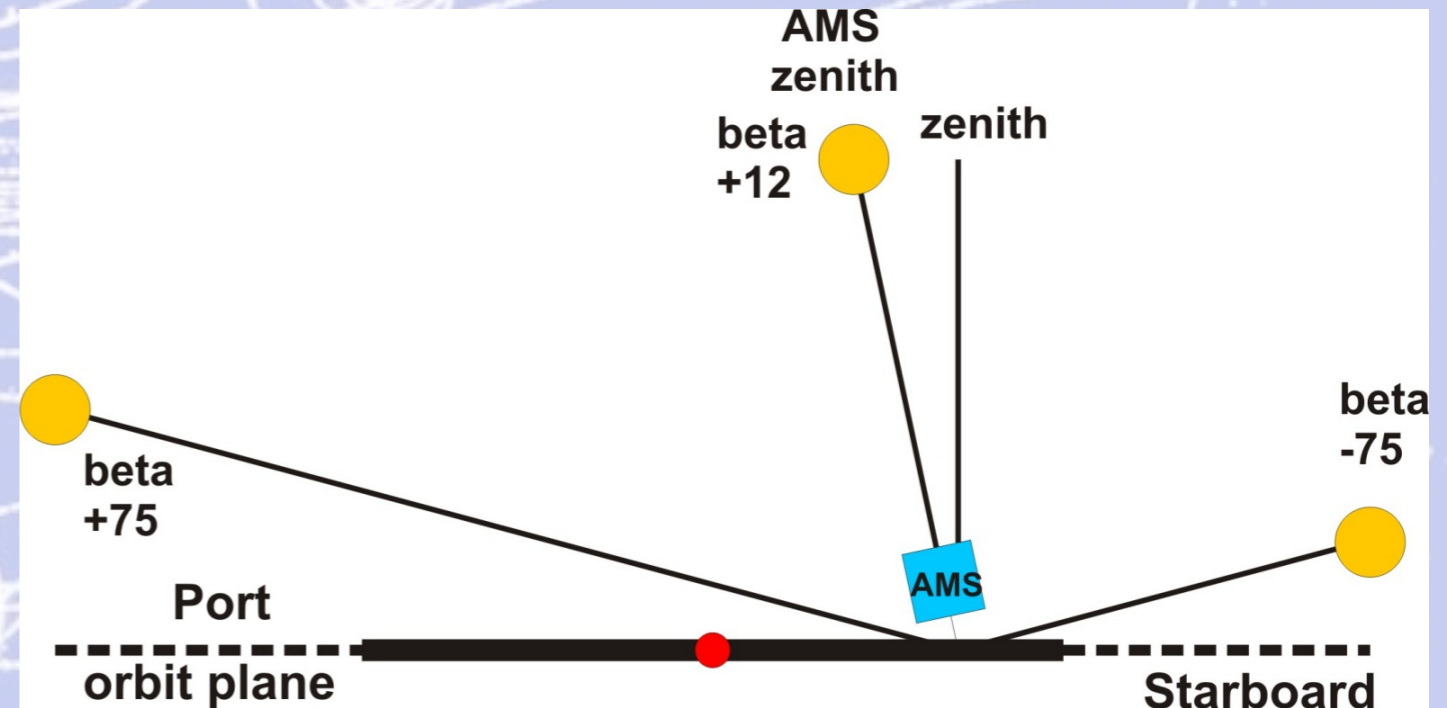
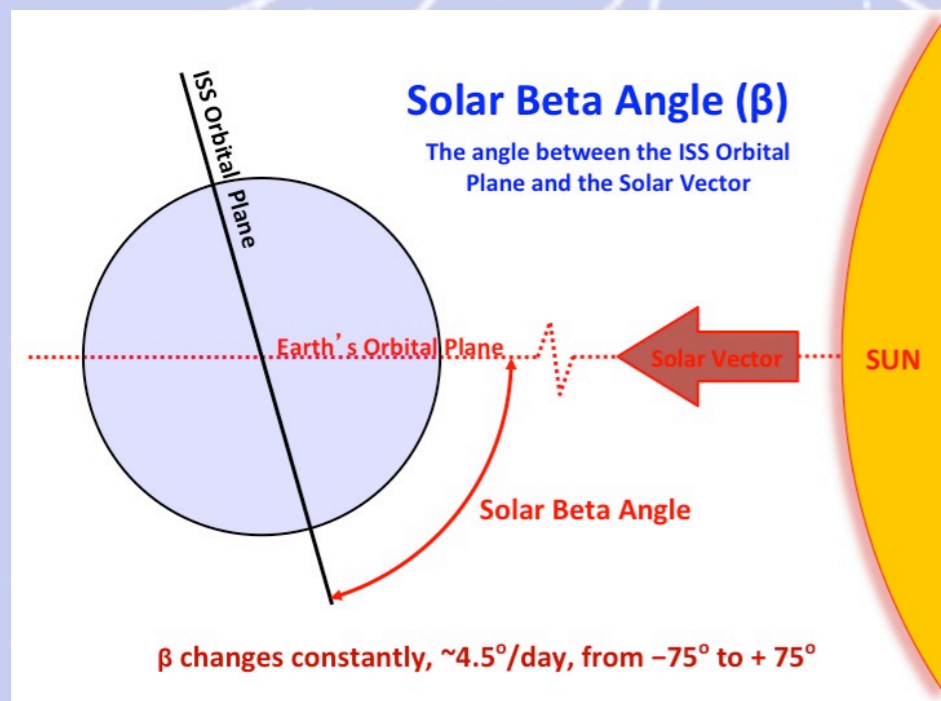

Over **1,100** temperature sensors and **298** heaters are monitored around the clock in the AMS POCC to assure components stay within thermal limits and avoid permanent damage.



The background of the slide is a light blue color with a complex pattern of white lines. These lines represent particle tracks, showing various paths such as straight lines, spirals, and loops, typical of what might be seen in a particle detector. The tracks are scattered across the entire page, creating a sense of dynamic movement and scientific exploration.

# Appendice 9

(Il tracciatore di AMS-02)

The momentum resolution ( $\Delta p/p$ ) is the sum of two contributions:

1. Measurement inside the magnet with an effective length  $L$

$$(Q/p) \cdot (\Delta p/p) \propto 1/BL^2$$

2. Measurement of the incident ( $\theta_1$ ) and exit ( $\theta_2$ ) angles

which depend on the length  $L_1$

$$(Q/p) \cdot (\Delta p/p) \propto 1/BL L_1$$

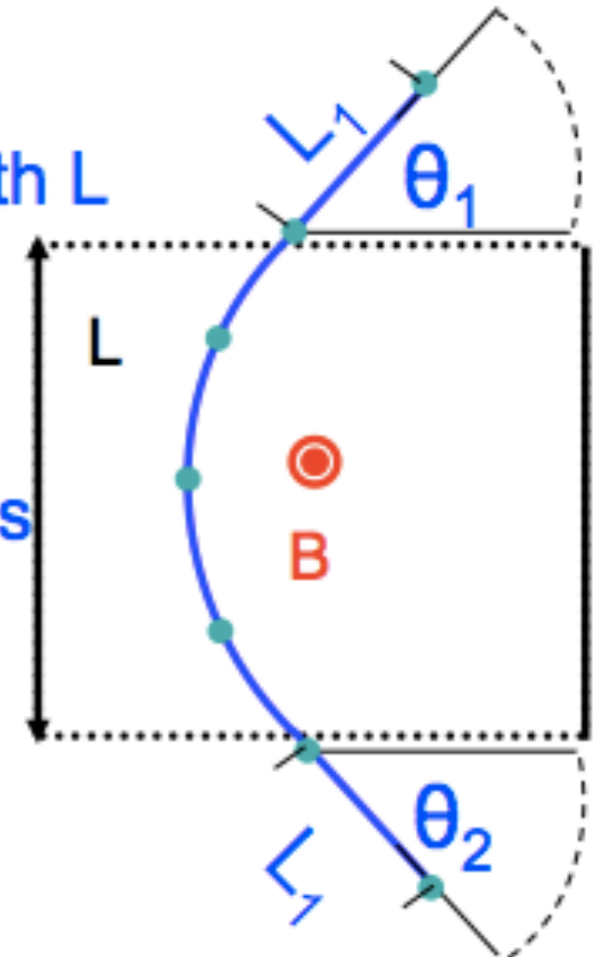

For both magnets,  $L \sim 80$  cm,

but in the permanent magnet  $B$  is 5 times smaller

to maintain the same  $\Delta p/p$  we increase  $L_1$  from  $\sim 15$  cm  
(Superconducting Magnet) to  $\sim 125$  cm (permanent magnet)

196,608 Pulse Heights,  
216 Low Voltages,

192 Tracker Data Reduction (TDR)

16 Readout Computers (JINF-T)

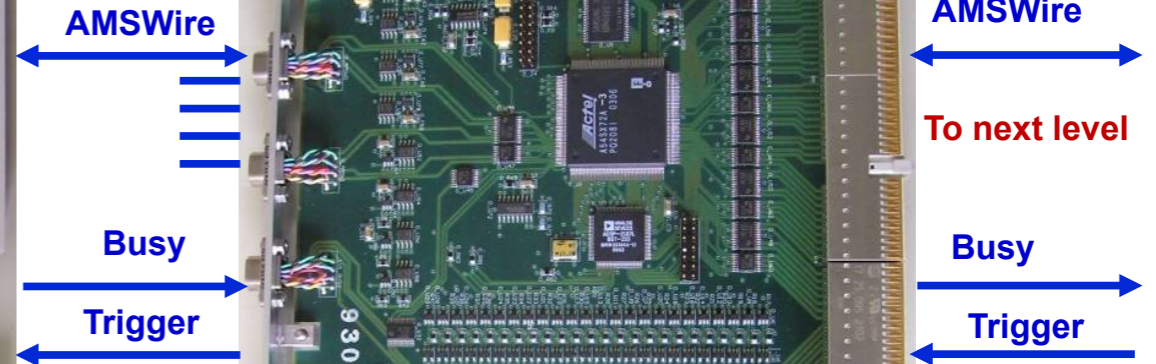
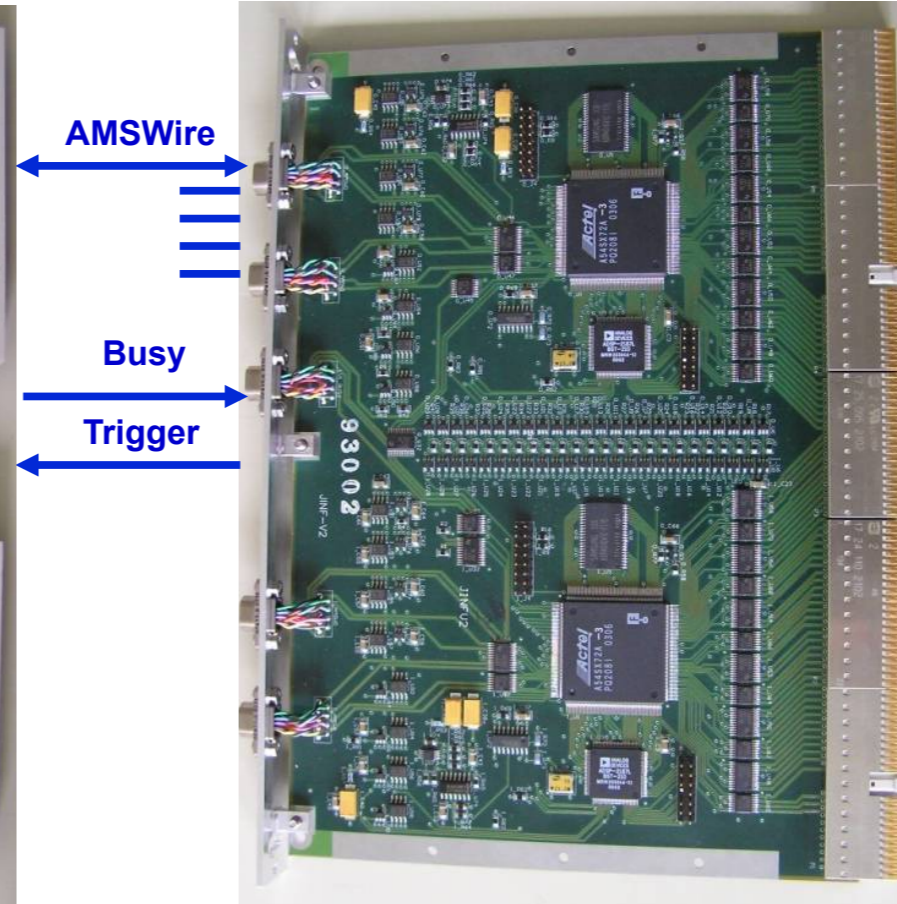
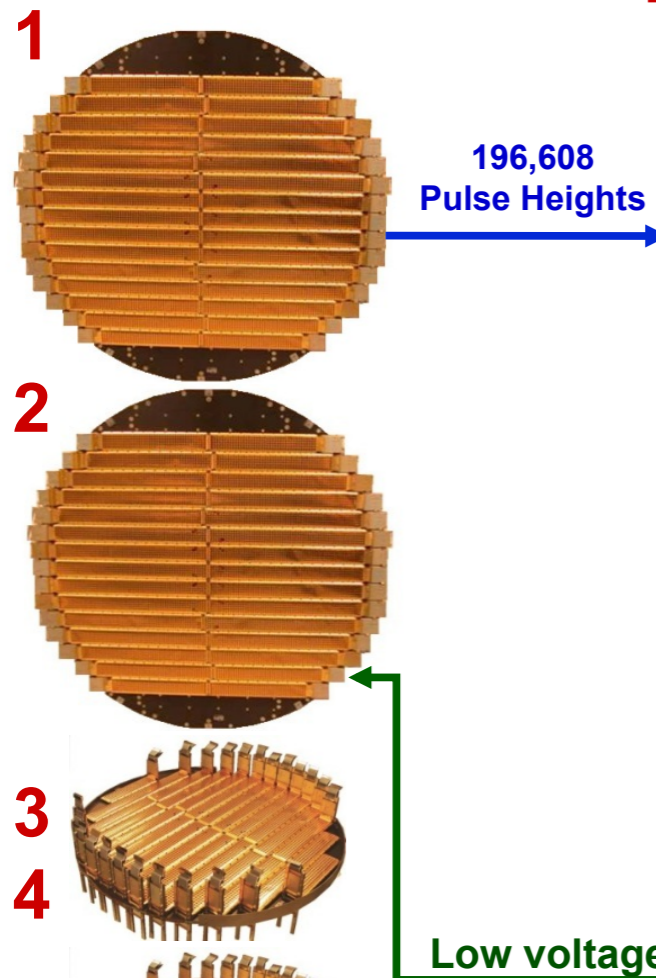

- Analog to digital conversion  
coordinate resolution of 10  $\mu\text{m}$
- Data reduction:  
Pedestal subtraction  
Noise suppression  
Cluster finding
- Format, send to next level

- Collect data from TDR (\*)
- Format, send to next level
- Control Low Voltages
- Combine Busy signals
- Distribute Trigger
- Distribute command to TDR

(\*) Tracker Data Reduction



The background is a light blue color with a complex pattern of white lines. These lines include several concentric circles, a prominent spiral, and various straight and curved paths that resemble particle tracks or data points. The overall aesthetic is scientific and technical.

# Appendice 10

(II TRD: Gas System)

# Transition Radiation Detector (TRD)

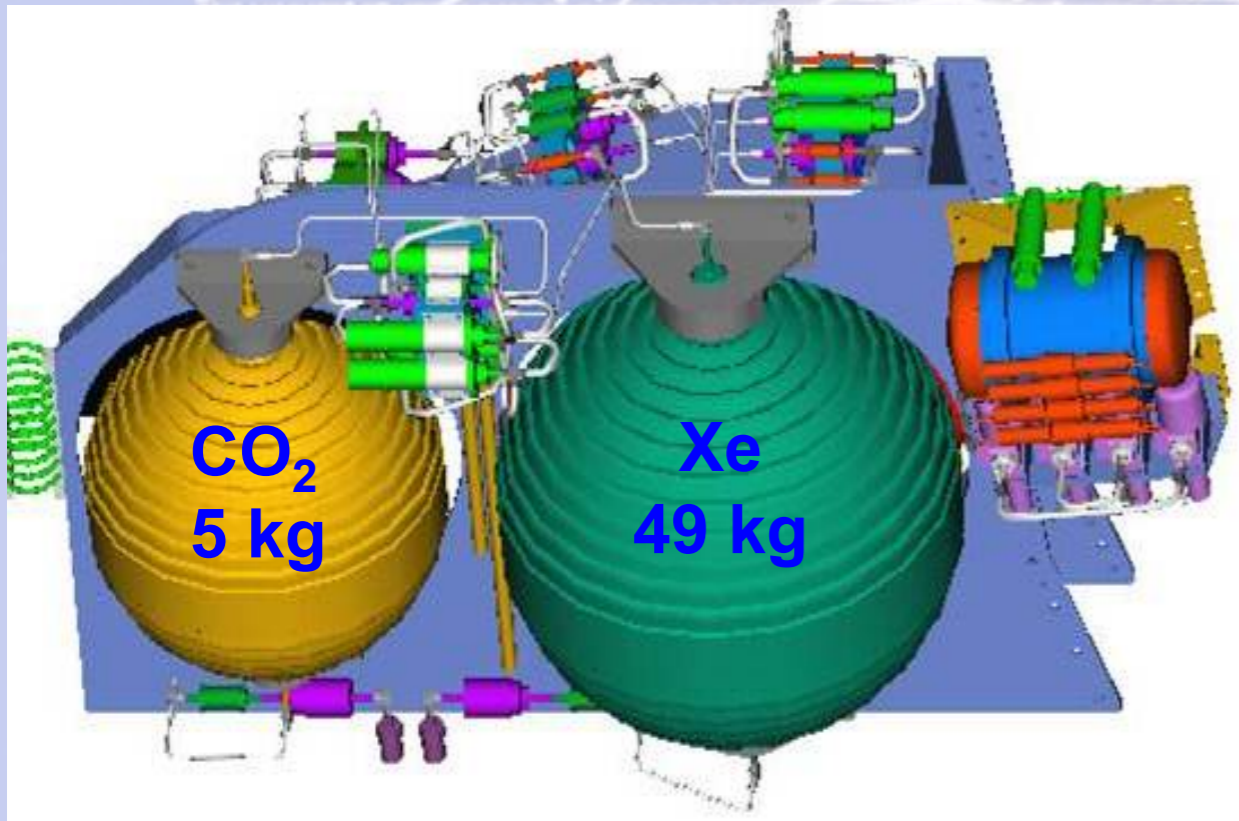
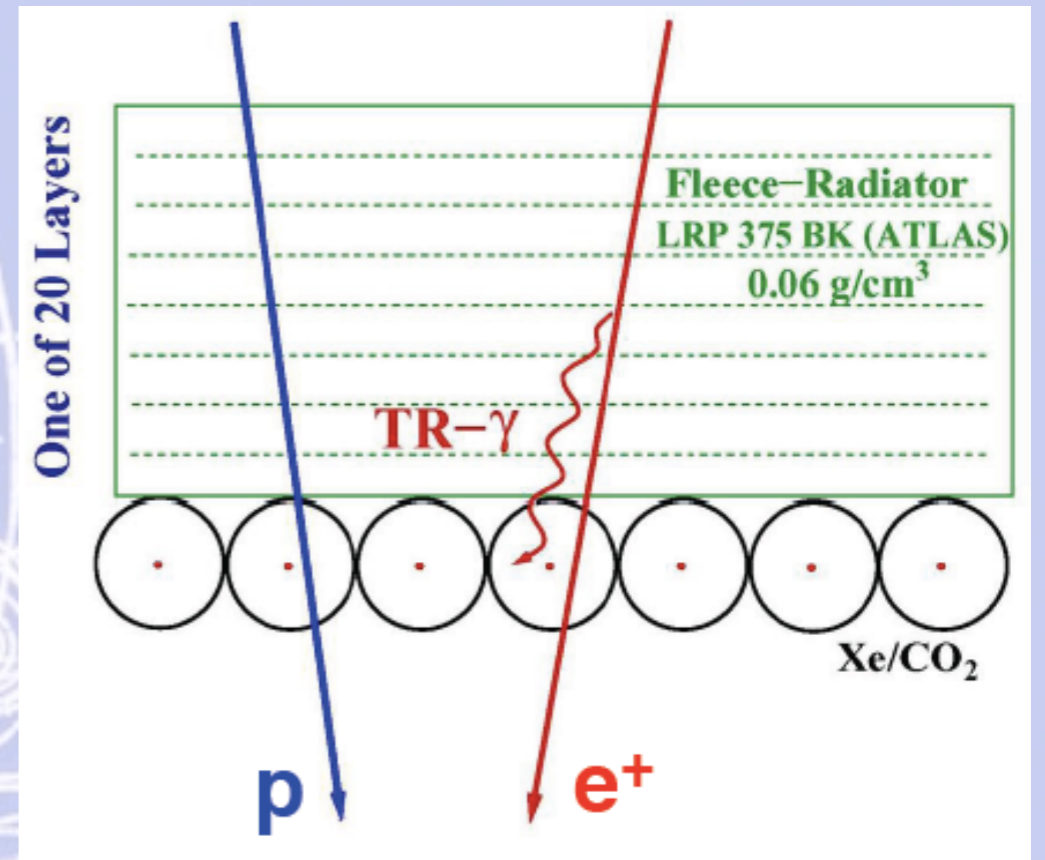
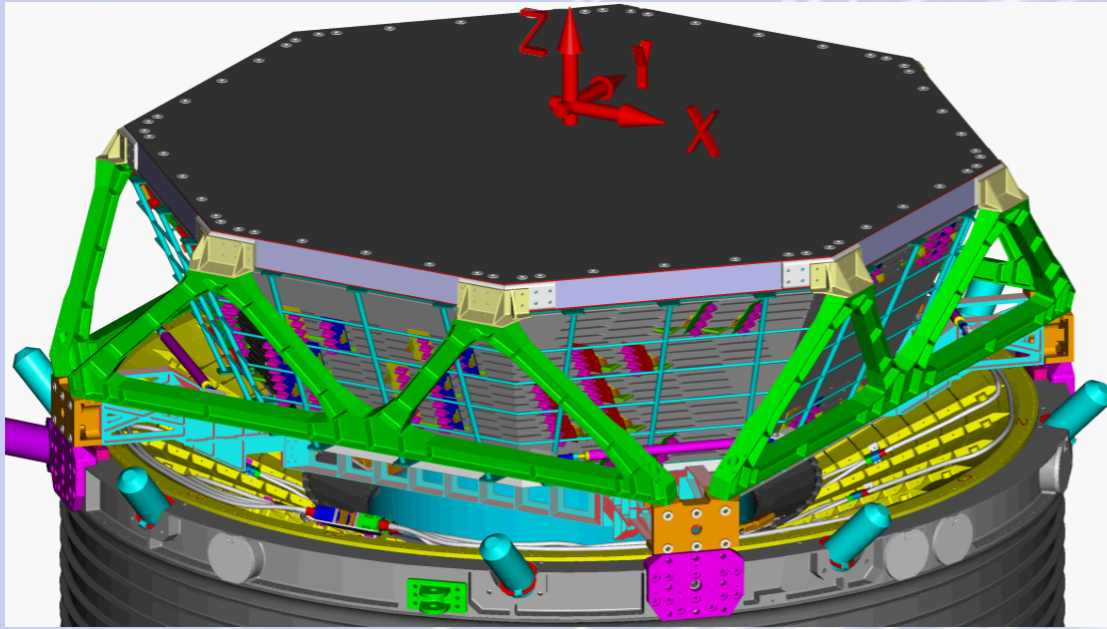

Leakrate of  $5 \mu\text{g/s}$ , caused by  $\text{CO}_2$  diffusion, corresponds to a lifetime  $\sim 20$  years in Space

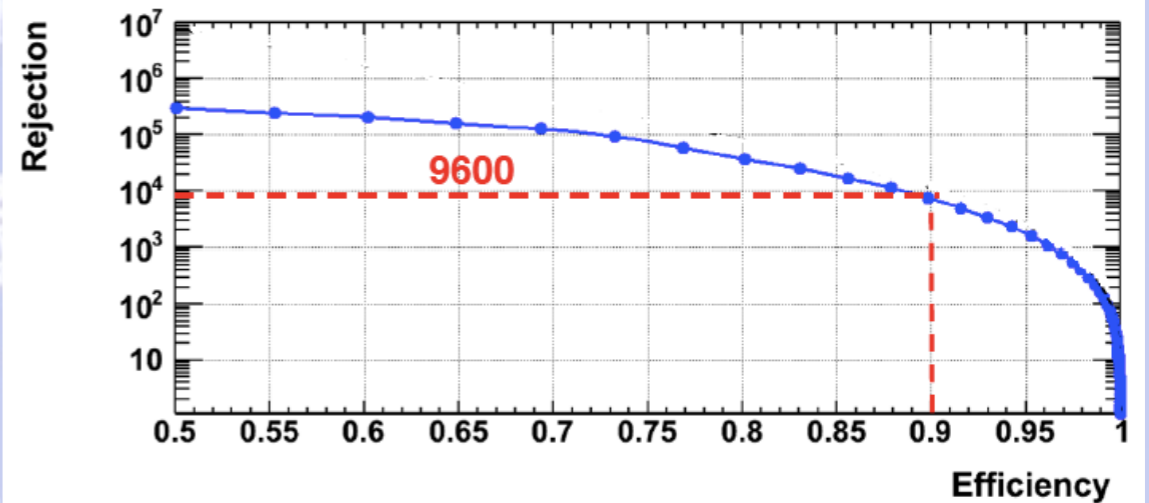
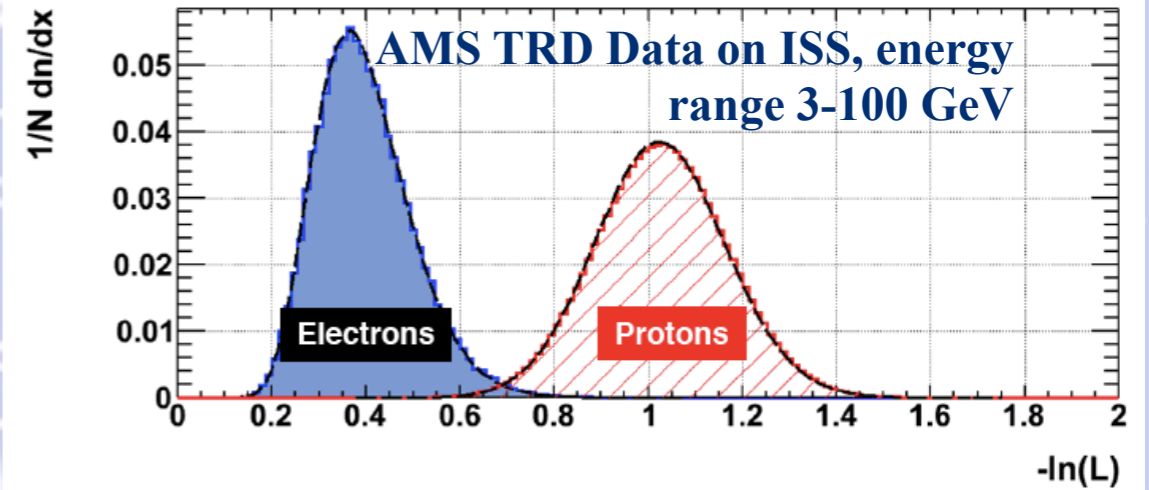

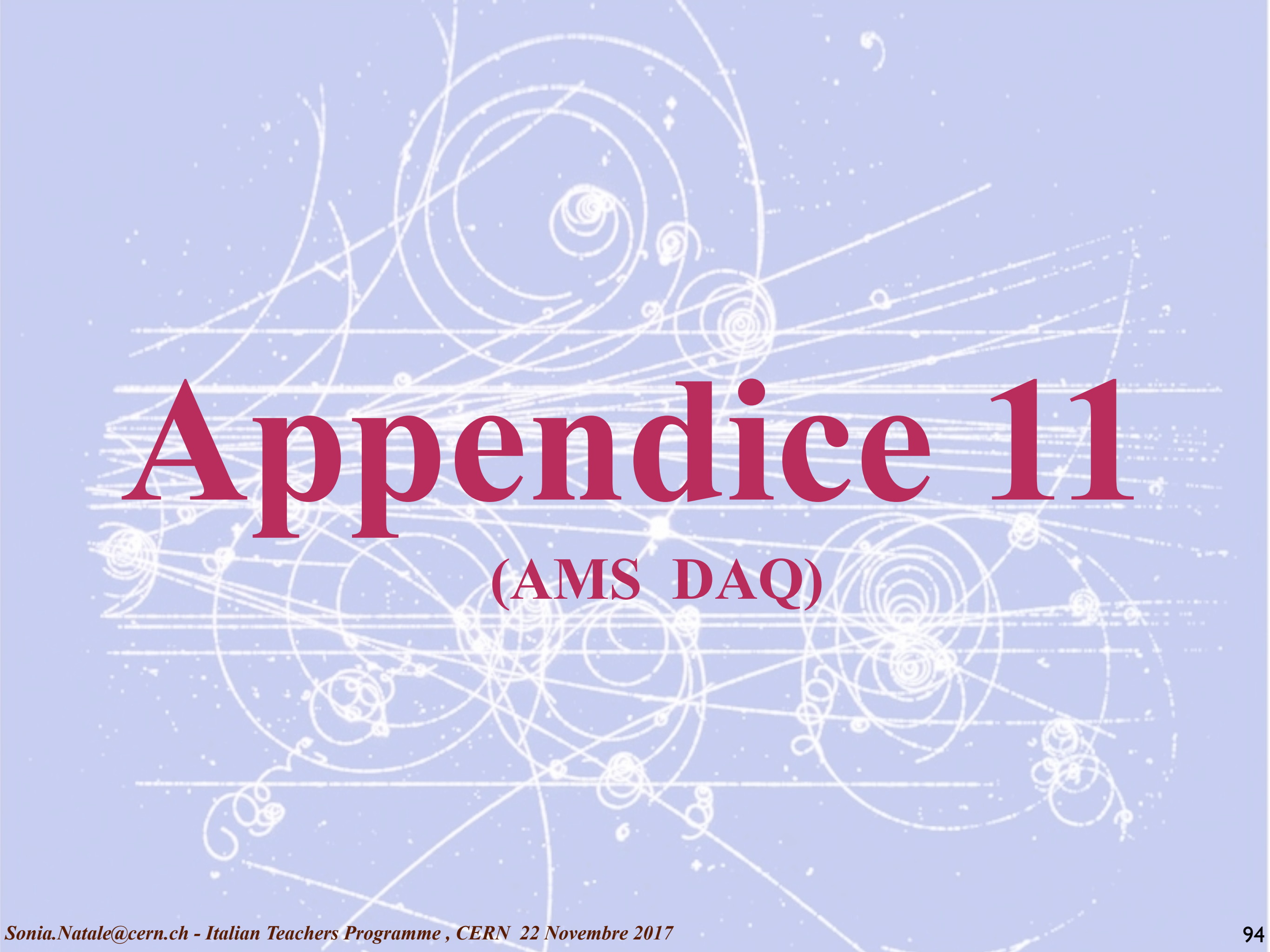
The background of the slide is a light blue color. It features a complex pattern of white lines representing particle tracks, some forming spirals and others as straight lines. Scattered throughout the background are small white dots, resembling a starry sky or a particle detector's output.

# Appendice 11

(AMS DAQ)

# AMS Data Acquisition System

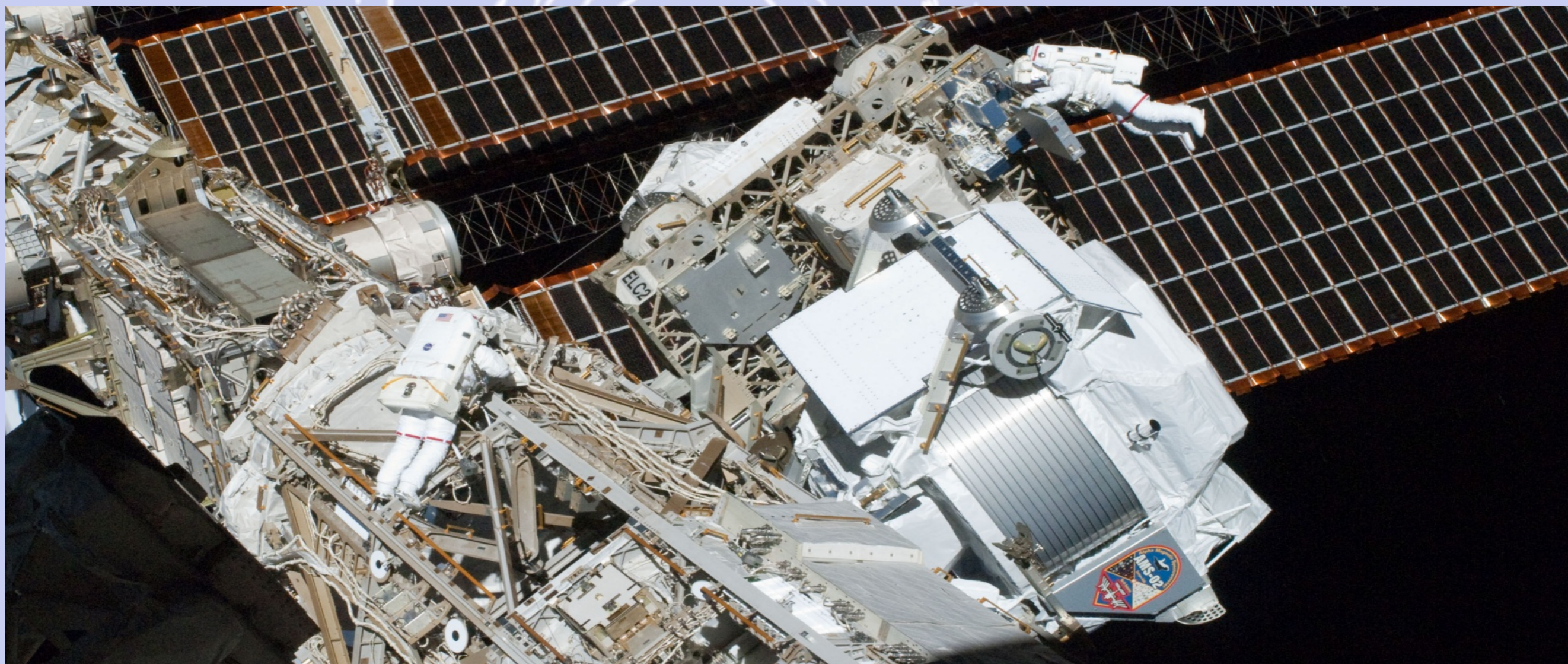

To read out 300,000 channels at up to 2 KHz, we developed a large set of **computers (650)** which **are programmable from the POCC** and which readout all the different detectors with up to 400% redundancy. Hundreds of these computers are interconnected in a tree like structure with an **100 MBit/s serial link.**

# AMS Payload Operation and Control Center for ISS

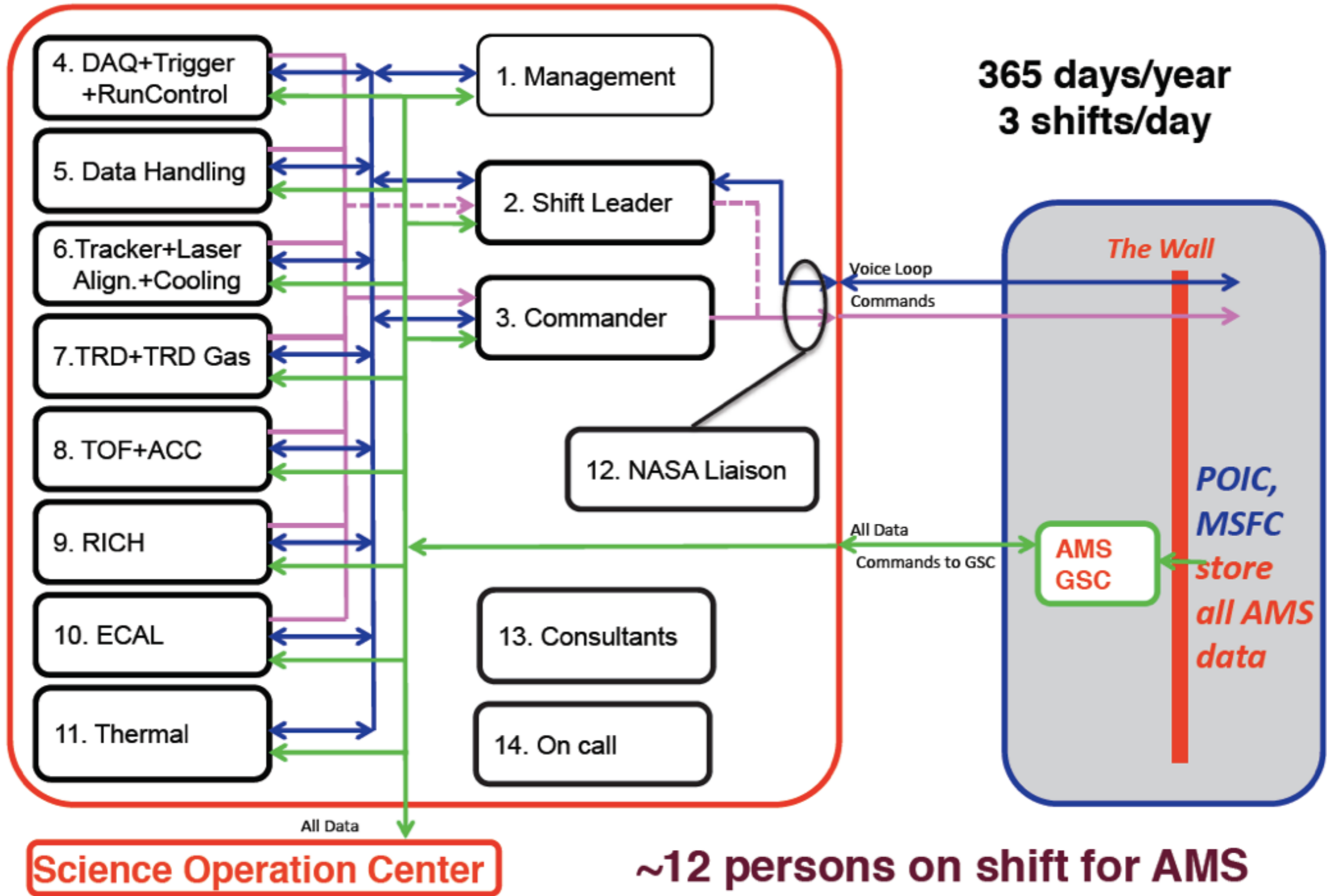



The background of the slide is a light blue color with a complex pattern of white lines. These lines represent particle tracks, featuring a mix of straight paths, spirals, and circular loops, typical of tracks from a particle detector like AMS-02. The tracks are scattered across the entire page, creating a sense of dynamic movement and scientific exploration.

# Appendice 12

(AMS-02 performance)

# AMS-02 collected over 20 billion events in 14 months operation on ISS

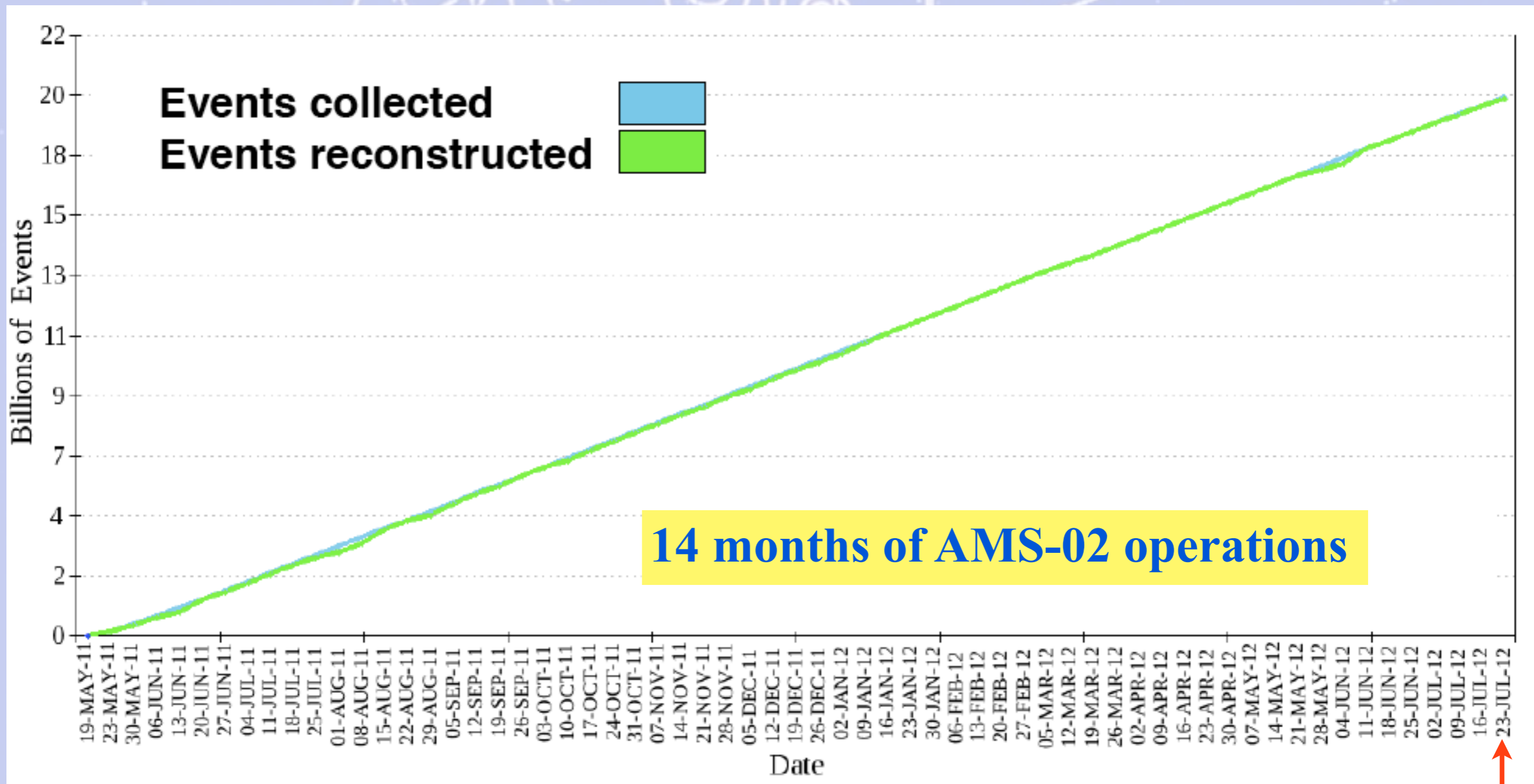

# Multiple independent Measurements of the Charge ( $|Z|$ )

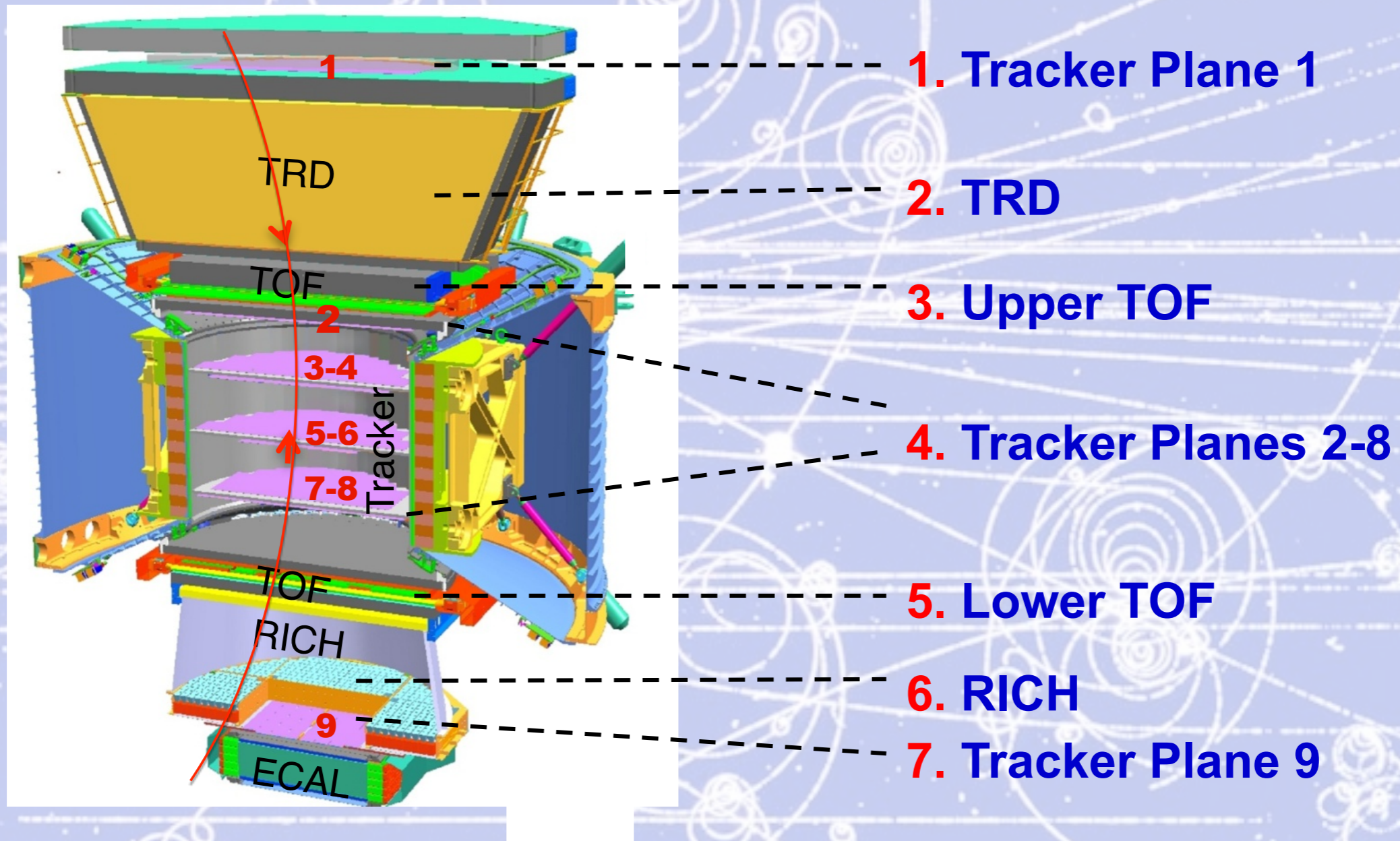

# Test Beam Results at CERN 2010 (8-20 Aug)

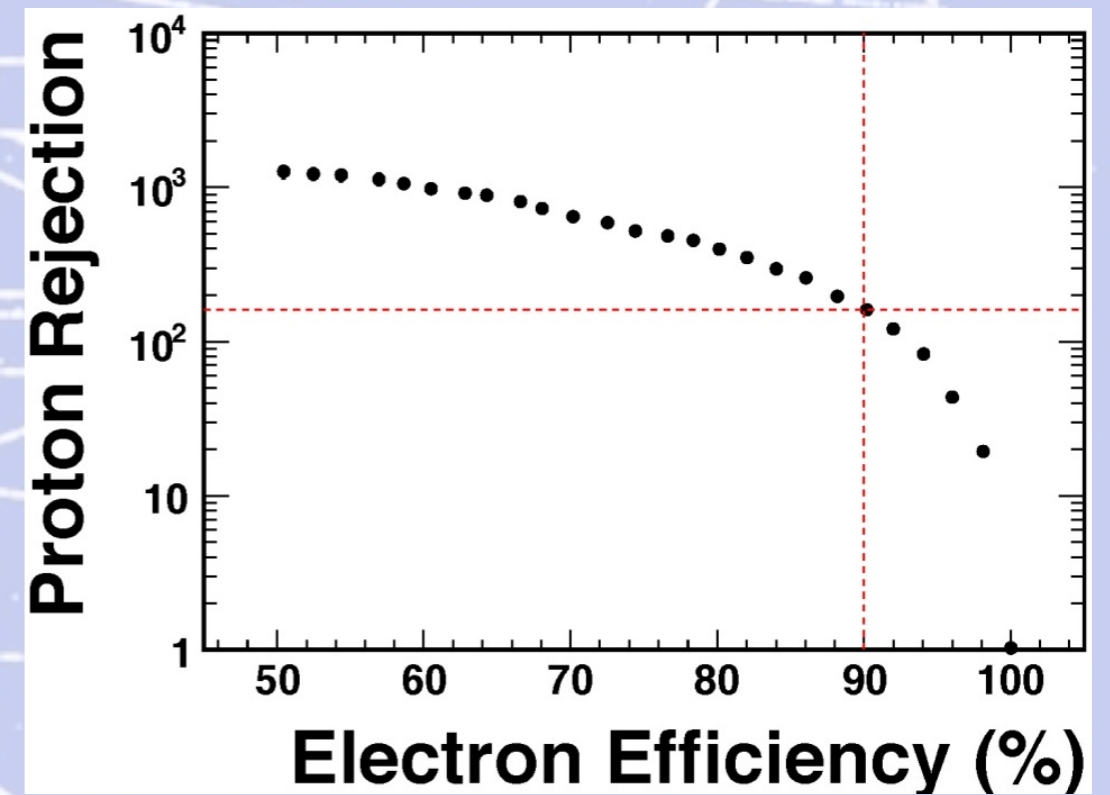
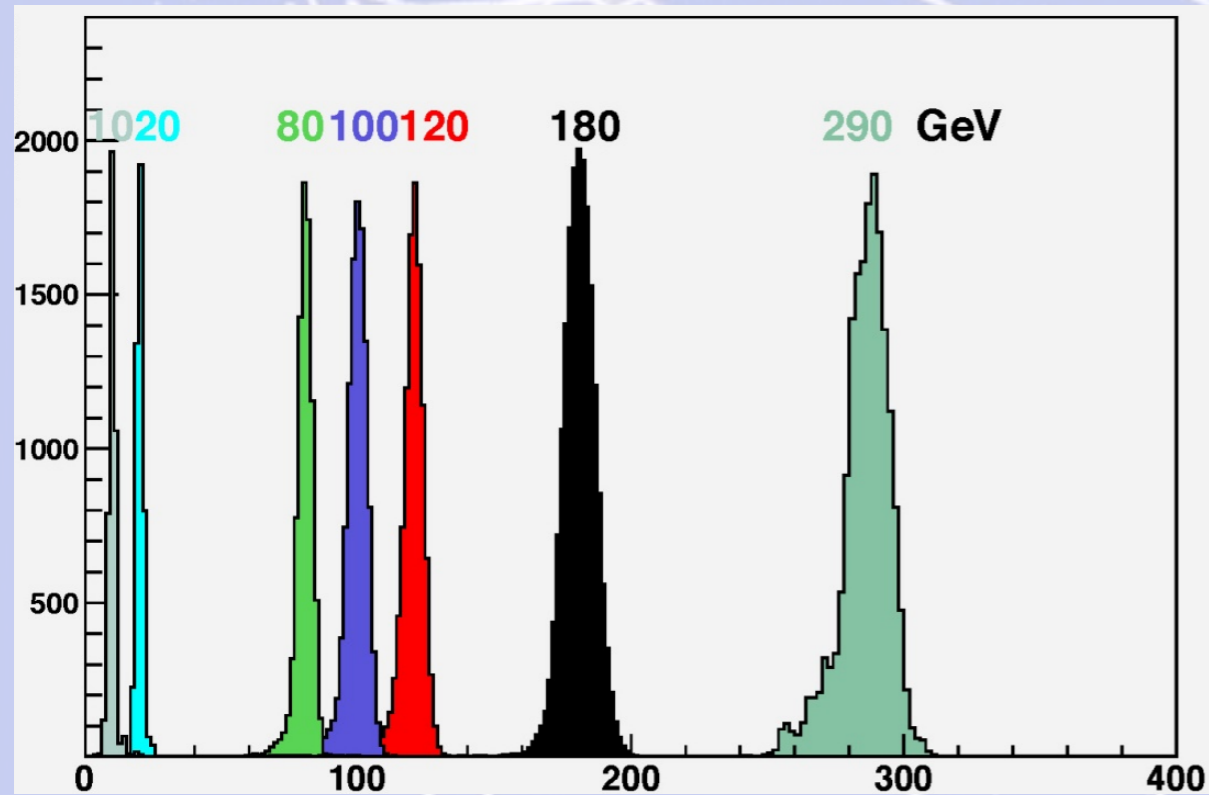
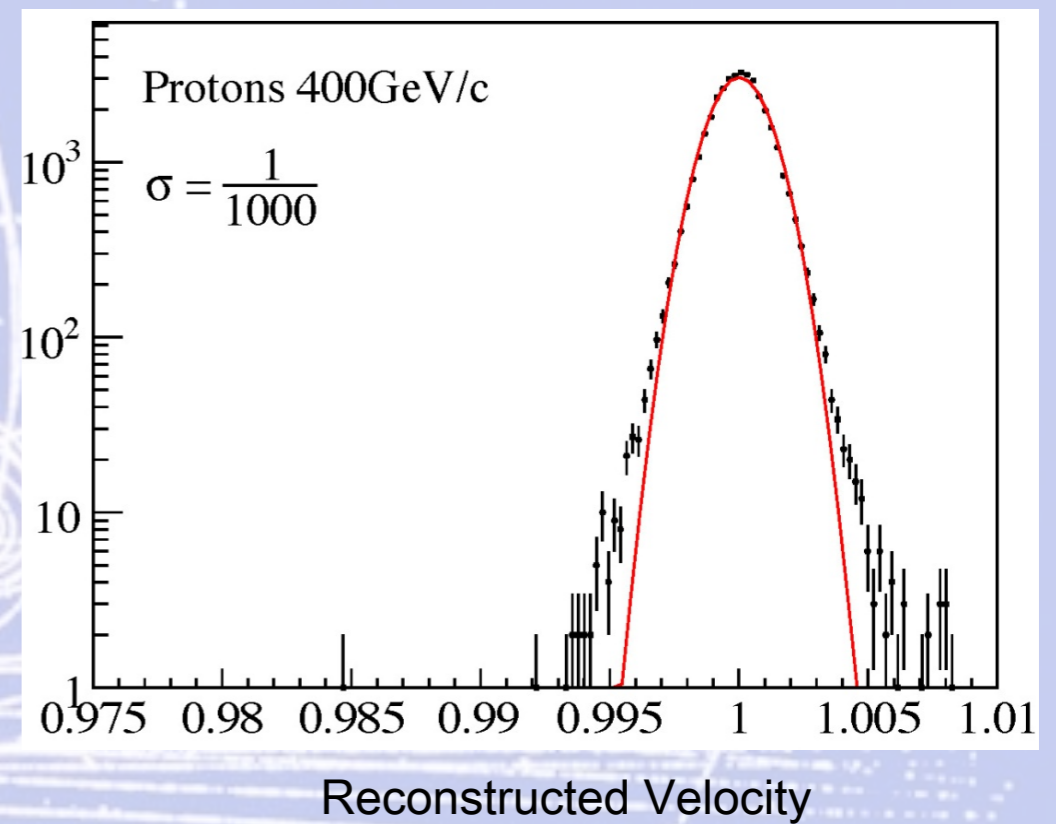
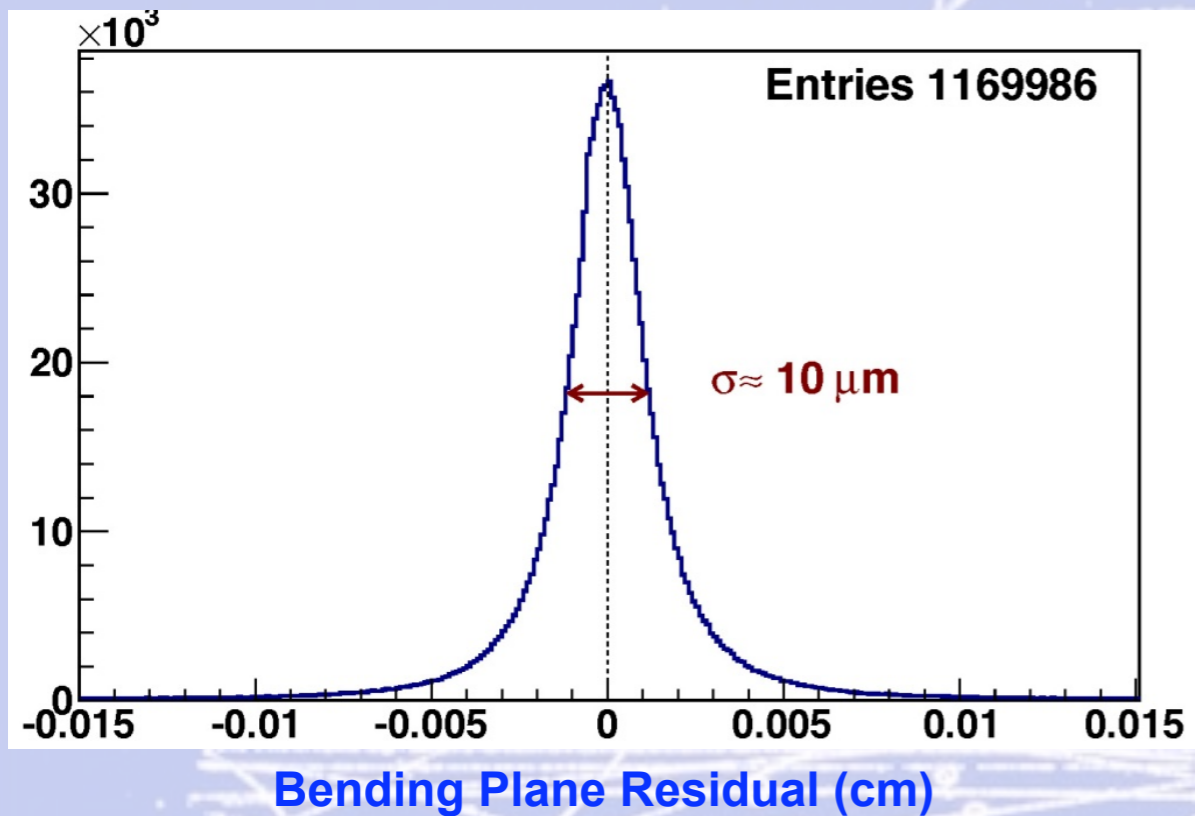

Measured combined rejection power at 400 GeV:  $e^+/p = 10^{-6}$

# The Magnet and the VETO System reject random Cosmic Rays

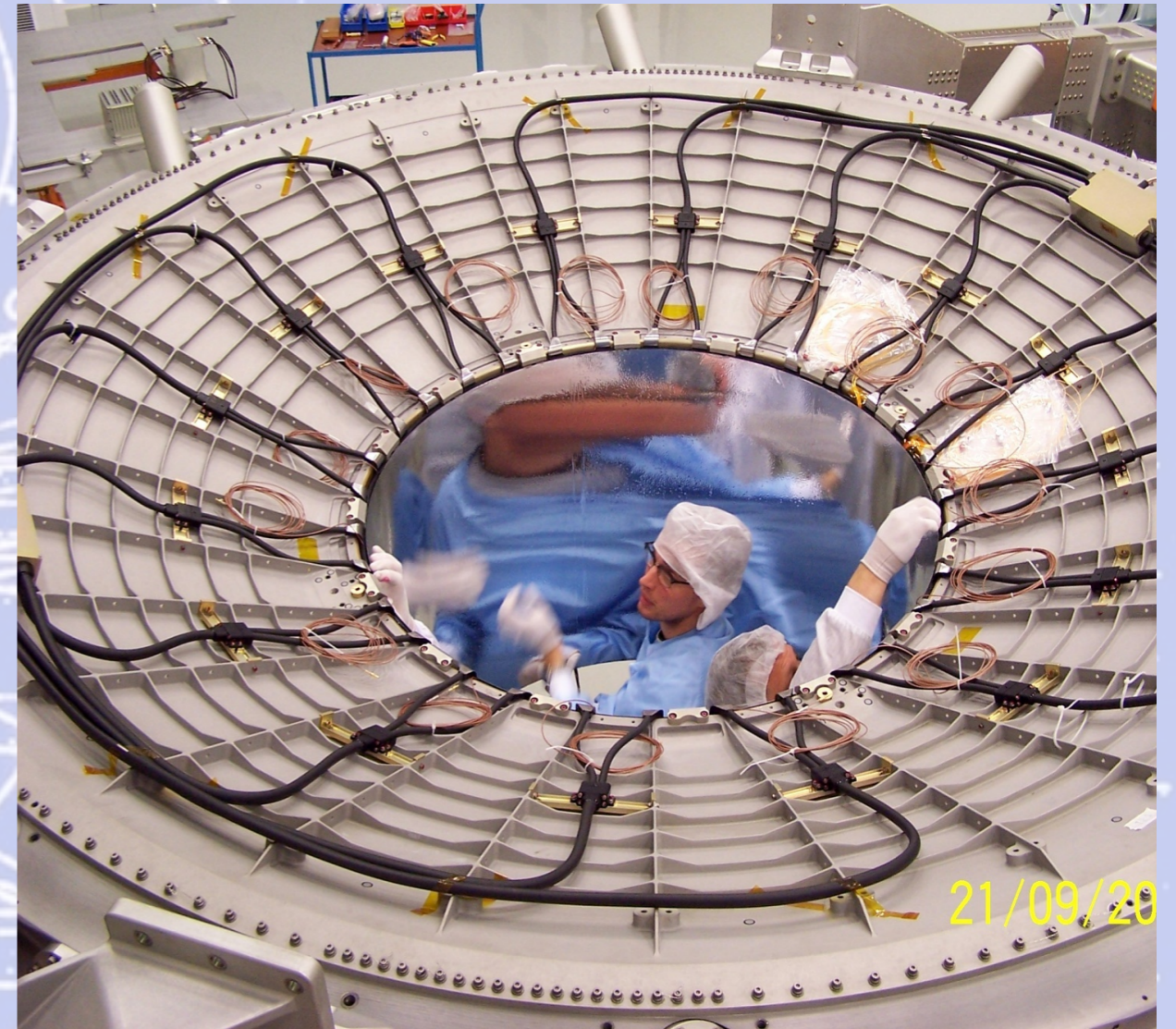
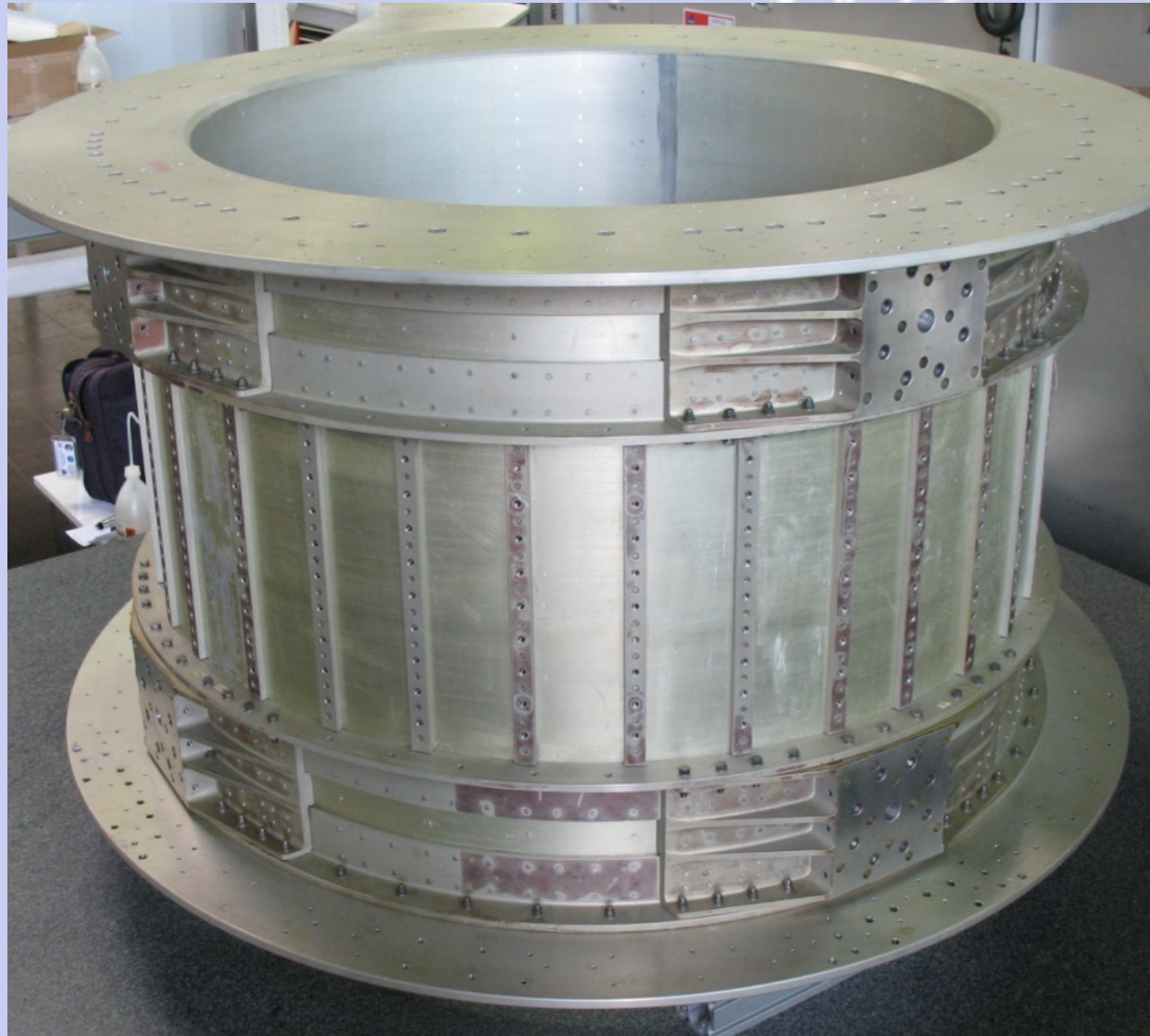

**In 12 years the field has remained the same to  $< 1\%$  (from 1997 to 2010)**

**Measured VETO (ACC) efficiency better than 0.99999**

# Appendice 13

(Risultati AMS-02 da maggio 2011 a settembre 2014  
+  
aggiornamento a settembre 2016)

# La fisica di AMS-02: misure di abbondanza nucleare

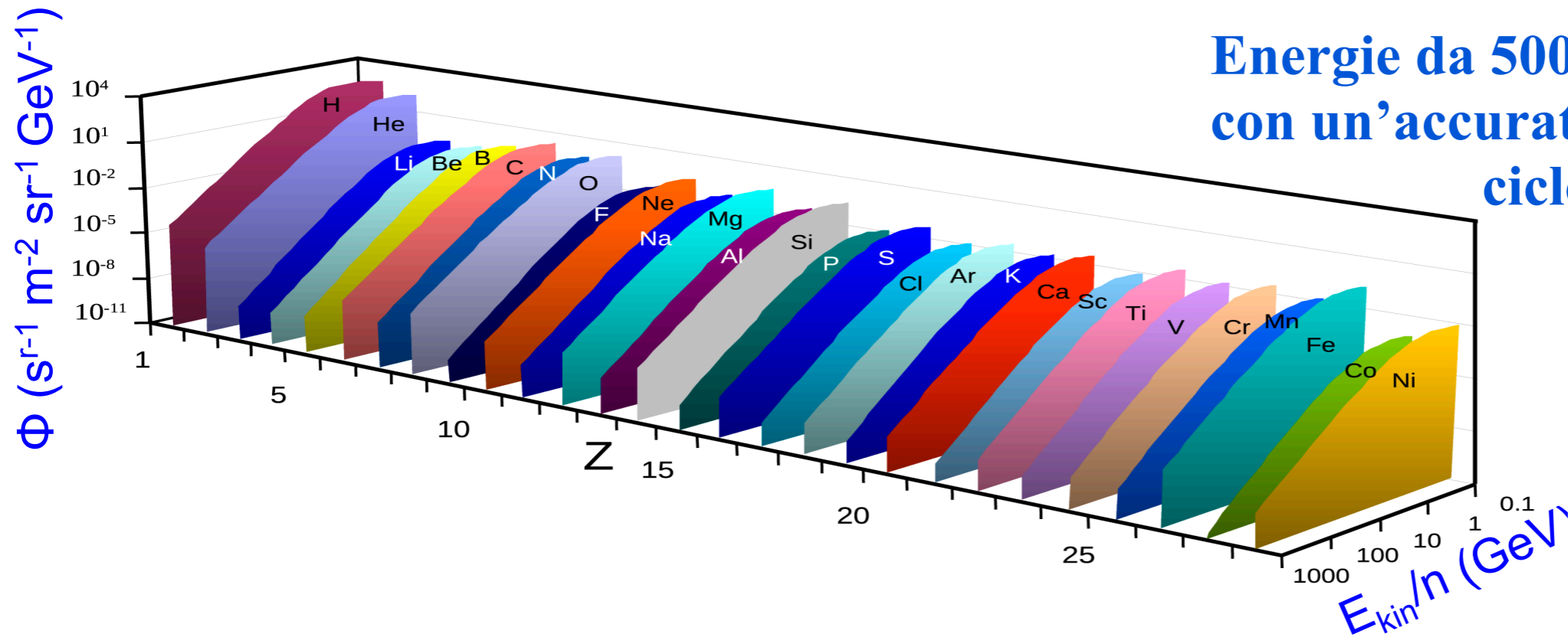

Energie da 500 MeV a 2 TeV  
con un'accuratezza dell'1% sul  
ciclo solare (11 anni).

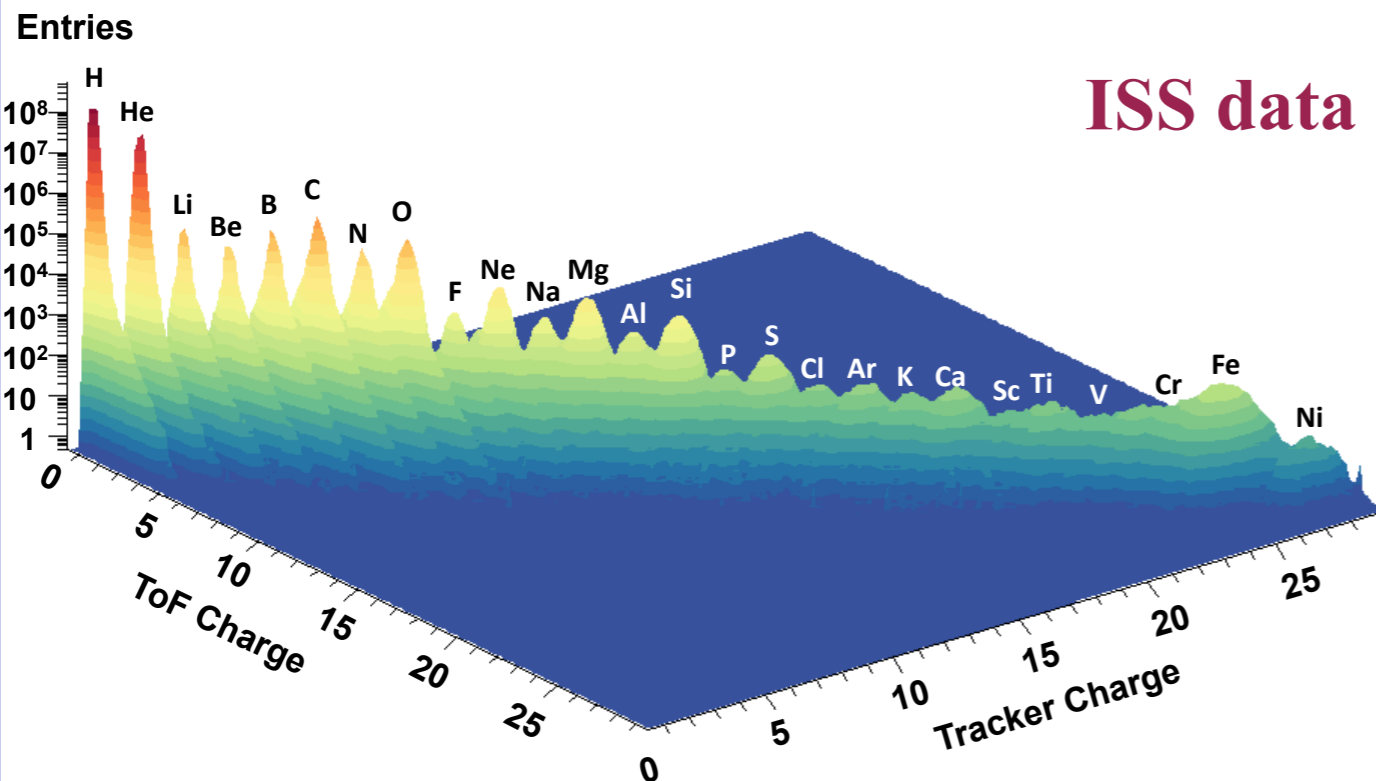

ISS data

Questi spettri forniscono  
dati sperimentali necessari  
per calcolare il  
“background” nella ricerca  
della Materia Oscura,  
i.e.,  $p + C \rightarrow e^+, p, \dots$

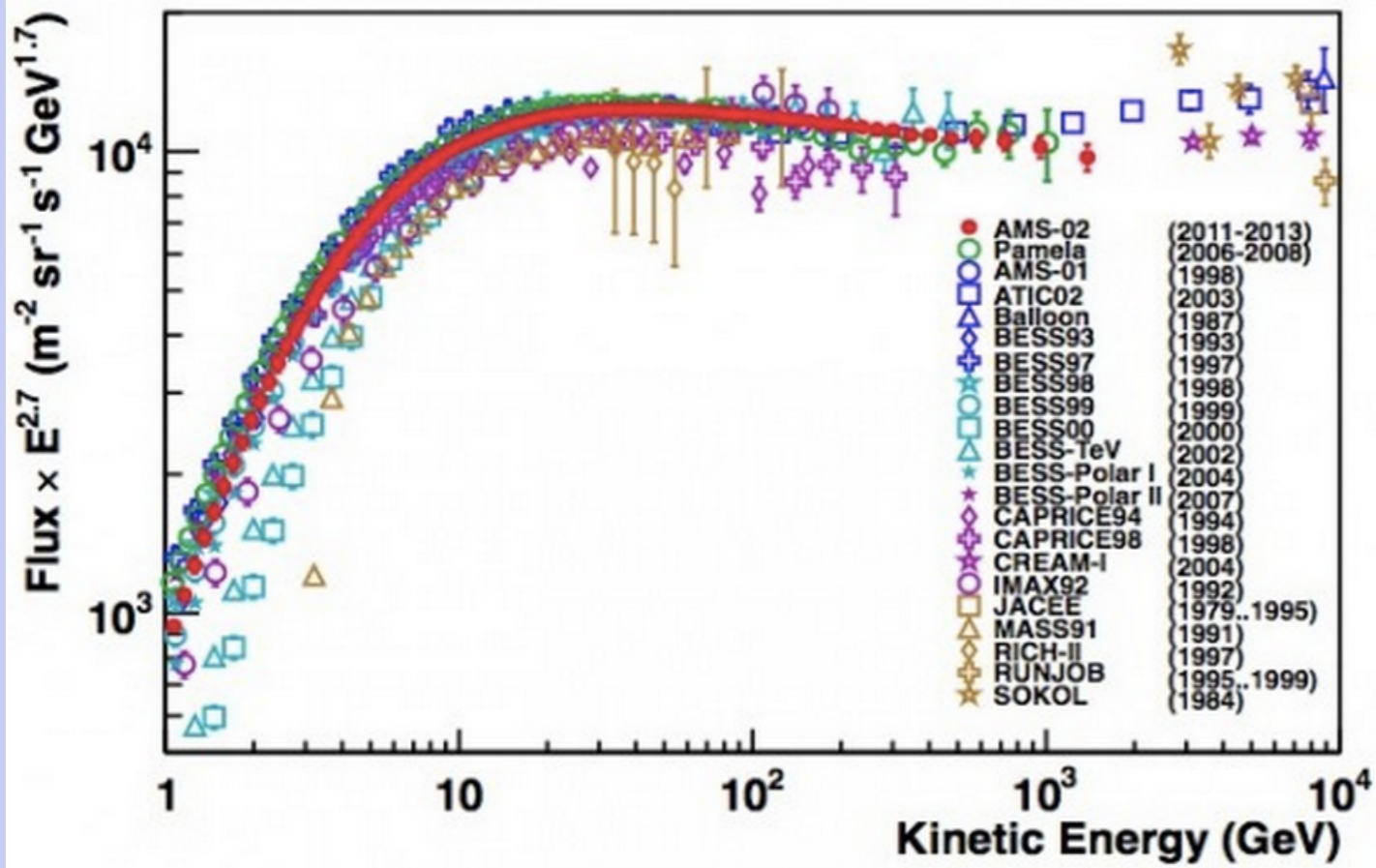

**Flusso di protoni  
(ICRC 2013)**

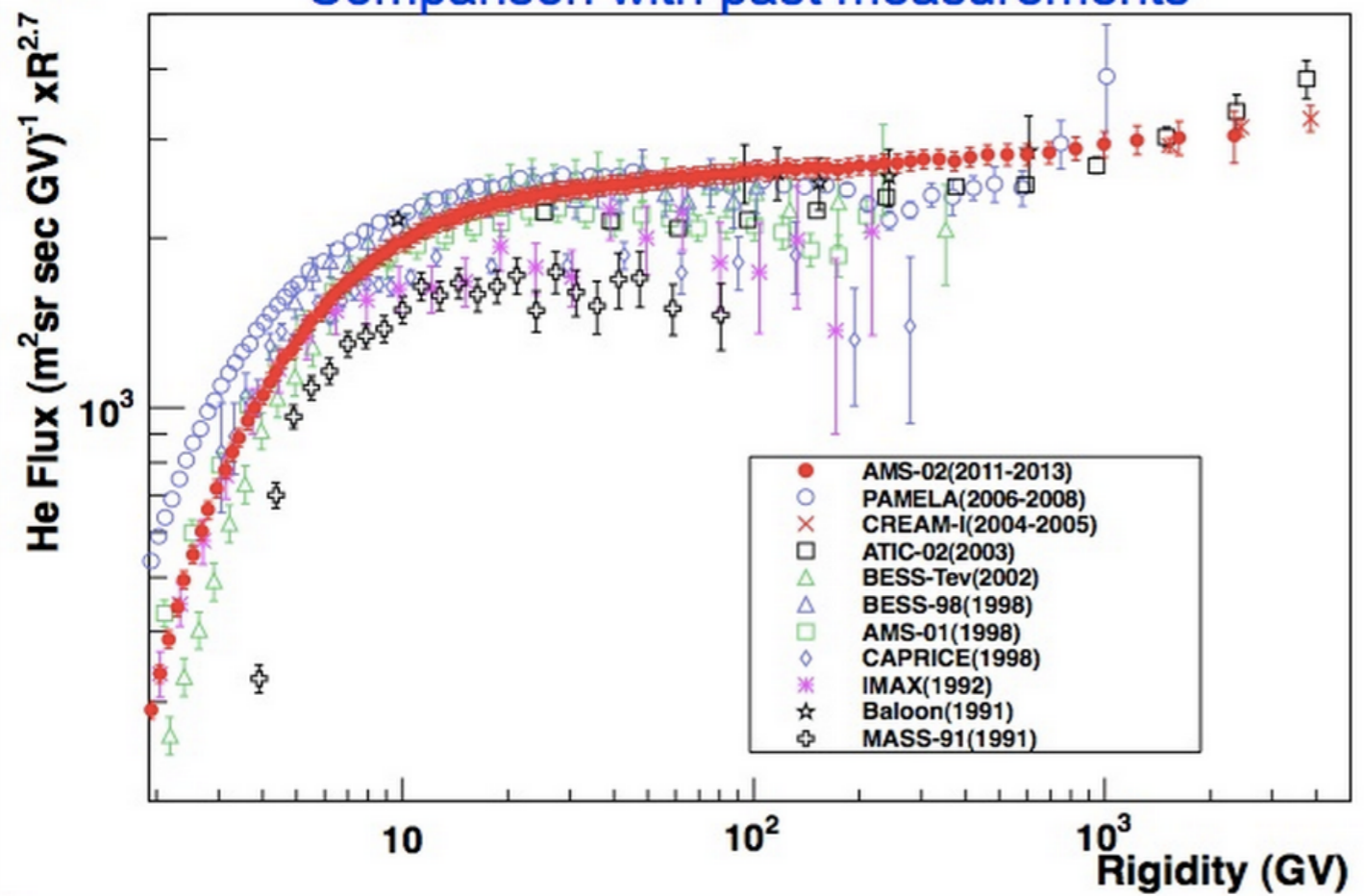

**Flusso dell'elio  
(ICRC 2013)**



# La fisica di AMS-02: rapporto Boro/Carbonio

Misure precise degli spettri di energia del B/C forniscono informazioni sulle interazioni e la propagazione dei CR

Interazioni con il Mezzo Interstellare:  
 $C + (p, He) \rightarrow B + \dots$

Diffusione  
Convezione  
Ri-accelerazione

Interazioni con il Mezzo Interstellare (ISM):

- Frammentazione
- Secondari
- Perdite energetiche

$40 \times 10^3$  ly

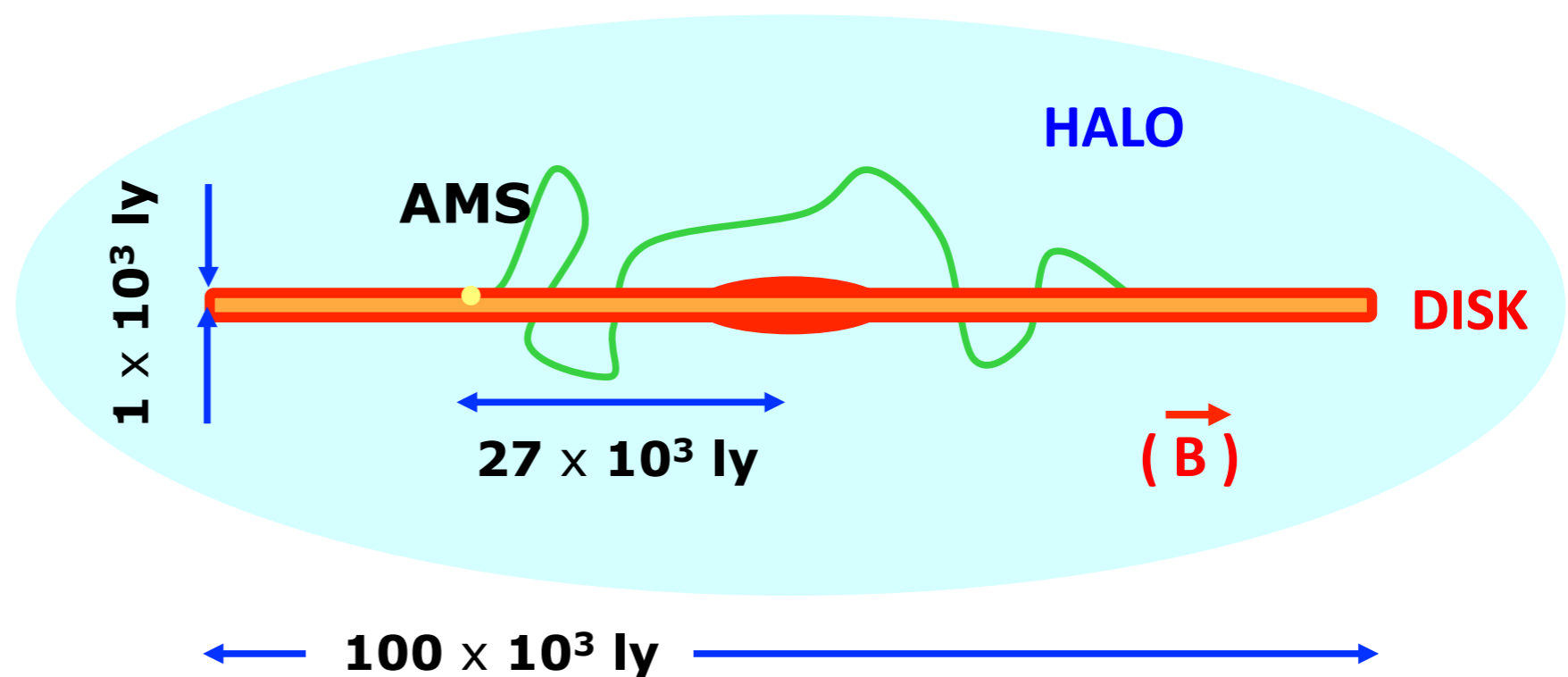

# Rapporto Boro/Carbonio (ICRC 2013)

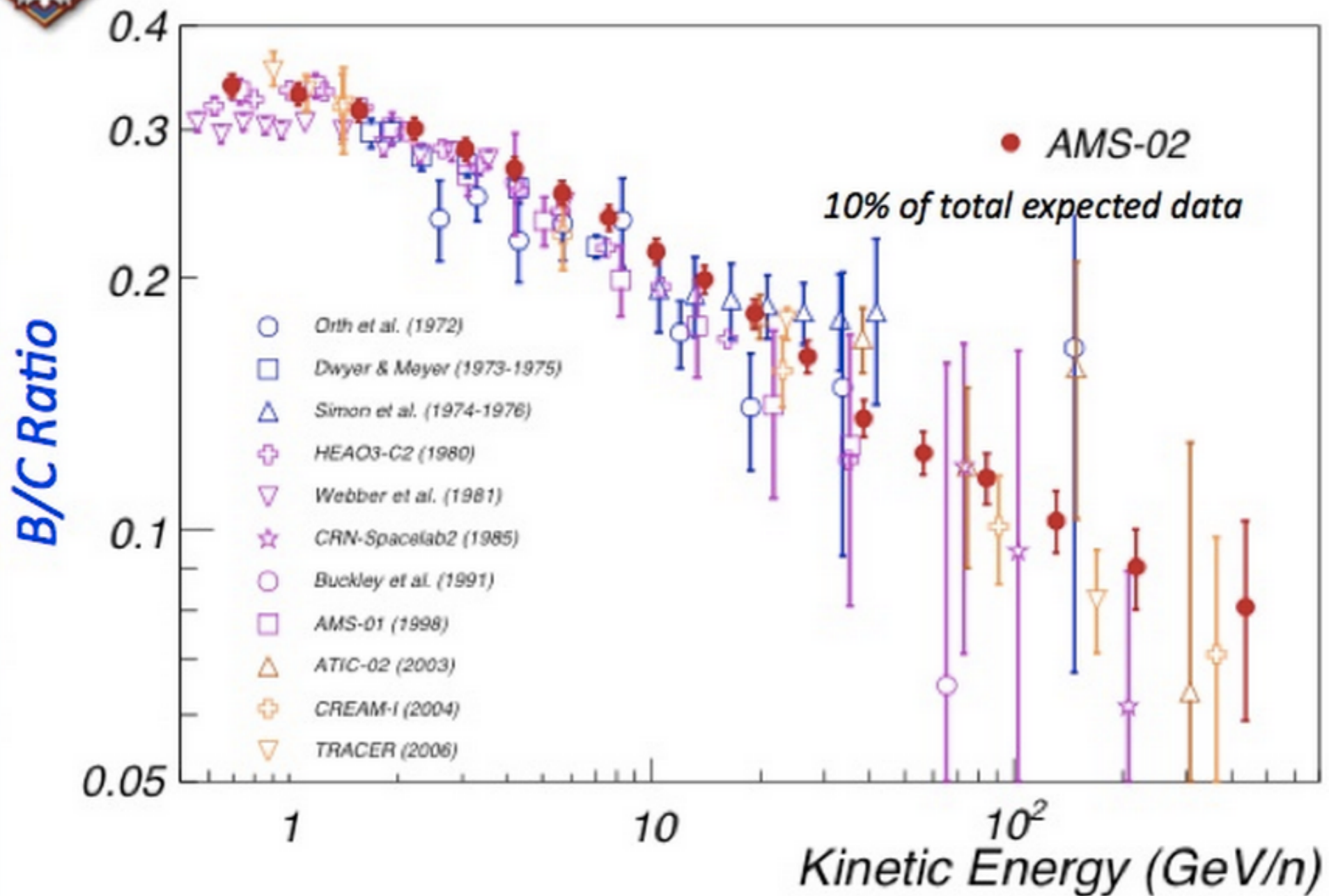

# La fisica di AMS-02: ricerca indiretta della Materia Oscura

AMS-02 ha la capacita' di studiare l'annichilazione del Neutralino (candidato della Materia Oscura) usando simultaneamente quattro diversi stati finali di particelle: **positroni, anti-protoni, anti-deuteroni and fotoni.**

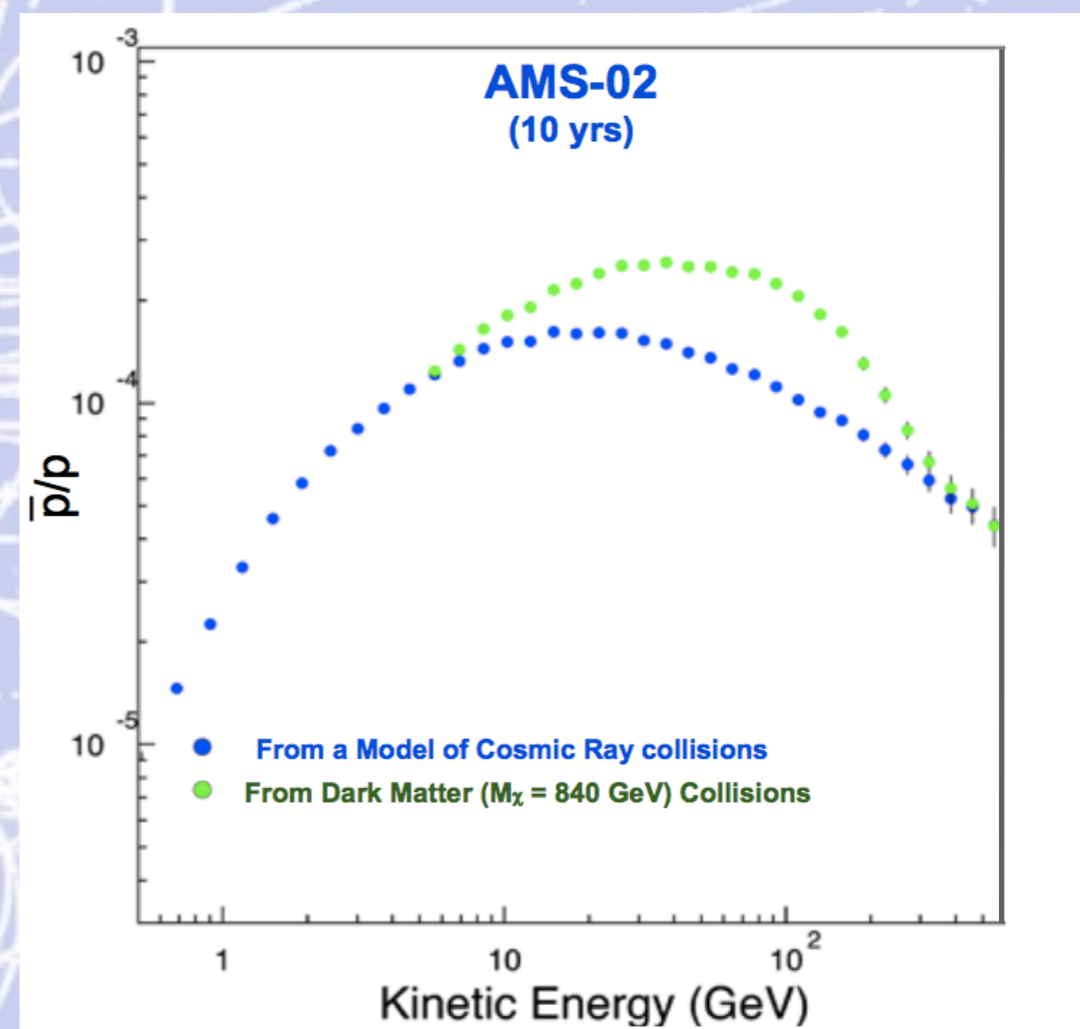
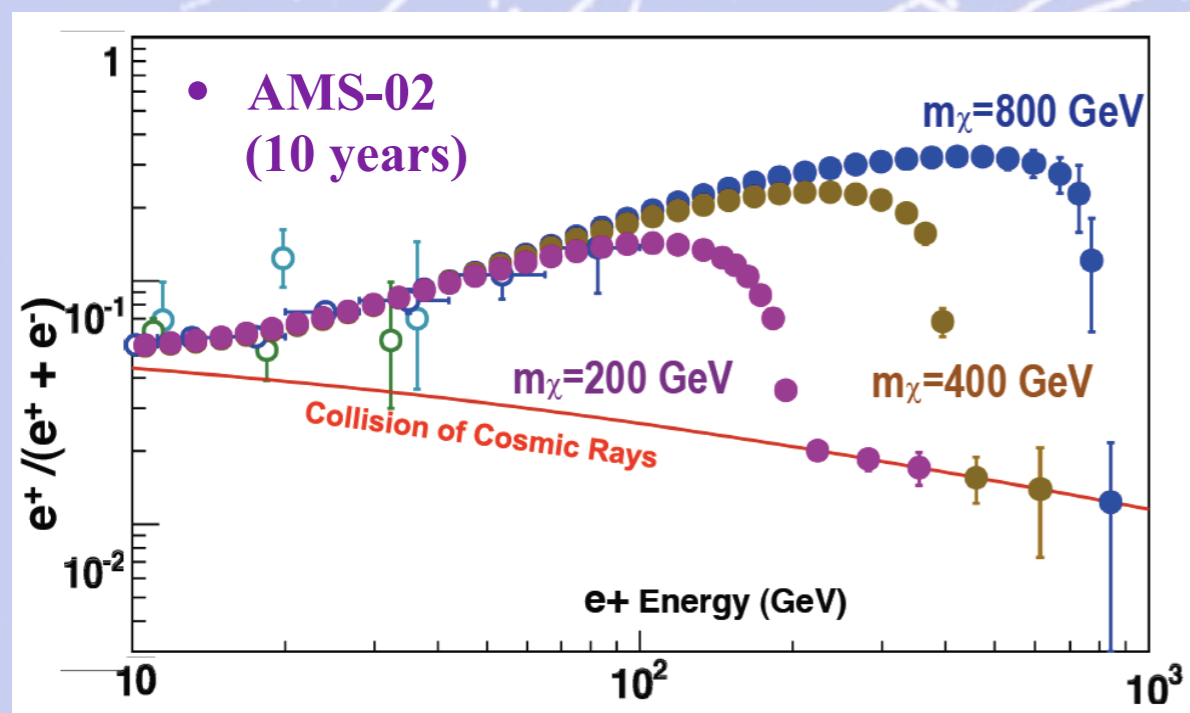

Segnale **aspettato** per la Materia Oscura da AMS-02 relativo alla misura della frazione del flusso di positroni e considerando diverse ipotesi della massa del Neutralino.

Segnale **aspettato** per la Materia Oscura da AMS-02 relativo alla misura della frazione del flusso di antiprotoni nell'ipotesi di massa del Neutralino  $M_\chi = 840$  GeV .

# La fisica di AMS-02: ricerca indiretta della Materia Oscura

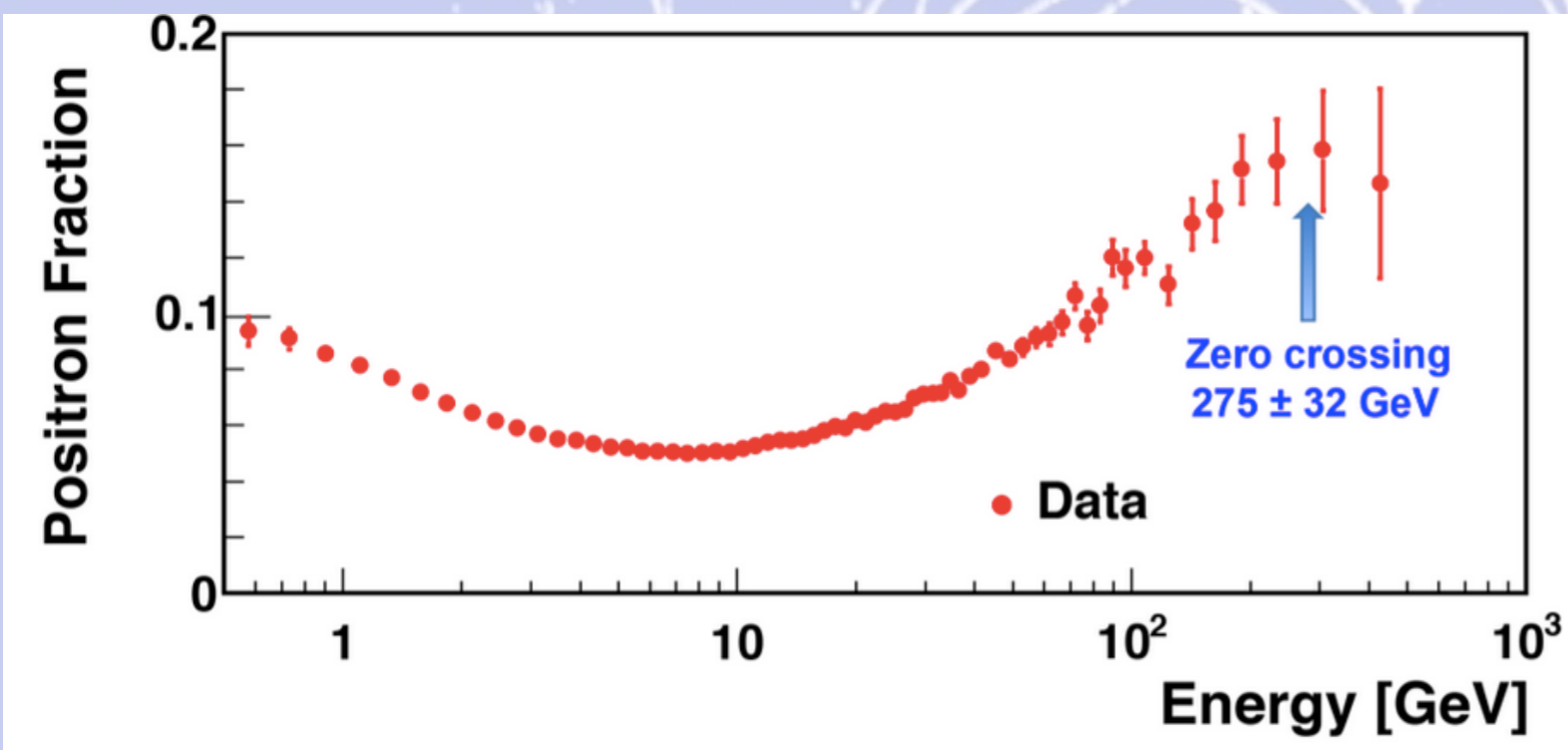

**Frazione di positroni  
misurata da AMS-02  
(Sett. 2014)**

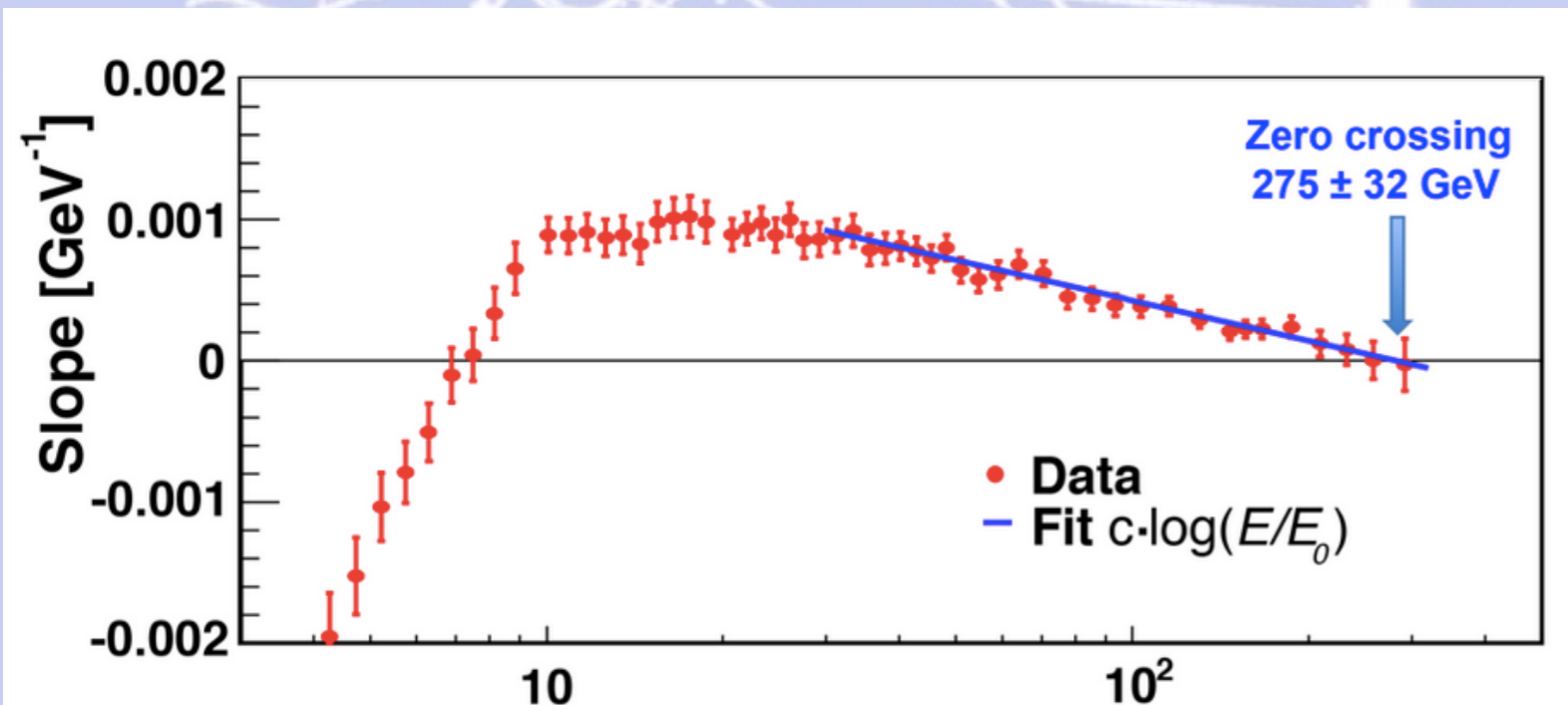

# Flusso combinato $e^\pm \times E^3$ misurato da AMS (Sett. 2014)

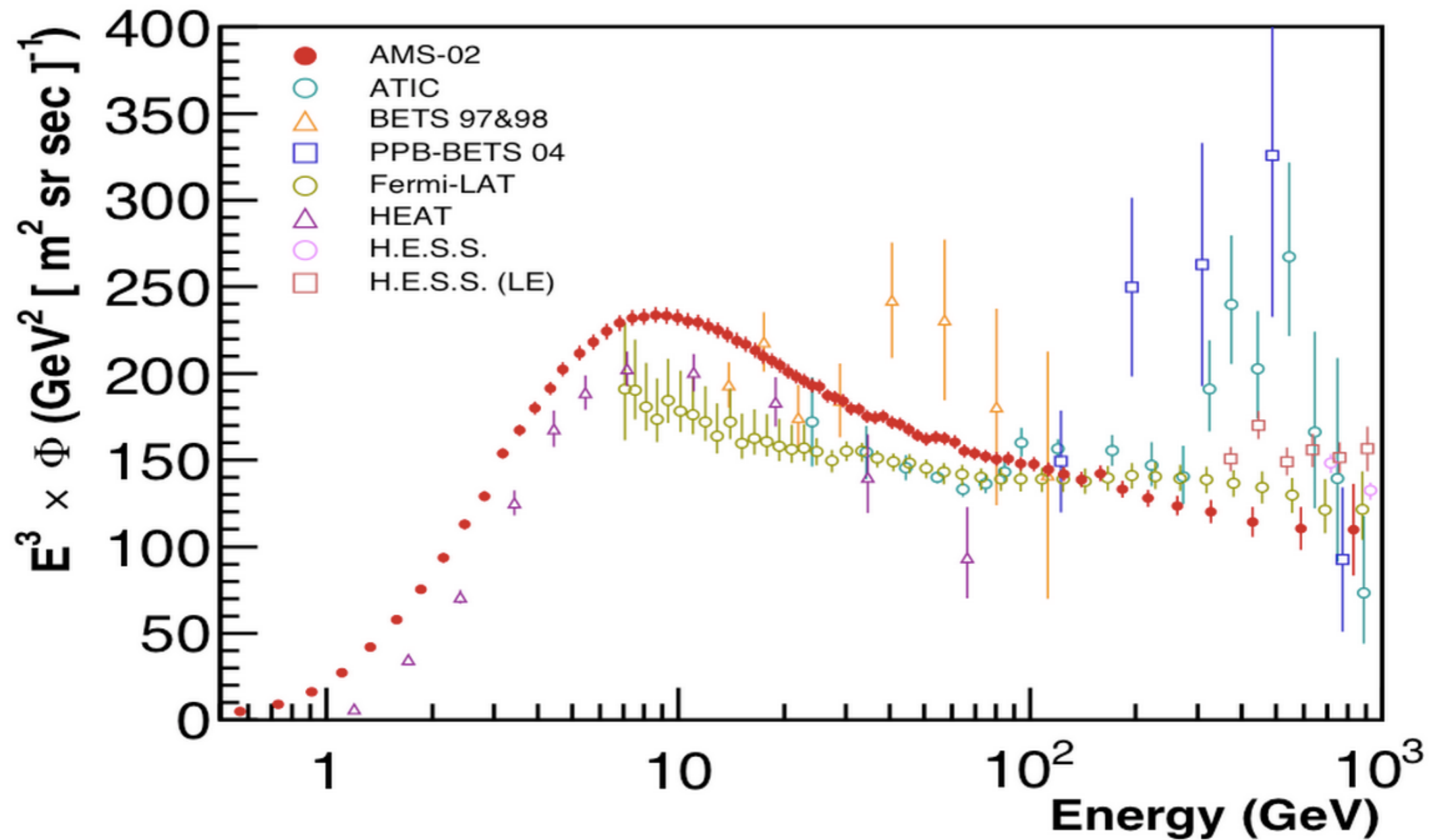

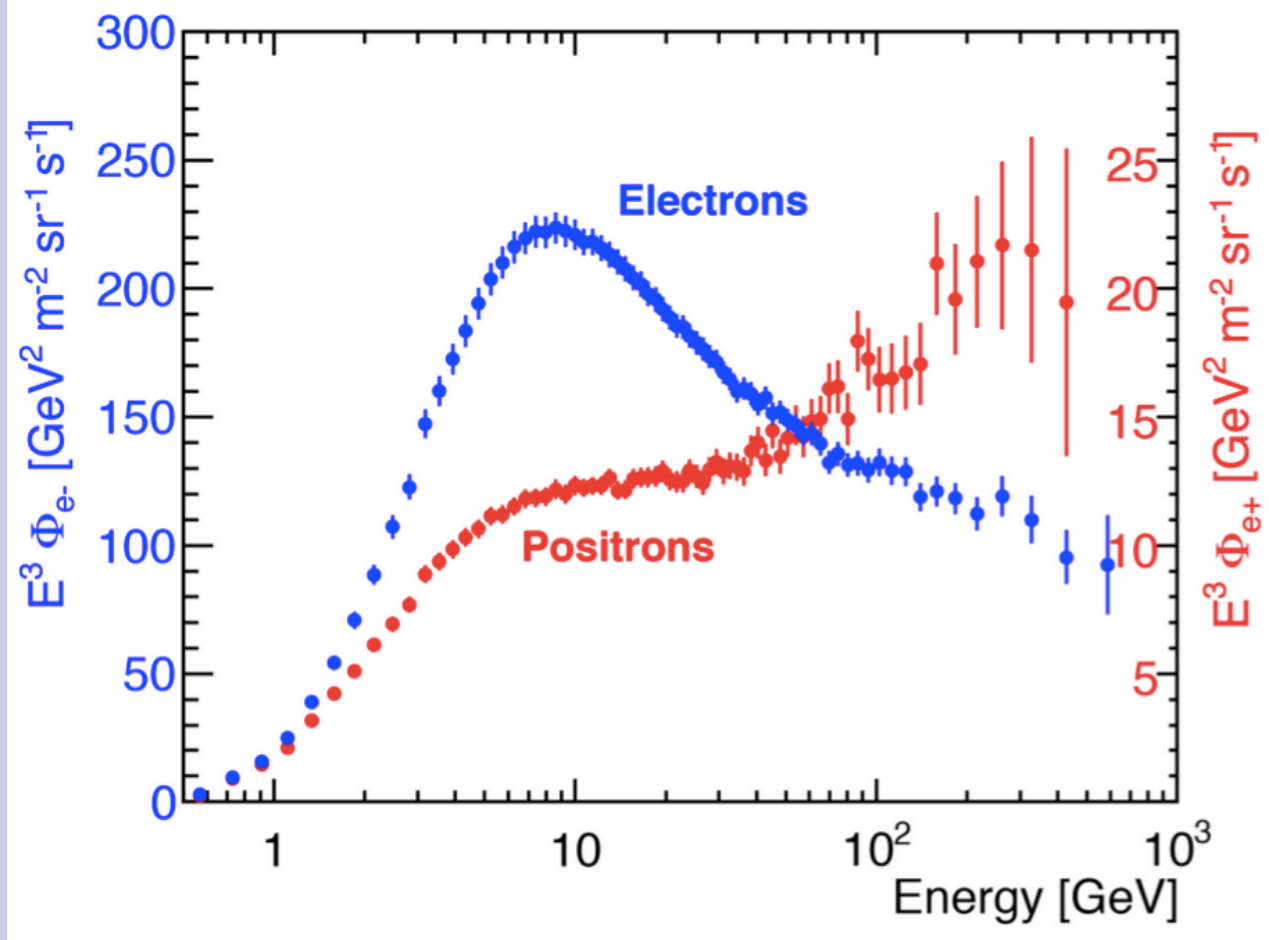

**Flusso degli elettroni e dei positroni (Sett. 2014)**

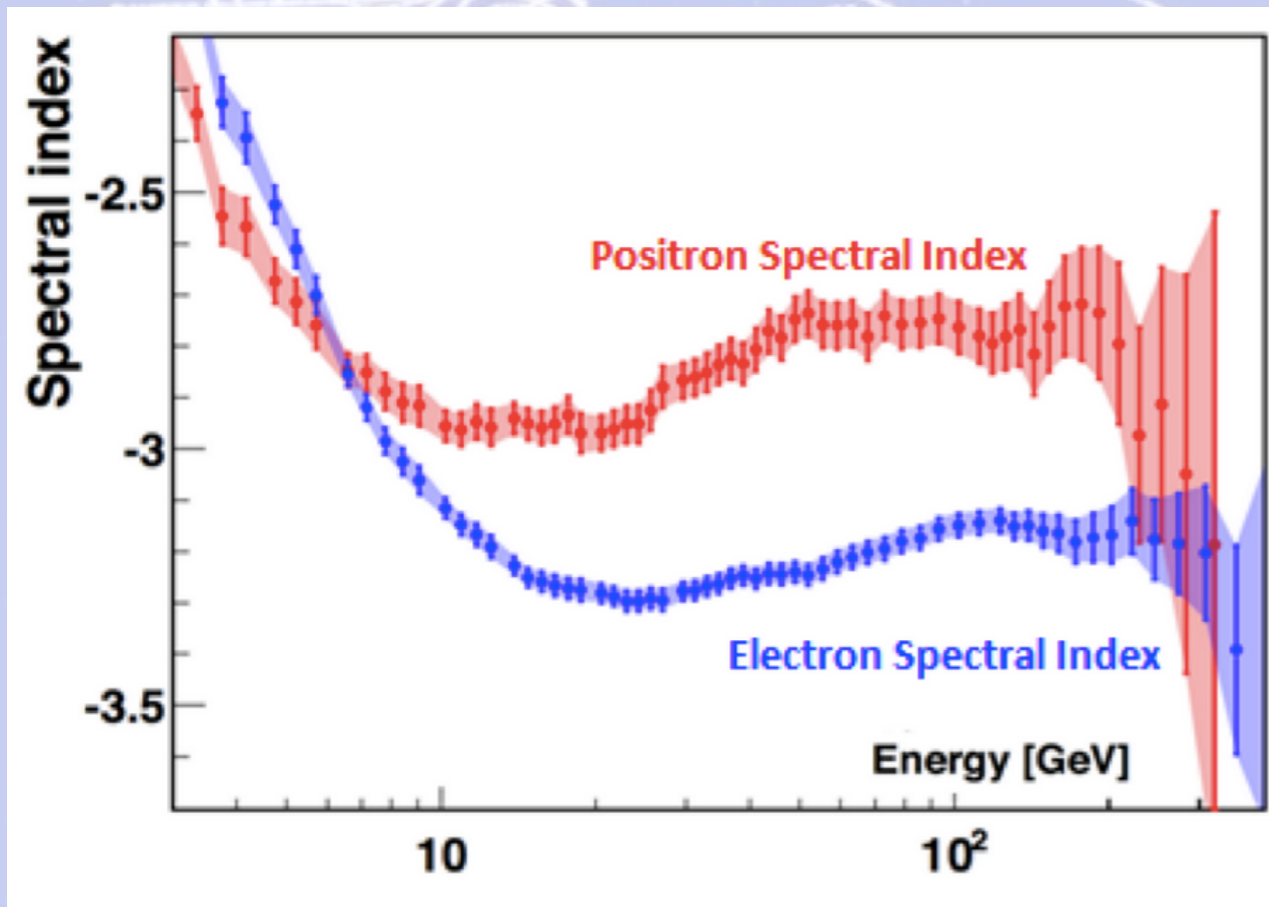

**Indice spettrale degli elettroni e dei positroni (Sett. 2014)**

# Flusso combinato $e^\pm \times E^3$ misurato da AMS (Sett. 2014)

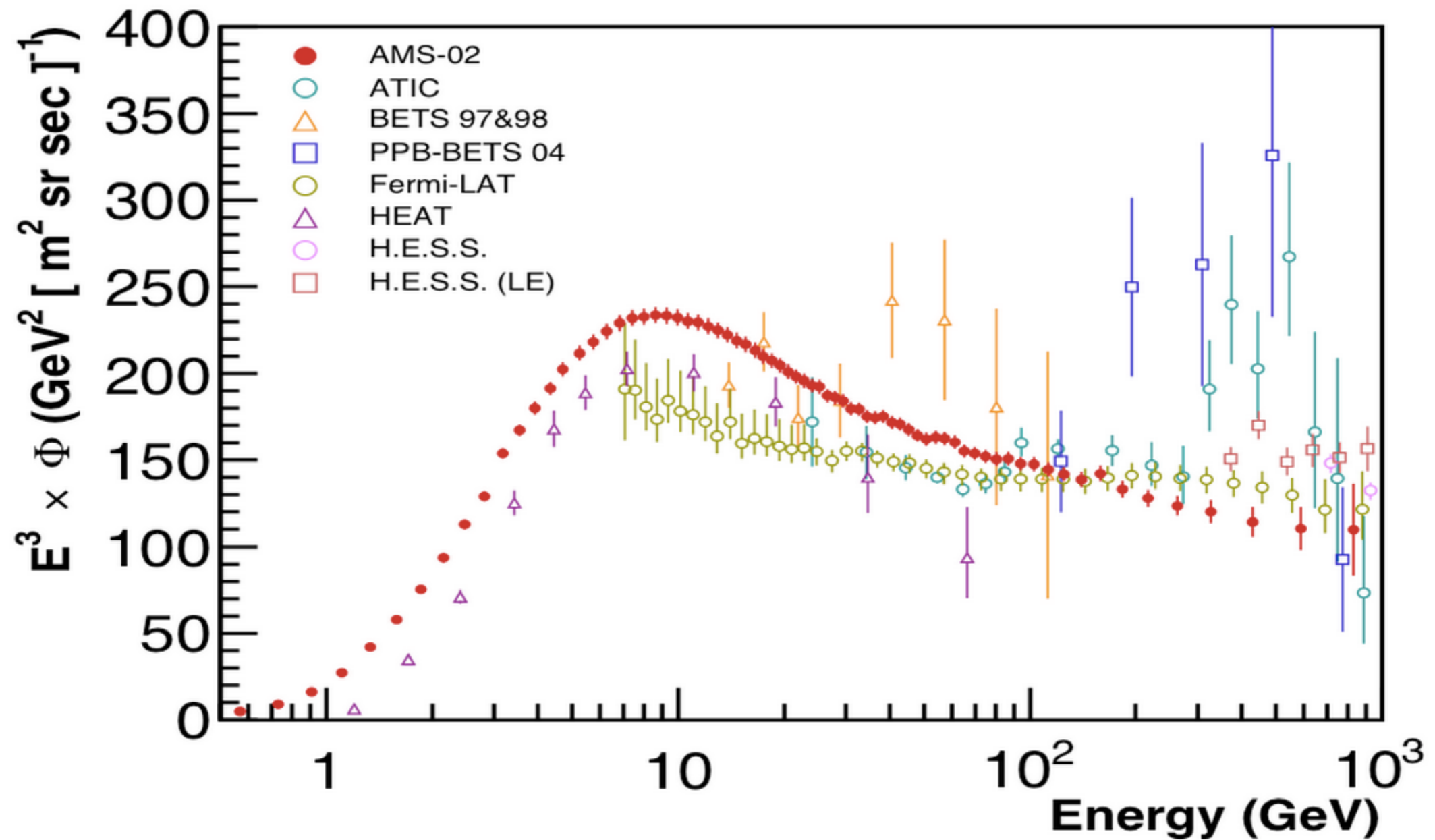

# La fisica di AMS-02: ricerca di antimateria cosmica residua (limite sulla presenza di $\bar{\text{He}}$ )

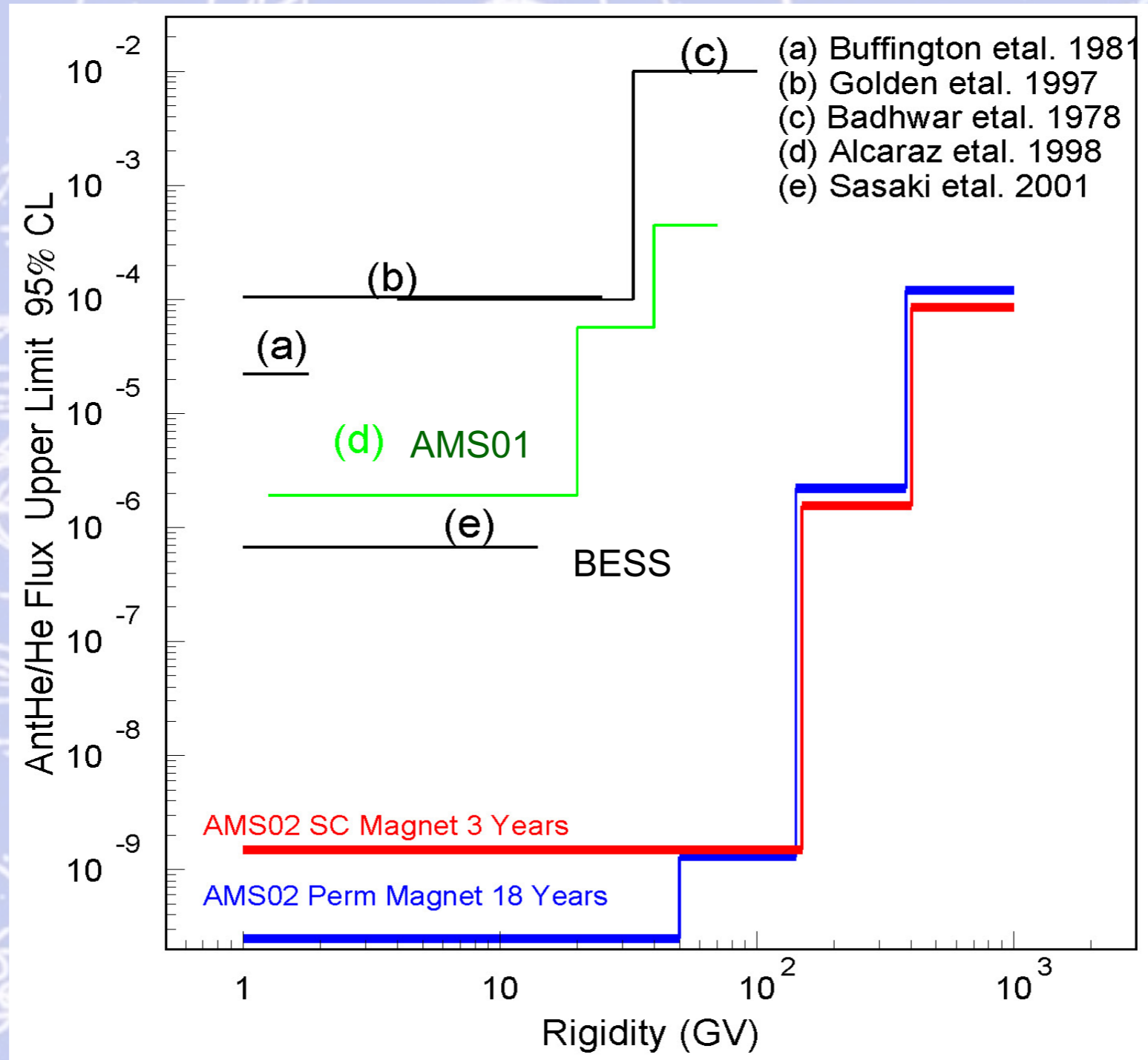





**(aggiornamento a settembre 2016)**

# Positroni ed elettroni

Positron fraction analysis: dopo 5 anni di presa dati  $\Leftrightarrow 85 \cdot 10^9$  raggi

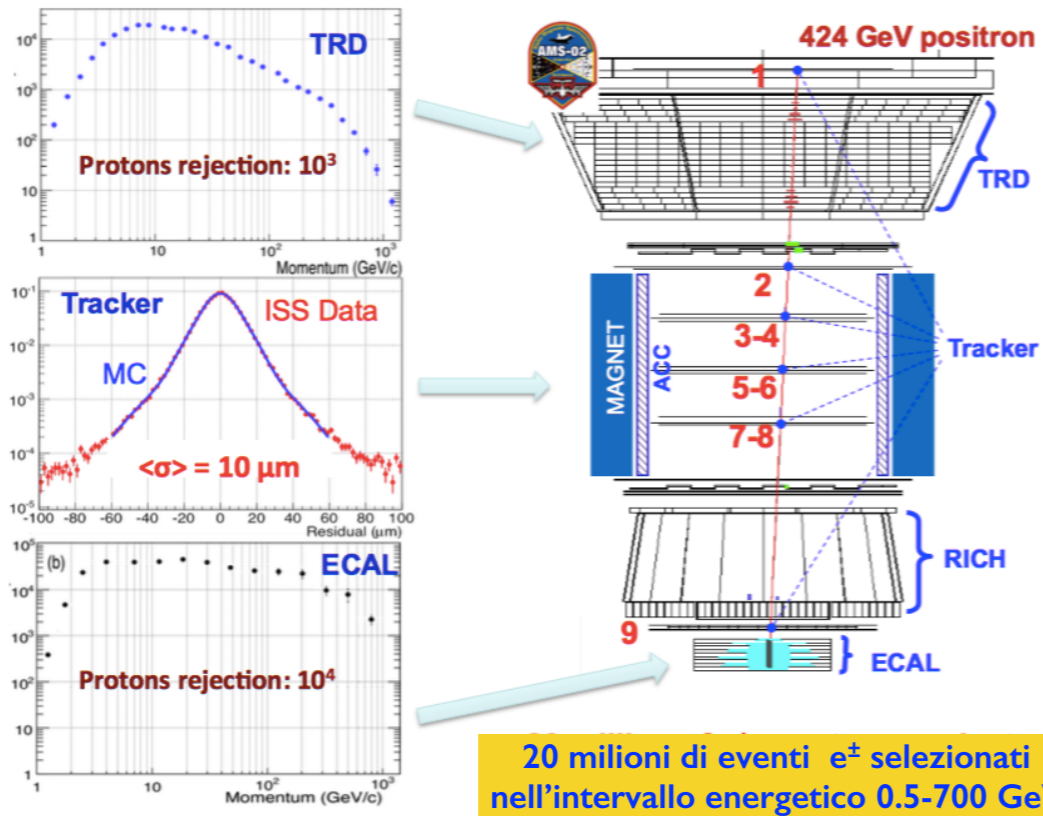

Rispetto al 2014: - intervallo energetico  $e^\pm$  esteso a 700 GeV  
- statistica  $e^\pm$  aumentata da 11 a 20 milioni di  $e^\pm$

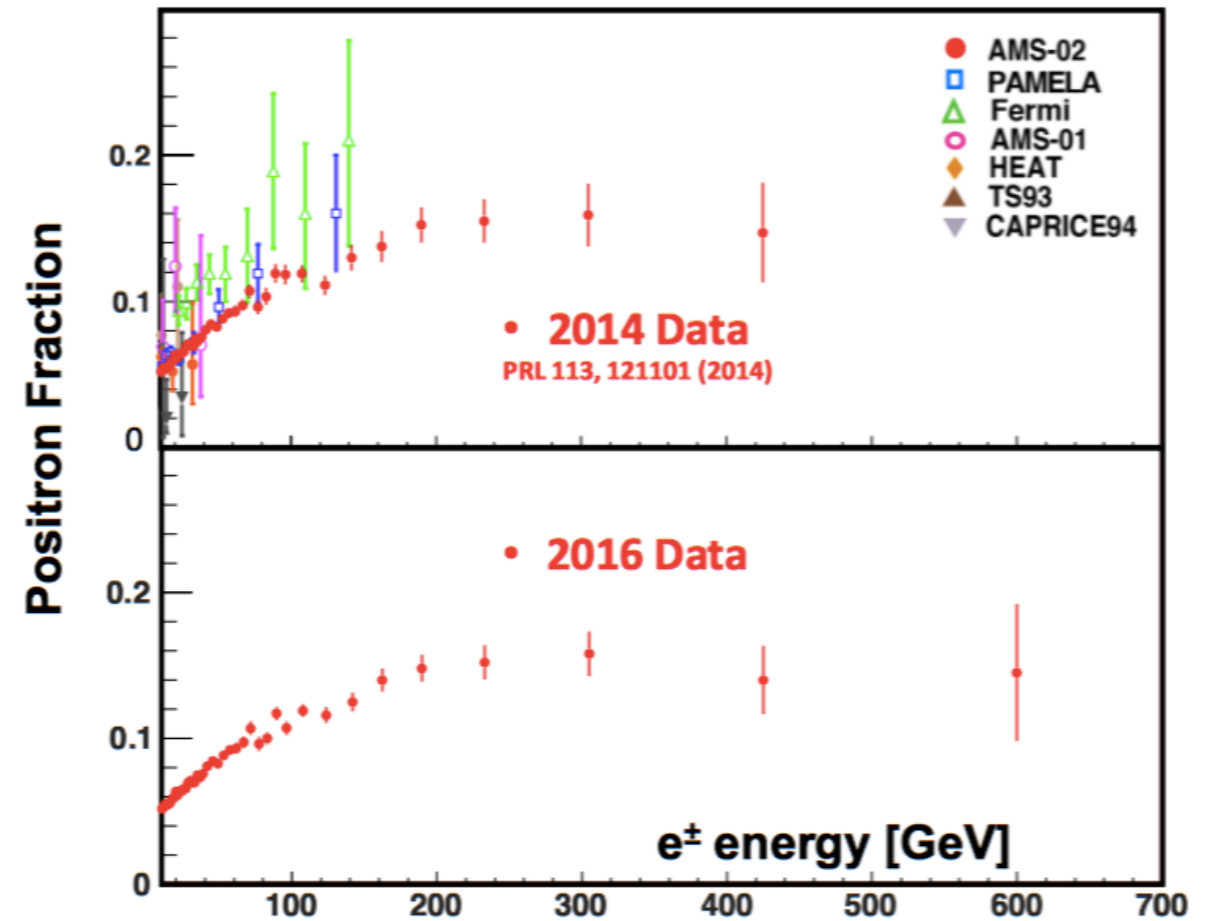

## Misura della Carica: ridondanza

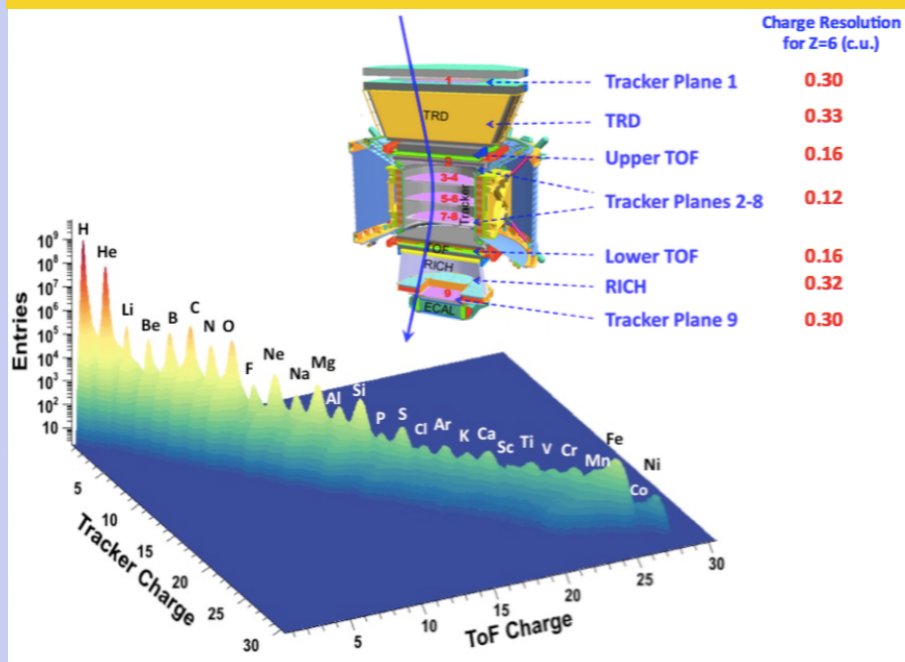

## TRD Estimator: - chiara separazione tra positroni e protoni

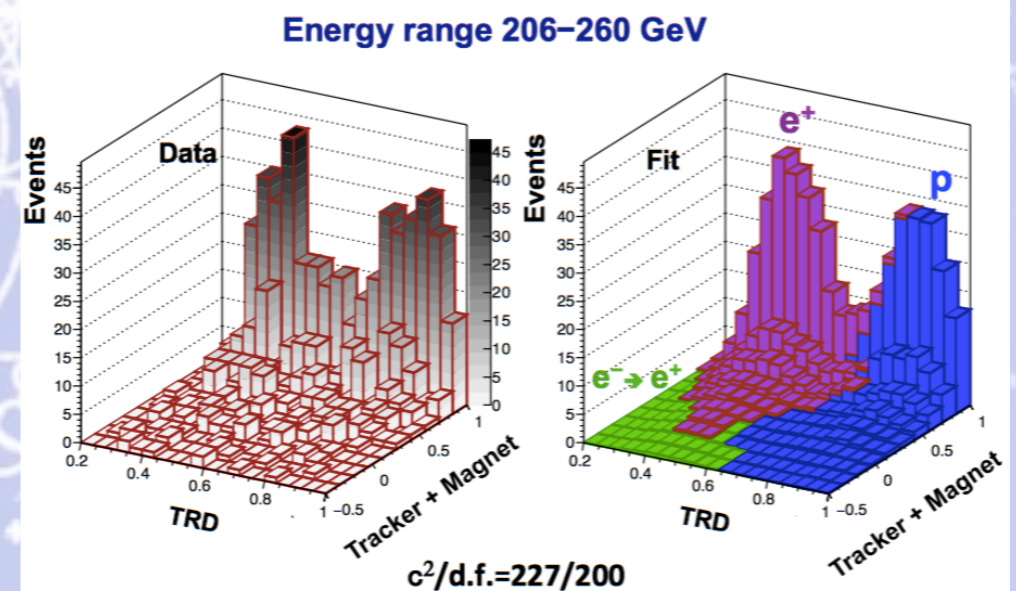

# Multiple Measurements of Charge

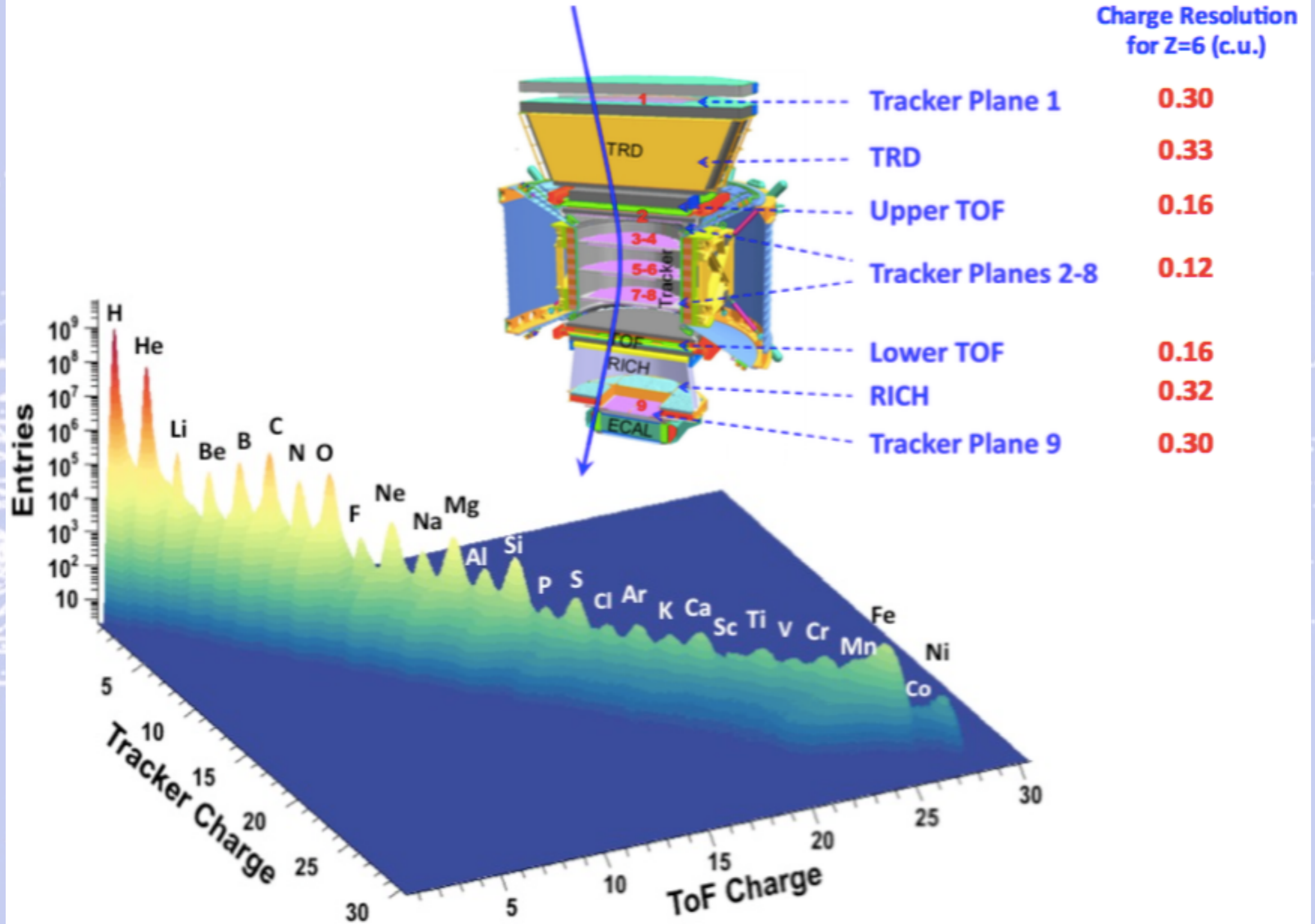

# Ciclo solare: inversione del campo magnetico solare

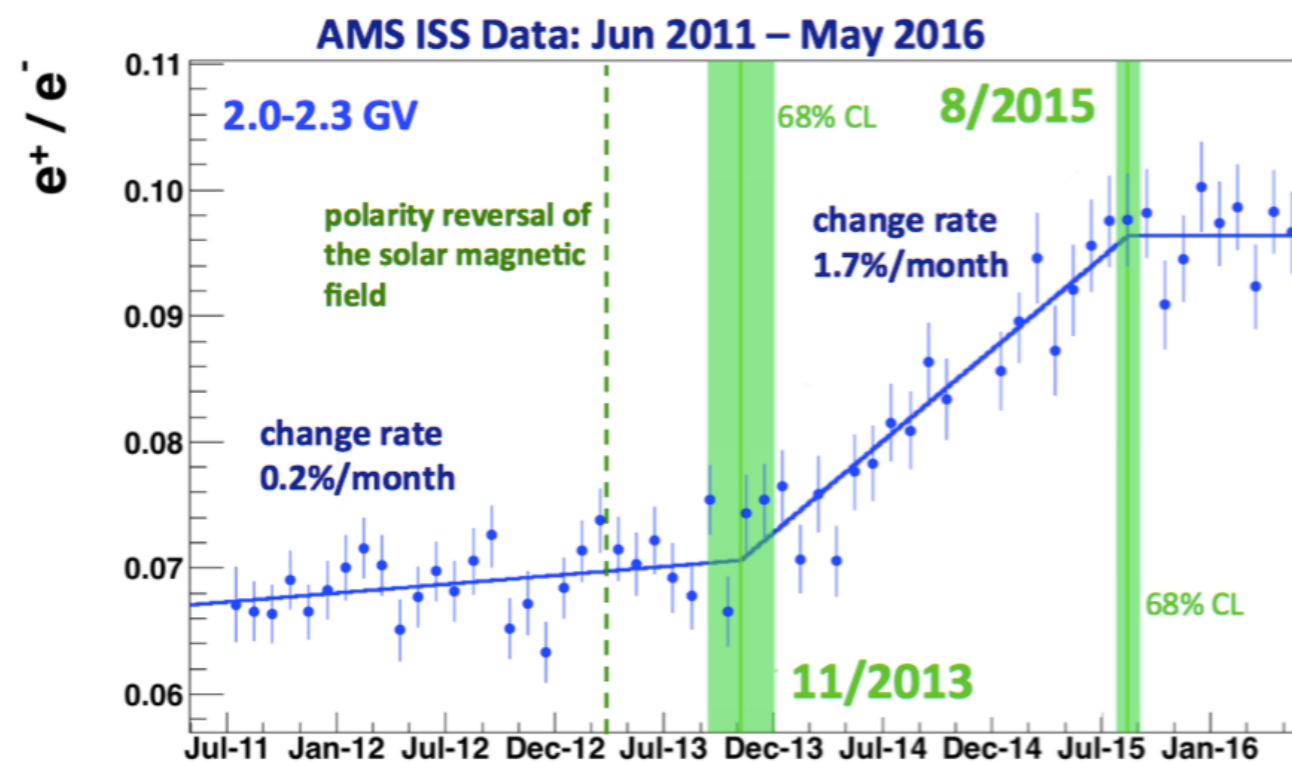

- After the reversal of the solar magnetic field in 03/2013 it takes  $(8 \pm 1.5)$  month till this has a visible effect on the  $e^+ / e^-$  ratio.
- It takes  $(21 \pm 1)$  month to stabilize the  $e^+ / e^-$  ratio again.

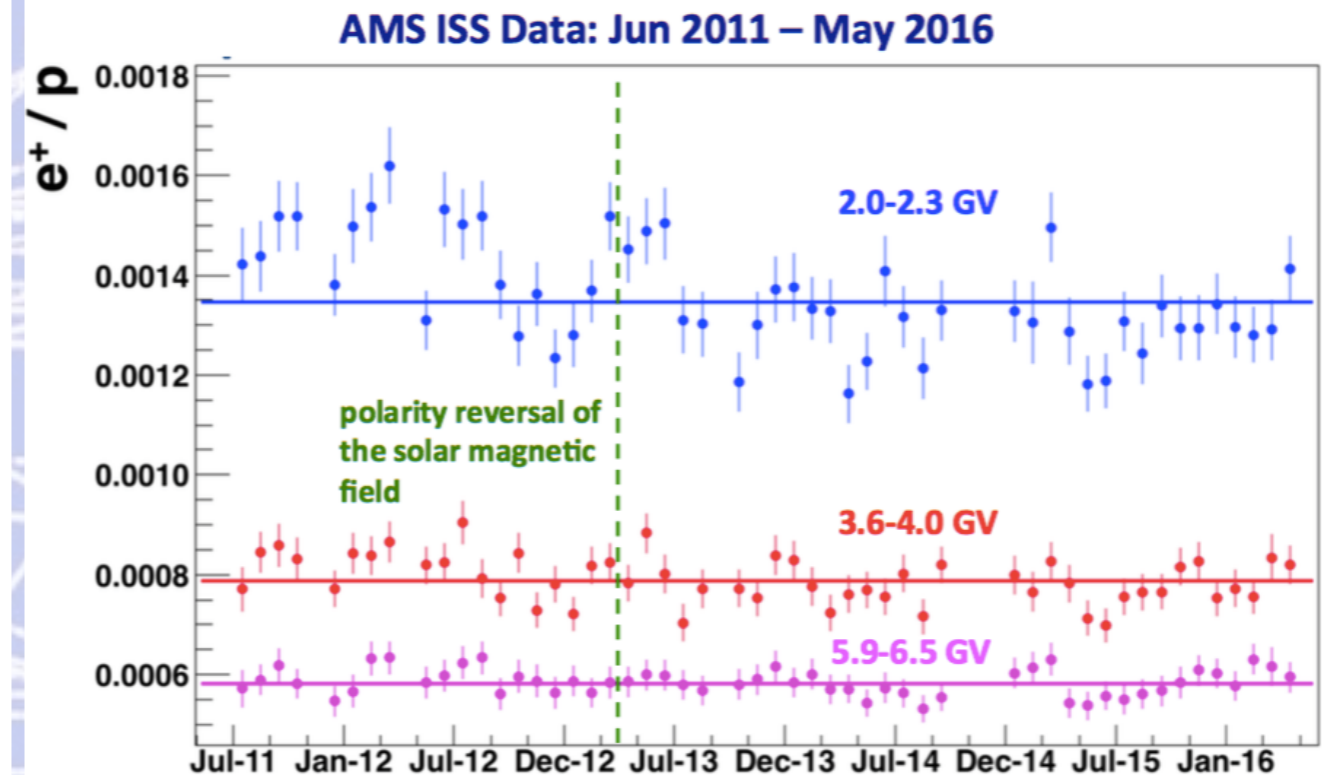

- The  $e^+ / p$  ratio does not show large variations as a function of time.
- The full power of the AMS high precision data sets can only be explored after time dependent effects are extracted and the data can be used to constrain the local interstellar spectra.

**AMS ed il monitoraggio continuo intorno alla Terra**

## Additional source of positrons

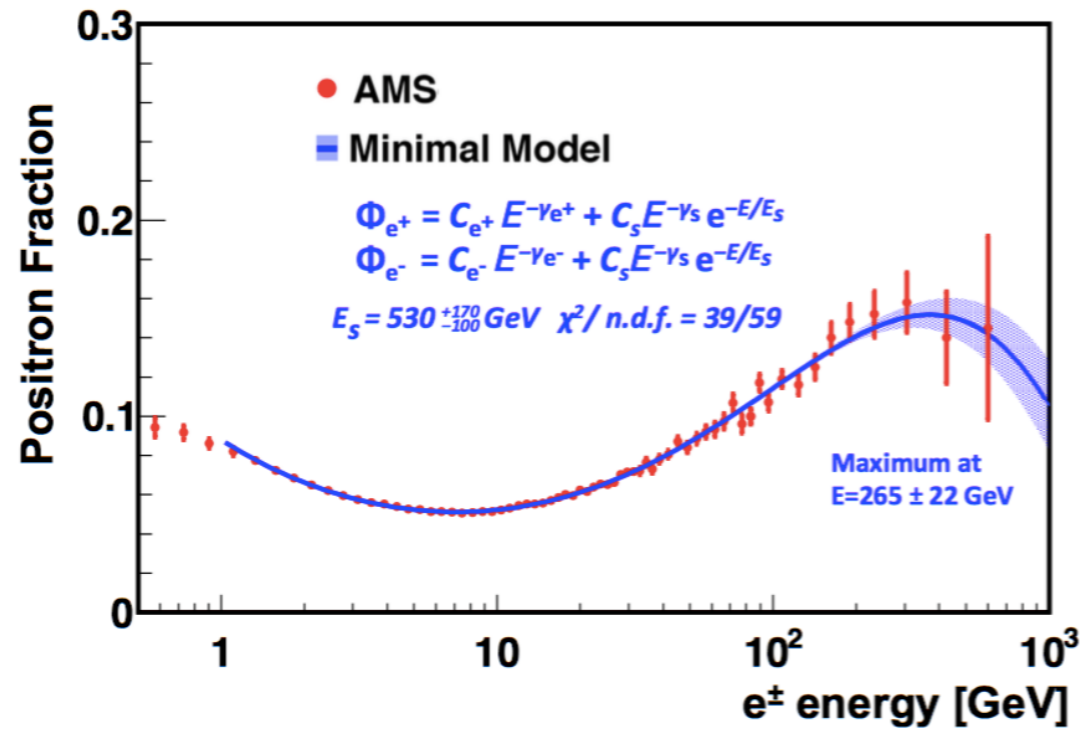

# Positroni ed elettroni: lo spettro (1)

The Positron Flux has no sharp structures and is dominated at high energies by the source term.

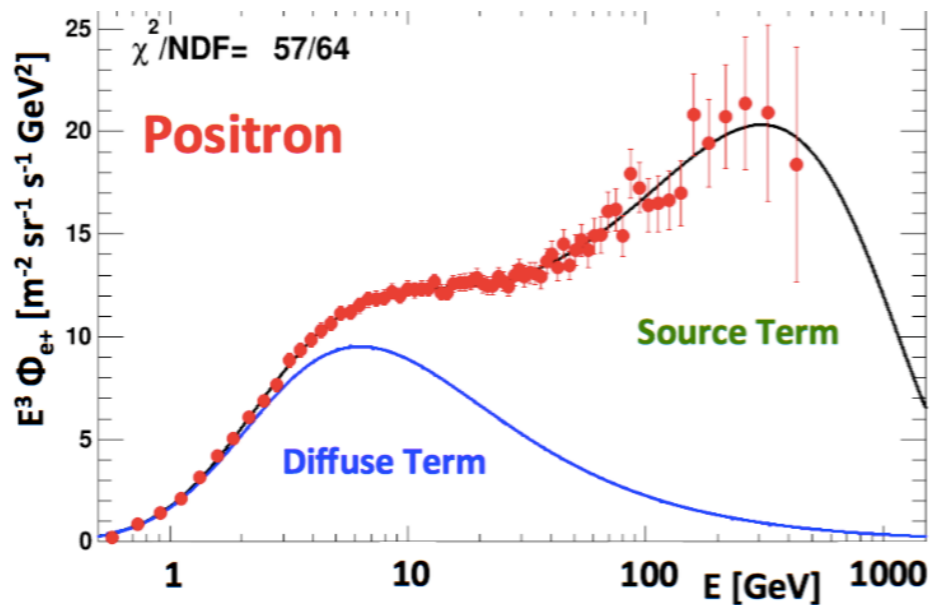

The source term parameters are constrained from the positron flux fit.

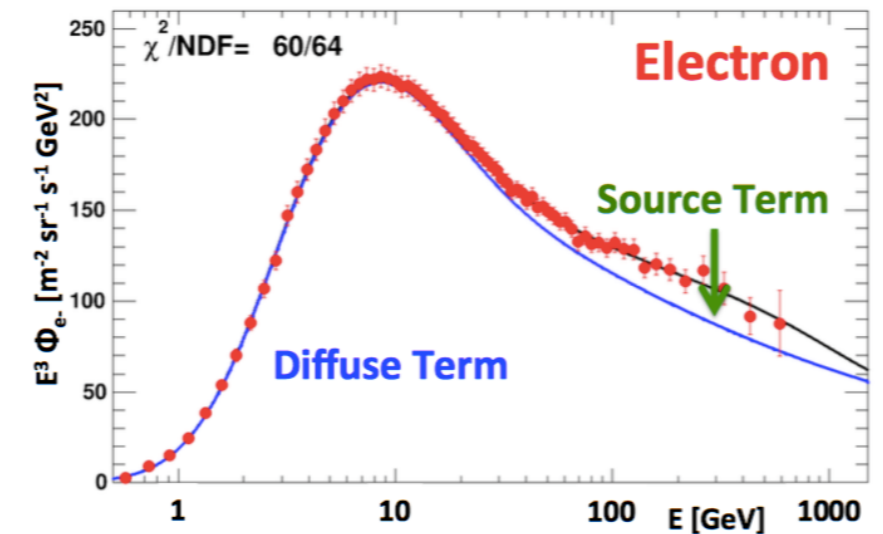

The Electron Flux

- has no sharp structures and is dominated by the diffuse term.
- is consistent with a charge symmetric source term.

The spectral index of the diffuse term has to become energy dependent:

$$\Phi_{e^-}(E) = \frac{E^2}{\hat{E}^2} \left[ C_{e^-} \hat{E}^{\gamma_{e^-}(\hat{E})} + C_S \hat{E}^{\gamma_S} \exp(-\hat{E}/E_S) \right]$$

The source term parameters are constrained from the positron flux fit.

$$\Phi_{e^+}(E) = \frac{E^2}{\hat{E}^2} \left[ C_{e^+} \hat{E}^{\gamma_{e^+}} + C_S \hat{E}^{\gamma_S} \exp(-\hat{E}/E_S) \right] \text{ with } E_S = 530 \text{ GeV from the } e^+/(e^+ + e^-) \text{ fit}$$

and  $\hat{E} = E + \Psi$  as the energy scale of the LIS

# Positroni ed elettroni: lo spettro (3)

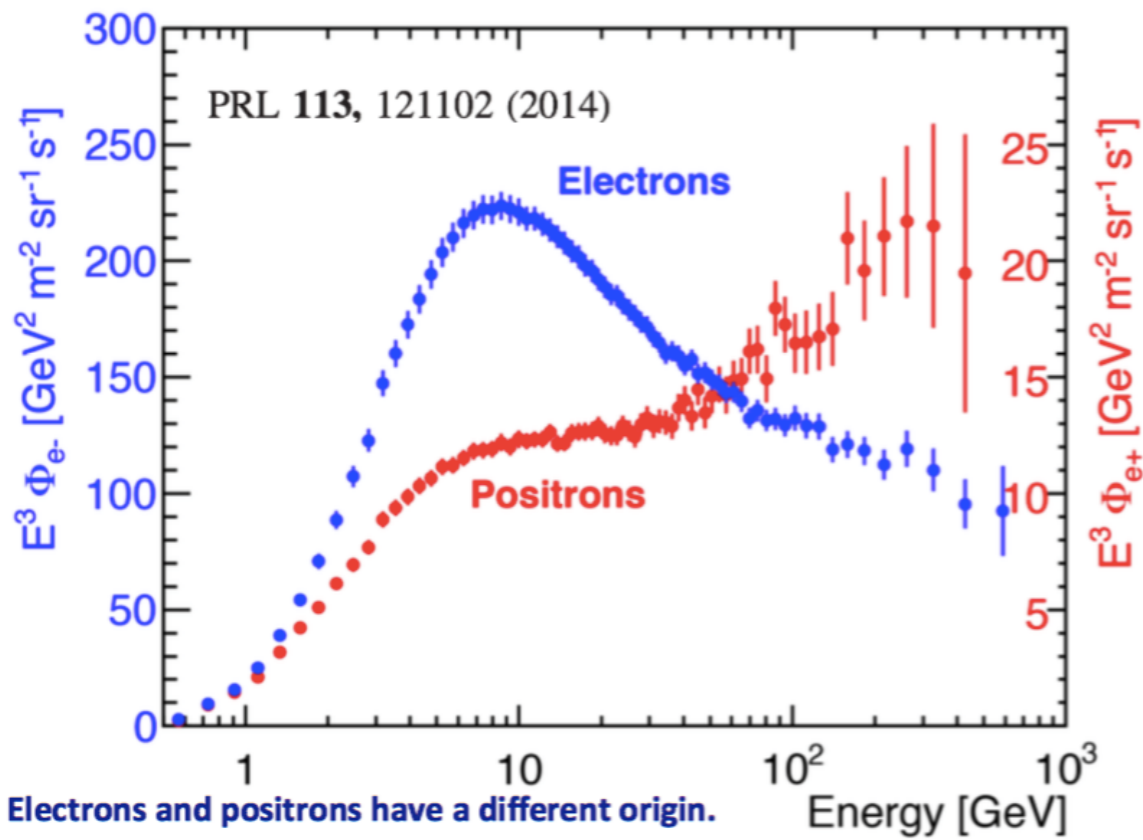

- Electrons and positrons have a different origin.
- A „Standard Model“ to describe all our data does not exist.
- Therefore we have to use simple phenomenological models.

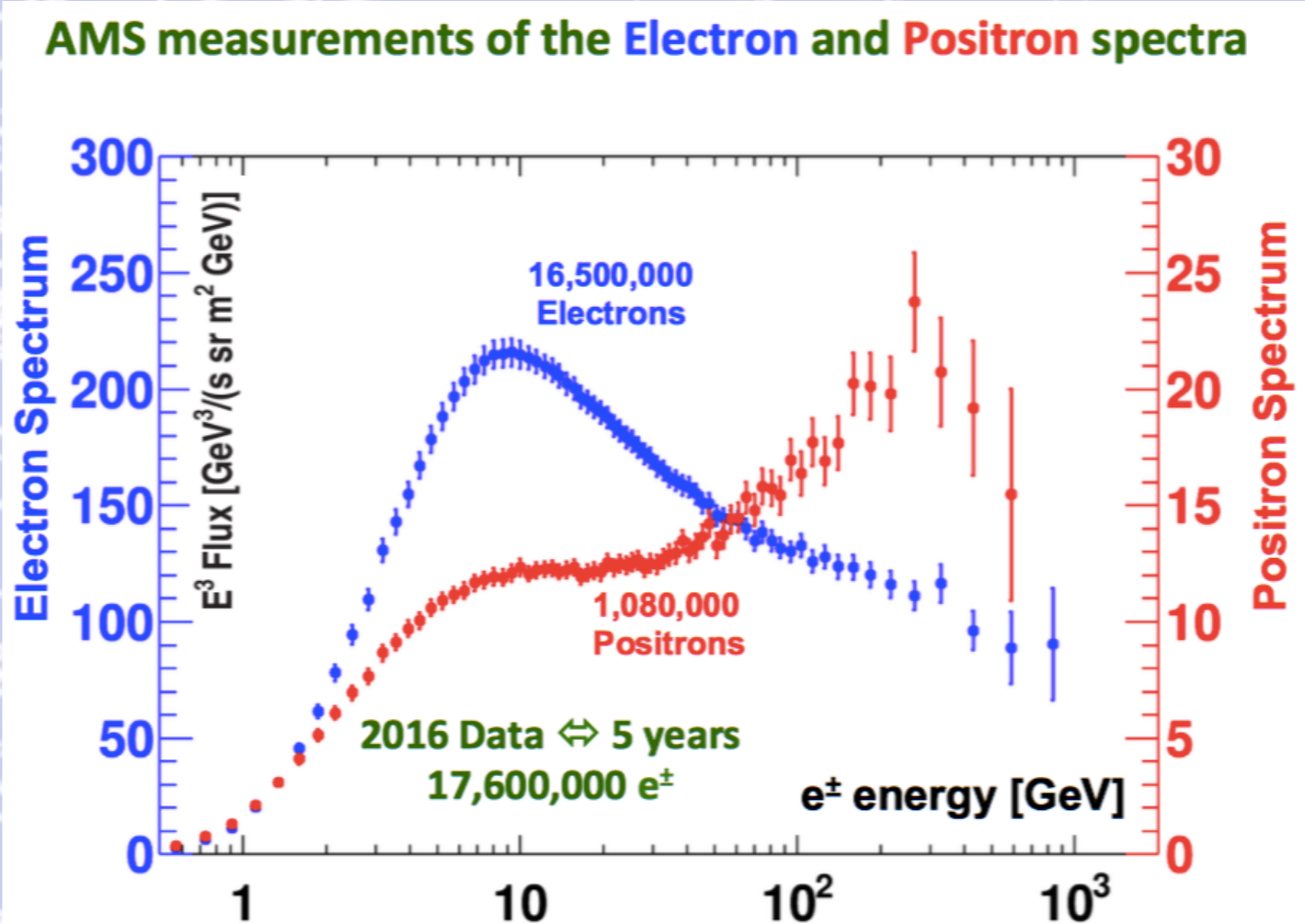

# Positroni: dati e previsioni

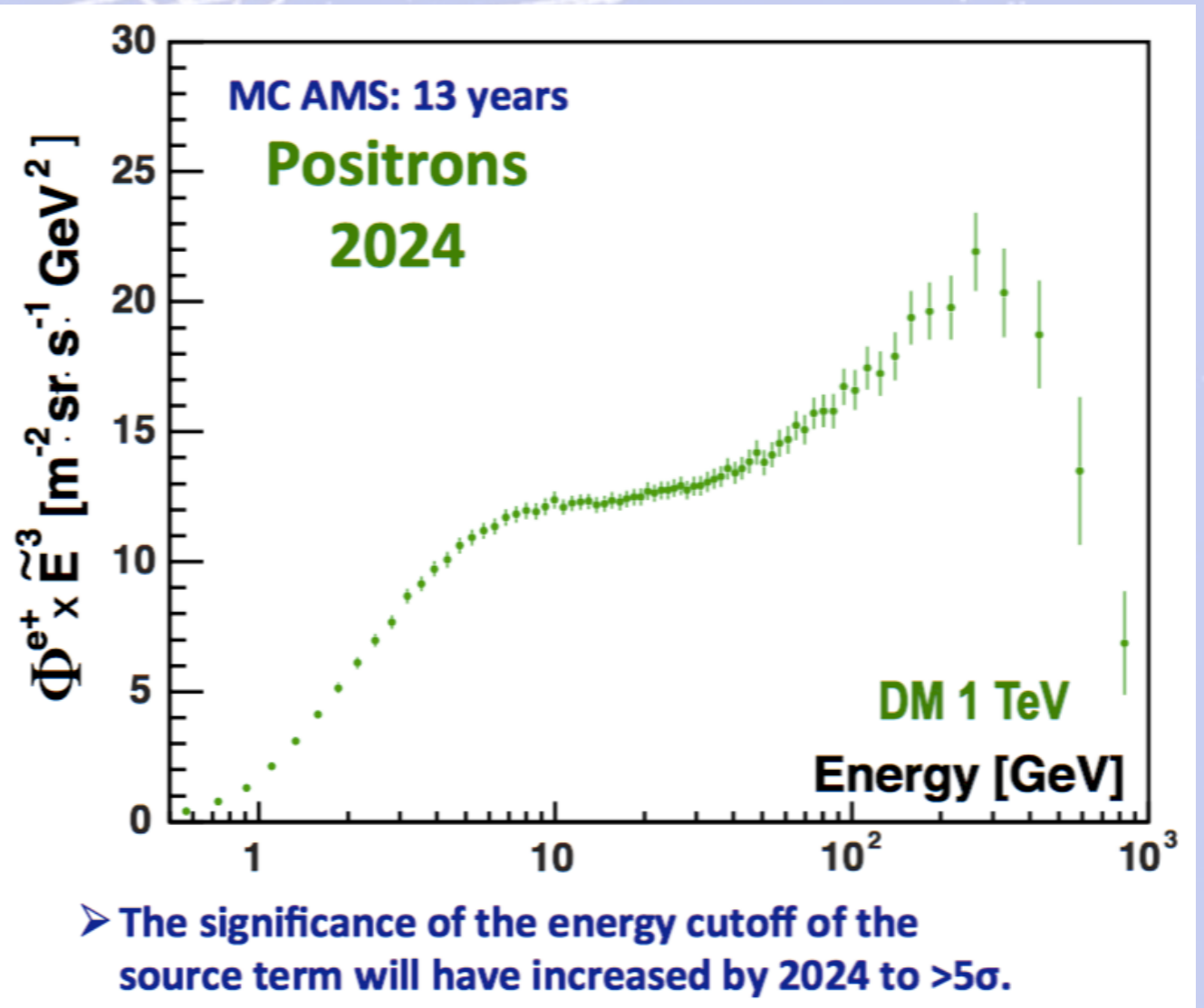
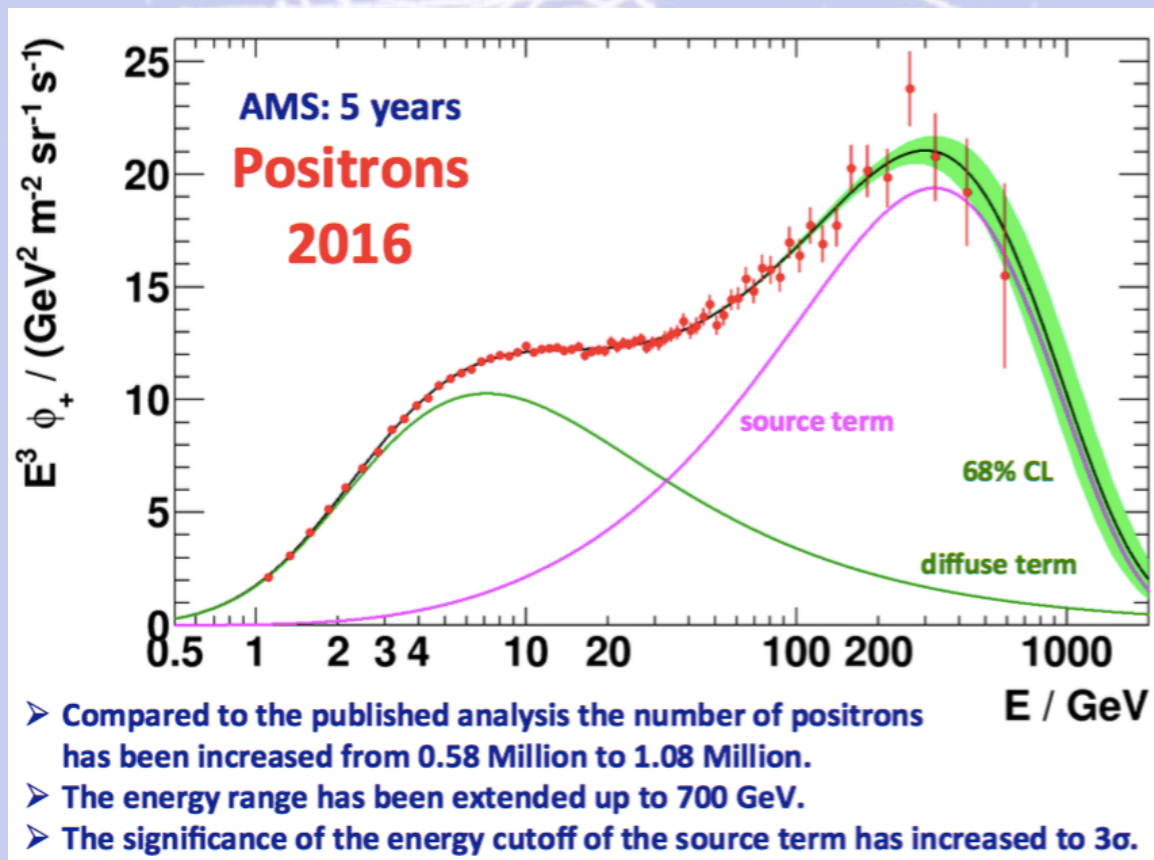
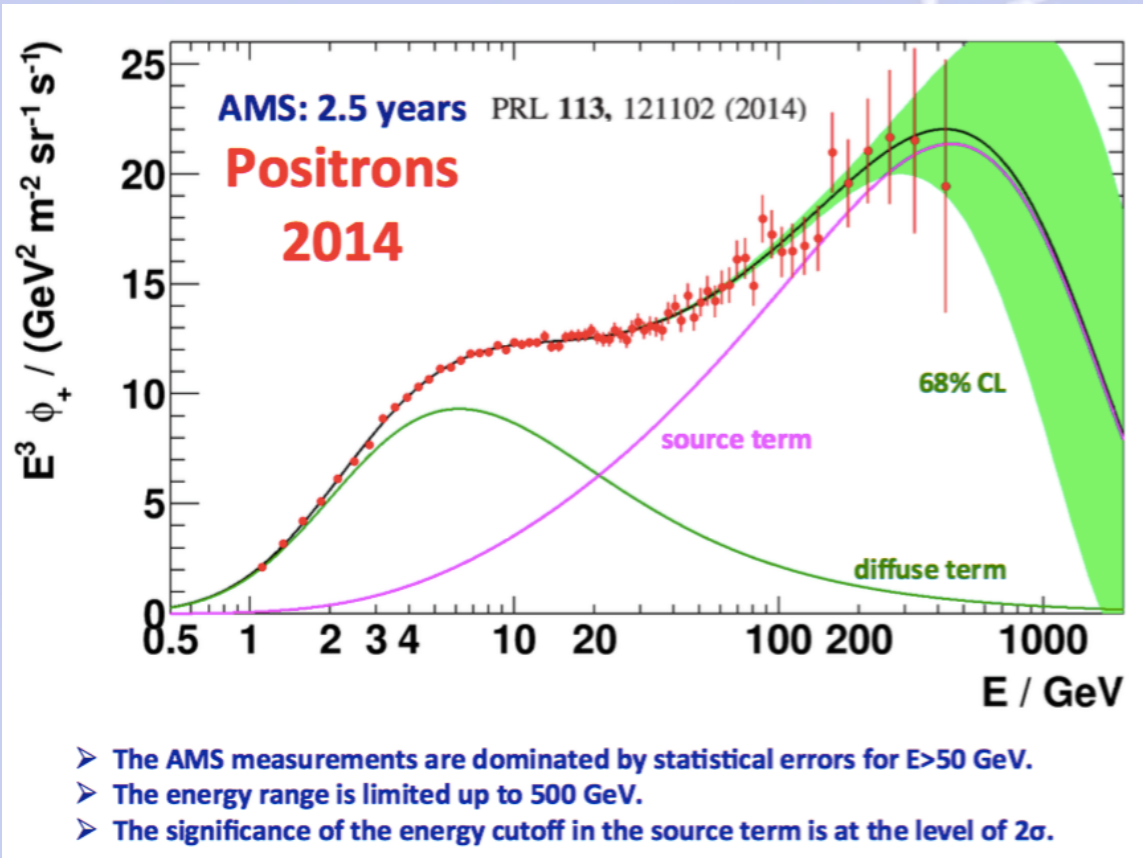

# Positroni, elettroni e protoni: segnale e fondo

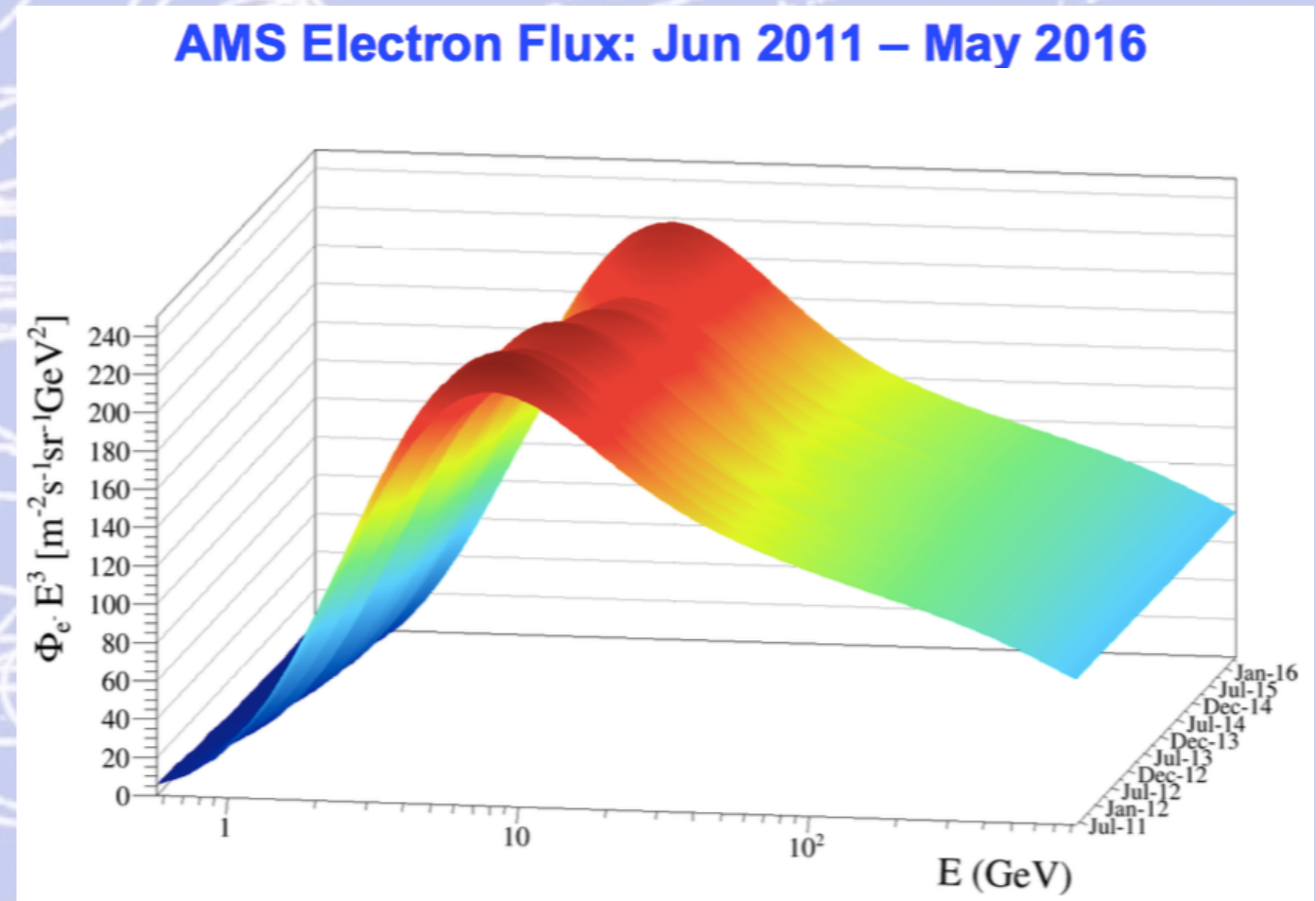
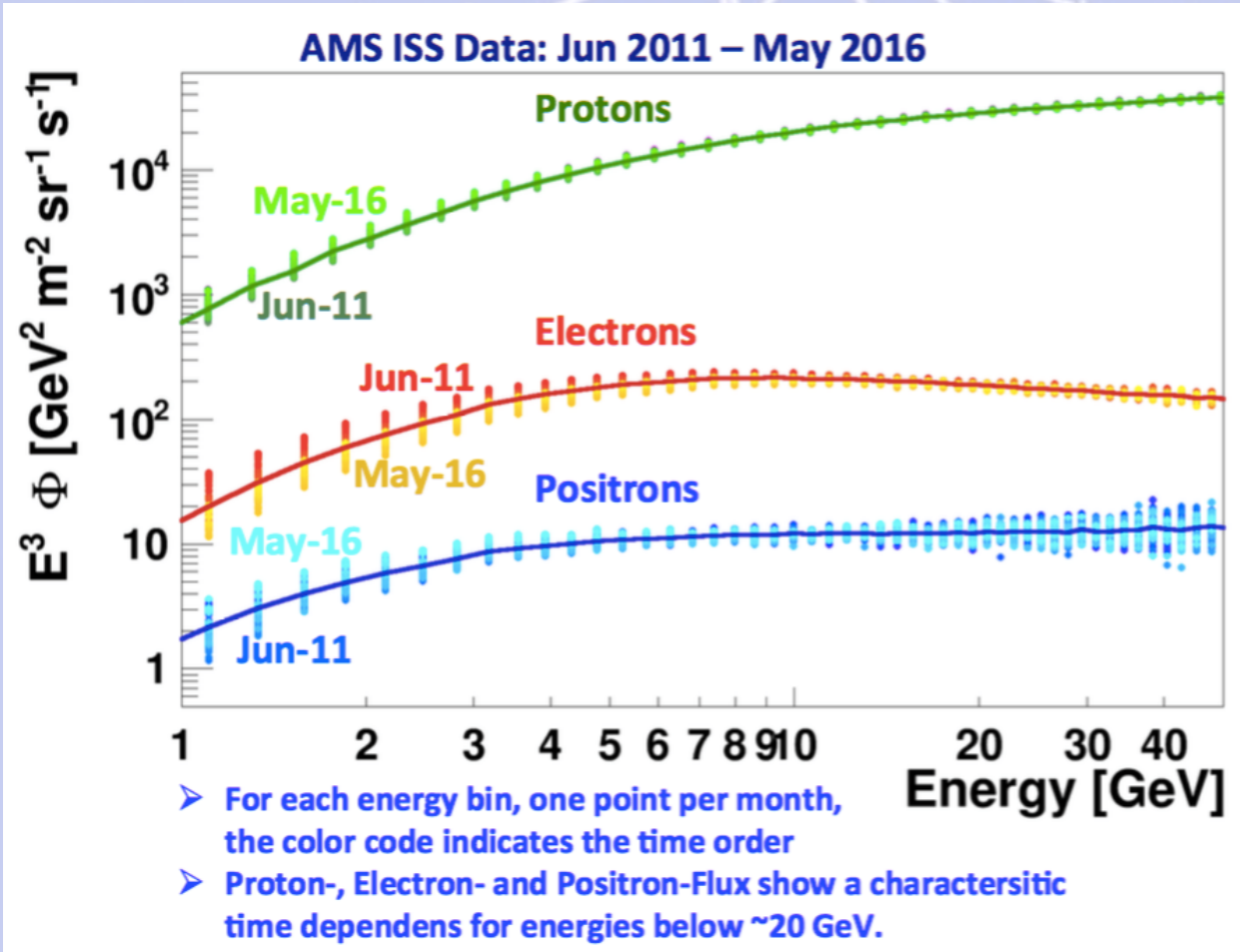



It was expected that the proton flux could be described with a single power law with spectral index  $\gamma=-2.7$ .

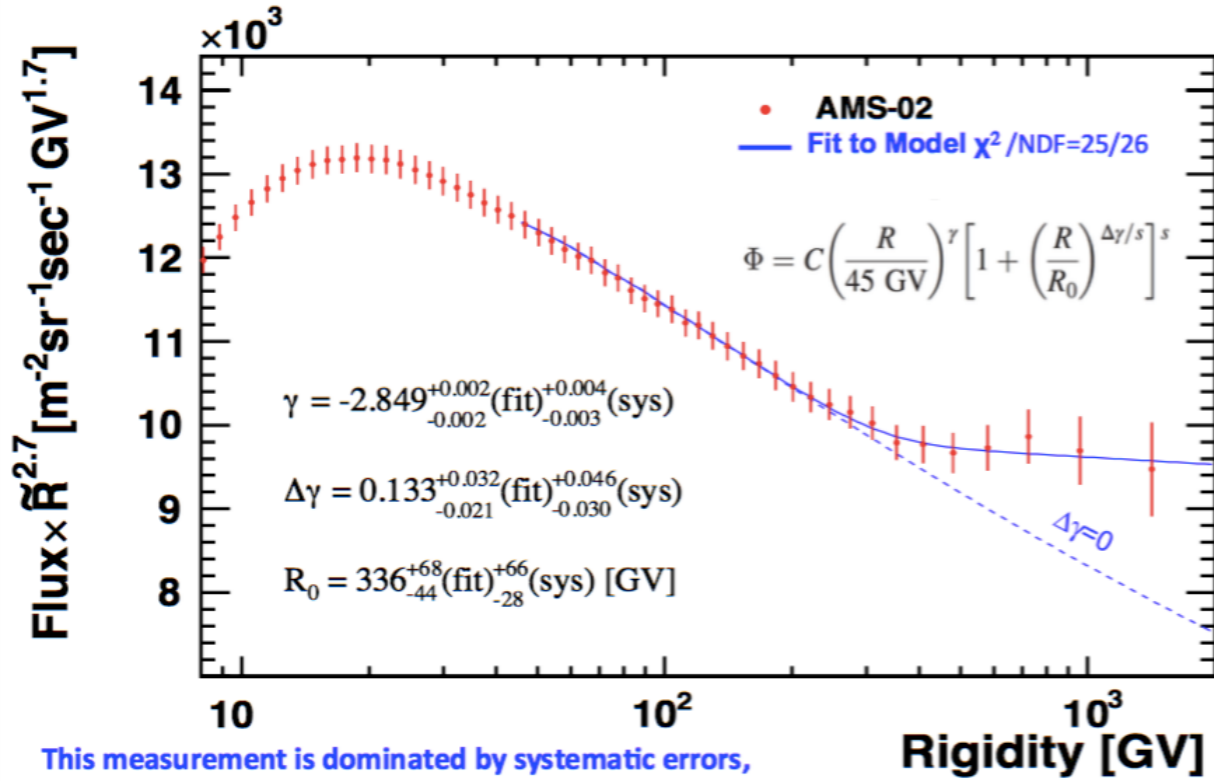

This measurement is dominated by systematic errors, we will therefore not be able to improve it.

# Protoni ed elio: flusso

It was expected that the He flux could be described with a single power law with spectral index  $\gamma=-2.7$ .

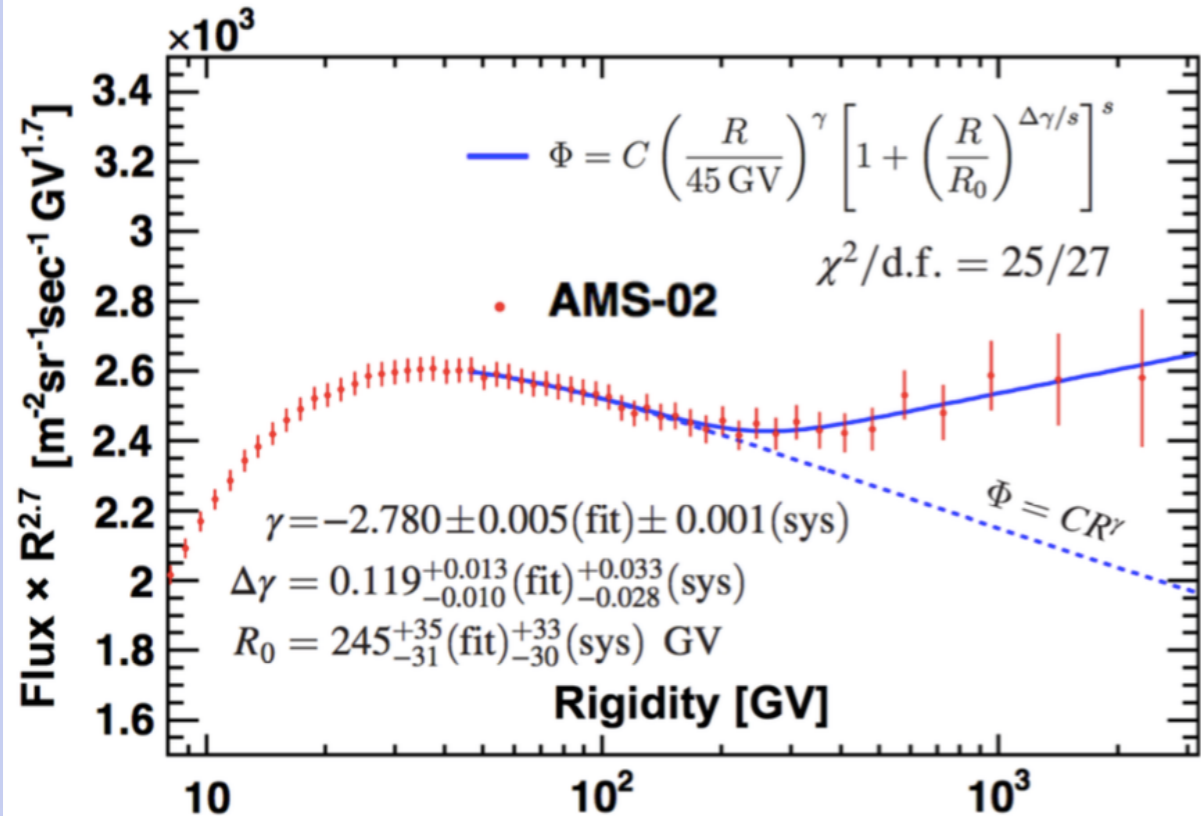

## The AMS proton/helium flux ratio

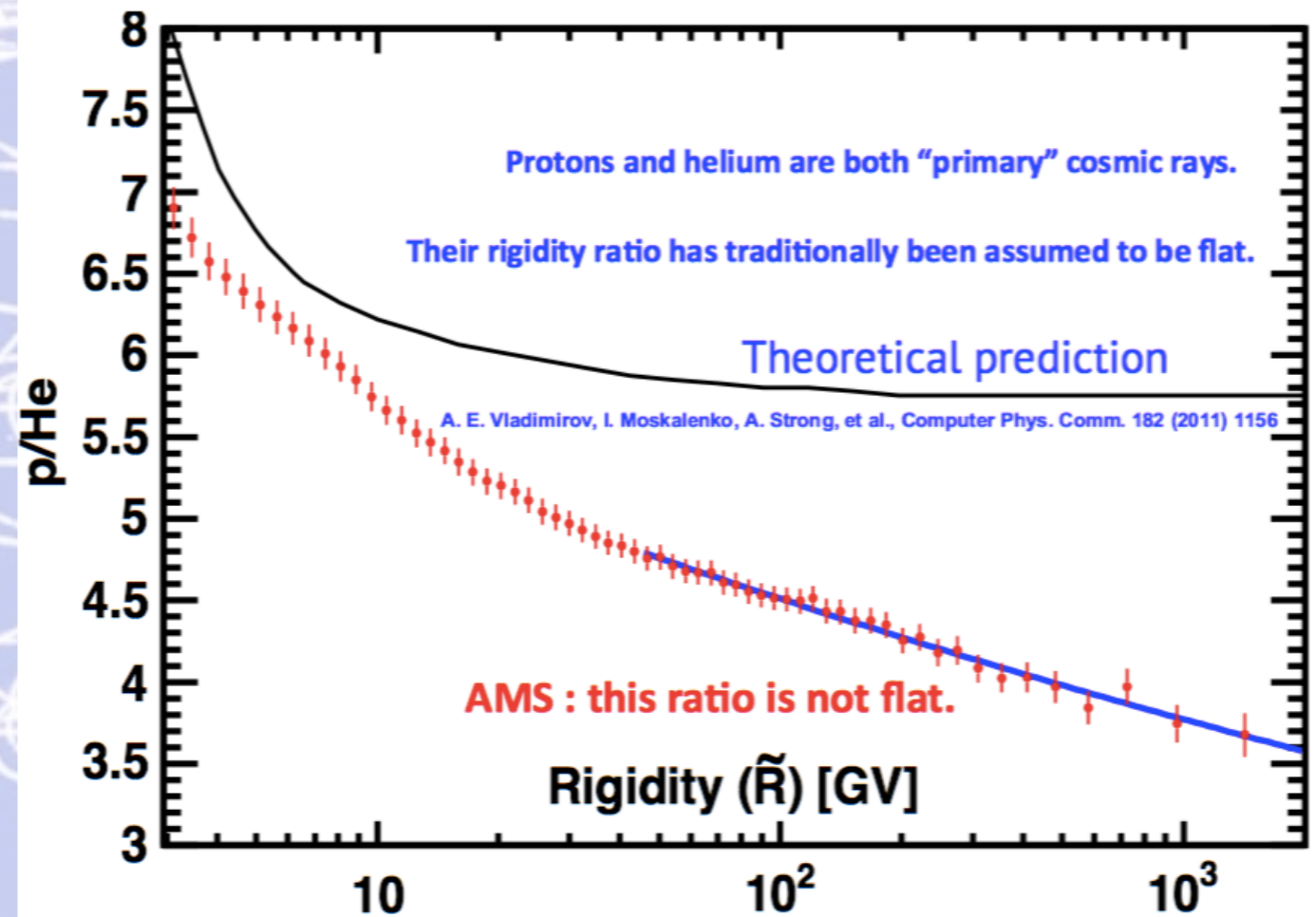

# Carbonio e Litio: flusso

AMS Carbon flux

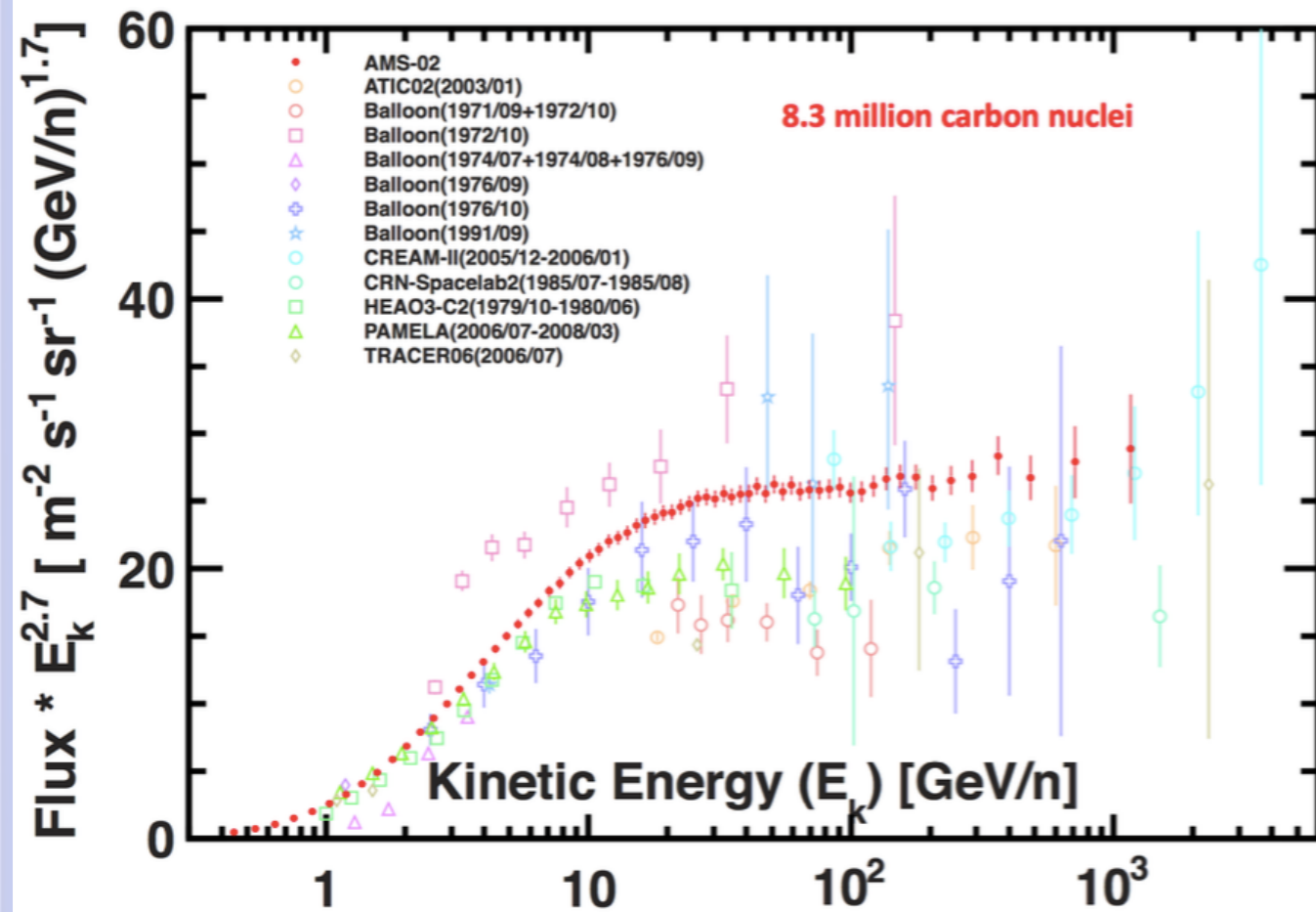

AMS Lithium flux

Up to now it was assumed that cosmic lithium is purely secondary in origin. The AMS data show that either cosmic lithium has also a primary origin or the diffusion coefficient that describes the propagation of cosmic rays is rigidity dependent.

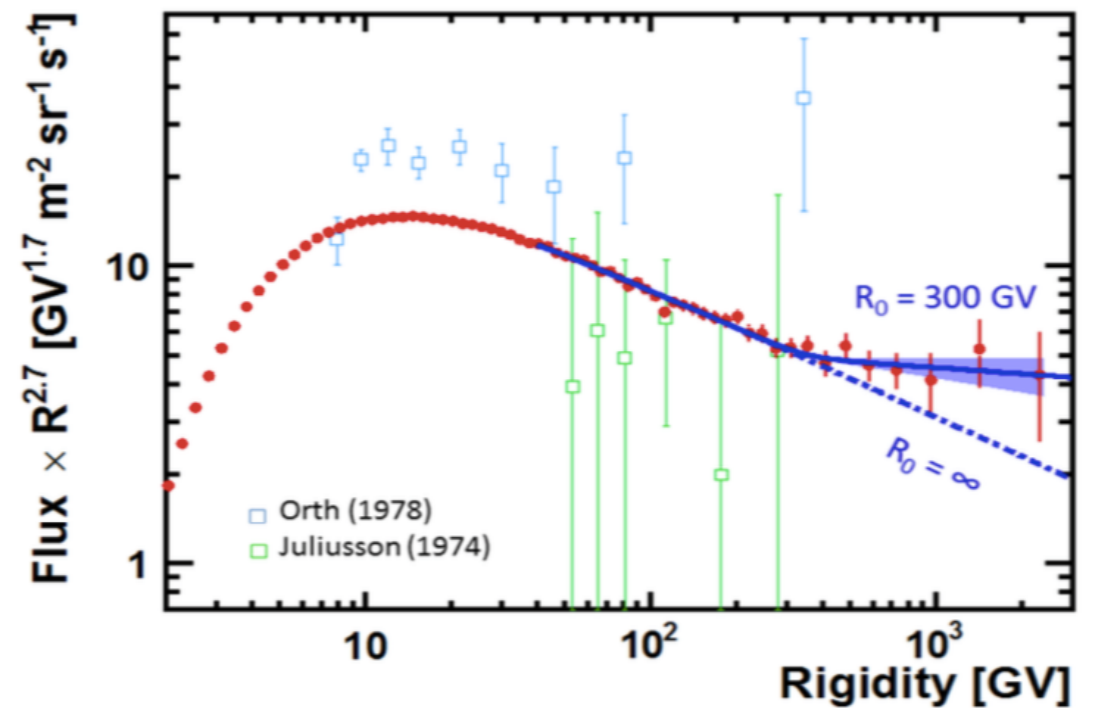

The AMS lithium flux fitted with a double power law  $\Phi=C \cdot (R/45\text{GV})^\nu \cdot (1+(R/R_0)^{\Delta\nu/s})^s$  (solid line, shaded region 1-sigma limits).

## Flux Ratios: Boron/Carbon and cosmic ray propagation

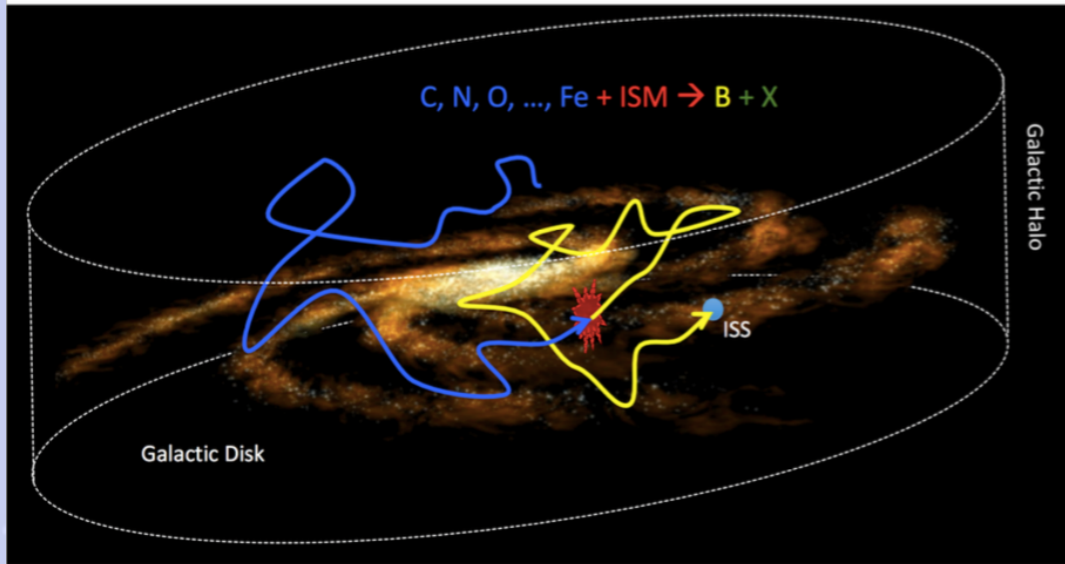

The boron-to-carbon ratio (B/C) is important in the determination of cosmic ray propagation. Boron is assumed to be produced from the collision of primary cosmic rays, such as carbon (C), with the interstellar medium (ISM), hence the B/C ratio provides information on cosmic ray propagation.

# Boro/Carbonio: dati e previsioni

## The AMS boron-to-carbon (B/C) flux ratio

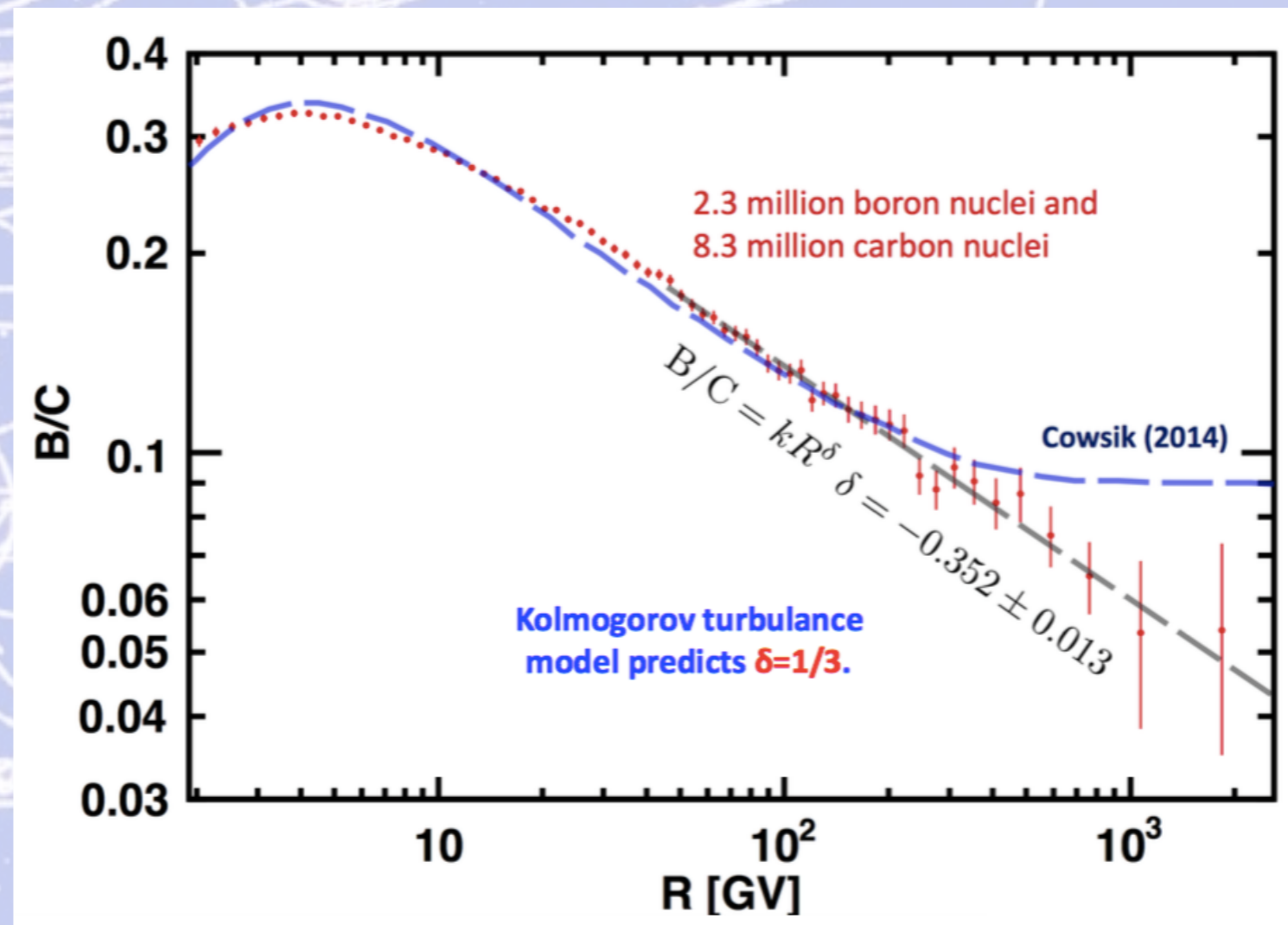
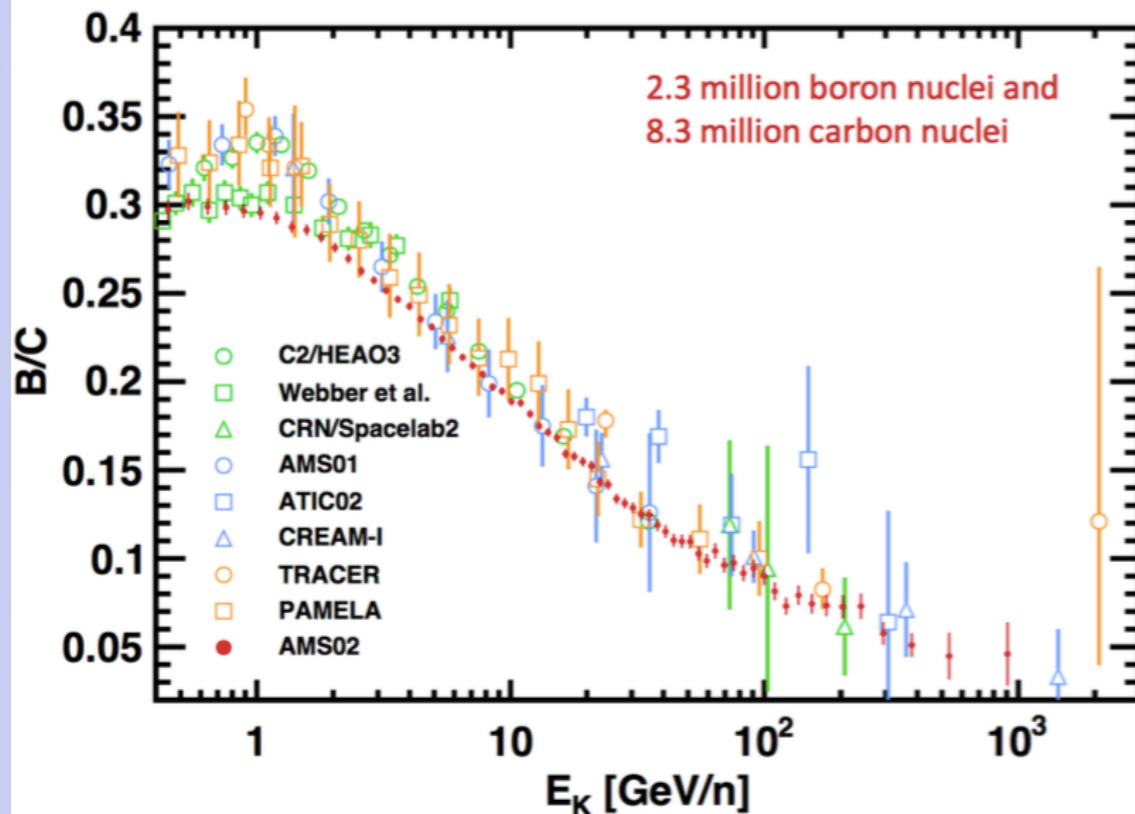

(Dettagli sui modelli teorici in appendice 6)

# Antiproton analysis

$6.5 \cdot 10^{10}$  cosmic rays  
 $3.49 \cdot 10^5$  antiprotons  
 $2.42 \cdot 10^9$  protons

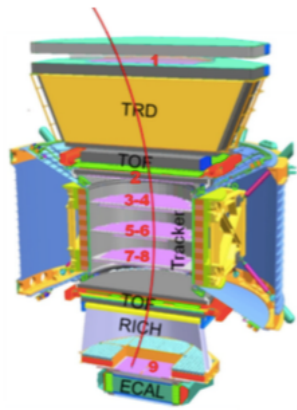

## 1. TRD (transition radiation) to separate $e^\pm$ from $p^\pm$

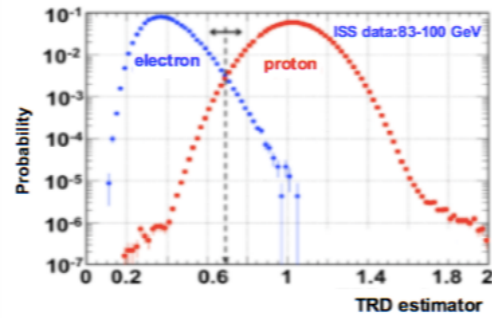

## 2. Tracker measures momentum and separates $+$ from $-$

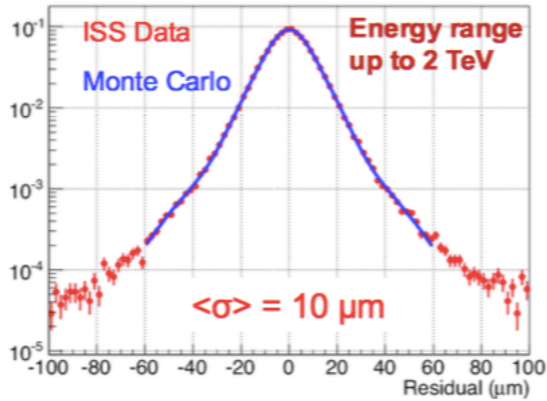

## 3. RICH measures velocity,

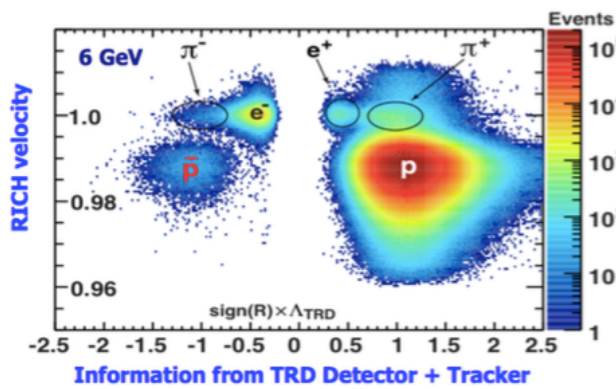

# Protoni ed antiprotoni

## AMS results on the $\bar{p}/p$ flux ratio

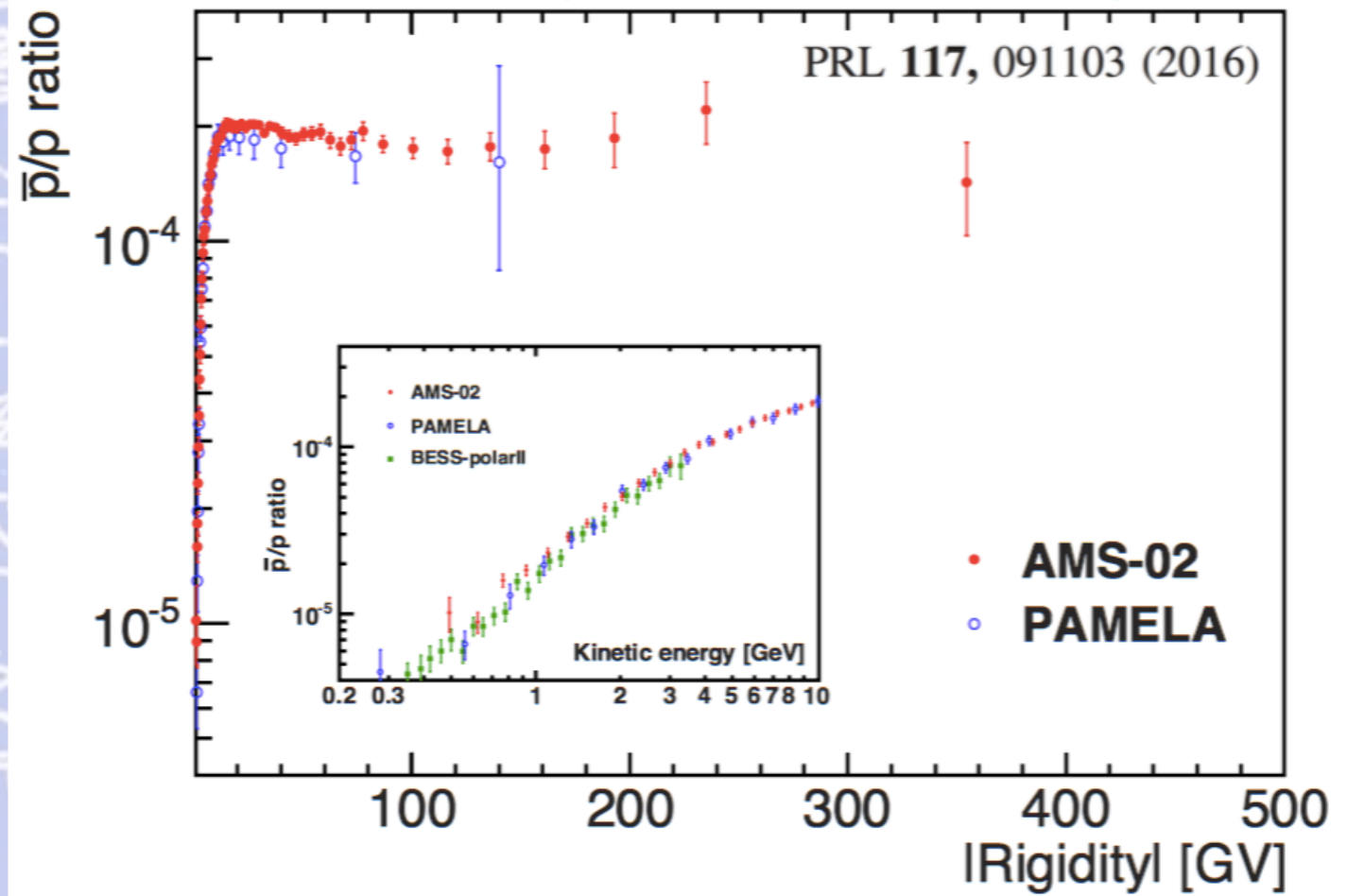

## AMS $\bar{p}/p$ results and modeling

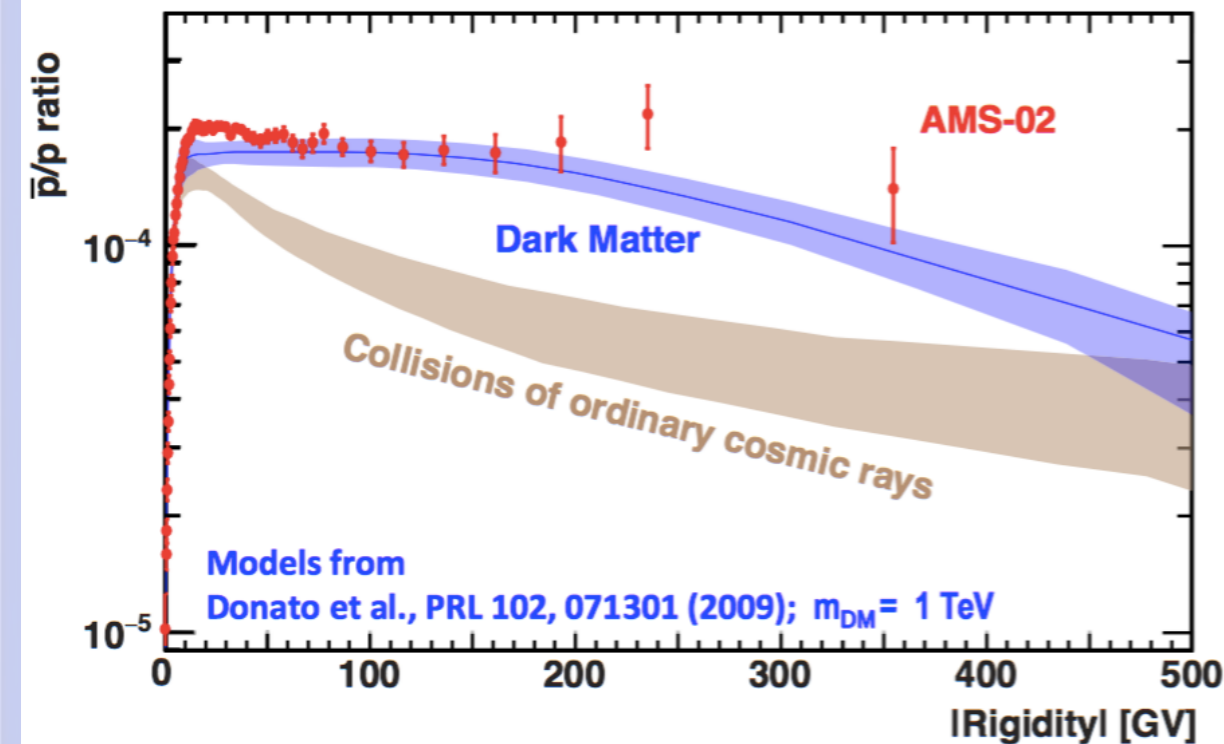

Flux Ratios  $\bar{p}/e^-$  and  $p/e^-$  are **not** energy independent in the interval 60–450 GV

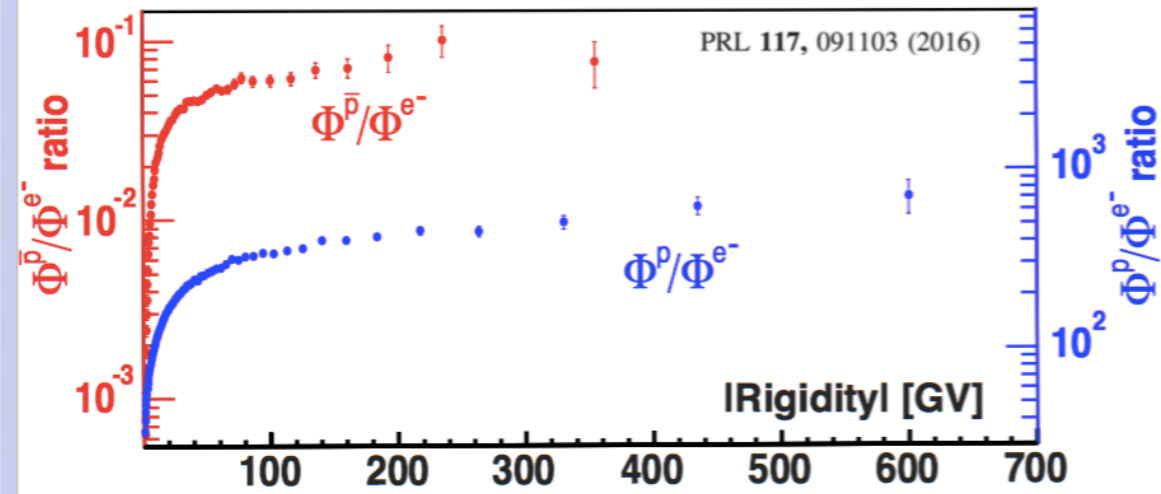

As expected: significant energy losses of  $e^-$  due to synchrotron radiation

# Dipendenza energetica dei flussi

**Unexpected Result**

Flux Ratio of Elementary Particles  $\bar{p}/p$  is energy independent above 60 GeV

Flux Ratios  $\bar{p}/e^+$  and  $p/e^+$  are also energy independent in the interval 60–450 GV

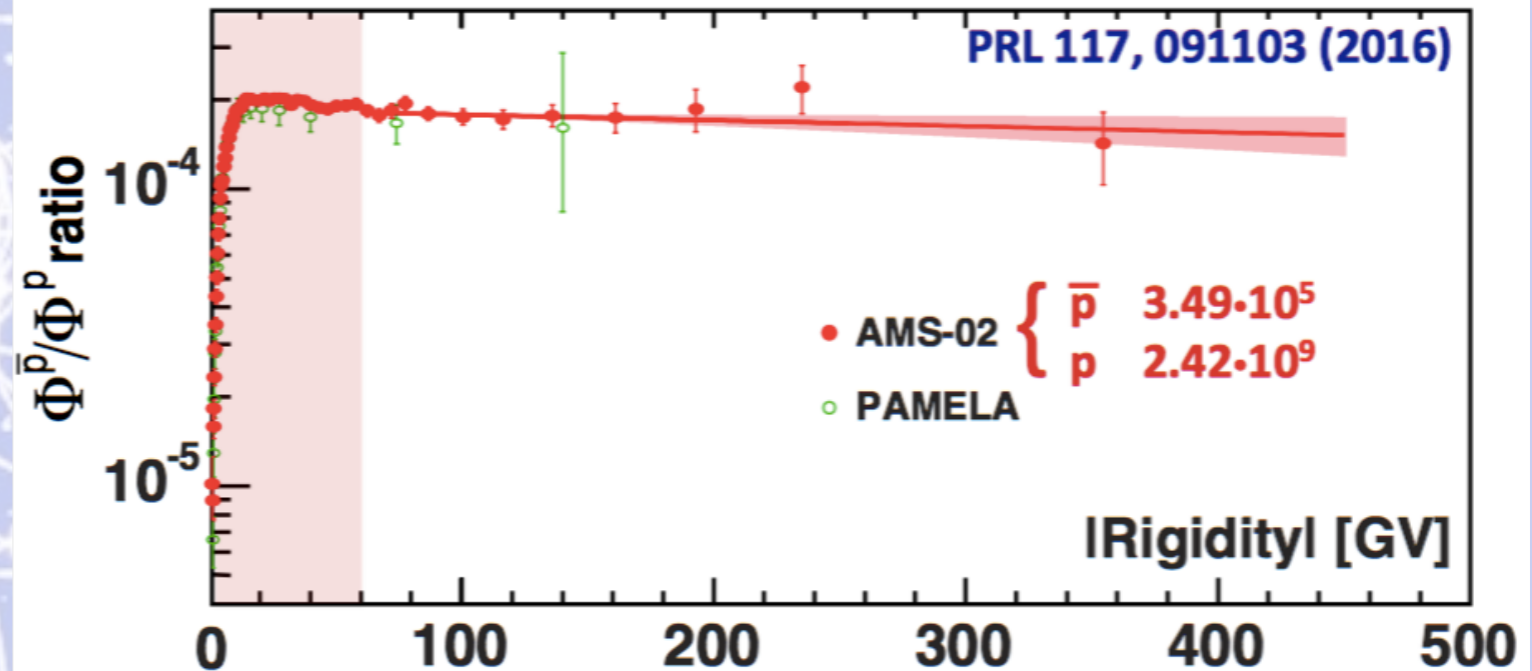
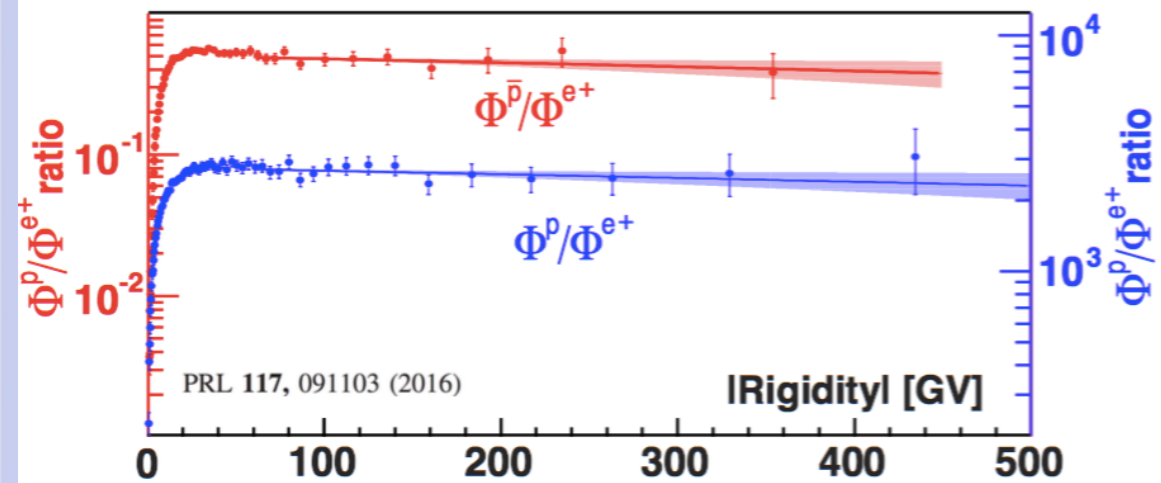

# Summary

## AMS results on the fluxes of elementary particles

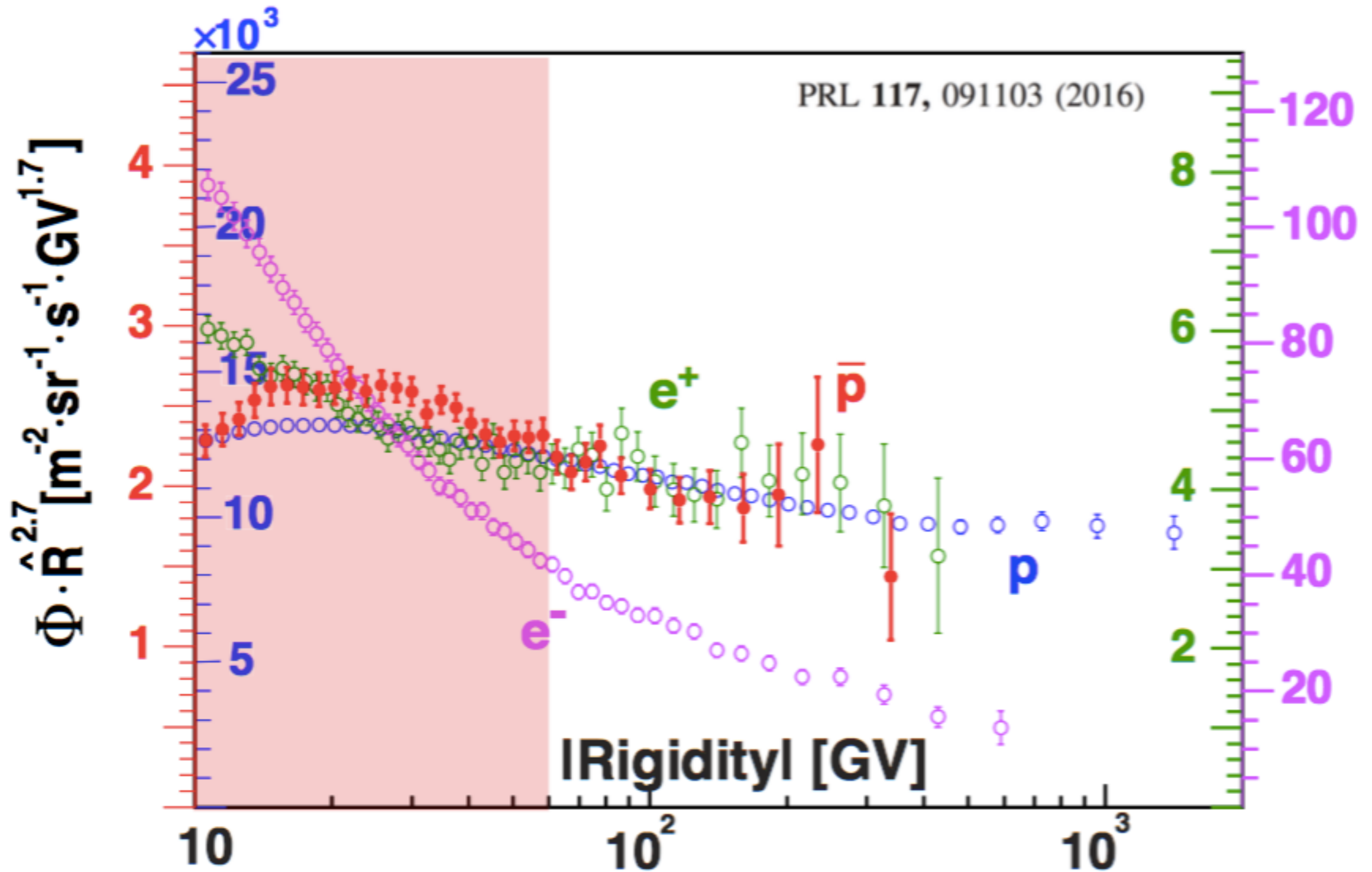

# Alcune pubblicazioni: protoni ed elio (2015)

PRL 114, 171103 (2015)

PHYSICAL REVIEW LETTERS

week ending  
1 MAY 2015

Precision Measurement of the Proton Flux in Primary Cosmic Rays from Rigidity 1 GV to 1.8 TV with the Alpha Magnetic Spectrometer on the International Space Station

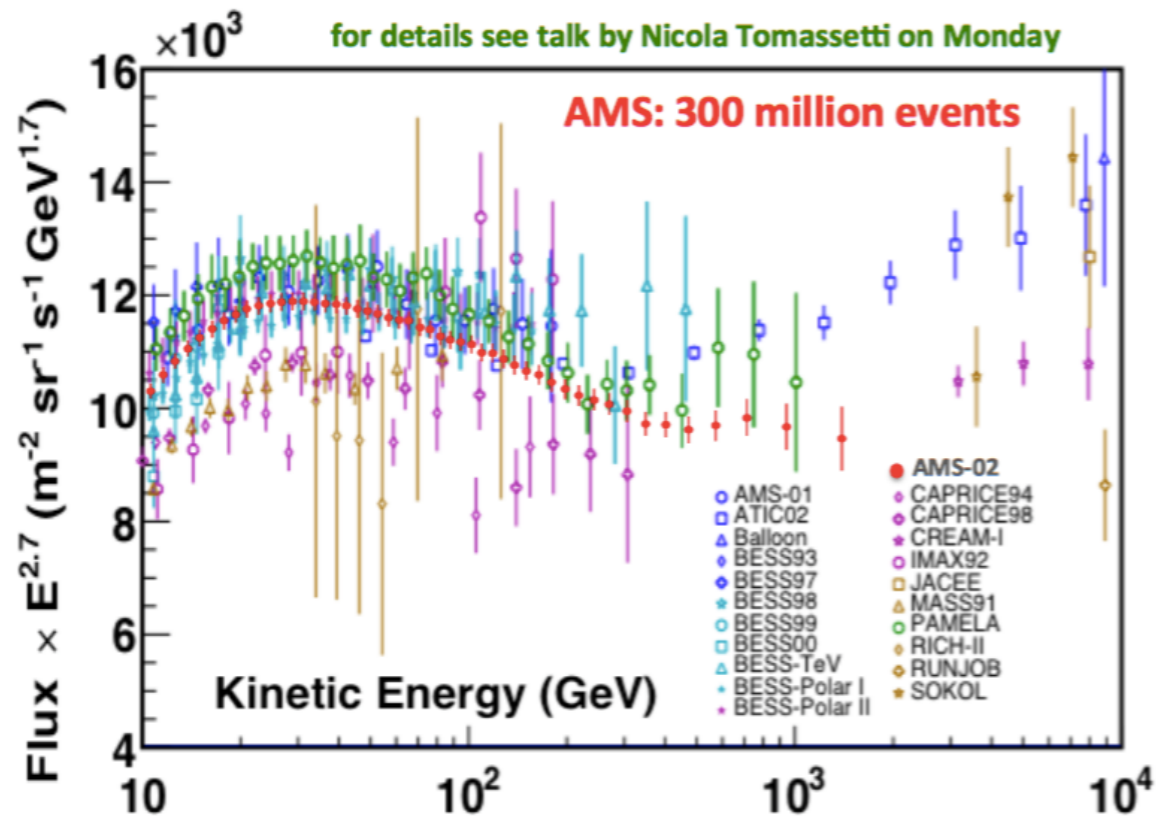

PRL 115, 211101 (2015)

PHYSICAL REVIEW LETTERS

week ending  
20 NOVEMBER 2015

Precision Measurement of the Helium Flux in Primary Cosmic Rays of Rigidities 1.9 GV to 3 TV with the Alpha Magnetic Spectrometer on the International Space Station

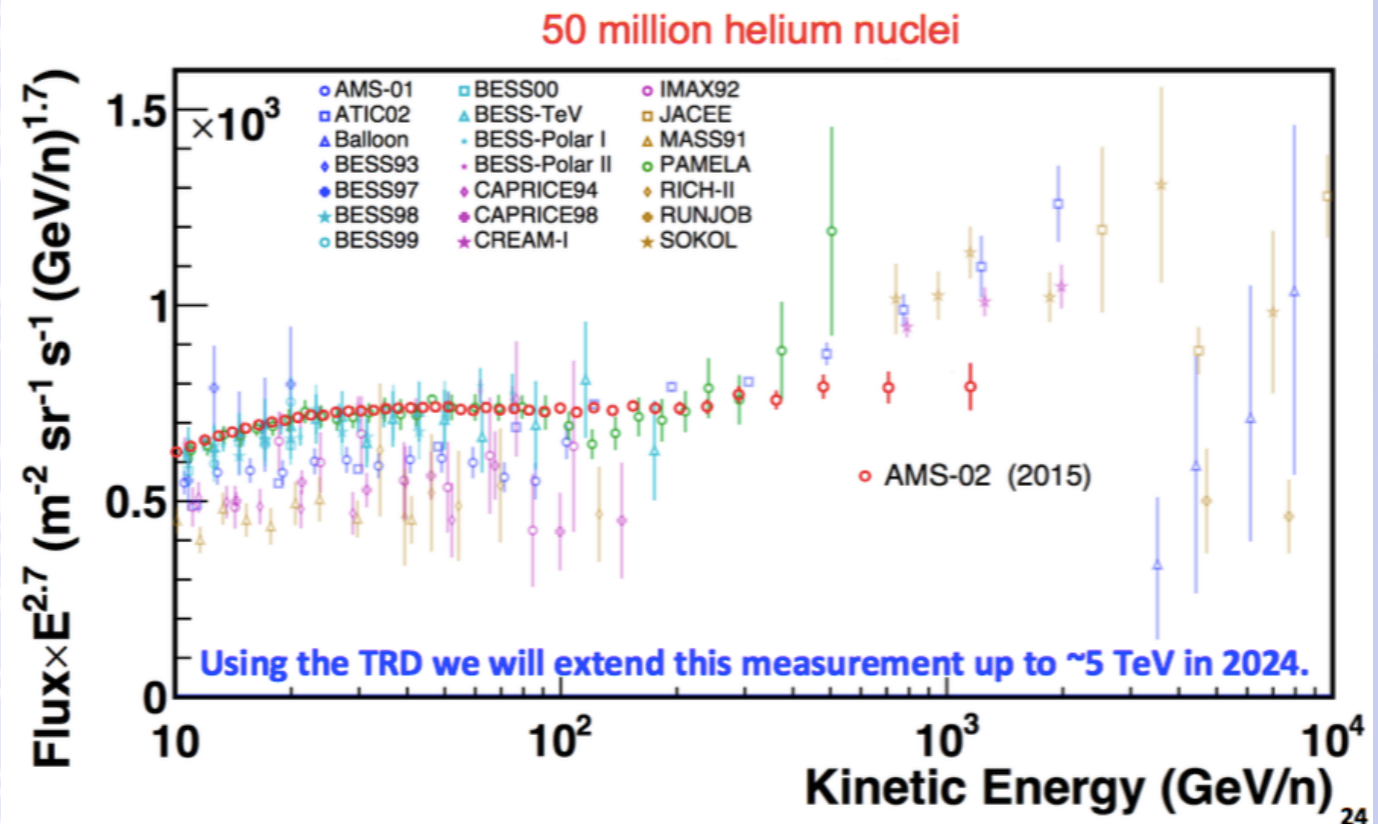

# Appendice 14

(L' esperimento pilota AMS-01)



# Experience from the AMS-1 flight (STS-91) 1998

- Data taking  $\approx 135$  hours;
- Shuttle altitude  $\approx 370$  km;
- 100 million events recorded.

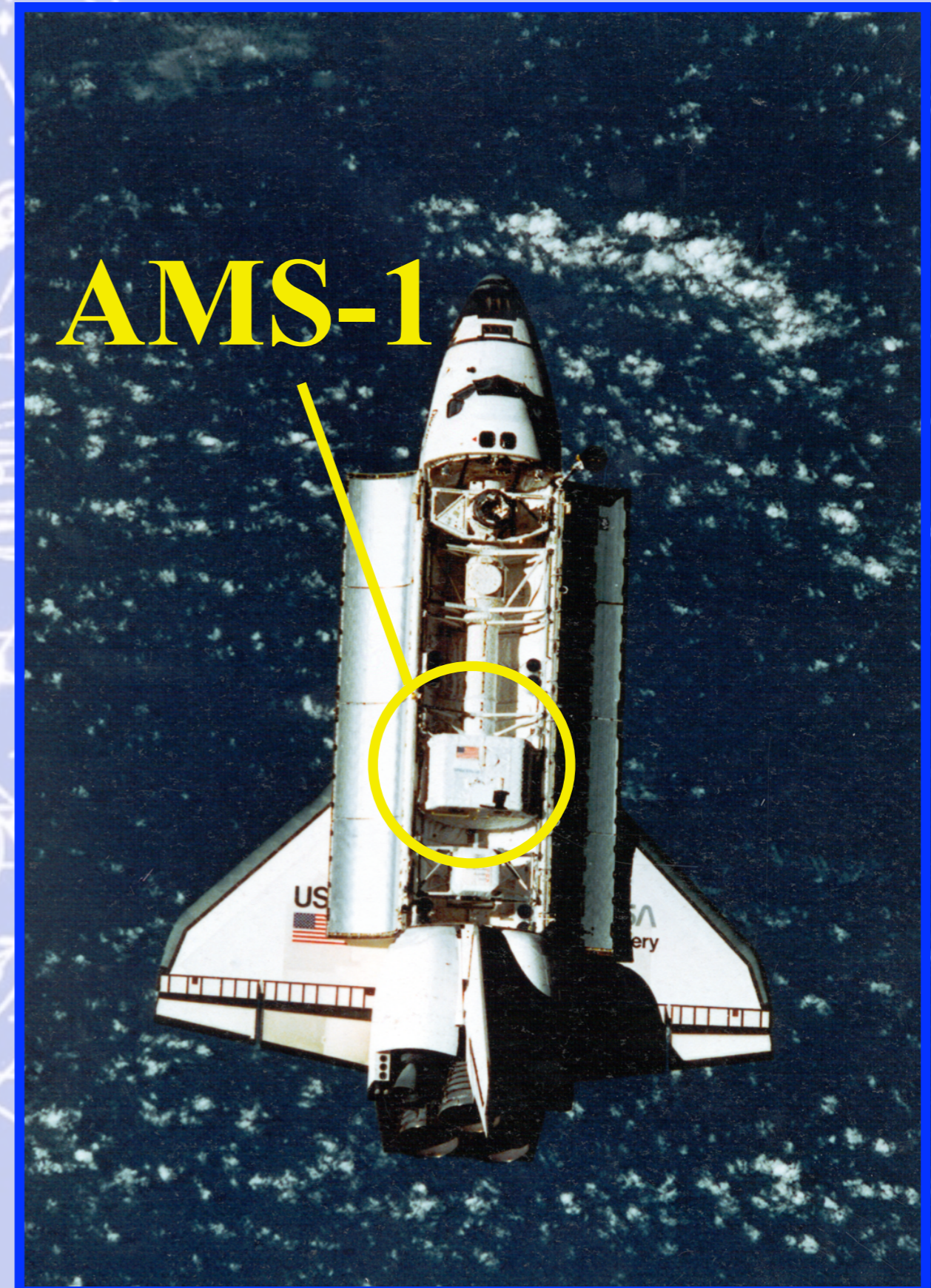
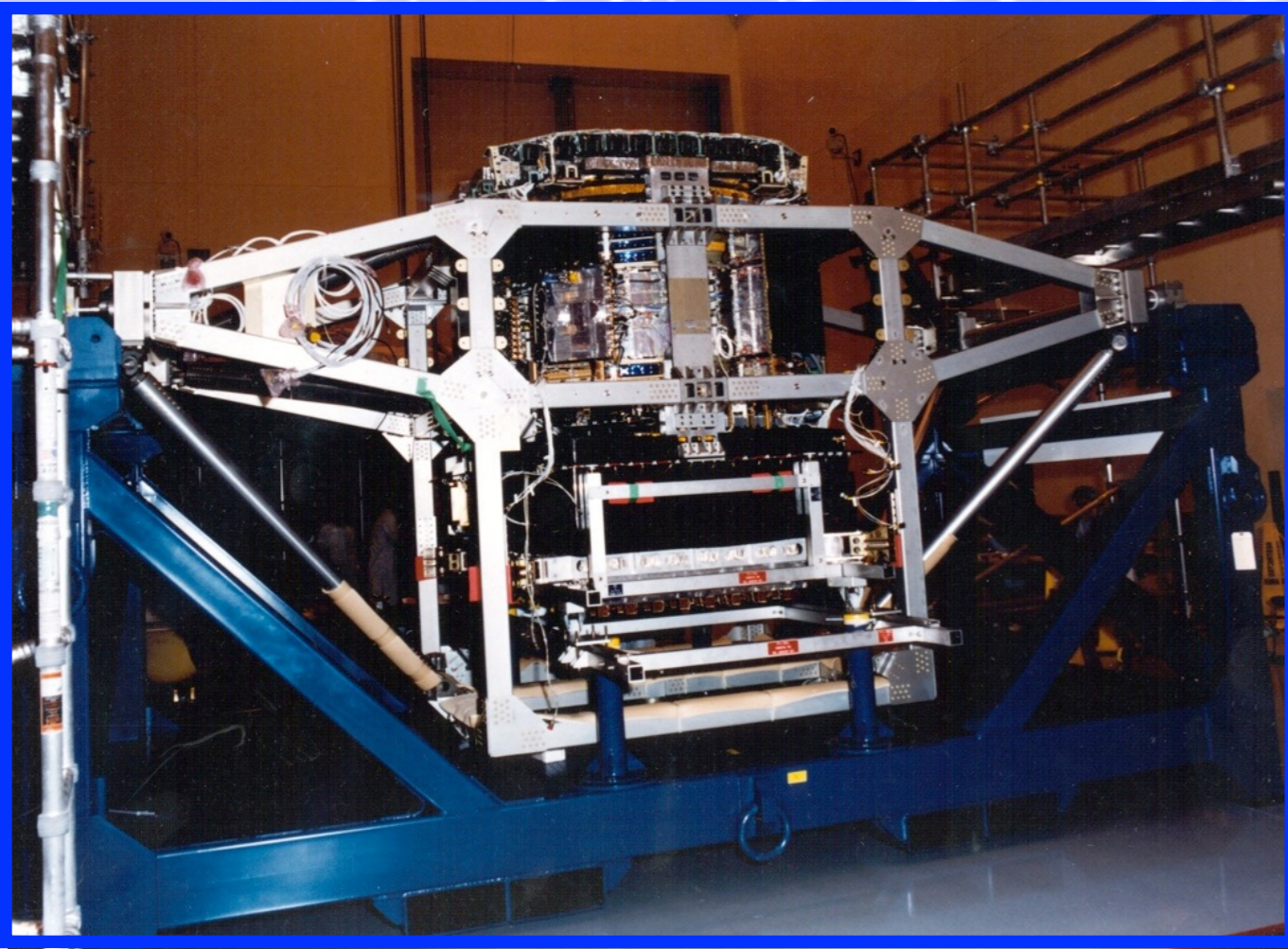



# Appendice 15

(Varie ed eventuali)

# Data from AMS on ISS: He rate

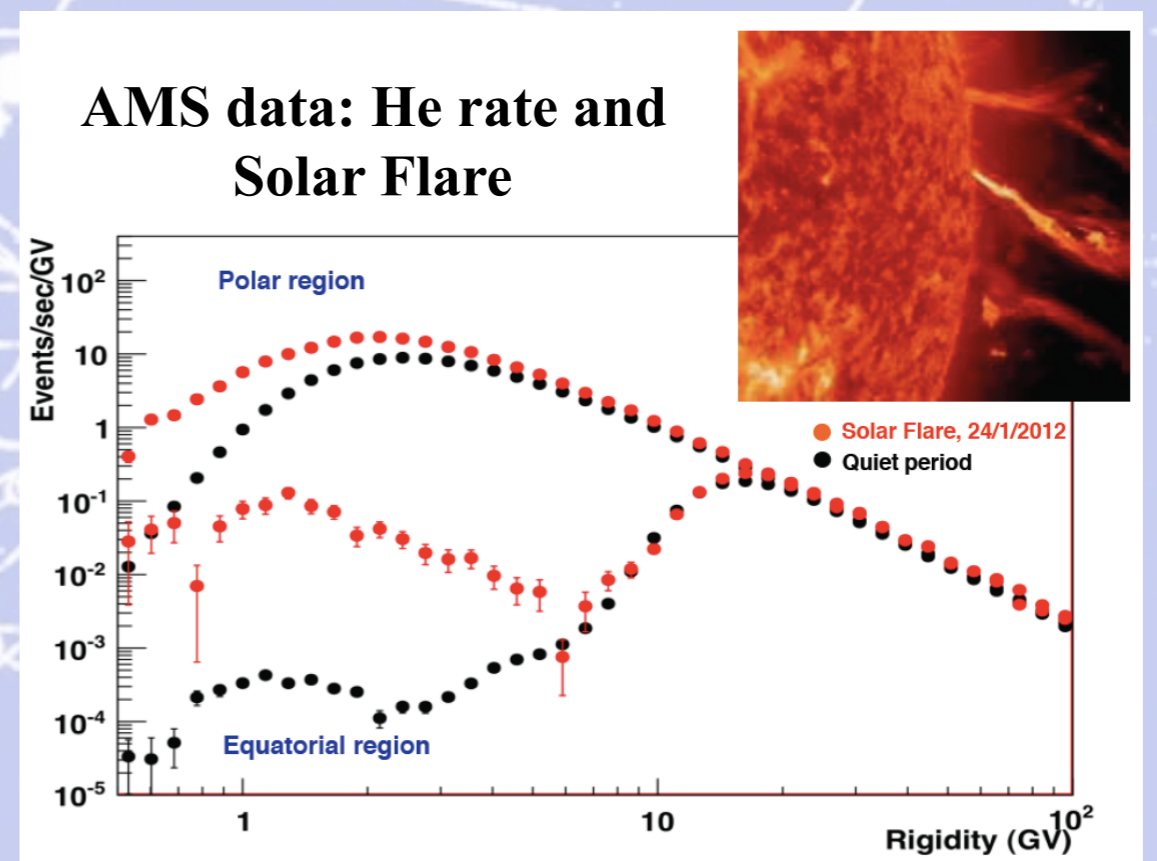
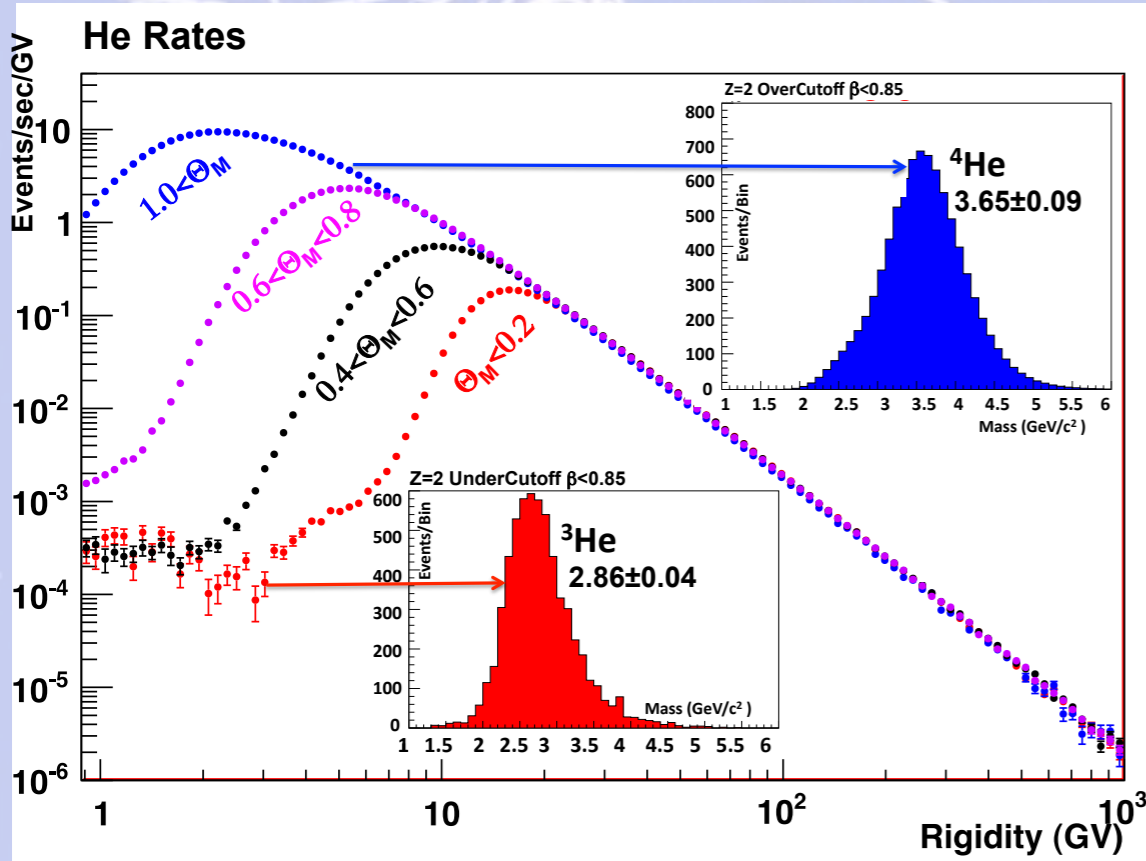
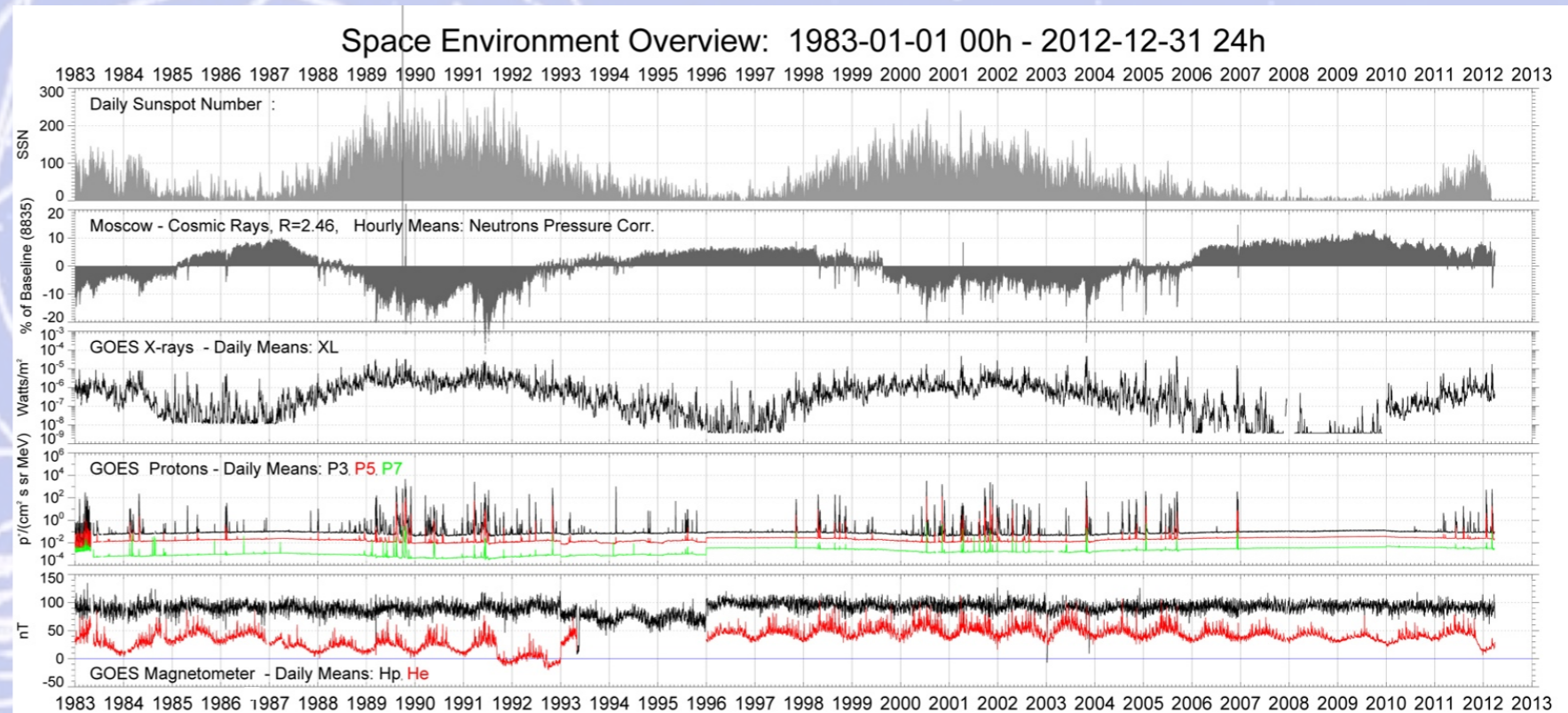
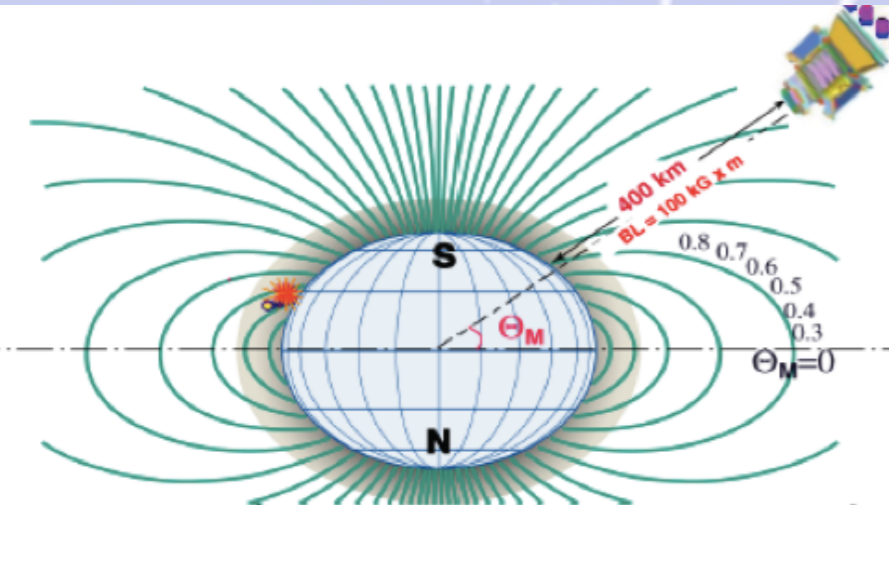

# Rigidity ~ 3 GV

## Boron Rigidity=3.7 GV

Run/Event 1333501084/ 42231

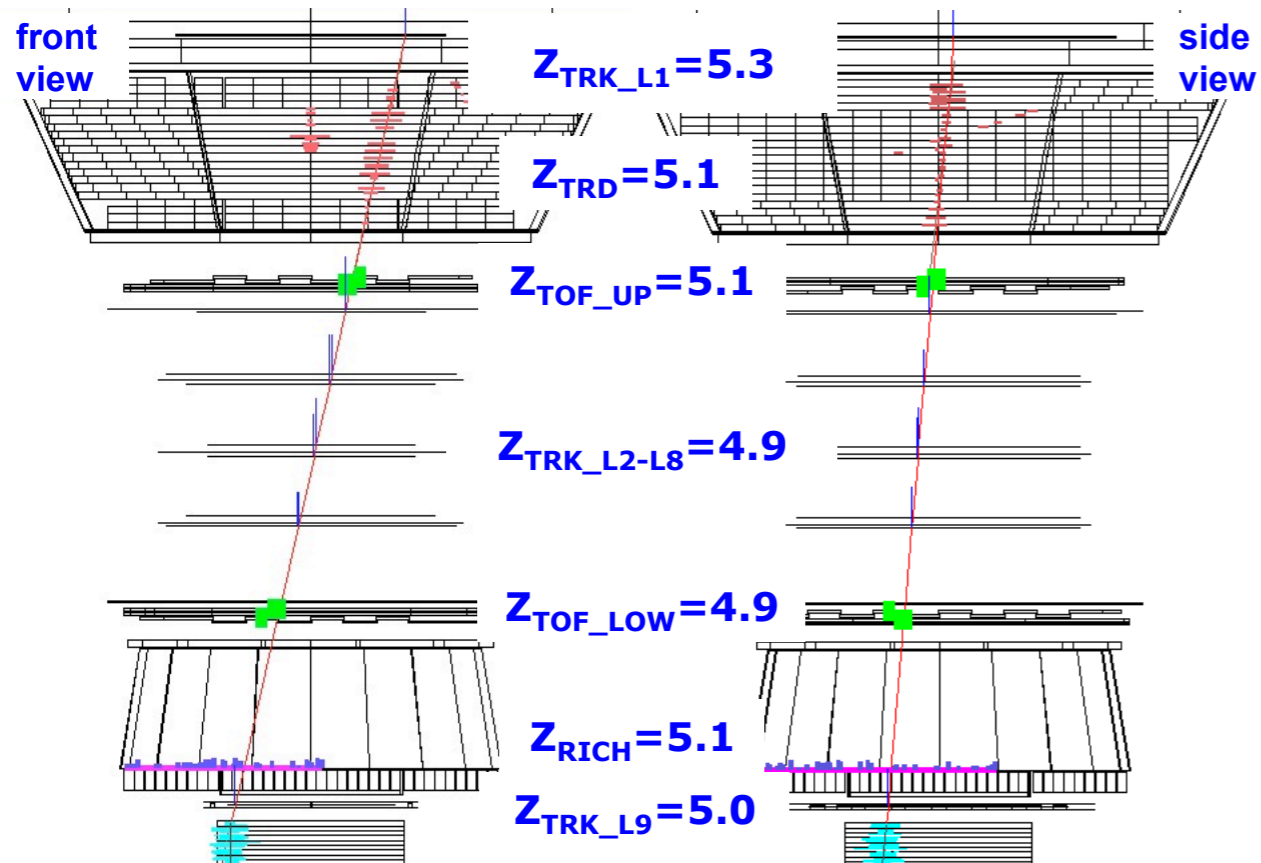

## Carbon Rigidity=3.3 GV

Run/Event 1327519853/ 487070

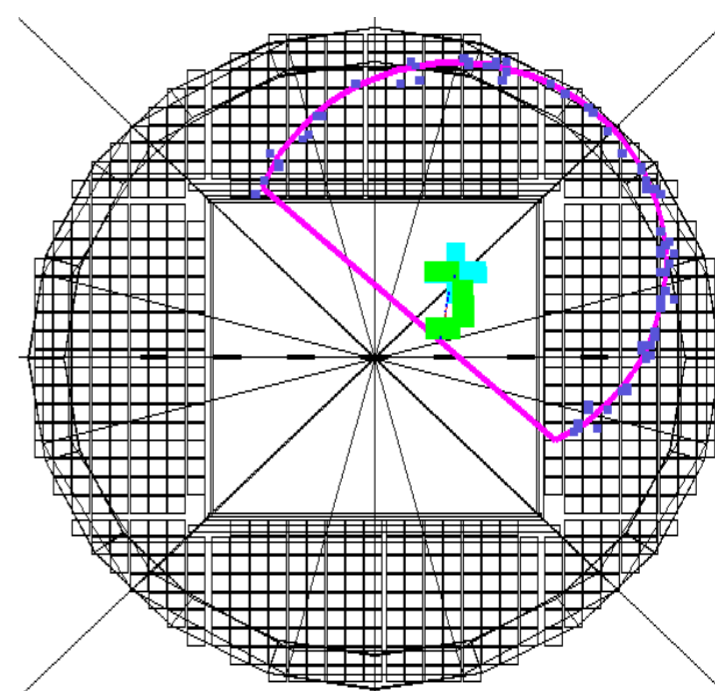
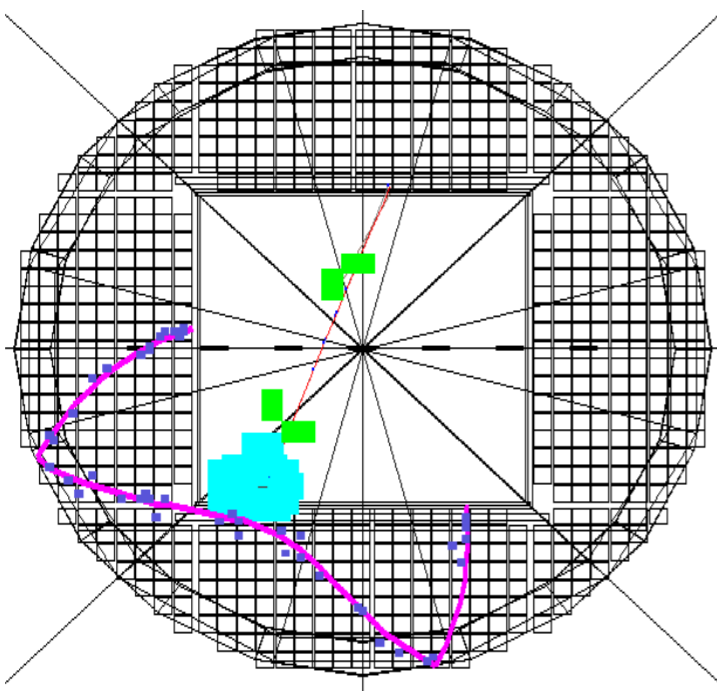
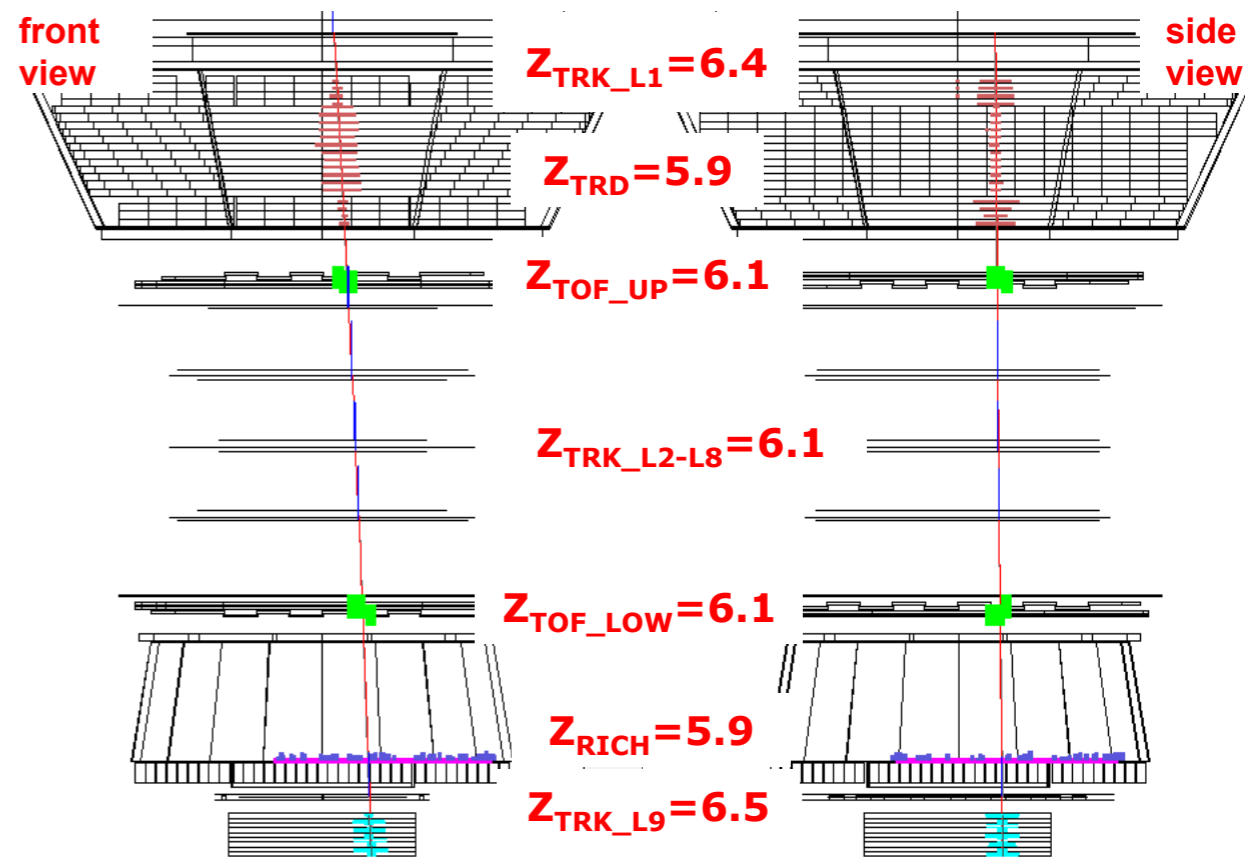

# Rigidity ~ 20 GV

## Boron Rigidity=24 GV

Run/Event 1326201809/ 798775

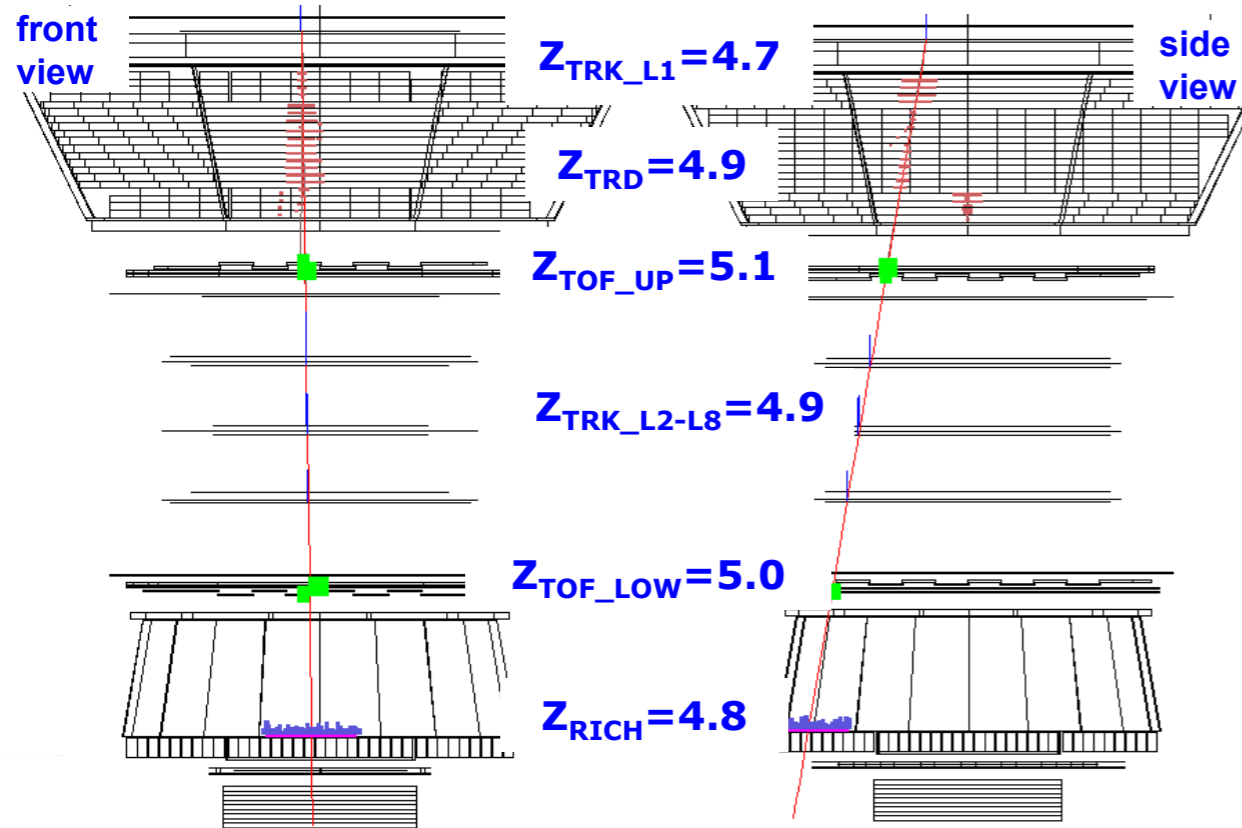

## Carbon Rigidity=24 GV

Run/Event 1329490720/ 473181

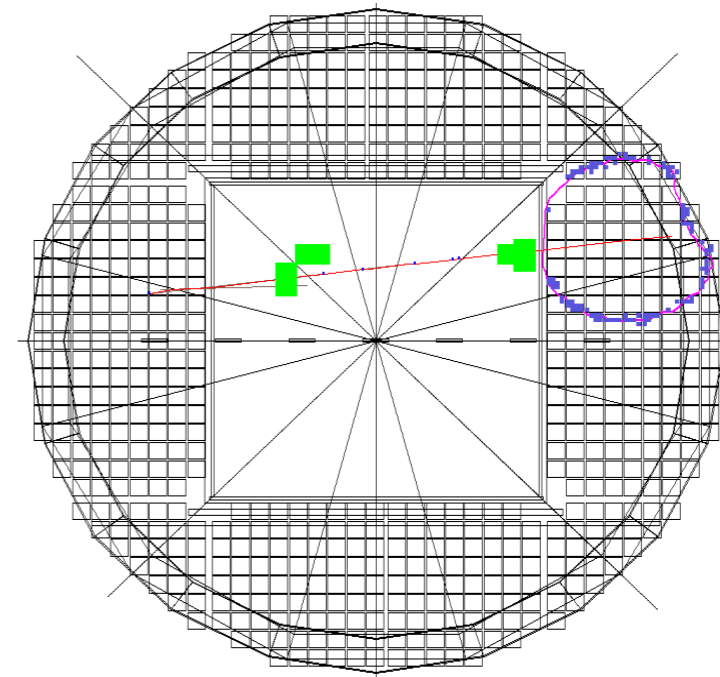
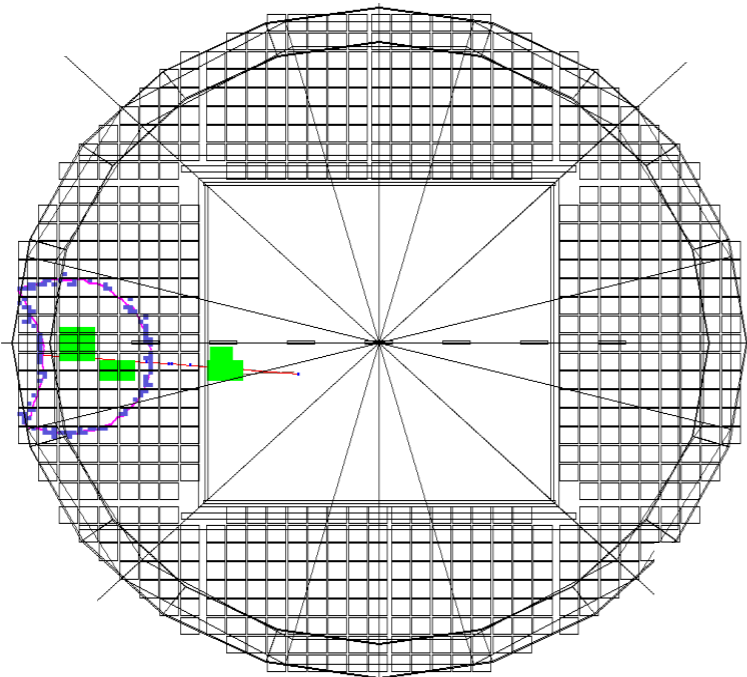
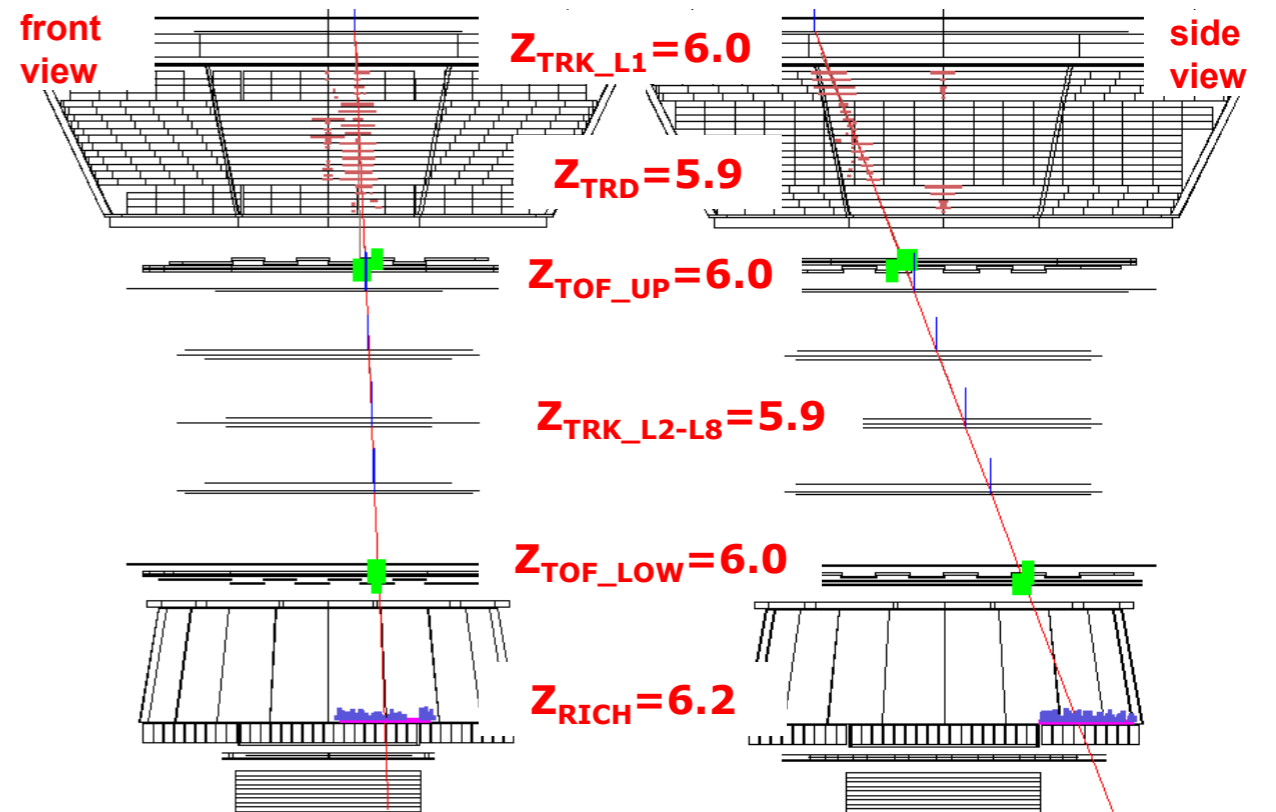

# Rigidity ~ 200 GV

**Boron**  
Rigidity=187 GV

Run/Event 1329086299/ 747549

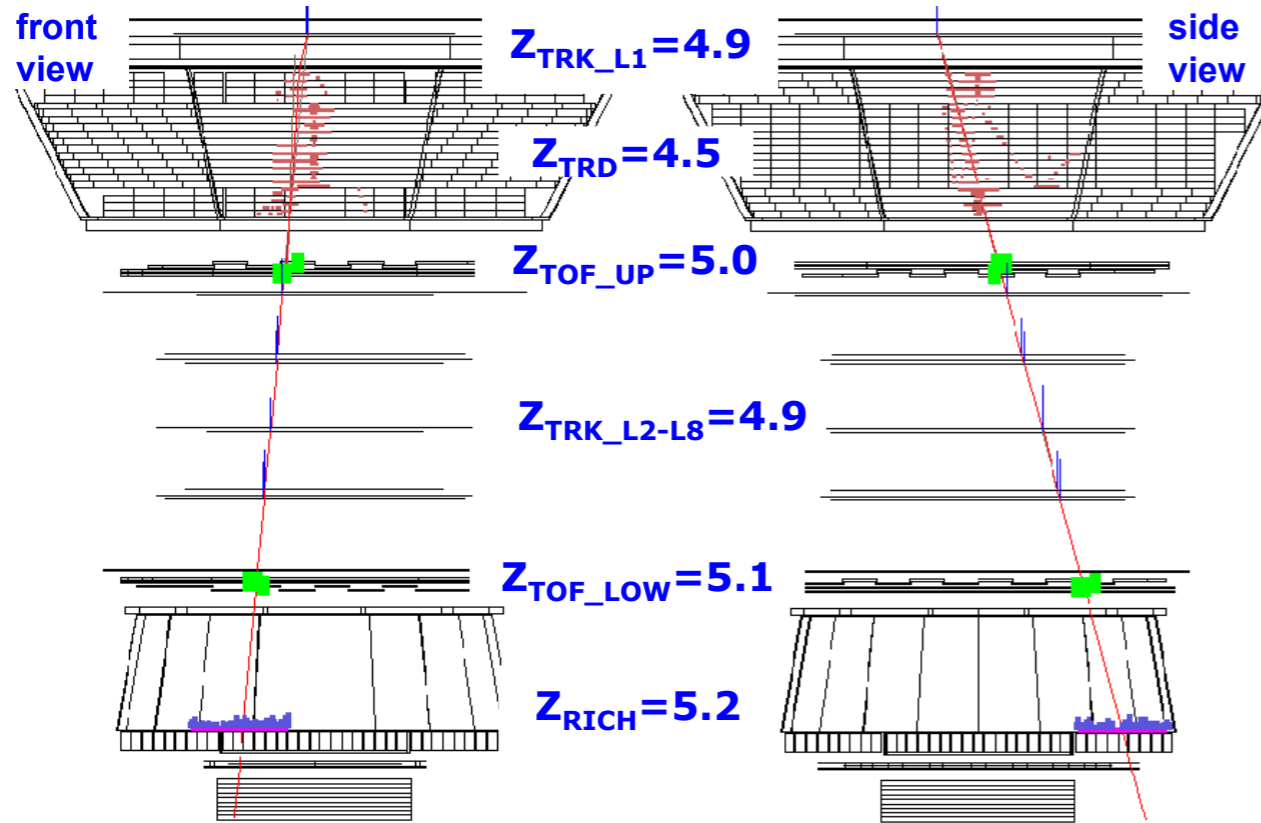

**Carbon**  
Rigidity=215 GV

Run/Event 132643580/ 132197

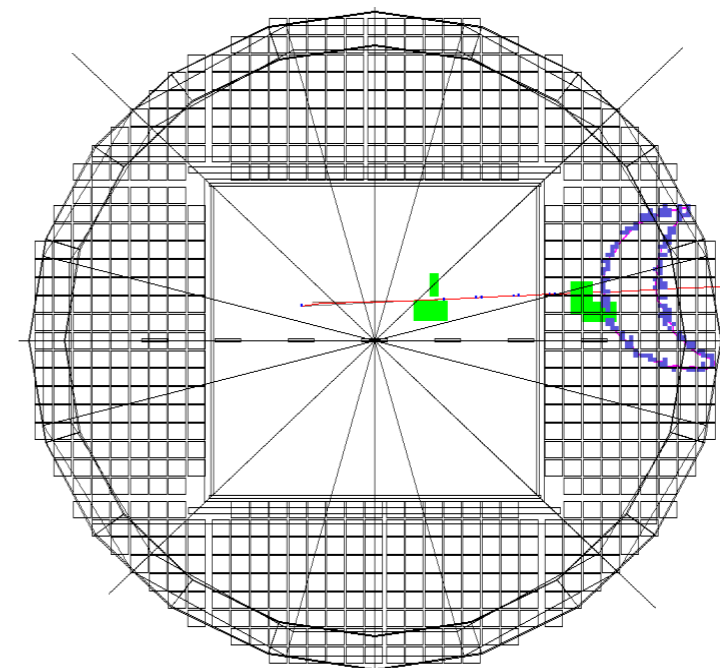
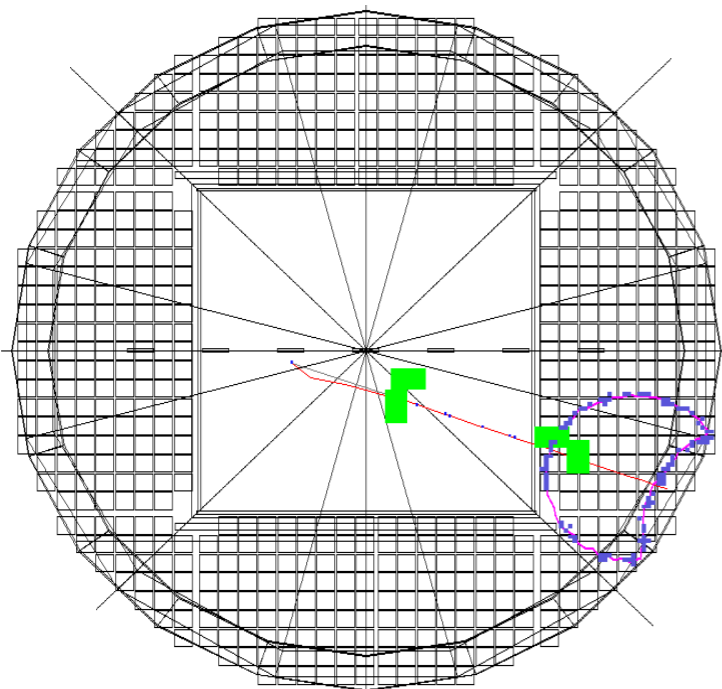
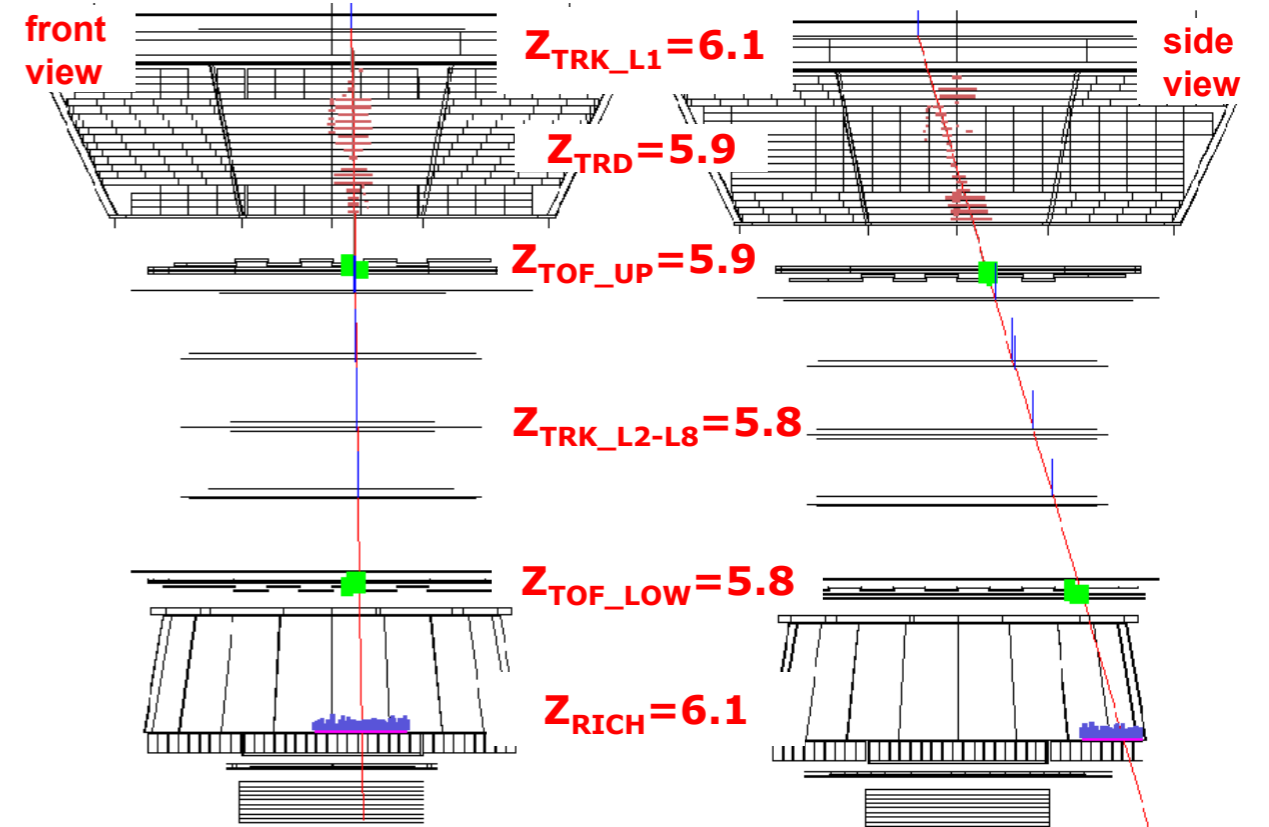

# Rigidity ~ 700 GV

**Boron**  
Rigidity=680 GV

Run/Event 1319990213/ 235892

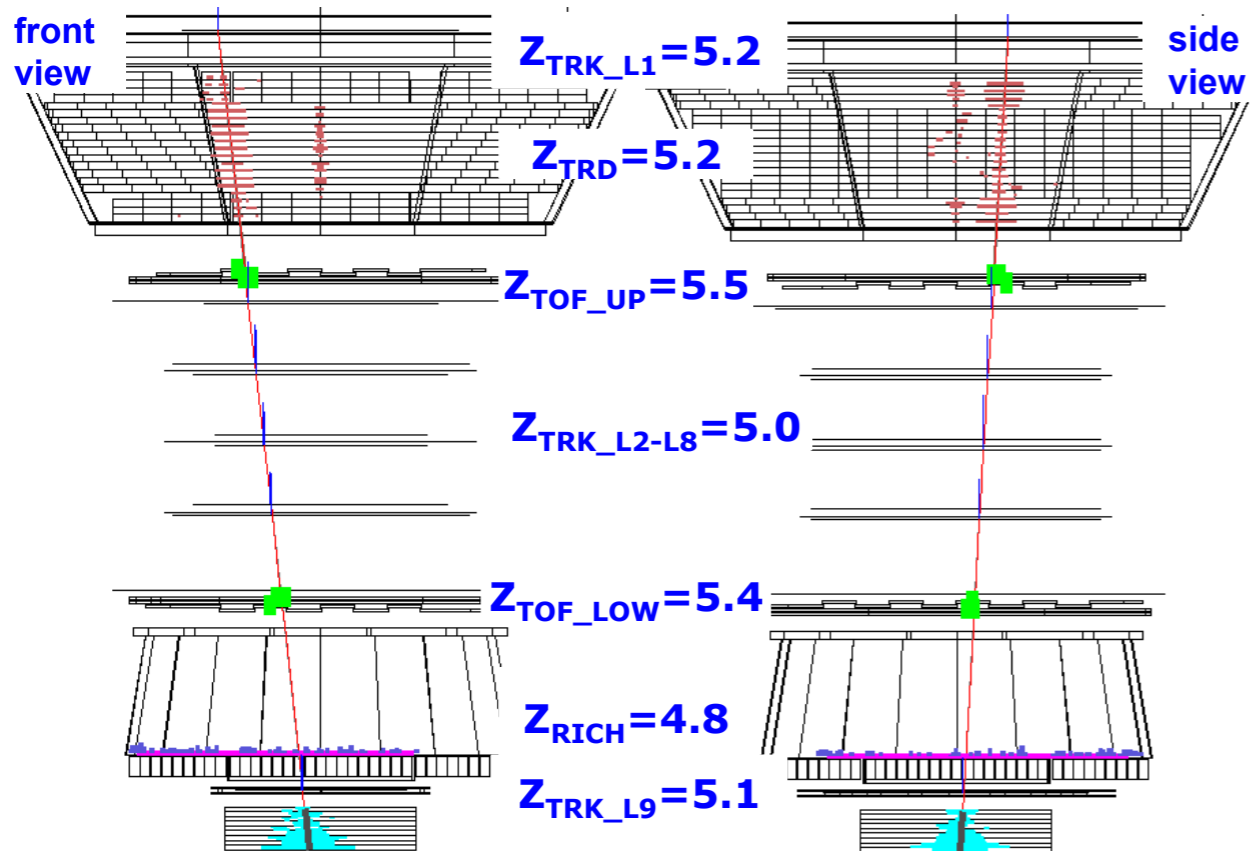

**Carbon**  
Rigidity=666 GV

Run/Event 1327184805/ 266043

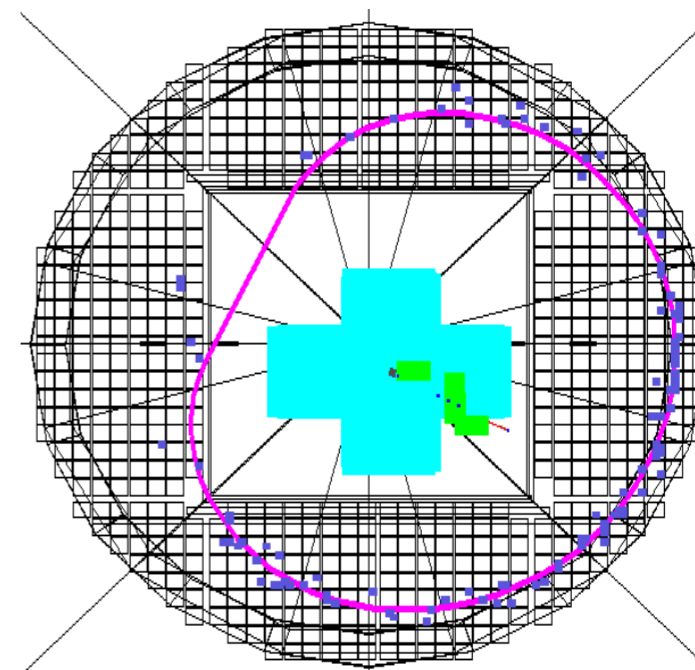
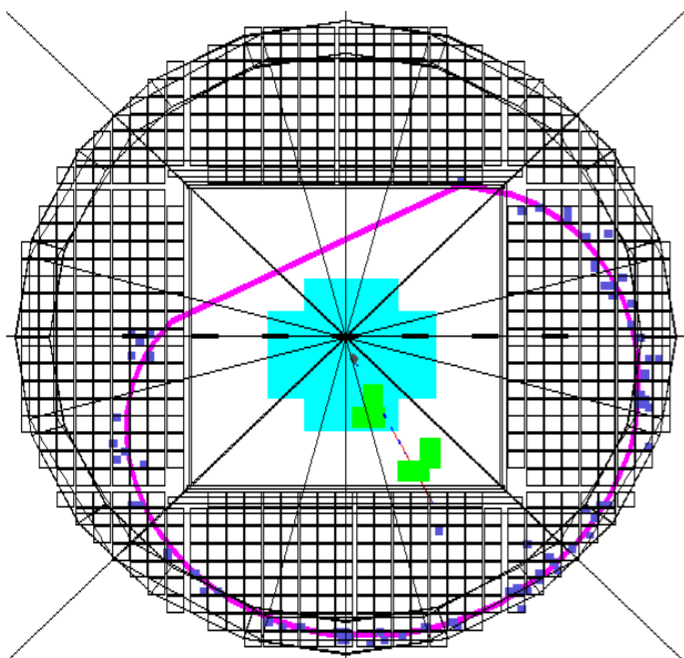
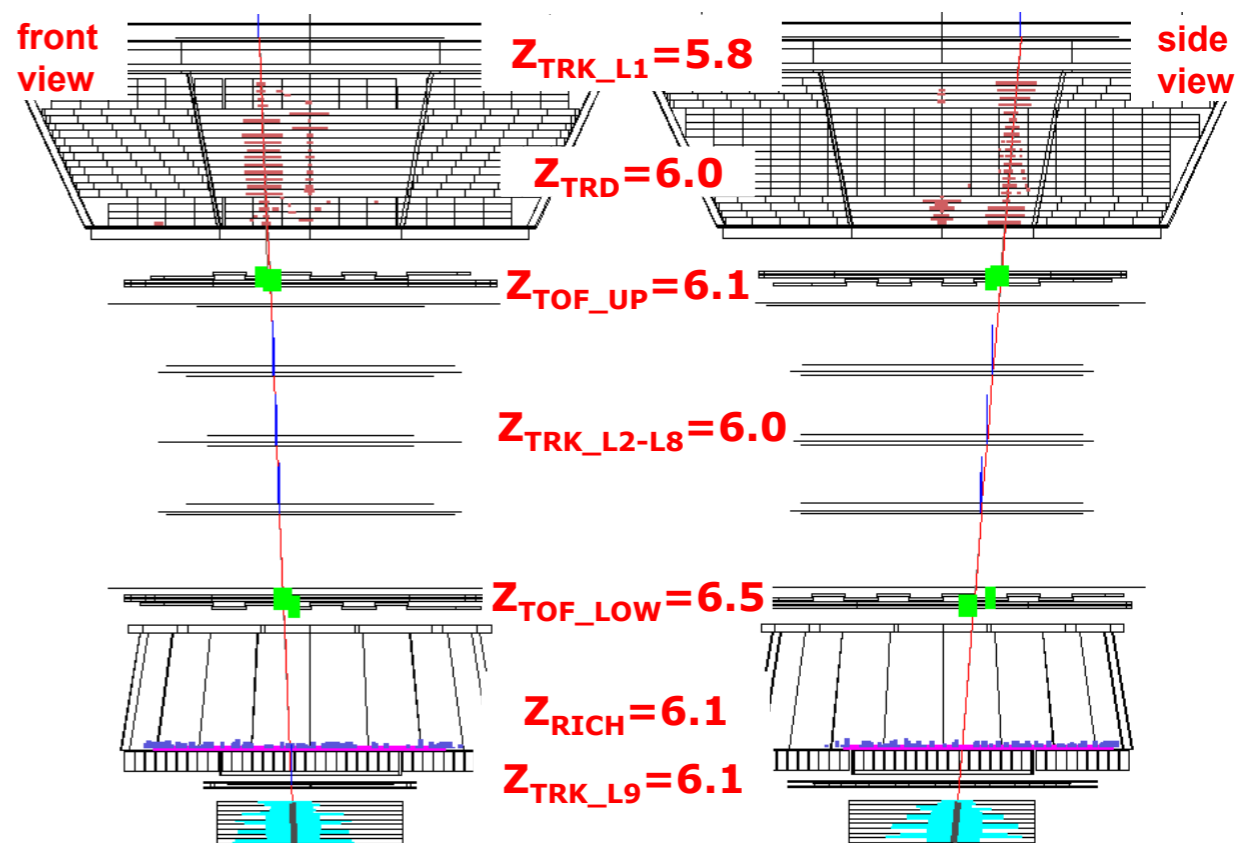

# AMS ISS data: electrons

1.03 TeV electron

AMS Event Display

Run/Event 1315754945 / 173049 GMT Time 2011-254.15:31:15

front view

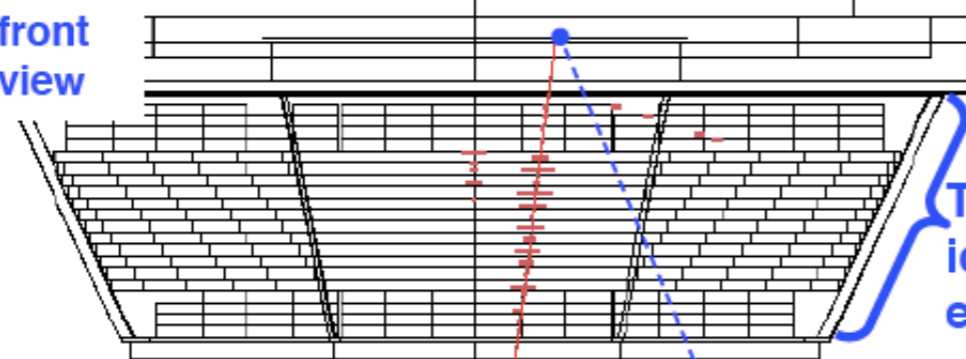

side view

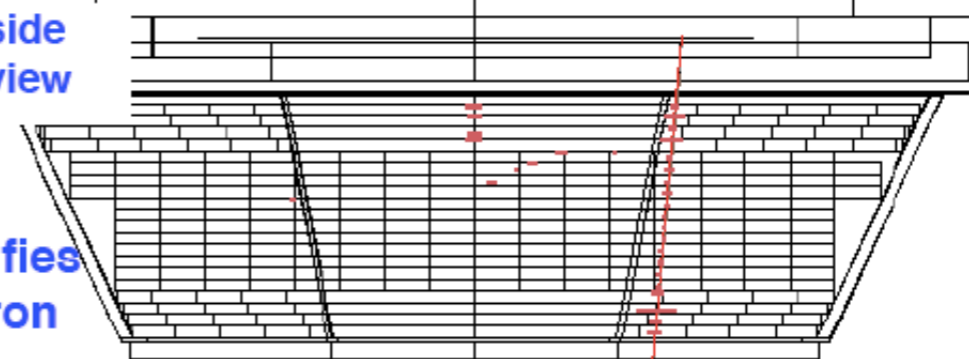

TRD:  
identifies  
electron

Tracker and Magnet:  
measure momentum

RICH  
charge of  
electron

ECAL:  
identifies electron and measures  
its energy

35



# AMS ISS data: positrons

