

Dual-Readout Calorimetry *for High-Quality Energy Measurements*

*Status report of the RD52 (DREAM) Collaboration**

Richard Wigmans

CERN, April 4, 2017

* *DREAM (RD52) Collaboration:*

Cagliari, Cosenza, Como, Pavia, Pisa, Iowa State, TTU, Korea University

RD52 is a **generic** detector R&D project
not linked to any experiment

Goal:

Investigate + eliminate the factors that prevent us from measuring hadrons and jets with similar precision as electrons, photons

And thus develop a calorimeter that is up to the challenges of future experiments in particle physics

Outline:

- *New paper (hadronic performance)*
- *New experimental results (1 week in October 2016)*
- *Plans for the future*

DUAL-READOUT CALORIMETRY

- *Dual-readout Method (DREAM):*

Simultaneous measurement of scintillation light (dE/dx) and Čerenkov light produced in shower development makes it possible to measure the em fraction of hadron showers event by event.

The effects of fluctuations in this fraction can thus be eliminated

- *In this way, the same advantages are obtained as for intrinsically compensating calorimeters ($e/h = 1$), WITHOUT the limitations (sampling fraction, integration volume, time)*

- *Correct hadronic energy reconstruction, in an instrument calibrated with electrons*
- *Linearity + excellent energy resolution for hadrons & jets*
- *Gaussian response functions*

Hadron detection with a dual-readout fiber calorimeter

New RD52 paper

S. Lee^m, A. Cardini^c, M. Cascella^d, S. Choi^e, G. Ciapetti^{†g},
R. Ferrari^h, S. Franchinoⁱ, M. Fraternali^f, G. Gaudio^h, S. Ha^e,
J. Hauptman^j, H. Kim^m, A. Lanza^h, F. Li^j, M. Livan^f, E. Meoni^l,
J. Park^m, F. Scuri^b, A. Sill^a and R. Wigmans^{a, 1}

^a *Texas Tech University, Lubbock (TX), USA*

^b *INFN Sezione di Pisa, Italy*

^c *INFN Sezione di Cagliari, Monserrato (CA), Italy*

^d *University College, London, UK*

^e *Korea University, Seoul, Korea*

^f *INFN Sezione di Pavia and Dipartimento di Fisica, Università di Pavia, Italy*

^g *Dipartimento di Fisica, Università di Roma "La Sapienza" and INFN Sezione di Roma, Italy*

^h *INFN Sezione di Pavia, Italy*

ⁱ *Kirchhoff-Institut für Physik, Ruprecht-Karls-Universität Heidelberg, Germany*

^j *Iowa State University, Ames (IA), USA*

^l *Dipartimento di Fisica, Università della Calabria and INFN Cosenza, Italy*

^m *Kyungpook National University, Daegu, Korea*

[†] *Deceased*

Abstract

In this paper, we describe measurements of the response functions of a fiber-based dual-readout calorimeter for pions, protons and multiparticle “jets” with energies in the range from 10 to 180 GeV. The calorimeter uses lead as absorber material and has a total mass of 1350 kg. It is complemented by leakage counters made of scintillating plastic, with a total mass of 500 kg. The effects of these leakage counters on the calorimeter performance are studied as well. In a separate section, we investigate and compare different methods to measure the energy resolution of a calorimeter. Using only the signals provided by the calorimeter, we demonstrate that our dual-readout calorimeter, calibrated with electrons, is able to reconstruct the energy of proton and pion beam particles to within a few percent at all energies. The fractional widths of the signal distributions for these particles (σ/E) scale with the beam energy as $30\%/\sqrt{E}$, without any additional contributing terms.

PACS: 29.40.Ka, 29.40.Mc, 29.40.Vj

Key words: Dual-readout calorimetry, Čerenkov light, optical fibers

¹ Corresponding author. Email wigmans@ttu.edu, fax (+1) 806 742-1182.

Principles of dual-readout calorimetry (1)

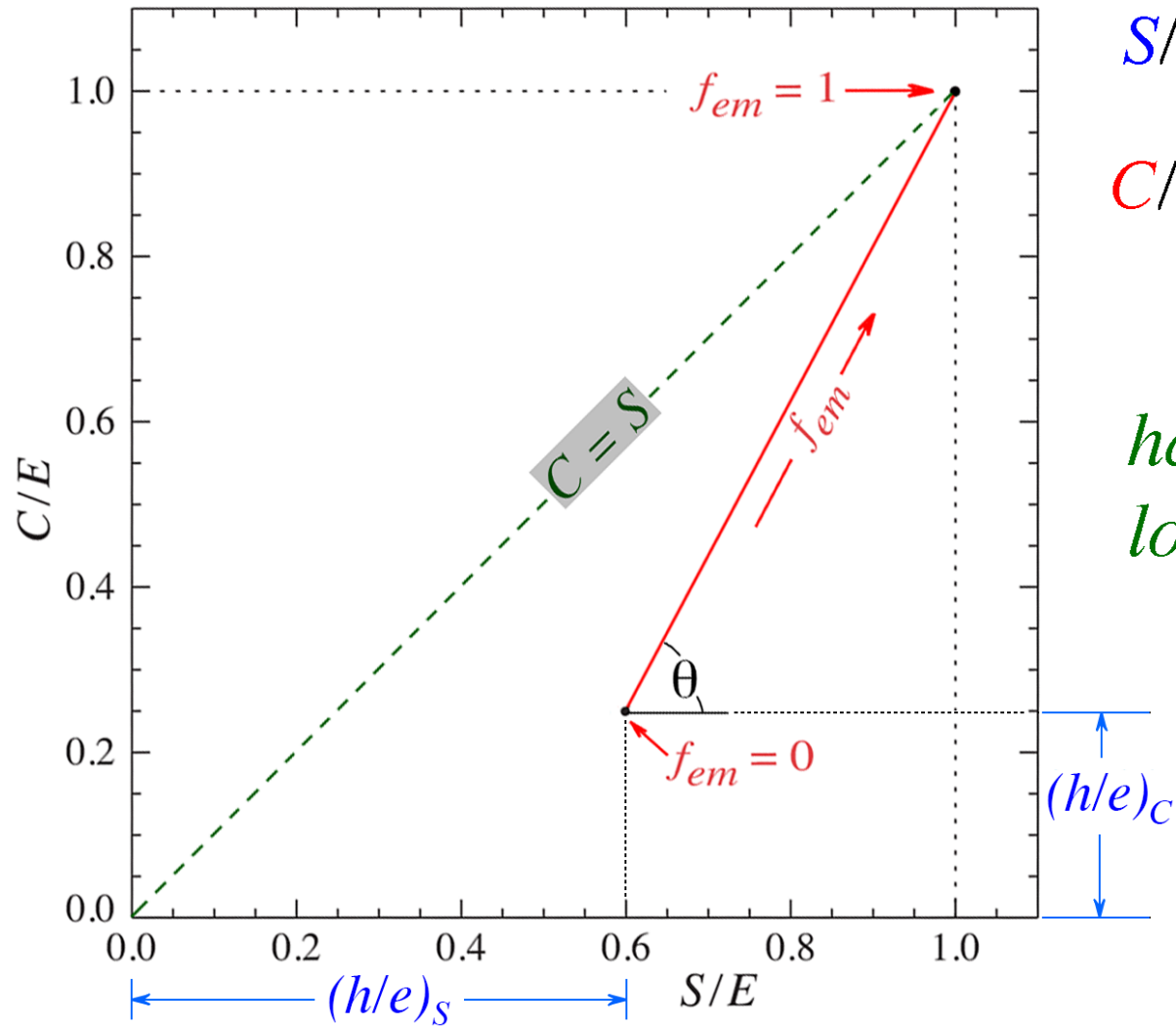

$$S/E = (h/e)_s + f_{em} [1 - (h/e)_s]$$

$$C/E = (h/e)_c + f_{em} [1 - (h/e)_c]$$

hadronic data points (S,C)
located on straight (red) line

Principles of dual-readout calorimetry (2)

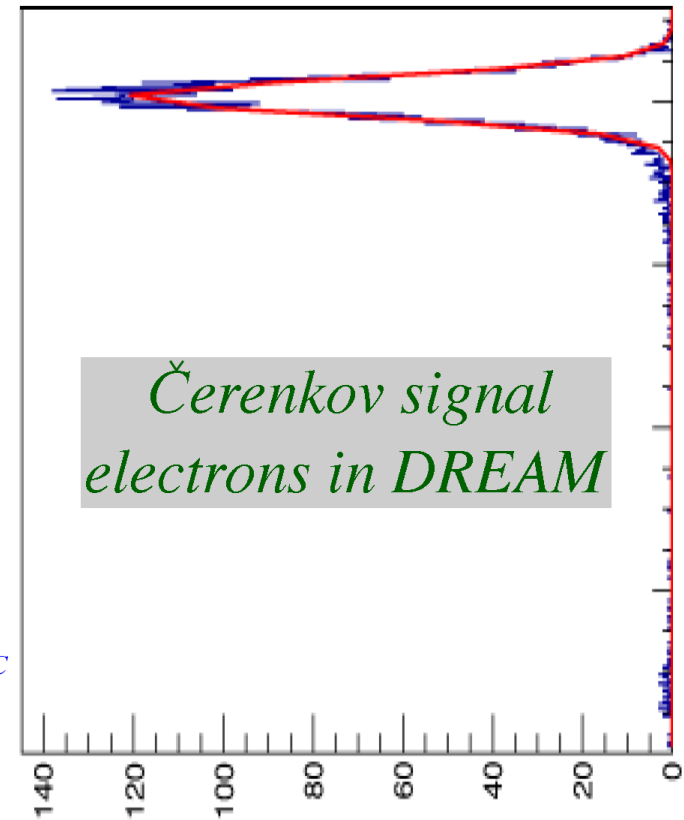
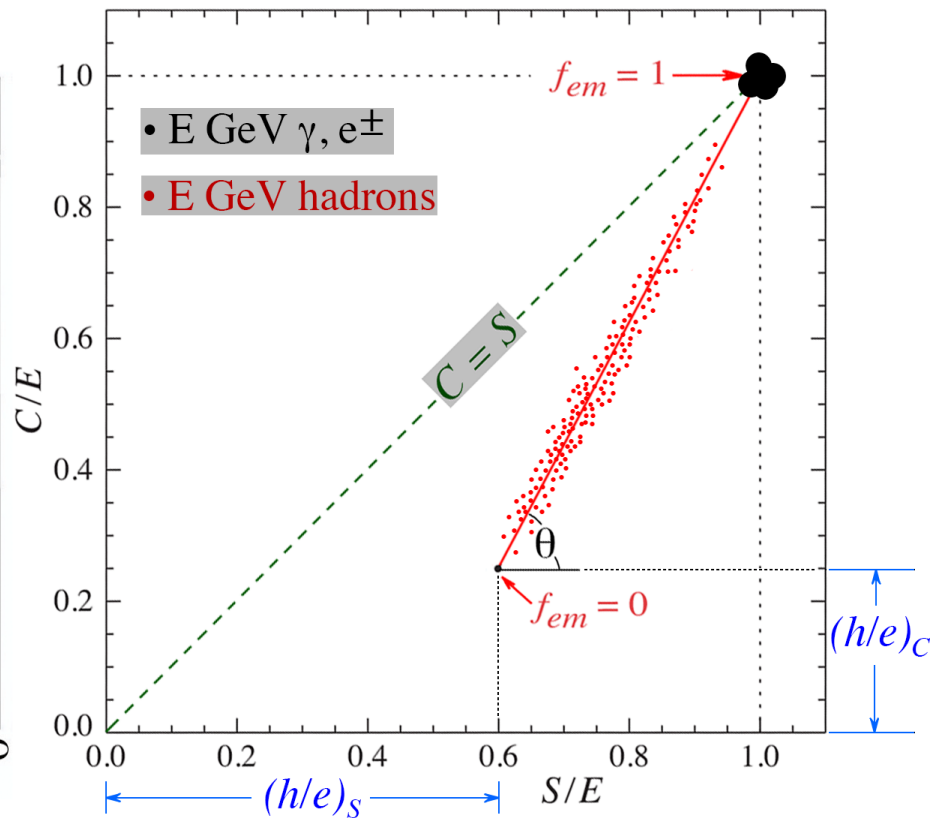
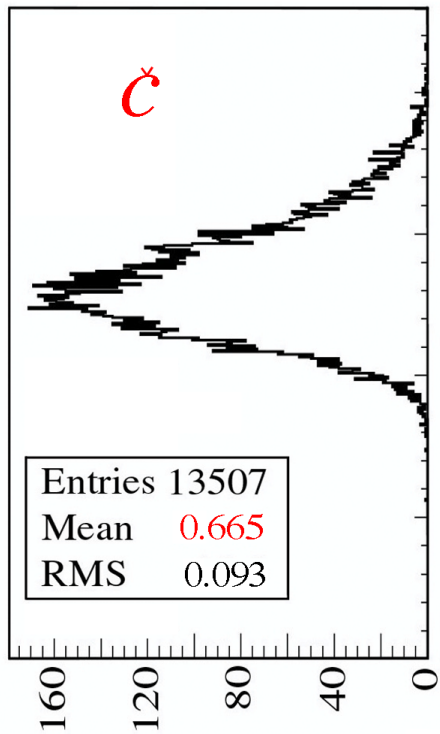

200 GeV "jets"
 in DREAM

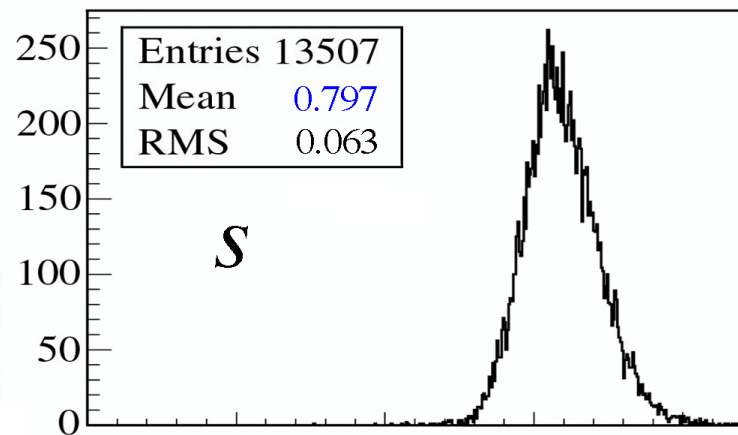

Principles of dual-readout calorimetry (3)

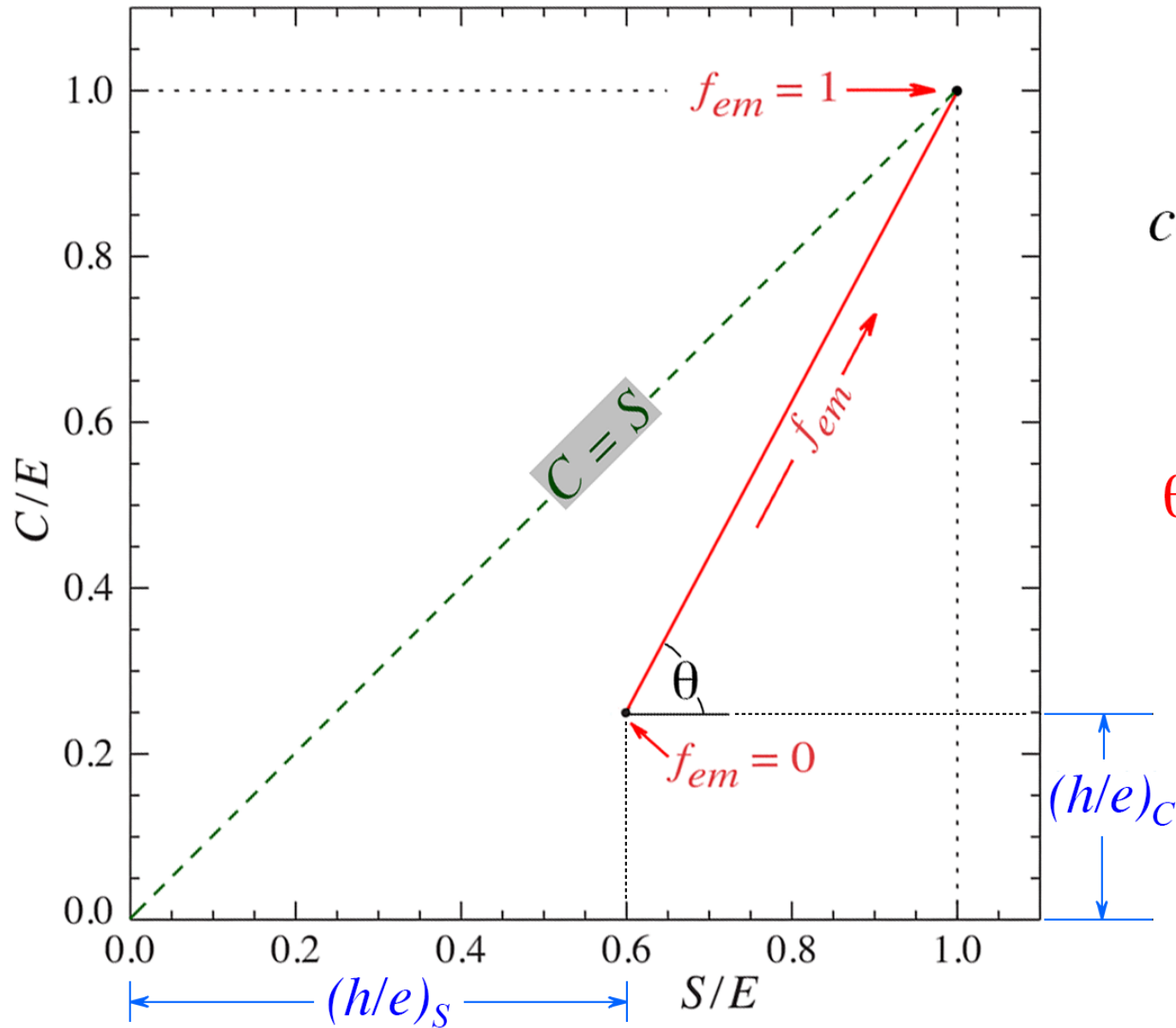

$$\cot \theta = \frac{1 - (h/e)_s}{1 - (h/e)_c} = \chi$$

θ, χ are independent of energy!!

Principles of dual-readout calorimetry (4)

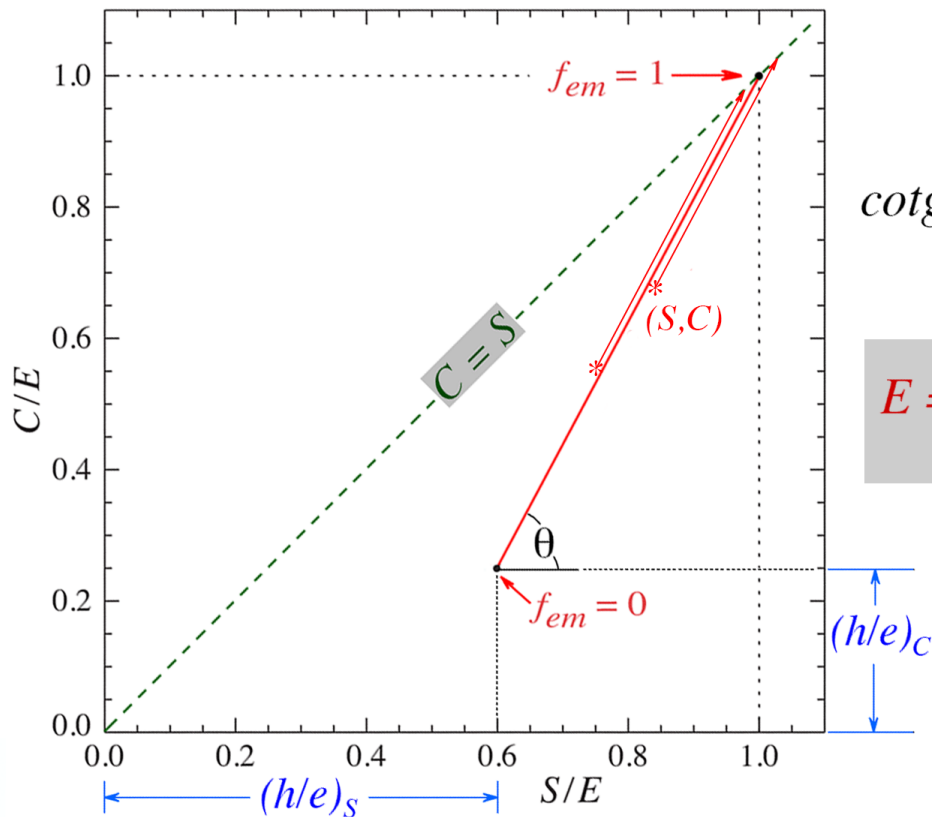
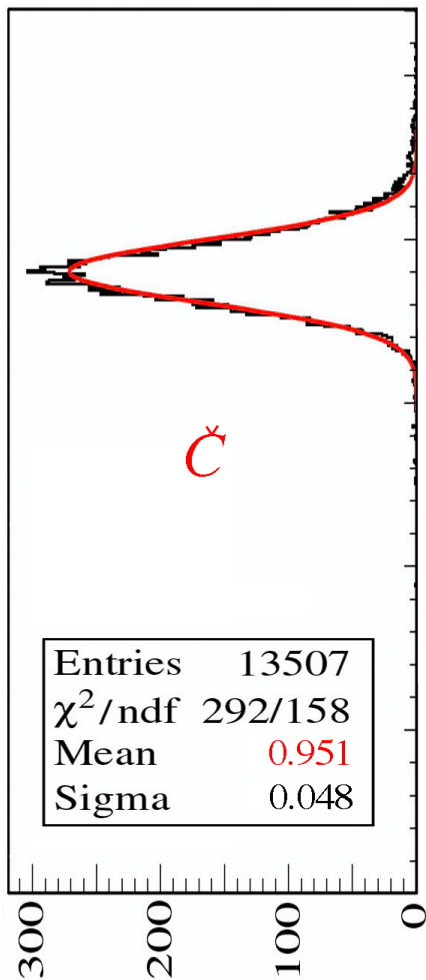

$$\cotg \theta = \frac{1 - (h/e)_S}{1 - (h/e)_C} = \chi$$

$$E = \frac{S - \chi C}{1 - \chi}$$

200 GeV "jets"
in DREAM

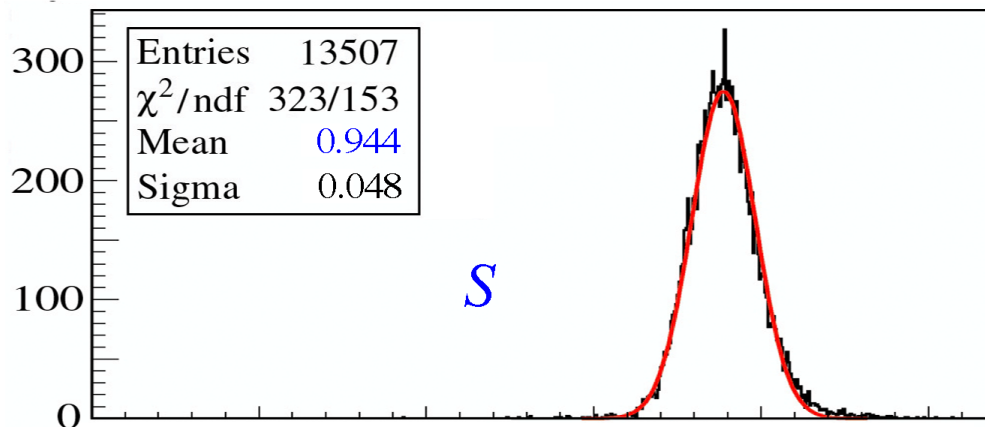

Principles of dual-readout calorimetry (5)

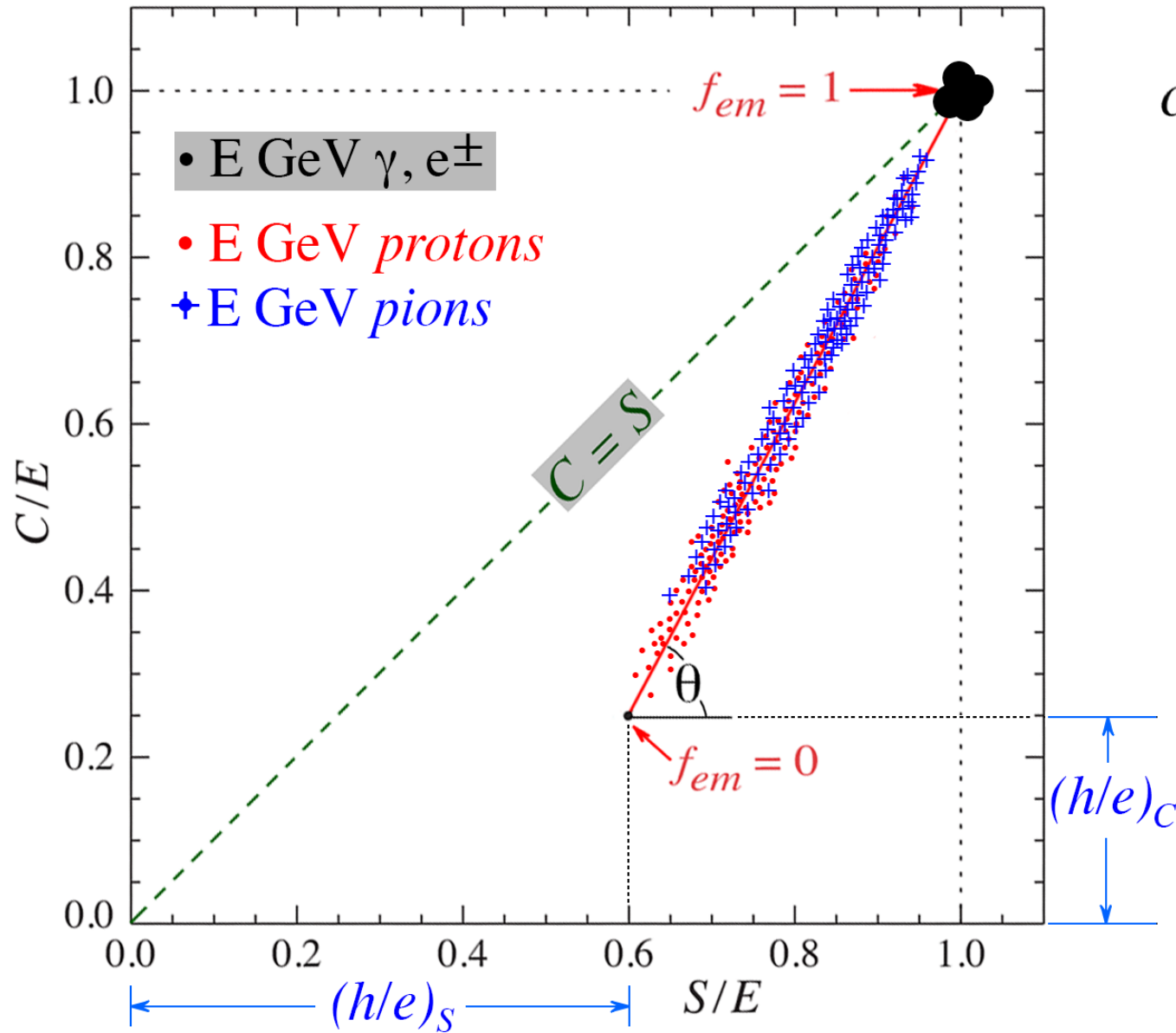

$$\cotg \theta = \frac{1 - (h/e)_s}{1 - (h/e)_c} = \chi$$

θ, χ are independent of energy!!

and also independent of the type of hadron!!

$$E = \frac{S - \chi C}{1 - \chi}$$

is universally valid

Effects of the dual-readout method

Signal linearity

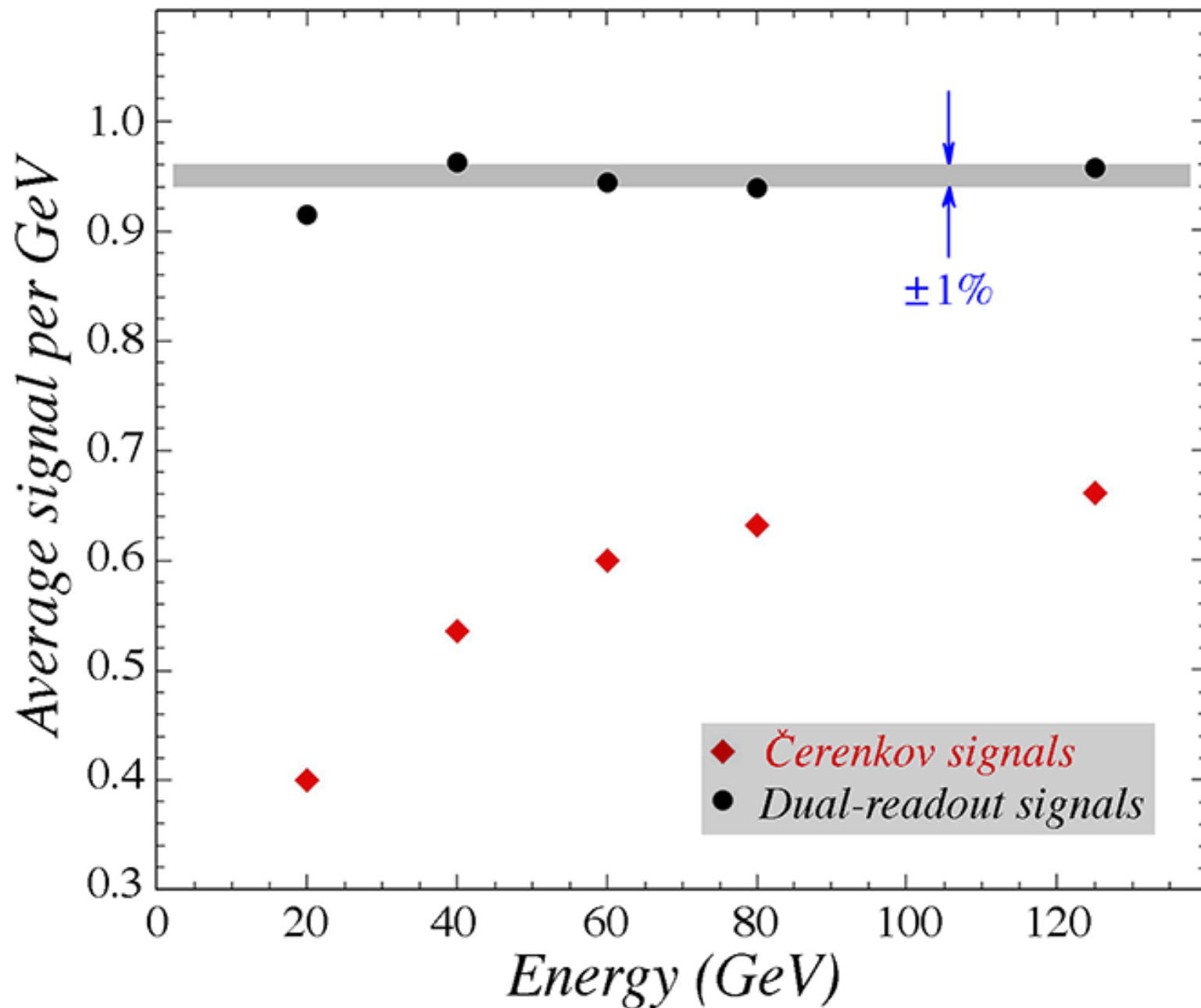

Principles of dual-readout calorimetry (6)

The rotation method

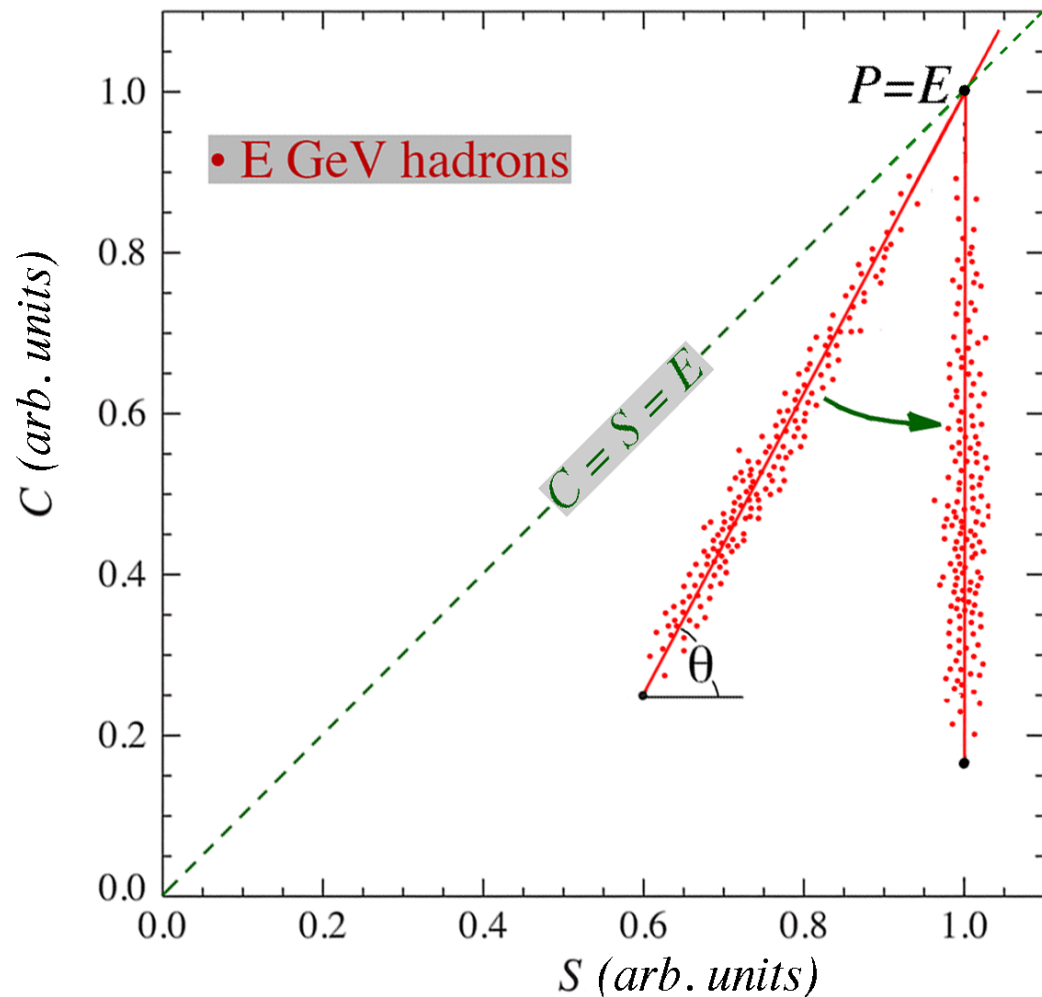

- Fit experimental data with a straight line
- Determine coordinates of P (intersection with $C=S$ line)
- Rotate data points about P over angle $(90^\circ - \theta)$
- Project data points on horizontal (S) axis

θ is independent of E
and particle type!!
→ Don't need this info!!

Some applications of the rotation method

*hadron data taken October 2015
with the lead based RD52 fiber calorimeter*

Applications of the DR rotation method (1)

60 GeV π^-

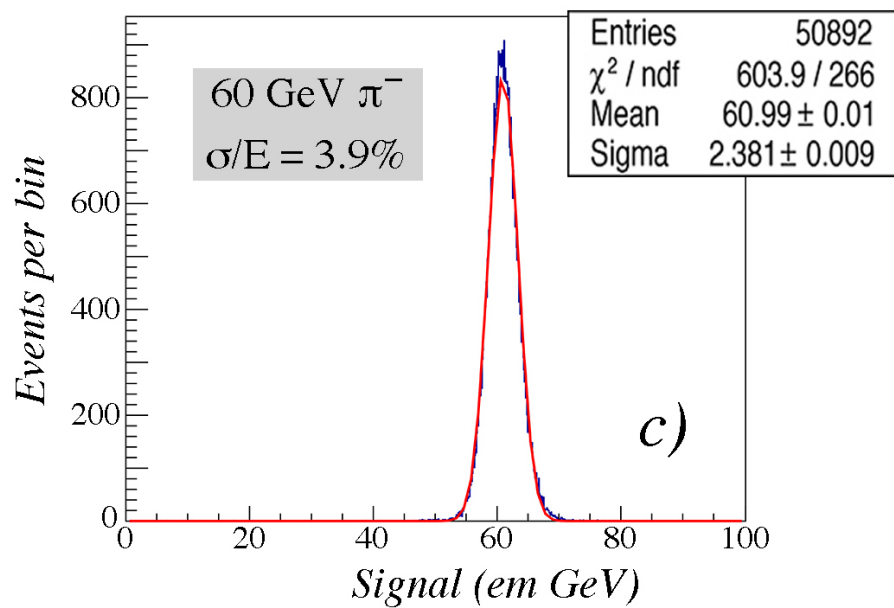
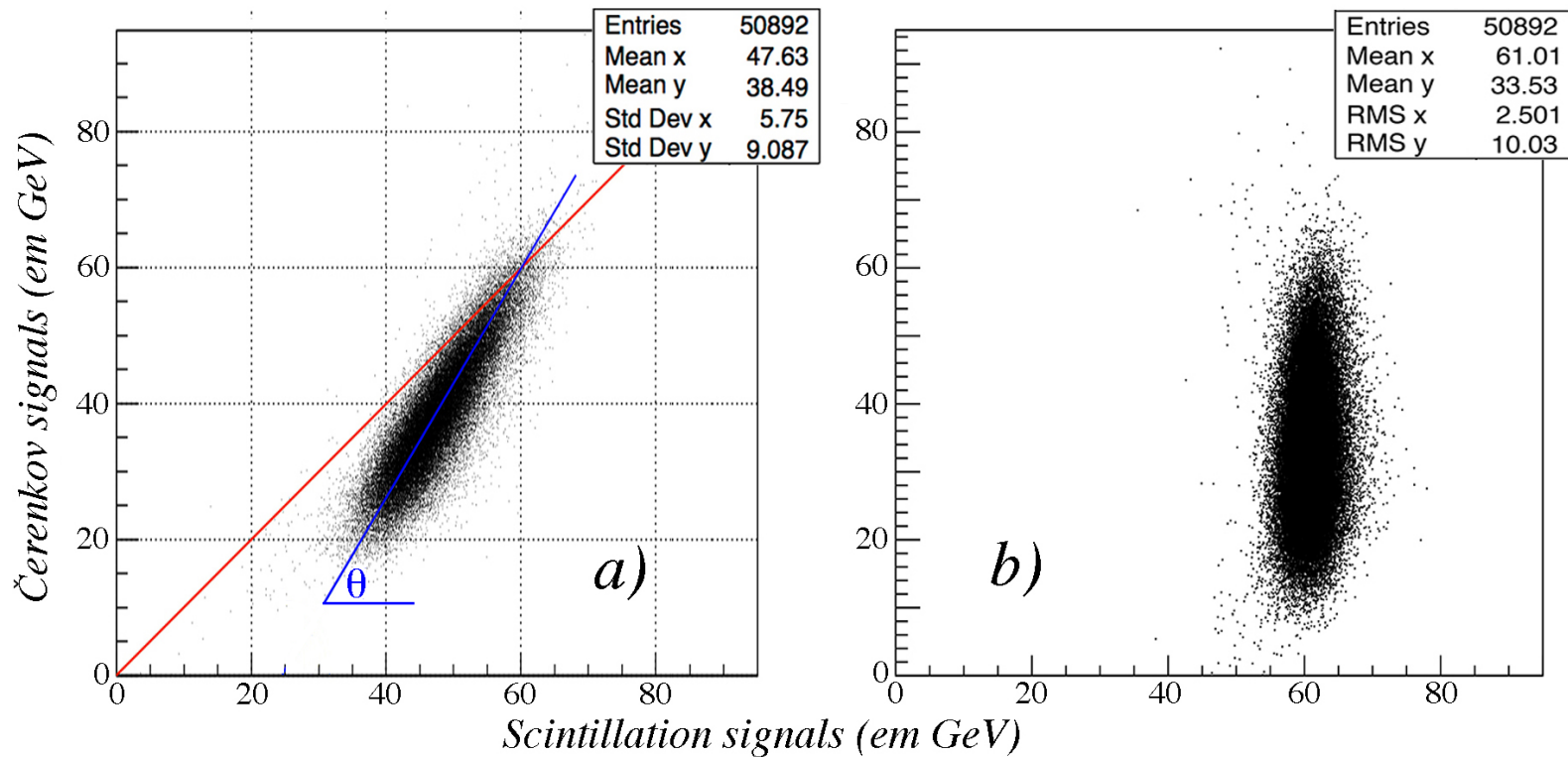

Applications of the DR rotation method (2)

80 GeV π^+ / p

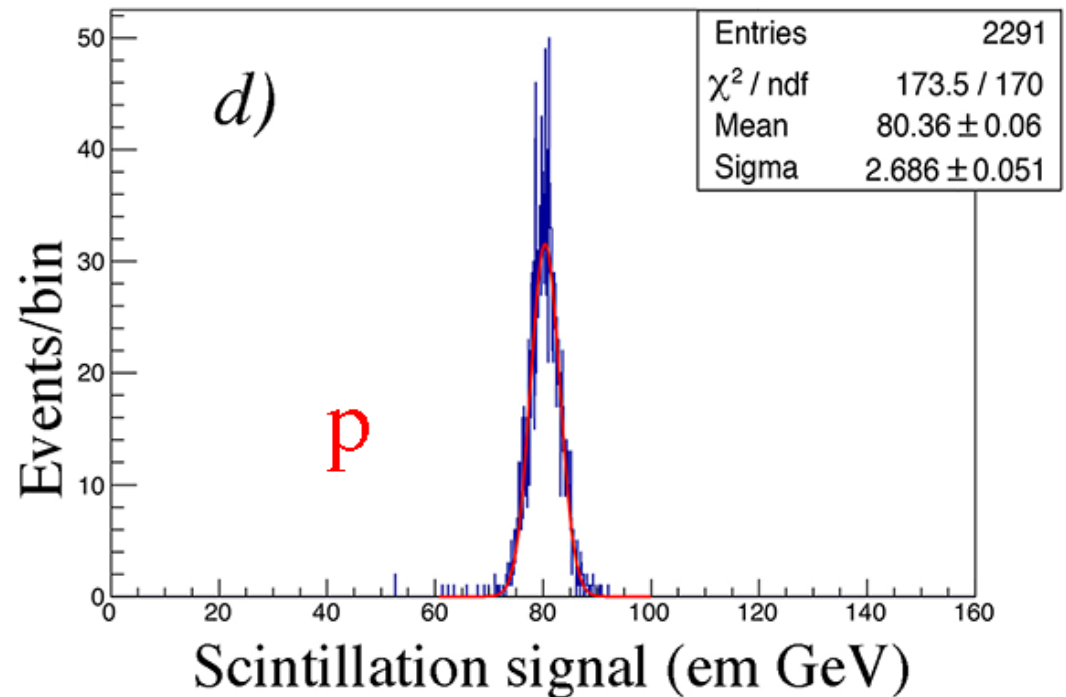
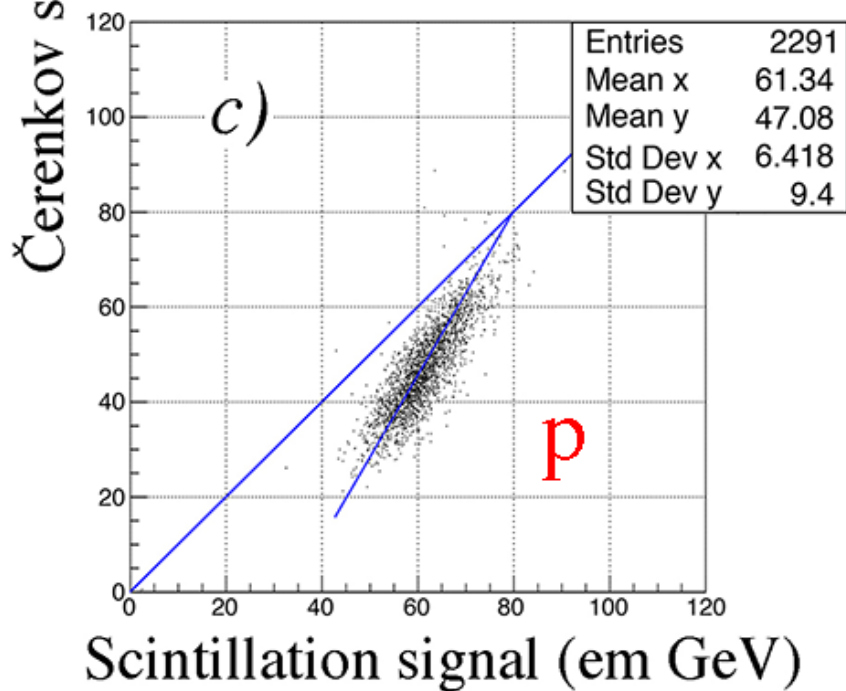
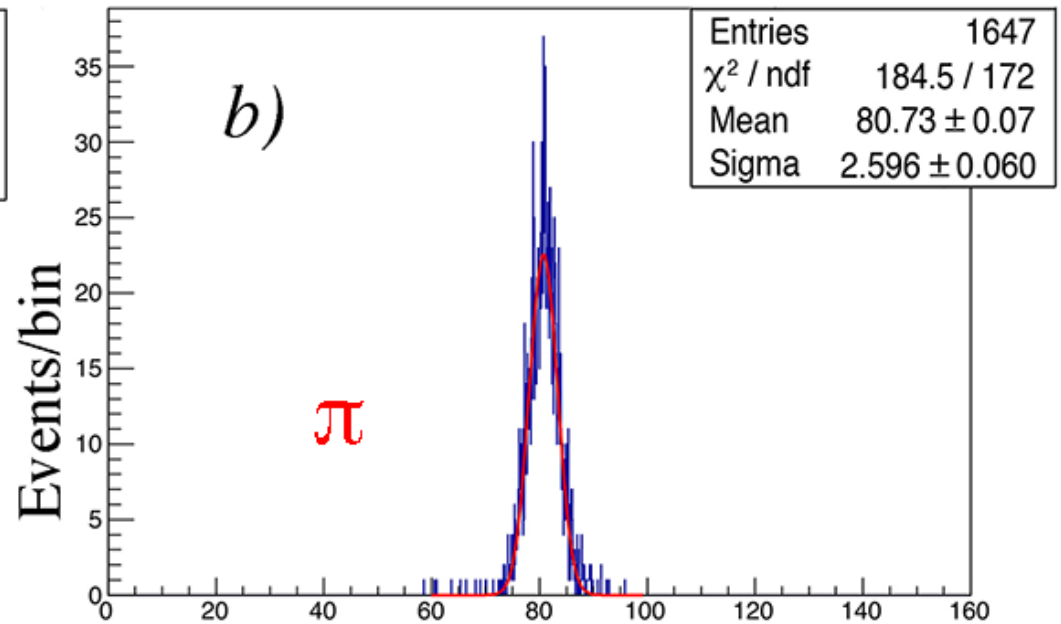
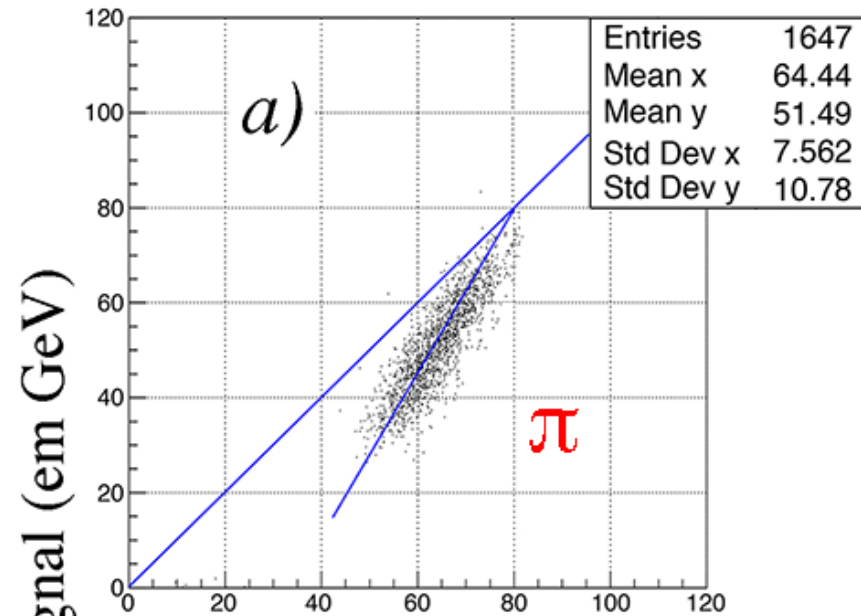

Applications of the DR rotation method (3)

single hadrons, multiparticle events (“jets”)

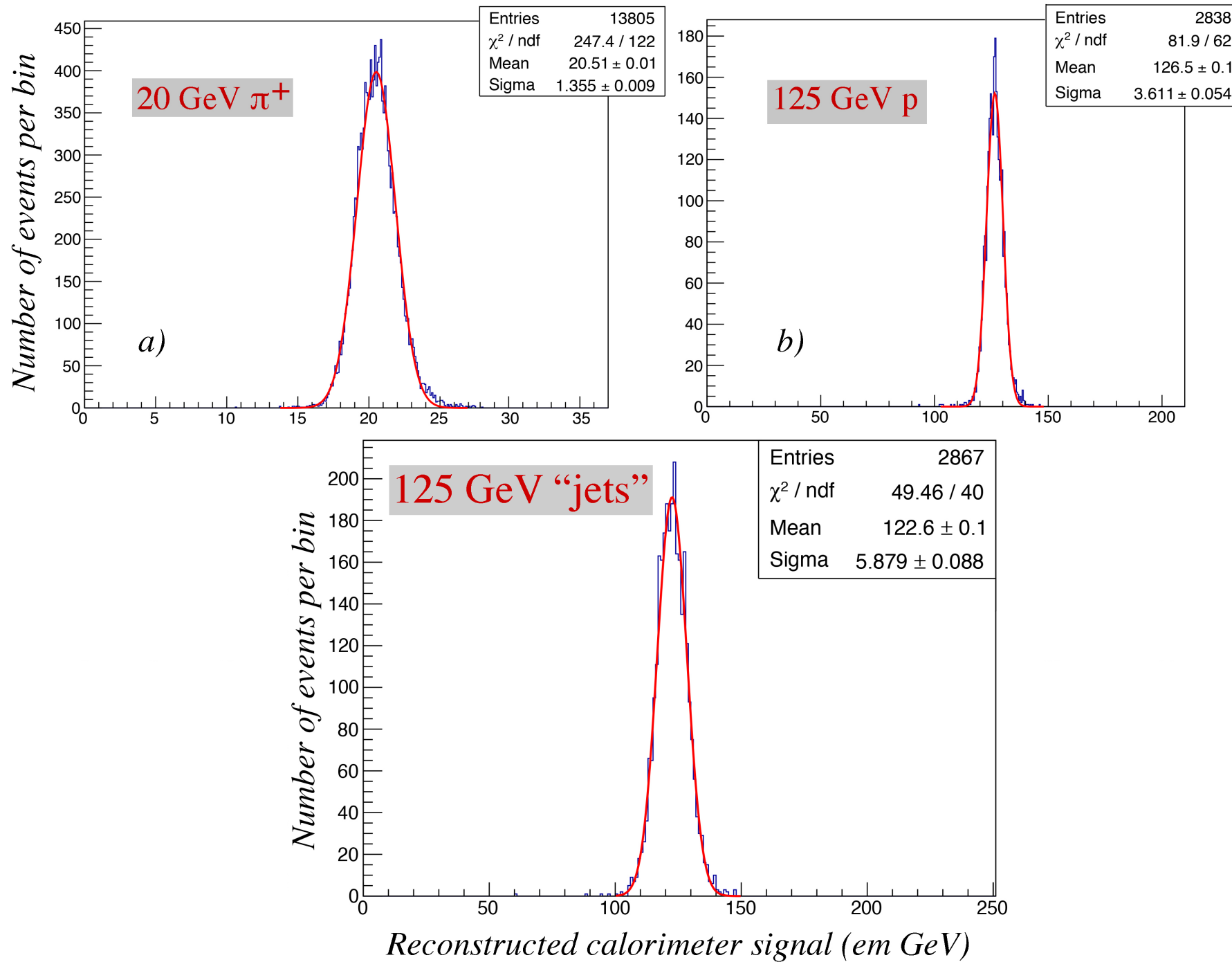

Applications of the DR rotation method (4)
(linearity, fractional width of signal distribution)

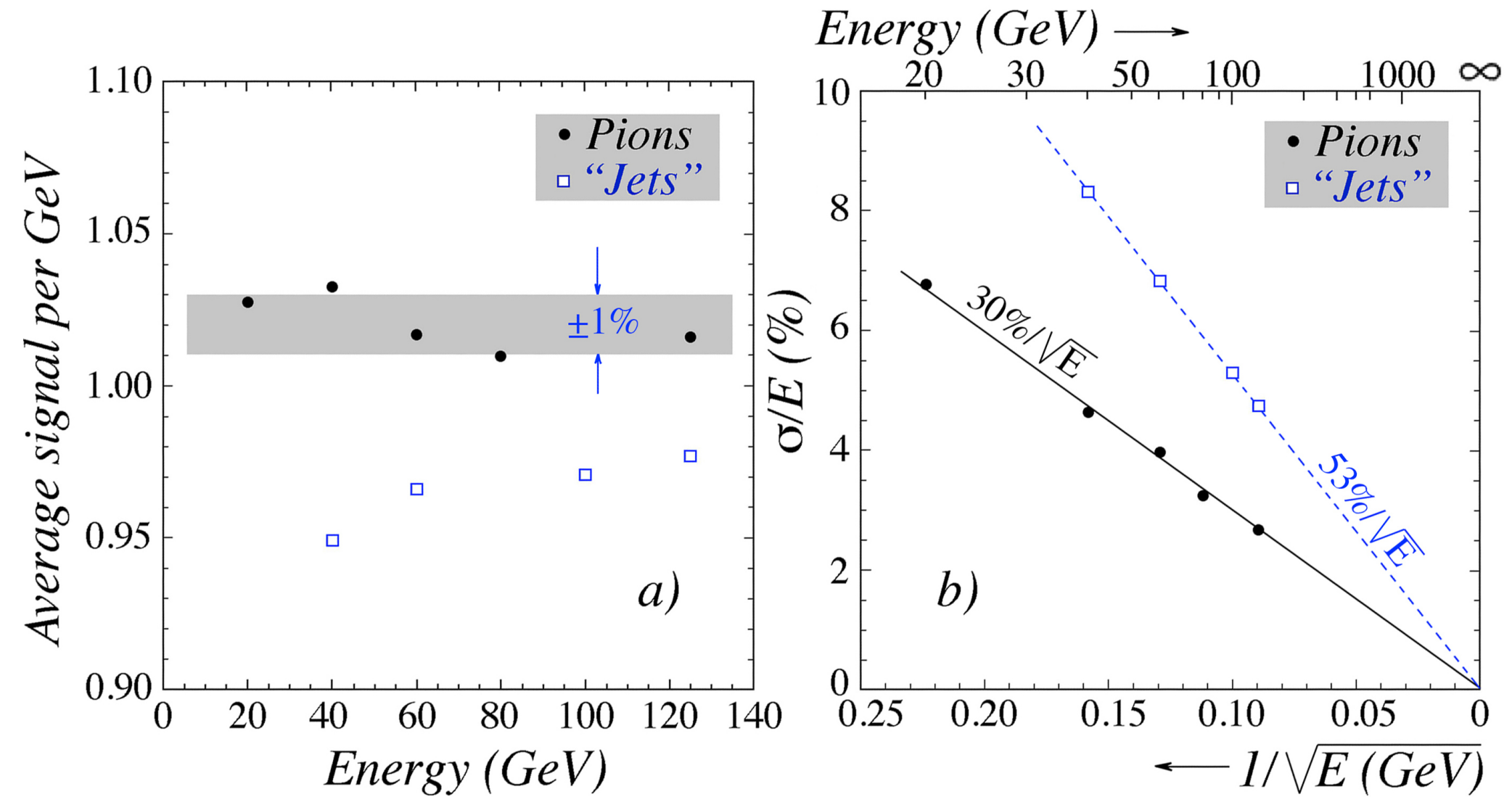

A new phase for RD52

Silicon PM readout

The PMT readout of the DREAM calorimeter

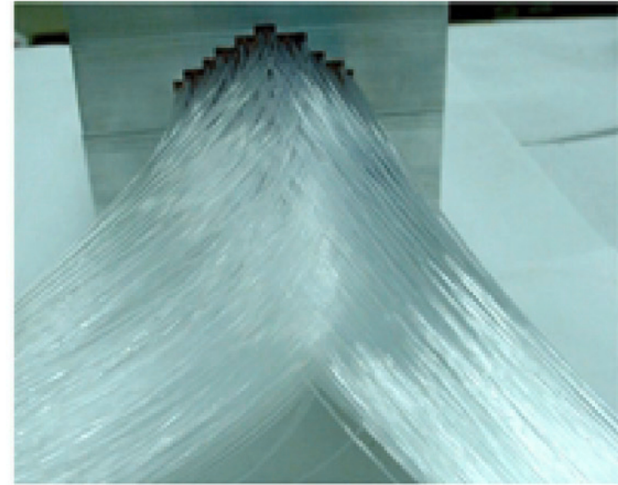
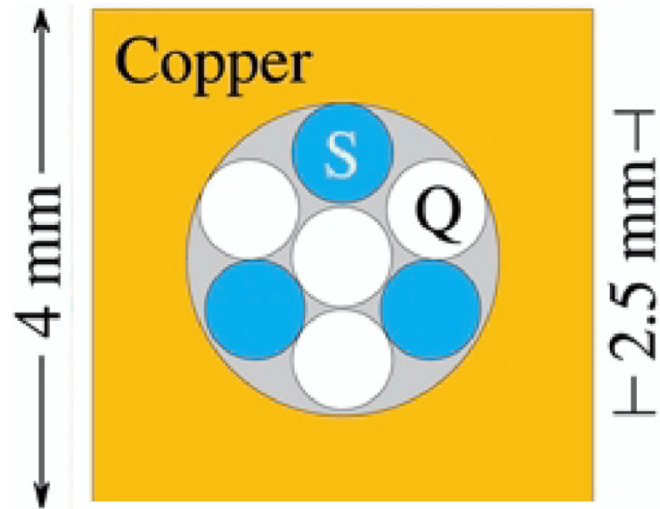

Comparison PMT / SiPM readout

Advantages SiPM:

- *Compact readout, no fibers sticking out (antennas)*
- *Longitudinal segmentation possible*
- *Operation in magnetic field possible*
- *Larger light yield (# Cerenkov photoelectrons limits resolution)*

(Potential) disadvantages SiPM:

- *Signal saturation (digital light detector)*
- *Cross talk between Cerenkov and scintillation signals*
- *Dynamic range*
- *Instrumental effects (stability, afterpulsing, etc....)*

The very first SiPM test of a DR calorimeter (10/2016)

8 x 8 array of 1 mm² Hamamatsu SiPMs, 50 μm pixels (400/SiPM)

1 fiber per SiPM

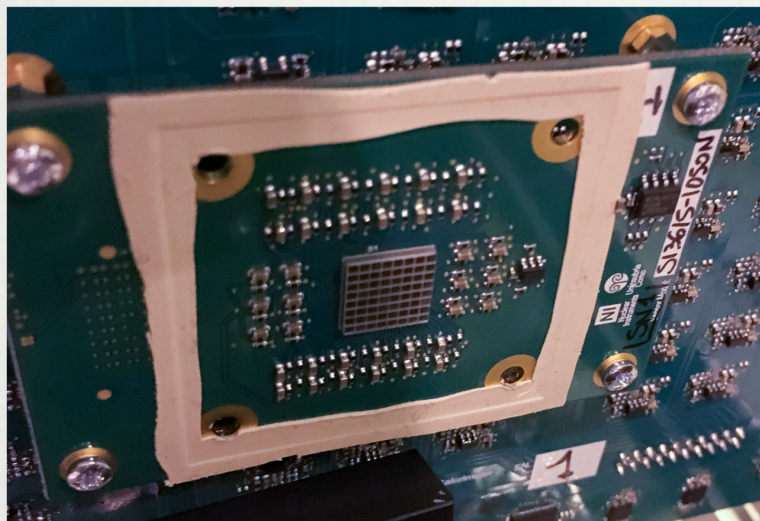

a)

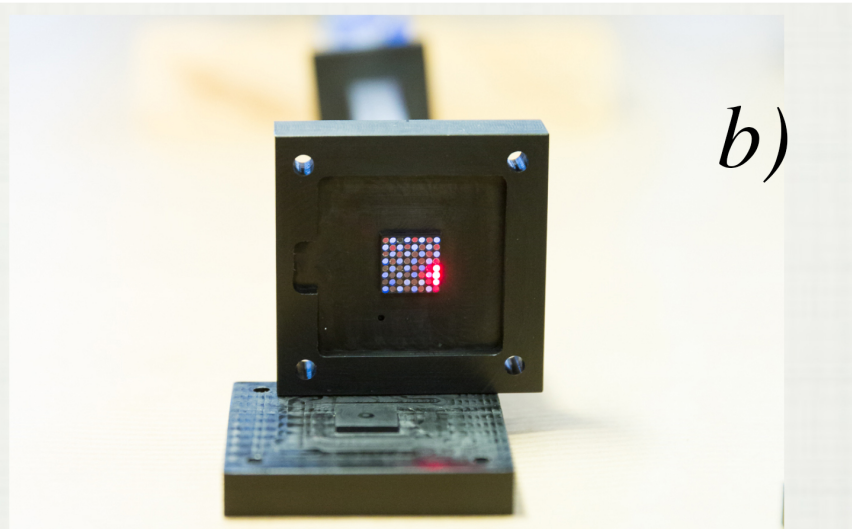

b)

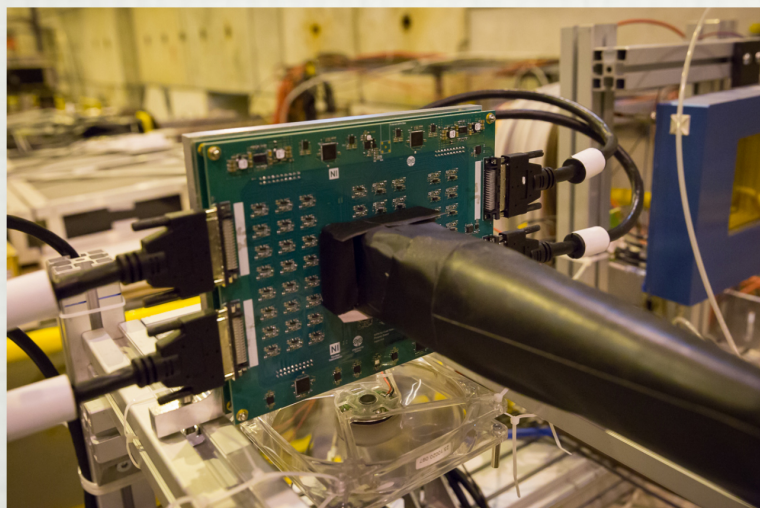

c)

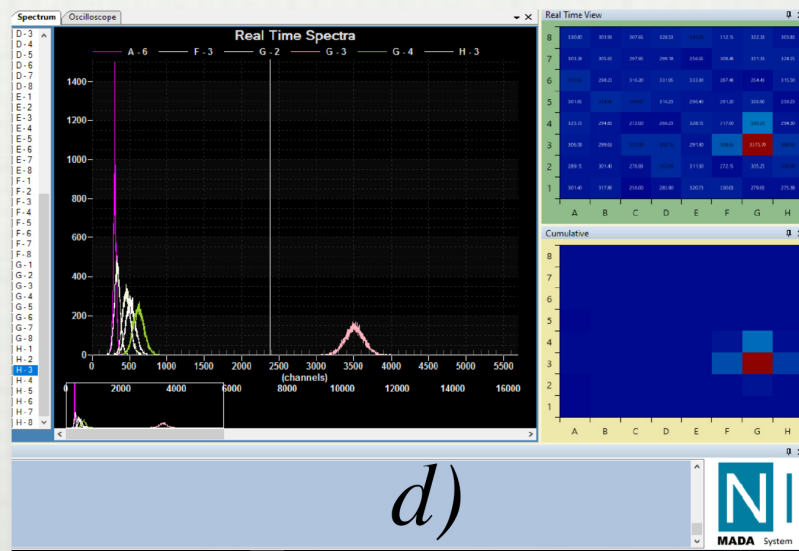

d)

MODULE 1: All channels equipped (32 scintillating + 32 Čerenkov fibers)

MODULE 2: Only Čerenkov fibers connected (32)

1 fiber per SiPM

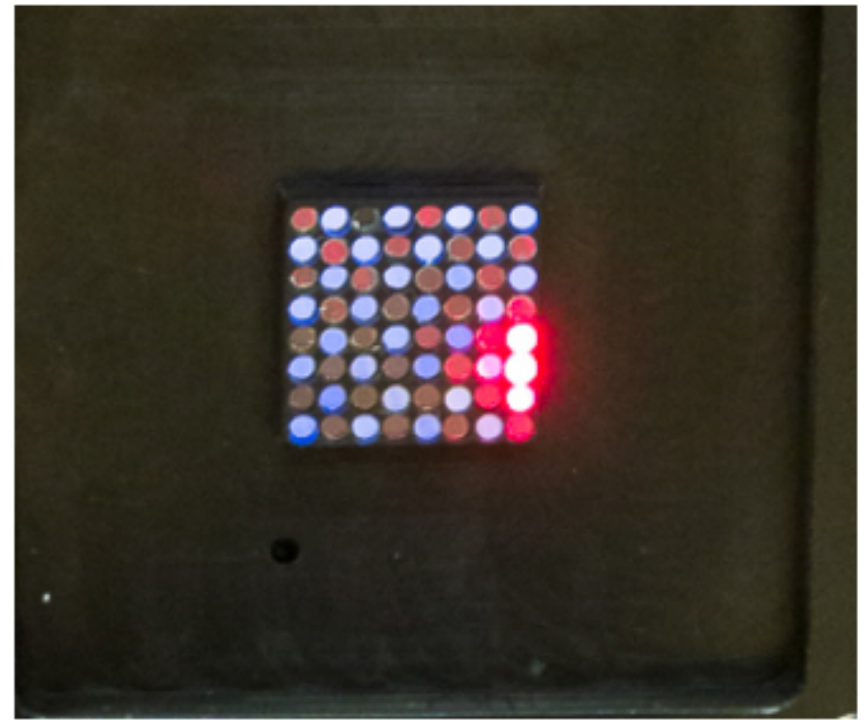
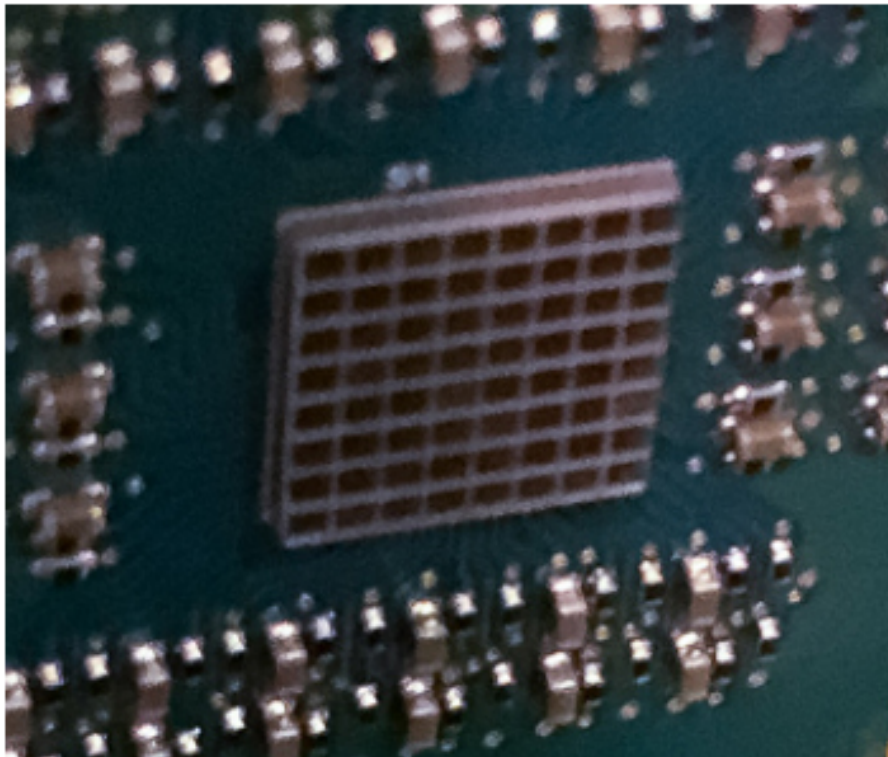

Calibration: Use single-photon response

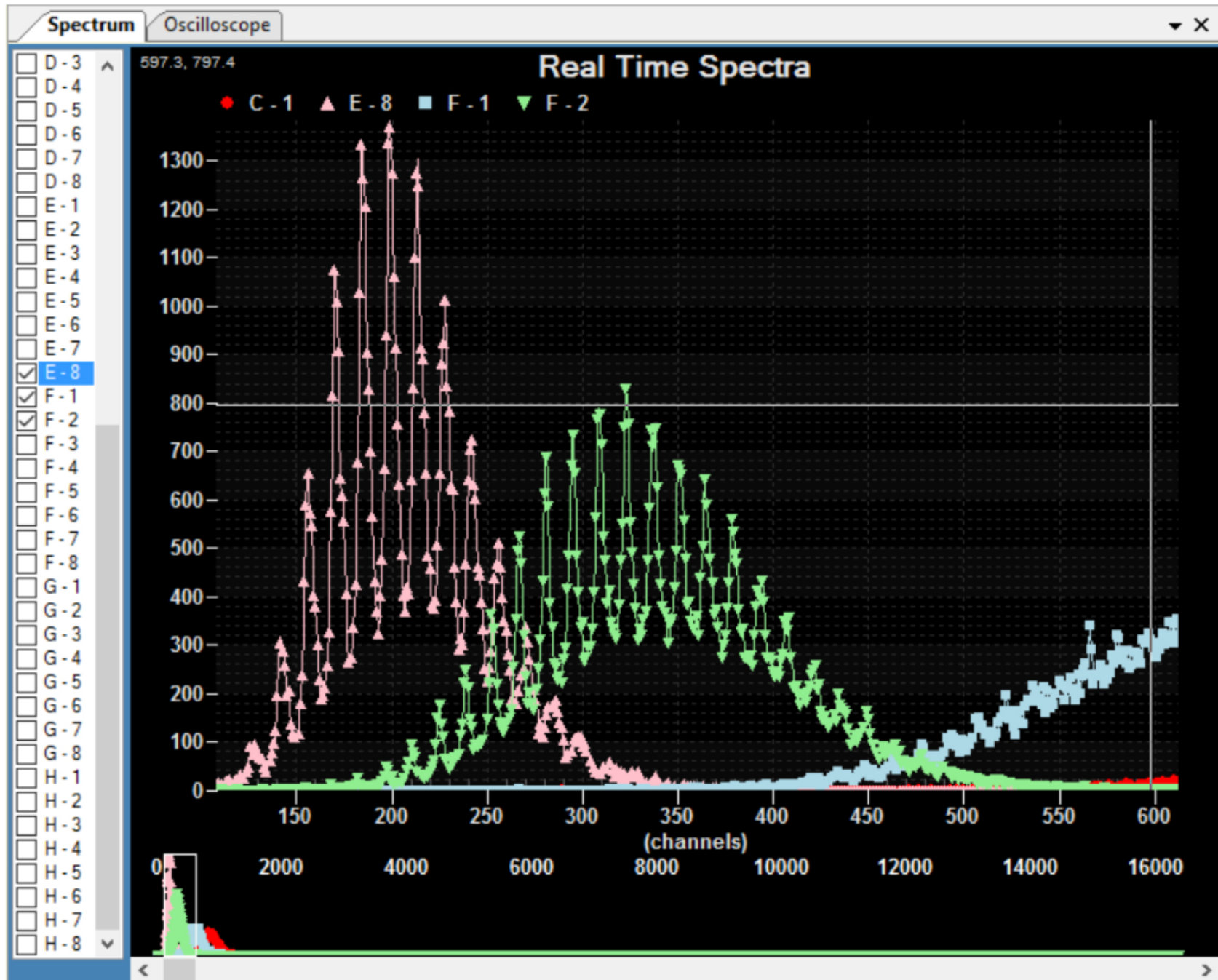

*Event displays in 8 x 8 mm² region
(module 2)*

a)

Centered

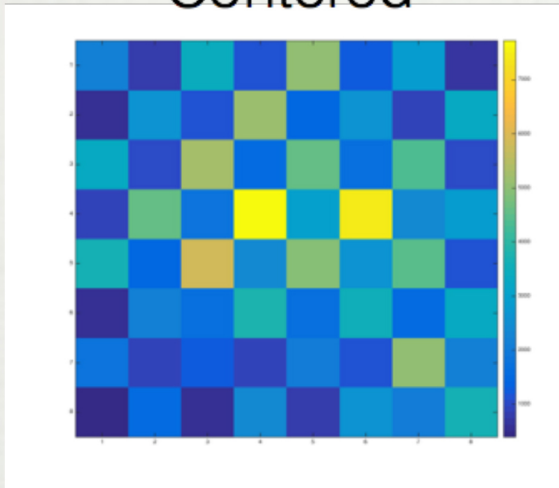

40 GeV electrons

b)

Off-centered

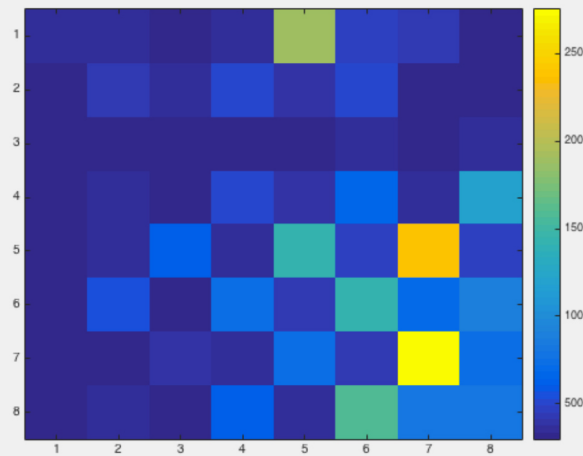

c)

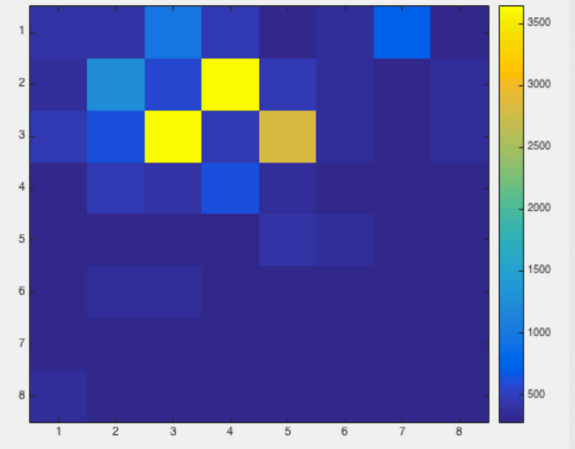

A muon

Showering electrons deposit 50% of their energy in this region

Optical cross talk (module 2)

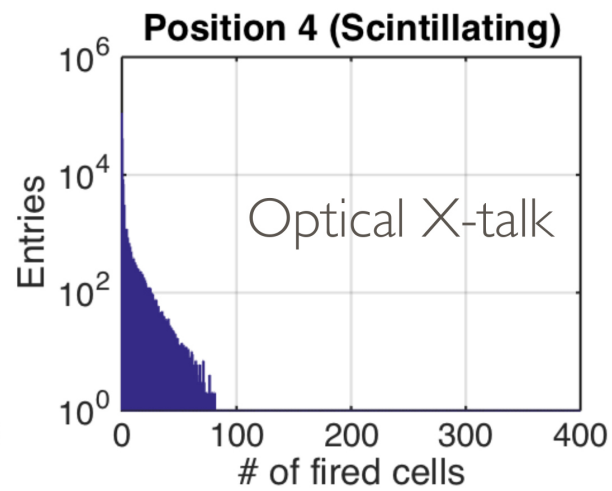
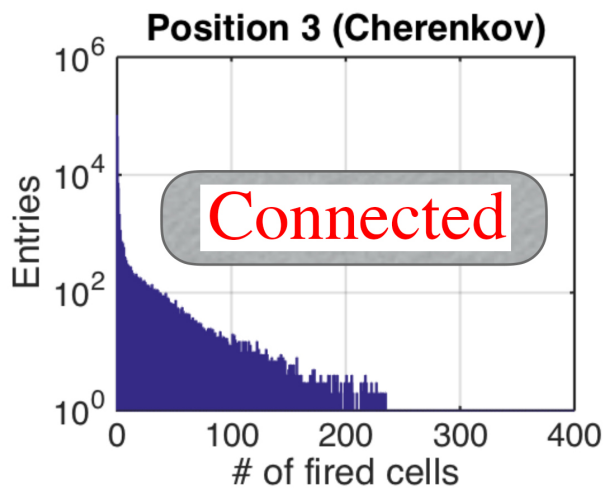
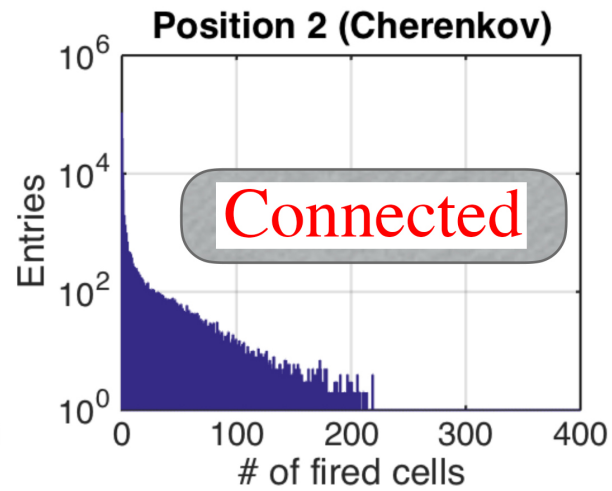
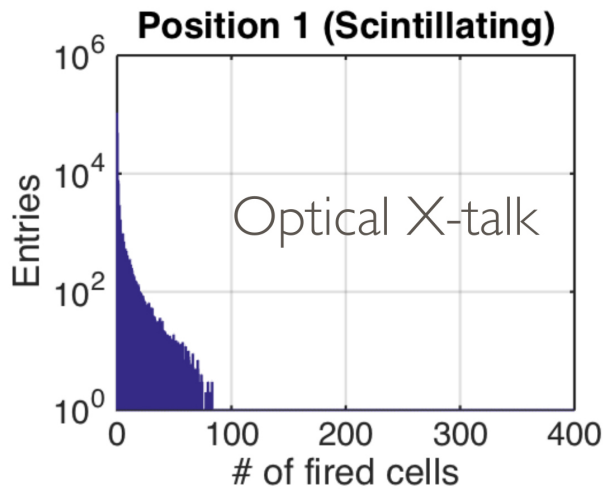

Cerenkov-only module

20 GeV electrons

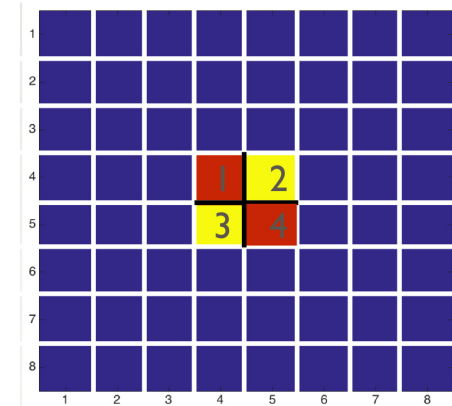

Optical cross talk and signal saturation (module 2)

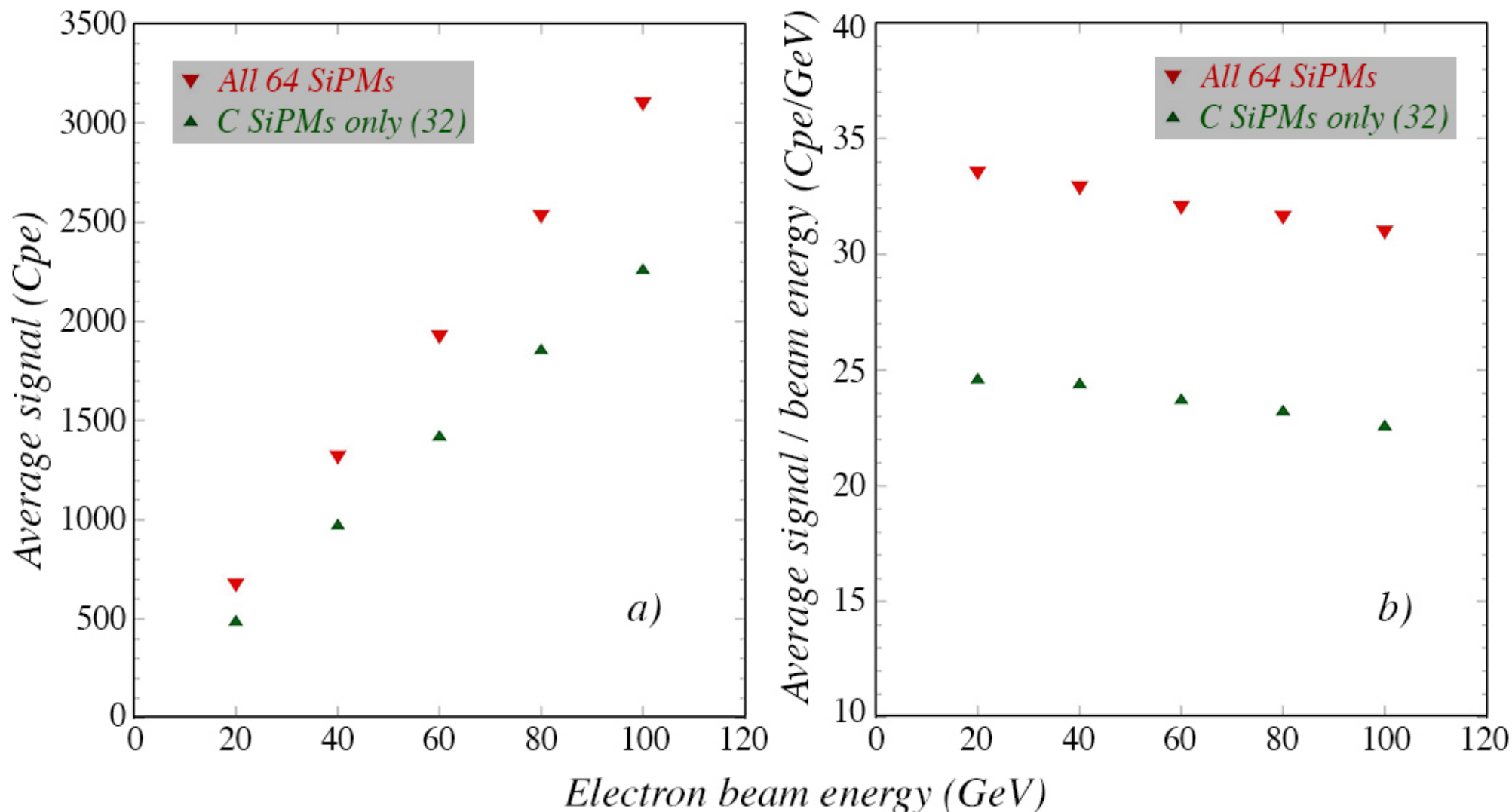

Čerenkov light yield: 60 – 70 p.e./GeV (2x PMT)

Optical cross talk: ~25% to neighboring SiPMs

Non-linearity due to saturation: ~8%

Module 1 (*S + C fibers connected*)

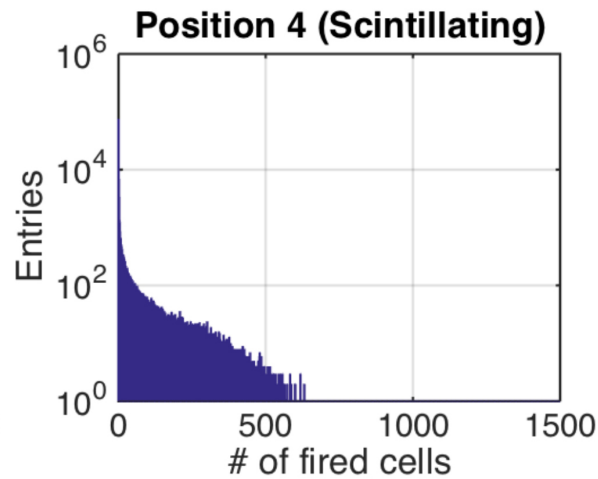
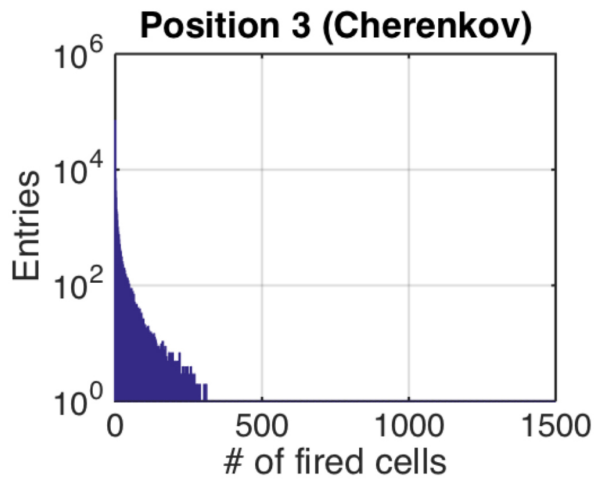
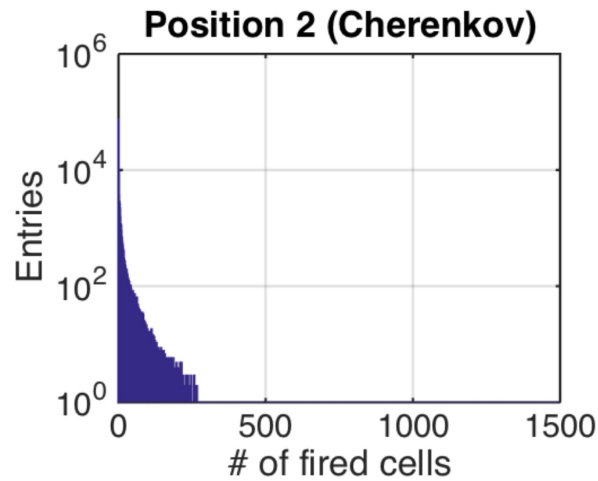
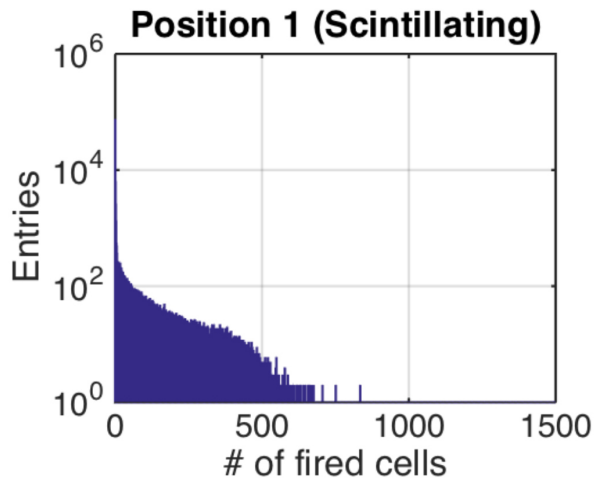

S+C module
20 GeV electrons

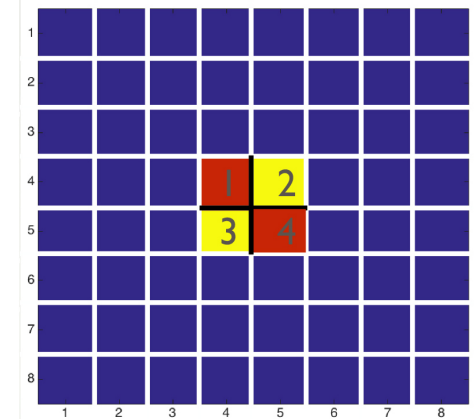

Central fibers completely saturated (> 400 photons!)

Čerenkov signals, comparison modules 1,2

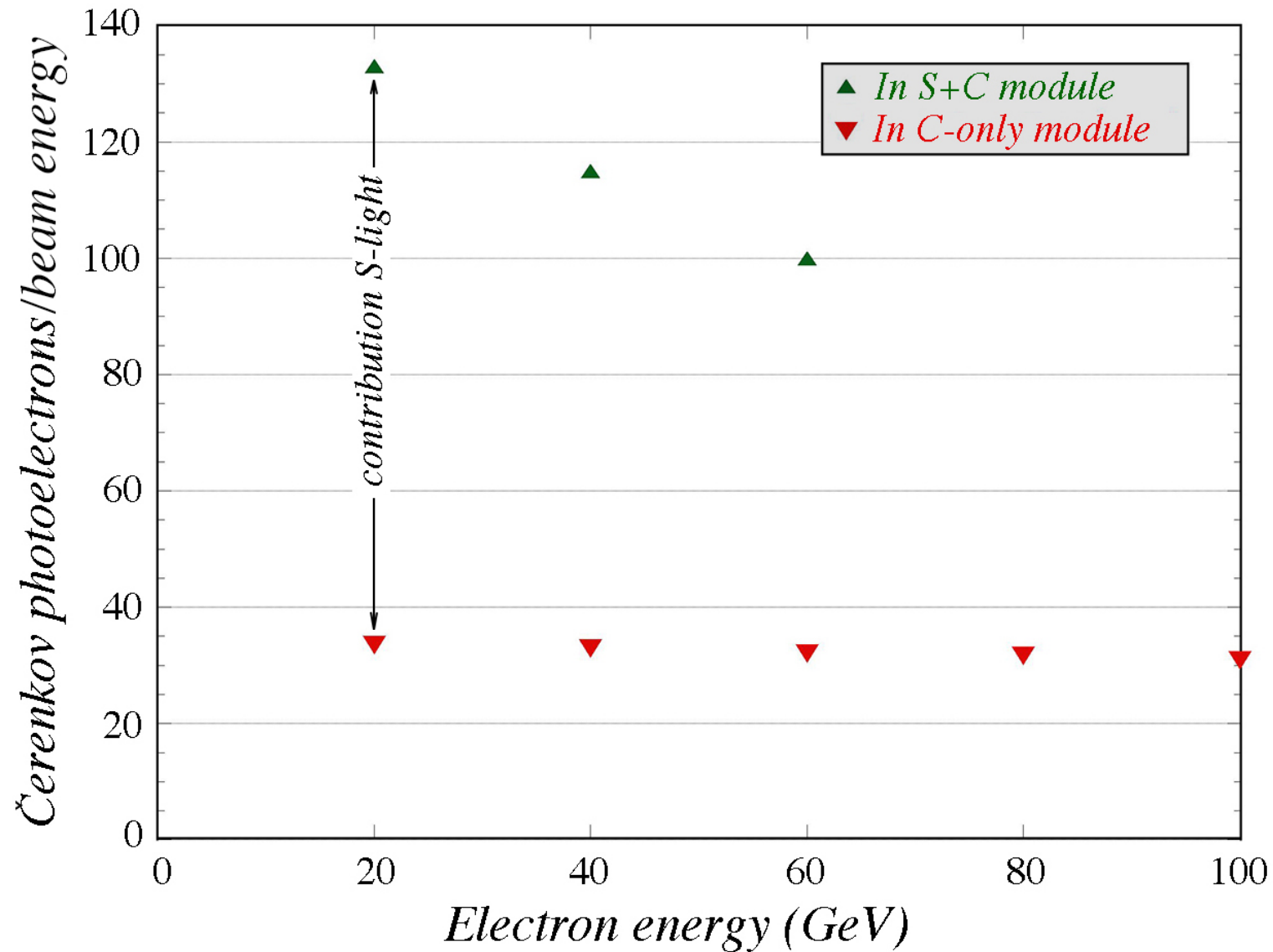

Module 1: Čerenkov signals dominated by xtalk S fibers

Light yield S fibers estimated 20x Č fibers

Plans for 2017

(1 week in July)

Goals for 2017 SiPM tests

- *Eliminate crosstalk between S and C signals as much as possible*
Use separate arrays for both signals, fiber feed thru crucial issue
- *Eliminate / strongly reduce saturation effects*
Only an issue for S signals
Use SiPMs with smaller pixels, reduce gain

Calorimeter Module for 2017 Test Beam

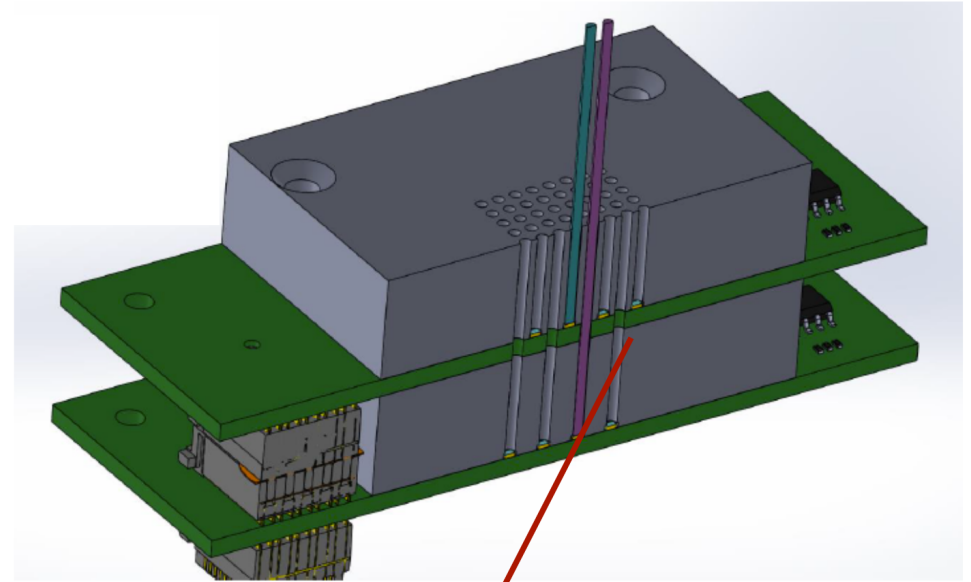

Places for SiPMs

**Holes to access
the second layer**

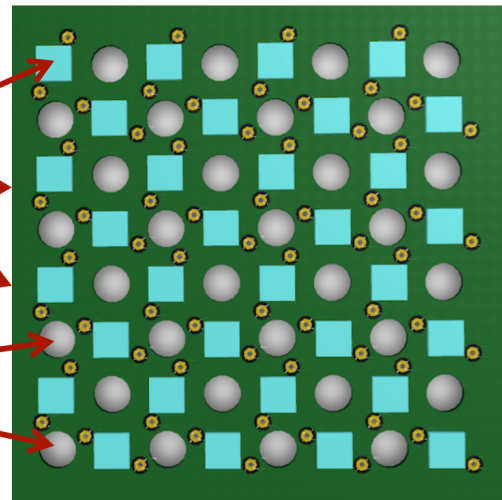

Goals 2017 beam tests

In addition, we want to test two new full-scale copper-fiber calorimeter modules, built at Iowa State University (standard PMT readout)

For both components of our experimental program, we request electron beams, with energies from 10 - 100 GeV

*First full scale Cu modules built at Iowa State Univ.
(using Cu/Te alloy)*

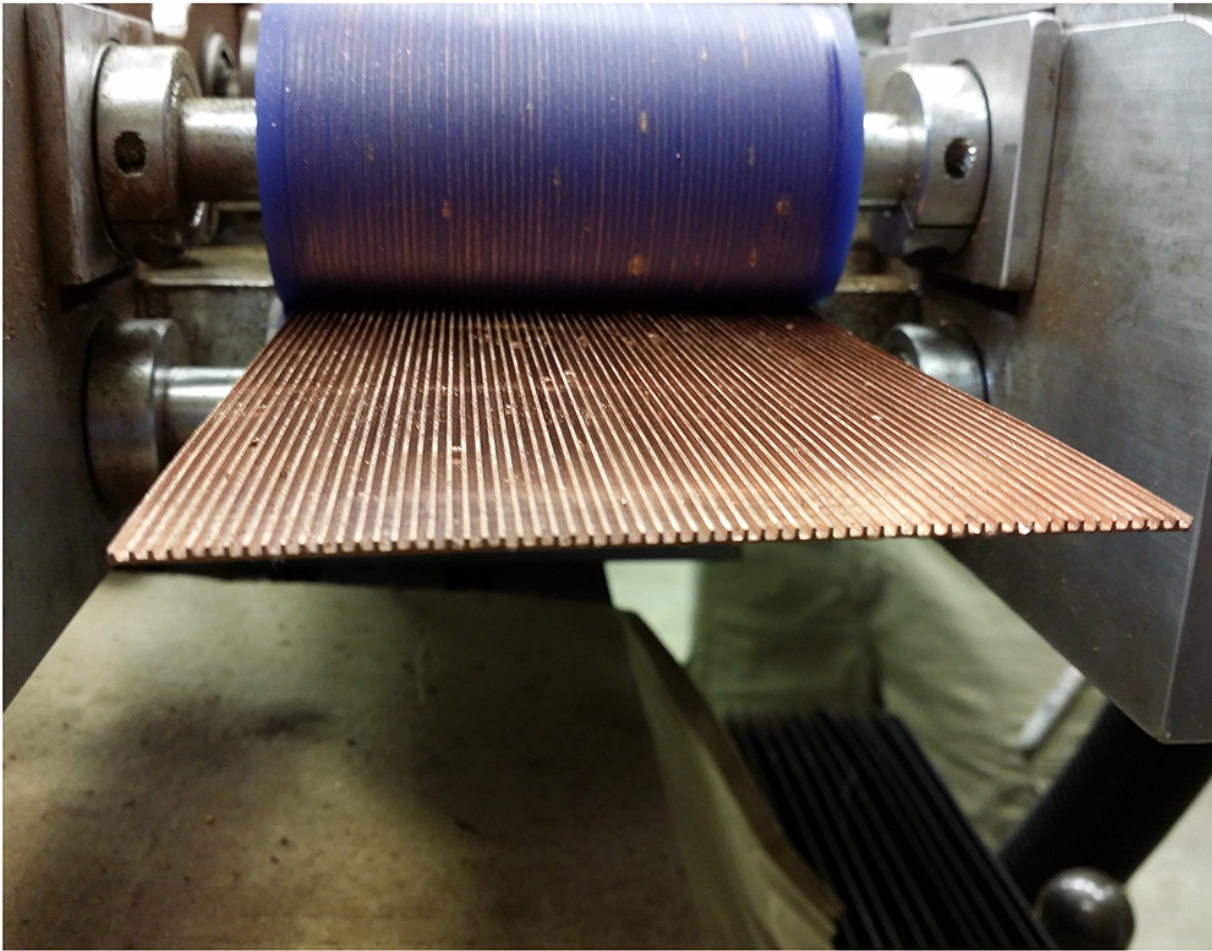

Backup slides

DUAL-READOUT CALORIMETRY
for pedestrians

Richard Wigmans
Como, 29/3/2017

The physics of hadronic shower development

- A hadronic shower consists of two components

- Electromagnetic component**

- electrons, photons
 - neutral pions $\rightarrow 2 \gamma$

- Hadronic (non-em) component**

- charged hadrons π^\pm, K^\pm (20%)
 - nuclear fragments, p (25%)
 - neutrons, soft γ 's (15%)
 - break-up of nuclei ("invisible") (40%)

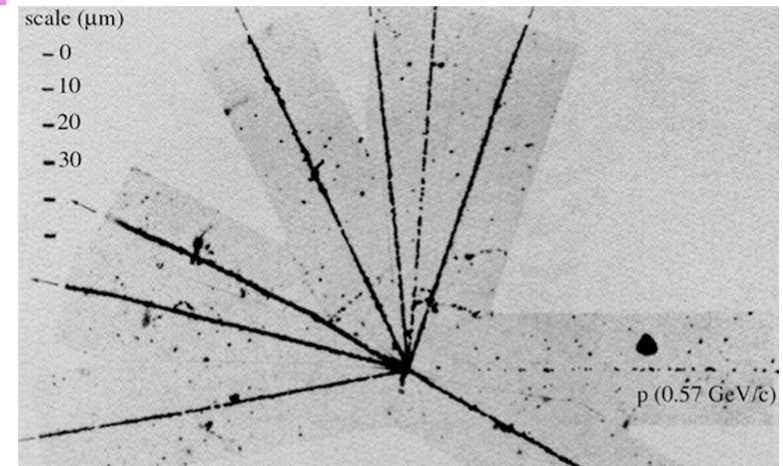
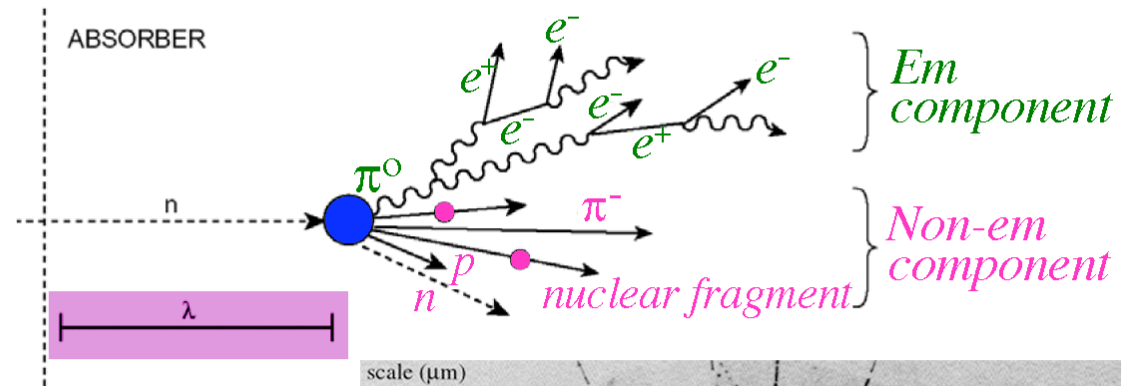

- Important characteristics for hadron calorimetry:

- Large, non-Gaussian fluctuations in energy sharing em/non-em
 - Large, non-Gaussian fluctuations in "invisible" energy losses (e.g. 100 GeV π : energy resolution ZEUS 3.5%, D0 7%)

*The calorimeter response to the two shower components
is NOT the same*

(mainly because of nuclear breakup energy losses in non- π^0 component)

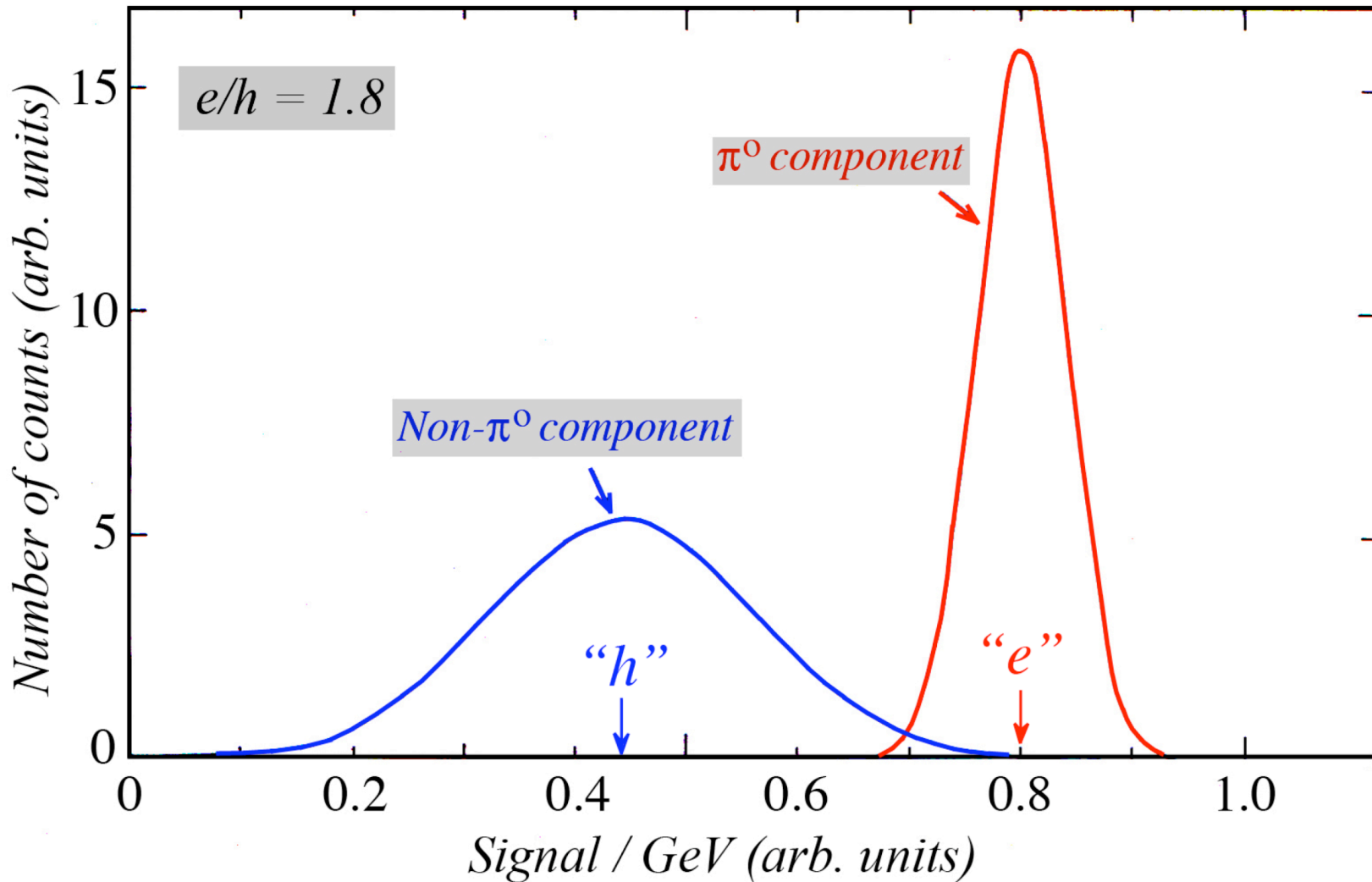

This effect is quantified by the e/h ratio.

In this example, only $1/1.8 = 56\%$ of the non- π^0 energy contributes to signals

IMPORTANT

(often misunderstood)

The e/h ratio is INDEPENDENT of the particle energy

It is determined by the calorimeter structure

For example, in crystal calorimeters $e/h \sim 2$

in sampling calorimeters it is typically smaller (1 - 1.8)

What DOES depend on the energy is the e/π signal ratio

This is because of the E dependence of the em shower component (f_{em})

*And since $\langle f_{em} \rangle$ and its fluctuations are different for π, K, p ,
the response functions are typically different for these particles*

(Fluctuations in) the electromagnetic shower fraction, f_{em}
i.e. the fraction of the shower energy deposited by π^0 s

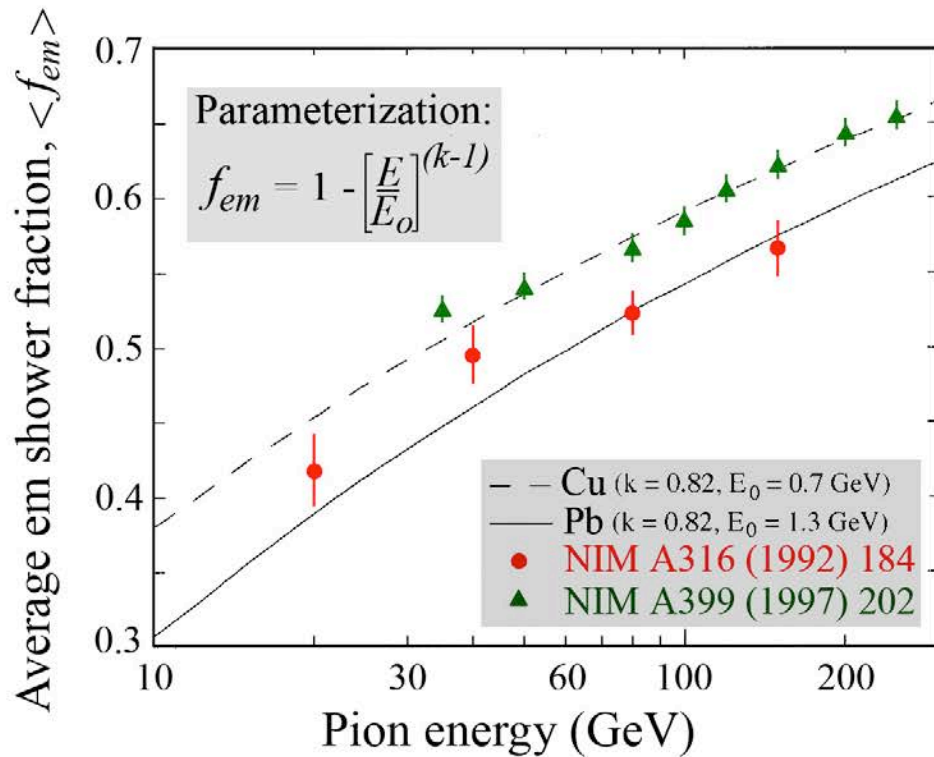

The em fraction is, on average,
large and energy dependent

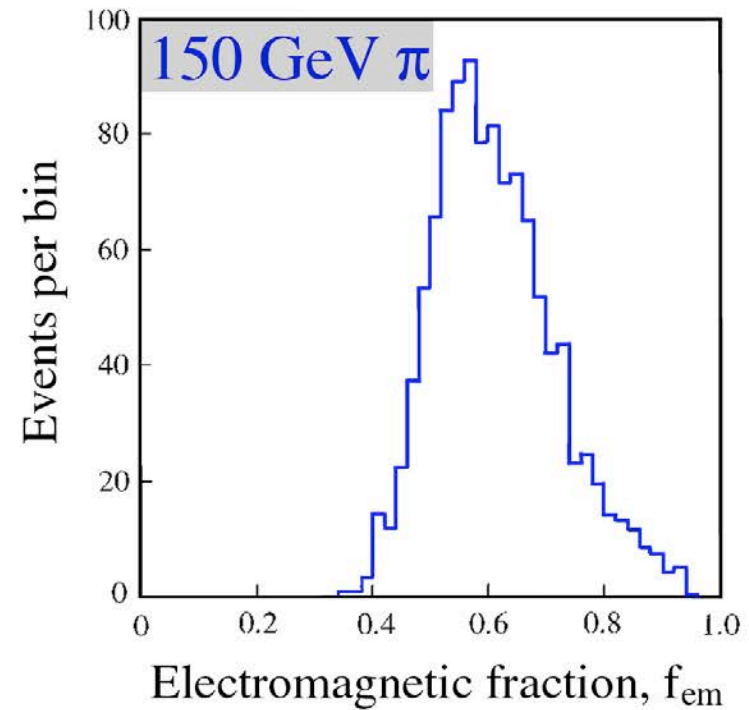

Fluctuations in f_{em} are
large and non-Poissonian

Fluctuations in the em shower component (f_{em})

- *Why are these important ?*
 - Electromagnetic calorimeter response \neq non-em response ($e/h \neq 1$)
 - Event-to-event fluctuations are large and *non-Gaussian*
 - $\langle f_{em} \rangle$ *depends on* shower *energy* and *age*
- *Cause of all common problems in hadron calorimeters*
 - *Energy scale* different from electrons, in energy-dependent way
 - Hadronic *non-linearity*
 - *Non-Gaussian* response function
 - Poor energy *resolution*
 - *Calibration* of the sections of a longitudinally segmented detector

Dual-readout calorimetry

Measure the em shower fraction f_{em} event by event

*→ eliminate effects of fluctuations in f_{em}
on the calorimeter performance*

Exploit the fact that the (e/h) values for a sampling calorimeter based on scintillation light or Čerenkov light are (very) different (e.g. protons from h component contribute to S , but not to Č signals)

Proton / pion differences in calorimeter signals caused by differences in em shower fraction characteristics

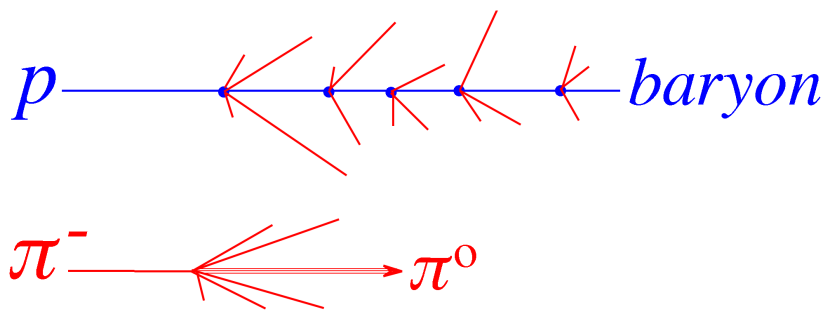
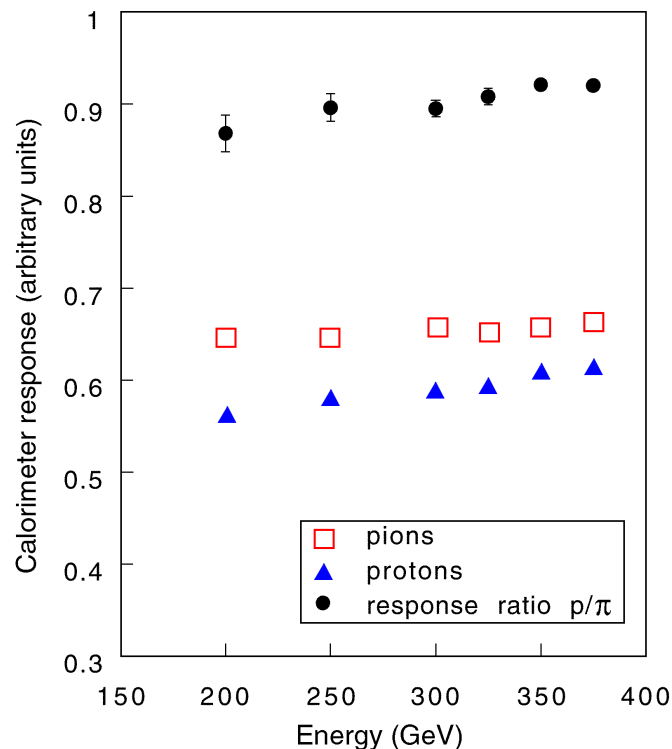
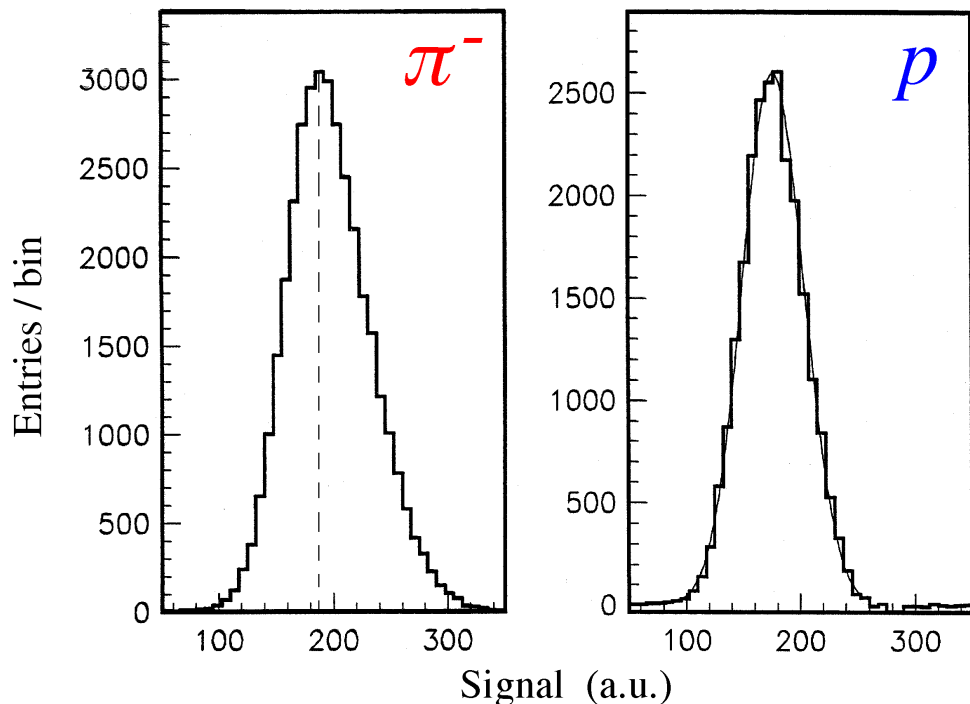

em fraction in p showers:

- smaller
- less fluctuations
- more symmetric
- less concentrated near axis

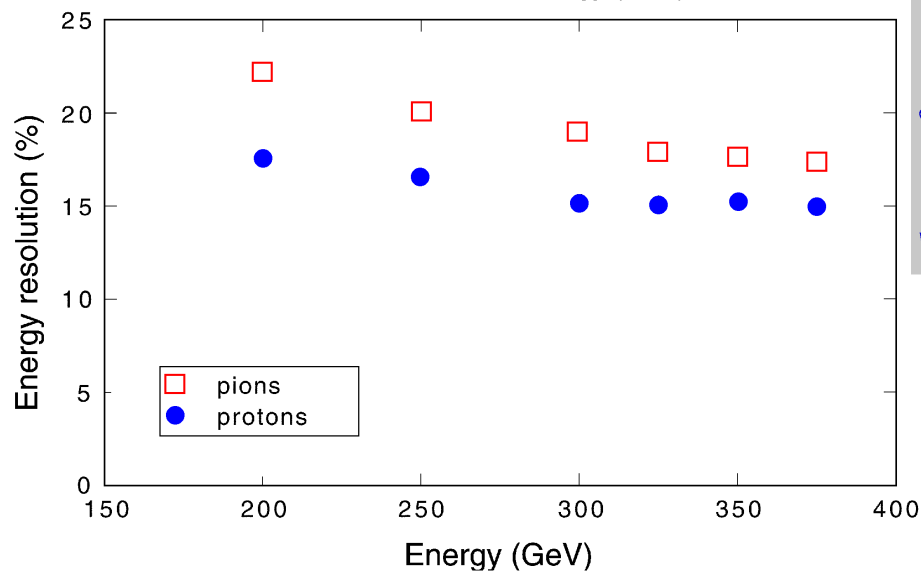

data from NIM A408 (1998) 380

Effects of incomplete shower containment

Lateral leakage fluctuations

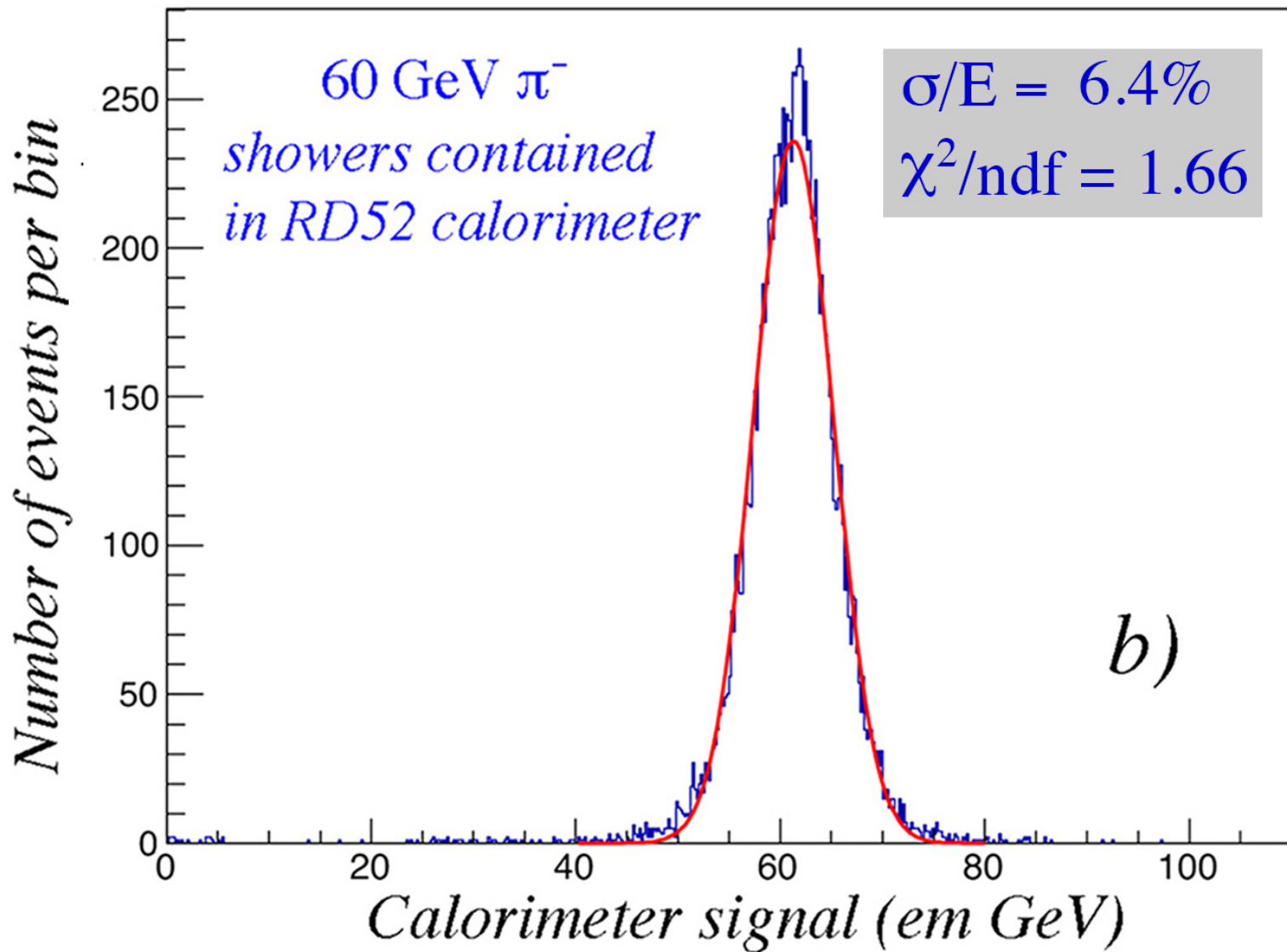

RD52 setup in H8 (October 2015)

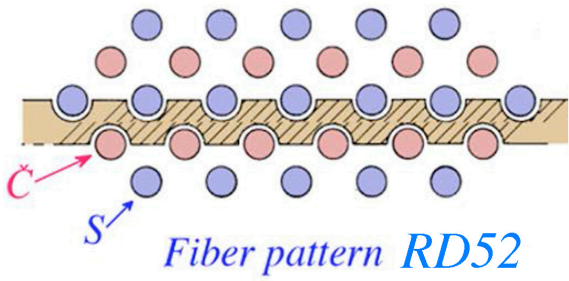
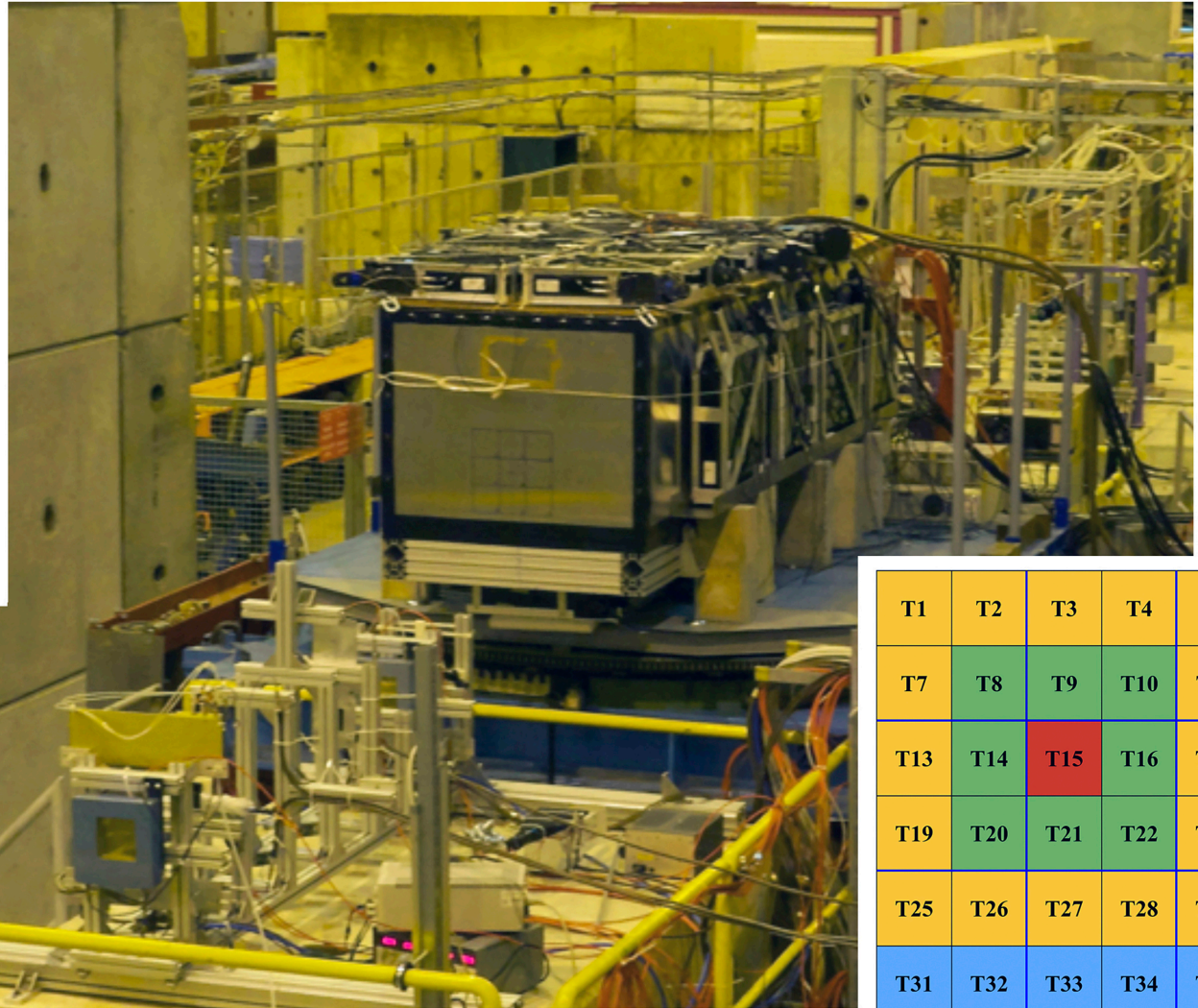
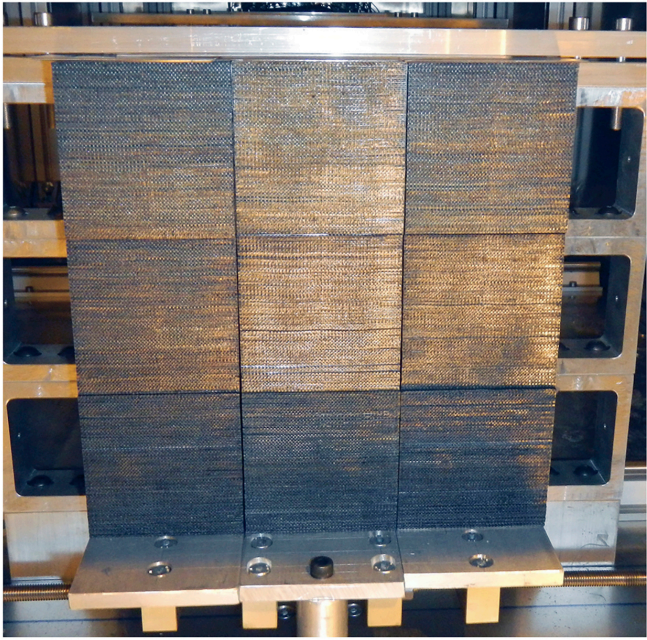

T1	T2	T3	T4	T5	T6
T7	T8	T9	T10	T11	T12
T13	T14	T15	T16	T17	T18
T19	T20	T21	T22	T23	T24
T25	T26	T27	T28	T29	T30
T31	T32	T33	T34	T35	T36

Ring 1 Ring 2 Ring 3

The leakage counter array

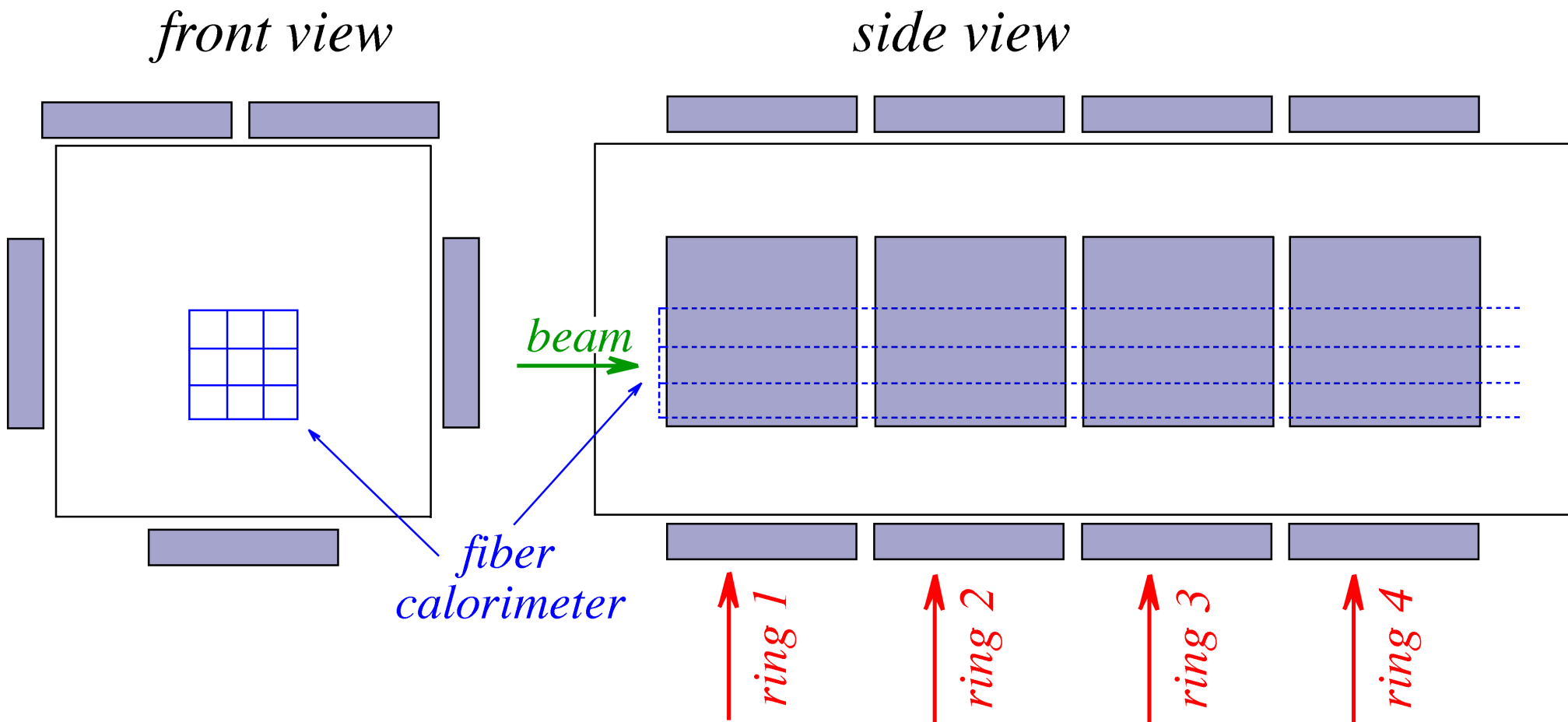

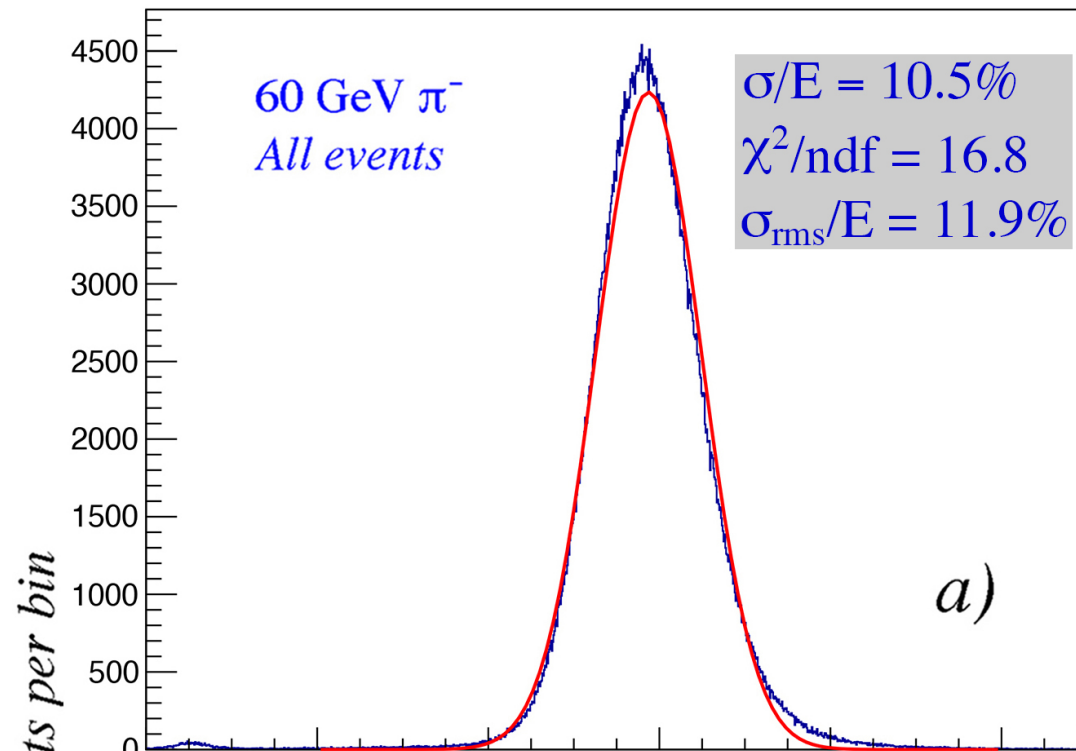

*Effects of incomplete
shower containment*

Lateral leakage fluctuations

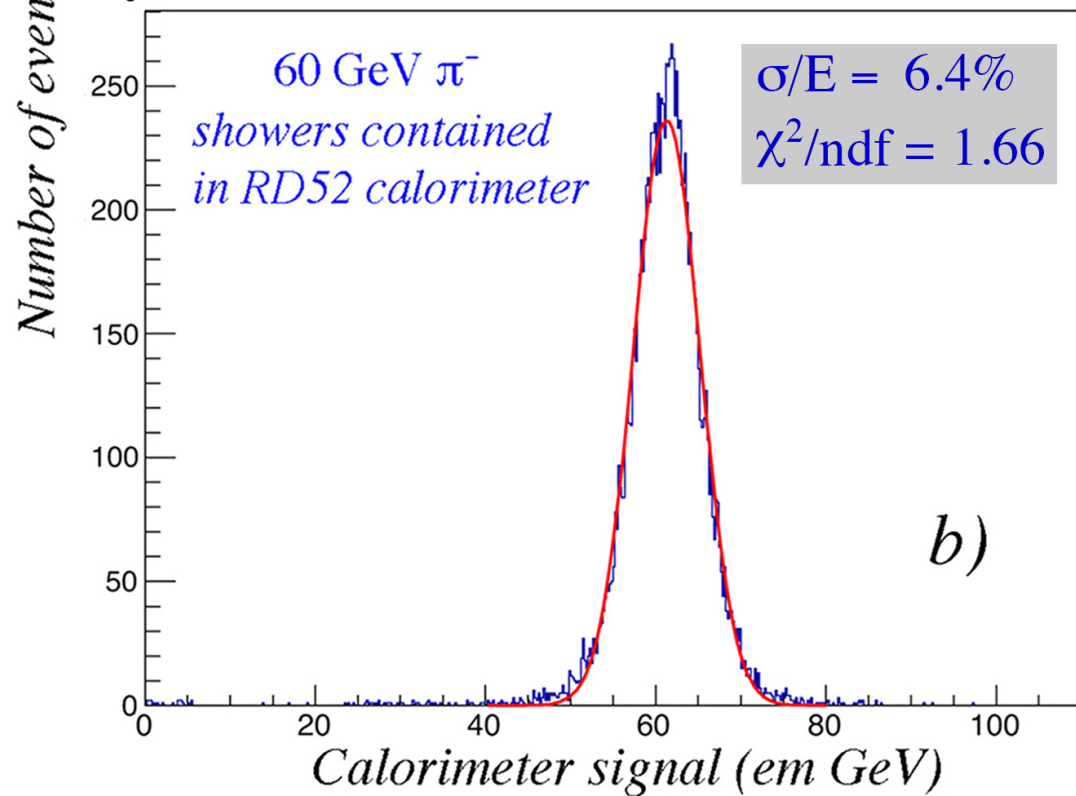

Early vs. late starting showers (effects of light attenuation in S fibers)

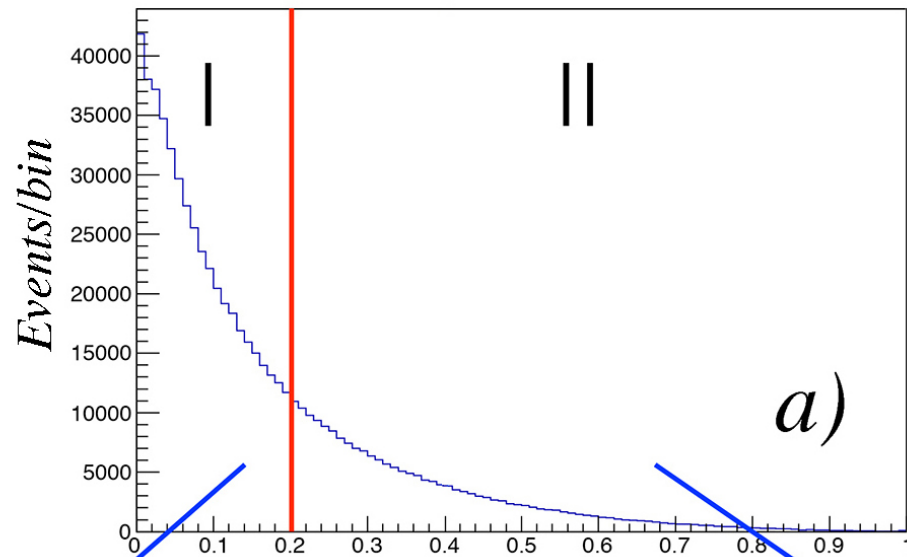

Shower starts deep
inside calorimeter

Shower starts early

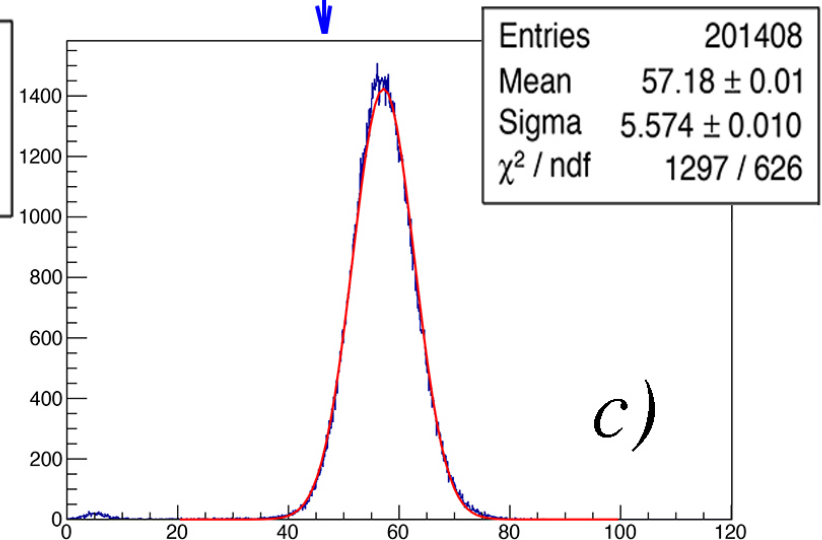
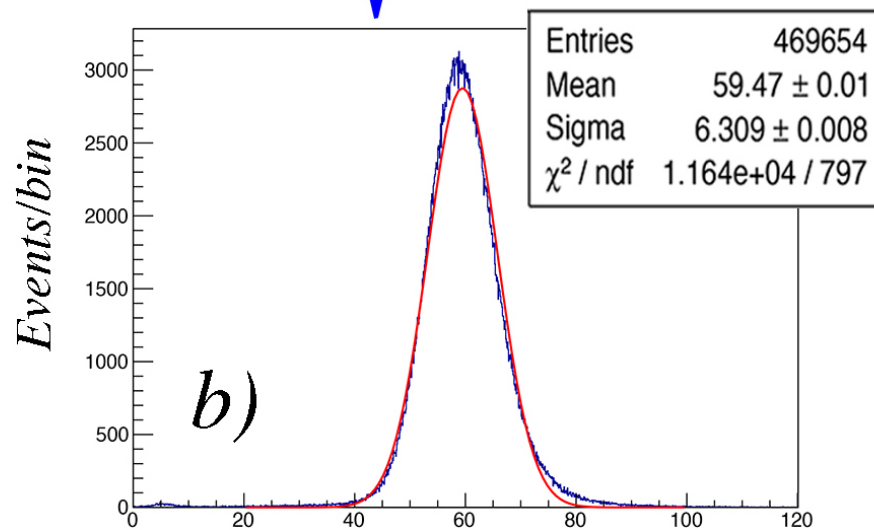

Dual-readout calorimeter signal for 60 GeV pions

Effects of leakage counters on the hadronic energy resolution

Use S+L signals

*Use $S * 1.064$*

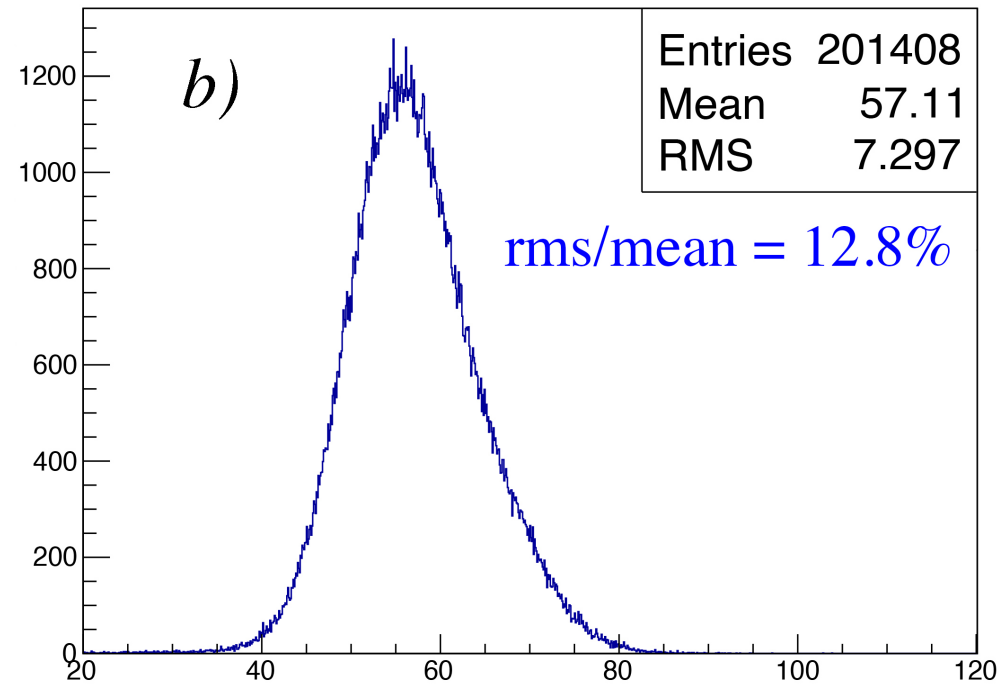
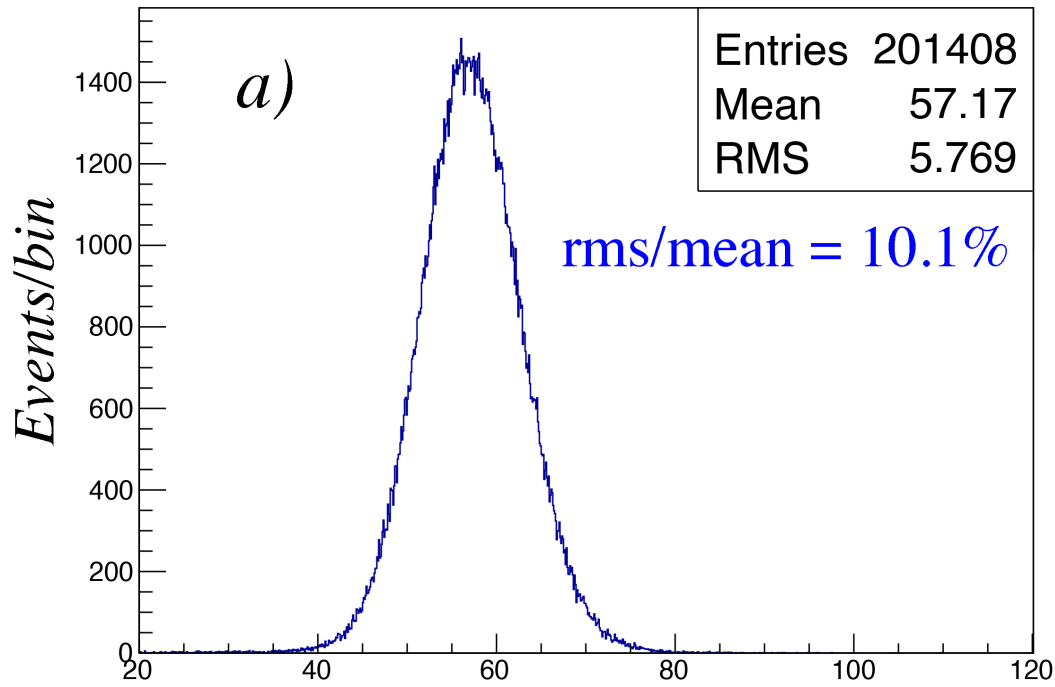

Dual-readout signal for 60 GeV pions (em GeV)

The meaning of “energy resolution”

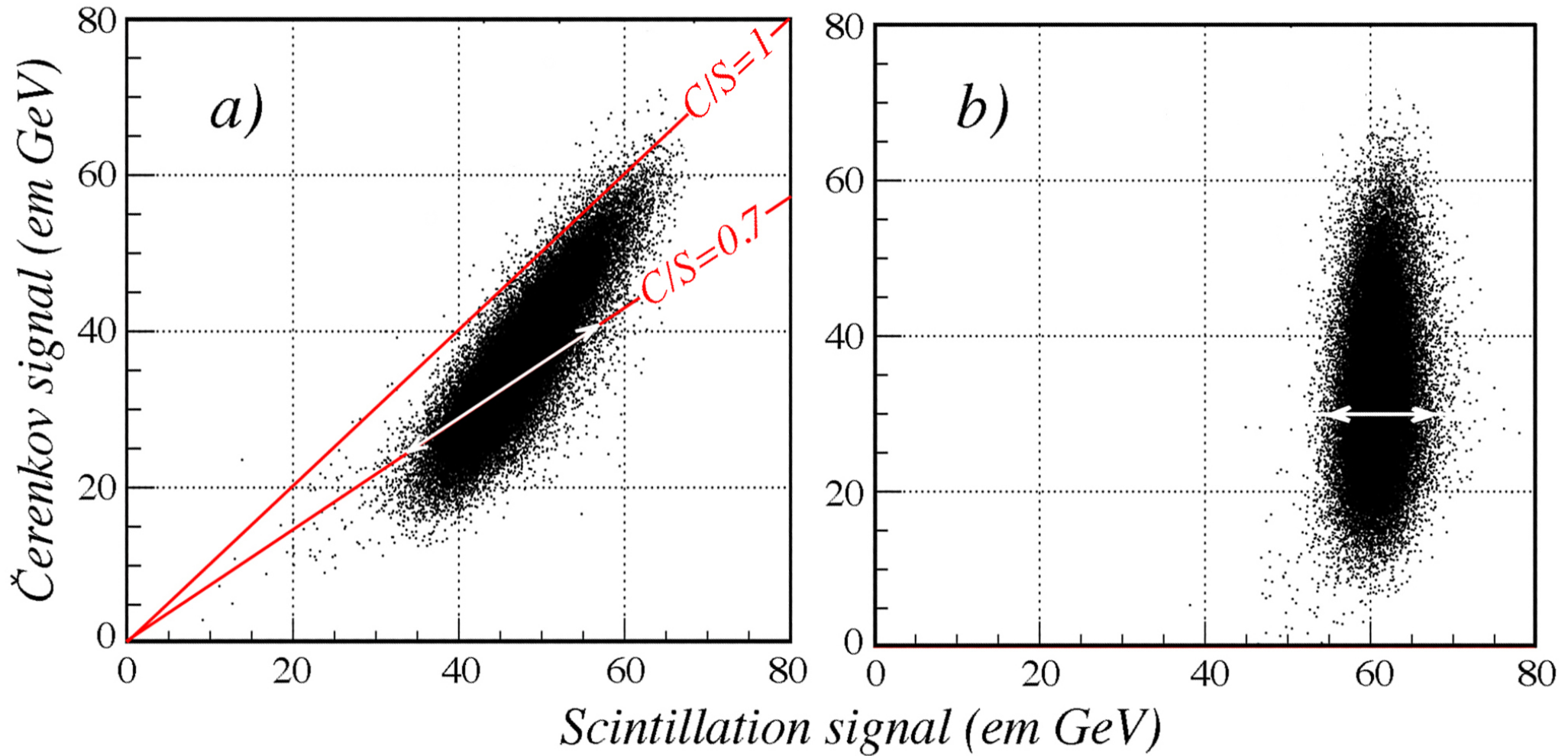

What is the meaning of “energy resolution”?

- *The precision with which the energy of an event can be determined on the basis of the signals*

In practice it is measured to be the width of the signal distribution for a collection of mono-energetic beam particles

This is what we do in the rotation method.

This is also what is done for every other calorimeter.

Other calorimeters use ADDITIONAL information.

For example:

The “offline compensation” method used in ATLAS is based on calibration constants that depend on the energy of the particles, and on the ratio of signals in different detector compartments.

These constants are also different for protons and pions.

In our analysis, we do NOT use knowledge of the particle type or energy!