

FROM RAW DATA TO PHYSICS

LECTURE 3

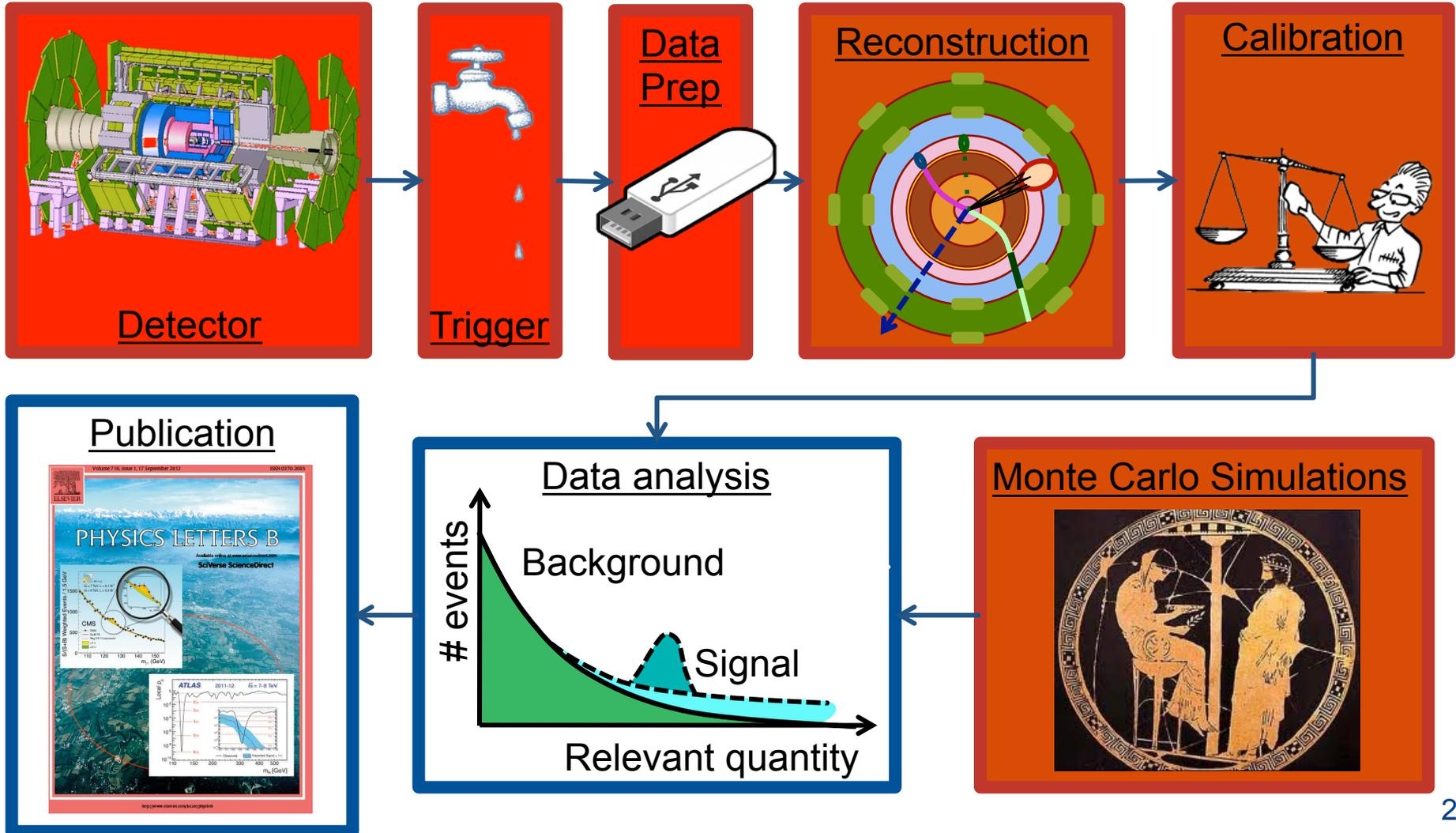

LECTURE 3



WHAT DO WE RECONSTRUCT

Simplified Detector Transverse View

Tracks and Clusters

Combining those:
“objects”
 (“particles”)

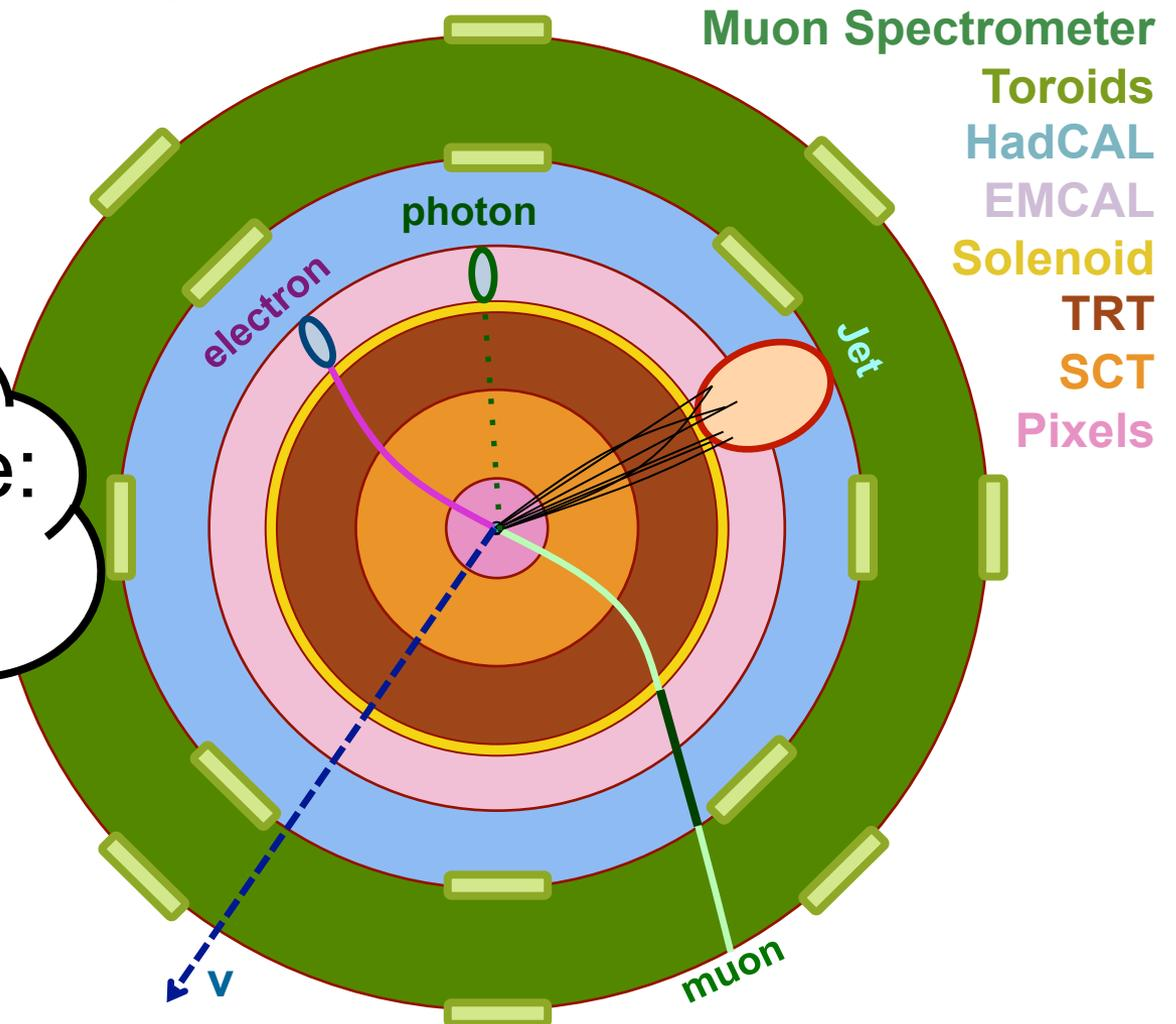

	I	II	III	
Quarks	2.4 MeV u	1.3 GeV c	170 GeV t	0 γ
	4.8 MeV d	104 MeV s	4.2 GeV b	0 g
	< 2 eV ν_1	< 2 eV ν_2	< 2 eV ν_3	91 GeV Z
Leptons	0.5 MeV e	16 MeV μ	1.8 GeV τ	80 GeV W
				126 GeV H
				Bosons

RECONSTRUCTING PARTICLES

	I	II	III	
Quarks	2.4 MeV u	1.3 GeV c	170 GeV t	0 Υ
	4.8 MeV d	104 MeV s	4.2 GeV b	0 g
	<2 eV ν_e	<2 eV ν_μ	<2 eV ν_τ	91 GeV Z
Leptons	0.5 MeV e	16 MeV μ	1.8 GeV τ	80 GeV W
				126 GeV H

Bosons

Simplified Detector Transverse View

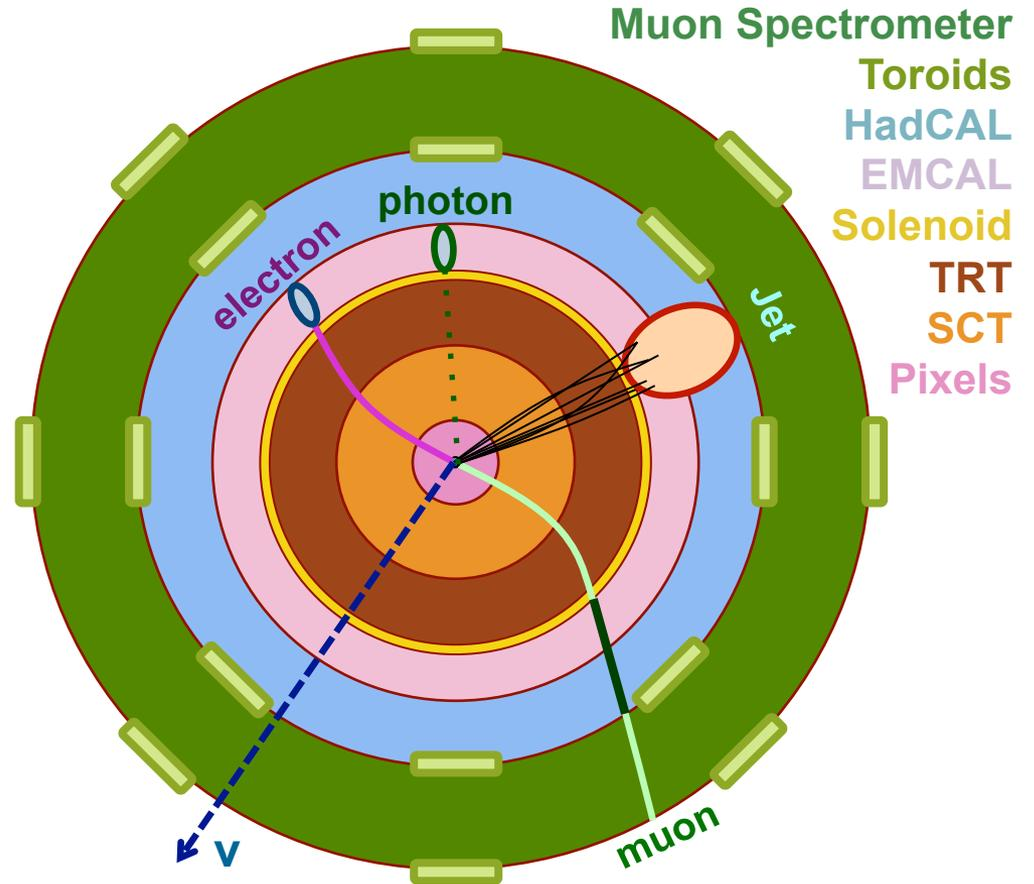

TAUS

Tau Decay Mode			B.R.
Leptonic		$\tau^\pm \rightarrow e^\pm + \nu + \nu$	17.8%
		$\tau^\pm \rightarrow \mu^\pm + \nu + \nu$	17.4%
Hadronic	1-prong	$\tau^\pm \rightarrow \pi^\pm + \nu$	11%
		$\tau^\pm \rightarrow \pi^\pm + \nu + n\pi^0$	35%
	3-prong	$\tau^\pm \rightarrow 3\pi^\pm + \nu$	9%
		$\tau^\pm \rightarrow 3\pi^\pm + \nu + n\pi^0$	5%
Other		~5%	

- © Hadronic tau reconstruction extremely challenging.
- © Using **multi-variate** techniques based on track multiplicity and shower shapes.

A tau jet (signal)...

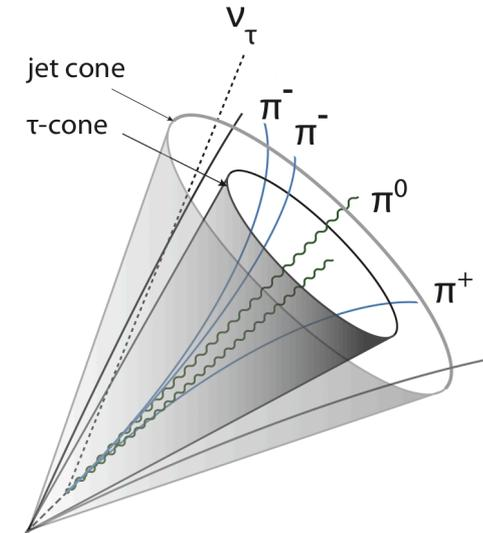

...vs. a QCD jet (background)

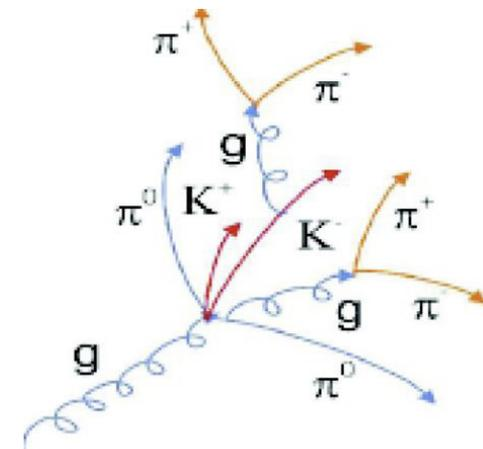

t, W, Z

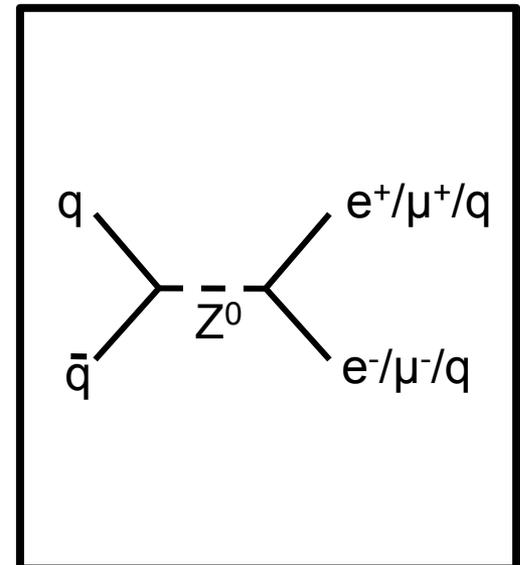
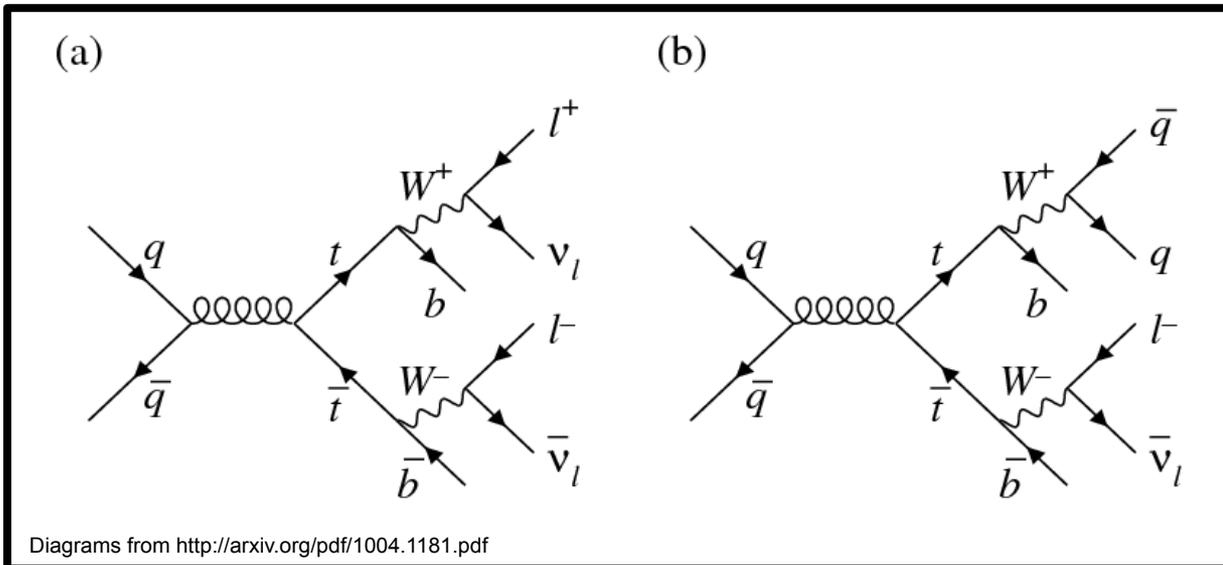
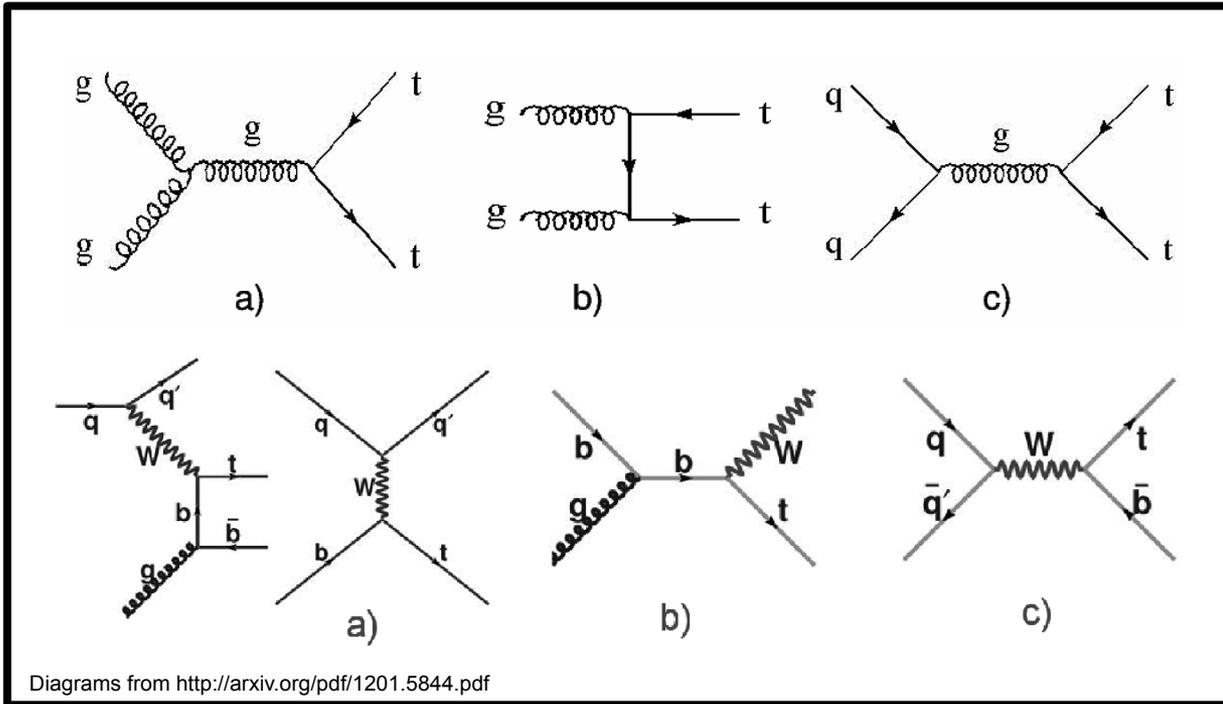

AND THE HIGGS!

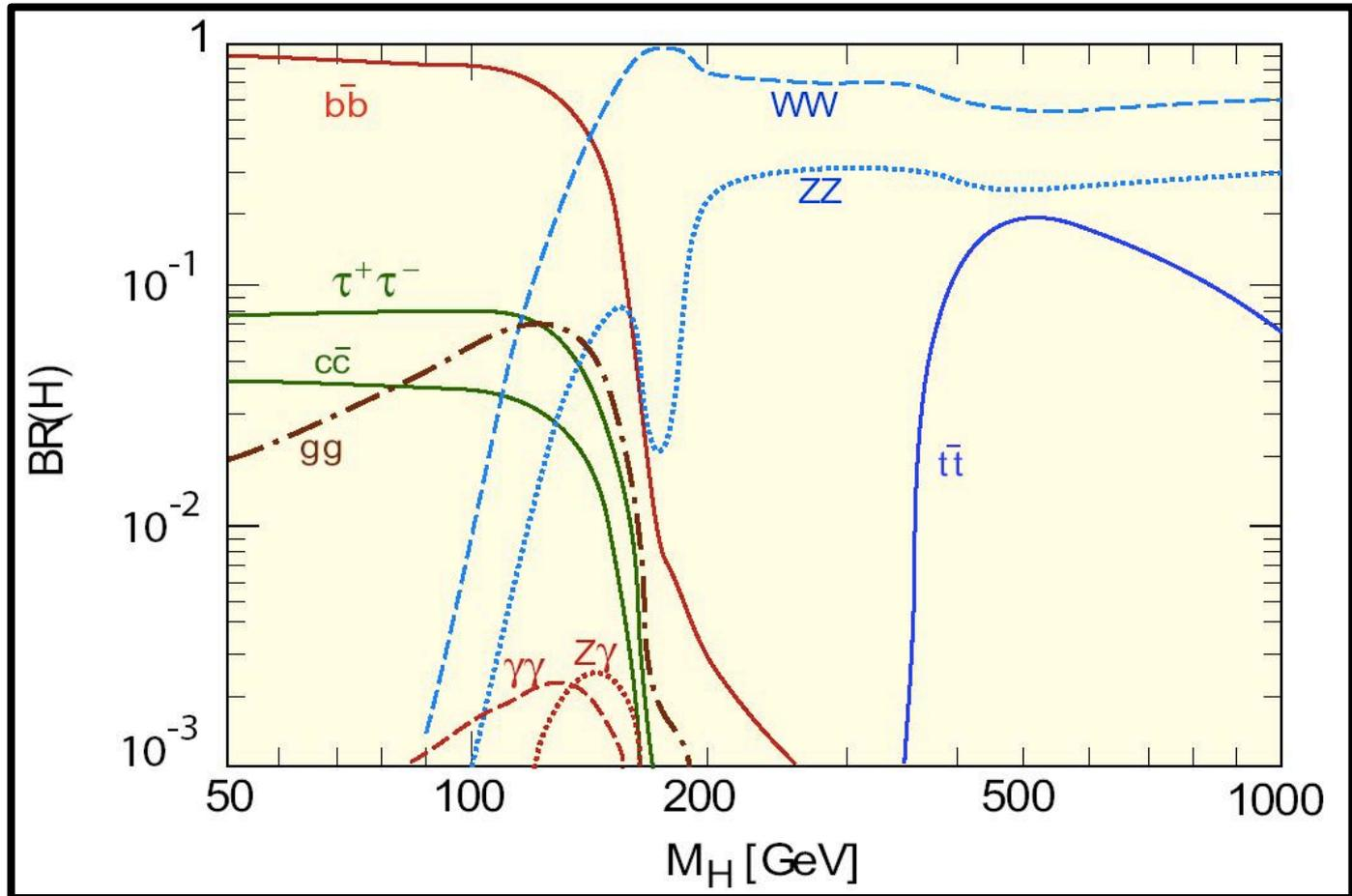

LECTURE 3

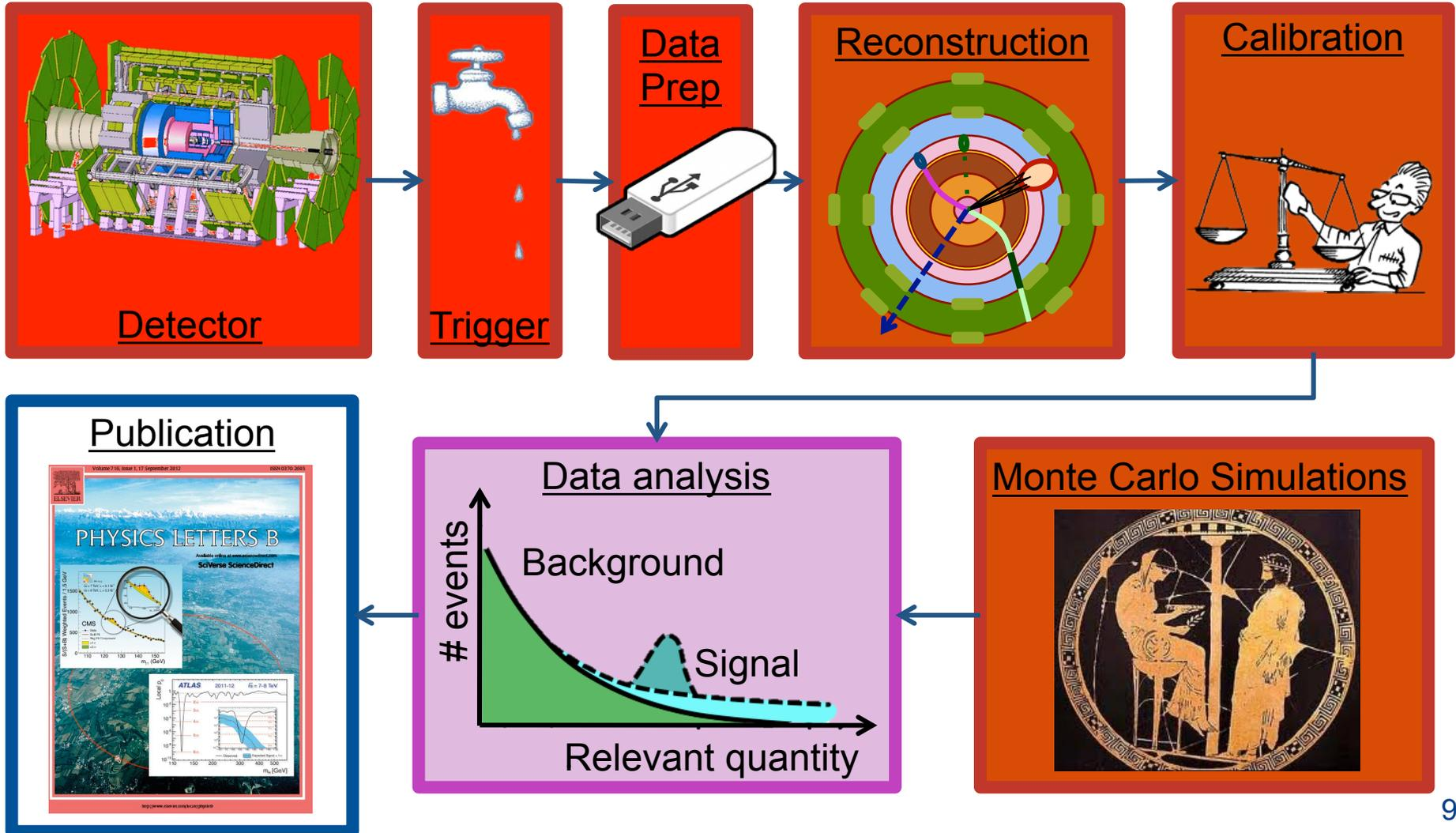

PHYSICS ANALYSES

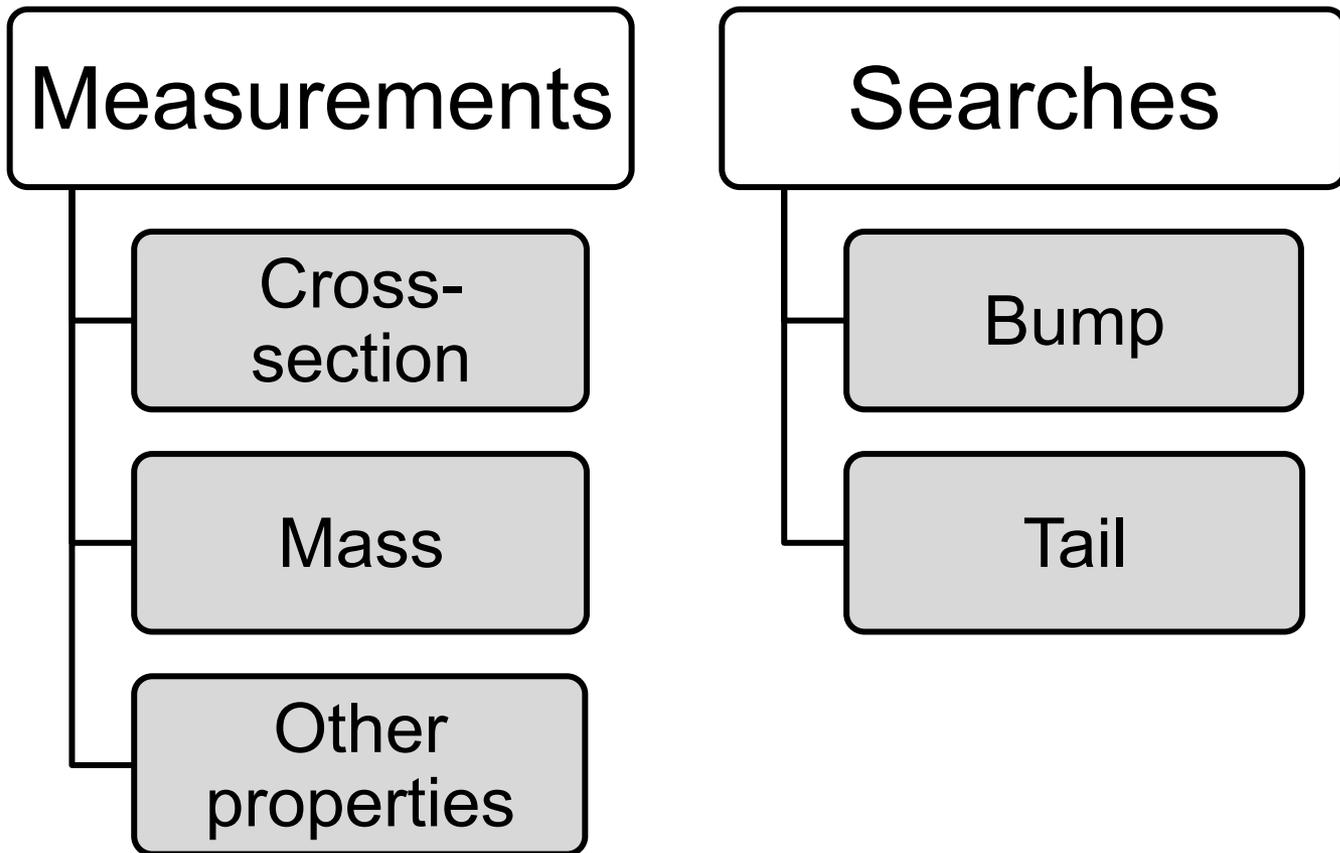

PHYSICS ANALYSES

Measurements

- ◎ Allow important tests of the consistency of the theory.
- ◎ Typically limited by systematic uncertainties.

Searches

- ◎ ... For new particles.
- ◎ If no signal, set limits on some model.
- ◎ If signal, a potential discovery!
- ◎ More data typically improve a search.

PHYSICS ANALYSES

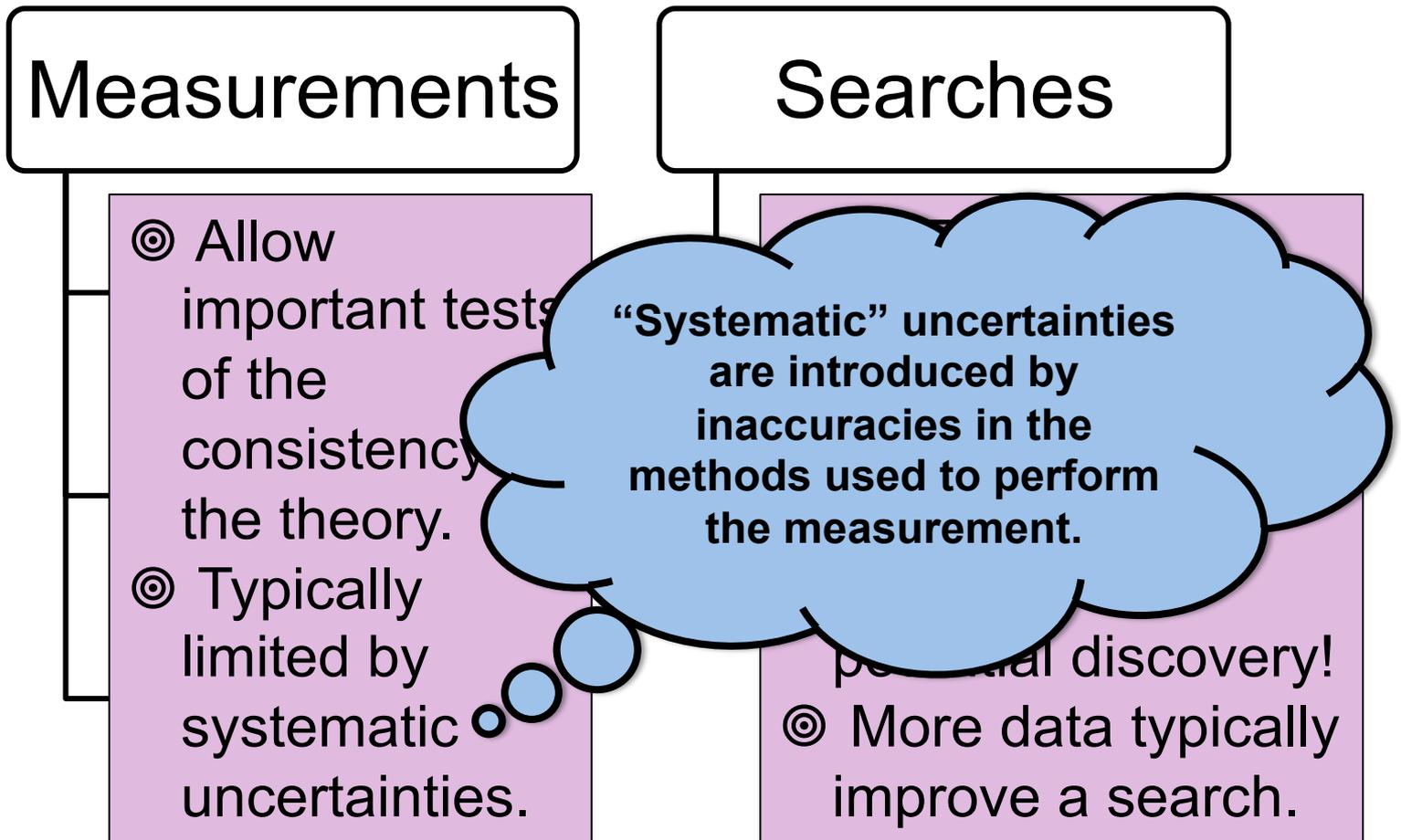

PHYSICS ANALYSES

Measurements

- ◎ Allow important tests of the consistency of the theory.
- ◎ Typically limited by systematic uncertainties.

Searches

- ◎ ... For new particles.
- ◎ If no signal, set limits on some model.
- ◎ If signal, a potential discovery!
- ◎ More data typically improve a search.

SIMPLE EXAMPLE:

**MEASURING Z^0 CROSS-SECTION
AT LHC**

MEASURING Z^0 CROSS-SECTION AT LHC

© Z^0 boson decays to lepton or quark pairs

© We can reconstruct it in the e^+e^- or $\mu^+\mu^-$ decay modes

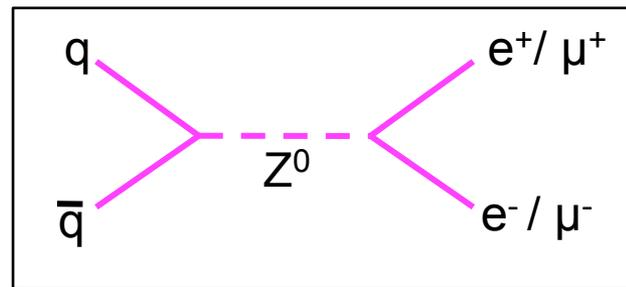

© Discovery and study of the Z^0 boson was a critical part understanding the electroweak force.



© And now, at the LHC?

© **Important test of theory:** does the measurement agree with the theoretical prediction at LHC collision energy?

© **A standard candle** for studying reconstruction and deriving calibrations.

© Can be used for luminosity determination!

MEASURING Z^0 CROSS-SECTION AT LHC



Run Number: 154817, Event Number: 968871
Date: 2010-05-09 09:41:40 CEST

$M_{ee} = 89 \text{ GeV}$

$Z \rightarrow ee$ candidate in 7 TeV collisions

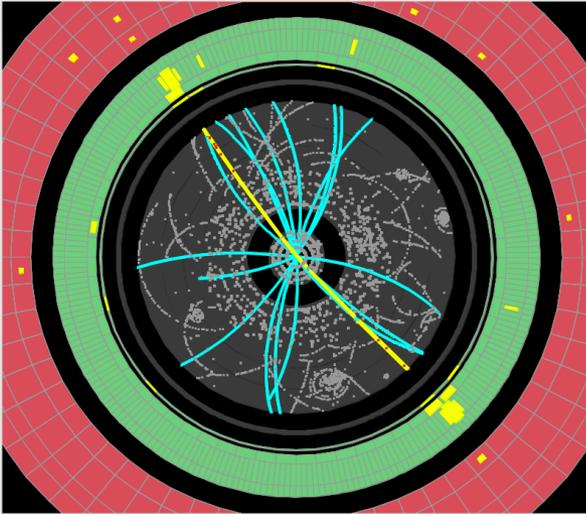
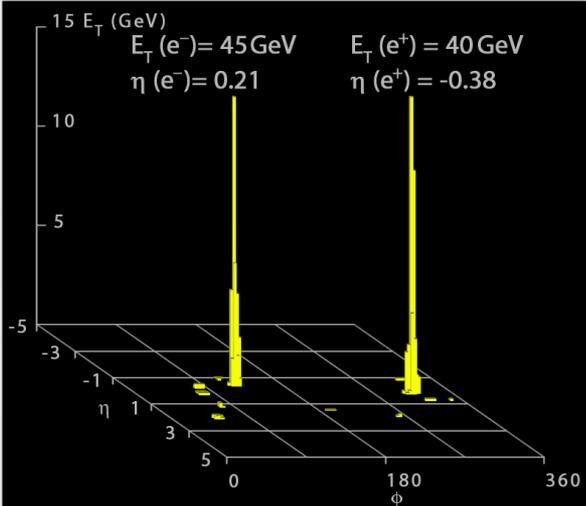
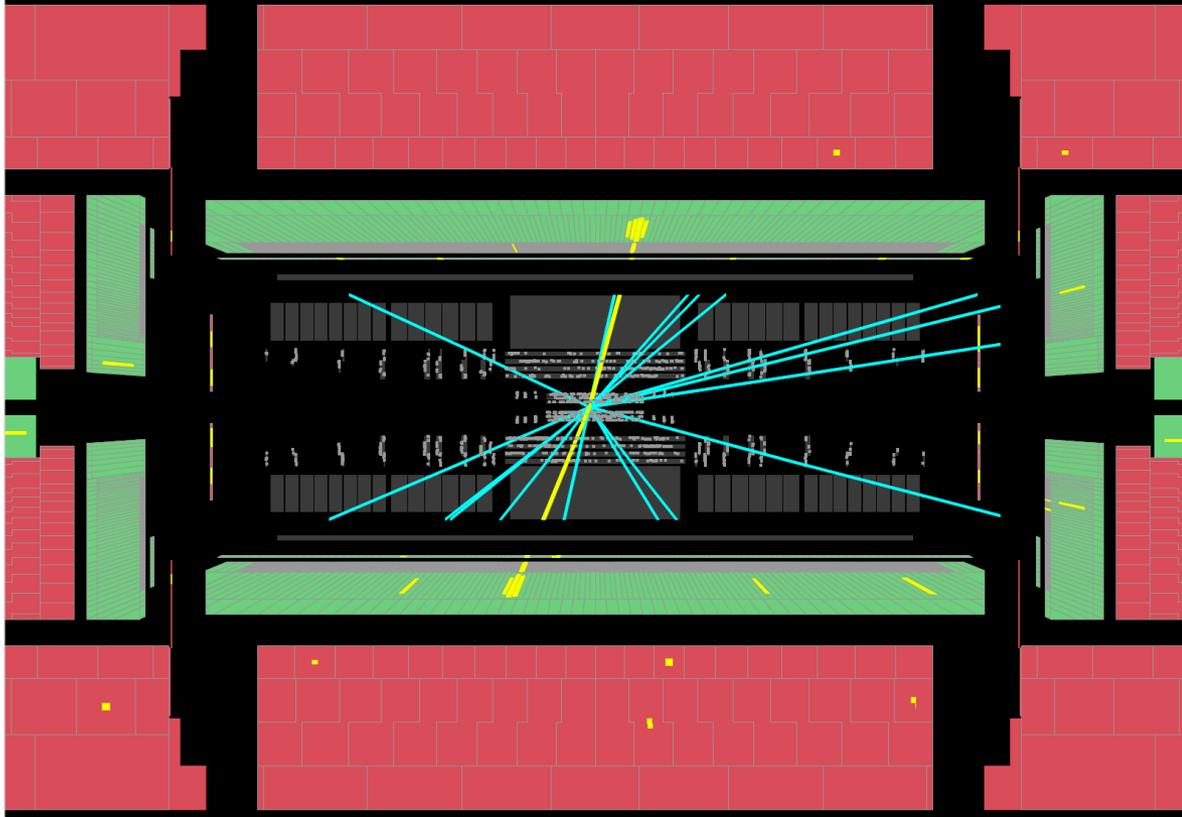

MEASURING Z^0 CROSS-SECTION AT LHC



CMS Experiment at LHC, CERN
Run 136087 Event 39967482
Lumi section: 314
Mon May 24 2010, 15:31:58 CEST

Muon $p_T = 27.3, 20.5 \text{ GeV}/c$
Inv. mass = $85.5 \text{ GeV}/c^2$

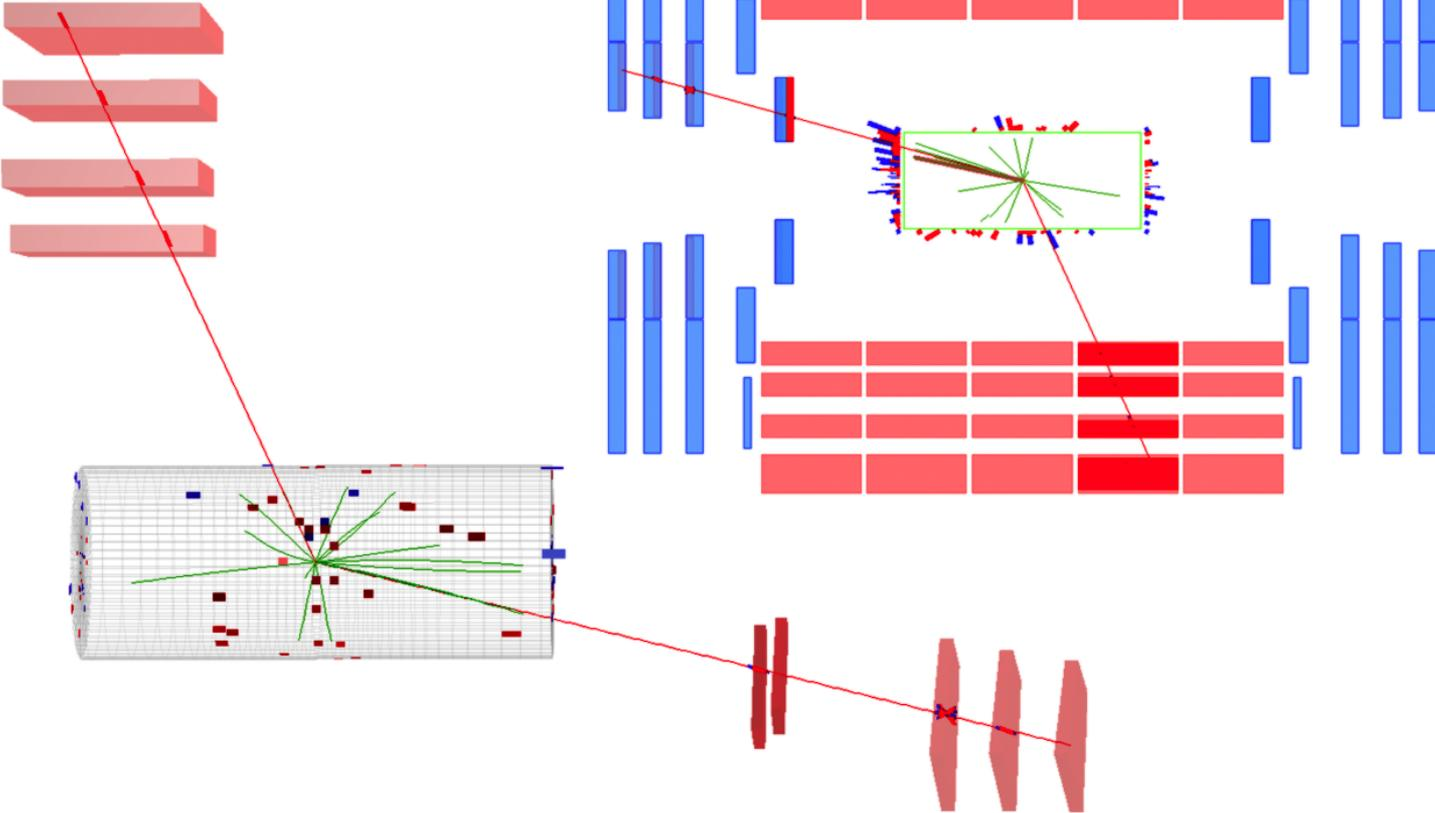

RECONSTRUCTING Z⁰'S

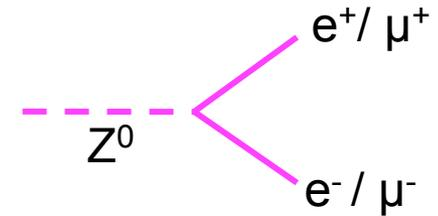

How do we know it's a Z⁰?

Identify Z decays using the invariant mass of the 2 leptons

$$M^2 = (L_1 + L_2)^2 \quad \text{where } L_i = (E_i, \mathbf{p}_i) = 4\text{-vector for lepton } i$$

Under assumption that lepton is massless compared to mass of Z⁰

$$\Rightarrow M^2 = 2 E_1 E_2 (1 - \cos\vartheta_{12}) \quad \text{where } \vartheta_{12} = \text{angle between the leptons}$$

⊙ So need to reconstruct the electron and muon energy and direction. Then can calculate the mass.

Select Z⁰ events with 'analysis cuts':

- ⊙ Events with 2 high momentum electrons or muons
- ⊙ Require the electrons or muons are of opposite charge
- ⊙ With di-lepton mass close to the Z⁰ mass (e.g. $70 < m_{l+l-} < 110$ GeV)

Very little background in Z⁰ mass region!

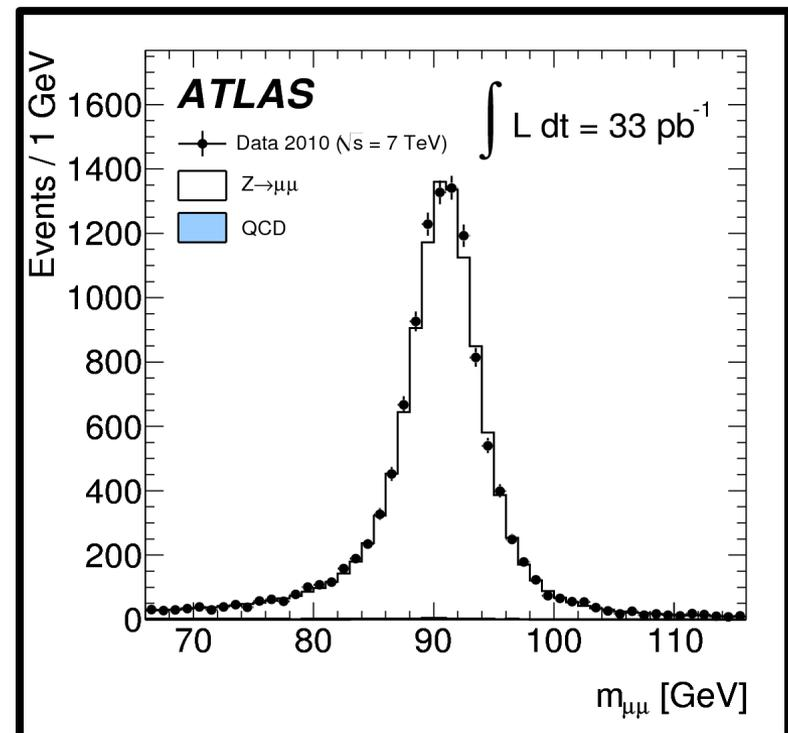

RECONSTRUCTING Z⁰'S

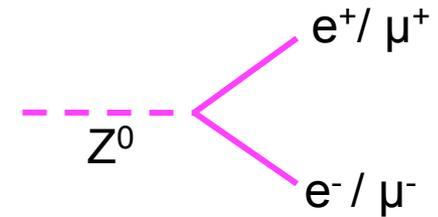

How do we know it's a Z⁰?

Identify Z decays using the invariant mass of the 2 leptons

$$M^2 = (L_1 + L_2)^2 \quad \text{where } L_i = (E_i, \mathbf{p}_i) = 4\text{-vector for lepton } i$$

Under assumption that lepton is massless compared to mass of Z⁰

$$\Rightarrow M^2 = 2 E_1 E_2 (1 - \cos\vartheta_{12}) \quad \text{where } \vartheta_{12} = \text{angle between the leptons}$$

⊙ So need to reconstruct the electron and muon energy and direction. Then can calculate the mass.

Select Z⁰ events with 'analysis cuts':

- ⊙ Events with 2 high momentum electrons or muons
- ⊙ Require the electrons or muons are of opposite charge
- ⊙ With di-lepton mass close to the Z⁰ mass (e.g. 70 < m_{l+l-} < 110 GeV)

Very little background in Z⁰ mass region!

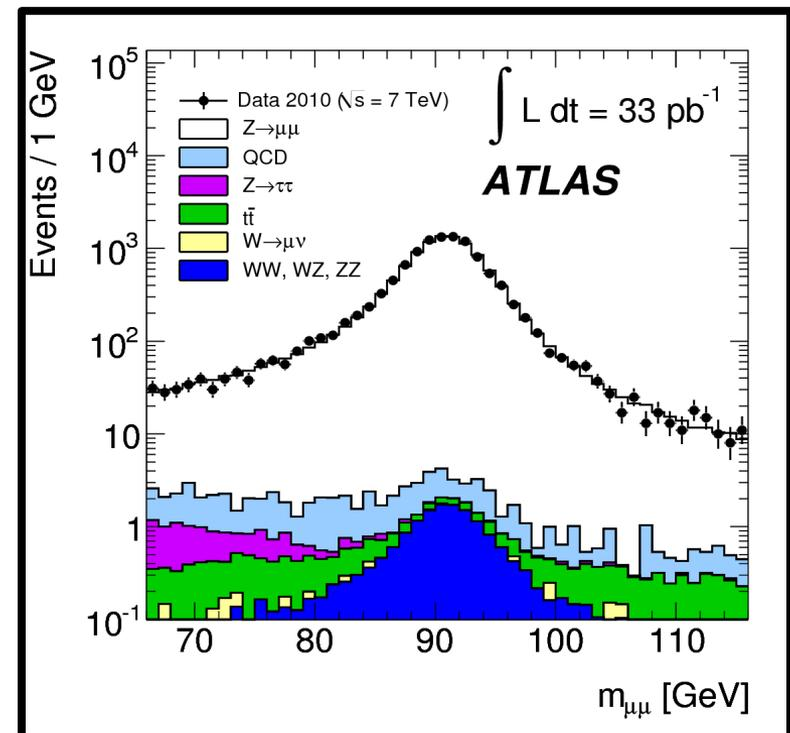

A STEP BACK IN TIME...

Z → ee in UA1

Two EM clusters with
 $E_T > 25 \text{ GeV}$.

As above plus a track with
 $p_T > 7 \text{ GeV}$ pointing to the
cluster. Hadronic and track
isolation requirements applied.

A second cluster has also an
isolated track.

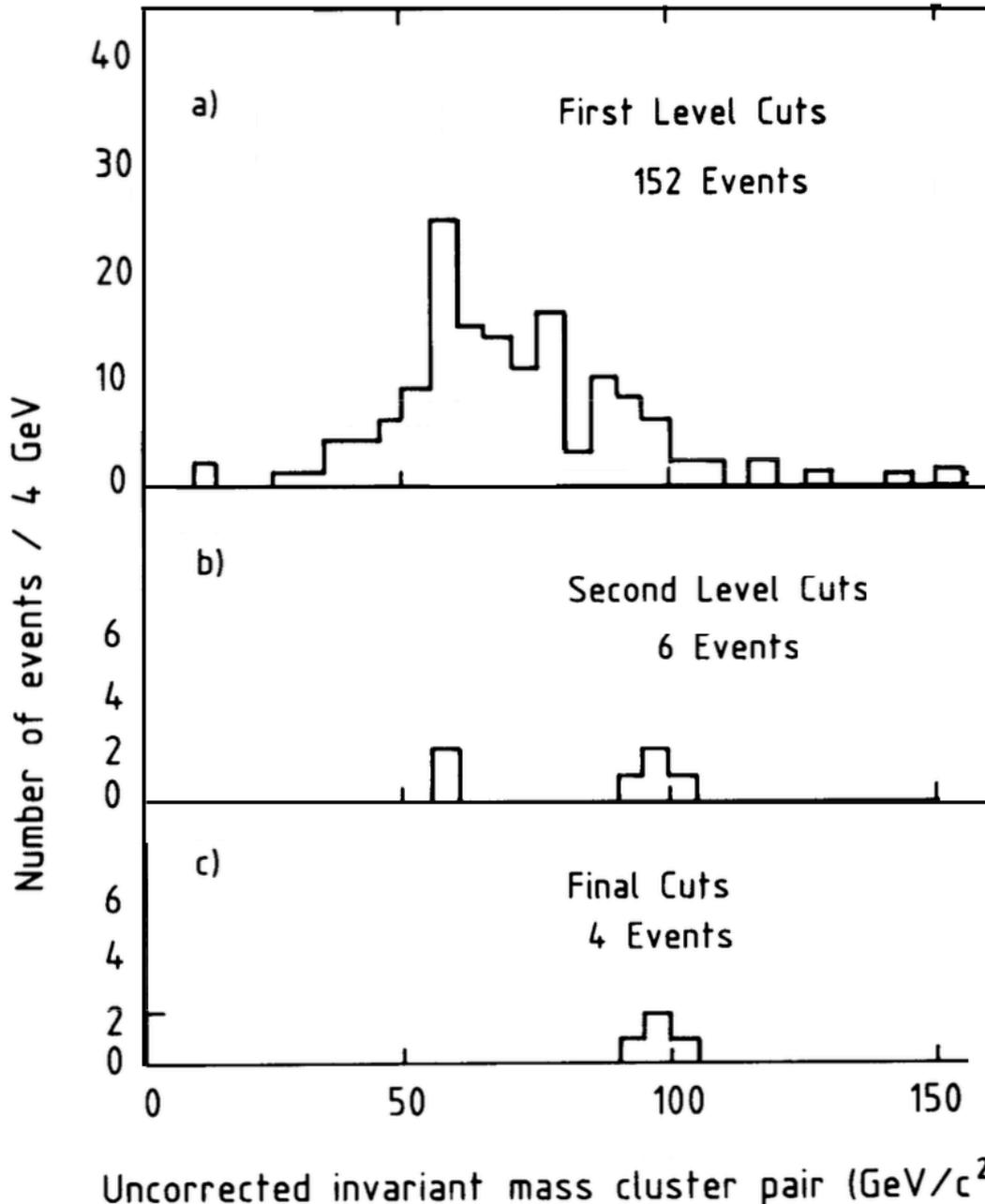

MEASURING THE Z^0 CROSS-SECTION

Theoretically

Cross-section calculated for:

- ⊙ Specific production mechanism (pp, $p\bar{p}$, e^+e^-)
- ⊙ Centre-of-Mass of the collisions (7, 8, 13 TeV at LHC)

Experimentally

$$\sigma \cdot \text{BR} = \frac{\text{Number of events}}{\alpha \cdot \epsilon \cdot L}$$

N of events:

N of events on data – N of expected background events

α – acceptance:

fraction of events passing selection requirements

ϵ – efficiency:

reconstruction efficiency of relevant objects

L – luminosity

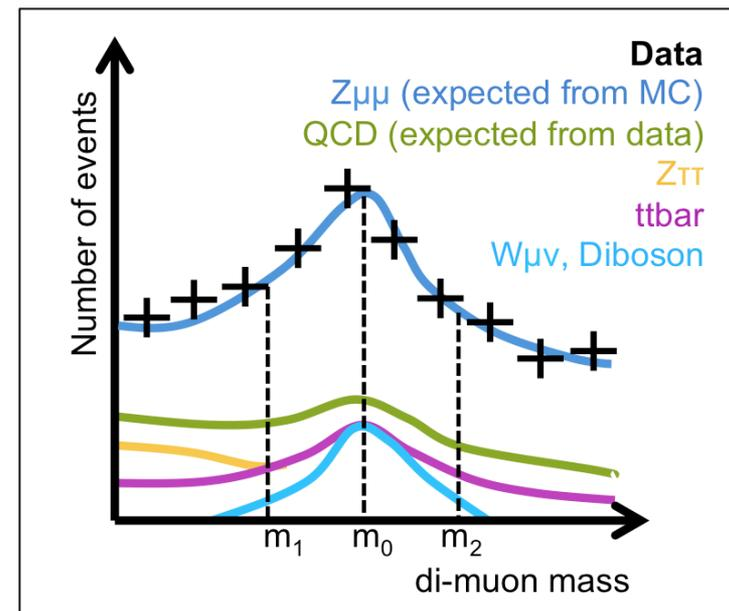
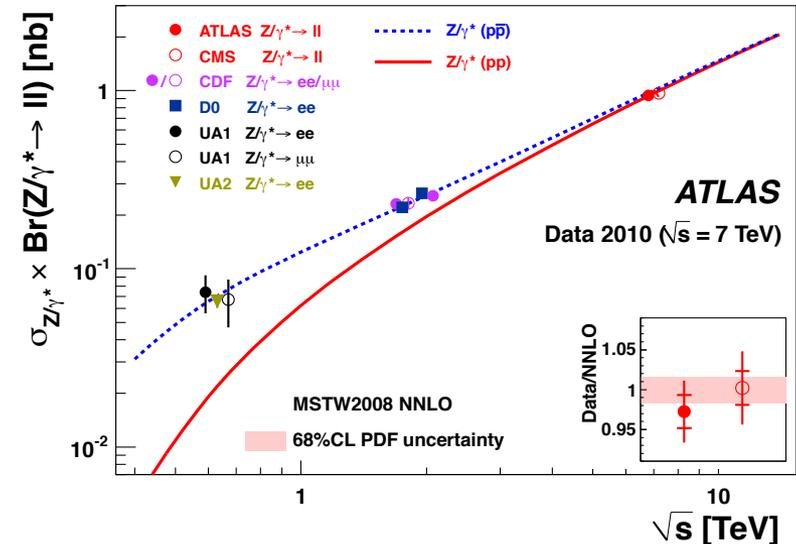

MEASURING THE Z^0 CROSS-SECTION

Theoretically

Cross-section calculated for:

- ⊙ Specific production mechanism (pp, $p\bar{p}$, e^+e^-)
- ⊙ Centre-of-Mass of the collisions (7, 8, 13 TeV at LHC)

Experimentally

$$\sigma \cdot BR = \frac{\text{Number of events}}{\alpha \cdot \epsilon \cdot L}$$

N of events:

N of events on data – N

α – acceptance:

fraction of events passing

ϵ – efficiency:

reconstruction efficiency

L – luminosity

All numbers carry uncertainties – both “statistical” and “systematic”!

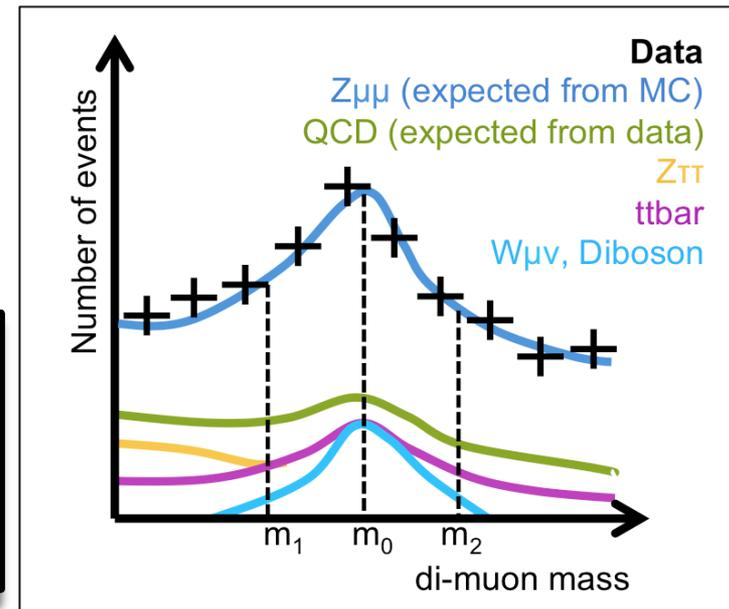
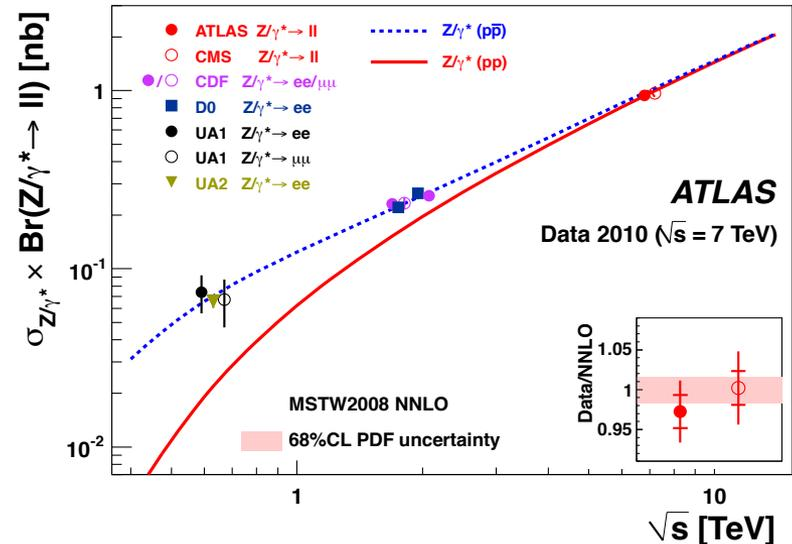

MEASURING THE Z^0 CROSS-SECTION

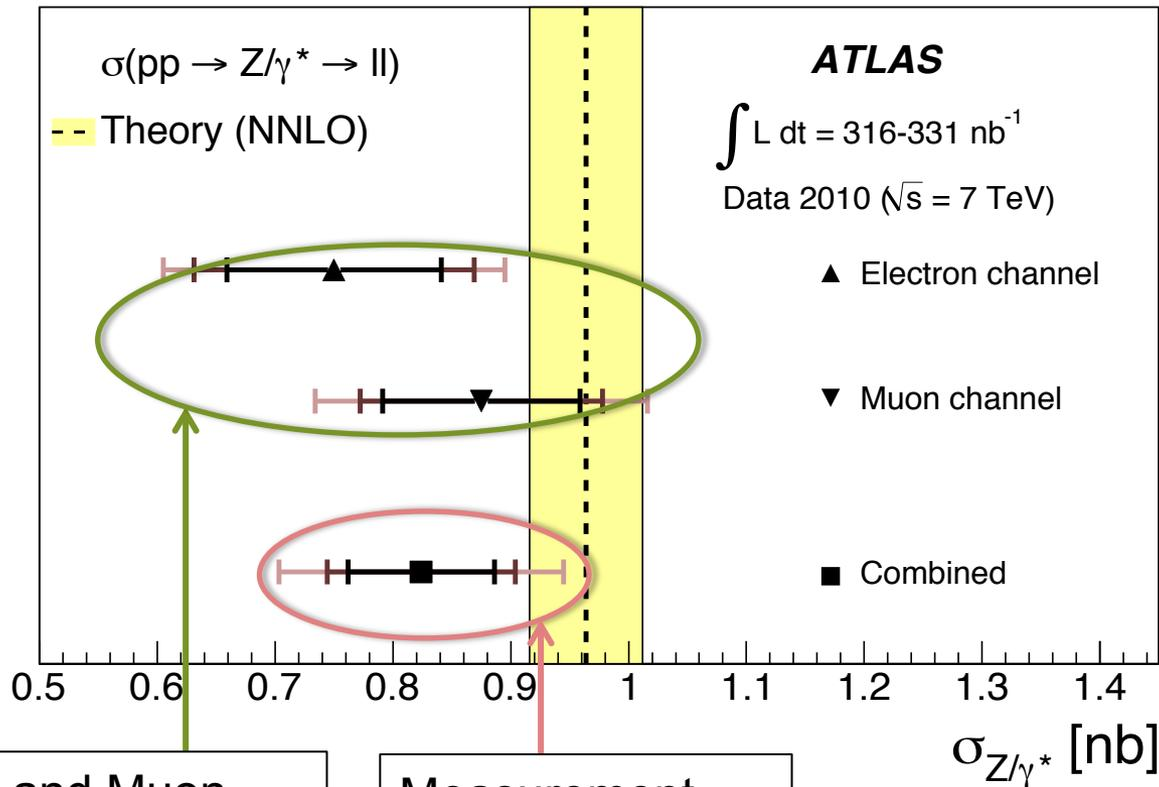

Electron and Muon channel agree within uncertainties

Measurement consistent with prediction within uncertainties

MEASURING THE W CROSS-SECTION

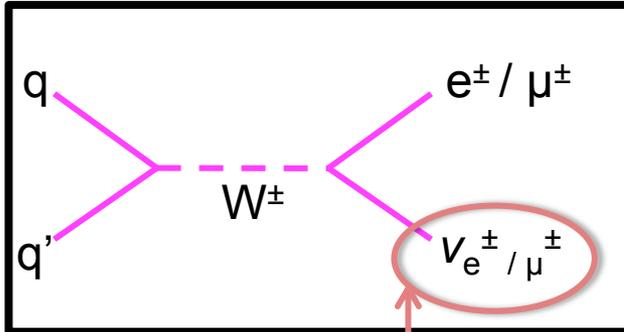

Available in the transverse plane only!

$$M_T^2 = 2 E_{T1} E_{T2} (1 - \cos\theta_{12})$$

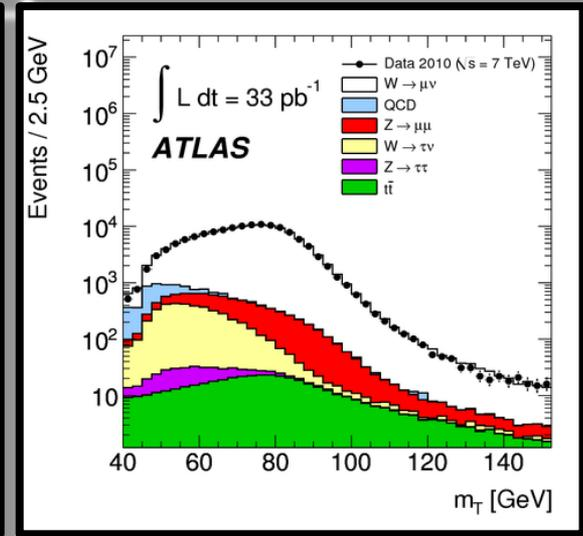
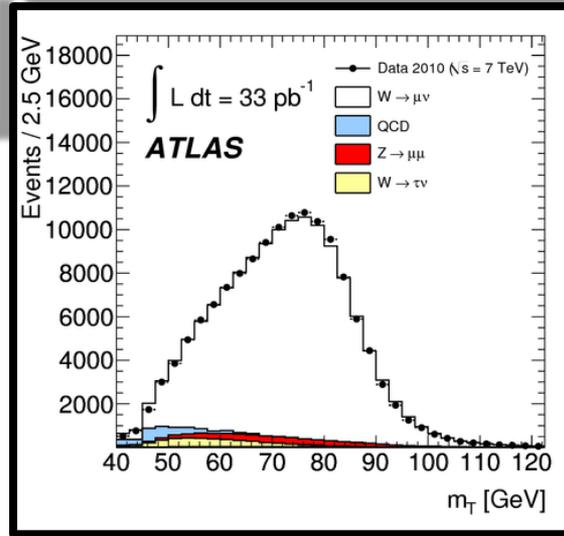
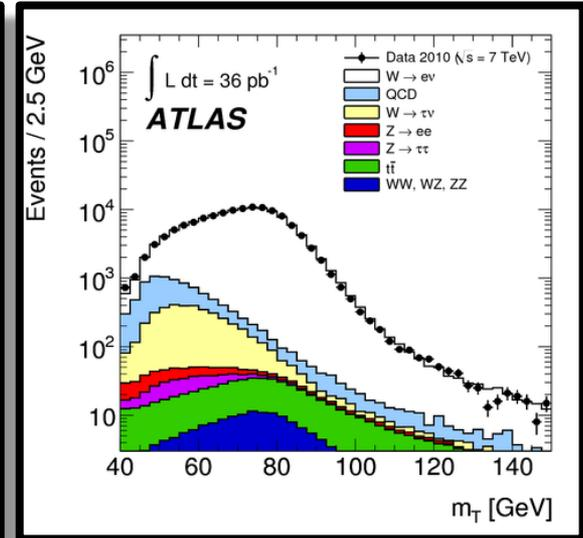
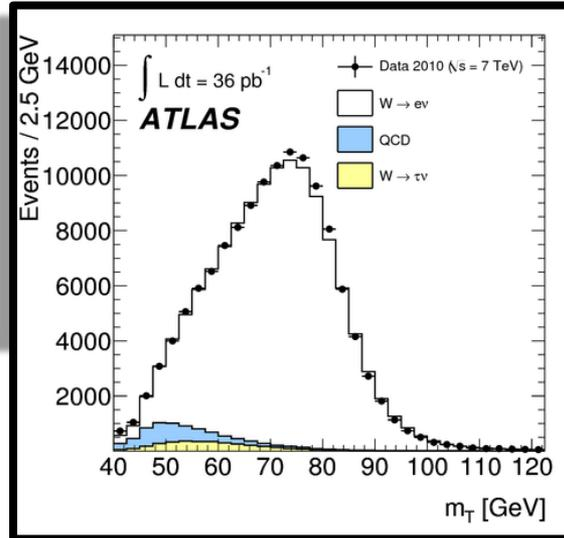

MEASURING THE W CROSS-SECTION

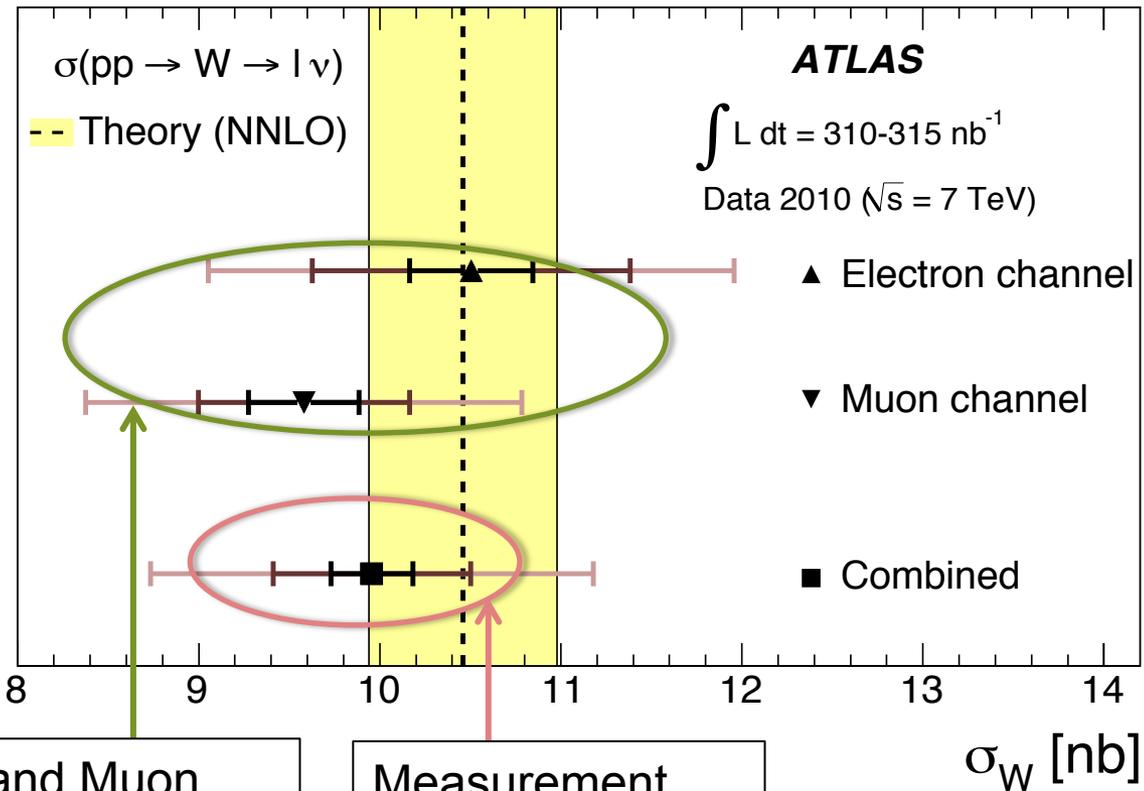

Electron and Muon channel agree within uncertainties

Measurement consistent with prediction within uncertainties

“FINAL” CALIBRATION



Standard Model Total Production Cross Section Measurements

Status: March 2015

$\int \mathcal{L} dt$
[fb⁻¹]

Reference

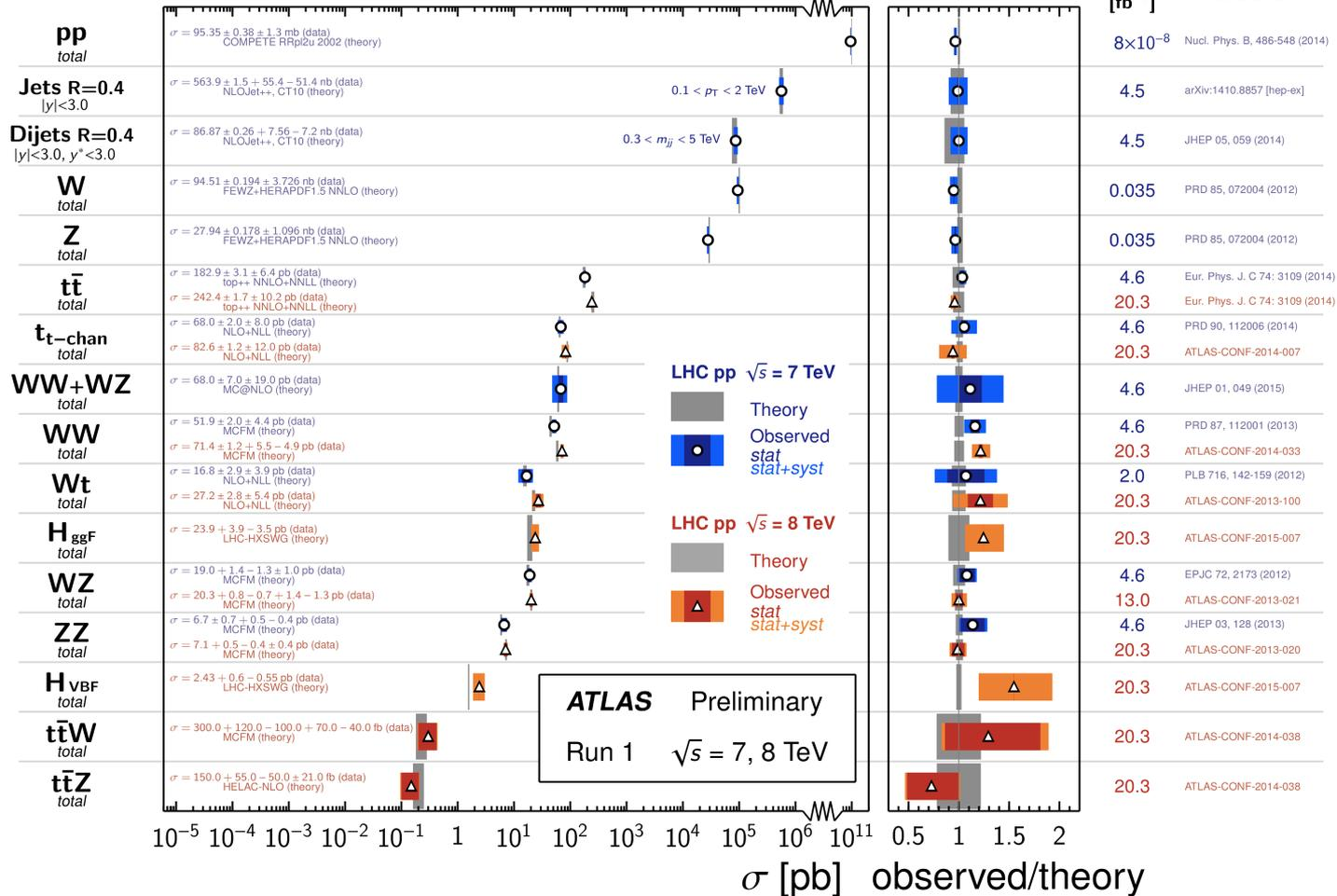

MEASURING CROSS-SECTION RATIOS

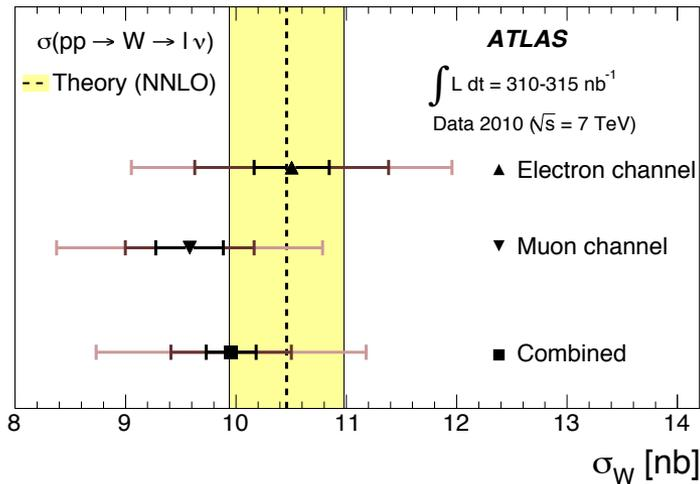
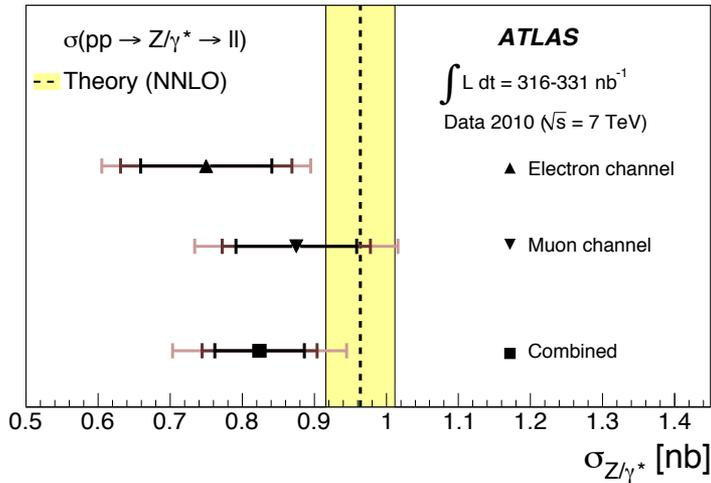

$\sigma_{W^\pm}^{\text{tot}} \cdot \text{BR}(W^\pm \rightarrow l\nu) [\text{nb}]$

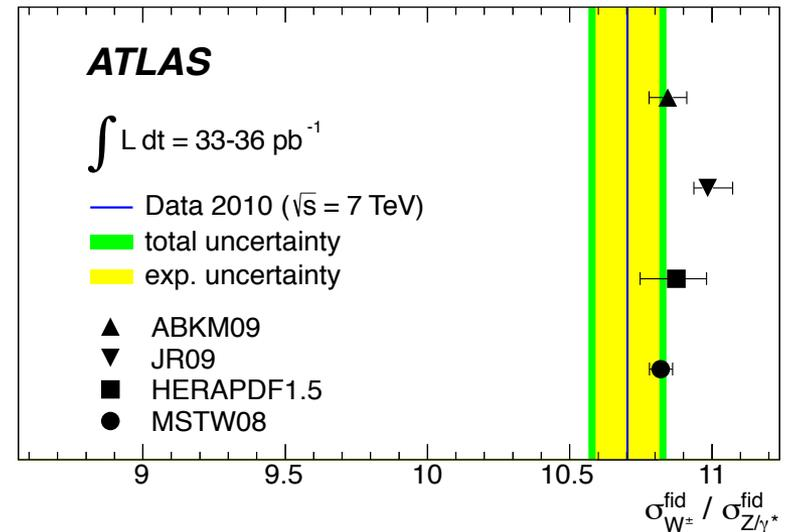
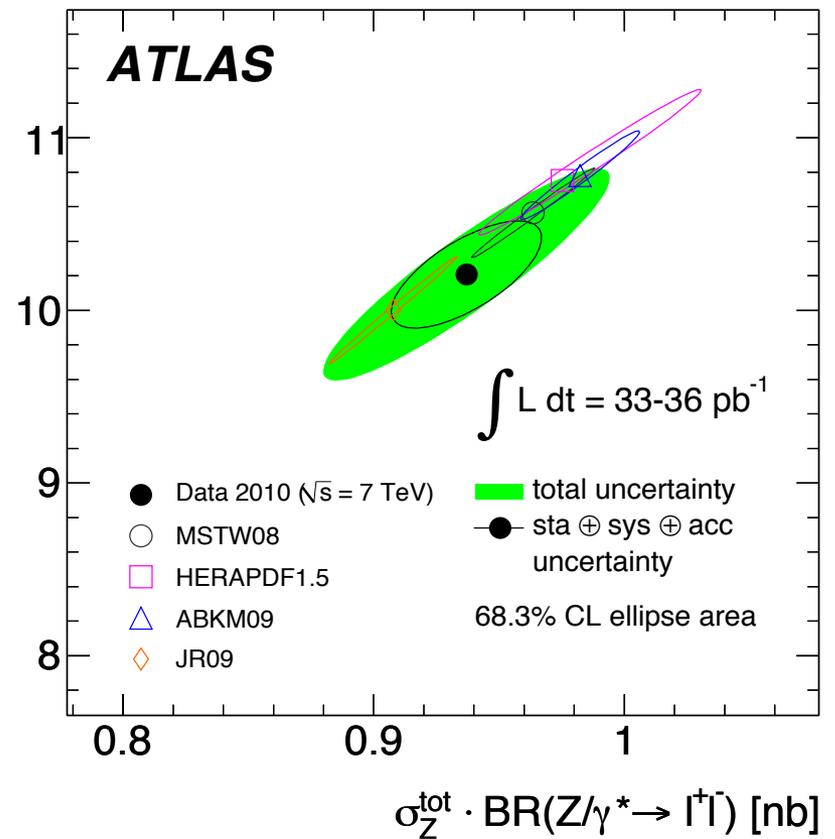

MEASURING CROSS-SECTION RATIOS

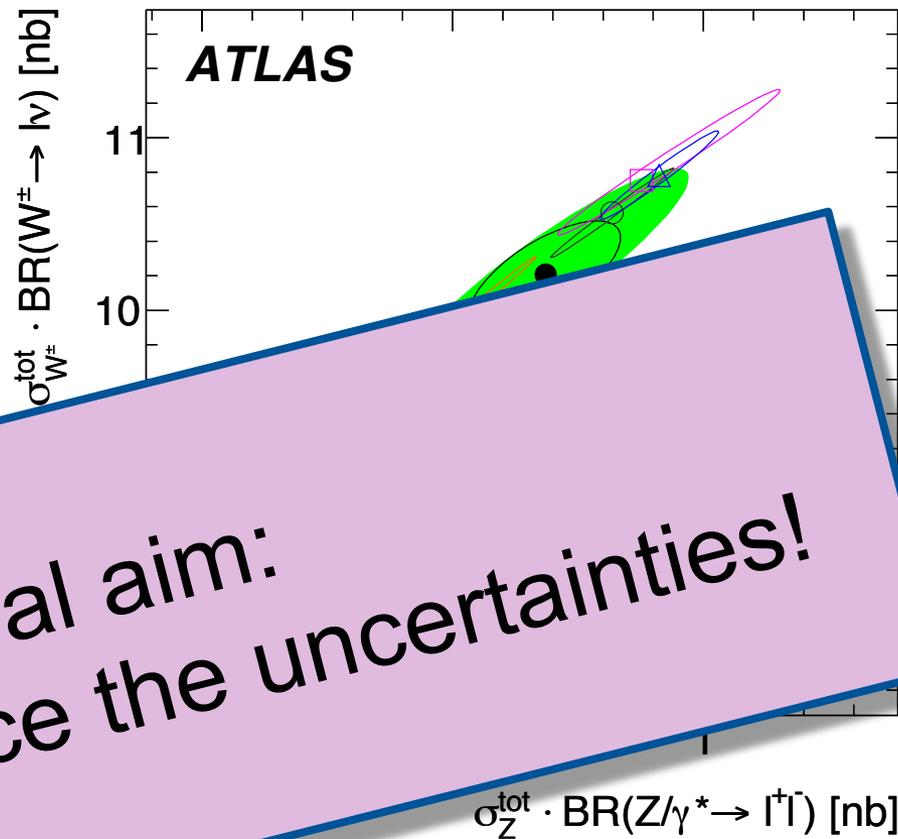
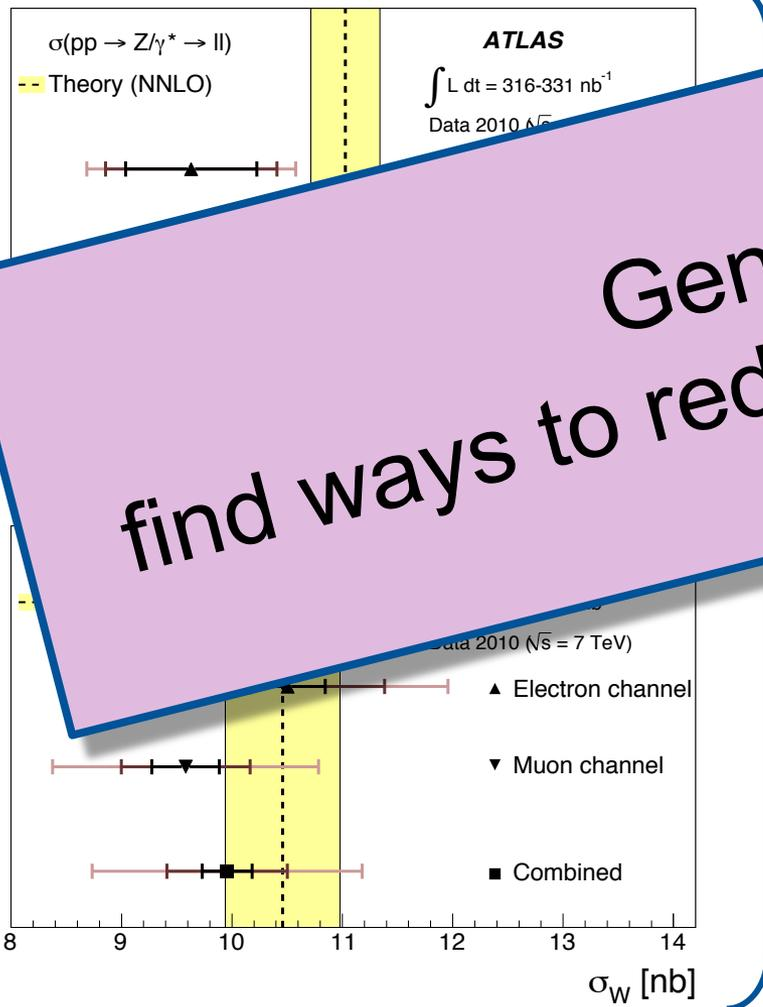

General aim:
find ways to reduce the uncertainties!

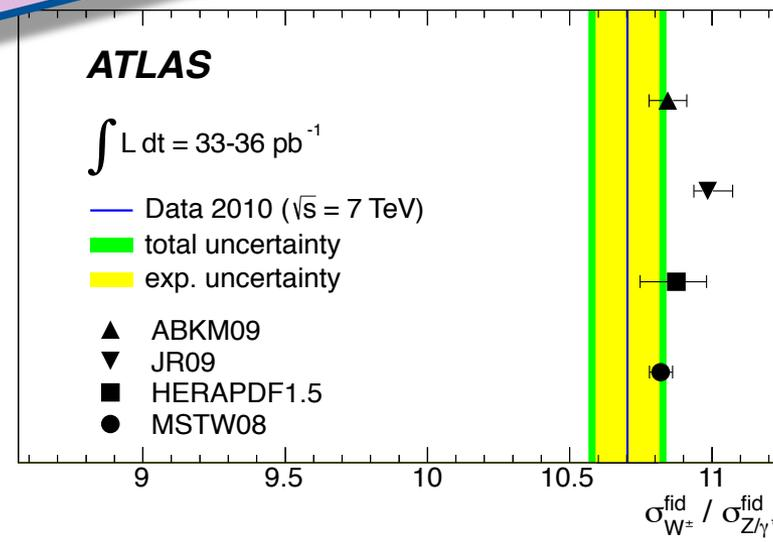

ANALYSIS FLOW IN Z^0 CROSS-SECTION MEASUREMENT

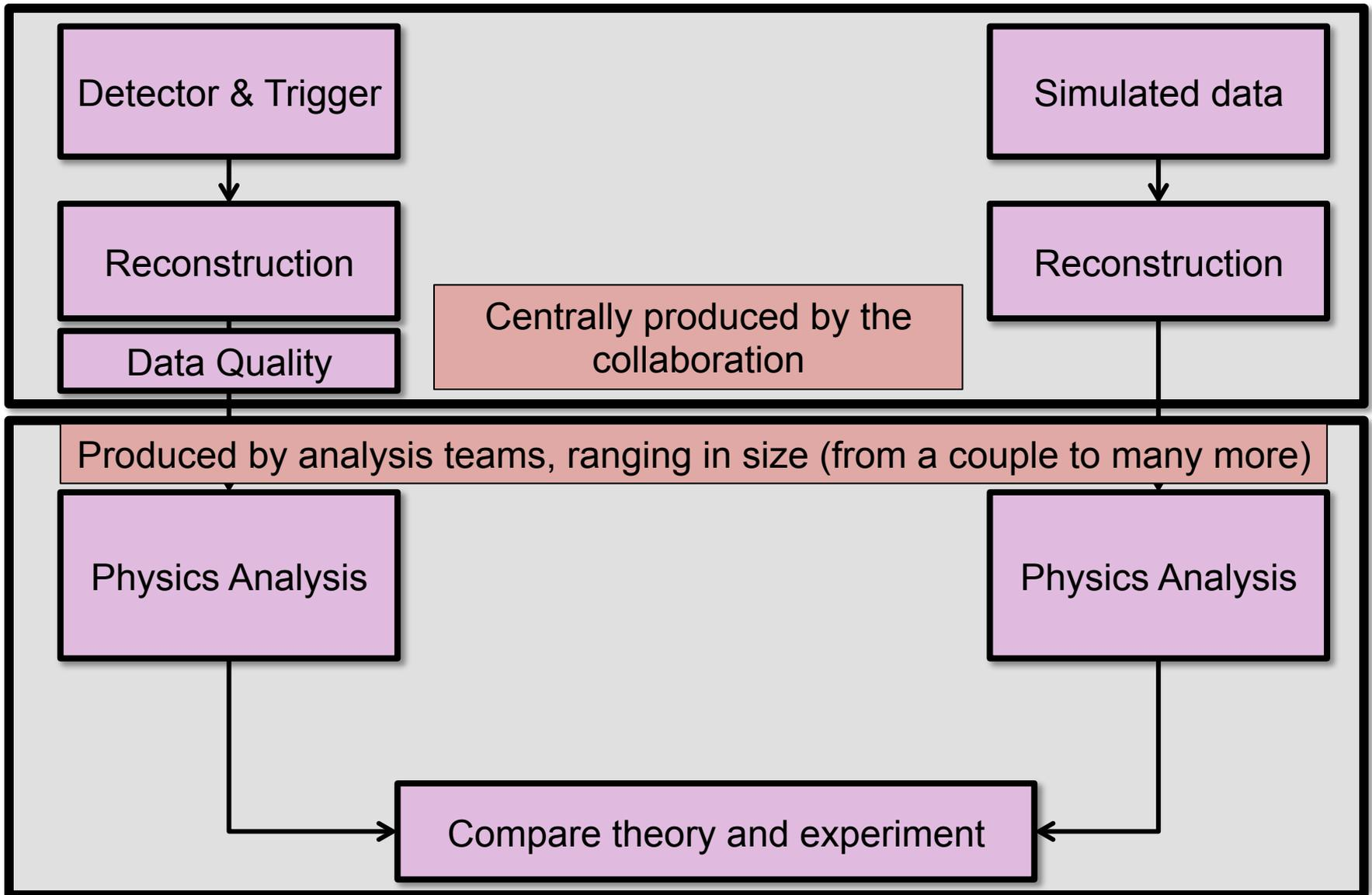

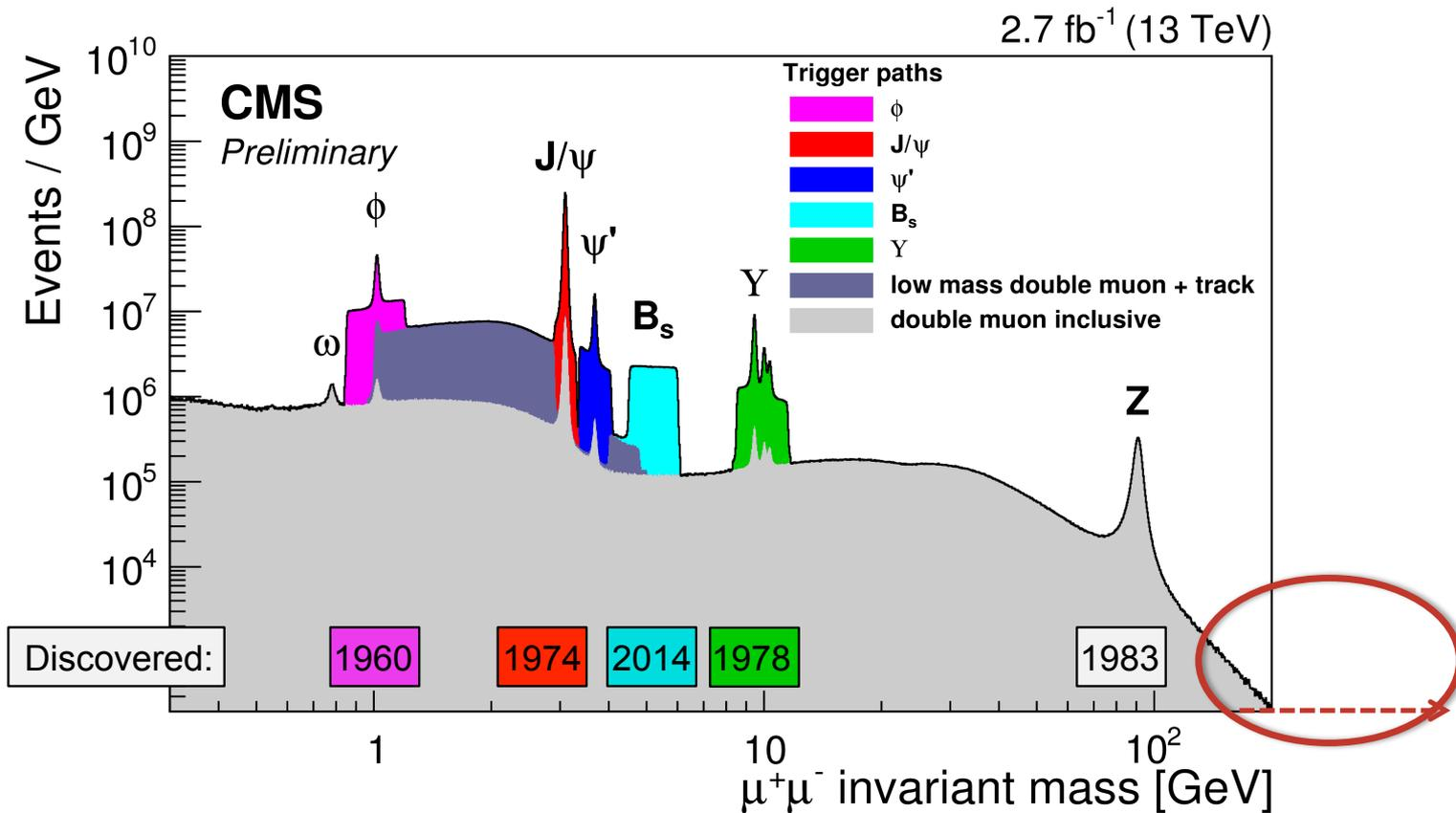

What's out there?

SIMPLE SEARCH EXAMPLE:

SEARCH FOR A HEAVY Z'

SEARCH FOR A NEW HEAVY Z'

© Like Z→ee but at higher mass.

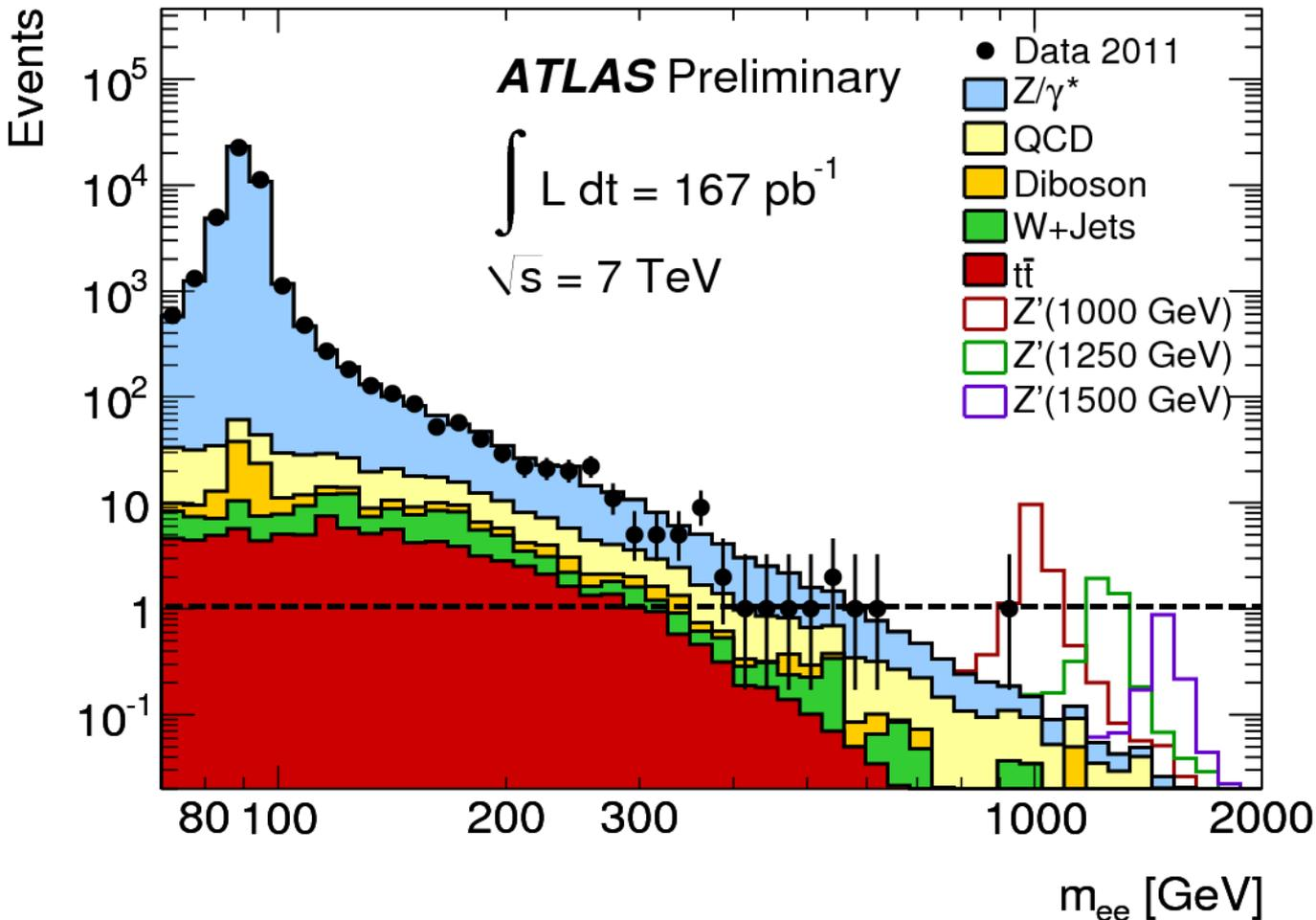

SEARCH FOR A NEW HEAVY Z'

© Like Z→ee but at higher mass.

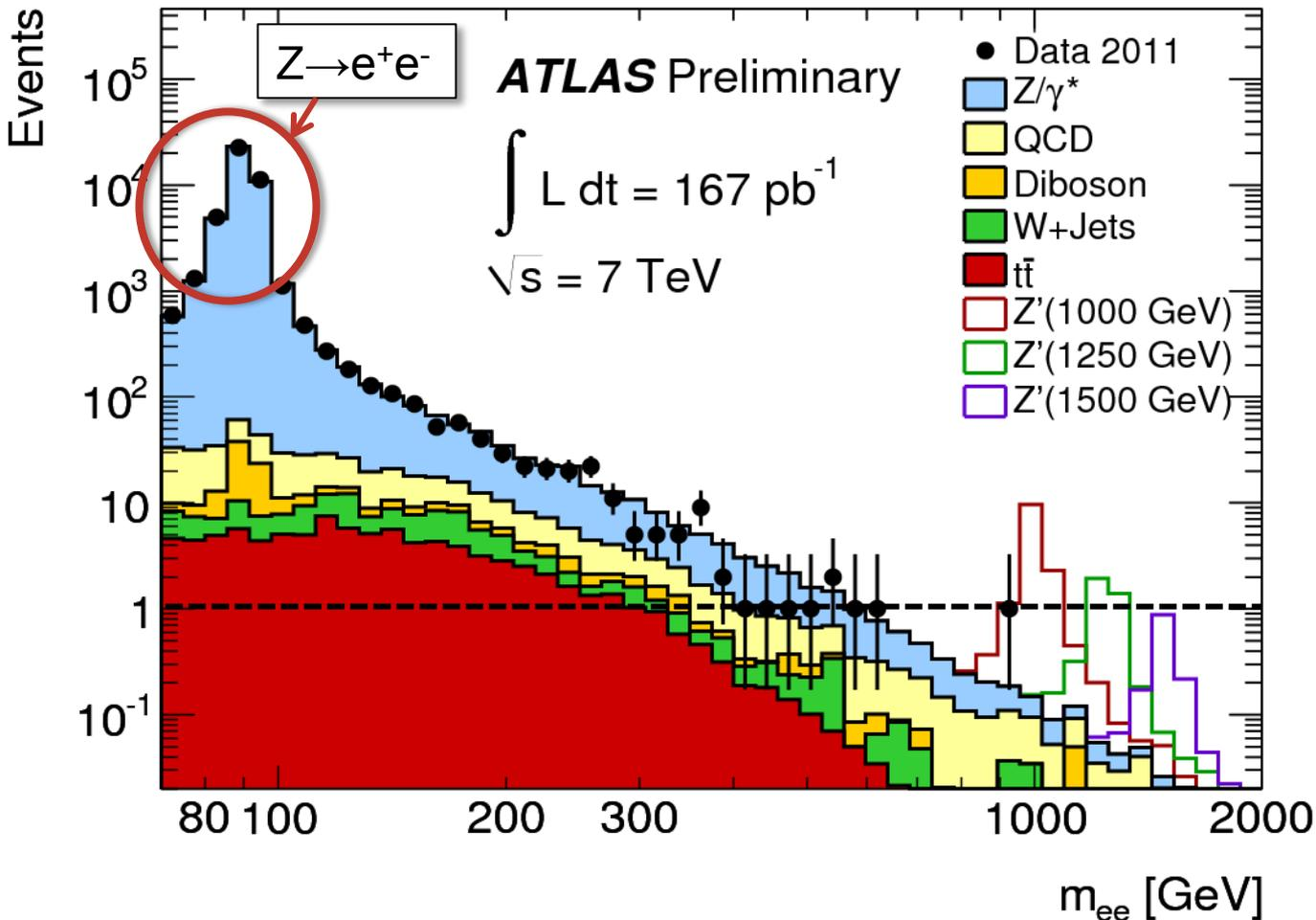

SEARCH FOR A NEW HEAVY Z'

© Like $Z \rightarrow ee$ but at higher mass.

Select 2 electron candidates and plot their invariant mass for:
1. Data

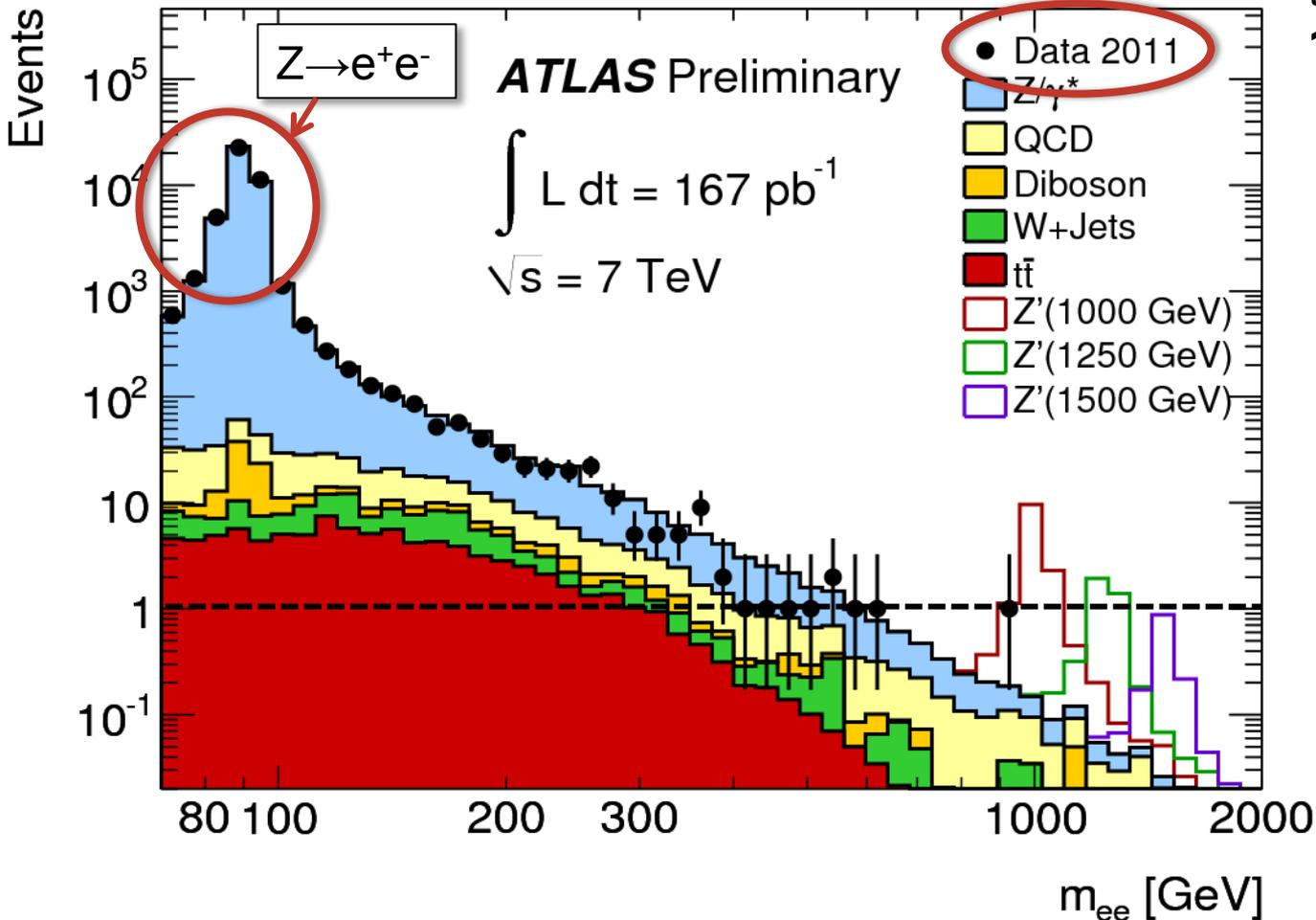

SEARCH FOR A NEW HEAVY Z'

© Like Z→ee but at higher mass.

Select 2 electron candidates and plot their invariant mass for:

1. Data
2. Simulated background events

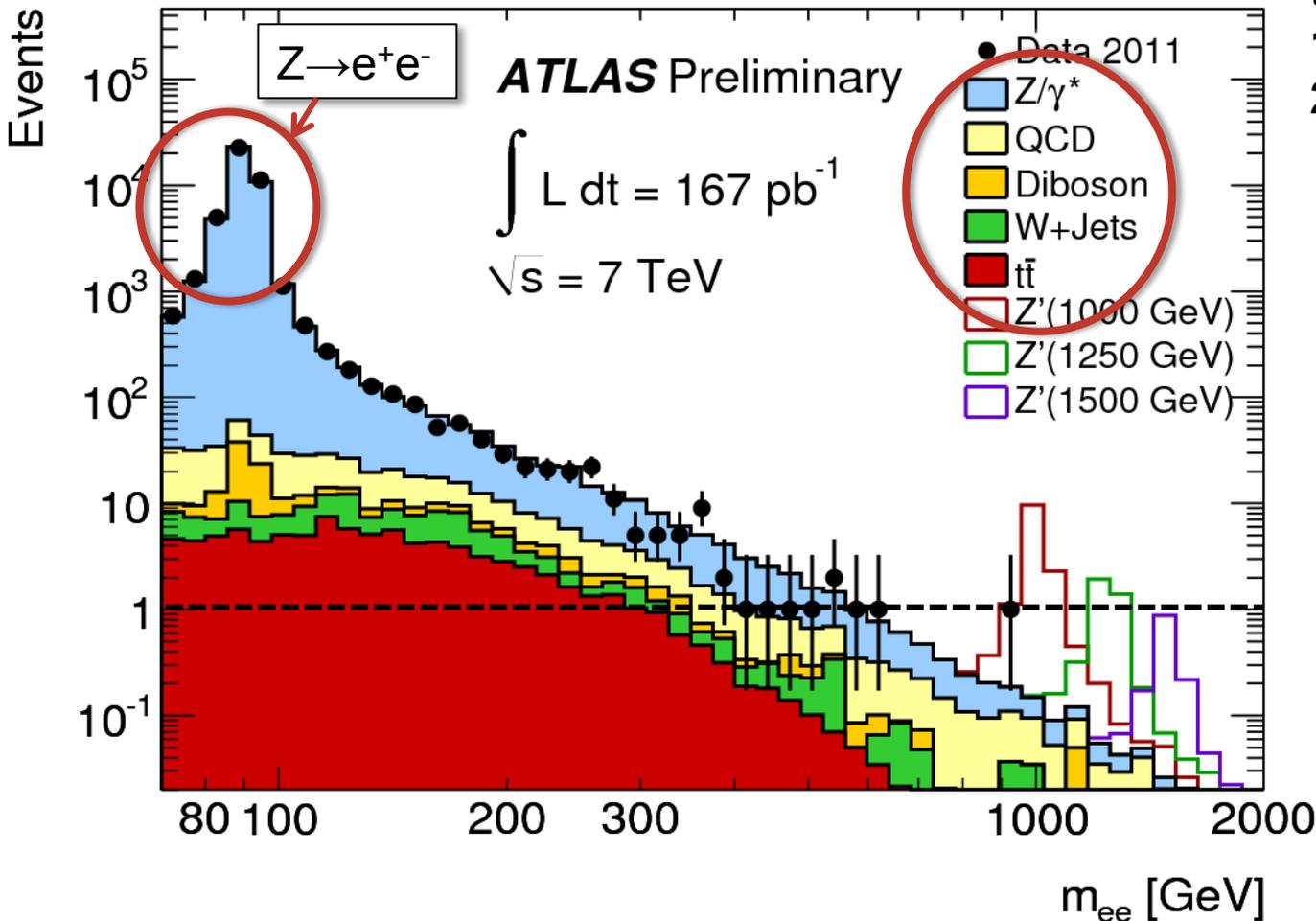

SEARCH FOR A NEW HEAVY Z'

© Like $Z \rightarrow ee$ but at higher mass.

Select 2 electron candidates and plot their invariant mass for:

1. Data
2. Simulated background events
3. Simulated signal with different masses

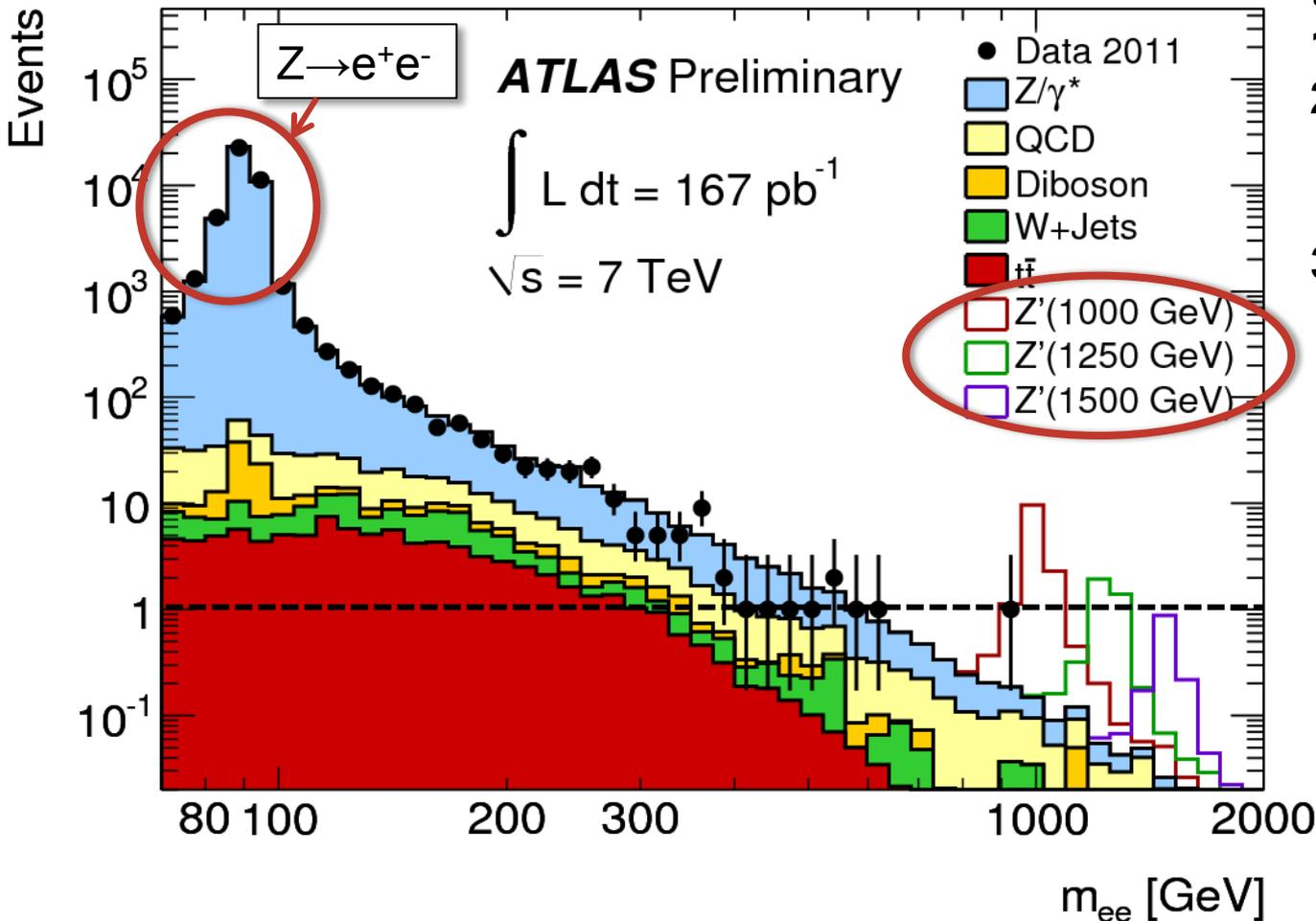

SEARCH FOR A NEW HEAVY Z'

© Like $Z \rightarrow ee$ but at higher mass.

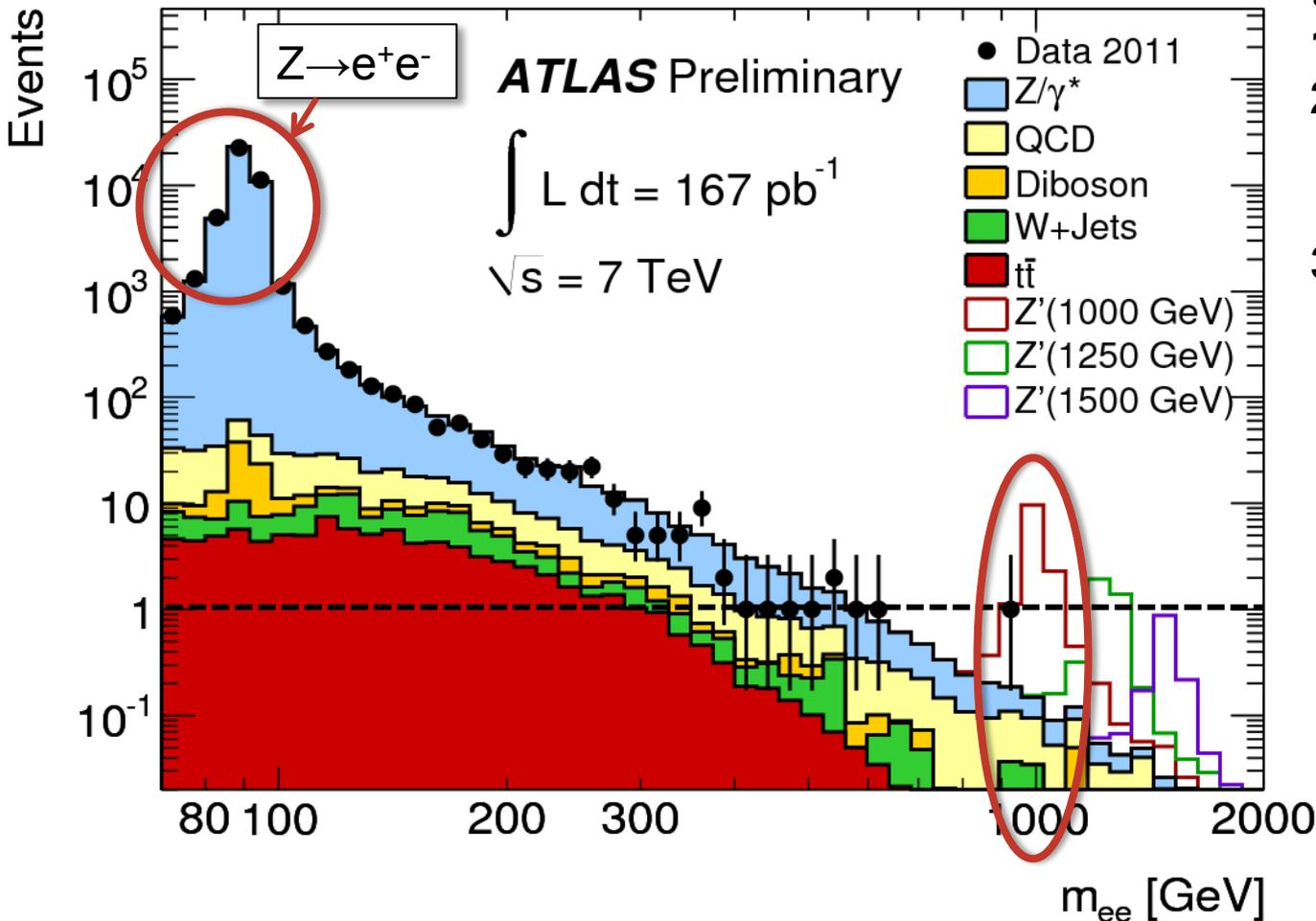

Select 2 electron candidates and plot their invariant mass for:

1. **Data**
2. **Simulated background events**
3. **Simulated signal with different masses**

Data inconsistent with a 1TeV Z'

SEARCH FOR A NEW HEAVY Z'

© Like Z→ee but at higher mass.

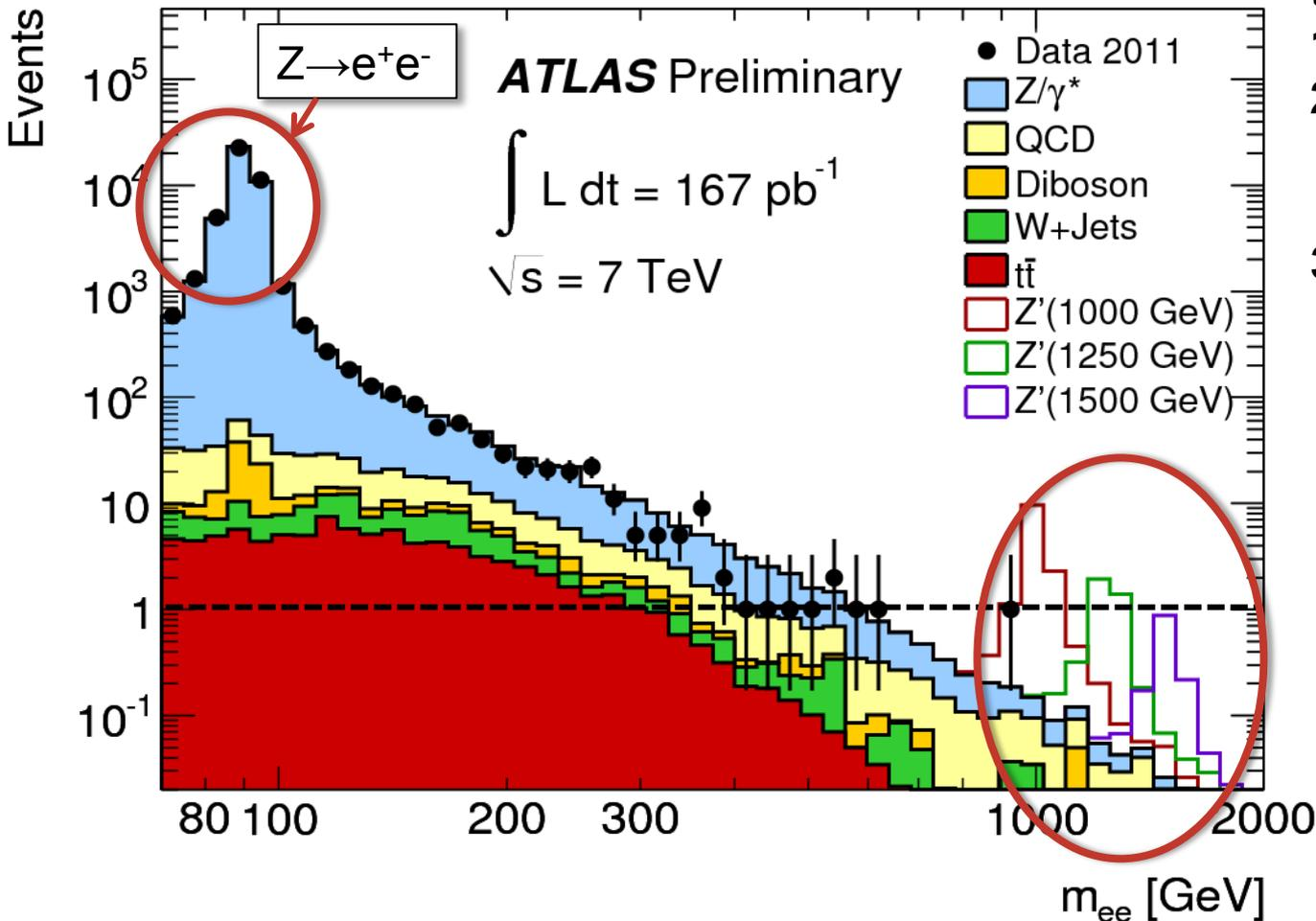

Select 2 electron candidates and plot their invariant mass for:

1. **Data**
2. **Simulated background events**
3. **Simulated signal with different masses**

Cross-section decreases with mass
(higher the mass of the Z', the more data needed to discover it)

SEARCH FOR A NEW HEAVY Z'

© And similar for muons

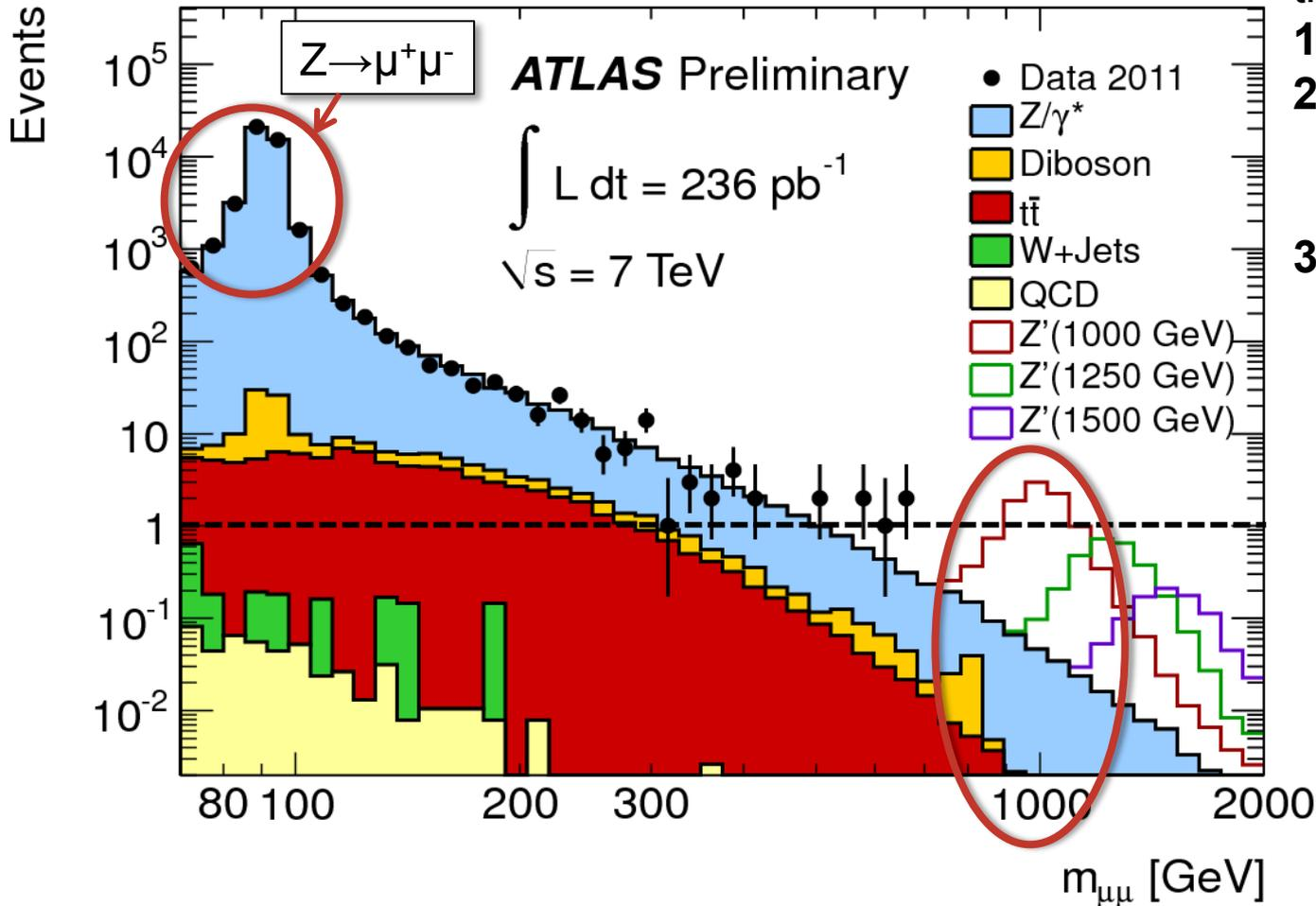

Select 2 muon candidates and plot their invariant mass for:

1. **Data**
2. **Simulated background events**
3. **Simulated signal with different masses**

Data inconsistent with a 1TeV Z'

A SMALL COMPARISON

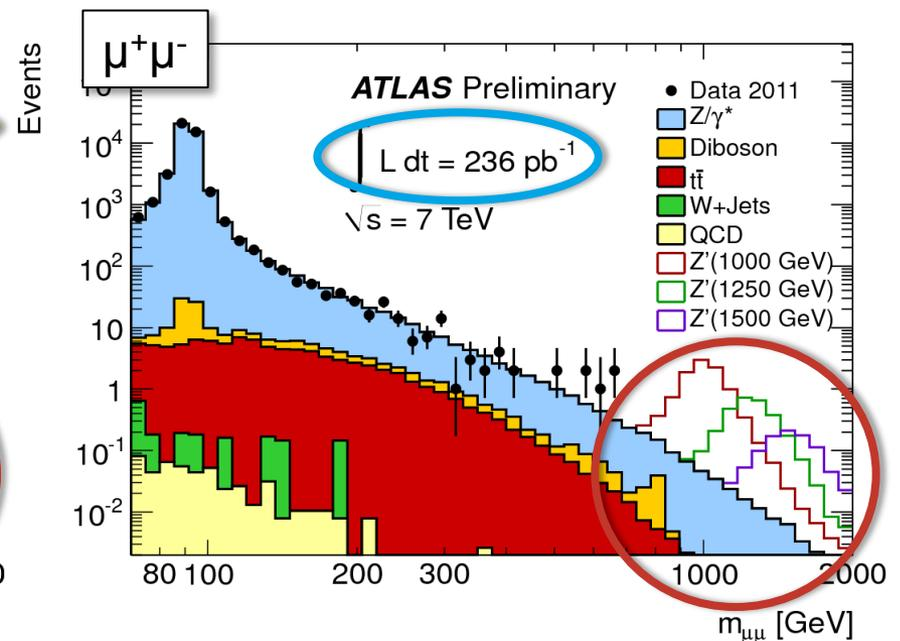
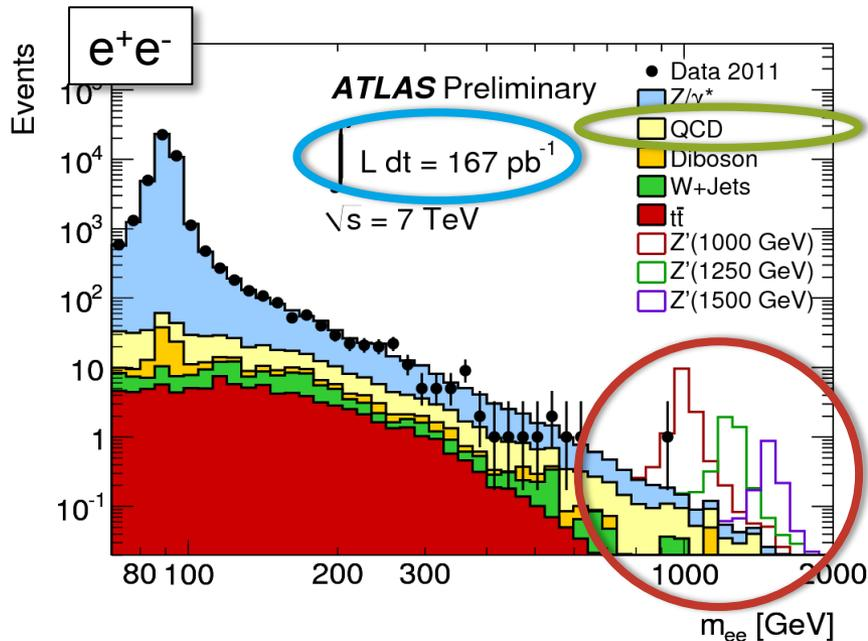

Differences in:

- ⊙ Resolution
- ⊙ Background composition
- ⊙ Dataset

EVOLUTION...

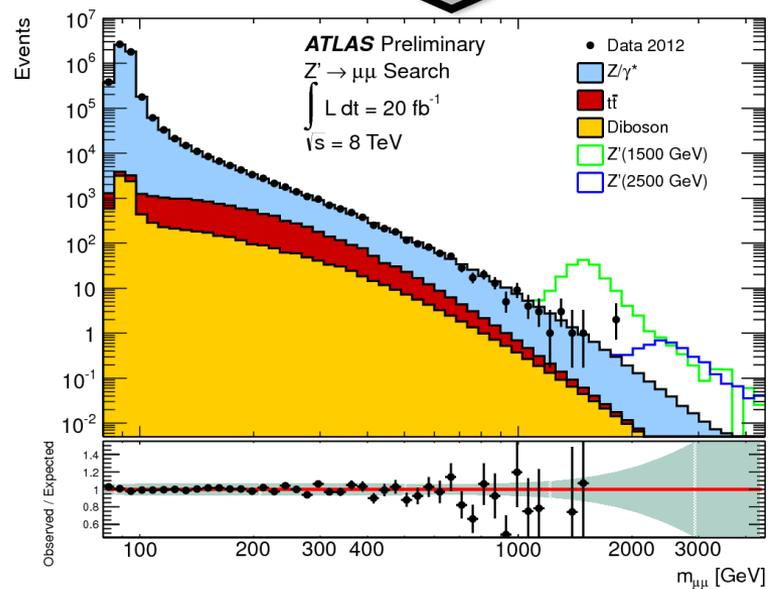
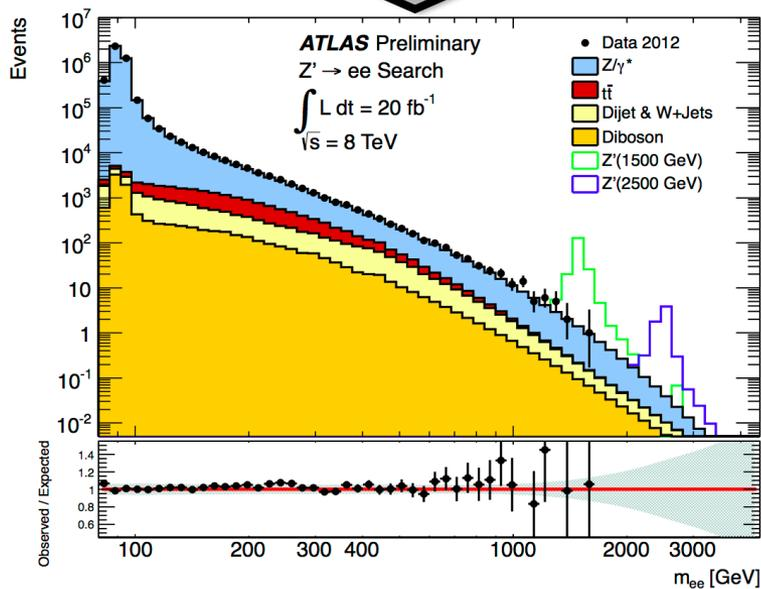
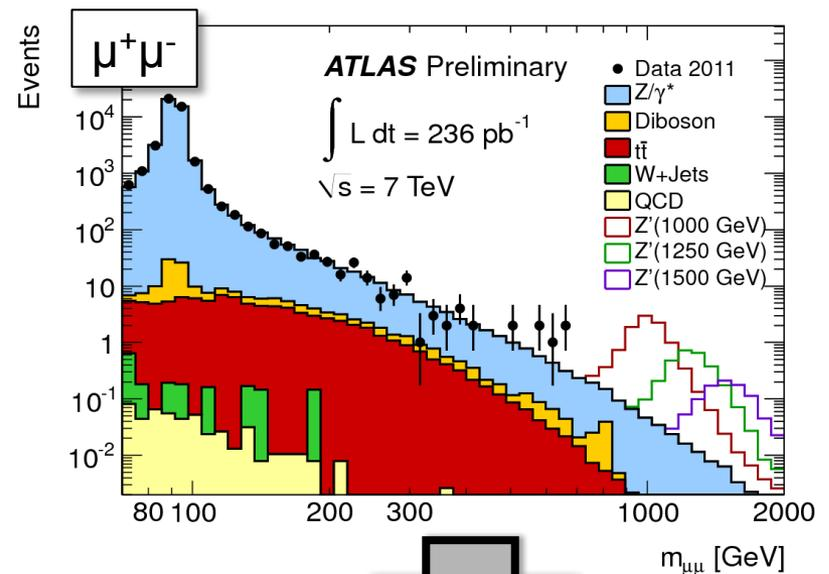
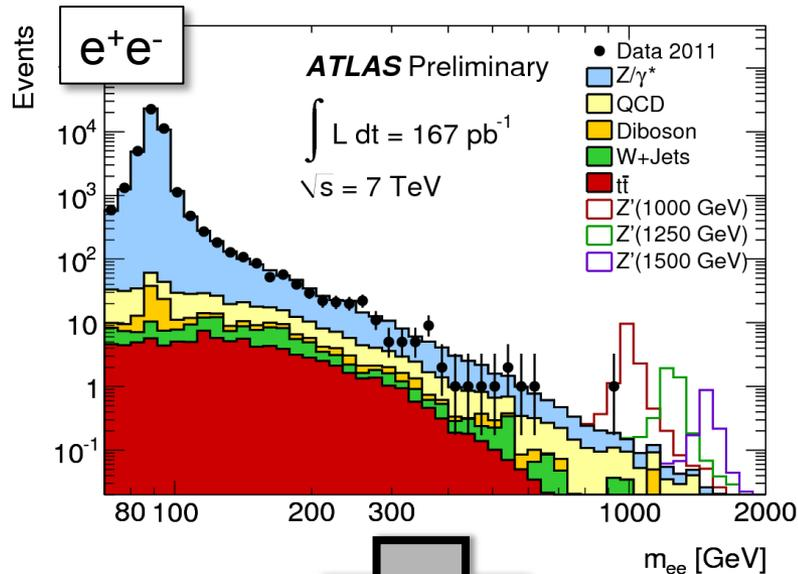

SEARCHES...

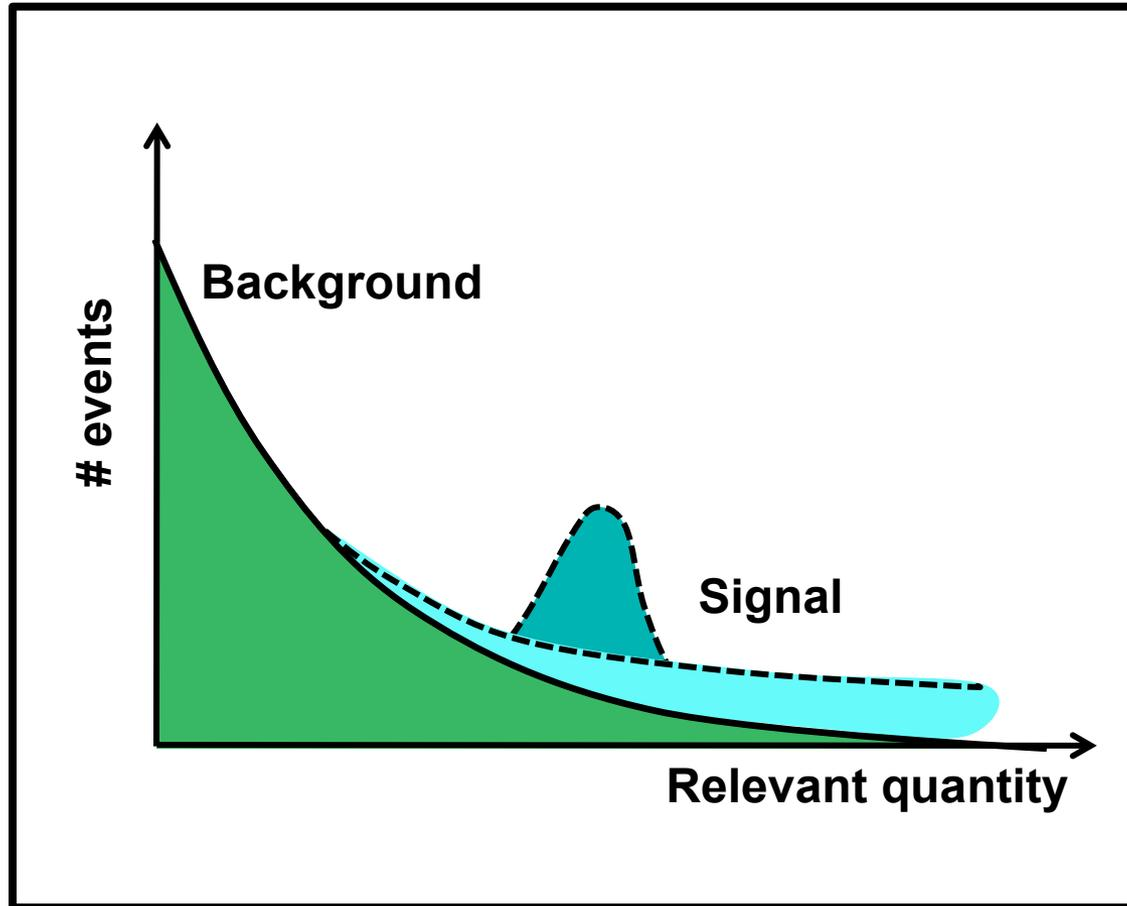

A “WELL KNOWN” BUMP SEARCH

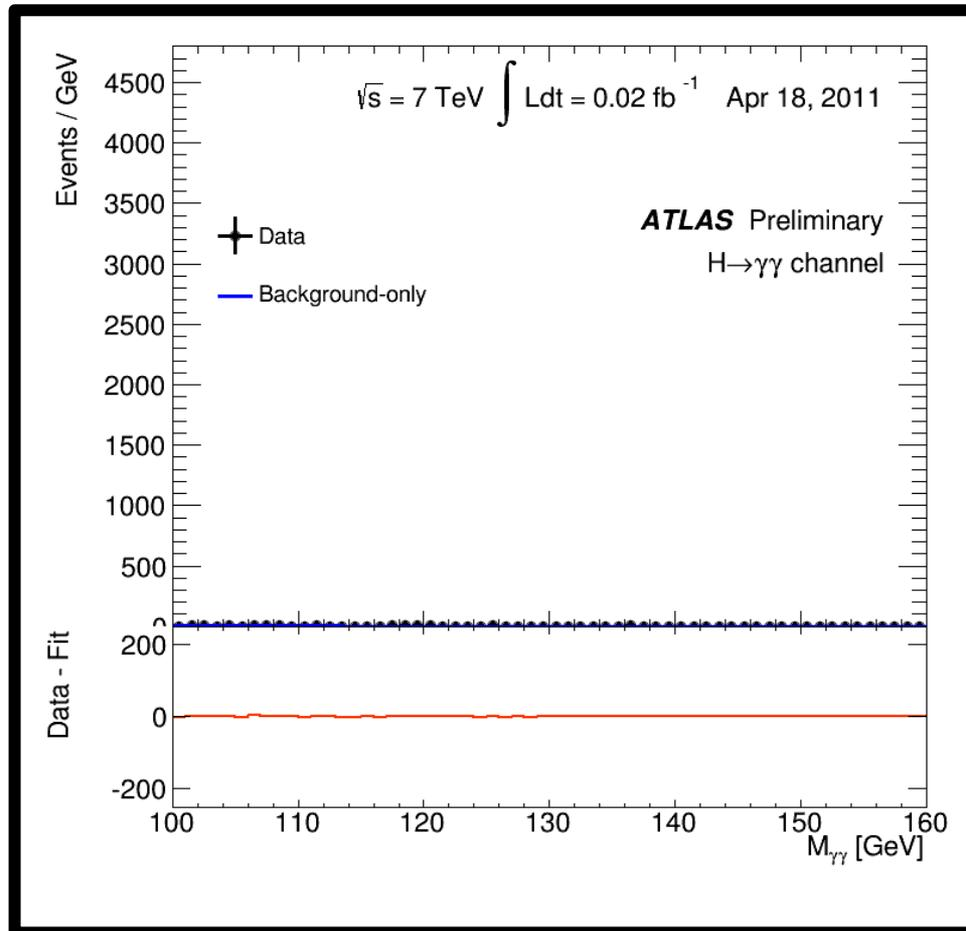

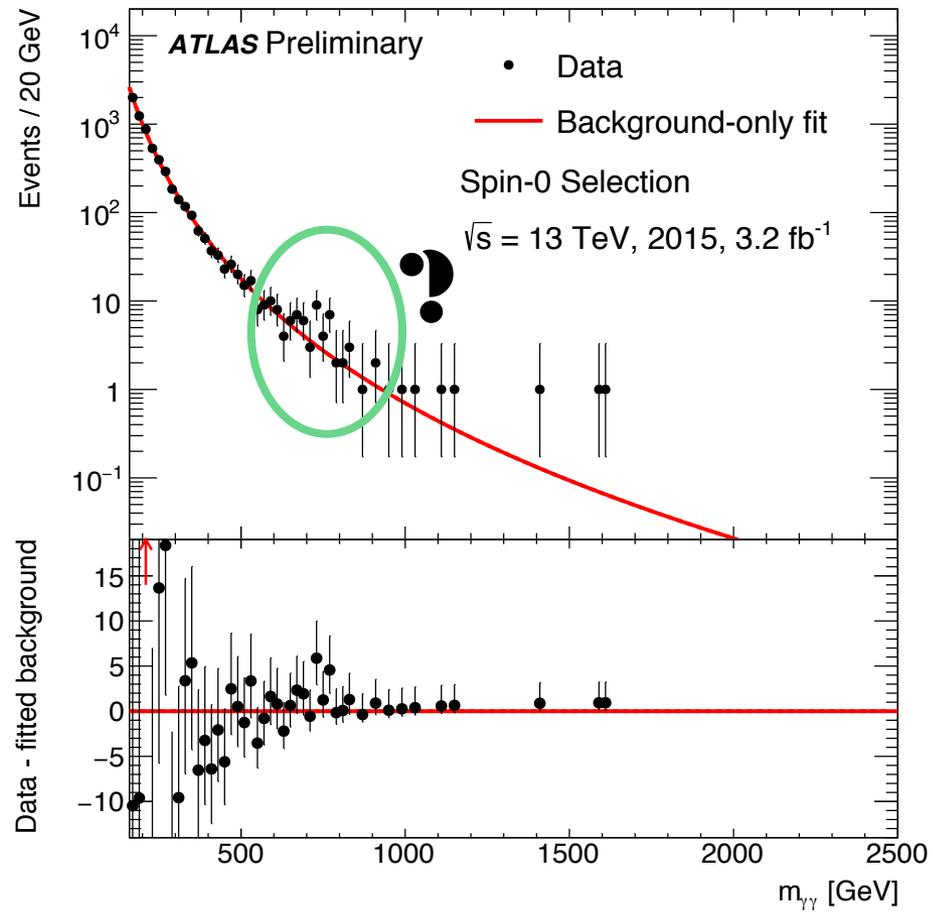

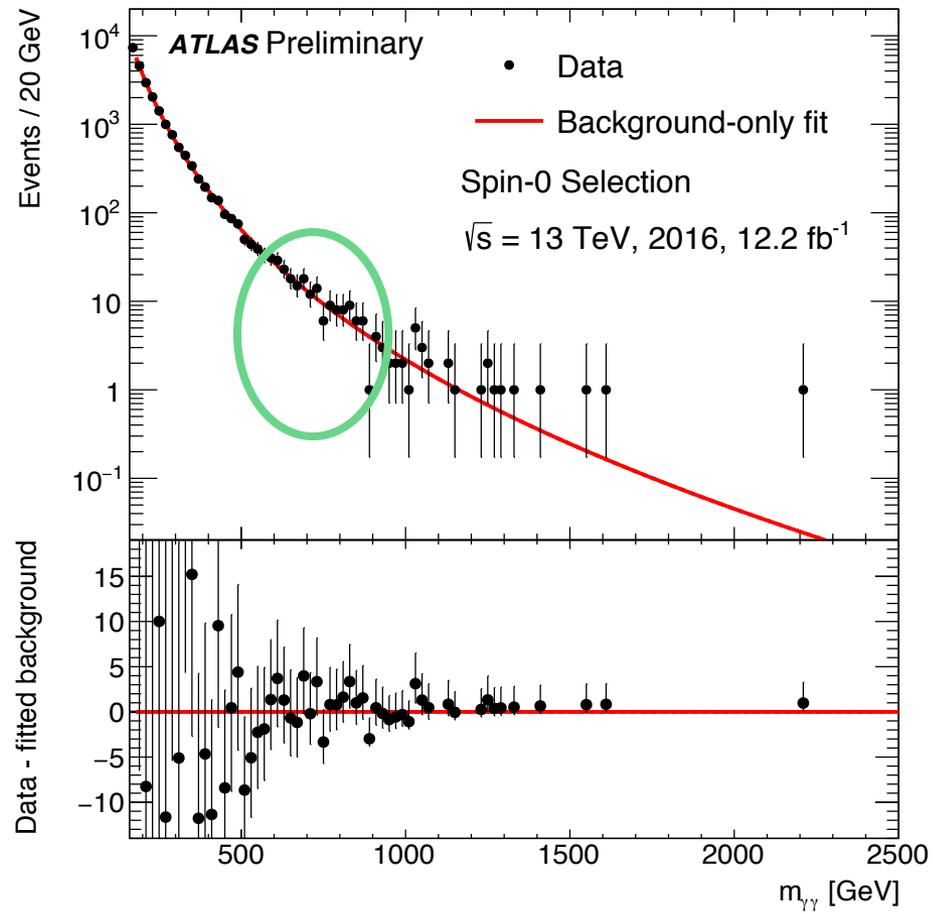

MARIO
096950

● x23

WORLD
1-4

TIME
593

THANK YOU MARIO!

BUT OUR PRINCESS IS IN
ANOTHER CASTLE!



SEARCHES...

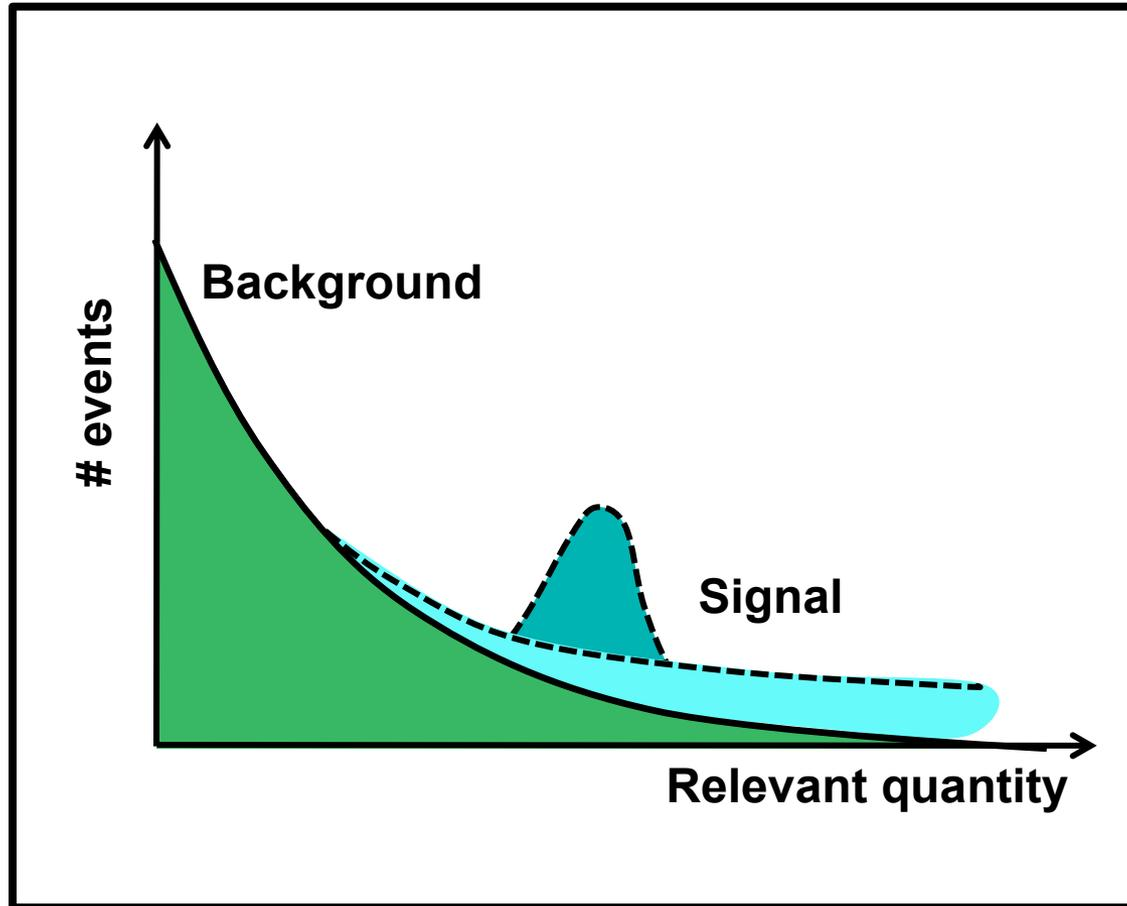

TYPICAL SUSY SEARCHES

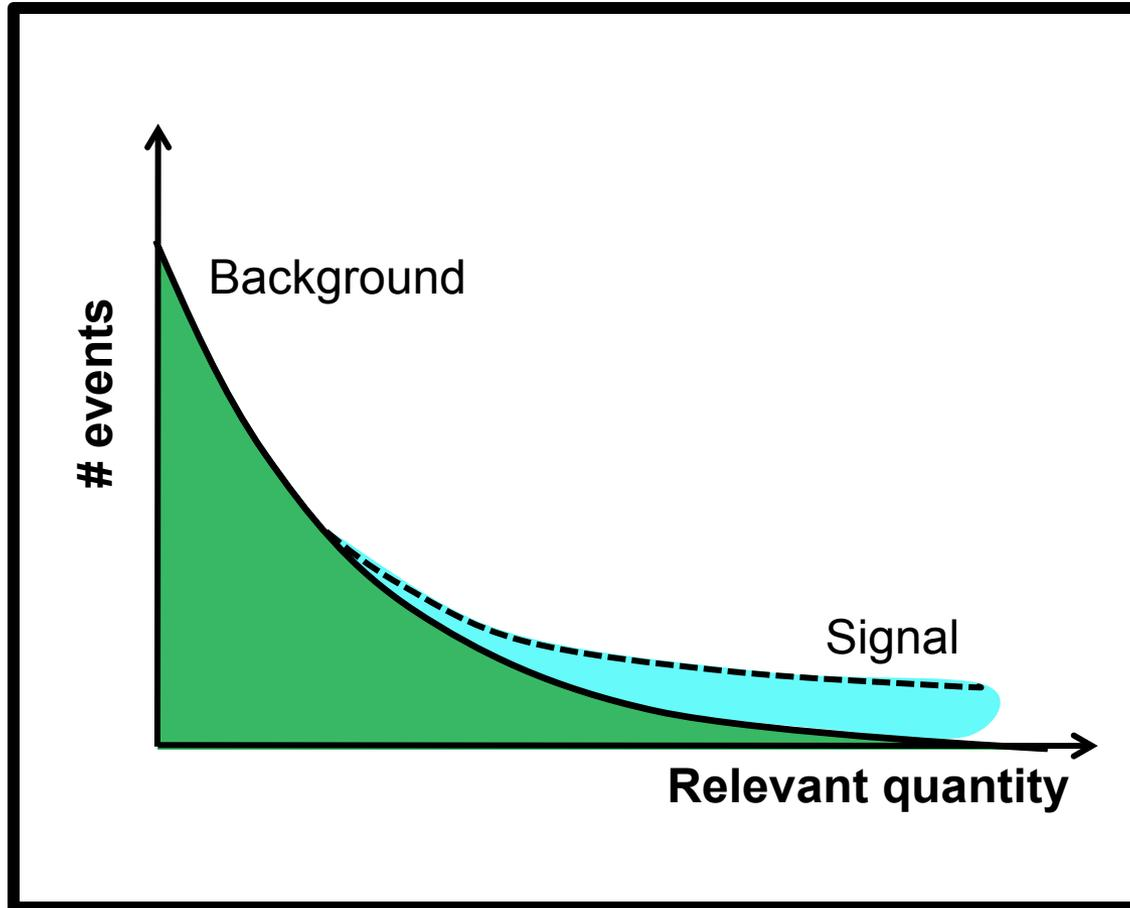

TYPICAL SUSY SEARCHES

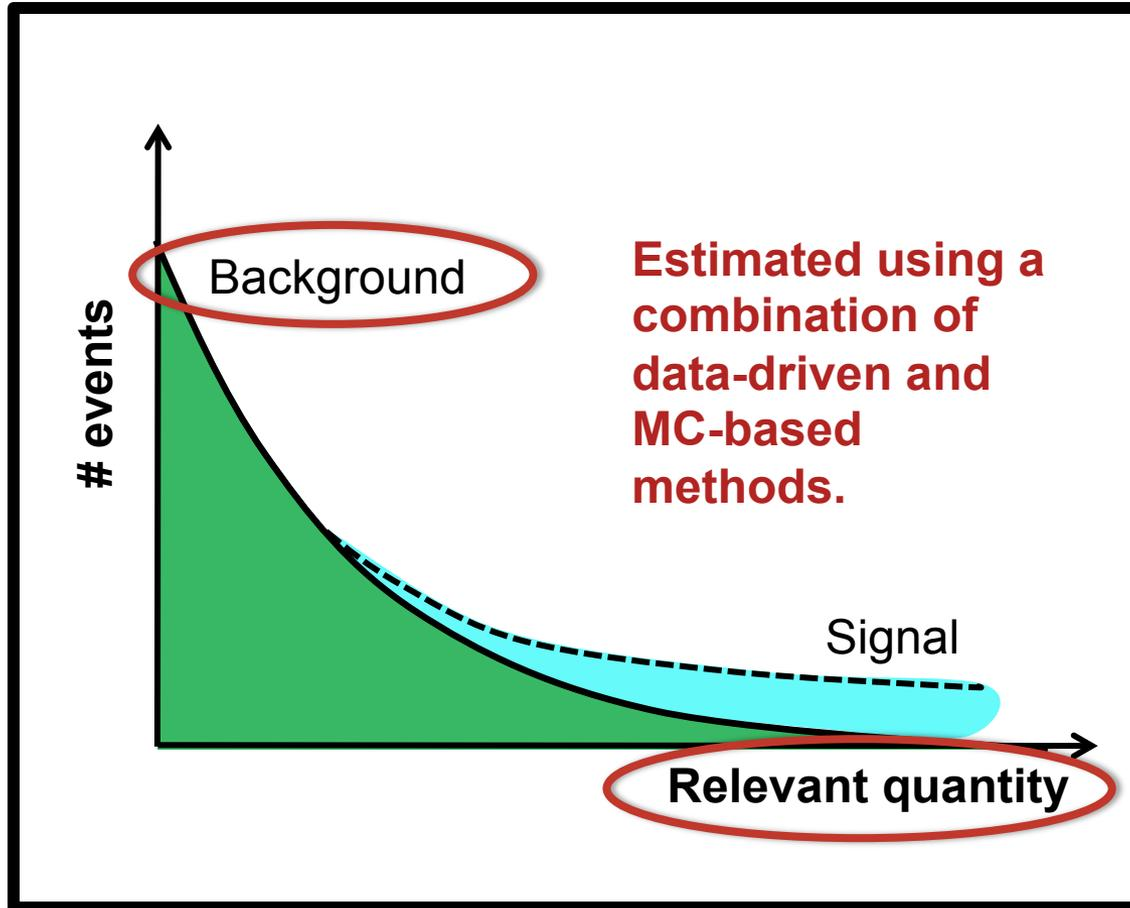

E.g. MET

ANOTHER SEARCH EXAMPLE:

SEARCH FOR SUSY IN EVENTS WITH LARGE JET MULTIPLICITIES

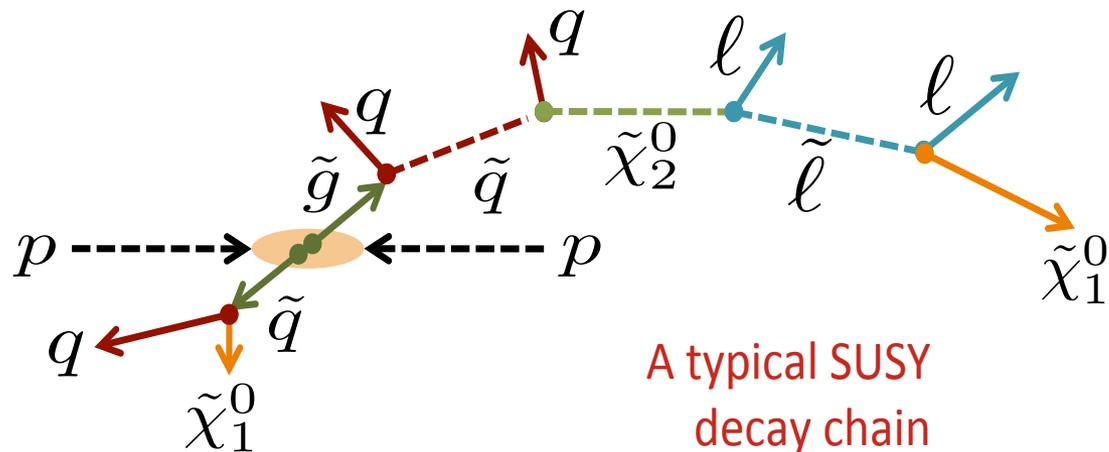

EVENT SELECTIONS

b-jets

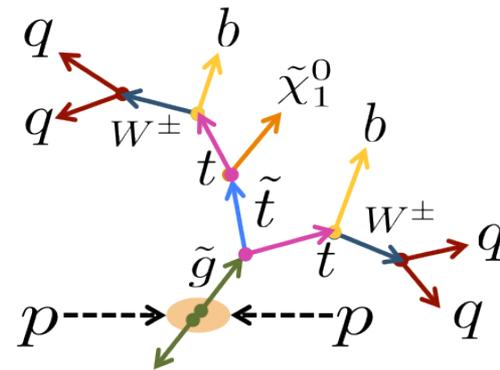
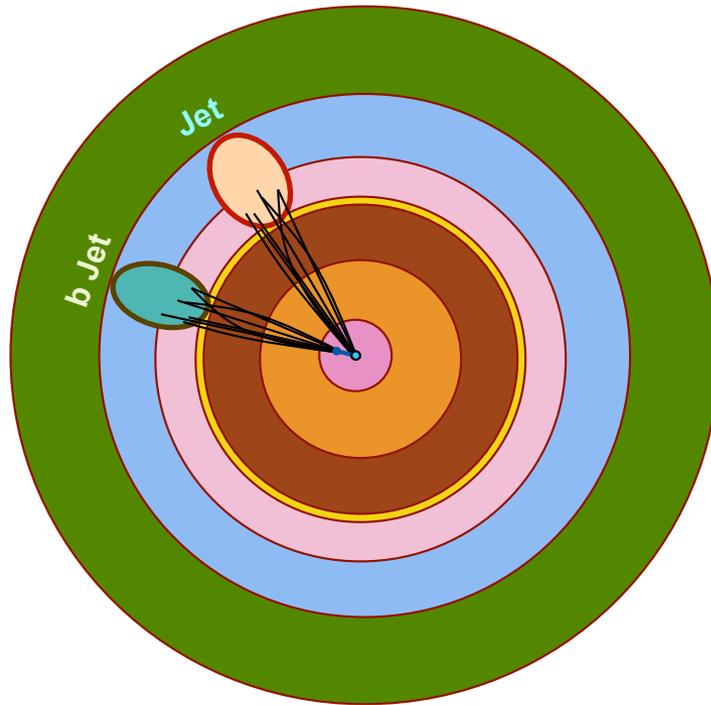

EVENT SELECTIONS

b-jets

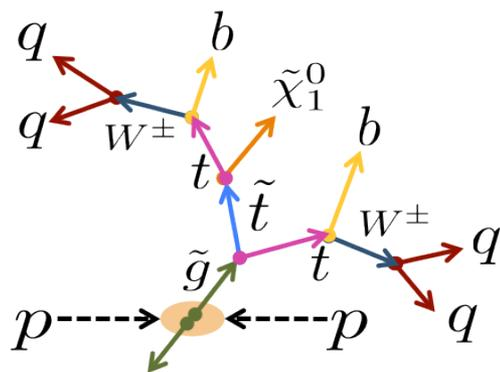
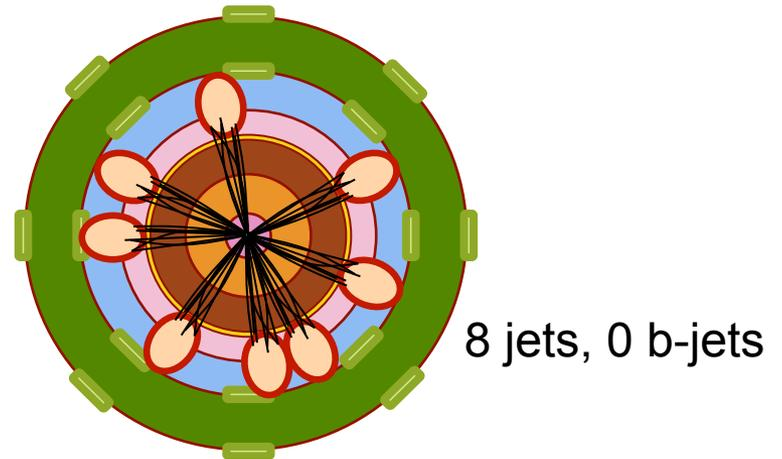
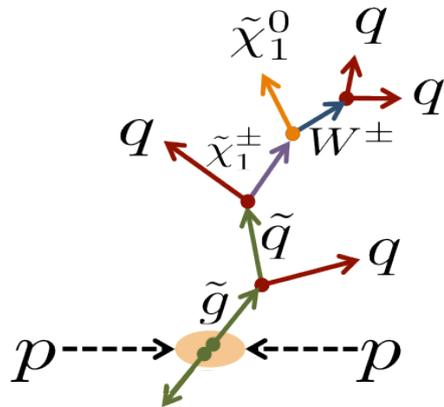

Signal regions can range in jet p_T and jet & b-jet multiplicity.

EVENT SELECTIONS

“fat-jets”

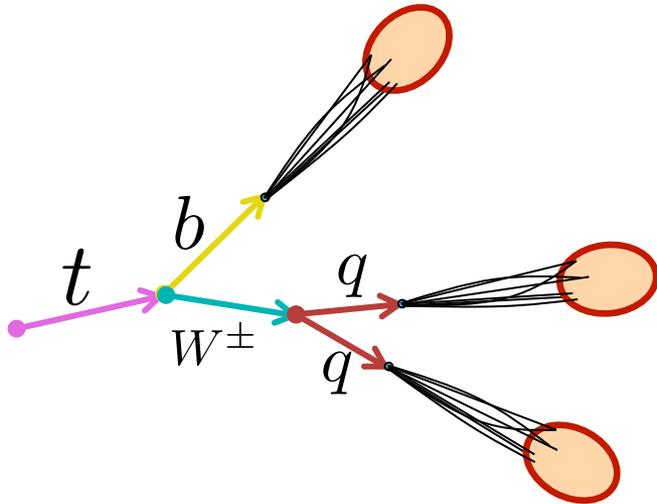

EVENT SELECTIONS

“fat-jets”

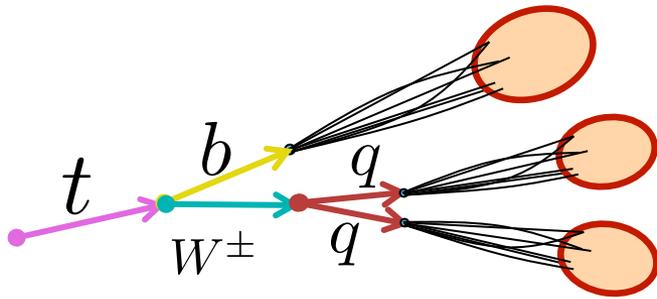

EVENT SELECTIONS

“fat-jets”

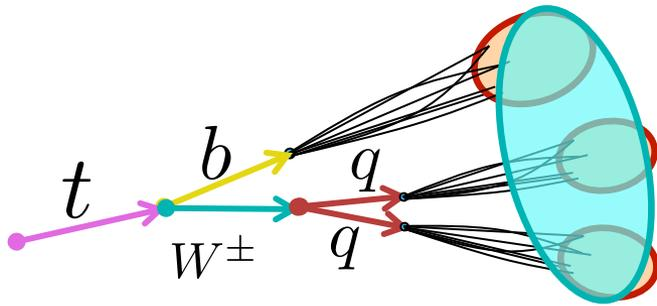

EVENT SELECTIONS

“fat-jets”

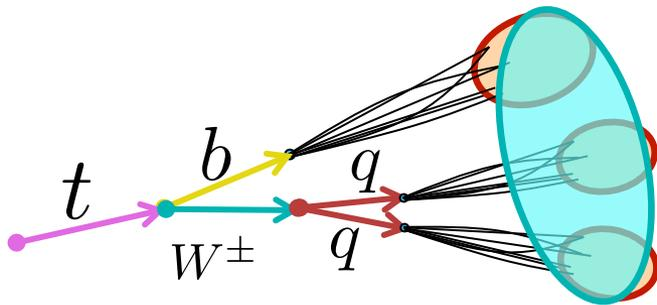

Fat-jets are a key signature in searches for boosted objects, e.g. boosted tops.

EVENT SELECTIONS

“fat-jets”

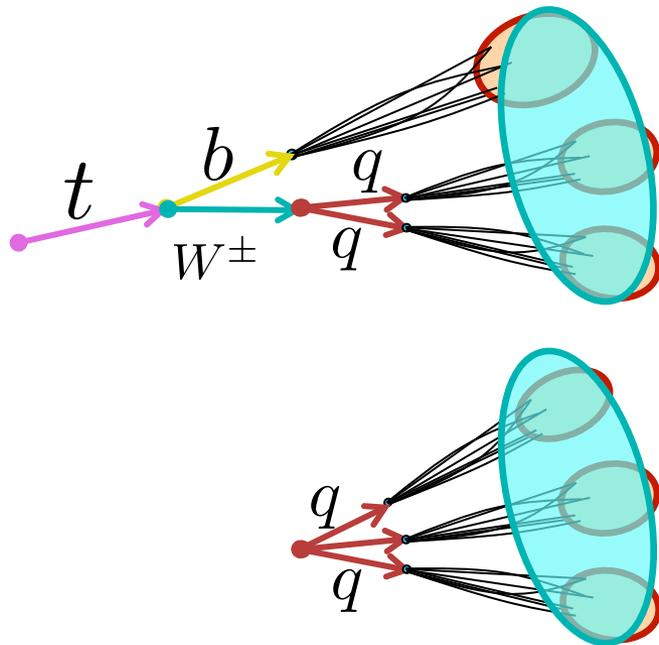

$$m_j \text{ (QCD)} < m_j \text{ (SUSY)}$$

Proposed in arXiv:1202.0558

EVENT SELECTIONS

“fat-jets”

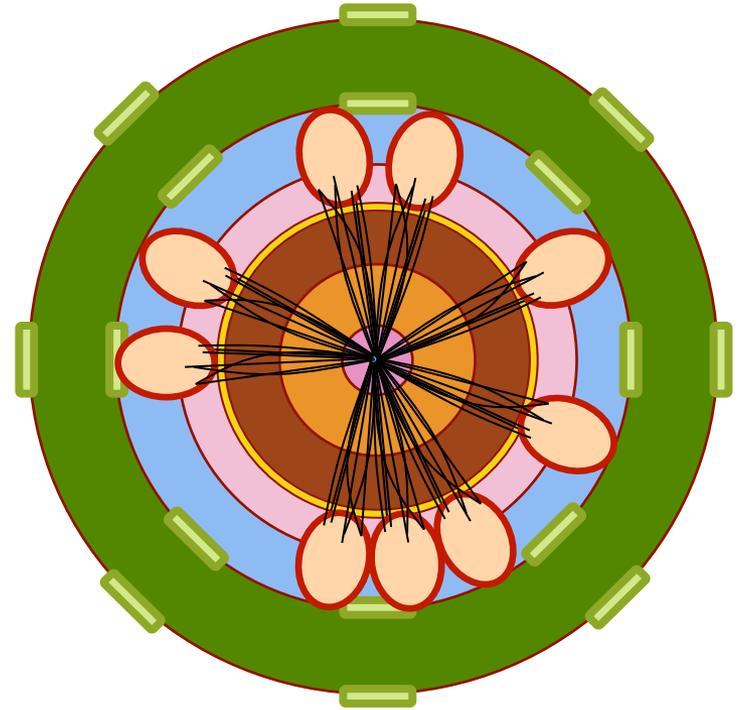
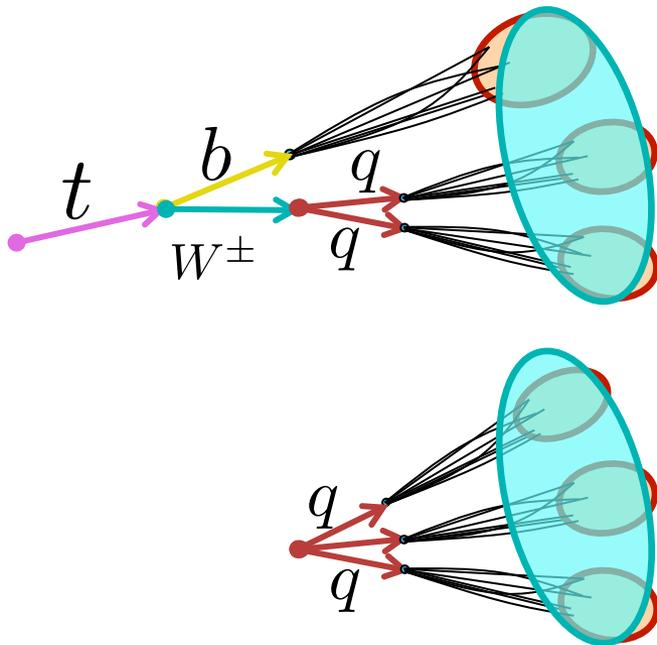

$$m_j (\text{QCD}) < m_j (\text{SUSY})$$

Proposed in arXiv:1202.0558

EVENT SELECTIONS

“fat-jets”

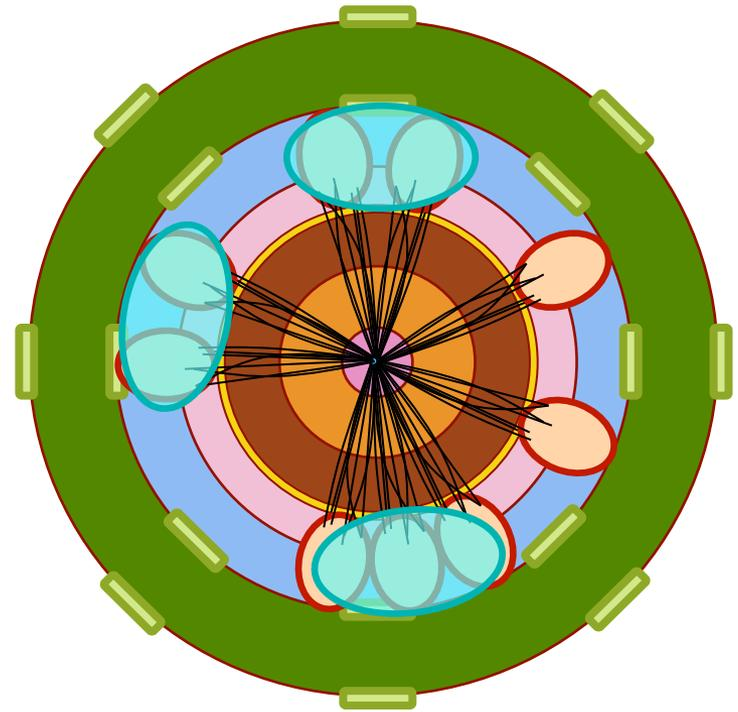
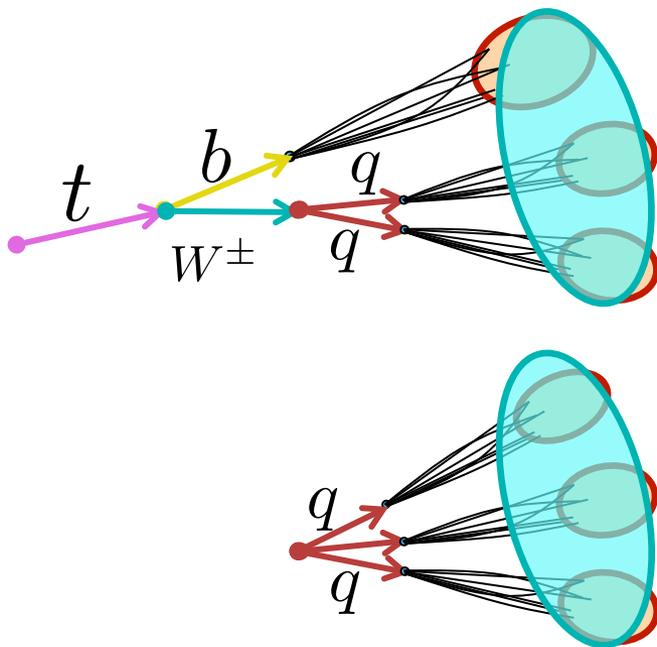

$$m_j \text{ (QCD)} < m_j \text{ (SUSY)}$$

Proposed in arXiv:1202.0558

$$M_J^\Sigma = \sum_{i=1}^{nJ} m_{j_i}$$

Signal regions can range in jet multiplicity and M_J^Σ cuts.

An example of a search

EVENT SELECTIONS

“b-jet stream”

ID	8j50			9j50			≥10j50			7j80			≥8j80		
Jet $ \eta $	< 2.0														
Jet p_T	50 GeV						80 GeV								
Jet count	=8			=9			≥10			=7			≥8		
b-jets	0	1	≥2	0	1	≥2	-	0	1	≥2	0	1	≥2		
$ME_T/\sqrt{H_T}$	> 4 GeV ^{1/2}														

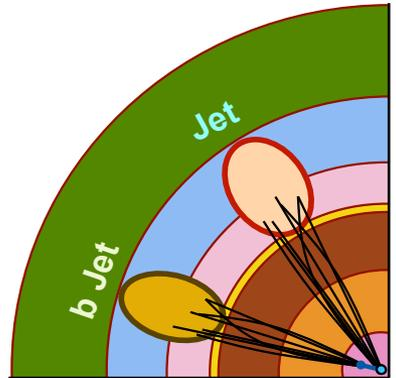

“fat-jet stream”

ID	≥8j50		≥9j50		≥10j50	
Jet $ \eta $	< 2.8					
Jet p_T	50 GeV					
Jet count	≥8		≥9		≥10	
M_J^Σ (GeV)	>340	>420	>340	>420	>340	>420
$ME_T/\sqrt{H_T}$	> 4 GeV ^{1/2}					

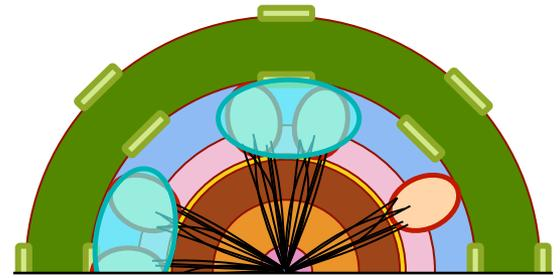

Proposed in arXiv:1202.0558

$$M_J^\Sigma = \sum_{i=1}^{n_J} m_{j_i} \quad 61$$

RESULTS

b-jet stream

ID	8j50			9j50			≥10j50
b-jets	0	1	≥2	0	1	≥2	0
Expected evts	35±4	40±10	50±10	3.3±0.7	6.1±1.7	8.0±2.7	1.37±0.35
Observed evts	40	44	44	5	8	7	3
Significance (σ)	0.7	-0.02	-0.6	0.8	0.6	-0.28	1.11

ID	7j80			≥8j80		
b-jets	0	1	≥2	0	1	≥2
Expected evts	11.0±2.2	17±6	25±10	0.9±0.6	1.5±0.9	3.3±2.2
Observed evts	12	17	13	2	1	3
Significance (σ)	0.05	-0.14	-1.0	0.9	-0.28	-0.06

fat-jet stream

ID	≥8j50		≥9j50		≥10j50	
M_J^Σ (GeV)	340	420	340	420	340	420
Expected evts	75±19	45±14	17±7	11±5	3.2±3.7	2.2±2.0
Observed evts	69	37	13	9	1	1
Significance (σ)	-0.27	-0.6	-0.6	-0.34	-0.8	-0.6

RESULTS

b-jet stream

ID	8j50			9j50			≥10j50
b-jets	0	1	≥2	0	1	≥2	0
Expected evts	35±4	40±10	50±10	3.3±0.7	6.1±1.7	8.0±2.7	1.37±0.35
Observed evts	40	44	44	5	8	7	3
Significance (σ)	0.7	-0.02	-0.6	0.8	0.6	-0.28	1.11

ID	7j80			≥8j80		
b-jets	0	1	≥2	0	1	≥2
Expected evts	11.0±2.2	17±6	25±10	0.9±0.6	1.5±0.9	3.3±2.2
Observed evts	12	17	13	2	1	3
Significance (σ)	0.05	-0.14	-1.0	0.9	-0.28	-0.06

fat-jet stream

ID	≥8j50		≥9j50		≥10j50	
M_J^Σ (GeV)	340	420	340	420	340	420
Expected evts	75±19	45±14	17±7	11±5	3.2±3.7	2.2±2.0
Observed evts	69	37	13	9	1	1
Significance (σ)	-0.27	-0.6	-0.6	-0.34	-0.8	-0.6

RESULTS

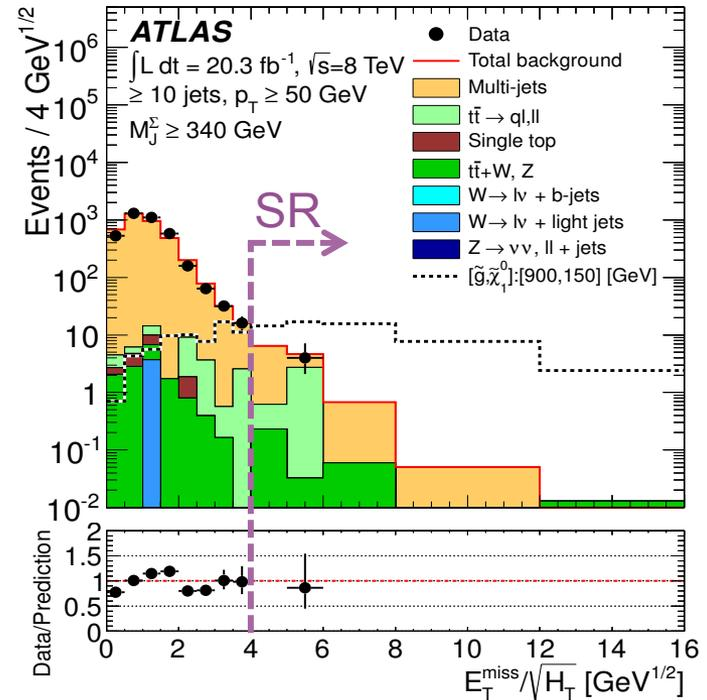
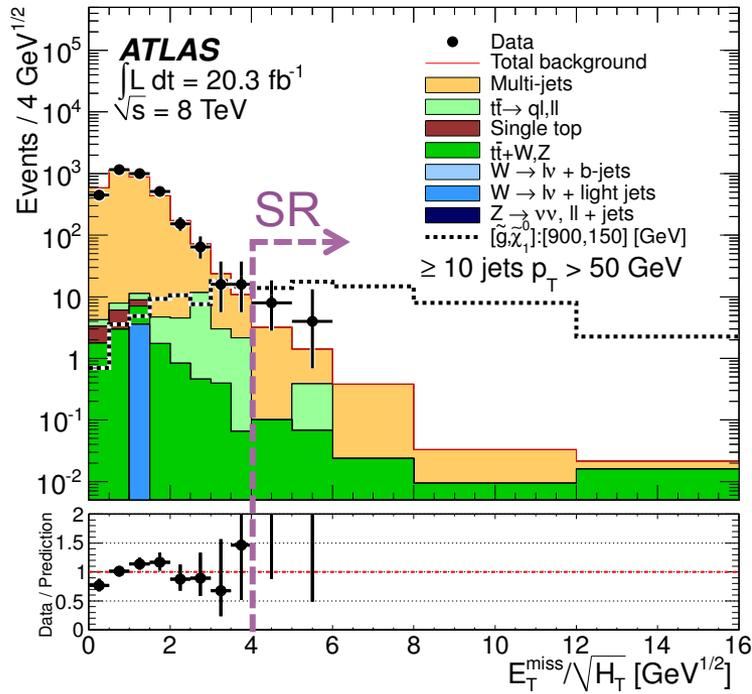

INTERPRETATIONS

Real or Simplified models

- © Simplified topologies include typically one production and one decay process. Provide useful information for theorists.

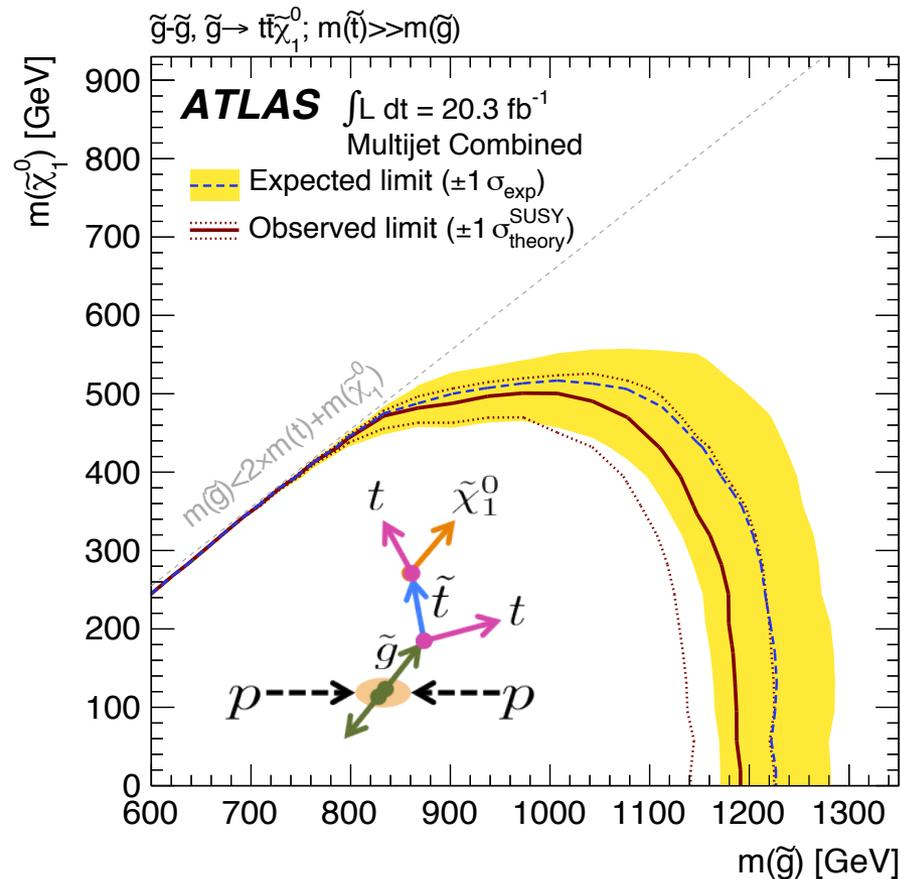

INTERPRETATIONS

Real or Simplified models

- © Simplified topologies include typically one production and one decay process. Provide useful information for theorists.

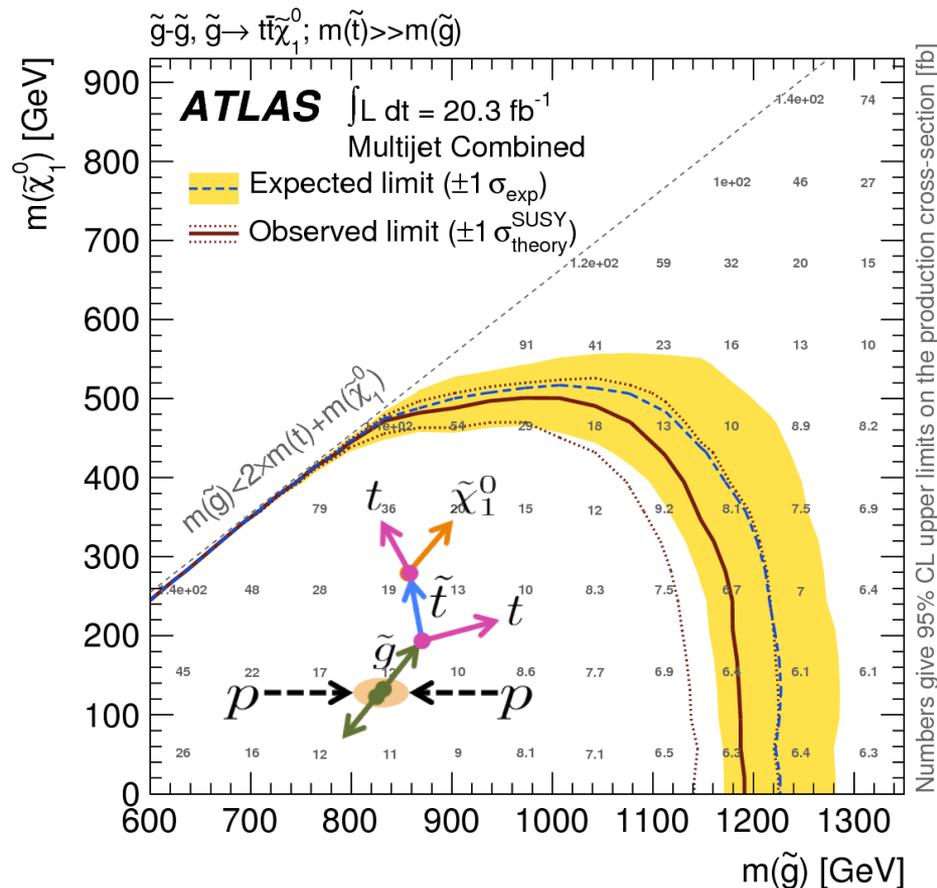

CONTENTS OF A RANDOM SEARCH INTERNAL DOCUMENTATION

26	Contents	
27	1 Introduction	3
28	2 Differences compared to the previous multijet analysis	3
29	3 Data-set and Monte Carlo samples	5
30	3.1 Data Sample	5
31	3.2 Standard Model Monte-Carlo	5
32	3.3 Signal Models	5
33	4 Trigger	10
34	5 Object selection and event cleaning	
35	5.1 Definition of Primary Objects	
36	5.2 General Analysis Cuts	
37	6 Effect of Pile-up on jets	
38	7 Event selection	
39	7.1 Signal region optimization	
40	7.2 Jet mass selection	
41	7.3 Signal region definitions	
42	8 Standard Model background estimation	
43	8.1 Multi-Jet Production	
44	8.1.1 Central jets, split by b -tag	
45	8.1.2 Total Jet Mass, M_J^2	
46	8.2 Leptonic backgrounds	
47	8.2.1 $t\bar{t}$ and W +jets Background	
48	8.2.2 Z +jets Background	
49	8.3 Other SM Processes	
50	8.4 Summary	
51	9 Systematic uncertainties	
52	9.1 Experimental Uncertainties	
53	9.2 Theoretical Uncertainties	
54	9.2.1 $t\bar{t}$ Systematics	
55	9.2.2 W +jets Systematics	
56	9.2.3 $W + b/\bar{b}/b\bar{b}$ +jets Systematics	
57	9.2.4 $Z \rightarrow \nu\nu$ +jets Systematics	
58	9.2.5 Single Top Systematics	
59	9.2.6 $t\bar{t}$ + W/Z Systematics	
60	10 Statistical Methods	
61	11 Results and Interpretation	
62	11.1 Fit results	
63	11.1.1 b -jet analysis stream	
64	11.1.2 M_J^2 analysis stream	

65	11.2 Interpretation	156
66	11.2.1 Model independent limits	156
67	11.2.2 Limits	157
68	12 Conclusions	161
69	A B-tagging in Different Monte-Carlo Samples	165
70	B Optimization studies	166
71	B.1 Multijet plus b-jets signal regions	166
72	B.2 Multijet plus M_J^2 signal regions	173
73	B.3 Multijet plus M_J^2 control regions - systematic uncertainties	177
74	B.3.1 Reweighting distributions using the leading fat jet p_T	182
75	C Trigger	197
76	D Theory Systematic Variations	203
77	D.1 $t\bar{t}$ Systematic variations	203
78	D.2 Single Top Systematic variations	204
79	D.3 Vector Boson + Jets Systematic variations	204
80	D.4 $T\bar{t}$ + V Systematic variations	204
81	E Sensitivity to SUSY models	208
82	F Signal contamination	229
83	G Heavy Flavour systematics	237
84	H Signal region distributions	242
85	H.1 b -jet SRs	242
86	H.2 M_J^2 SRs	244
87	I Minor backgrounds	247
88	J Fit tests	250
89	K Stream overlap	250
90	L HEP data	256
91	M Event displays	285

COMPONENTS OF A PHYSICS ANALYSIS

- ◎ Data-set and Monte Carlo samples
- ◎ Trigger
- ◎ Object definitions and event selections
- ◎ Background determination
- ◎ Systematic uncertainties
- ◎ Statistical methods
- ◎ Results
- ◎ [Interpretations]

COMPONENTS OF A PHYSICS ANALYSIS

- ⊙ Data-set and Monte Carlo samples
- ⊙ Trigger
- ⊙ Object definitions
- ⊙ Background detection
- ⊙ Systematic uncertainties
- ⊙ Statistical methods
- ⊙ Results
- ⊙ [Interpretations]

The data and simulation samples used in the analysis. Data for the measurement / search, simulation to compare data to predictions.

Data-set specifics:

- ⊙ Data quality \Rightarrow Good run list.
- ⊙ Luminosity.

Monte carlo sample specifics:

- ⊙ Generator, tunes.
- ⊙ Statistics.

COMPONENTS OF A PHYSICS ANALYSIS

- ⊙ Data-set and Monte Carlo samples
- ⊙ Trigger
- ⊙ Object definition
- ⊙ Background determination
- ⊙ Systematic uncertainties
- ⊙ Statistical methods
- ⊙ Results
- ⊙ [Interpretations]

The trigger used to collect the data with.

Trigger specifics:

- ⊙ Prescales; typically unprescaled triggers are used, prescaled triggers for QCD / high stat measurements.
- ⊙ Trigger (in)efficiencies.

COMPONENTS OF A PHYSICS ANALYSIS

◎ Data-set and Monte Carlo samples

◎ Trigger

◎ Object definitions and event selections

◎ Backgrounds The exact definition of objects (electrons, muon, jets, ...) and how these are combined in selecting events to be analyzed.

◎ Systematics

◎ Statistical uncertainties ◎ “Flavor” of the identification (loose, medium, tight).

◎ Calibrations.

◎ Results

Event selection specifics:

◎ [Interpretation]

◎ Event cleaning (e.g. from noise and cosmics).

◎ Momentum, geom. acceptance and multiplicity of objects.

◎ Higher level cuts, such as invariant mass.

◎ “Signal regions”.

COMPONENTS OF A PHYSICS ANALYSIS

- ⊙ Data-set and Monte Carlo samples
- ⊙ Trigger
- ⊙ Object definitions and event selection
- ⊙ Background determination
- ⊙ Systematic uncertainties
- ⊙ Statistical methods
- ⊙ Results
- ⊙ [Interpretations]

Events that are imitating the signal we are searching for or measuring.

Background determination specifics:

- ⊙ Can/must be **data-driven** or **simulation-based**.
- ⊙ “**Validation regions**” and “**control regions**” required. These can use different triggers wrt signal regions.

COMPONENTS OF A PHYSICS ANALYSIS

- ◎ Data-set and Monte Carlo
 - ◎ Trigger
 - ◎ Object definitions and event selection
 - ◎ Background determination
 - ◎ Systematic uncertainties
 - ◎ Statistical methods
 - ◎ Results
 - ◎ [Interpretations]
- ◎ Any 'intermediate' measurement we have performed carries uncertainties (statistical and systematic).
 - ◎ **“Systematic” uncertainties are introduced by inaccuracies in the methods used to perform the measurement.**
 - ◎ Efficiencies, acceptance, number of events, luminosity, cross sections used in Monte Carlo scaling...
 - ◎ Some of them are “centrally” assessed by the performance groups of an experiment. Some of them are analysis-specific.

COMPONENTS OF A PHYSICS ANALYSIS

- © Data-set and Monte Carlo
- © Trigger
- © Object definitions and event selection
- © Background determination
- © Systematic uncertainties
- © Statistical methods
- © Results
- © [Interpretations]

Dealing with large data-sets, we use statistical methods to make sense of the numbers we measure.

Typical method:

- © Do a fit to extract signal from background.

Methodologies can vary a lot, but nowadays they are pretty unified within and across experiments.

COMPONENTS OF A PHYSICS ANALYSIS

- © Data-set and Monte Carlo
- © Trigger
- © Object definitions and event selection
- © Background determination
- © Systematic uncertainties
- © Statistical methods
- © Results
- © [Interpretations]

Dealing with large data-sets, we use statistical methods to make sense of the numbers we measure.

Typical method:

- © Do a fit to extract signal from background.

Methodologies can vary a lot, but nowadays they are pretty unified within and across experiments.

Neural nets and other machine learning methods are broadly used, primarily to improve signal over background discrimination!

COMPONENTS OF A PHYSICS ANALYSIS

- ◎ Data-set and Monte Carlo samples
- ◎ Trigger
- ◎ Object definitions and event selections
- ◎ Background determination
- ◎ Systematic uncertainties
- ◎ Statistical methods
- ◎ Results
- ◎ [Interpretations]

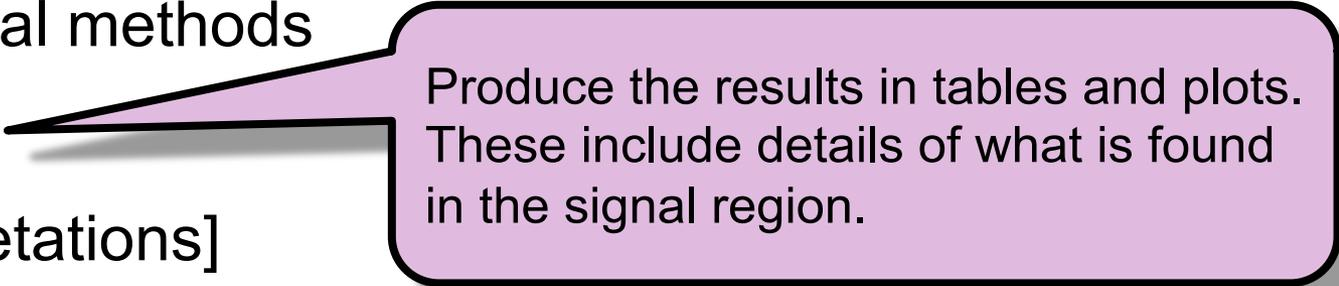

Produce the results in tables and plots. These include details of what is found in the signal region.

COMPONENTS OF A PHYSICS ANALYSIS

- ◎ Data-set and Monte Carlo samples
- ◎ Trigger
- ◎ Object definitions and event selections
- ◎ Background determination
- ◎ Systematic uncertainties
- ◎ Statistical methods
- ◎ Results
- ◎ [Interpretations]

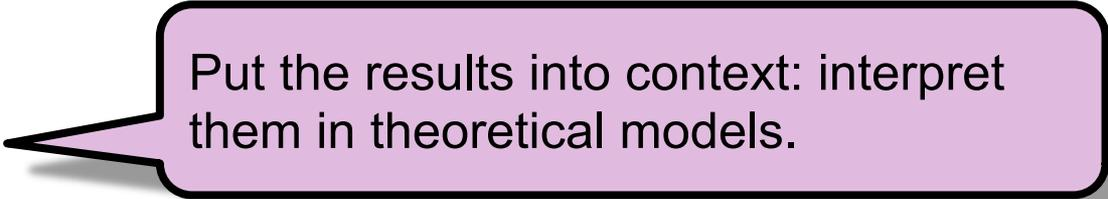

Put the results into context: interpret them in theoretical models.

CONCLUSIONS

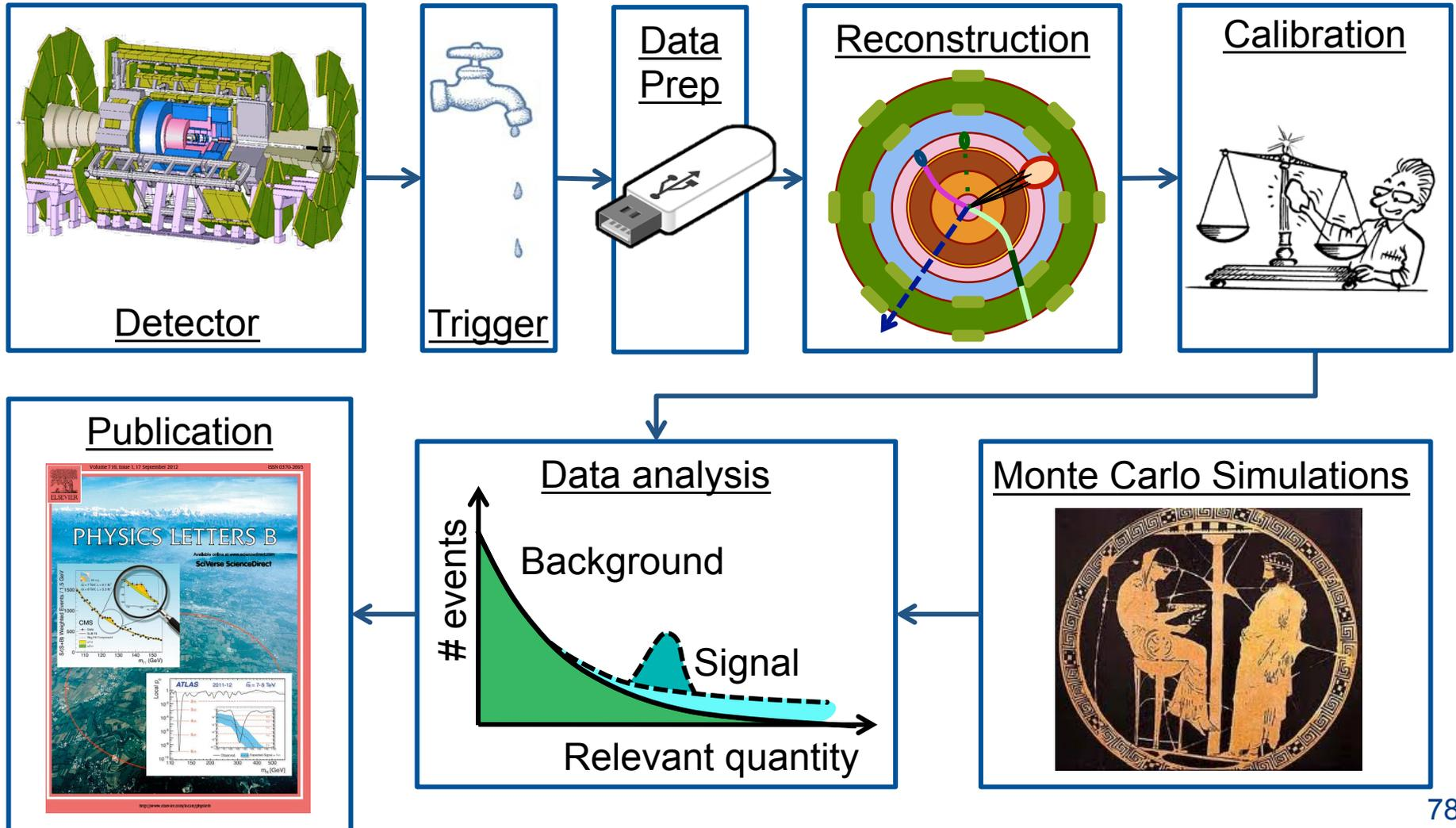

BACKUP

MEASURING Z^0 CROSS-SECTION AT LHC

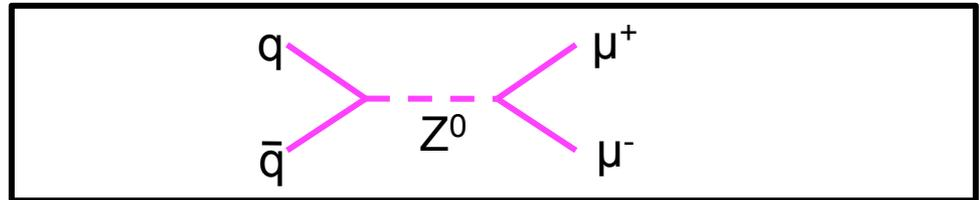
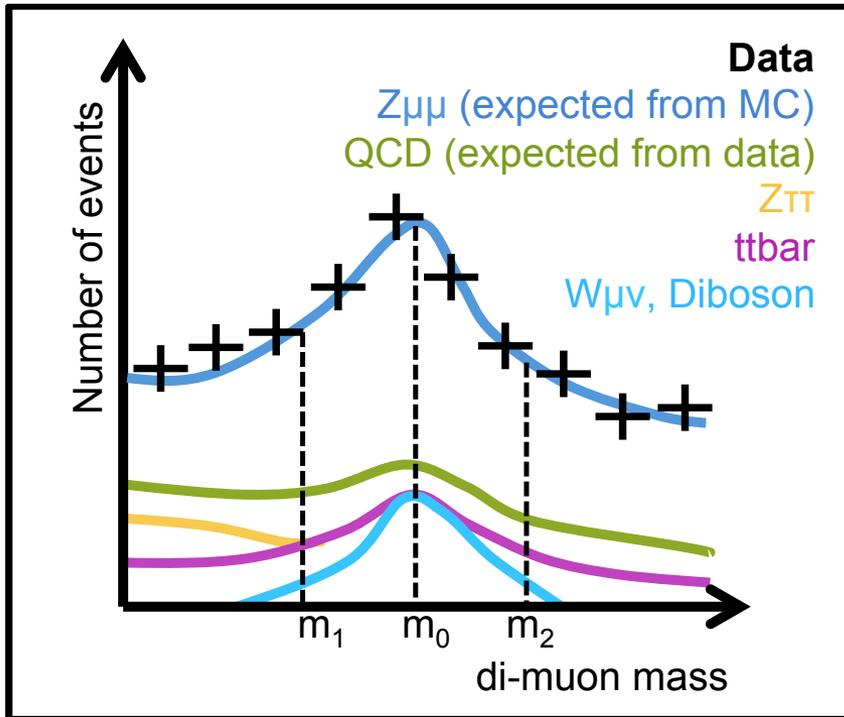

$$\sigma \cdot \text{BR} = \frac{\text{Number of events}}{\alpha \cdot \epsilon \cdot L}$$

N of events
 = N events on data – N expected background events
 α – acceptance
 = fraction of events passing selection requirements
 ϵ – efficiency
 = reconstruction efficiency of relevant objects

THE DATA ACQUISITION

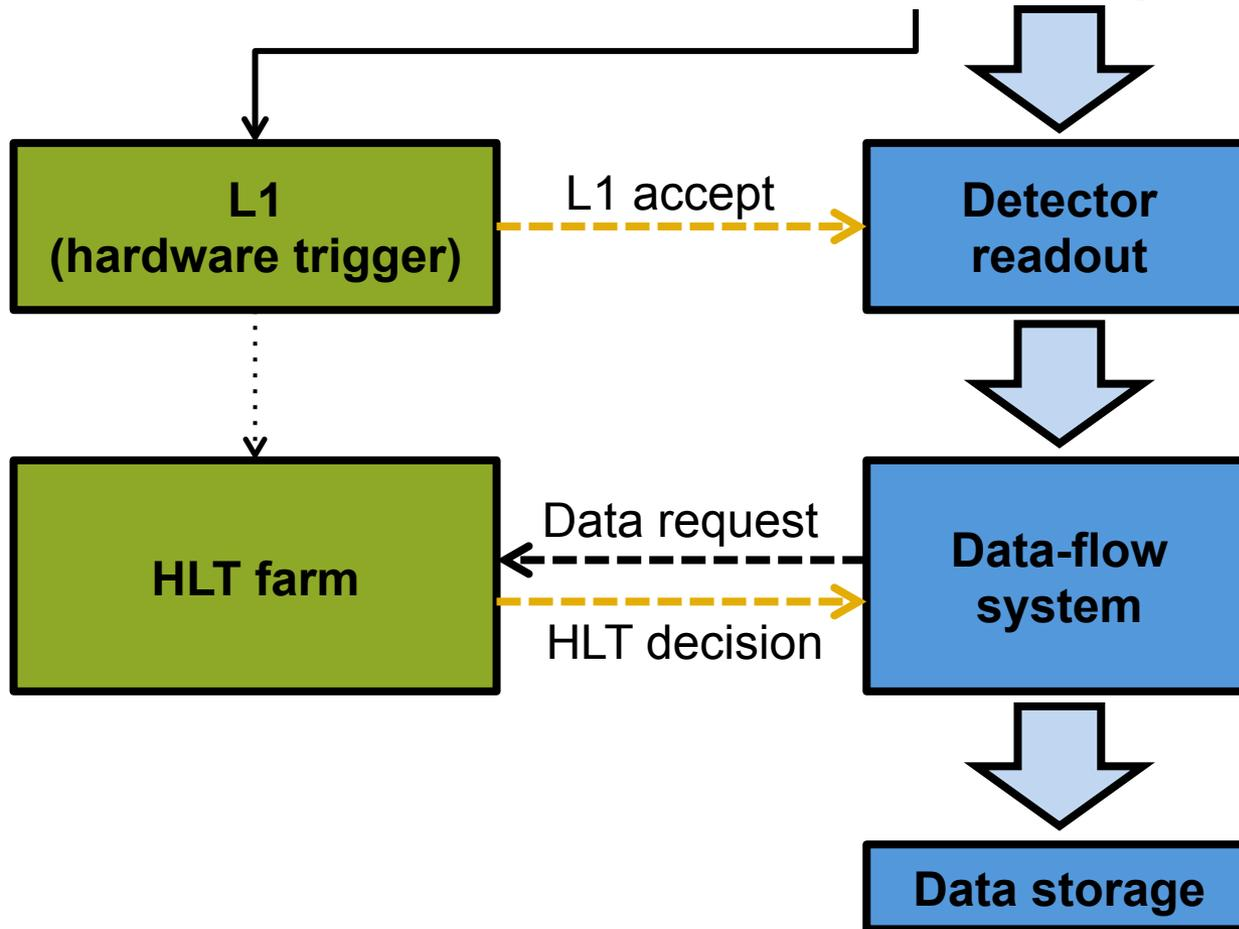
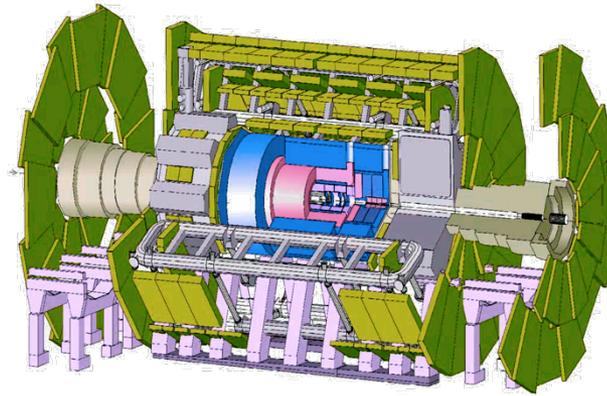

THE DATA ACQUISITION

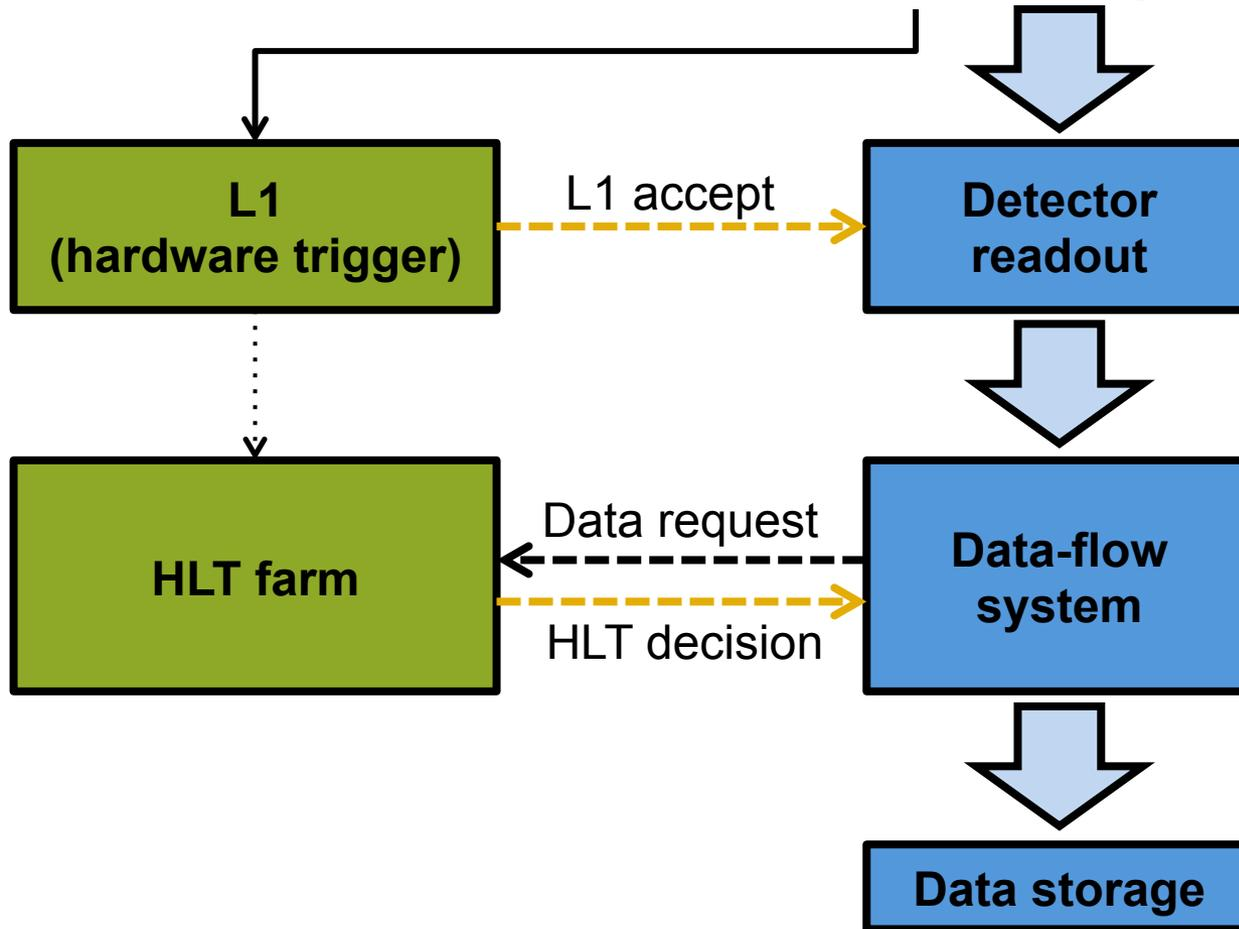
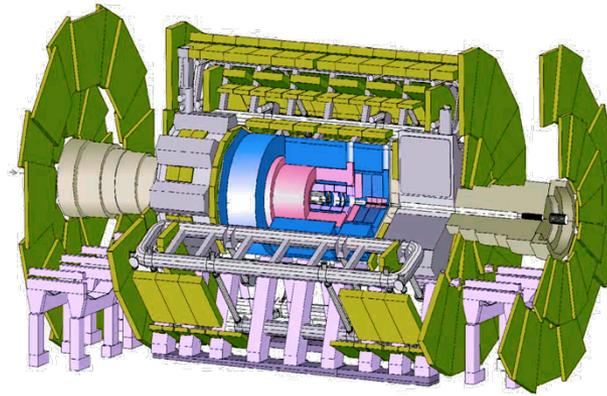

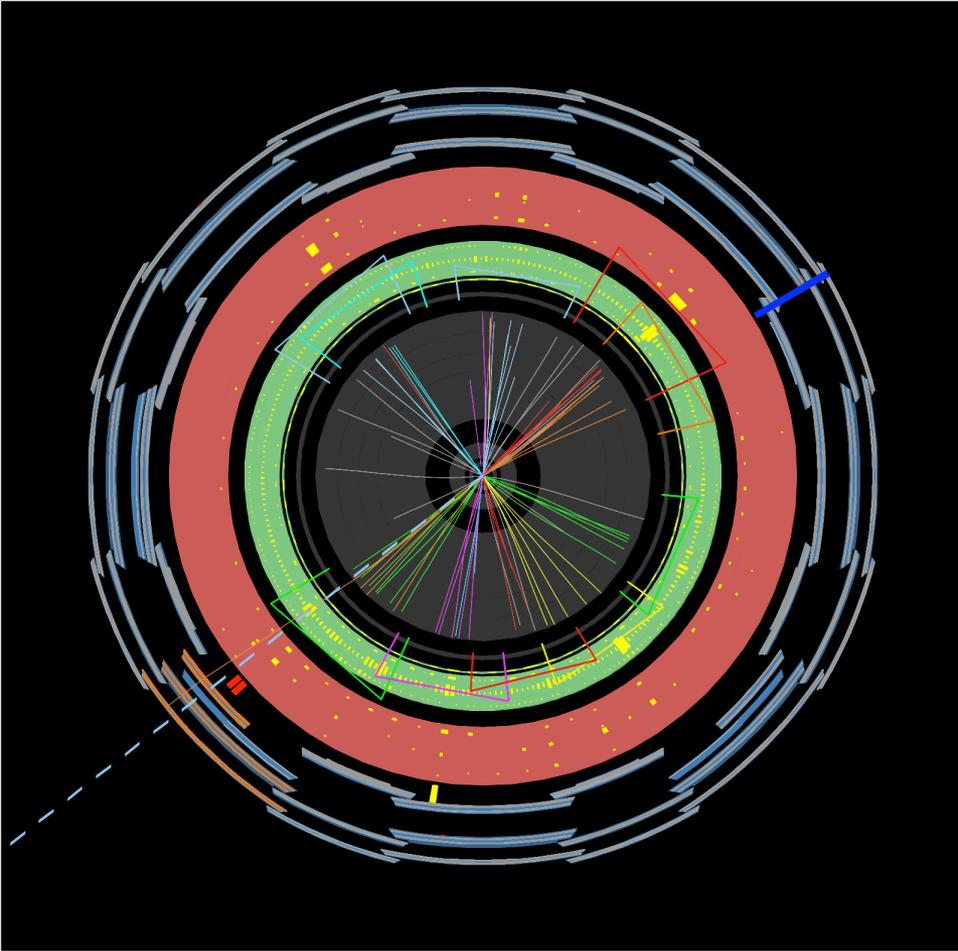

Run Number: 208781, Event Number: 39013006

Date: 2012-08-17 21:16:47 CEST

10 jets
with $p_T > 50\text{ GeV}$
 $ME_T = 120\text{ GeV}$

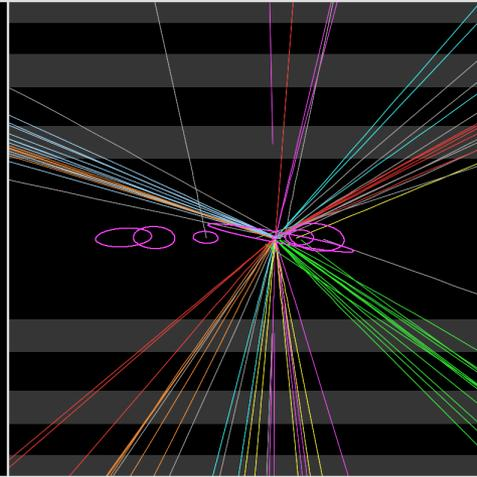
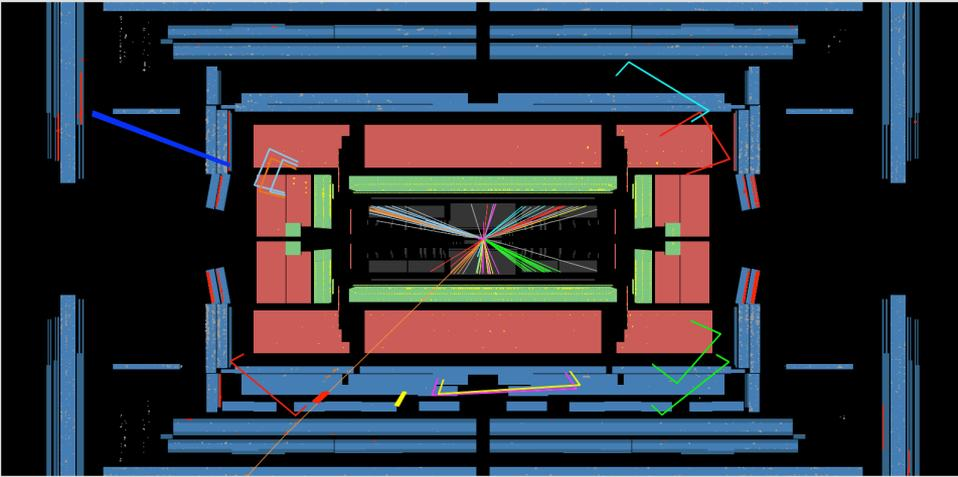
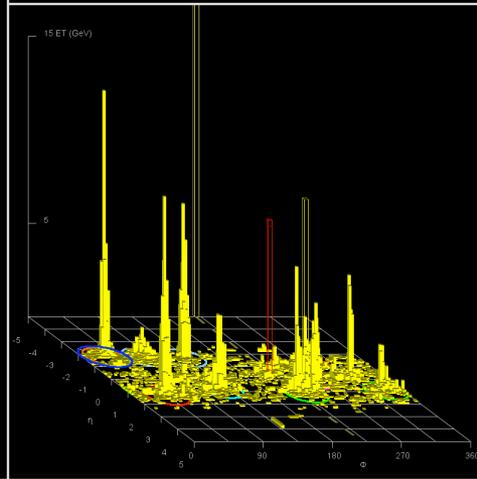

IN A P-P COLLISION

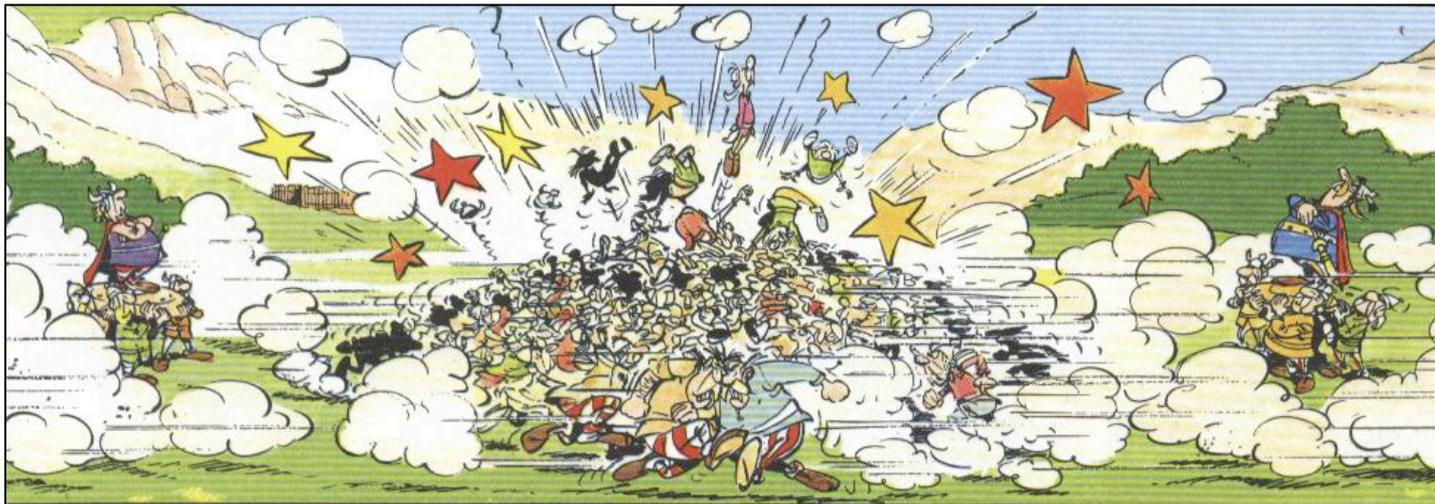
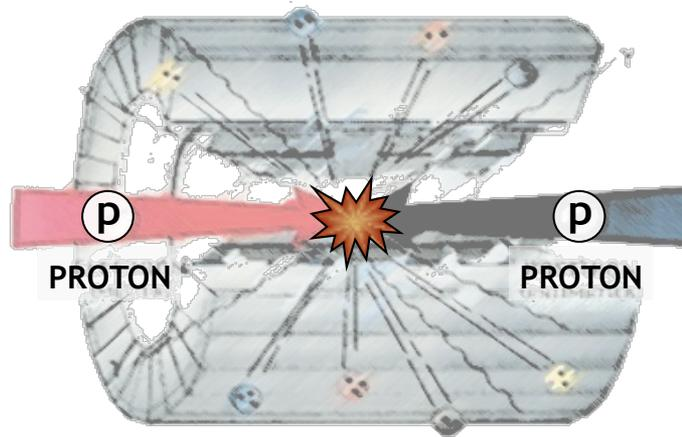

MISSING TRANSVERSE MOMENTUM

Impossible to measure particles that don't interact in the detector.

➤ Instead, measure everything else & require momentum conservation in the transverse plane.

⊙ Sensitive to pile-up and detector problems.

Only as good as its inputs.

⊙ Use calibrated physics objects: electrons, photons, muons, taus, jets.

⊙ Add remaining soft energy.

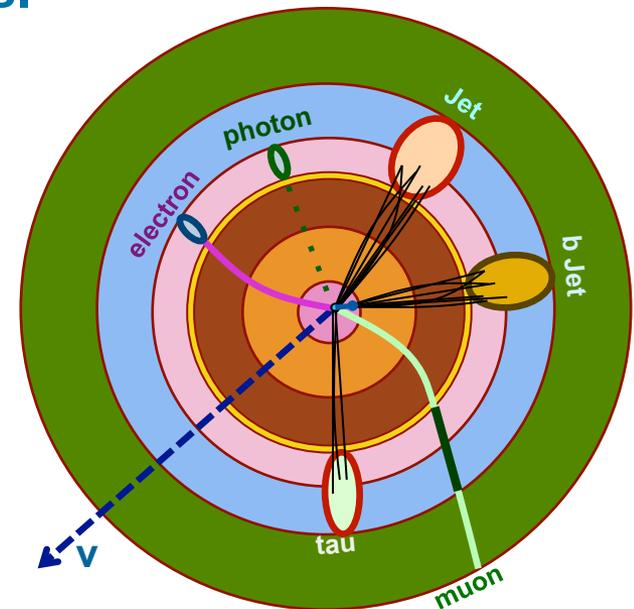

MISSING ET – PILEUP & TAILS

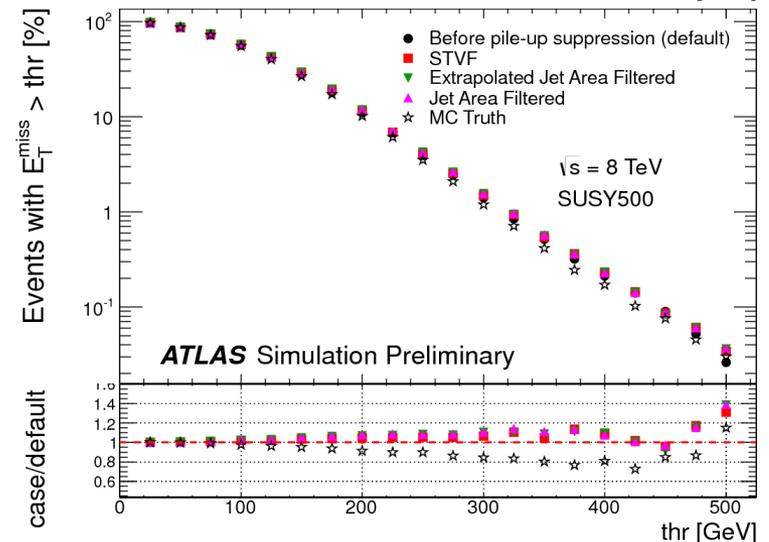
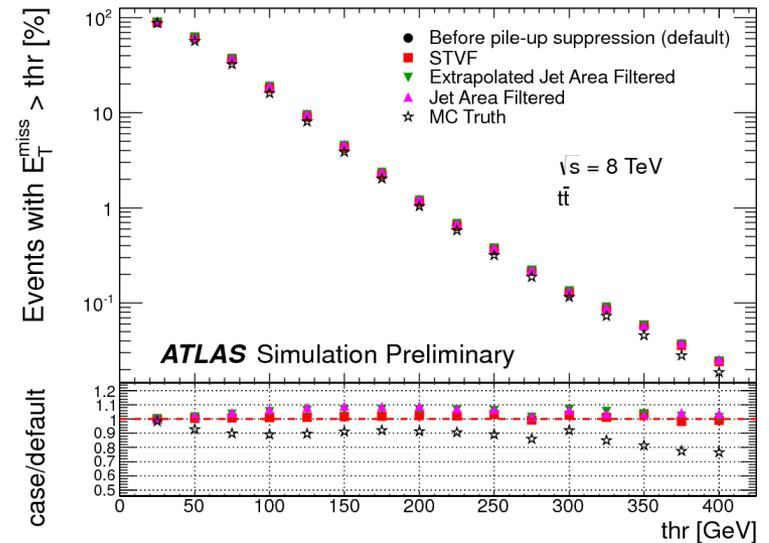
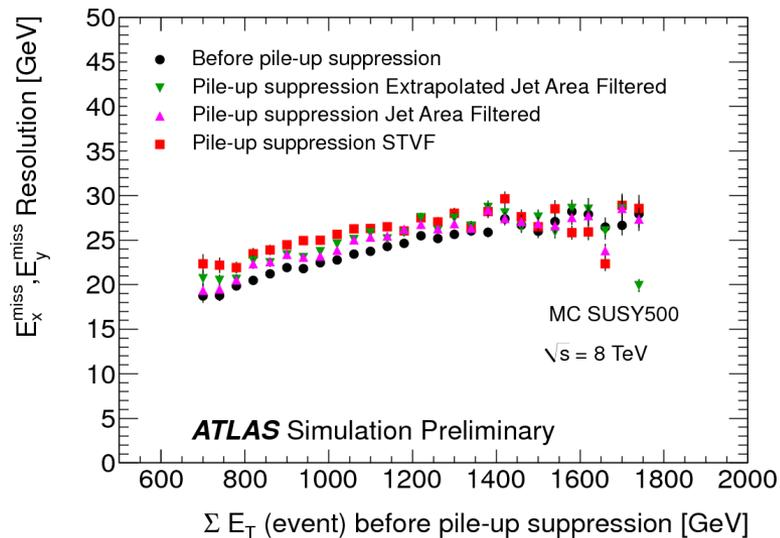
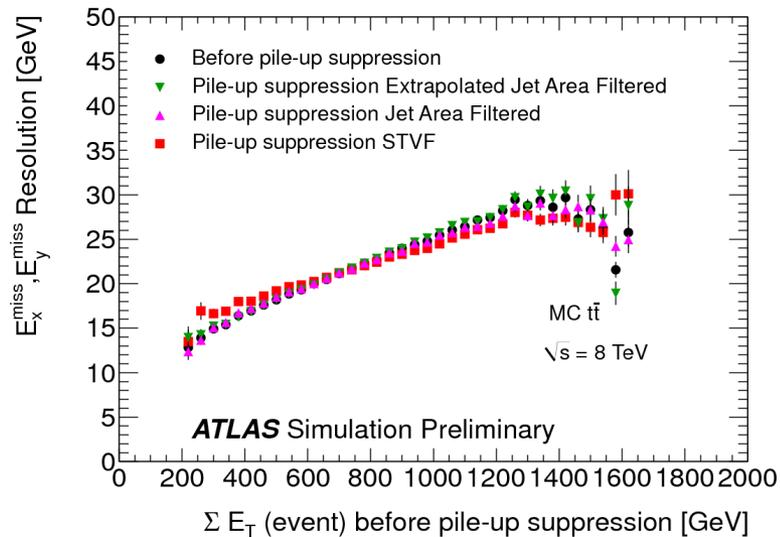

GRAND ATLAS (non-BSM) PHYSICS SUMMARY

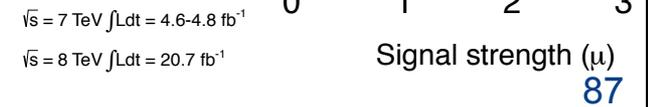
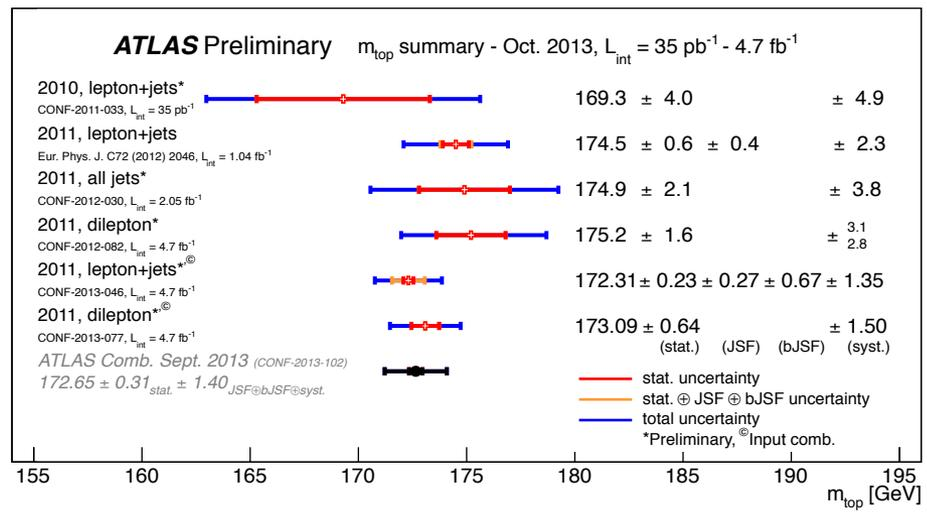
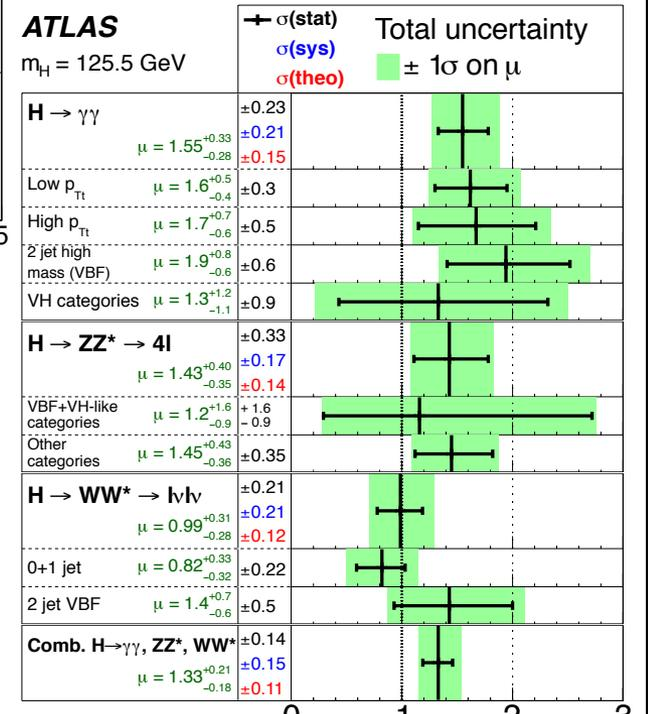
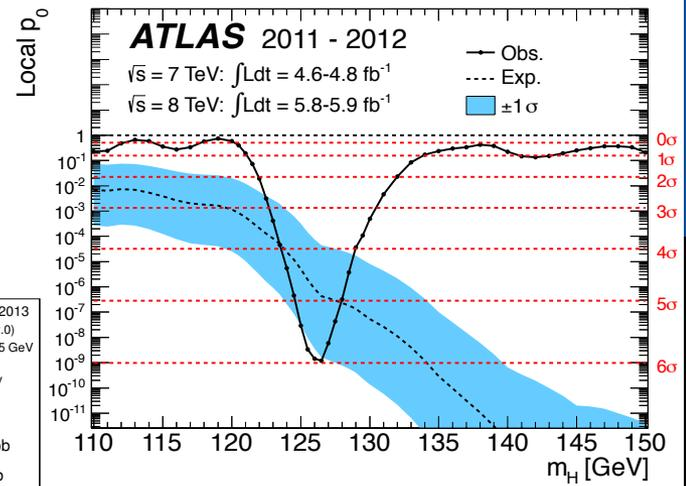
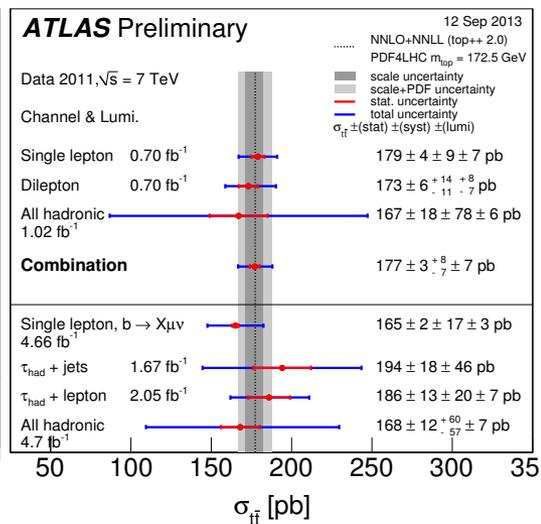
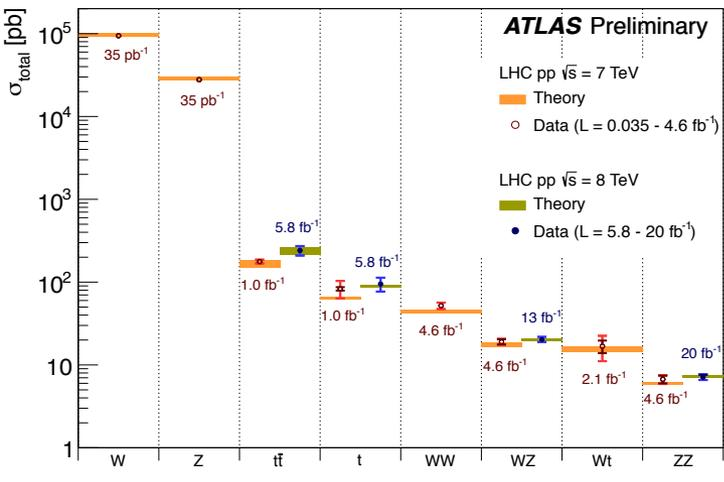

B-JET

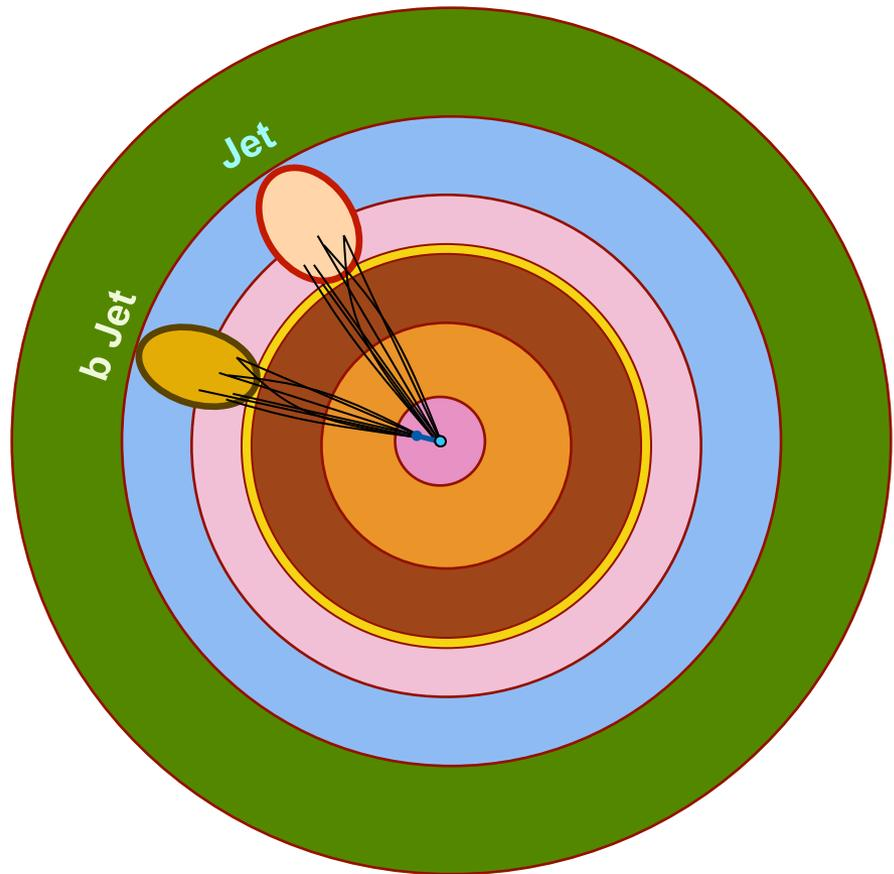

TRIGGER MENUS FOR SUSY

Selection	EF trigger election	EF Avg. Rate (Hz) $L_{\text{avg}}=5e33/\text{cm}^2\text{s}$
Single jet & E_T^{miss}	Jet $E_T > 145$ GeV & EF-only $E_T^{\text{miss}} > 70$ GeV	8
Single jet & E_T^{miss} & $\Delta\phi(\text{jet}, E_T^{\text{miss}})$	Jet $E_T > 80$ GeV & $E_T^{\text{miss}} > 70$ GeV & $\Delta\phi > 1.0$ rad	8
H_T	> 700 GeV	8
Single electron & E_T^{miss}	Electron $p_T > 25$ GeV & EF-only $E_T^{\text{miss}} > 35$ GeV	26
Single muon & single jet & E_T^{miss}	Muon $p_T > 24$ GeV & jet $E_T > 65$ GeV & EF-only $E_T^{\text{miss}} > 40$ GeV	15
Single photon & E_T^{miss}	Photon $p_T > 40$ GeV & EF-only $E_T^{\text{miss}} > 60$ GeV	5
3 electrons	$p_T > 18, 2 \times 7$ GeV	<1
3 muons	$p_T > 18, 2 \times 4$ GeV	<1
3 electrons & muons	$p_T > 2 \times 7$ (e), 6 (μ) GeV	<1
	$p_T > 7$ (e), 2×6 (μ) GeV	<1

'DELAYED' TRIGGERS

Trigger	EF trigger Selection	
	Prompt Stream	Delayed Stream
Multi-jets	4×80 GeV	4×65 GeV
	5×55 GeV	5×45 GeV
	6×45 GeV	
H_T	700 GeV	500 GeV
Single jet ($R = 1.0$)	460 GeV	360 GeV
E_T^{miss}	80 GeV	60 GeV

STANDARD MODEL SUMMARY

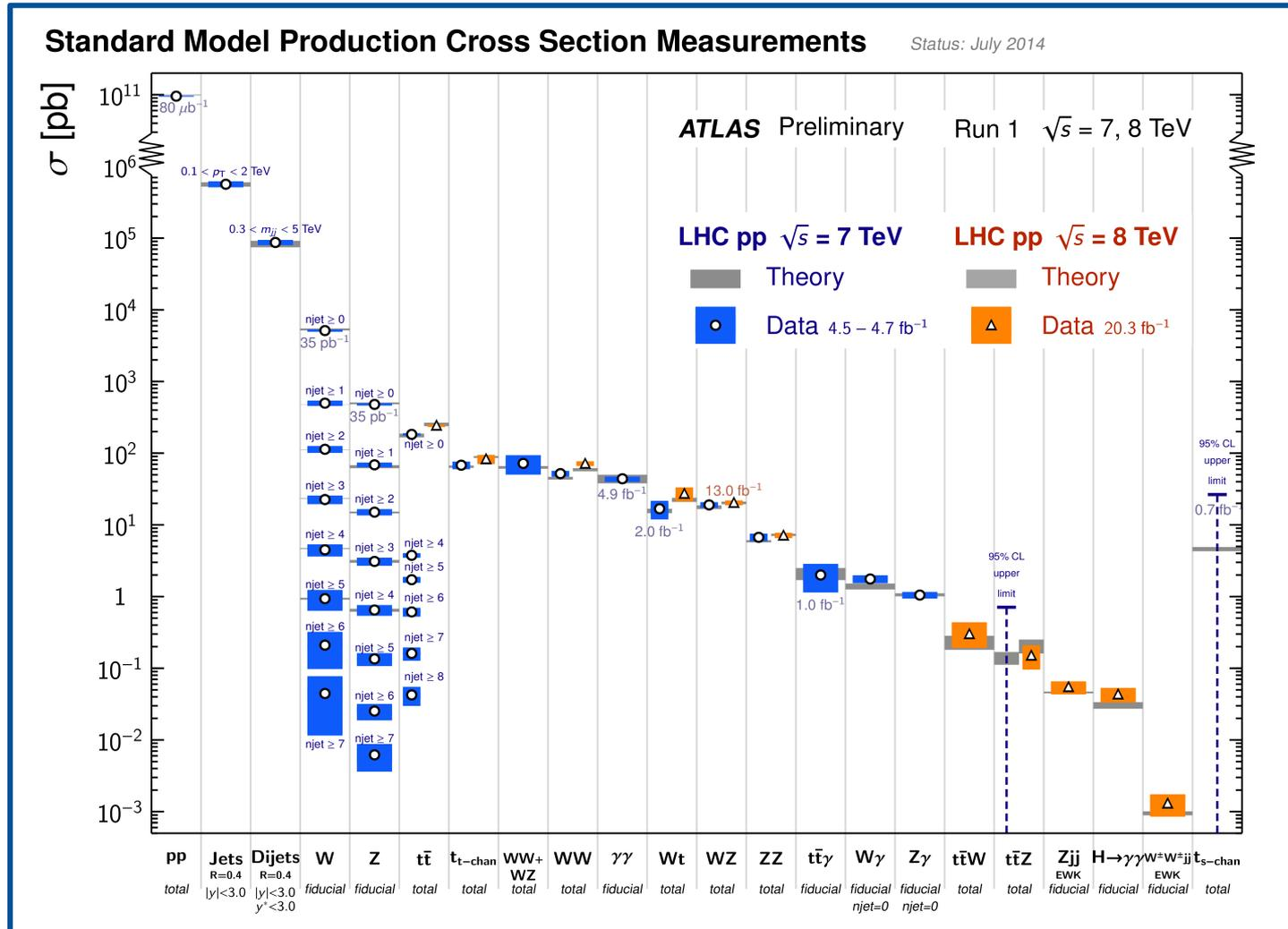

THE SUSY MULTIJET SEARCH

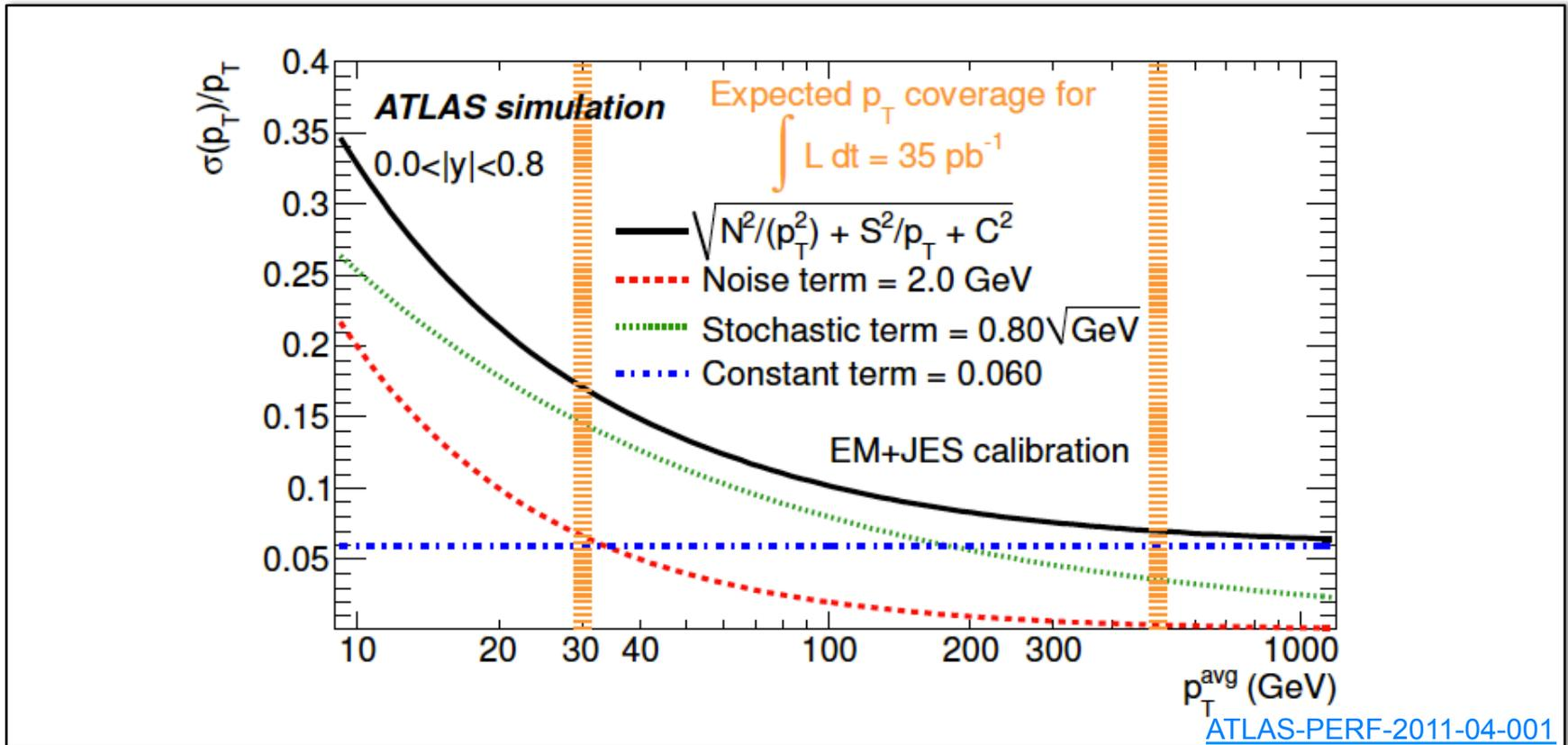

Why $ME_T/\sqrt{H_T}$?

⇒ a measure of ME_T in units of standard deviations of the fake ME_T

$$\frac{\sigma_{p_T}}{p_T} = \frac{N}{p_T} \oplus \frac{S}{\sqrt{p_T}} \oplus C$$

MULTI-JET BACKGROUND

Flavour stream

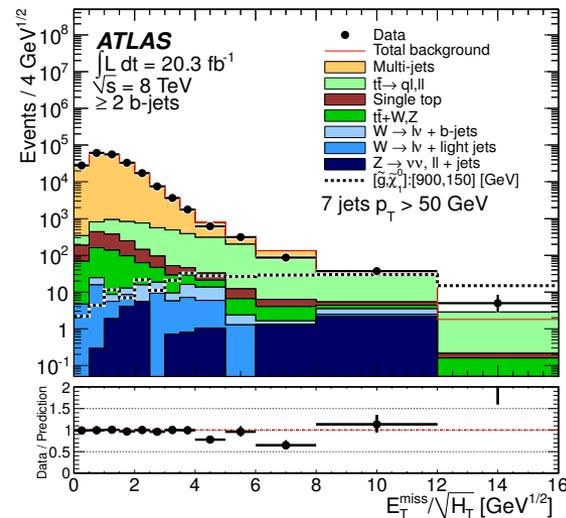
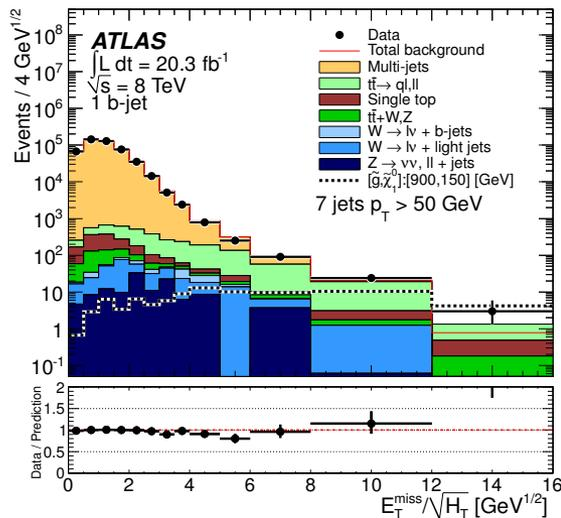
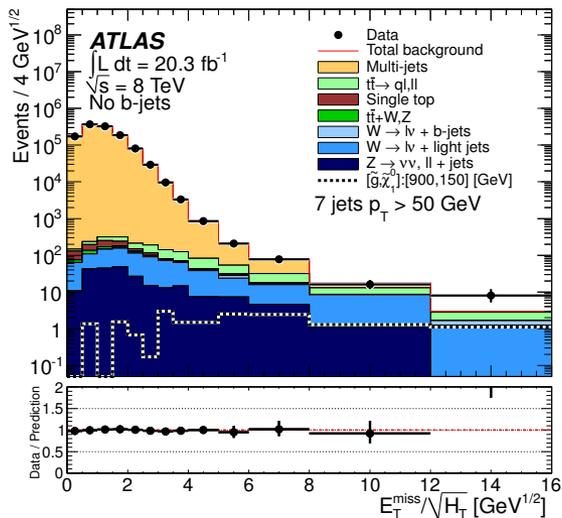

MJ stream

Template extracted from '6j50' and validated in '7j50'

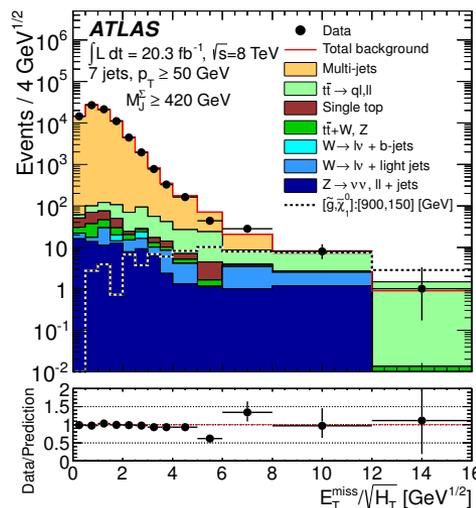
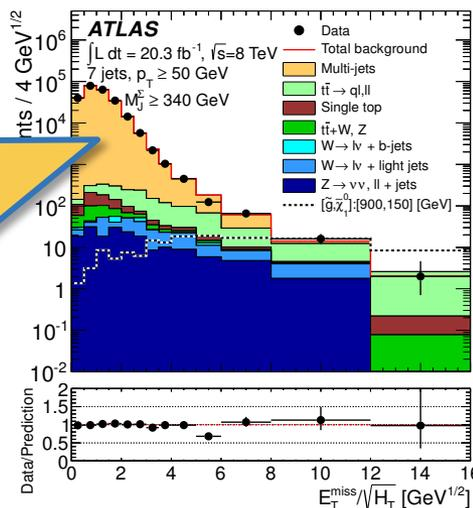

Discrepancies in control regions become uncertainties – dominant, on top of heavy flavour and 'leptonic' backgrounds.

LEPTONIC BACKGROUNDS

- © ttbar (non-full-hadronic) + jets and W/Z + jets.
- © Scale MC in control regions in data (through a multi-bin fit).

Single-lepton validation region	
Lepton p_T	$> 25 \text{ GeV}$
Lepton multiplicity	Exactly one, $\ell \in \{e, \mu\}$
E_T^{miss}	$> 30 \text{ GeV}$
$E_T^{\text{miss}}/\sqrt{H_T}$	$> 2.0 \text{ GeV}^{1/2}$
m_T	$< 120 \text{ GeV}$
Jet p_T	As for signal regions (table 1)
Jet multiplicity	
b -jet multiplicity	
M_J^Σ	
Control region (additional criteria)	
Jet multiplicity	Unit increment if $p_T^\ell > p_T^{\text{min}}$
$E_T^{\text{miss}}/\sqrt{H_T (+p_T^\ell)}$	$> 4.0 \text{ GeV}^{1/2}$

Two-lepton validation region	
Lepton p_T	$> 25 \text{ GeV}$
Lepton multiplicity	Exactly two, ee or $\mu\mu$
$m_{\ell\ell}$	80 GeV to 100 GeV
Jet p_T	As for signal regions (table 1)
Jet multiplicity	
b -jet multiplicity	
M_J^Σ	
Control region (additional criteria)	
$ \mathbf{p}_T^{\text{miss}} + \mathbf{p}_T^{\ell_1} + \mathbf{p}_T^{\ell_2} /\sqrt{H_T}$	$> 4.0 \text{ GeV}^{1/2}$

- © Uncertainties dominating the leptonic background determination: JES/JER, b -tagging, pile-up and theory.

LEPTONIC BACKGROUND

Flavour stream

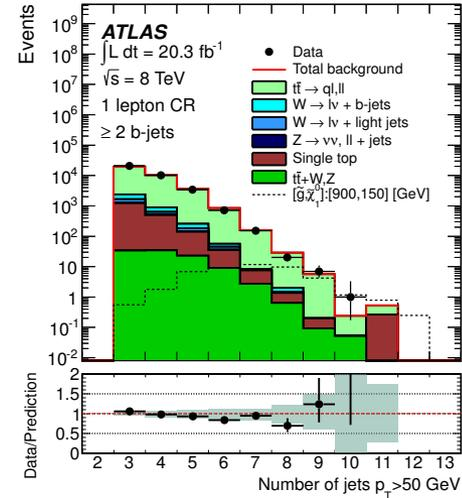
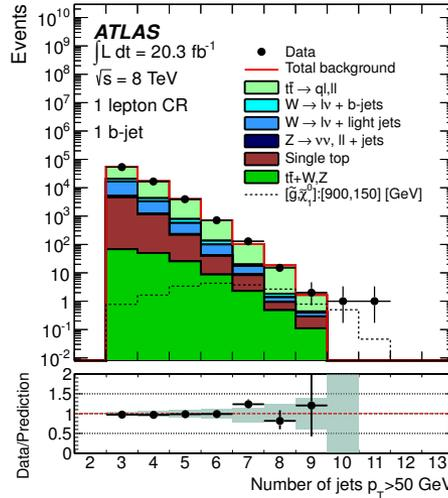
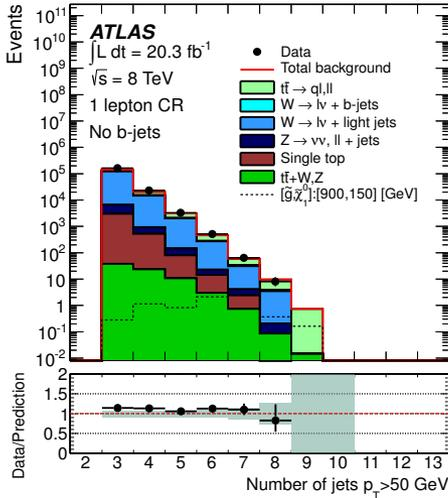

MJ stream

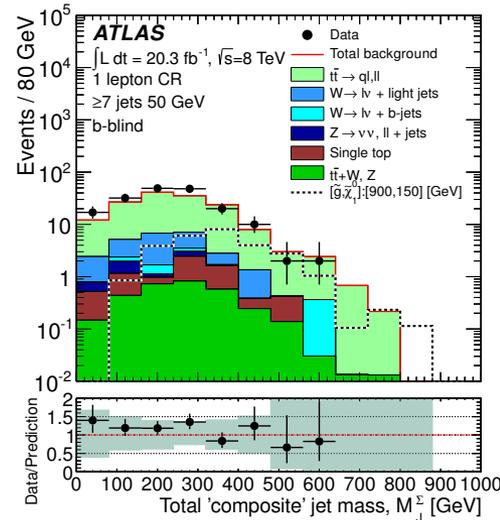
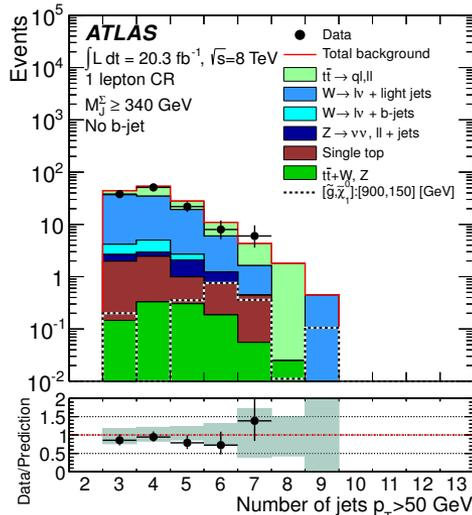

Uncertainties dominating the leptonic background determination: JES/JER, b-tagging, pile-up and theory.

THE STATISTICAL TREATMENT

Flavour stream

Simultaneous fit in the 'j50' and 'j80' signal regions separately.

- © **ttbar & W+jets:** one control region per signal region.
Normalization allowed to vary freely in the fit.
- © **Other less significant backgrounds;** determined using MC.
Constrained by their uncertainties.
- © **Multijet background;** not constrained by control regions.
Constrained by its uncertainties.

MJ stream

A fit performed in each signal region to adjust the normalization of ttbar and W backgrounds.

INTERPRETATIONS

'Real models'

© A minimal model, **Constraint Minimal SUSY (CMSSM)** (mSugra, i.e. gravity-mediated, based) only has 5 free parameters:

- Scalar mass parameter, m_0
- Gaugino mass parameter, $m_{1/2}$
- Trilinear Higgs-sfermion-sfermion coupling, A_0
- Ratio of Higgs vacuum expectation values, $\tan\beta$
- Sign of SUSY Higgs parameter, $\text{sign}(\mu)$

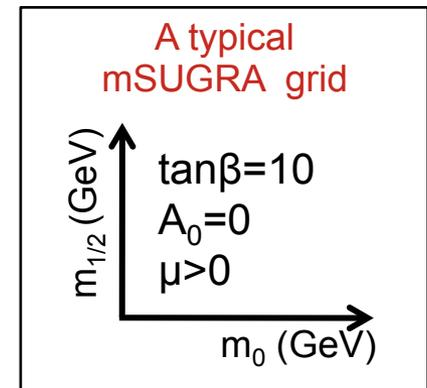

'Simplified models'

© **Simplified topologies with typically one production and one decay process. Provide useful information for theorists.**

INTERPRETATIONS

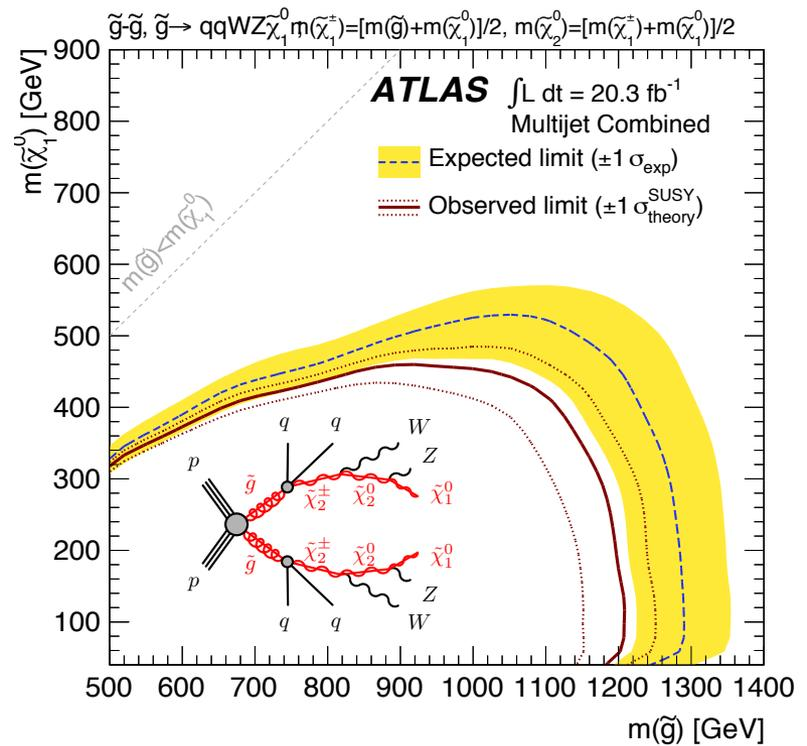
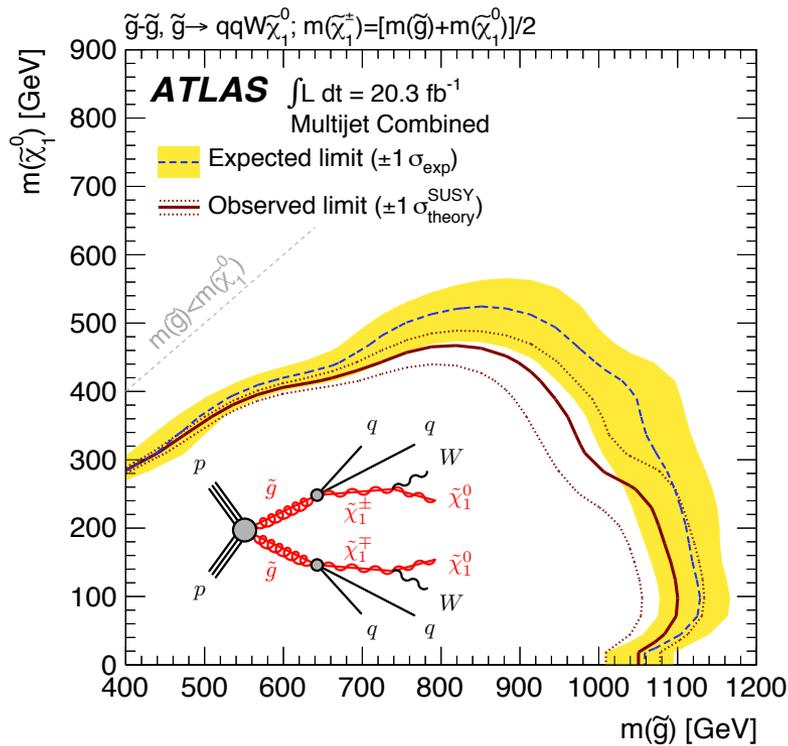

INTERPRETATIONS

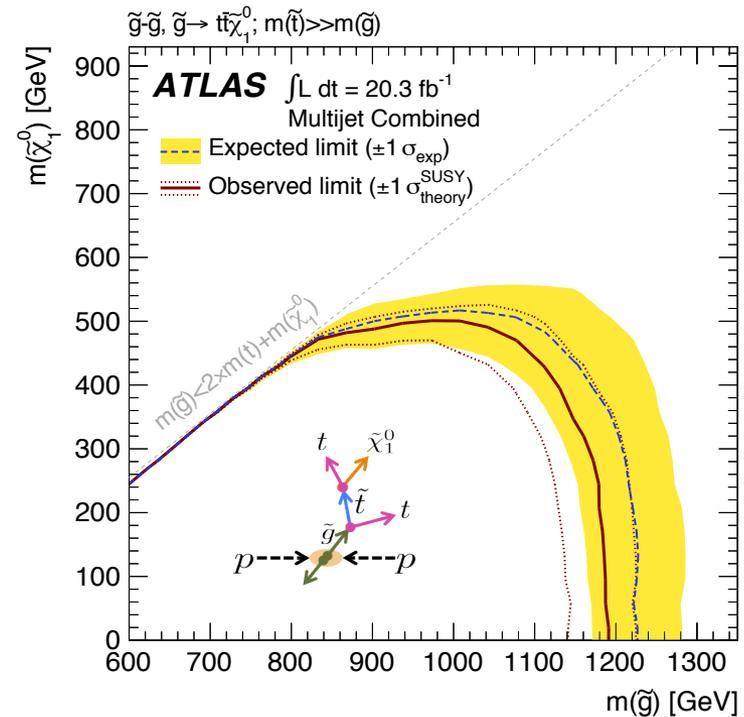
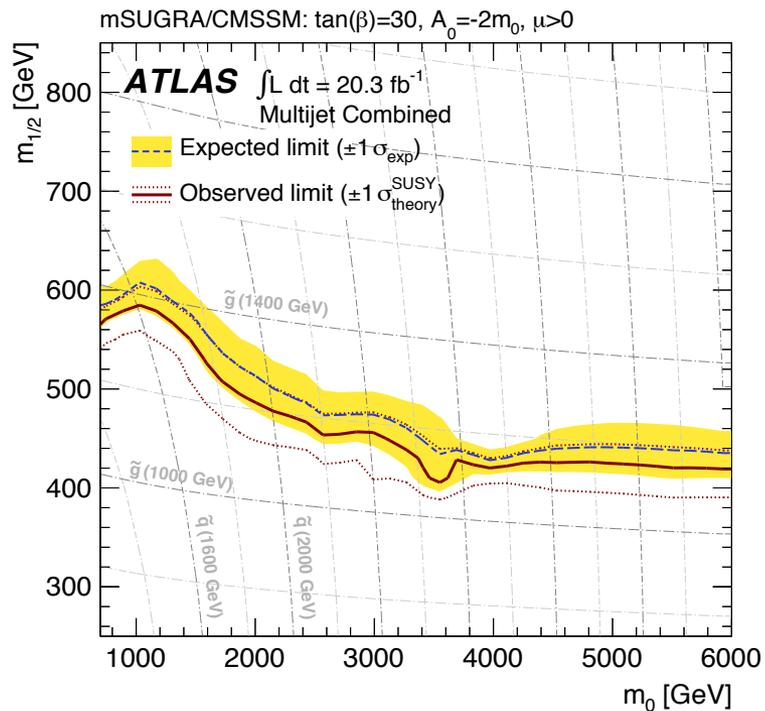

INTERPRETATIONS

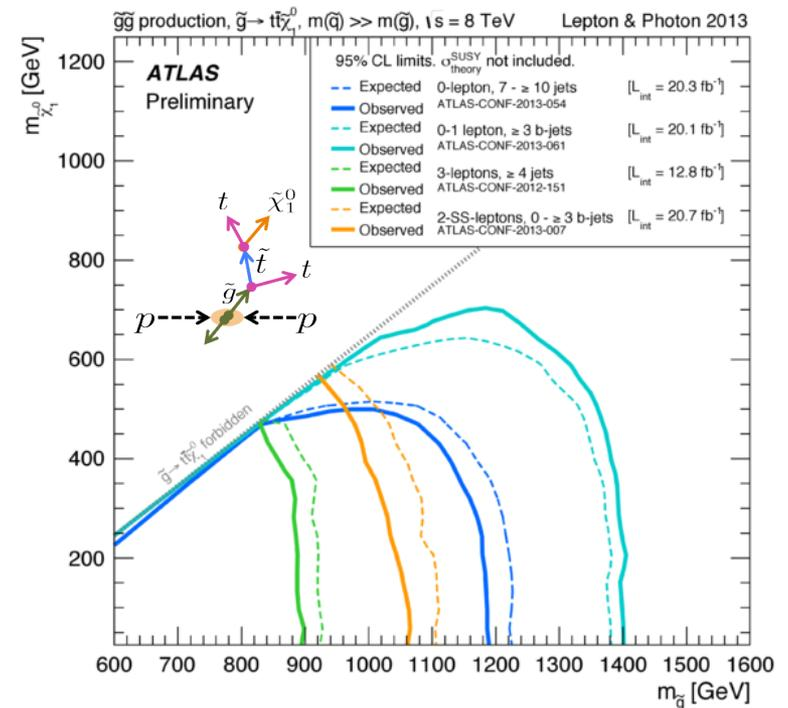
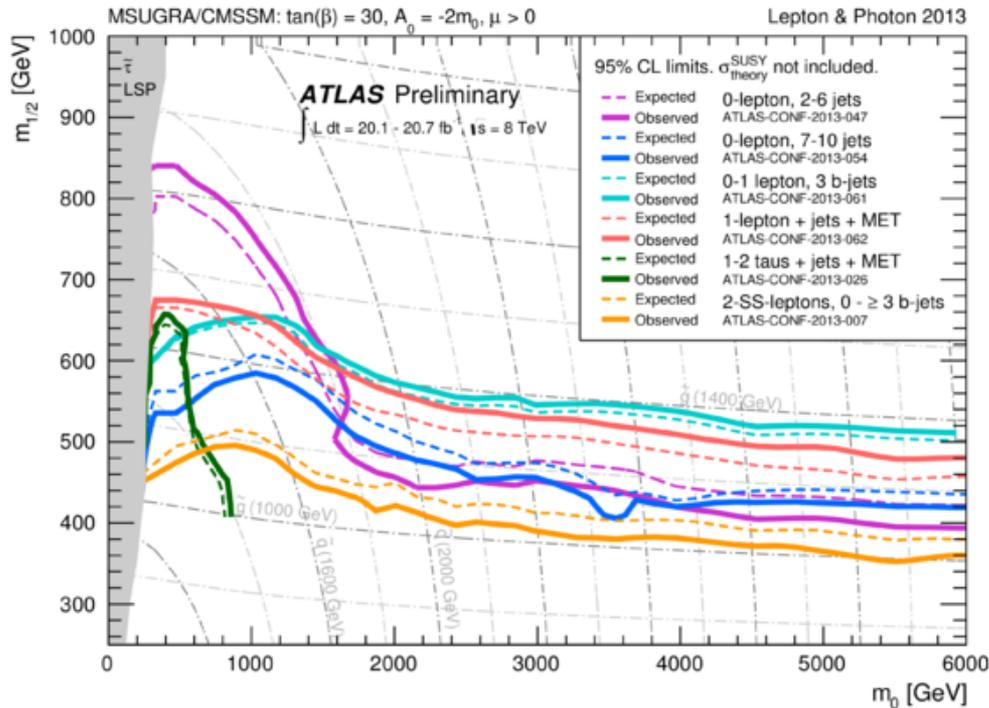

- ⊙ Note that the multijet analysis is not optimized for a specific model, it is built to be as model-independent as possible.
- ⊙ Multijet analysis is strong in other simplified models, e.g. gluino pair production via 2-step decay to 12 jets.

QCD BACKGROUNDS IN SUSY

All (SUSY) analyses use data-driven methods for assessing multi-jet SM production.

Monte Carlo can not be used when large multiplicities are involved:

- ⊙ Inclusive multi-jet / multi-parton samples provided by Monte Carlo generators recently only.
 - ⊙ E.g. only very latest Sherpa release provides NLO calculations up to four jets.
- ⊙ Monte Carlo predictions have not yet been validated with multi-jet data.
- ⊙ **Detailed comparisons between data and various Monte Carlo generators and theoretical predictions would provide extremely useful input to the theory community in understanding QCD.**
 - ⊙ They would also provide a great understanding of a dominant SUSY background in view of run2.

E.G. FOUR-JET TOPOLOGIES & OBSERVABLES

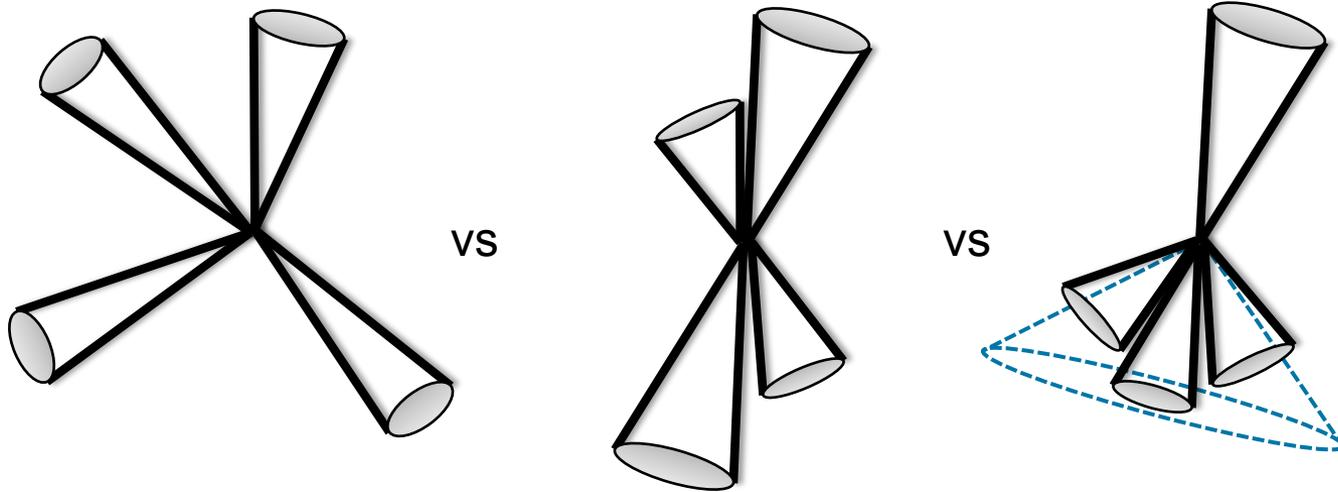

Category	Variable
Simple kinematic & ratios	$p_T, \eta, \phi, HT, p_{T_i}/p_{T_j}$
Angles	$\Delta\eta_{ij}, \Delta\phi_{ij}, \Delta R_{ij}$
Masses & ratios	$m_{ij}, m_{ijk}, m_4, m_i/m_{ij}, m_i/m_{ijk}, m_i/m_4$
Event shapes	$\Sigma p_T^2 / \Sigma p^2$

E.G. FOUR-JET TOPOLOGIES & OBSERVABLES

Name	Definition	Comment
p_{Ti}	Transverse momentum of the i th jet	} Sorted descending in p_T
Y_i	Rapidity of the i th jet	
H_T	$\sum_{i=1}^4 p_{Ti}$	Scalar sum of the p_T of the four jets
M_{jjjj}	$\left(\sum_{i=1}^4 E_i\right)^2 - \left(\sum_{i=1}^4 \mathbf{p}_i\right)^2$	Invariant mass of the four jets
M_{jj}^{\min}	$\min_{\substack{i,j \in [1,4] \\ i \neq j}} \left((E_i + E_j)^2 - (\mathbf{p}_i + \mathbf{p}_j)^2 \right)$	Minimum invariant mass of any two jets
$\Delta\phi_{ij}^{\min}$	$\min_{\substack{i,j \in [1,4] \\ i \neq j}} (\phi_i - \phi_j)$	Min azimuthal separation of two jets
ΔY_{ij}^{\min}	$\min_{\substack{i,j \in [1,4] \\ i \neq j}} (Y_i - Y_j)$	Min rapidity separation of two jets
$\Delta\phi_{ijk}^{\min}$	$\min_{\substack{i,j,k \in [1,4] \\ i < j < k}} (\Delta\phi_{ij} + \Delta\phi_{jk})$	Min azimuthal separation between three jets
ΔY_{ijk}^{\min}	$\min_{\substack{i,j,k \in [1,4] \\ i < j < k}} (\Delta Y_{ij} + \Delta Y_{jk})$	Min rapidity separation between three jets
ΔY_{ij}^{\max}	$\Delta Y_{ij}^{\max} = \max_{i,j \in [1,4]} (Y_i - Y_j)$	Max rapidity difference between two jets
$\Sigma p_T^{\text{central}}$	Sum of p_T of the two central-rapidity jets	Excludes jets having ΔY_{ij}^{\max}

E.G. FOUR-JET MONTE CARLO SAMPLES

Name	Hard process	PDF	Parton shower	Underlying event	Tune
Pythia8-CT10	PYTHIA 8	CT10	PYTHIA 8	PYTHIA 8	AU2-CT10
Pythia8-CTEQ6L1	PYTHIA 8	CTEQ6L1(†)	PYTHIA 8	PYTHIA 8	AU2-CTEQ6L1
Herwig++	Herwig++	CTEQ6L1	Herwig++	Herwig++	UE-EE-3-CTEQ6L1
Alpgen+Herwig	Alpgen	CTEQ6L1	HERWIG 6	JIMMY	AUET2-CTEQ6L1
Alpgen+Pythia	Alpgen	CTEQ6L1	PYTHIA 6	PYTHIA 6	Perugia 2011C
Madgraph+Pythia	Madgraph	CTEQ6L1	PYTHIA 6	PYTHIA 6	AUET2B-CTEQ6L1
Sherpa	Sherpa		Sherpa	Sherpa	

Table 2: The different Monte Carlo generators used for comparison against the data are listed, together with the parton distribution functions, parton shower algorithms, underlying event and parameter tunes. (†) The Pythia8-CT6L1 sample uses CT10 when calculating the Matrix Element but CTEQ6L1 when simulating the parton shower and underlying event. The first listed sample (Pythia8-CT10) is used for the deconvolution of detector effects.

THE ATLAS TRIGGER SYSTEM

Rate (2012 conditions)

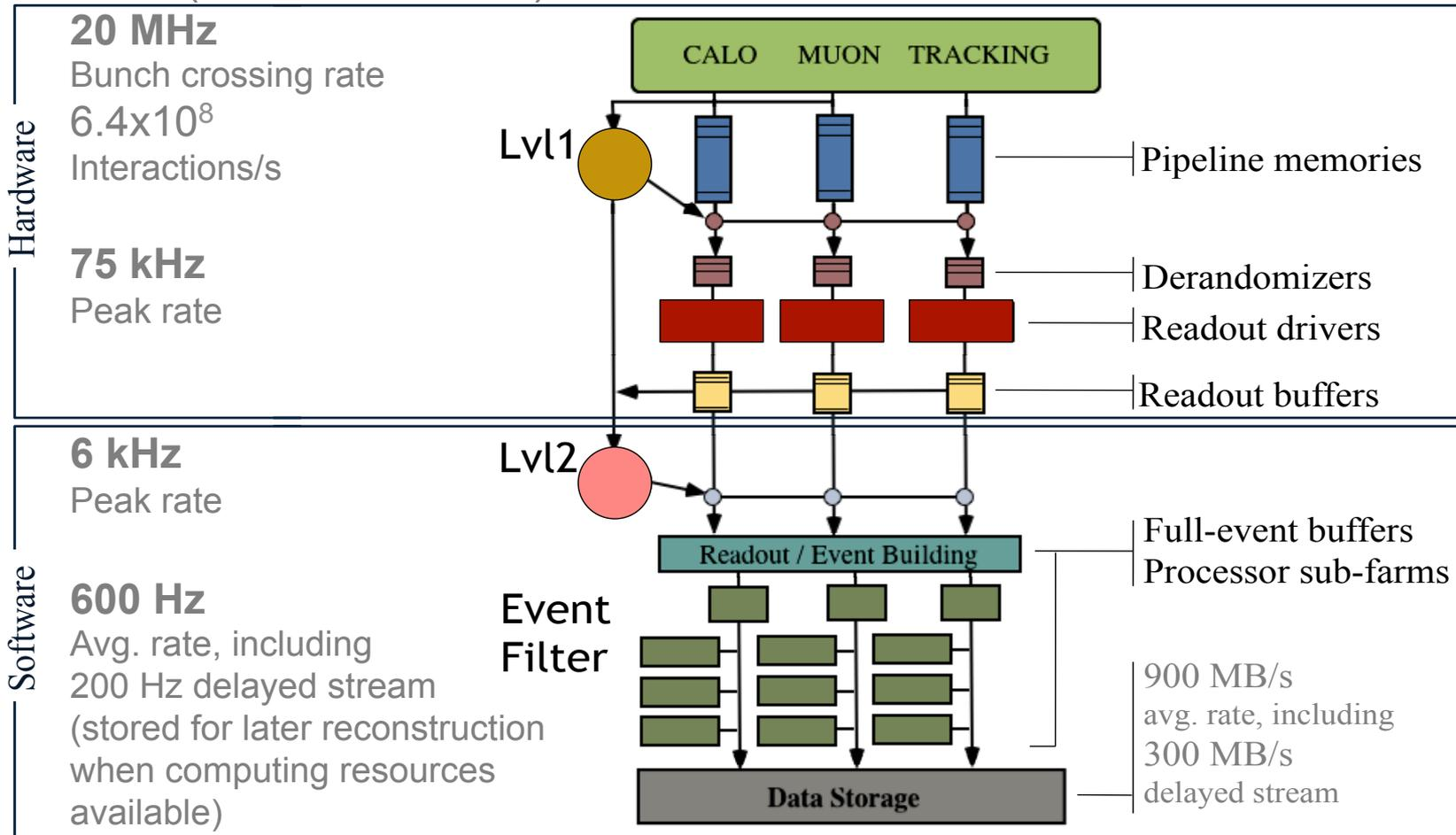

TRIGGER

Signal triggers		
Jet Multiplicity	pT cut	$ \eta $
6	45	3.2
5	55	

Background/support triggers	
Type	Purpose
Multijet (prescaled)	Efficiencies & Control regions
Single lepton	Control regions

Multijet trigger improvements in 2012

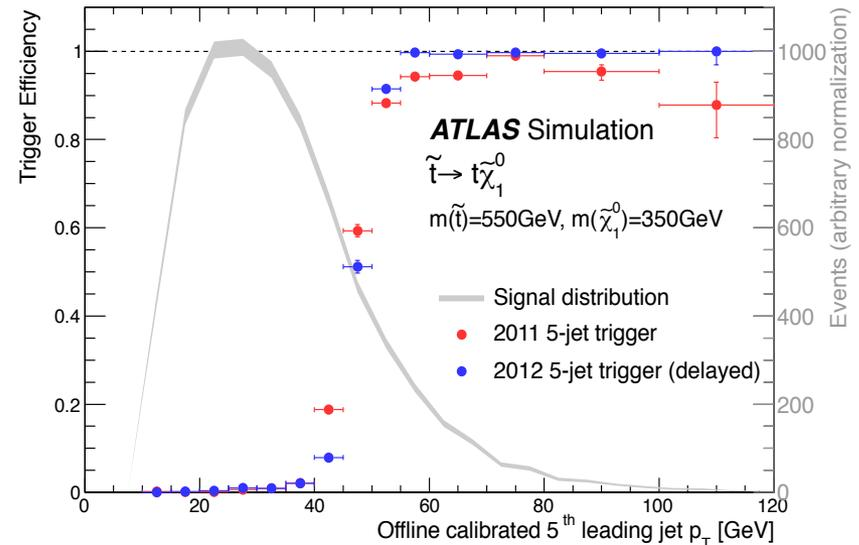
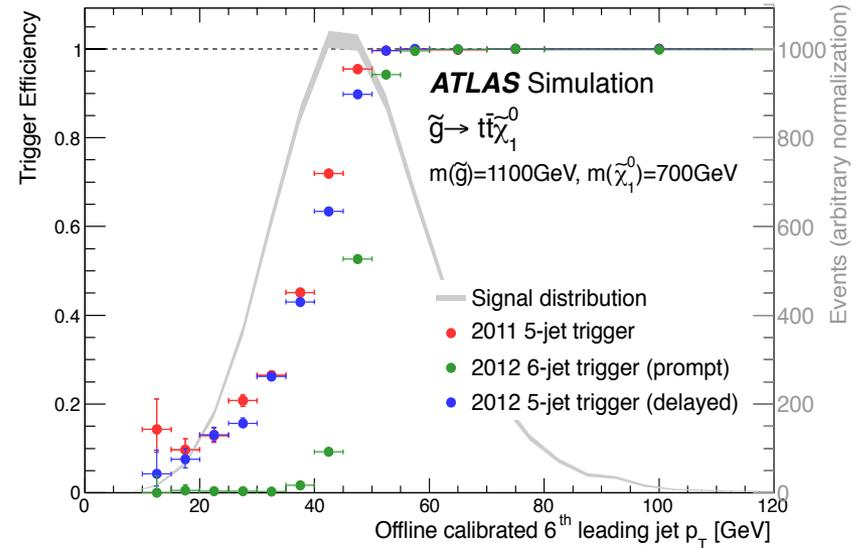

THE BENEFITS

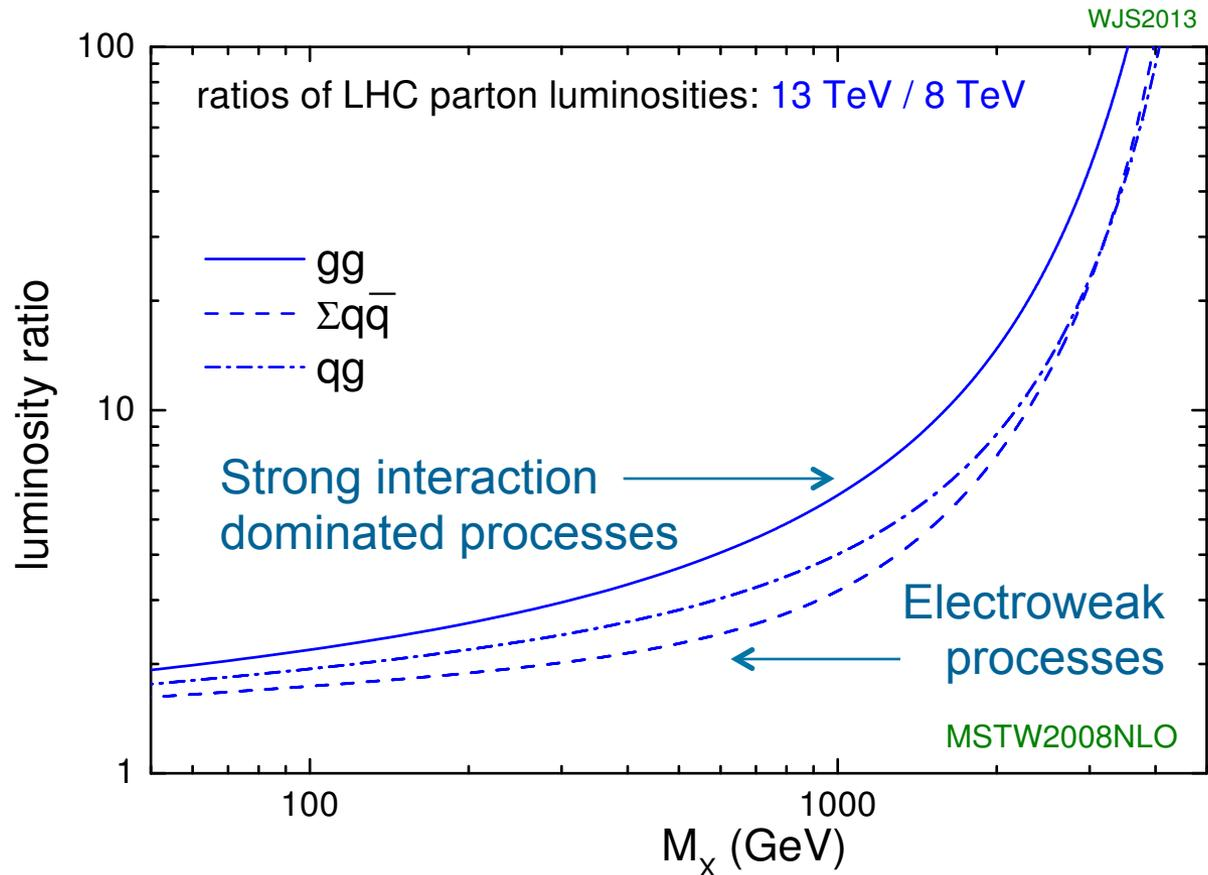

THE CHALLENGES

The calorimeter

Simulated noise in the Liquid Argon and Tile calorimeters at the electron scale

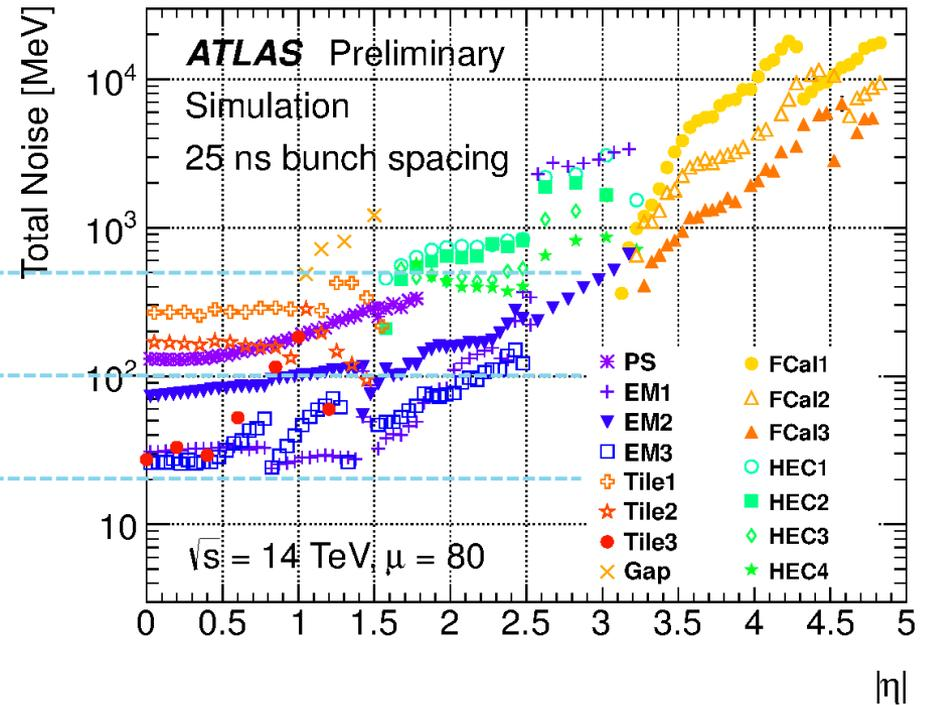
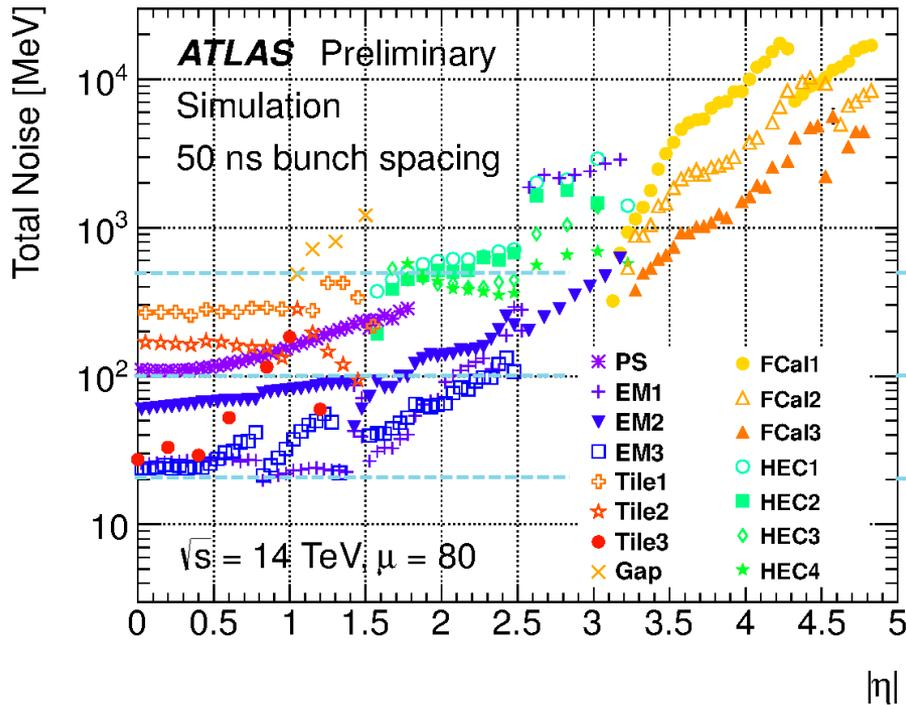

THE 'SOLUTIONS'

Detector extensions, e.g. extra muon chambers at $1.0 < |\eta| < 1.3$.

Ongoing trigger upgrade that will:

- ⊙ Increase the peak L1 rate to 100kHz.
- ⊙ Provide possibility to select on combined L1 quantities (angles, masses, etc).
- ⊙ Provide tracks at the input of the HLT for better object ID.
- ⊙ Ensure more efficient and flexible HLT reconstruction with a merged (L2 & EF) HLT.

Clever ideas for better & more robust object reconstruction.

THE PROSPECTS

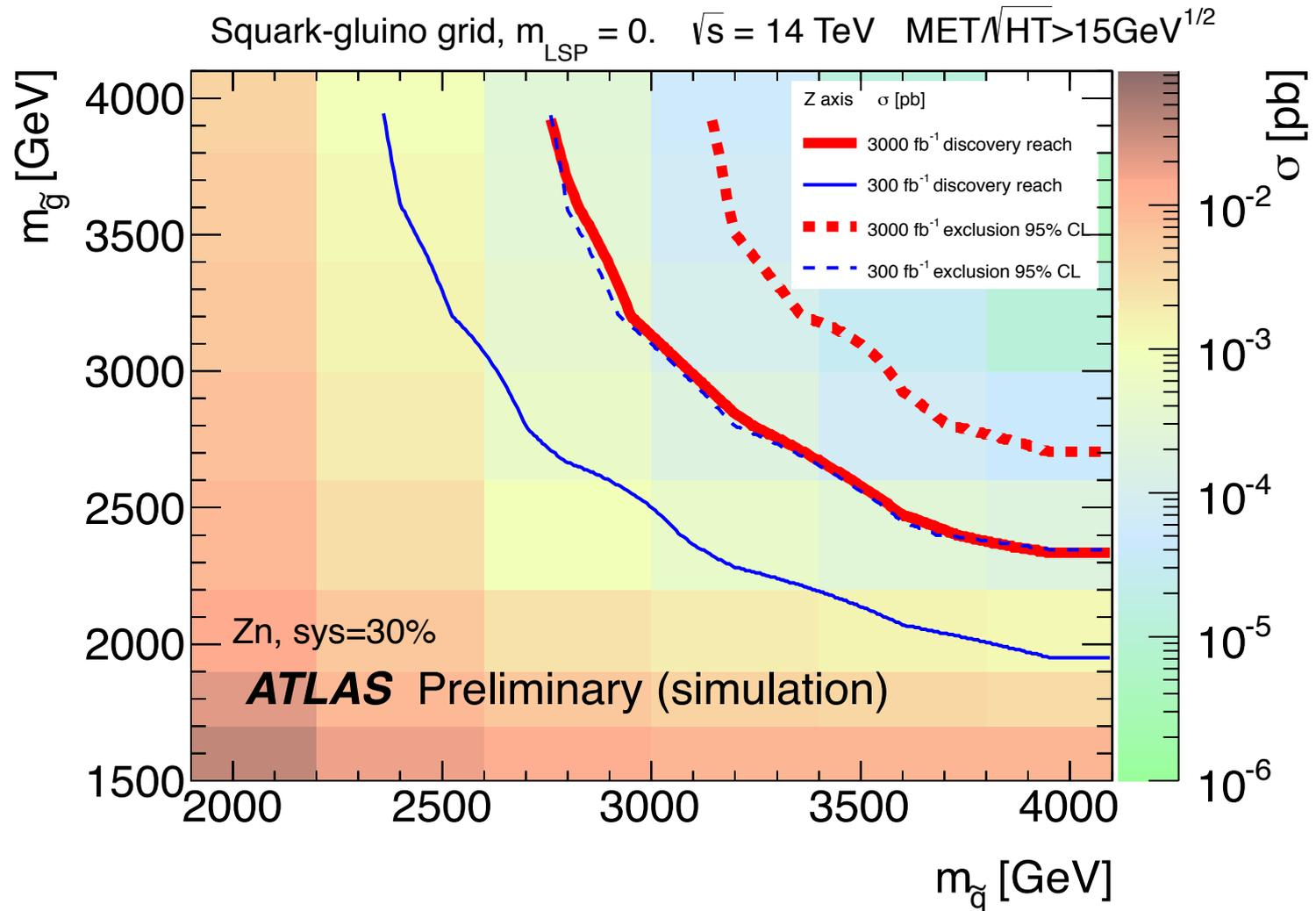

THE PROSPECTS

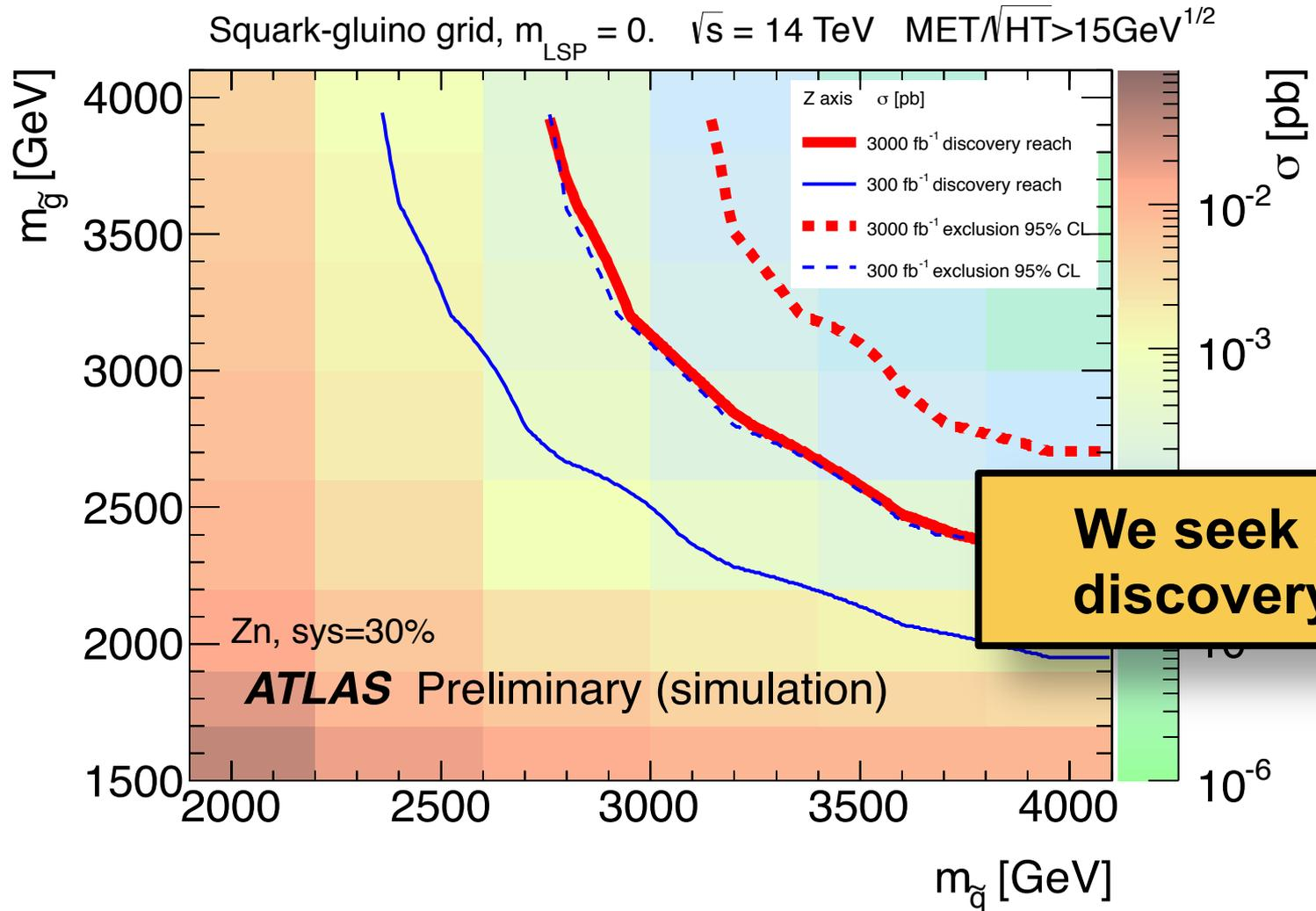

JETS

Detector inefficiencies
'Pile-up'
Electronic noise
Clustering, noise suppression
Dead material losses
Detector response
Algorithm efficiency

Algorithm efficiency
'Pile-up'
'Underlying event'

Physics process of interest

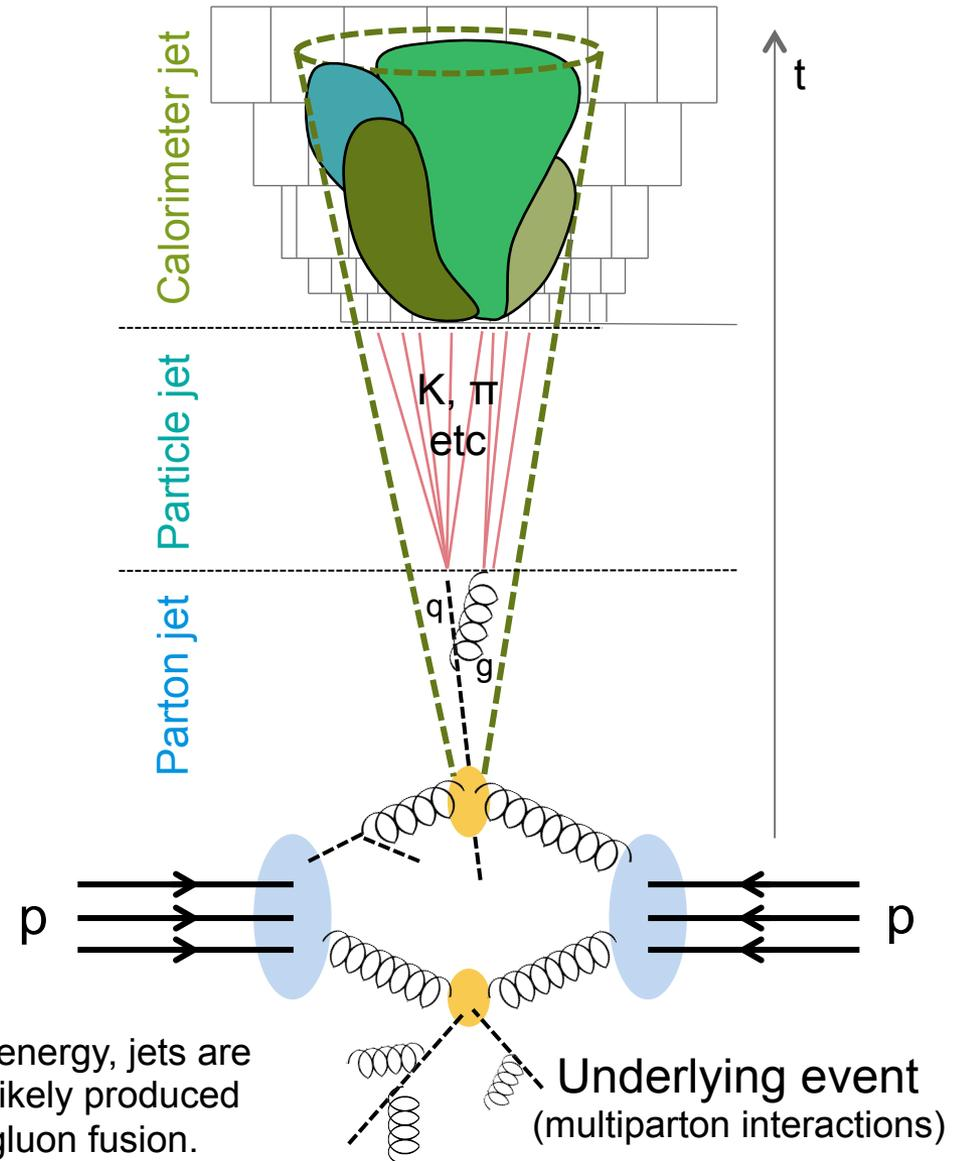

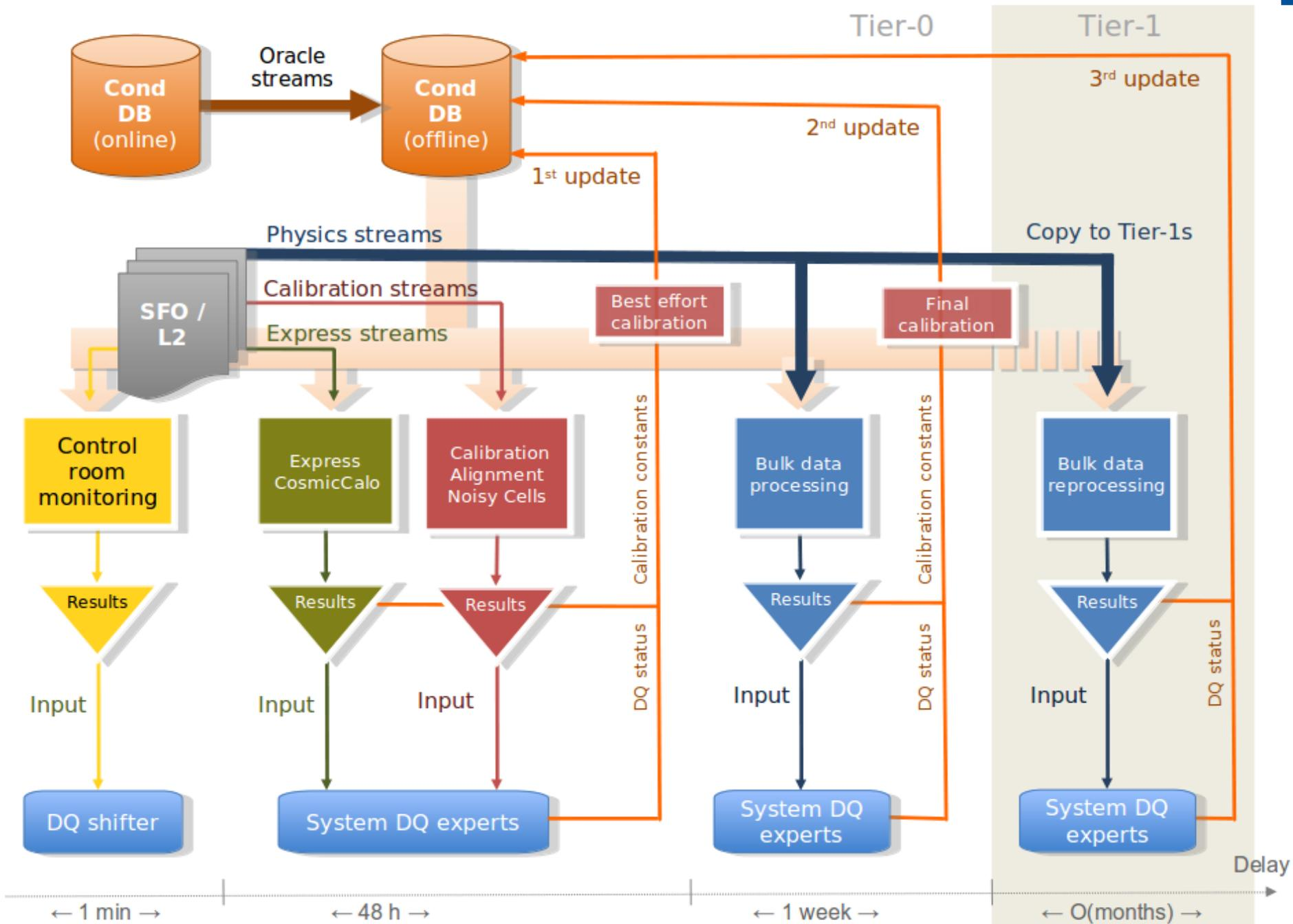

BACKGROUNDS & DETERMINATION

QCD & Hadronic $t\bar{t}b\bar{a}$

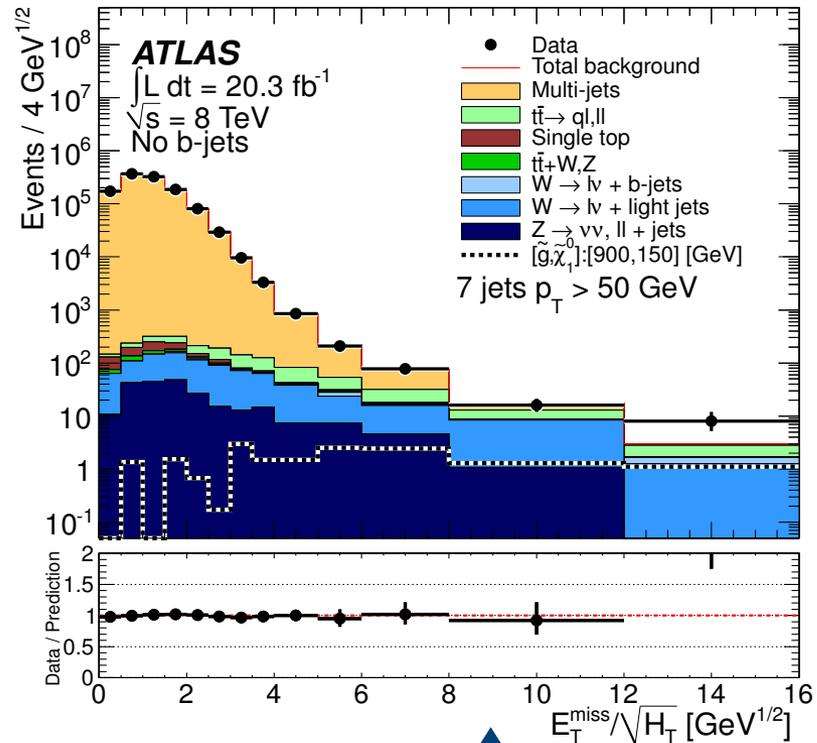
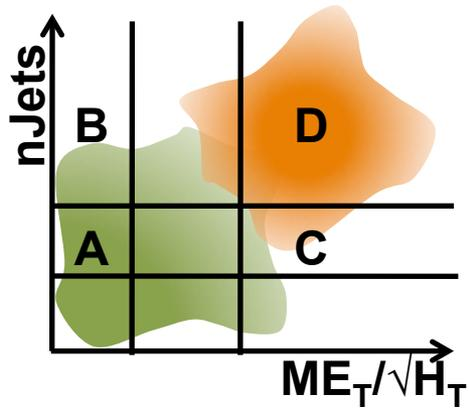

- © Template extracted from '6j50' and validated in '7j50'.
- © Discrepancies in control regions become uncertainties; dominant, on top of heavy flavor and 'leptonic' backgrounds.

BACKGROUNDS & DETERMINATION

Non-full hadronic $t\bar{t}b$ & V+jets

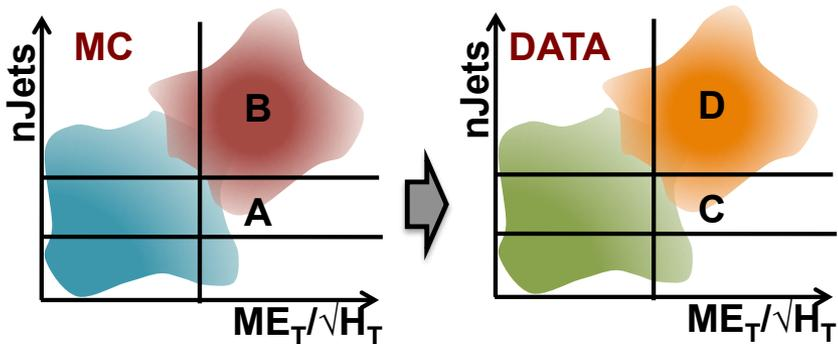

- ⊙ Extracted from MC normalized on data.
- ⊙ Uncertainties: JES/JER, b-tagging, pile-up and theory.

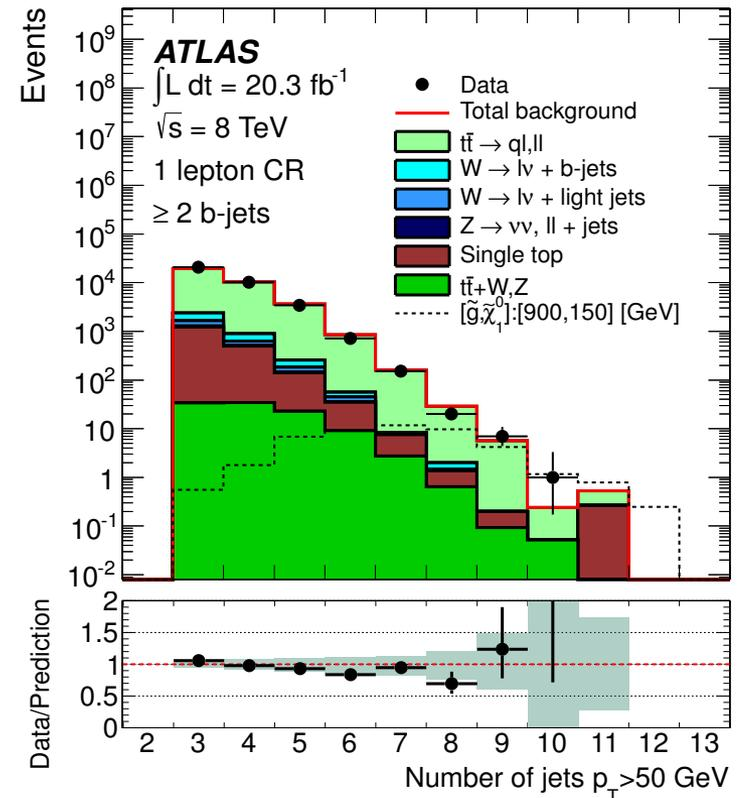

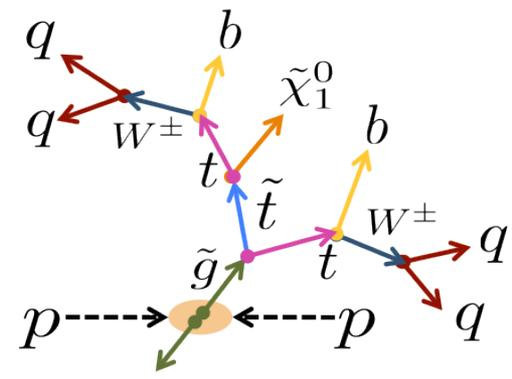
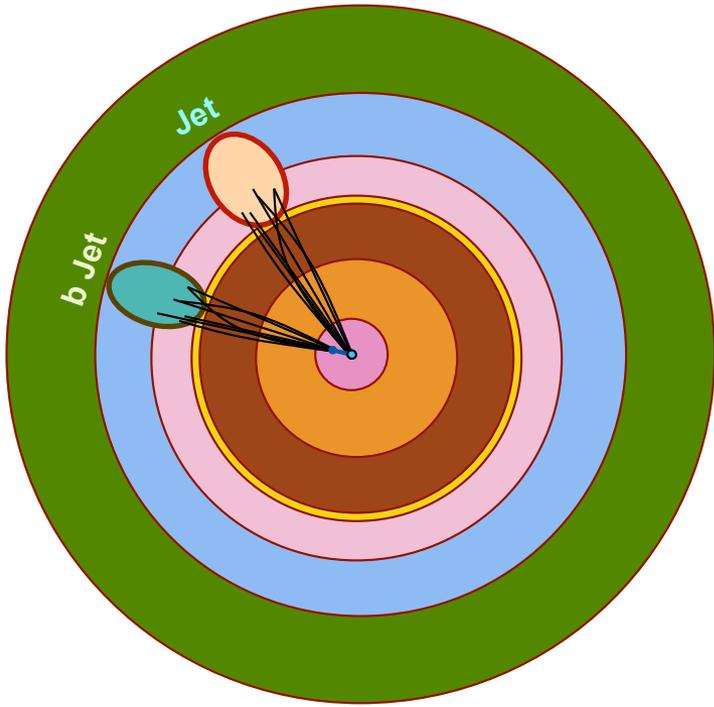

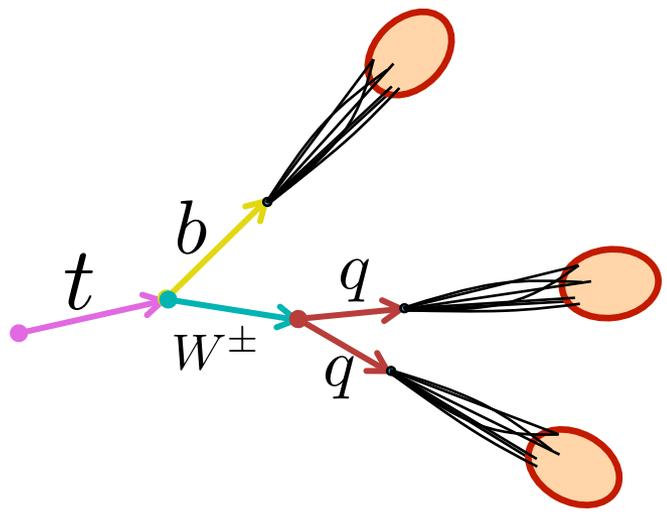

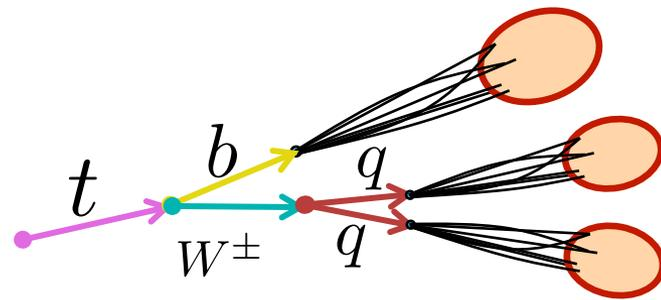

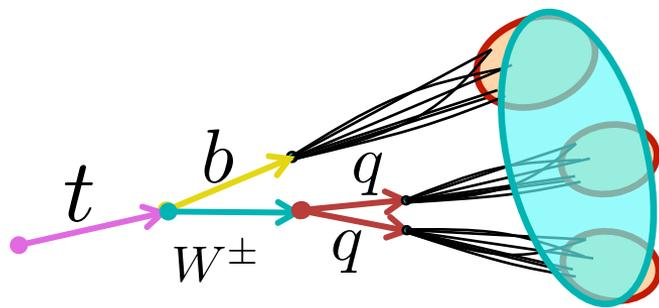

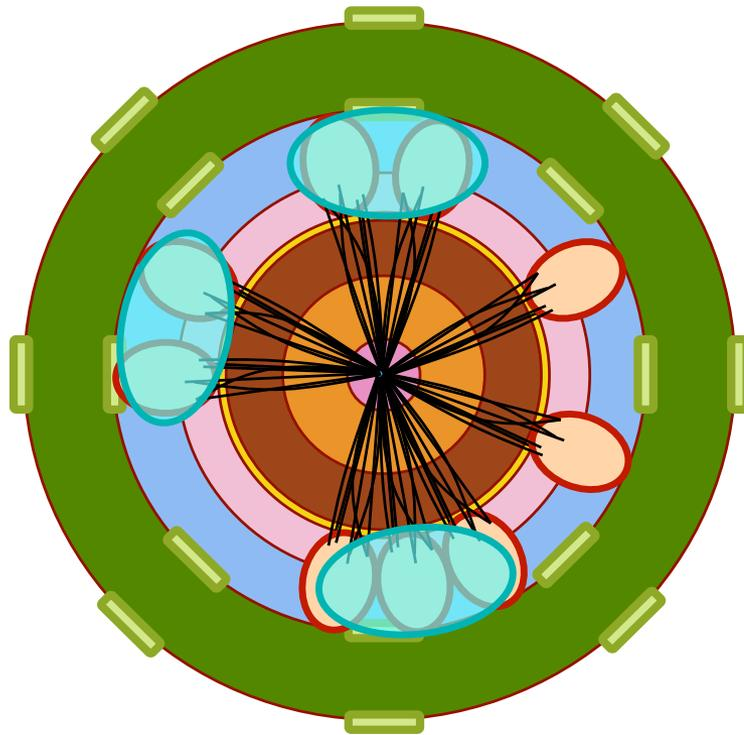

THE SUSY MULTIJET SEARCH

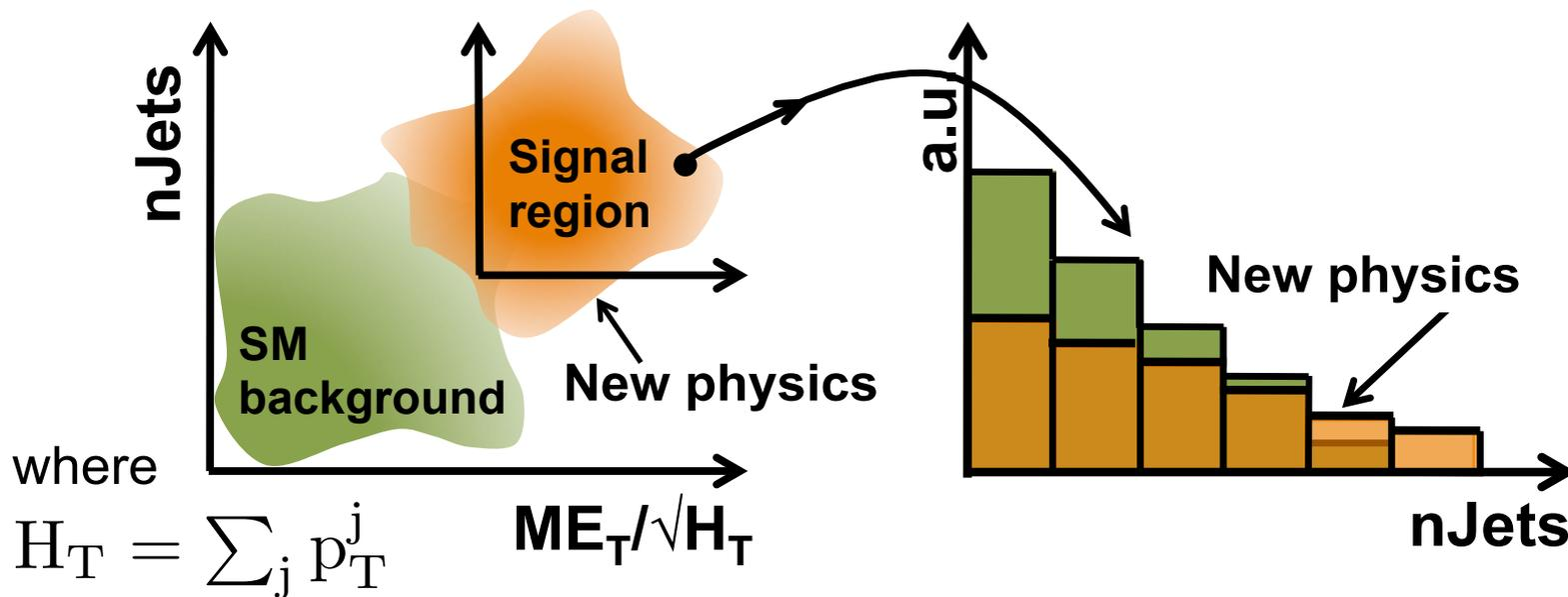

Dominant background: SM multijet production; fake MET from jet mis-measurements. Estimated using a combination of data-driven methods and Monte-Carlo based methods. Validated in control regions. **Typical treatment of (SUSY) searches.**

Why $ME_T / \sqrt{H_T}$?

\Rightarrow a measure of ME_T in units of standard deviations of the fake ME_T

$$\frac{\sigma_{p_T}}{p_T} = \frac{N}{p_T} \oplus \frac{S}{\sqrt{p_T}} \oplus C$$