

CHALLENGES IN PHOTON INDUCED INTERACTIONS

EMMI WORKSHOP

$\gamma\gamma \rightarrow \gamma\gamma$ SCATTERING
IN PROTON-PROTON AND NUCLEUS-NUCLEUS COLLISIONS

Antoni Szczurek ^{1,2}
Mariola Kłusek-Gawenda ¹
Piotr Lebiedowicz ¹
Wolfgang Schäfer ¹

¹Institute of Nuclear Physics PAN Kraków
²University of Rzeszów



CONTENTS

- 1 $\gamma\gamma \rightarrow \gamma\gamma$ scattering
 - Box contributions
 - A new soft mechanism
- 2 $pp \rightarrow pp\gamma\gamma$ (short, see Valery's talk)
- 3 $AA \rightarrow AA\gamma\gamma$
 - Equivalent photon approximation(s)
 - Nuclear charged form factor
- 4 Nuclear results
 - Integrated cross sections
 - Differential distributions
 - Experimental result and future possibilities
- 5 $\gamma\gamma \rightarrow \gamma\gamma$, two-gluon exchange mechanism
- 6 $\gamma\gamma \rightarrow \gamma\gamma$, meson-exchange
- 7 Conclusions

PHOTON-PHOTON SCATTERING

- In classical Maxwell theory photons/waves/wave packets do not interact
- In quantal theory interaction via **quantal fluctuations**
- For elastic $\gamma\gamma \rightarrow \gamma\gamma$ scattering the main mechanism are **intermediate boxes**.

PHOTON-PHOTON ELASTIC SCATTERING

- There were (still are) plans to construct **high-energy photon-photon collider(s)** at linear e^+e^- colliders (**double back Compton scattering**), but this seems to be still a remote future.
- In the region of MeV energies – **high-power lasers** were discussed recently: **K. Homma, K. Matsuura, K. Nakajima, arXiv:1505.03630. Drebot, Millotti, Serafini et al.**
- At (present) the LHC (high energy) two options a priori possible
 - $pp \rightarrow pp\gamma\gamma$ or $pp \rightarrow \gamma\gamma X$
 - $AA \rightarrow AA\gamma\gamma$
- For proton-proton collisions a serious background of **KMR mechanism** in elastic-elastic case at low photon-photon energies. At high energies:
 - (a) **P. Lebiedowicz, R. Pasechnik, A. Szczurek, Nucl. Phys. B881 (2014) 288.**
 - (b) **S. Fichet, G. von Gersdorff, O. Kepka, B. Lenzi, C. Royon, M. Saimpert, Phys. Rev. D89 (2014) 114004.**

PHOTON-PHOTON ELASTIC SCATTERING

- In Pb-Pb UPC the reaction is enhanced by $Z_1^2 Z_2^2$ factor (naive).
A first estimate: **D. d'Enterria, G. da Silveira**, Phys. Rev. Lett. **111** (2013) 080405.
wrong by a factor of about 8.
erratum was written, Phys.Rev.Lett. **116** (2016) 129901.
- This presentation will be based on our recent analysis:
M. Kłusek-Gawenda, P. Lebiedowicz and A. Szczurek,
arXiv:1601.07001, Phys. Rev. **C93** (2016) 044907.
- **M. Kłusek-Gawenda, W. Schäfer and A. Szczurek**, “Two-gluon exchange contribution to elastic $\gamma\gamma \rightarrow \gamma\gamma$ scattering and production of two-photons in ultraperipheral ultrarelativistic heavy ion and proton-proton collisions”, Phys. Lett. **B761** (2016) 399.
- **P. Lebiedowicz and A. Szczurek** “The role of meson exchanges in light-by-light scattering”, Phys. Lett. **B772** (2017) 330.

PHOTON-PHOTON ELASTIC SCATTERING

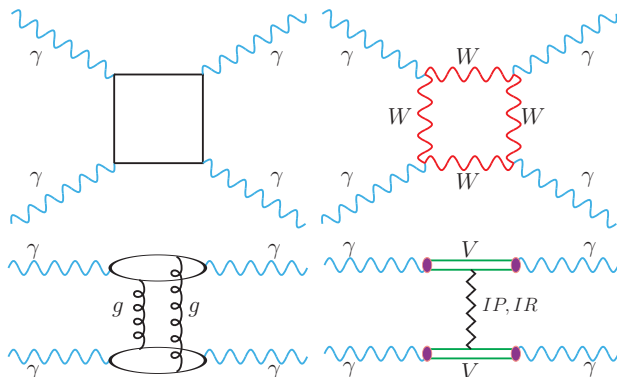

Upper mechanisms well known.

The mechanisms below were not considered.

EXCLUSIVE $pp \rightarrow pp\gamma\gamma$

Two mechanisms of the exclusive production:

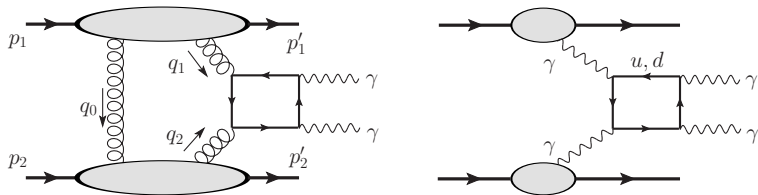

The QCD KMR mechanism disturbs seeing the QED mechanism

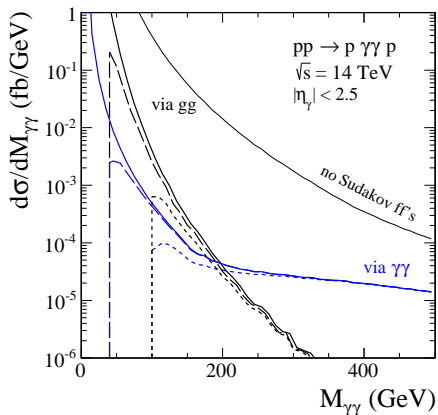
EXCLUSIVE $pp \rightarrow pp\gamma\gamma$ 

At low energy diffractive mechanism dominates

At high energy the $\gamma\gamma$ rescattering dominates

Potential place to look for effects beyond Standard Model

$$AA \rightarrow AA\gamma\gamma$$

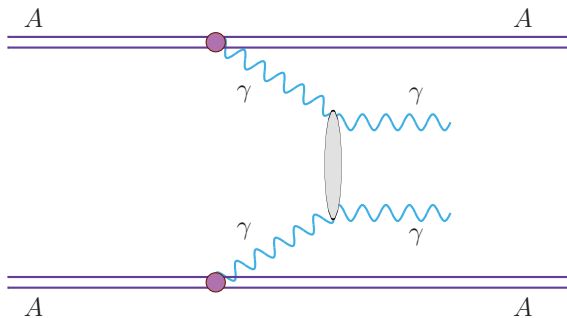

Let us consider ultraperipheral collisions.

EQUIVALENT PHOTON APPROXIMATION

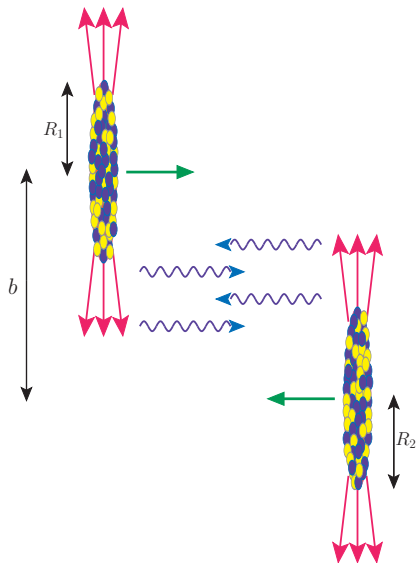

The strong electromagnetic field is a source of photons that induce electromagnetic reactions in ion-ion collisions.

ULTRAPERIPHERAL
COLLISIONS

$$b > R_{min} = R_1 + R_2$$

NUCLEAR CROSS SECTION

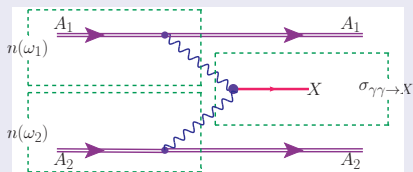

$$n(\omega) = \int_{R_{min}}^{\infty} 2\pi b db N(\omega, b)$$

$$\sigma_{A_1 A_2 \rightarrow A_1 A_2 X} = \int d\omega_1 d\omega_2 n(\omega_1) n(\omega_2) \sigma_{\gamma\gamma \rightarrow X}(\omega_1, \omega_2) \quad (1)$$

(naive)

$$= \int N(\omega_1, \mathbf{b}_1) N(\omega_2, \mathbf{b}_2) S_{abs}^2(\mathbf{b})$$

$$\times \sigma_{\gamma\gamma \rightarrow X}(\sqrt{s_{\gamma\gamma}})$$

$$\times 2\pi b db d\bar{b}_x d\bar{b}_y \frac{W_{\gamma\gamma}}{2} dW_{\gamma\gamma} dY_X$$

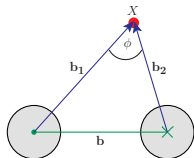

ELEMENTARY CROSS SECTION

The differential cross section for the elementary $\gamma\gamma \rightarrow \gamma\gamma$ subprocess can be calculated as:

$$\frac{d\sigma_{\gamma\gamma \rightarrow \gamma\gamma}}{dt} = \frac{1}{16\pi s^2} \overline{|\mathcal{A}_{\gamma\gamma \rightarrow \gamma\gamma}|^2} \quad (2)$$

or

$$\frac{d\sigma_{\gamma\gamma \rightarrow \gamma\gamma}}{d\Omega} = \frac{1}{64\pi^2 s} \overline{|\mathcal{A}_{\gamma\gamma \rightarrow \gamma\gamma}|^2}. \quad (3)$$

ELEMENTARY CROSS SECTION, FERMION BOXES

Leading-order QED fermion box diagram cross section is well known.

$$\overline{|\mathcal{M}_{\gamma\gamma\rightarrow\gamma\gamma}|^2} = \alpha_{em}^4 f(\hat{t}, \hat{u}, \hat{s}) . \quad (4)$$

Inclusion of W boxes can be calculated with Loop Tools.

Our result was confronted with that by [Jikia et al. \(1993\)](#), [Bern et al. \(2001\)](#) and [Bardin et al. \(2009\)](#).

[Bern et al.](#) considered both the QCD and QED corrections ([two-loop Feynman diagrams](#)) to the one-loop fermionic contributions in the ultrarelativistic limit ($\hat{s}, |\hat{t}|, |\hat{u}| \gg m_f^2$). The corrections are [quite small numerically](#).

Different limits discussed by:

[Ermolaev, Ivanov, Troyan](#), arXiv:1708.01437 [hep-ph],

Elastic scattering of virtual photons via quark loop in

Double-Logarithmic Approximation.

ELEMENTARY CROSS SECTION, VDM-REGGE COMPONENT

The t -channel amplitude for the **VDM-Regge** contribution:

$$\begin{aligned} \mathcal{A}_{\gamma\gamma\rightarrow\gamma\gamma}(s, t) &= \sum_i^3 \sum_j^3 \mathbf{C}_{\gamma\rightarrow V_i} \mathcal{A}_{V_i V_j \rightarrow V_i V_j} \mathbf{C}_{\gamma\rightarrow V_j} \\ &\approx \left(\sum_{i=1}^3 \mathbf{C}_{\gamma\rightarrow V_i} \right) \mathcal{A}_{VV\rightarrow VV}(s, t) \left(\sum_{j=1}^3 \mathbf{C}_{\gamma\rightarrow V_j} \right), \quad (5) \end{aligned}$$

where $i, j = \rho, \omega, \phi$ and

$$\mathcal{A}_{VV\rightarrow VV} = \mathcal{A}(s, t) \exp\left(\frac{B}{2}t\right) \quad (6)$$

The amplitude for $V_i V_j \rightarrow V_i V_j$ elastic scattering is parametrized in the **Regge approach** (similar as for $\gamma\gamma \rightarrow \rho^0 \rho^0$)

ELEMENTARY CROSS SECTION

$$\mathcal{A}(s, t) \approx s \left((1 + i) C_R \left(\frac{s}{s_0} \right)^{\alpha_R(t)-1} + i C_P \left(\frac{s}{s_0} \right)^{\alpha_P(t)-1} \right). \quad (7)$$

The interaction parameters are the same as for the $\pi^0\pi^0$ interaction. The latter obtained from NN and πN total cross sections assuming **Regge factorization**.

For example:

$$\mathcal{A}_{\pi^0\rho}(s, t) = \frac{1}{2} (\mathcal{A}_{\pi^+\rho}(s, t) + \mathcal{A}_{\pi^-\rho}(s, t)) . \quad (8)$$

$$\sigma_{\pi^\pm\rho}^{tot}(s) = \frac{1}{s} \text{Im} \mathcal{A}_{\pi^\pm\rho}(s, t = 0) . \quad (9)$$

ELEMENTARY CROSS SECTION

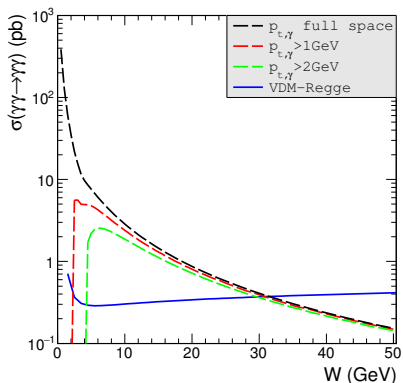

At large W a small lower cut on photon transverse momenta is not important.

ELEMENTARY CROSS SECTION

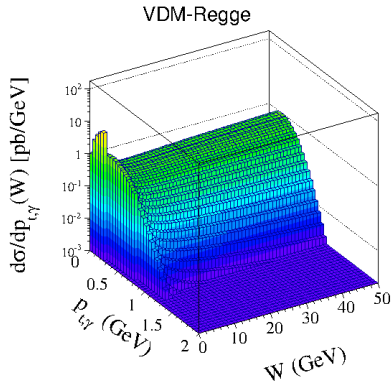
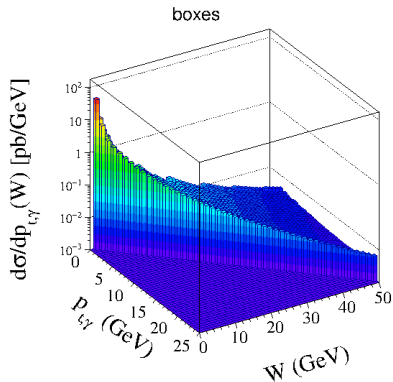

ELEMENTARY CROSS SECTION

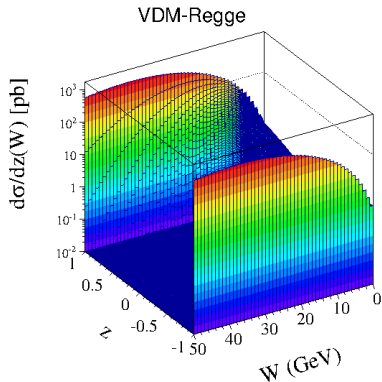
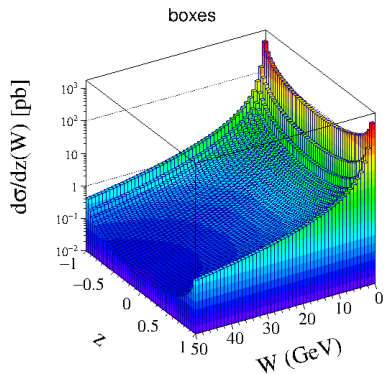

Hard and soft, respectively

NUCLEAR CROSS SECTION

In our b-space EPA:

$$\sigma_{A_1 A_2 \rightarrow A_1 A_2 \gamma\gamma}(\sqrt{s_{A_1 A_2}}) = \int \sigma_{\gamma\gamma \rightarrow \gamma\gamma}(\sqrt{s_{\gamma\gamma}}) N(\omega_1, \mathbf{b}_1) N(\omega_2, \mathbf{b}_2) S_{abs}^2(\mathbf{b}) \times 2\pi b db d\bar{b}_x d\bar{b}_y \frac{W_{\gamma\gamma}}{2} dW_{\gamma\gamma} dY_{\gamma\gamma}, \quad (10)$$

where $N(\omega_i, \mathbf{b}_i)$ are photon fluxes

$$Y_{\gamma\gamma} = \frac{1}{2} (y_{\gamma_1} + y_{\gamma_2}) \quad (11)$$

is a rapidity of the outgoing $\gamma\gamma$ system.

$$W_{\gamma\gamma} = \sqrt{4\omega_1\omega_2}, \quad (12)$$

where $\omega_{1/2} = W_{\gamma\gamma}/2 \exp(\pm Y_{\gamma\gamma})$. The quantities \bar{b}_x, \bar{b}_y are the components of the vector $\bar{\mathbf{b}} = (\mathbf{b}_1 + \mathbf{b}_2)/2$

$$\mathbf{b}_1 = \left[\bar{b}_x + \frac{b}{2}, \bar{b}_y \right], \quad \mathbf{b}_2 = \left[\bar{b}_x - \frac{b}{2}, \bar{b}_y \right]. \quad (13)$$

AA \rightarrow AA $\gamma\gamma$ - FORM FACTOR

$N(\omega_{1/2}, \mathbf{b}_{1/2})$ depends on the electromagnetic form factor

- realistic
- monopole

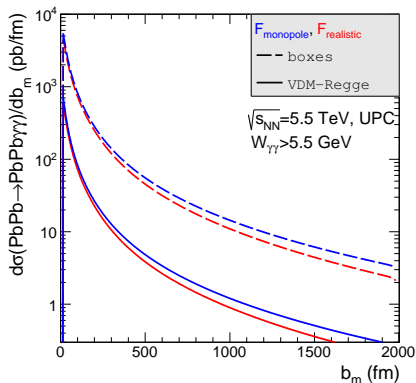

AA \rightarrow AA $\gamma\gamma$ - FORM FACTOR

- realistic
- monopole

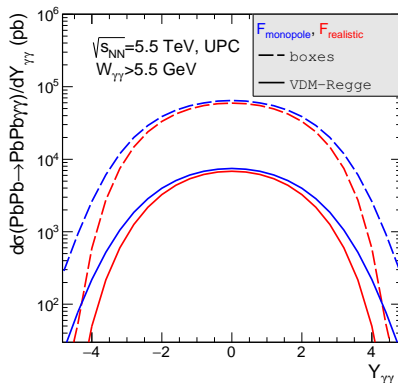
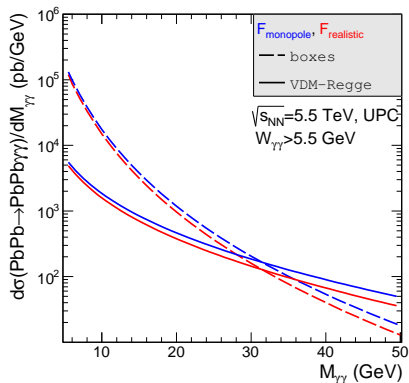

AA \rightarrow AA $\gamma\gamma$ - INTEGRATED CROSS SECTION

cuts	boxes		VDM-Regge	
	$F_{realistic}$	$F_{monopole}$	$F_{realistic}$	$F_{monopole}$
$W_{\gamma\gamma} > 5$ GeV	306	349	31	36
$W_{\gamma\gamma} > 5$ GeV, $p_{t,\gamma} > 2$ GeV	159	182	7E-9	8E-9
$E_{\gamma} > 3$ GeV	16 692	18 400	17	18
$E_{\gamma} > 5$ GeV	4 800	5 450	9	611
$E_{\gamma} > 3$ GeV, $ y_{\gamma} < 2.5$	183	210	8E-2	9E-2
$E_{\gamma} > 5$ GeV, $ y_{\gamma} < 2.5$	54	61	4E-4	7E-4
$p_{t,\gamma} > 0.9$ GeV, $ y_{\gamma} < 0.7$ (ALICE cuts)	107			
$p_{t,\gamma} > 5.5$ GeV, $ y_{\gamma} < 2.5$ (CMS cuts)	10			
$\sqrt{s} = 39$ TeV, $W_{\gamma\gamma} > 5$ GeV	6169		882	
$\sqrt{s} = 39$ TeV, $E_{\gamma} > 3$ GeV	4.696 mb		574	

TABLICA: Integrated cross sections in nb for exclusive diphoton production processes with both photons measured, for $\sqrt{s_{NN}} = 5.5$ TeV (LHC) and $\sqrt{s_{NN}} = 39$ TeV (FCC). Impact-parameter EPA.

AA \rightarrow AA $\gamma\gamma$ - NUMBER OF COUNTS

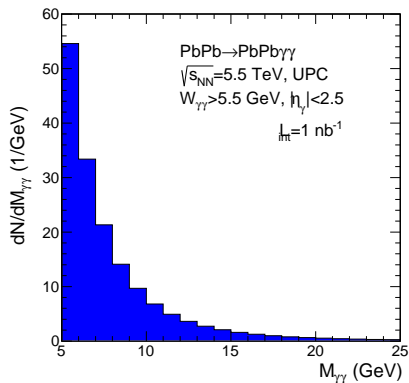

For $L_{\text{int}} = 1 \text{ nb}^{-1}$ a few counts per GeV – measurable quantity

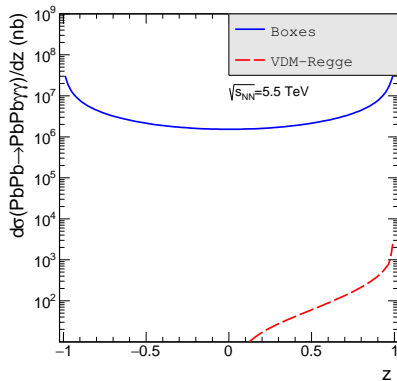
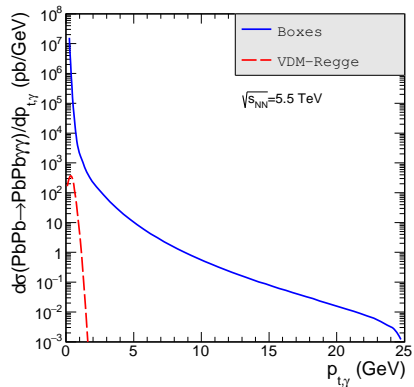
AA \rightarrow AA $\gamma\gamma$ - DISTRIBUTIONS

AA \rightarrow AA $\gamma\gamma$ - DISTRIBUTIONS

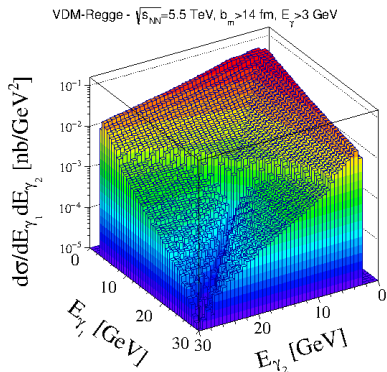
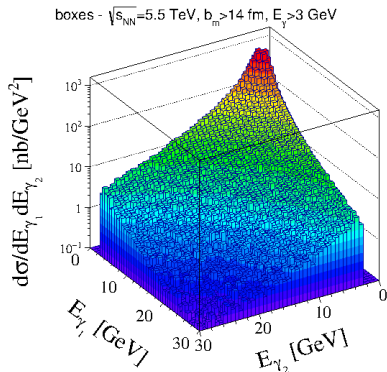

Cross section strongly depends on the photon energy cuts

AA \rightarrow AA $\gamma\gamma$ - PHOTON RAPIDITY

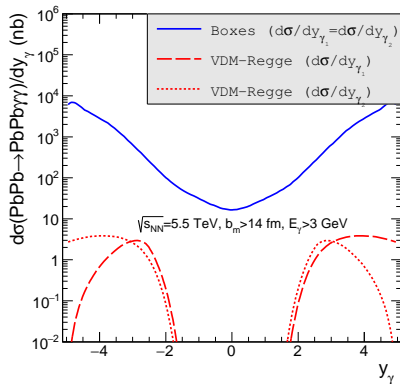

AA \rightarrow AA $\gamma\gamma$ - RAPIDITY CORRELATIONS

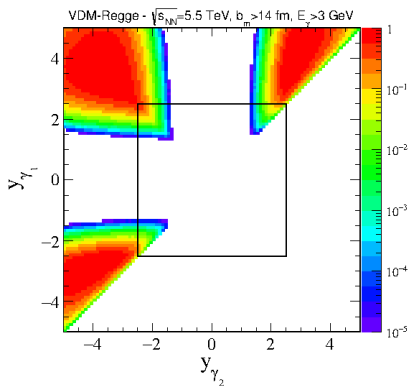
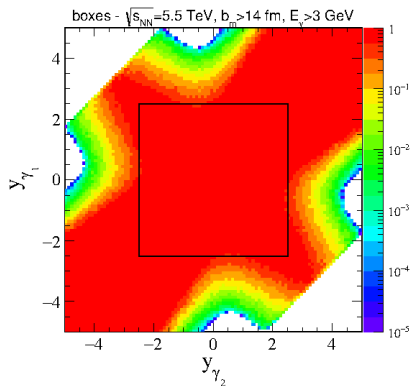

At midrapidity boxes dominate

The soft mechanism at large rapidities

Can it be measured with ZDC ?

AA \rightarrow AA $\gamma\gamma$ - RAPIDITY CORRELATIONS

In the extended rapidity range:

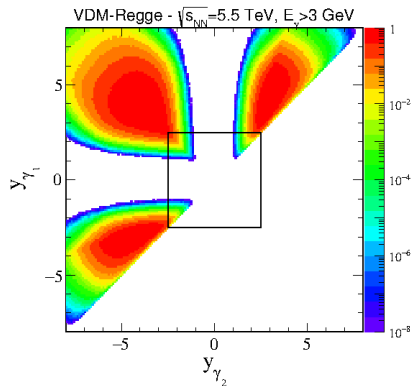

May be difficult to measure.

ATLAS RESULTS

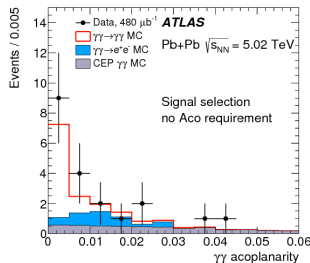
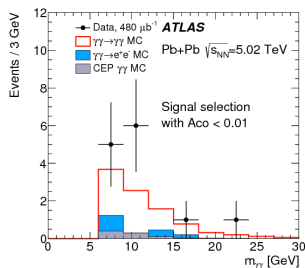

Only 13 events

Evidence for light-by-light scattering in heavy-ion collisions with the ATLAS detector at the LHC, Nature Physics, **13** (2017) 852.

Agreement with our predictions

see Mateusz Dyndal talk

$\gamma\gamma \rightarrow \gamma\gamma$, TWO-GLUON EXCHANGE

Let us consider (with M.Kłusek-Gawenda and W.Schäfer):

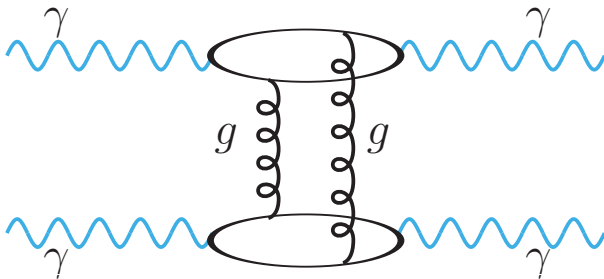

Not yet considered in the context of elastic scattering.

Exact calculation very difficult (**three loops**)

Here we consider high-energy approximation.

$\gamma\gamma \rightarrow \gamma\gamma$, TWO-GLUON EXCHANGE

The altogether **16 diagrams** result in the amplitude, which can be cast into the **impact-factor representation**:

$$A(\gamma_{\lambda_1} \gamma_{\lambda_2} \rightarrow \gamma_{\lambda_3} \gamma_{\lambda_4}; \mathbf{s}, t)$$

$$= i s \sum_{f, f'} \int d^2 \kappa \frac{\mathcal{J}^{(f)}(\gamma_{\lambda_1} \rightarrow \gamma_{\lambda_3}; \kappa, \mathbf{q}) \mathcal{J}^{(f')}(\gamma_{\lambda_2} \rightarrow \gamma_{\lambda_4}; -\kappa, -\mathbf{q})}{[(\kappa + \mathbf{q}/2)^2 + \mu_G^2][(\kappa - \mathbf{q}/2)^2 + \mu_G^2]}.$$

Here \mathbf{q} is the transverse momentum transfer, $t \approx -\mathbf{q}^2$, and μ_G is a gluon mass parameter. We parametrize the loop momentum such that gluons carry transverse momenta $\mathbf{q}/2 \pm \kappa$.

The amplitude is finite at $\mu_G \rightarrow 0$, because the impact factors \mathcal{J} vanish for $\kappa \rightarrow \pm \mathbf{q}/2$.

$\gamma\gamma \rightarrow \gamma\gamma$, TWO-GLUON EXCHANGE

The differential cross section is given by

$$\frac{d\sigma(\gamma\gamma \rightarrow \gamma\gamma; \mathbf{s})}{dt} = \frac{1}{16\pi s^2} \frac{1}{4} \sum_{\lambda_i} \left| A(\gamma_{\lambda_1} \gamma_{\lambda_2} \rightarrow \gamma_{\lambda_3} \gamma_{\lambda_4}; \mathbf{s}, t) \right|^2. \quad (15)$$

At small t , within the diffraction cone, the cross section is dominated by the s -channel helicity conserving amplitude. The explicit form of the impact factor is

$$\begin{aligned} \mathcal{J}^{(f)}(\gamma_\lambda \rightarrow \gamma_\tau; \boldsymbol{\kappa}, \mathbf{q}) &= \sqrt{N_c^2 - 1} \frac{e_f^2 \alpha_{em} \alpha_S}{2\pi^2} \int_0^1 dz \int \frac{d^2 \mathbf{k}}{\mathbf{k}^2 + m_f^2} \\ &\times \left(\delta_{\lambda\tau} I(T, T) + \delta_{\lambda, -\tau} I(T, T') \right), \quad (16) \end{aligned}$$

where $N_c = 3$ is the number of colors, e_f is the charge of the quark of flavour f . Quark and antiquark share the large lightcone momentum of the incoming photon in fractions $z, 1 - z$, respectively. The transverse momenta entering the outgoing $Q\bar{Q}\gamma$ -vertex are $\mathbf{k} + \mathbf{z}\mathbf{q}$ and $-\mathbf{k} + (1 - z)\mathbf{q}$.

$\gamma\gamma \rightarrow \gamma\gamma$ TWO-GLUON EXCHANGE

The spin-momentum structure of the quark-loop is encoded in the function $I(T, T)$ (Ivanov-Nikolaev-Schäfer 2006) Indices T, T refer to the transverse polarizations of photons. The s-channel-helicity conserving piece $I(T, T)$ and the helicity-flip piece $I(T, T')$:

$$\begin{aligned}
 I(T, T) &= m_f^2 \Phi_2 + \left[z^2 + (1-z)^2 \right] (\mathbf{k} \Phi_1) \\
 I(T, T') &= 2z(1-z) \left((\Phi_1 \mathbf{n})(\mathbf{k} \mathbf{n}) - [\Phi_1, \mathbf{n}][\mathbf{k}, \mathbf{n}] \right). \quad (17)
 \end{aligned}$$

Here, $\mathbf{n} = \mathbf{q}/|\mathbf{q}|$, and $[\mathbf{a}, \mathbf{b}] = a_x b_y - a_y b_x$. Here Φ_1, Φ_2 are shorthand notations for the momentum structures, corresponding to the four relevant Feynman diagrams:

$$\begin{aligned}
 \Phi_2 &= -\frac{1}{(I + \kappa)^2 + m_f^2} - \frac{1}{(I - \kappa)^2 + m_f^2} + \frac{1}{(I + \mathbf{q}/2)^2 + m_f^2} + \frac{1}{(I - \mathbf{q}/2)^2 + m_f^2} \\
 \Phi_1 &= -\frac{I + \kappa}{(I + \kappa)^2 + m_f^2} - \frac{I - \kappa}{(I - \kappa)^2 + m_f^2} + \frac{I + \mathbf{q}/2}{(I + \mathbf{q}/2)^2 + m_f^2} + \frac{I - \mathbf{q}/2}{(I - \mathbf{q}/2)^2 + m_f^2}, \quad (
 \end{aligned}$$

and we have used

TWO-GLUON EXCHANGE MECHANISM, FIRST RESULTS

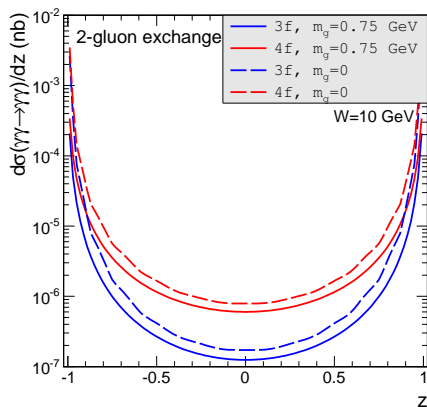

Huge effect of including charm at $z \approx 0$

– interference effect

TWO-GLUON EXCHANGE MECHANISM, NUMBER OF FLAVOURS

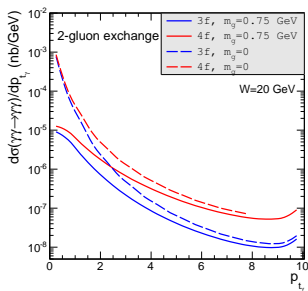
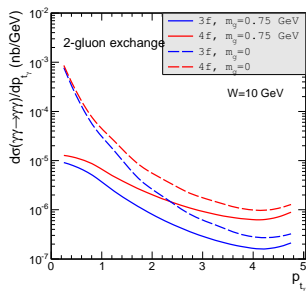

TWO-GLUON EXCHANGE VS BOX MECHANISMS VS VDM-REGGE

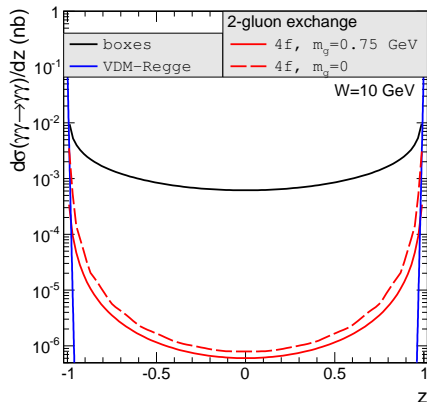

At low energies dominance of the box contributions

TWO-GLUON EXCHANGE VS BOX MECHANISMS VS VDM-REGGE

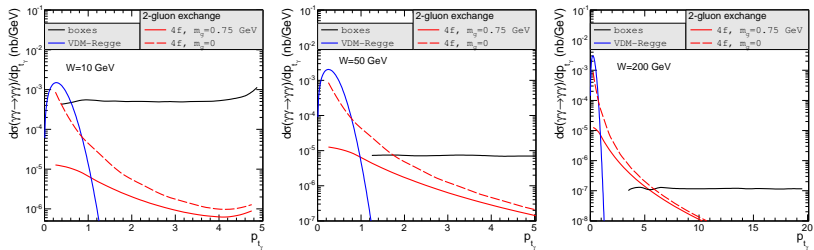

At linear collider with double back Compton scattering could be probably verified.

$AA \rightarrow AA\gamma\gamma$ WITH 2G EXCHANGE

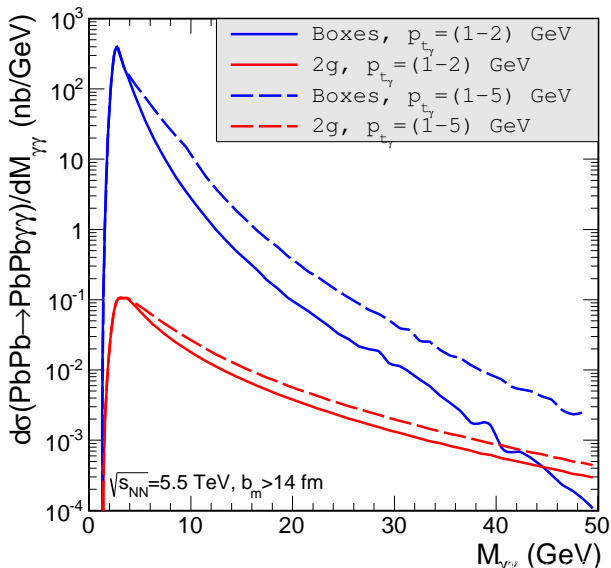

A COMMENT ON BFKL RESUMMATION

- So far we have made calculations within **two-gluon exchange approximation**.
- At high energies a (BFKL) **resummation** may be needed (ladder exchange).
- In LL BFKL formulae depend on $z = \frac{N_c \alpha_s}{\pi} \ln \left(\frac{s}{s_0} \right)$
- The choice of s_0 is pretty **arbitrary** which means that it is difficult to make any reliable predictions.
- **NLL predictions** would be necessary (not yet available).

MESON-EXCHANGE MECHANISMS

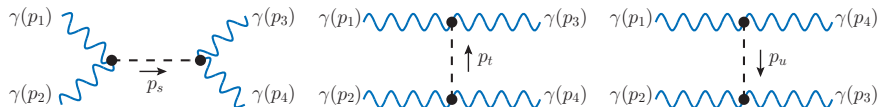

RYSUNEK: Diagrams for light-by-light scattering via a time-like (s-channel) and a space-like (t-channel and u -channel) meson exchanges.

P. Lebedowicz and A. Szczurek, "The role of meson exchanges in light-by-light scattering", arXiv:1705.06535, Phys. Lett. **B772** (2017) 330.

AMPLITUDES

The amplitude for the meson-exchange reaction:

$$\begin{aligned}
 \mathcal{M}_{\lambda_1\lambda_2\rightarrow\lambda_3\lambda_4} = & \sum_{M_{PS}=\pi^0,\eta,\eta'(958),\eta_c(1S),\eta_c(2S)} \mathcal{M}_{\lambda_1\lambda_2\rightarrow\lambda_3\lambda_4}^{(M_{PS})} \\
 + & \sum_{M_S=f_0(500),f_0(980),a_0(980),f_0(1370),\chi_{c0}(1P)} \mathcal{M}_{\lambda_1\lambda_2\rightarrow\lambda_3\lambda_4}^{(M_S)} \\
 + & \sum_{M_T=f_2(1270),a_0(1320),f_2'(1525)} \mathcal{M}_{\lambda_1\lambda_2\rightarrow\lambda_3\lambda_4}^{(M_T)}. \quad (20)
 \end{aligned}$$

The contribution of axial-vector mesons vanishes for on-shell photons due to the **Landau-Yang theorem**.

RESULTS

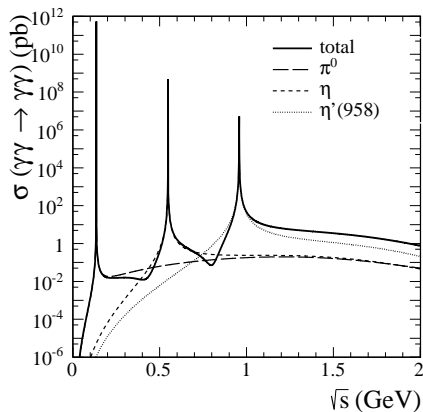
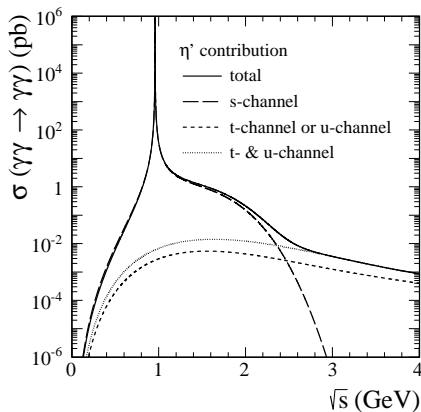

RYSUNEK: Energy dependence of the pseudoscalar meson contributions to the $\gamma\gamma \rightarrow \gamma\gamma$ scattering.

RESULTS

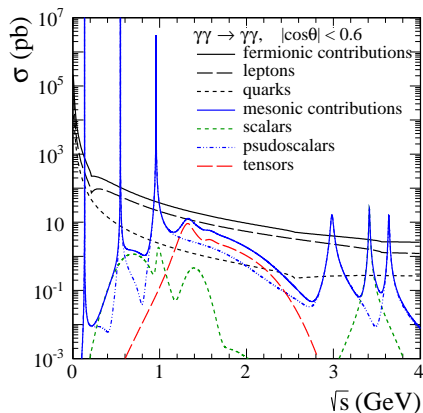
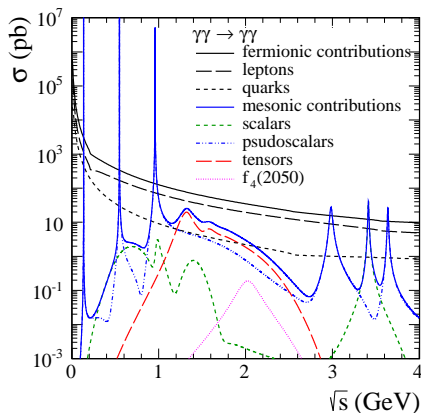

RYSUNEK: Energy dependence of the meson exchange contributions compared with the fermion-box ones. Results integrated over full z-range (left) and for $|z| < 0.6$ (right).

CONCLUSIONS

- Detailed analysis of the $\gamma\gamma \rightarrow \gamma\gamma$ (quasi)elastic scattering in nucleus-nucleus collisions at the LHC
- Two subprocesses included:
 - **Box contributions** (known for some time)
 - **Soft VDM Regge contribution** (new, for a first time)
- Calculation done in the **impact parameter EPA**.
Possibility of exclusion break-up of nuclei.
- Compare to literature we make an extension **following kinematics of photons in the LAB frame**.
- **Measurable** cross sections obtained.
- Very interesting pattern in kinematical variables of photons.
- The two subprocesses **almost separate** in the phase space.
- **ATLAS** already measured
CMS will be ready soon
It is a matter of a trigger. At ALICE only at run 3.
FCC – may be, if planned in advance.

CONCLUSIONS, VERY RECENT RESULTS

- Amplitude for two-gluon exchange has been derived **for the first time** (relatively simple formula).
- Cross section for $\gamma\gamma \rightarrow \gamma\gamma$ was calculated (**z and p_t distributions**)
- **Helicity-conserving** contribution dominates.
Helicity-flip contributions are very small even at large p_t .
- There is a **window** where two-gluon exchange **wins** with both boxes and VDM-Regge contribution.
- **Future linear colliders** ? (long-term perspective).
- $AA \rightarrow AA\gamma\gamma$? (statistics)
- $pp \rightarrow pp\gamma\gamma$? (statistics, pile ups)
- **BFKL effects** would increase the cross section.
LO \rightarrow NLO