



# Forward Physics at ATLAS

Andrew Pilkington - The University of Manchester

*Presented at the Low-x workshop, Ischia, 11<sup>th</sup> September 2009.*



## Outline

- 1) Forward detectors at ATLAS
- 2) Early measurements with 2009/2010 data:
  - Hard and soft diffraction
  - Exclusive production
  - Forward Jets
- 3) Prospects for 2011 onwards

# The ATLAS forward detector system

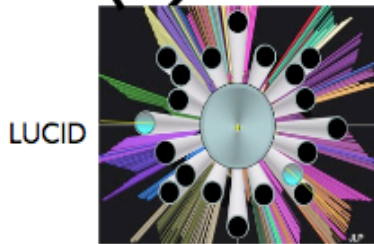
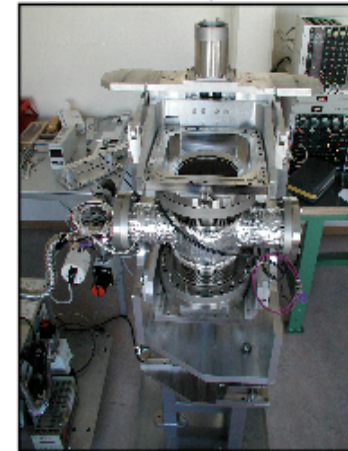
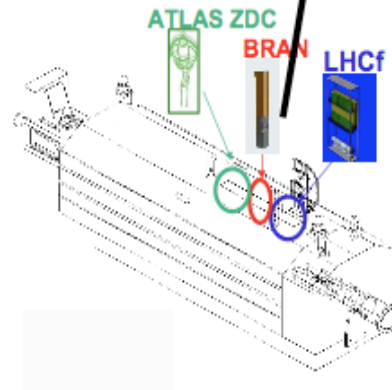
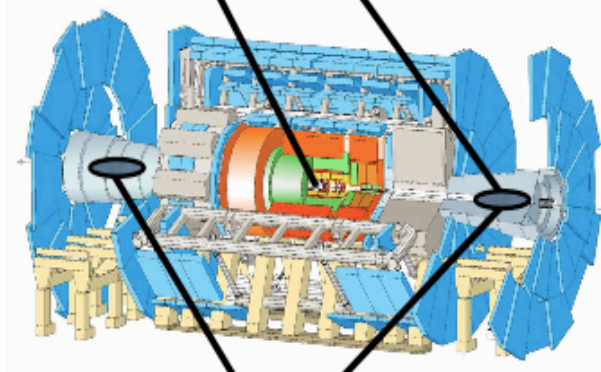
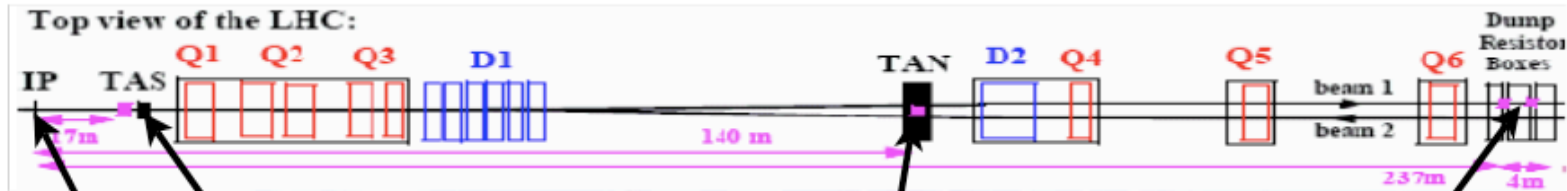

LHCf: LHC forward physics  
 BRAN: Beam Radiation Neutrals monitor  
 ZDC: Zero Degree Calorimeter

ALFA Roman Pots



# The ATLAS detector – $\eta$ coverage

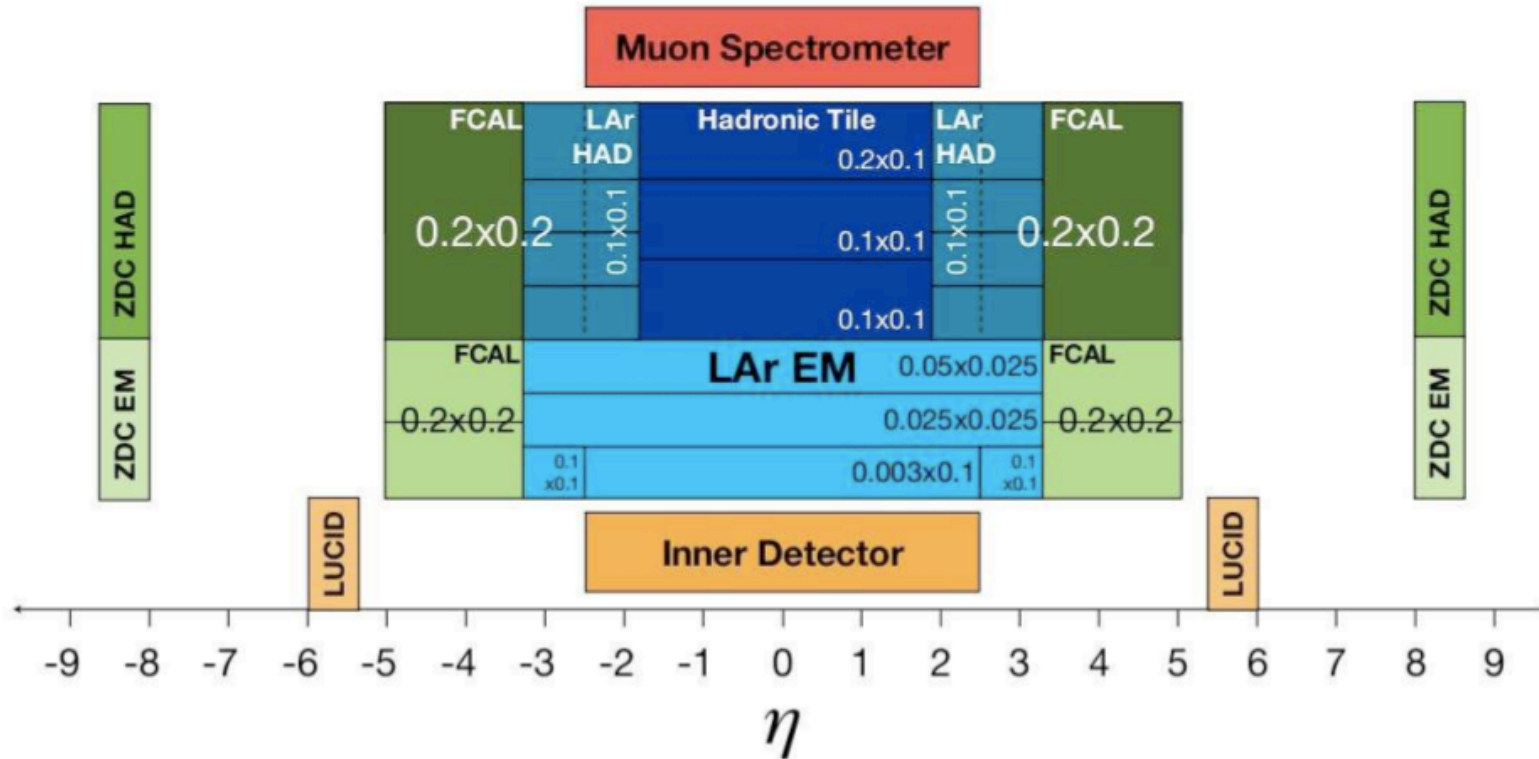

- Central detector consists of:
  - Inner tracking detector covering  $|\eta| < 2.5$ .
  - Electromagnetic calorimeters covering  $|\eta| < 3.2$ .
  - Hadronic calorimeters covering  $|\eta| < 4.9$ .
  - Muon spectrometer covering  $|\eta| < 2.7$ .

## Possible LHC running scenario\* (2009/2010)



- After commissioning at injection energy, collisions will take place at 3.5 TeV per beam.
  - Current plan\* is to take around  $60\text{pb}^{-1}$  of data in this initial stage.
  - In the region of 40% of this data will be taken with approximately 0.8 interactions per bunch crossing.
  - In the region of 60% with an average of 1.6 interactions per bunch crossing.
  - Pile-up removal will be important for empty 'rapidity gap' definitions.
- Energy can then be increased to between 4-5 TeV per beam\*. Discussion ongoing as to whether this will take place sooner or later.
  - Number of interactions kept to around 2 per bunch crossing -> pile-up removal techniques as above.
  - Luminosity reaches around  $2 \times 10^{32} \text{cm}^{-2} \text{s}^{-1}$ .
  - Approximately  $250\text{pb}^{-1}$  of data.

This is just the 'current' running scenario. The situation could (i.e. is likely to) be different in some way



## Soft diffraction

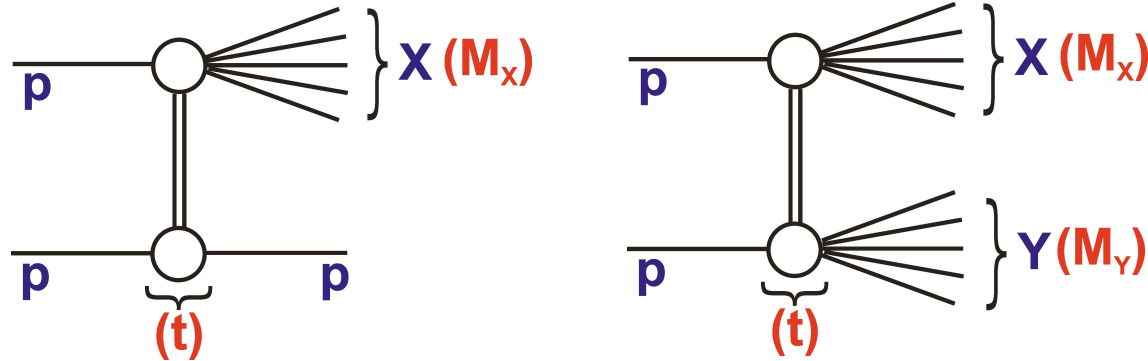

- Single and double diffractive dissociation have large cross section [ $O(\text{mb})$ ]
- First measurement of rapidity gap processes at LHC – study of underlying event/soft survival. Impacts our understanding pile-up at high luminosity.

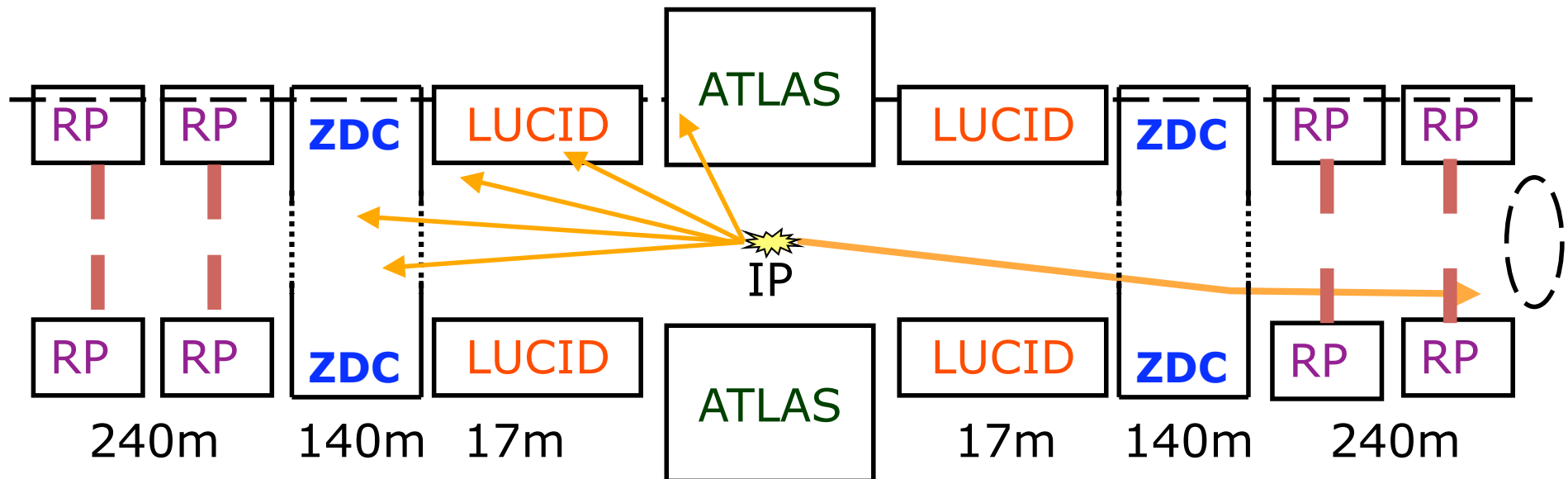

## Soft diffraction (II)



- Rapidity gaps in the calorimeters, LUCID and ZDC used to infer an outgoing proton.

- Diffractive mass,  $M_X$ , of the dissociative system measured and the fractional momentum loss of the (intact) proton defined:

$$\xi = \frac{M_X^2}{s}$$

- $M_X$  measured using calorimeter clusters and tracking information.

- Events retained using the Minimum Bias Trigger Scintillators (MBTS).
  - The MBTS are rings of trigger scintillators covering  $2.09 < |\eta| < 3.84$ .
  - Expect millions of events for analysis.

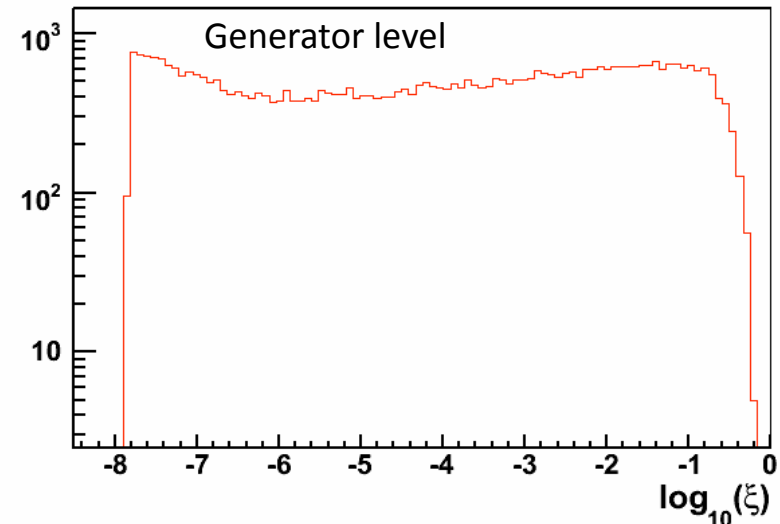
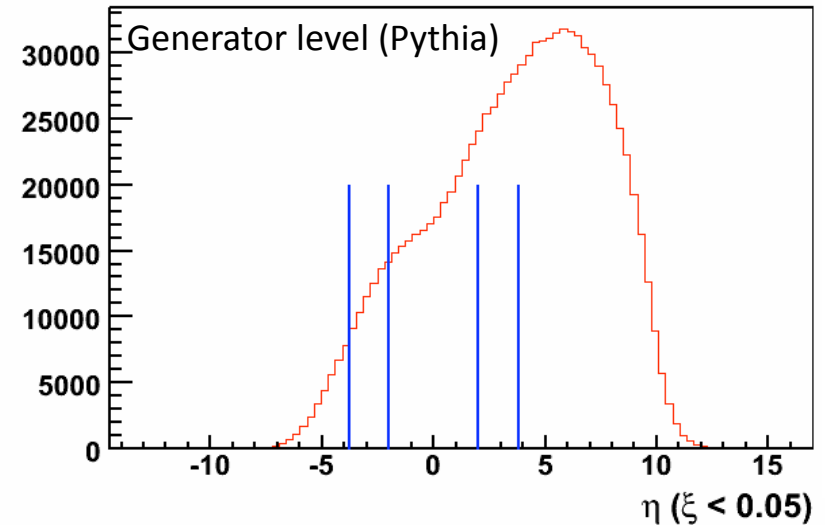

# Diffractive di-jet production



- Aim to measure:
  - Ratio of single diffractive (SD) di-jets to non-diffractive (ND) di-jets.
  - Ratio of double pomeron (DPE) to single diffractive di-jets; infer soft-survival effects.
  - Diffractive structure functions.
- Trigger using single jet triggers.
  - Examining use of LUCID, ZDC, MBTS for gap requirement.
- Expect a few thousand SD di-jet events in  $100\text{pb}^{-1}$  with  $E_T > 20\text{GeV}$  (after trigger pre-scale and gap requirement).
- Expect approximately 10 DPE events in same kinematic region.

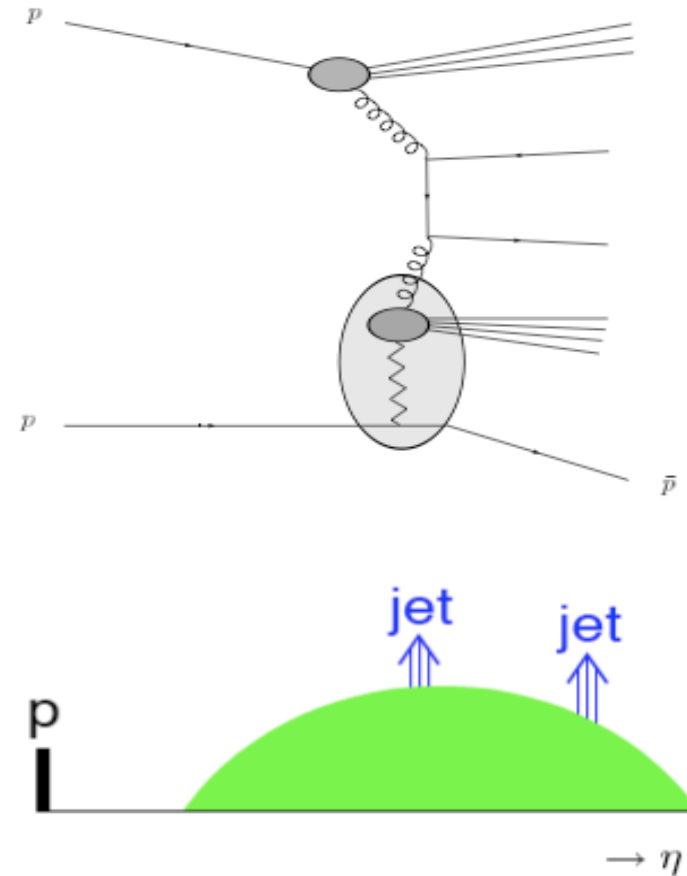





## Central exclusive di-jet production

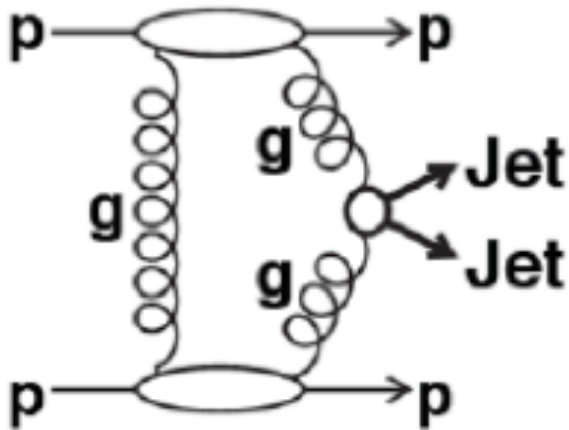

- Protons remain intact during interaction.
  - Observable: Two jets and little extra hadronic activity.
  - Allows study of theoretical framework, such as Sudakov effects and unintegrated PDFs.
  - Constrain theoretical uncertainty (factor of 2-3).
- New Level 1 trigger strategy developed for analysis using jet plus gap; gap defined by empty MBTS on one side of ATLAS.
    - Un-prescaled at  $L=10^{31}\text{cm}^{-2}\text{s}^{-1}$ .
    - Expect a few hundred CEP events after trigger and analysis cuts with  $E_T > 20\text{GeV}$  in  $20\text{pb}^{-1}$  of data.
  - Trigger can also be used to retain a large statistics sample of low- $\xi$  single diffractive di-jet events.

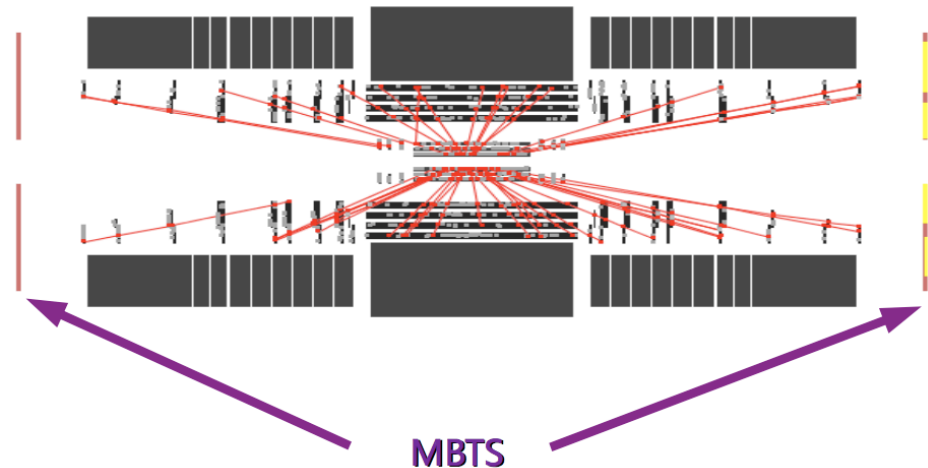



Exclusive  $\tau$  production

- Exclusive  $\tau$  production has a small theoretical uncertainty (<1%).
  - Cross section prediction (LPAIR) is 3pb (elastic + inelastic) for  $p_T(\tau) > 10\text{GeV}$ .
  - From offline selection, expect around 100 events in  $100\text{pb}^{-1}$
  - Events triggered using
    - (a) single lepton trigger and
    - (b) jet + gap trigger used in exclusive di-jet study.

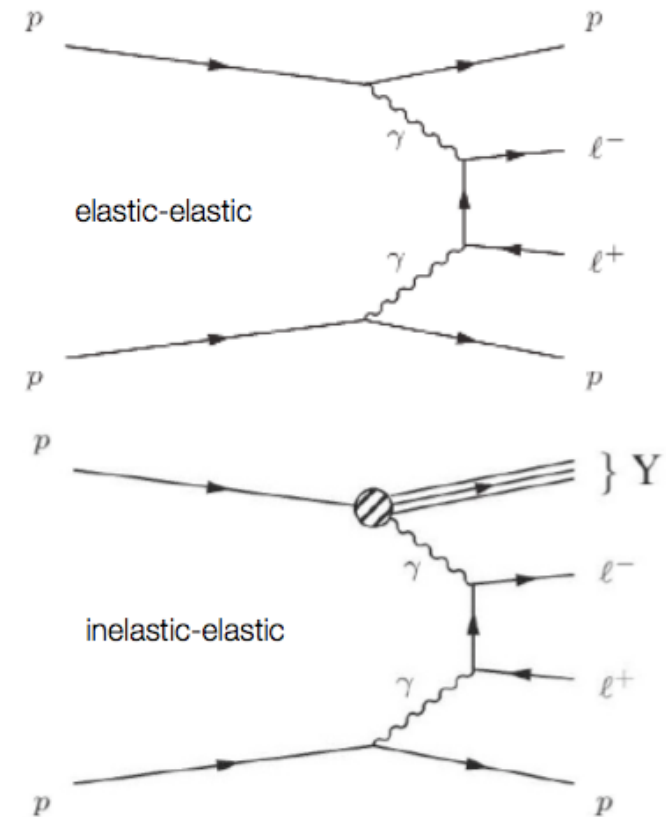
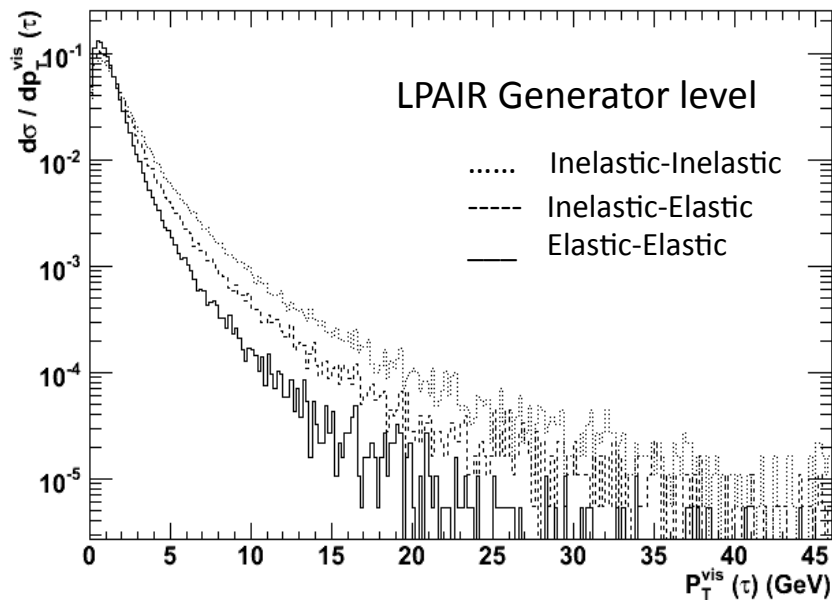

## Forward jet studies (I)

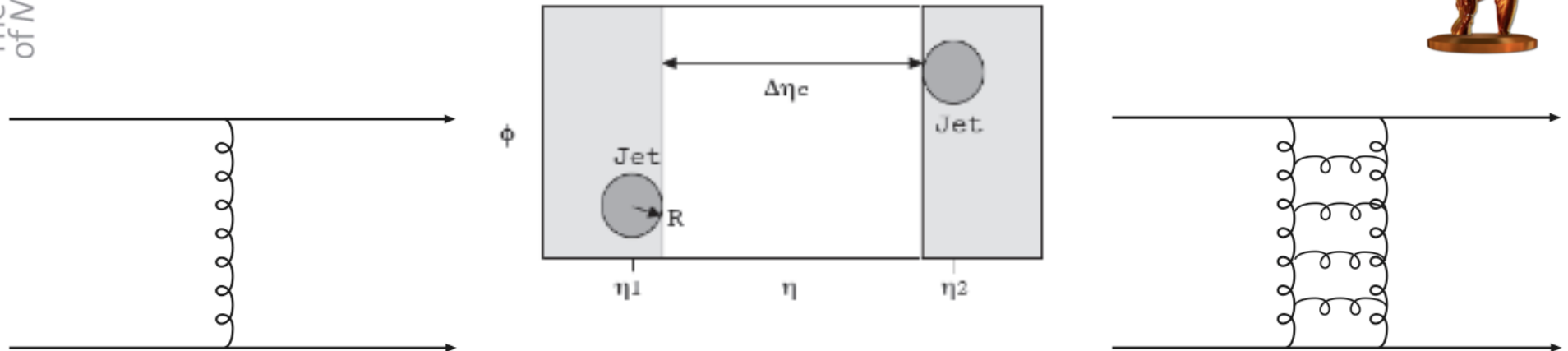

- Di-jet systems in which the jets are separated by at least 3 units of pseudo-rapidity.
- Two processes contribute:
  - Gluon (or quark) exchange between partonic 2->2 scatters (dominant).
  - Hard colour singlet (BFKL gluon ladder) exchange. Up to 10% of di-jet cross section.
- ATLAS measurements will focus on both inclusive measurements and those in which radiation between the jets is limited.
- Calorimeters give a lever arm of up to 9 units in jet-rapidity separation, when using jets with radius parameter set to 0.4.

## Forward Jets (II) – Azimuthal de-correlation



- Di-jets are back-to-back in azimuth,  $\Delta\phi = \pi$ , for leading order 2 $\rightarrow$ 2 scattering.
- Additional radiation means that  $\Delta\phi < \pi$
- De-correlation depends on  $E_T$  of the additional radiation.
- Theoretical predictions can be made for this de-correlation using fixed order (NLO), parton shower and BFKL.
- For 1-5 $\text{pb}^{-1}$ , expect very early measurement for  $|\eta| < 2.5$ .
- Observation of any BFKL effects at large  $\Delta\eta$  will probably require more than 100 $\text{pb}^{-1}$  of data.

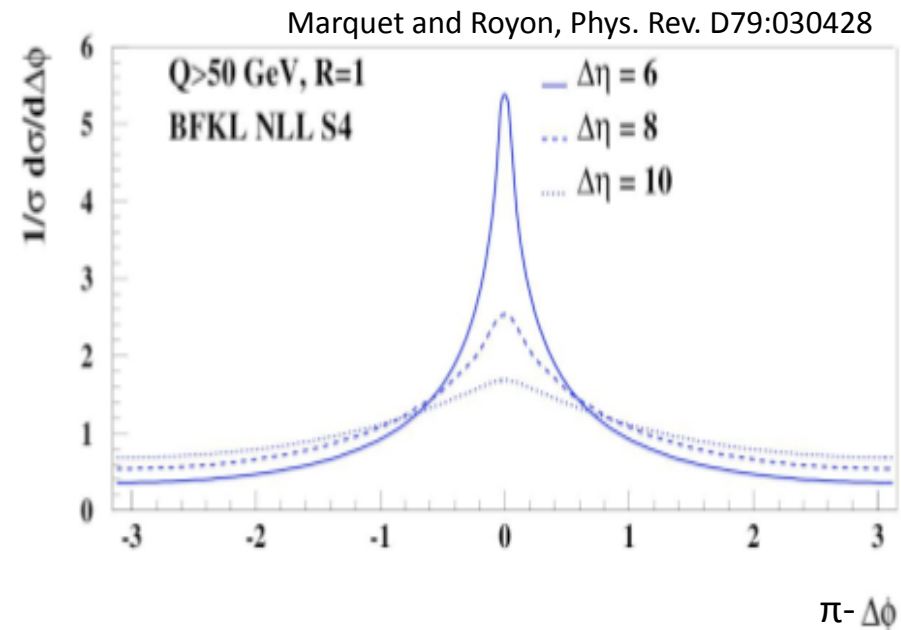
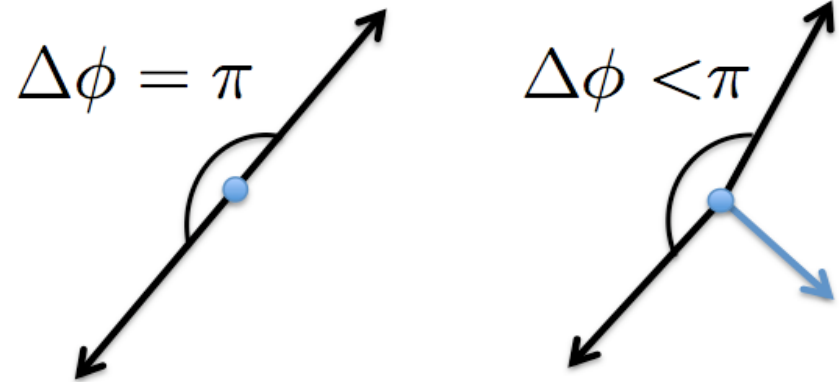

## Gaps-between-jets (I) – wide angle gluon radiation



- Gaps-between-jets events identified by vetoing on additional radiation between the two leading jets.
- Infrared safe veto definition needed, such as  $E_T$  of veto-jet or  $\Sigma E_T$  in calorimeter.
- Observable of interest is the gap-fraction, i.e. the ratio of gap-events to inclusive di-jet events as a function of leading jet  $E_T$  and separation of jets.
- Moderately separated jets sensitive to higher order QCD effects, such as differences between parton shower and matrix element generators (left), Glauber-Coulomb gluons (right) etc.

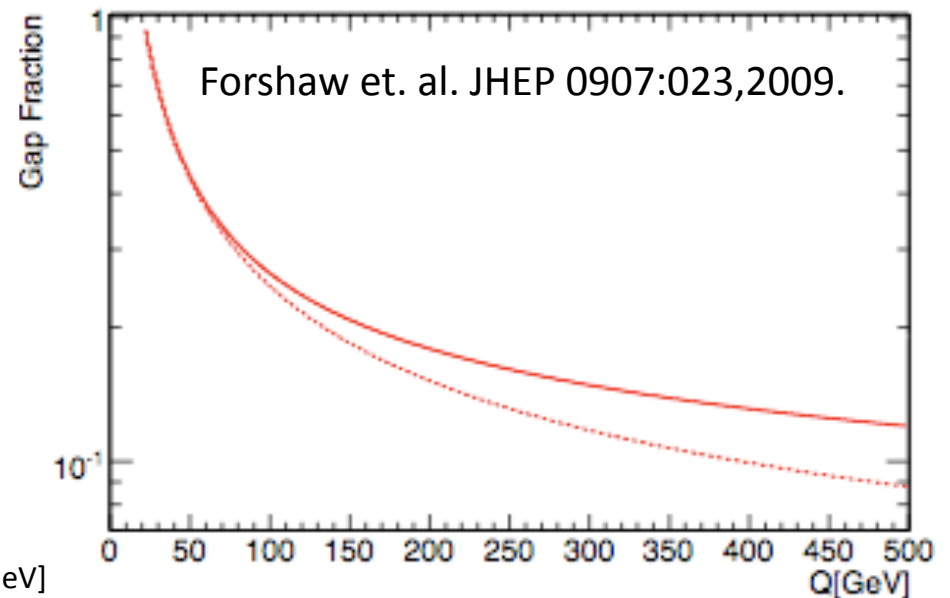
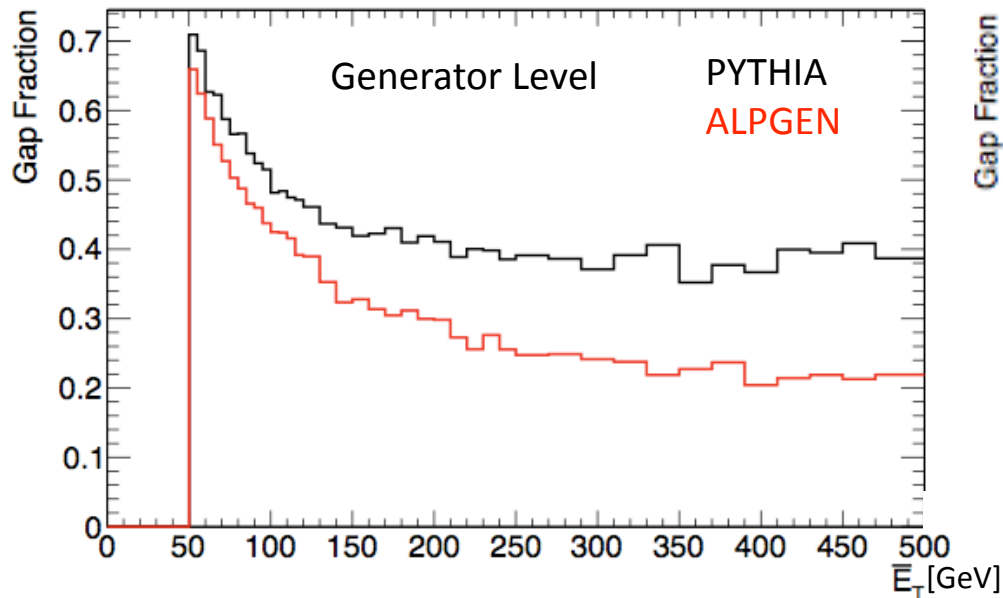

## Gaps-between-jets (II) – hard colour singlet exchange



- For large jet pseudo-rapidity separation, colour singlet exchange starts to become increasingly important:
  - Two leading jets identified ( $E_T > 30\text{GeV}$ ).
  - Gap events defined (in this case) using the H1 methodology, by summing the transverse energy between leading jets, i.e.  $E_T^{\text{gap}} < 10\text{GeV}$ .
- Expect CSE events to have  $E_T^{\text{gap}} \approx 0$ .
  - But get many events with higher values due to multiple parton-parton interactions.
  - Measurement should be possible with around  $10\text{pb}^{-1}$  of data.
  - BFKL predicts a rise in the gap fraction due to hard colour singlet exchange.

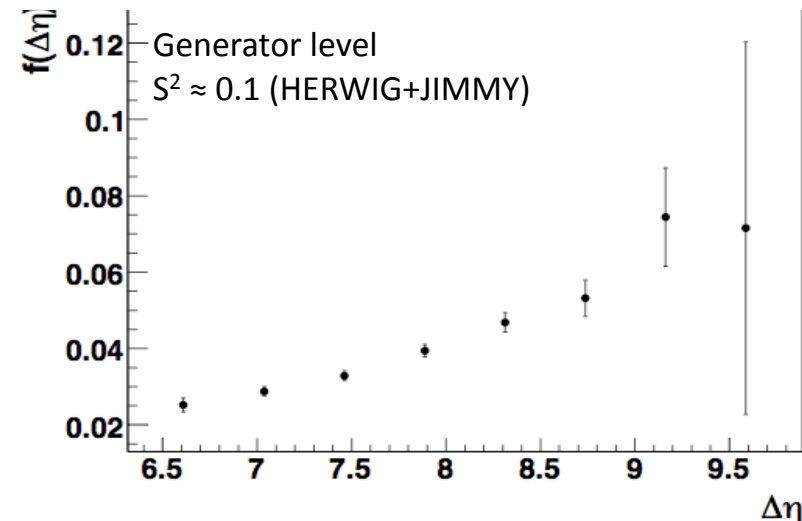
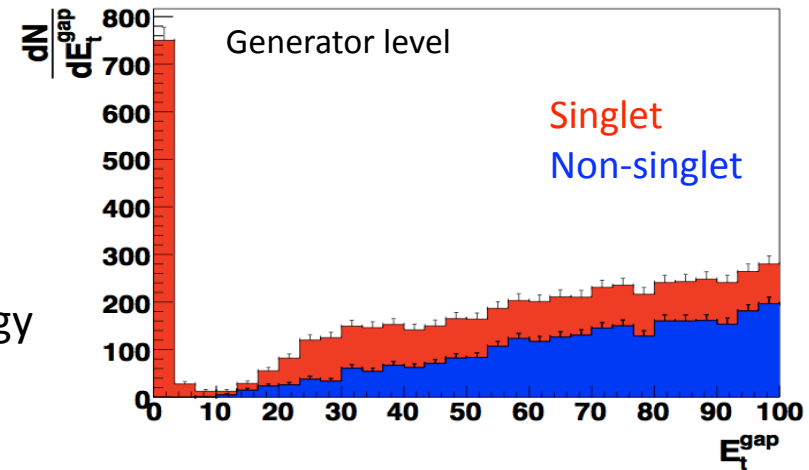

## Beyond 2010 – ALFA based SD measurements



- ALFA can be used during special ‘luminosity’ runs to measure soft-SD proton spectrum.
- Hits in LUCID and energy in ZDC are used to tag the diffractive dissociation.
- Proton tag in ALFA – measure proton  $\xi$ .
- 1.2-1.8 million events with 100hrs at  $L=10^{27}\text{cm}^{-2}\text{s}^{-1}$ .
- BUT, ALFA requires special running conditions.

Efficiency [%]	Pythia	Phojet
Preselection		
$\xi < 0.2$	97.1	94.8
ZDC [ $E > 1$ TeV]	53.9	38.7
LUCID [1 track]	45.2	57.3
Total preselection	75	74
RP selection		
ALFA (Relative to preselection)	60.1	54.2
Total acceptance	45.0	40.1

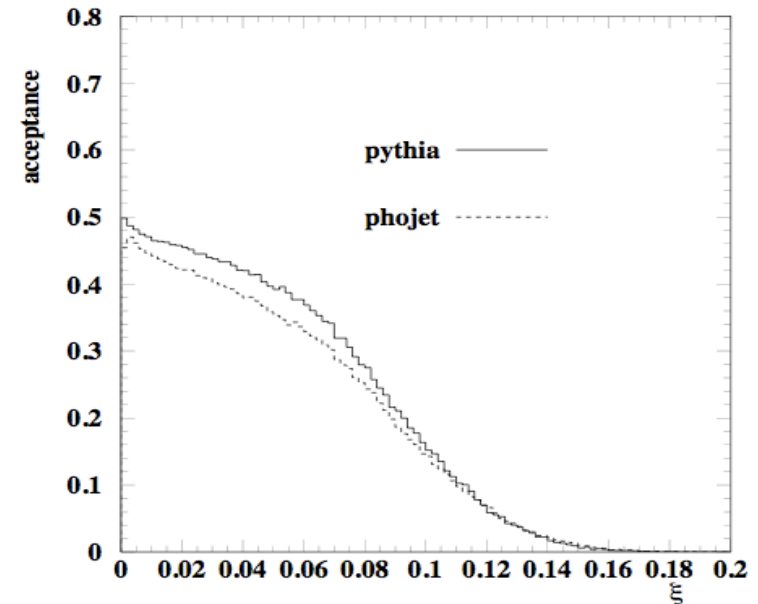

- Want to measure the diffractive  $\xi$  distribution:

$$\xi = 1 - \frac{|p'_z|}{|p_z|}$$

- $p_z$  = beam momentum
- $p'_z$  = outgoing proton momentum



# The ATLAS Forward Proton project

Forward protons measured from CEP

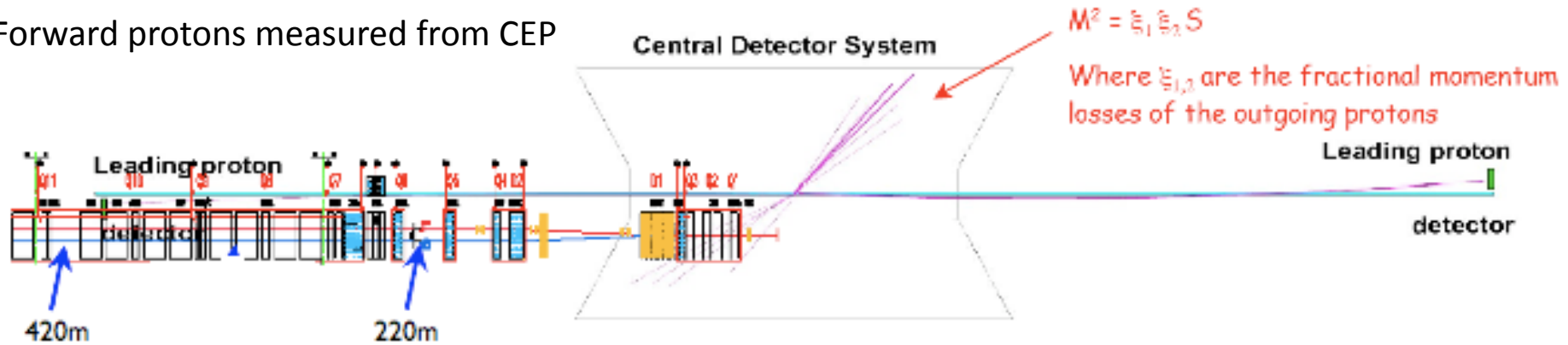

- AFP project proposes to install new detectors at 220m and 420 either side of IP.
- Main aim: To detect both protons from exclusive interactions up to  $L=10^{34} \text{cm}^{-2} \text{s}^{-1}$ .
- SUSY, Higgs, BSM physics, plus wide range of QED and QCD possible
- Resonance mass measured regardless of decay channel.
- See detailed talk by [M. Tasevsky](#).

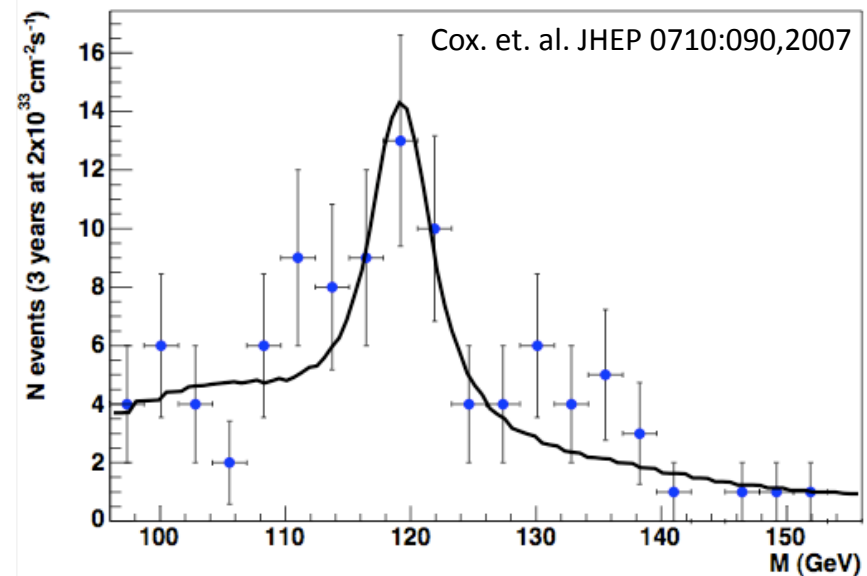



# Summary



## **2009/2010 measurements with up to 10pb<sup>-1</sup>:**

- 1) Soft single and double diffraction.
- 2) Forward jet azimuthal de-correlations up to moderate  $\Delta\eta$ .
- 3) Gaps-between-jets.

## **2009/2010 measurements with up to 200pb<sup>-1</sup>:**

- 1) Exclusive di-jet and di-tau production.
- 2) Single diffractive di-jet production.
- 3) Extended phase space for forward jet studies.

## **Prospects after 2010:**

- 1) Single diffraction (and elastic scattering) with ALFA.
- 2) New physics studies if AFP is installed.