



Searches for New Physics with the MoEDAL detector at the LHC

Vasiliki A. Mitsou

for the MoEDAL Collaboration

17th HELLENIC SCHOOL AND WORKSHOPS ON ELEMENTARY
PARTICLE PHYSICS AND GRAVITY

Workshop on the Standard Model and Beyond

September 2 – 10, 2017, Corfu, Greece

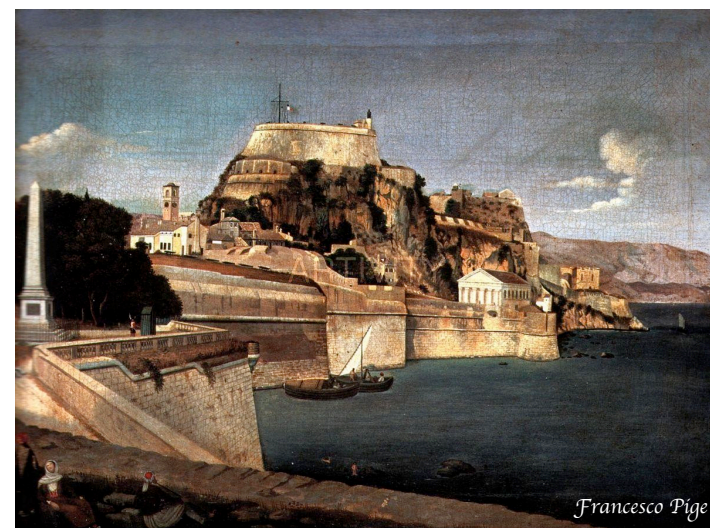

MoEDAL at LHC

Monopole & Exotics Detector At LHC

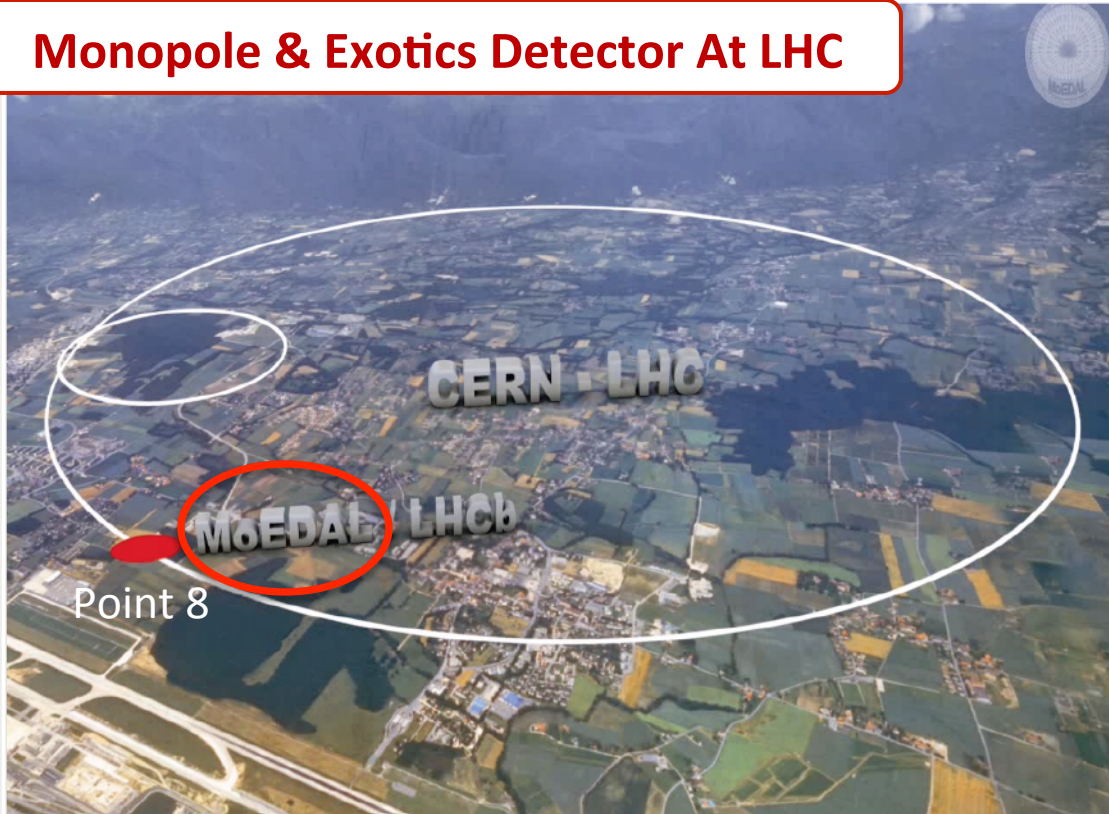

**International collaboration
~70 physicists from
~20 participating institutions**

UNIVERSITY OF ALABAMA
UNIVERSITY OF ALBERTA
INFN & UNIVERSITY OF BOLOGNA
UNIVERSITY OF BRITISH COLUMBIA
CERN
UNIVERSITY OF CINCINNATI
CONCORDIA UNIVERSITY
GANGNEUNG-WONJU NATIONAL UNIVERSITY
UNIVERSITÉ DE GENÈVE
UNIVERSITY OF HELSINKI
IMPERIAL COLLEGE LONDON
KING'S COLLEGE LONDON
KONKUK UNIVERSITY
UNIVERSITY OF MÜNSTER
MOSCOW INSTITUTE OF PHYSICS AND TECHNOLOGY
NORTHEASTERN UNIVERSITY
TECHNICAL UNIVERSITY IN PRAGUE
QUEEN MARY UNIVERSITY OF LONDON
INSTITUTE FOR SPACE SCIENCES, ROMANIA
STAR INSTITUTE, SIMON LANGTON SCHOOL
TUFT'S UNIVERSITY
IFIC VALENCIA



Key feature: high ionisation

$$\frac{\text{charge}}{\text{velocity: } \beta = v/c} = z/\beta$$

$$-\frac{dE}{dx} = K \frac{Z}{A} \frac{1}{\beta^2} \left[\frac{1}{2} \ln \frac{2m_e c^2 \beta^2 \gamma^2 T_{\max}}{I^2} - \beta^2 - \frac{\delta}{2} \right]$$

Electric charge

Bethe-Bloch formula

High ionisation (HI) possible when:

- multiple electric charge (H^{++} , Q-balls, etc.) = $n \times e$
- very low velocity & electric charge, i.e. [Stable Massive Charged Particles \(SMCPs\)](#)
- magnetic charge (monopoles, dyons) = $ng_D = n \times 68.5 \times e$
 - a singly charged relativistic monopole has ionisation ~ 4700 times MIP!!
- any combination of the above

MoEDAL detectors have a threshold of $z/\beta \sim 5 - 10$

$$-\frac{dE}{dx} = K \frac{Z}{A} \frac{g^2}{\beta^2} \left[\ln \frac{2m_e c^2 \beta^2 \gamma^2}{I_m} + \frac{K|g|}{2} - \frac{1}{2} - B(g) \right]$$

Magnetic charge

Ahlen formula

Particles must be **massive**, **long-lived** & **highly ionising** to be detected at **MoEDAL**

MoEDAL sensitivity

Cross-section limits for magnetic and electric charge assuming that:

- ~ one MoEDAL event is required for discovery and ~100 events in the other LHC detectors
- integrated luminosities correspond to about two years of 14 TeV run

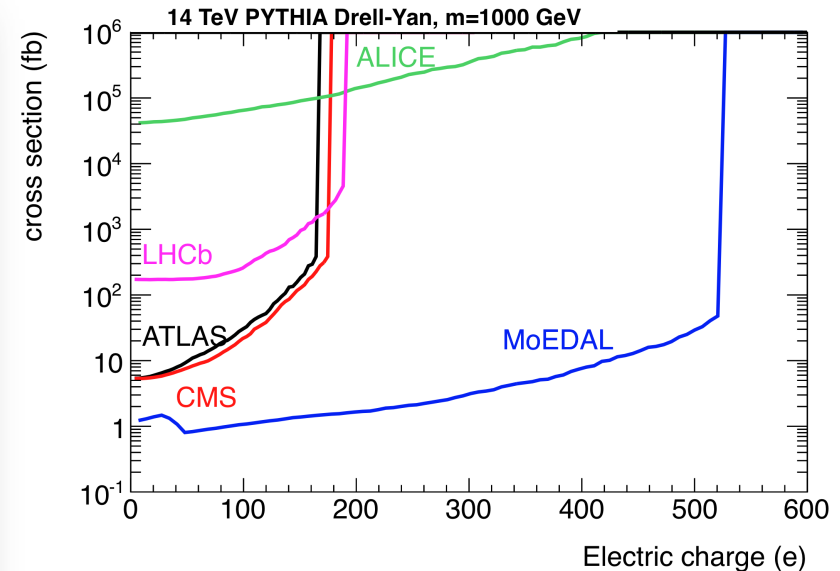
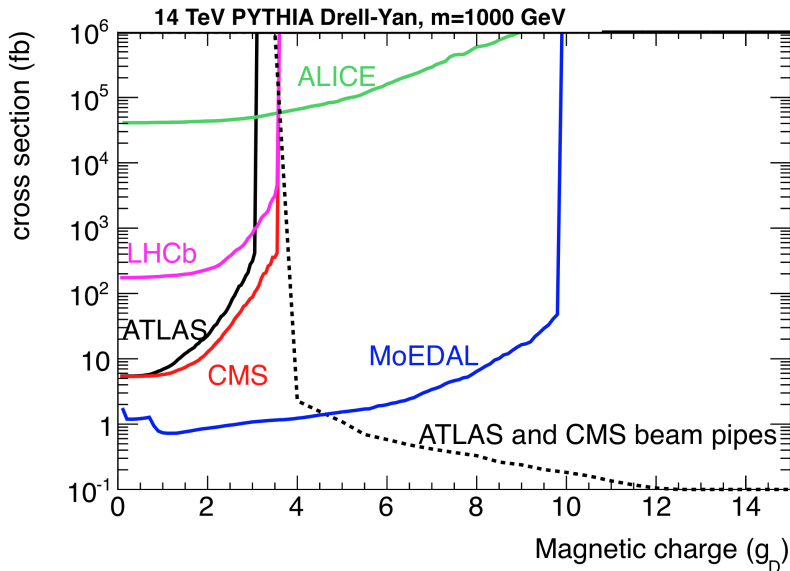

De Roeck, Katre, Mermoud, Milstead, Sloan, EPJC72 (2012) 1985 [arXiv:1112.2999]

MoEDAL offers robustness against timing and well-estimated signal efficiency

MoEDAL physics programme

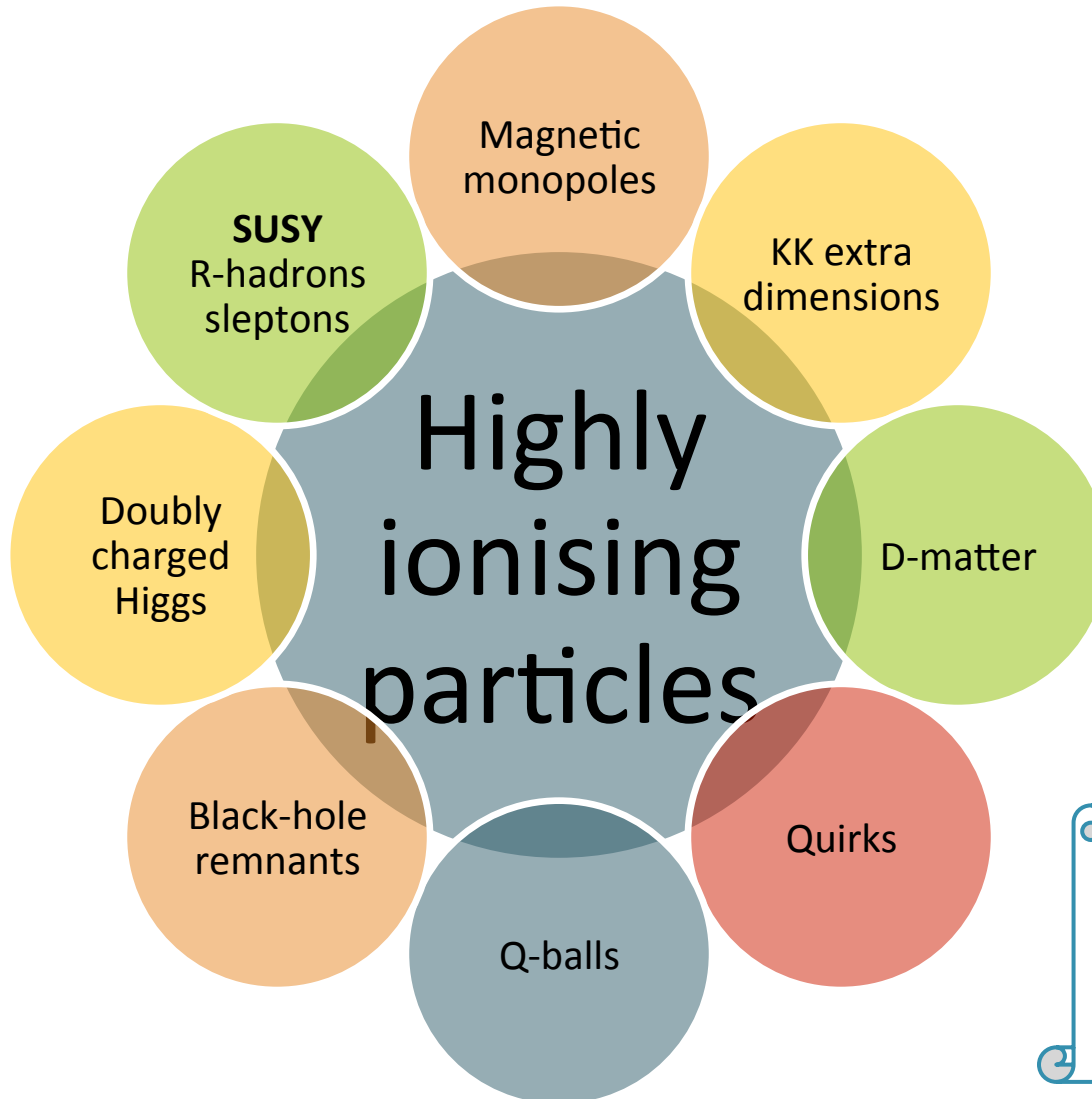

Searching for
massive,
long-lived &
highly ionising
particles

MoEDAL physics program
Int. J. Mod. Phys. A29 (2014)
1430050
[arXiv:1405.7662]

The MoEDAL detector components

MoEDAL detector

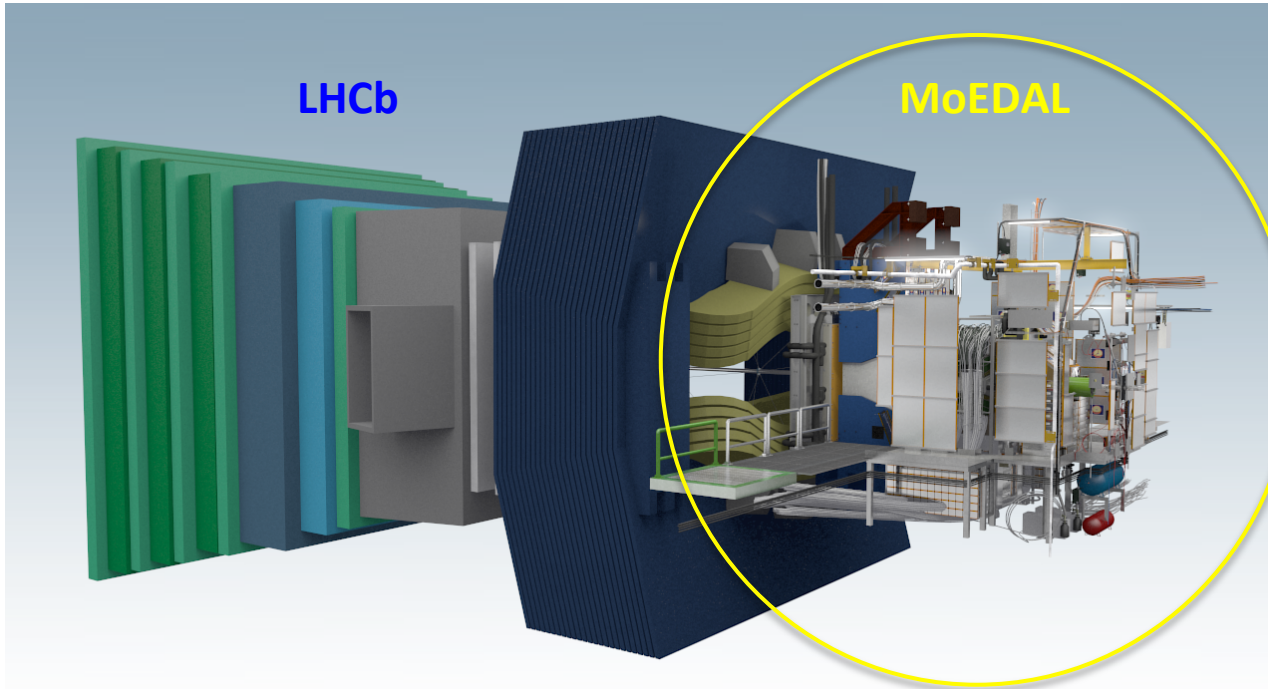

DETECTOR SYSTEMS

- ① Low-threshold NTD (LT-NTD) array
 - $z/\beta > \sim 5 - 10$
- ② Very High Charge Catcher NTD (HCC-NTD) array
 - $z/\beta > \sim 50$
- ③ TimePix radiation background monitor
- ④ Monopole Trapping detector (MMT)

MoEDAL is unlike any other LHC experiment:

- mostly **passive detectors**; no trigger; no readout
- the largest deployment of passive **Nuclear Track Detectors (NTDs)** at an accelerator
- the 1st time **trapping detectors** are deployed as a detector

① & ② HI particle detection in NTDs

- Passage of a highly ionising particle through the plastic NTD marked by an invisible damage zone (“**latent track**”) along the trajectory
- The damage zone is revealed as a **cone-shaped etch-pit** when the plastic sheet is chemically etched
- Plastic sheets are later **scanned** to detect etch-pits

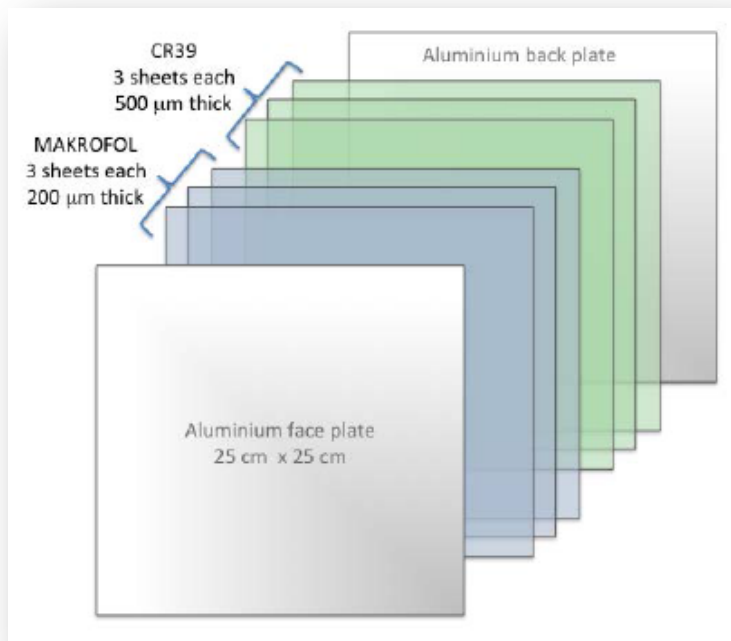
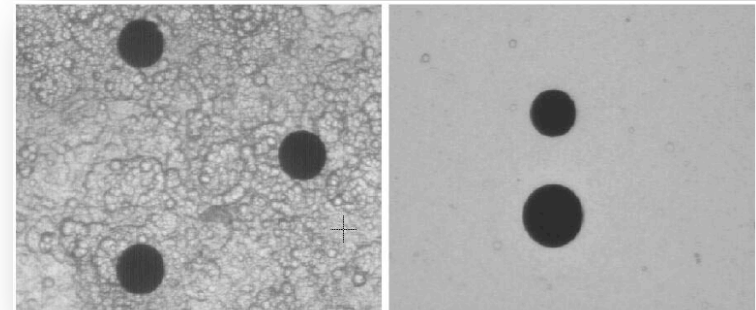
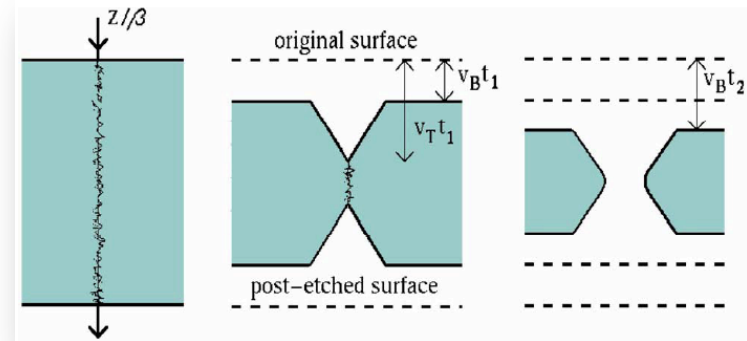

Looking for
aligned etch pits
in multiple sheets

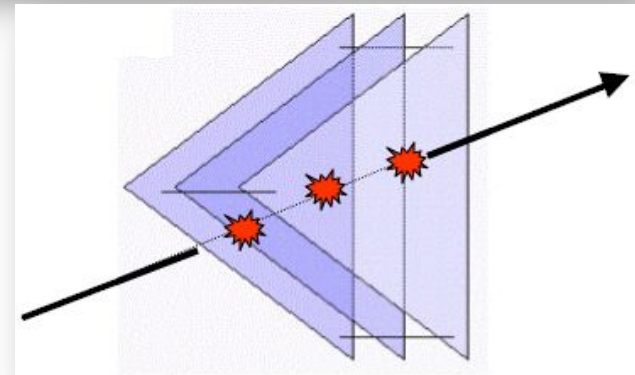

① & ② NTDs deployment

2012: LT-NTD

NTDs sheets kept in boxes mounted onto LHCb VELO cavern walls



2015-2016: LT-NTD

Top of VELO cover
Closest possible location to IP

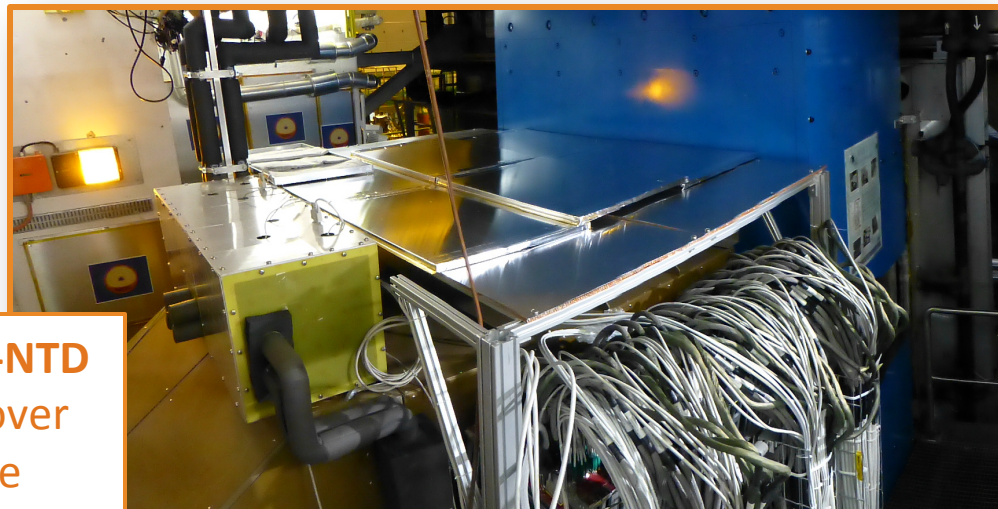

2015-2016: HCC-NTD

Installed in LHCb acceptance
between RICH1 and TT

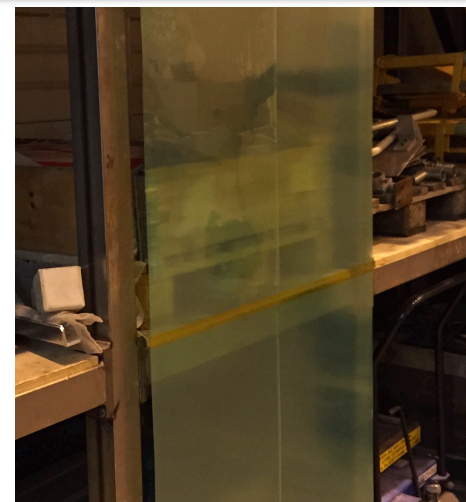

3 TimePix radiation monitor

- Timepix (MediPix) chips used to measure online the radiation field and monitor spallation product background
- Essentially act as little electronic “bubble-chambers”
- The only active element in MoEDAL

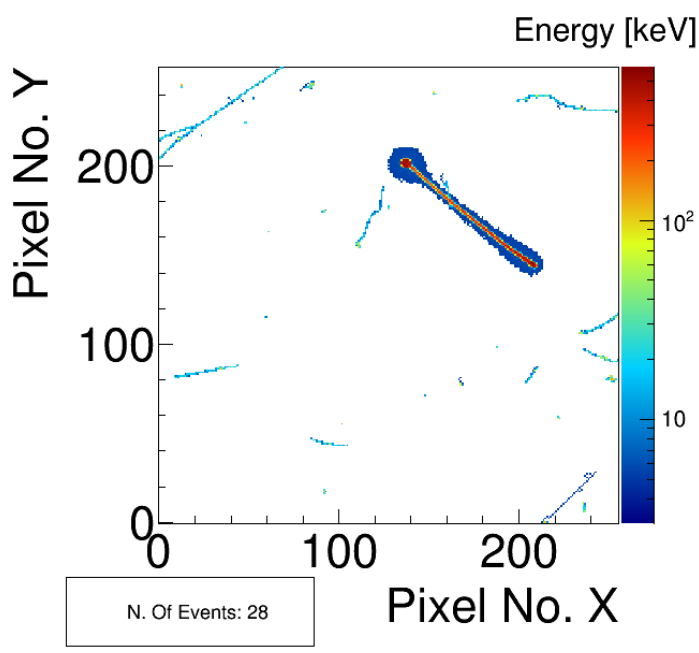
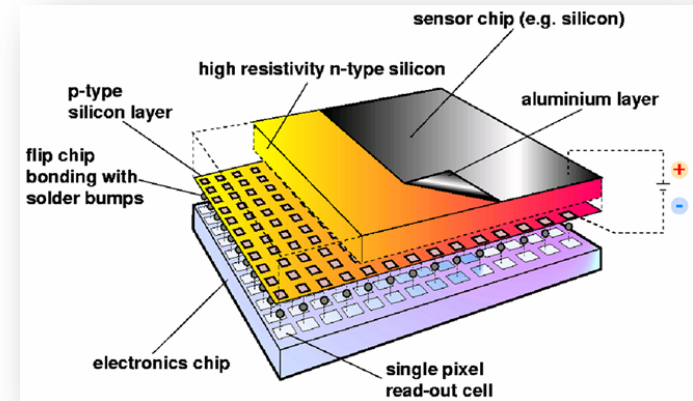

Sample calibrated frame in MoEDAL TPX04

2015 deployment
of MediPix chips
in MoEDAL

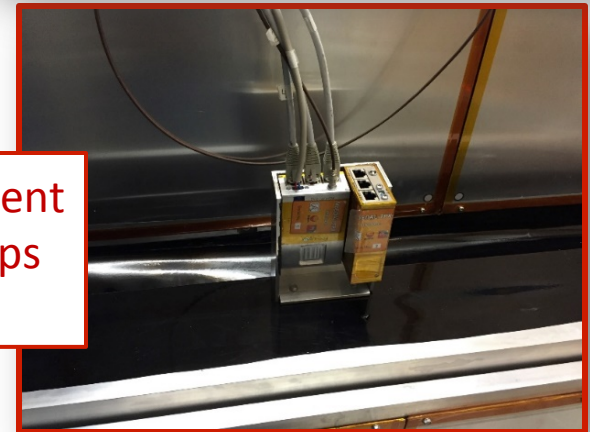

- 256×256 pixel solid state detector
- 14×14 mm active area
- amplifier + comparator + counter + timer

4 MMT: Magnetic Monopole Trapper

- **Binding energy** of monopoles in nuclei with finite magnetic dipole moments of $\mathcal{O}(100 \text{ keV})$
- MMTs analysed with superconducting quantum interference device (**SQUID**)
- Material: **Aluminium**
 - large nuclear dipole moment
 - relatively cheap
- **Persistent current:** difference between resulting current after and before
 - first subtract current measurement for empty holder
 - if other than zero \rightarrow *monopole signature*

Typical sample & pseudo-monopole curves

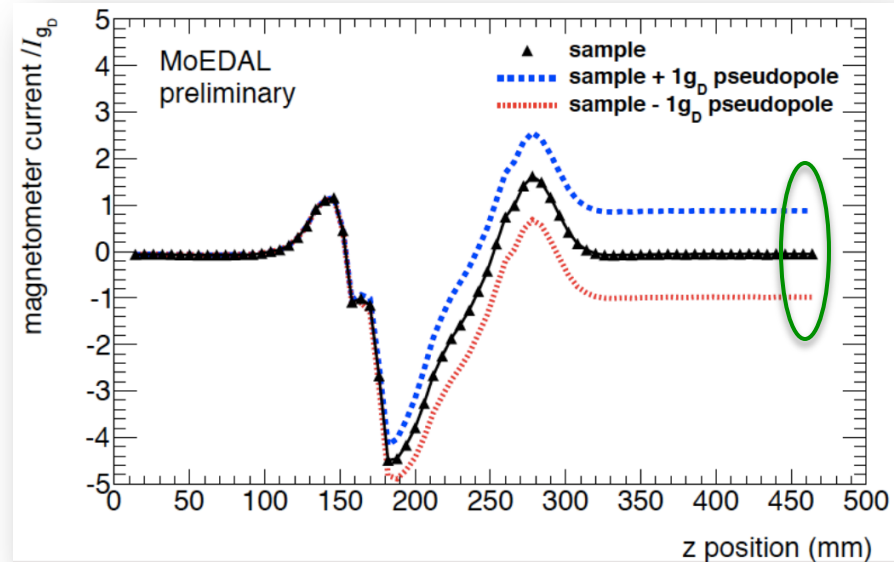
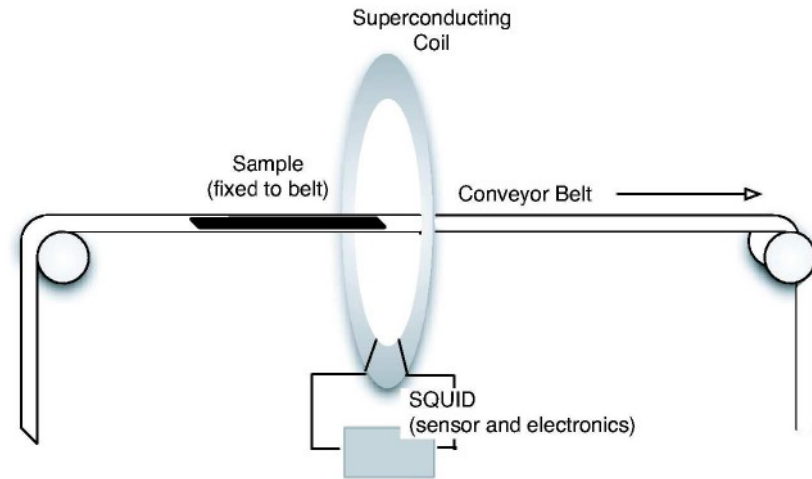

MMTs deployment

2012

11 boxes each containing 18 Al rods of 60 cm length and 2.54 cm diameter (**160 kg**)

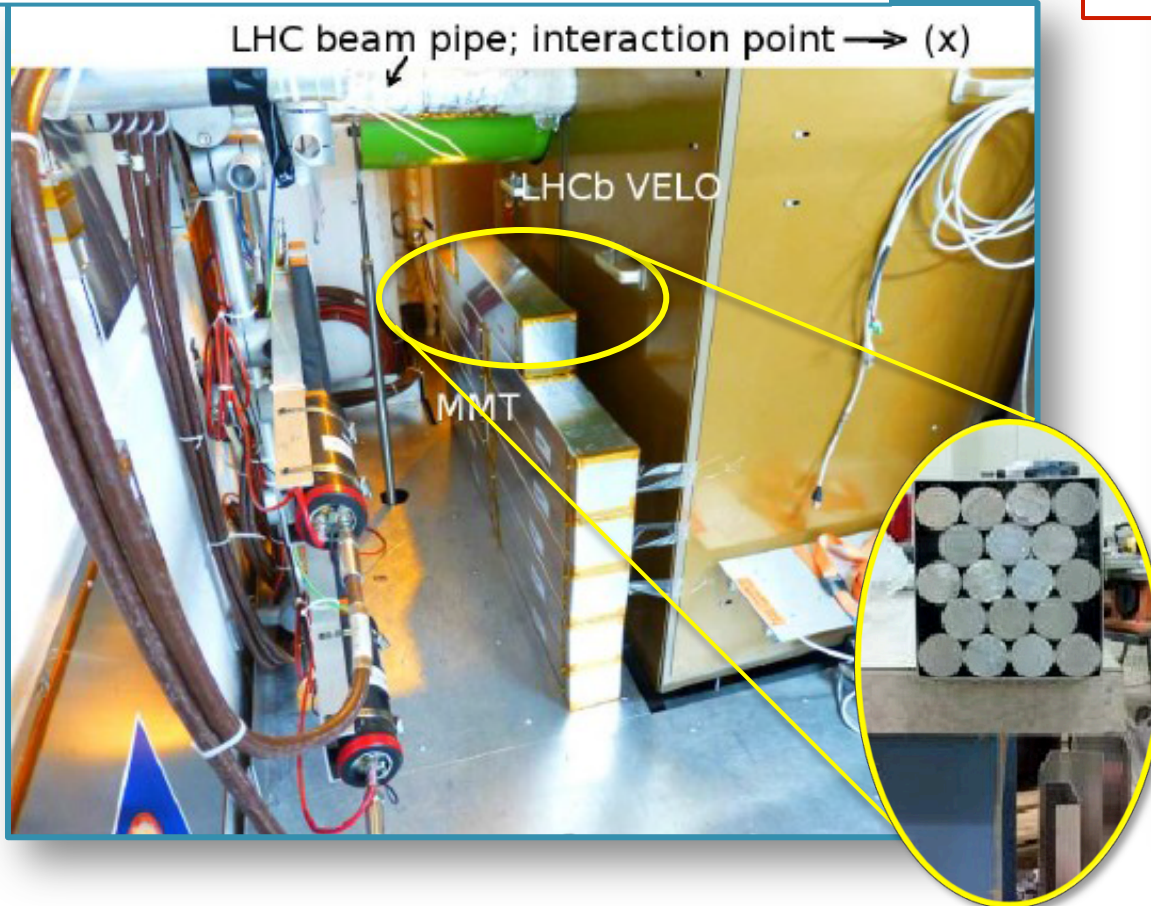

2015-2016

- Installed in additional locations: sides A & C, too
- Approximately **800 kg** of Al
- Total 2400 aluminum bars



Results on monopole mass & charge from MMTs

- **@ 8 TeV** JHEP 1608 (2016) 067 [arXiv:1604.06645]
- **@ 13 TeV** Phys.Rev.Lett. 118 (2017) 061801 [arXiv:1611.06817]

Magnetic monopoles

- Motivation
 - symmetrisation of Maxwell's eqs.
 - electric charge quantisation
- Properties
 - magnetic charge = $ng = n \times 68.5e$
 - coupling constant = $g/\hbar c \sim 34$
 - spin and mass not predicted

Name	Without Magnetic Monopoles	With Magnetic Monopoles
Gauss's law:	$\vec{\nabla} \cdot \vec{E} = 4\pi\rho_e$	$\vec{\nabla} \cdot \vec{E} = 4\pi\rho_e$
Gauss' law for magnetism:	$\vec{\nabla} \cdot \vec{B} = 0$	$\vec{\nabla} \cdot \vec{B} = 4\pi\rho_m$
Faraday's law of induction:	$-\vec{\nabla} \times \vec{E} = \frac{\partial \vec{B}}{\partial t}$	$-\vec{\nabla} \times \vec{E} = \frac{\partial \vec{B}}{\partial t} + 4\pi\vec{J}_m$
Ampère's law (with Maxwell's extension):	$\vec{\nabla} \times \vec{B} = \frac{\partial \vec{E}}{\partial t} + 4\pi\vec{J}_e$	$\vec{\nabla} \times \vec{B} = \frac{\partial \vec{E}}{\partial t} + 4\pi\vec{J}_e$

HIGHLY IONISING

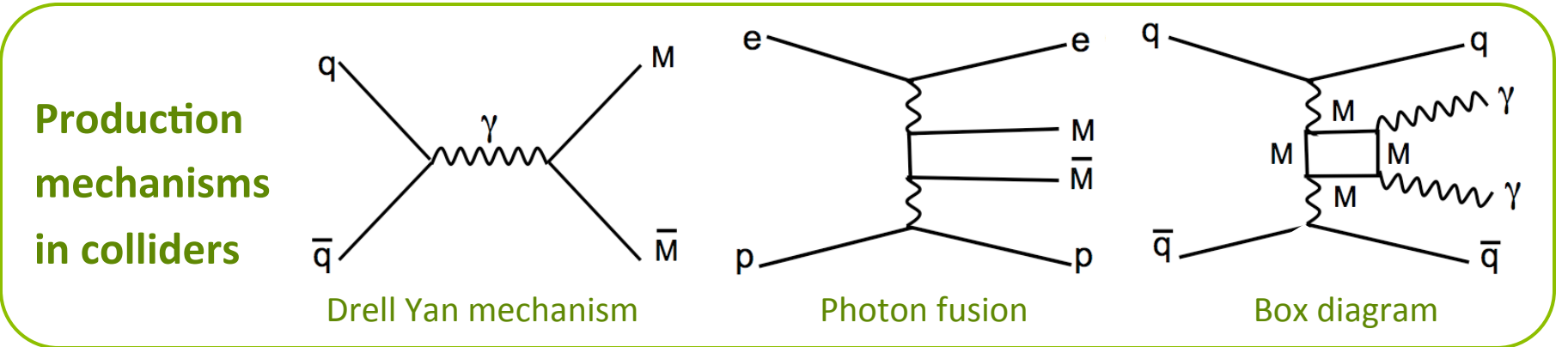

MoEDAL improves reach of monopole searches w.r.t. cross section & charge

MMT2015: scanning

- Analysed with SQUID at ETH Zürich
- Excellent charge resolution ($< 0.1 g_D$) except for outliers

Detector: prototype of **222 kg** of aluminium bars

Exposure: **0.371 fb^{-1}** of **13 TeV** pp collisions during 2015

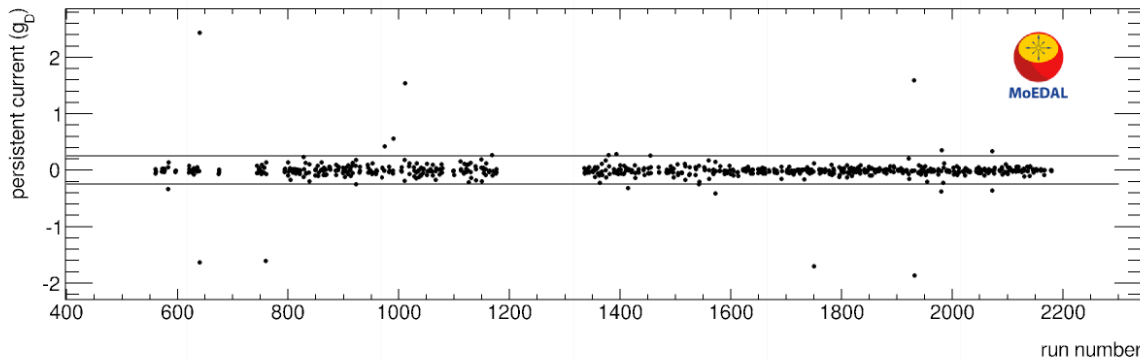

Persistent current after first passage for all samples

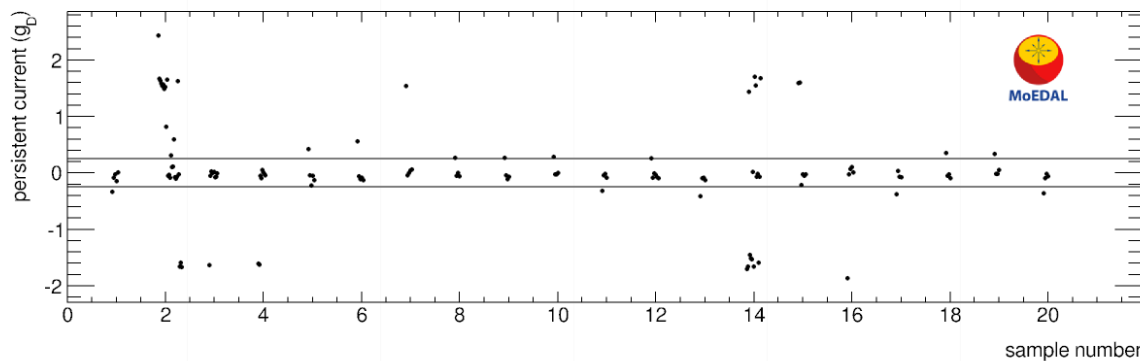

Persistent current for multiple measurements of candidates

PRL 118 (2017) 061801
[arXiv:1611.06817]

No monopole with charge $> 0.5 g_D$ observed in MMT samples at 99.5% CL

MMT2015: analysis

Geometry

Material description between IP & detector

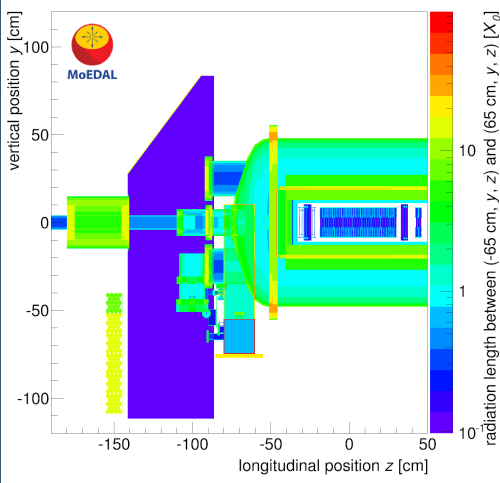

Kinematics

Event generation of Drell Yan production

coupling $\gg 1 \Rightarrow$ non-perturbative!

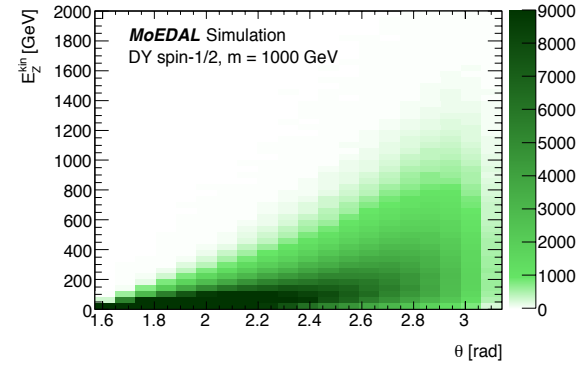
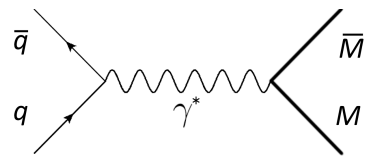

JHEP 1608 (2016) 067

Propagation in matter

- Ahlen formula
- Monopole energy loss
- Stopping range

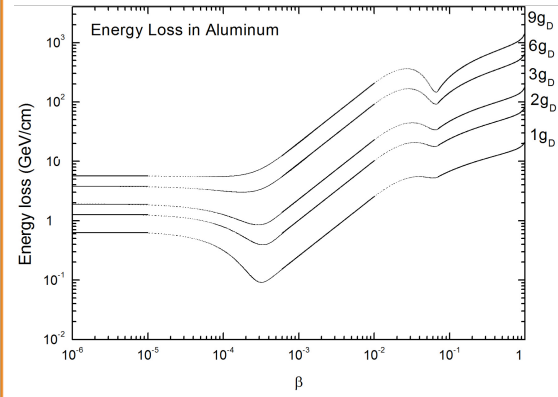

arXiv:1606.01220

MMT2015: results

Detector: prototype of **222 kg** of aluminium bars
 Exposure: **0.371 fb^{-1}** of **13 TeV** pp collisions during 2015

PRL 118 (2017) 061801
 [arXiv:1611.06817]

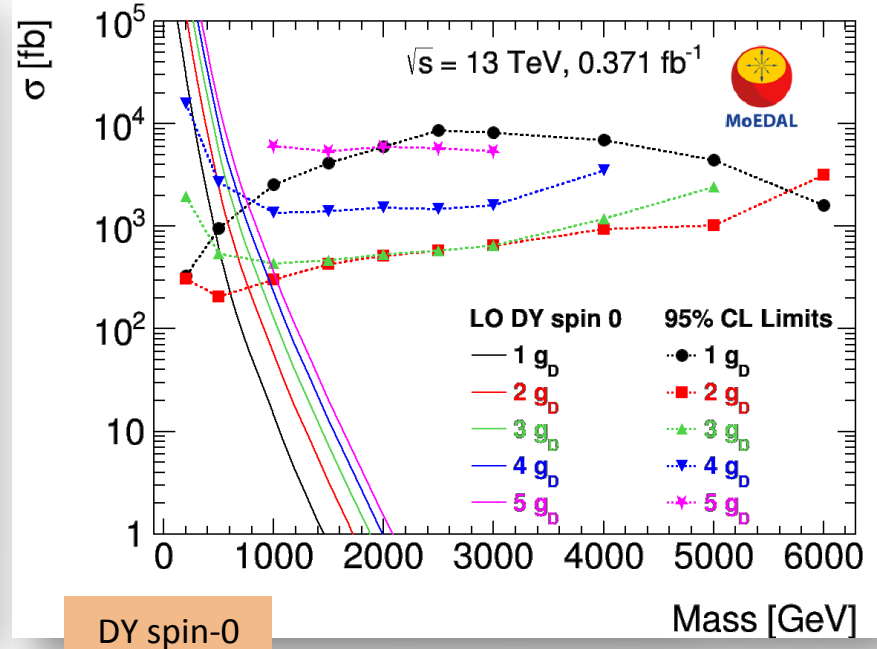
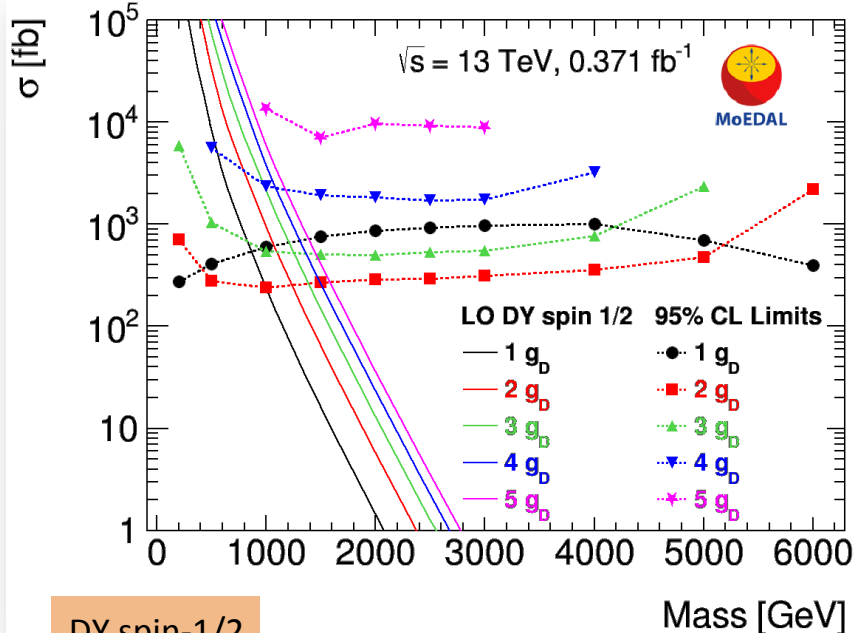

- First monopole searches at **13 TeV** at LHC
- First limits for magnetic charge of **$5 g_D$** and masses **$> 3.5 \text{ TeV}$**

Monopole mass limits

PRL 118 (2017) 061801
[arXiv:1611.06817]

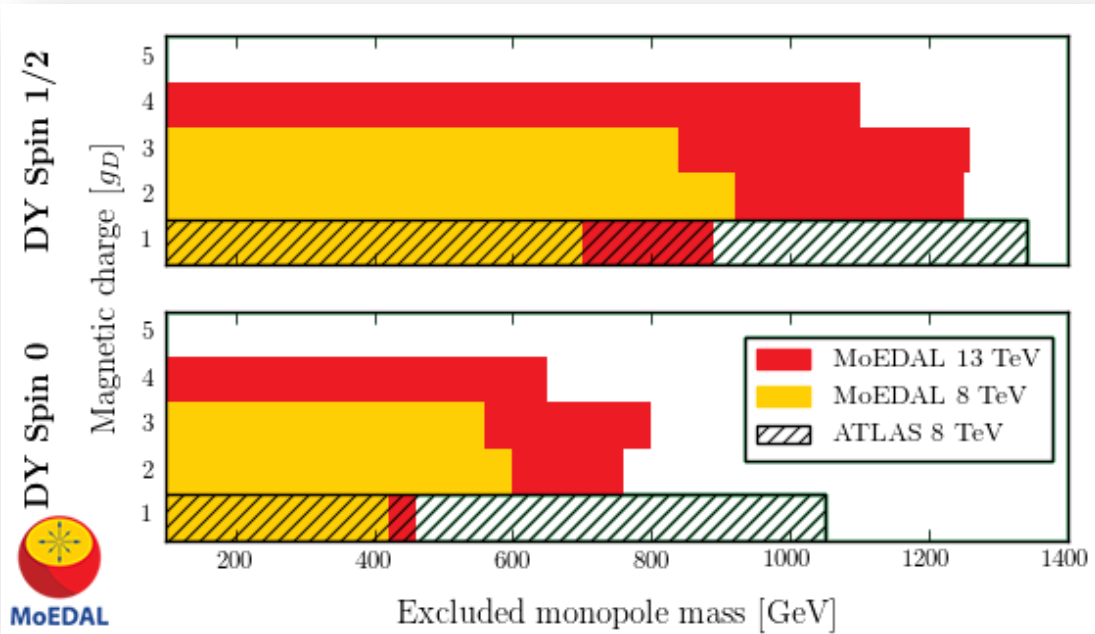

- Mass limits are *highly model-dependent* 
- Exclude low masses for $|g| = 4g_D$ for the first time at LHC
- World-best collider limits for $|g| \geq 2g_D$

DY lower mass limits [GeV]		$ g = g_D$	$ g = 2g_D$	$ g = 3g_D$	$ g = 4g_D$
MoEDAL 13 TeV	spin 1/2	890	1250	1260	1100
	spin 0	460	760	800	650
MoEDAL 8 TeV	spin 1/2	700	920	840	—
	spin 0	420	600	560	—
ATLAS 8 TeV	spin 1/2	1340	—	—	—
	spin 0	1050	—	—	—



Beyond magnetic monopoles

- What about *electrically*-charged particles?

Why MoEDAL when searching SMCPs?

- ATLAS and CMS triggers have to
 - rely on other “objects”, e.g. E_T^{miss} , that accompany SMCPs, thus limiting the reach of the search
 - final states with associated object present
 - trigger threshold set high for high luminosity
 - develop specialised triggers
 - dedicated studies needed
 - usually efficiency significantly less than 100%
- Timing: signal from (slow-moving) SMCP should arrive within the correct bunch crossing
- MoEDAL mainly constrained by its geometrical acceptance
- When looking for trapped particles
 - monitoring of detector volumes in an underground/basement laboratory has less background than using empty bunches in LHC cavern

Slepton searches comparison*

* Indicative numbers

	ATLAS / CMS	MoEDAL	comments
Velocity	$\beta > 0.2$ Constrained by LHC bunch pattern	$\beta < 0.2$ Constrained by NTD Z/ β threshold	Complementarity 😊
Analysis	Not simple, involving several detector components, electronics, triggers, ...	Simple and robust	😊
Efficiency		$\sim 100\%$ (if $\beta \lesssim 0.2$)	😐
Acceptance	$\epsilon \times A$ order of 20% <i>See limitations in previous slide</i>	<ul style="list-style-type: none"> • Geometry: $\sim 50\%$ for 2015; scalable to higher coverage • β-cut yield: $\sim 10\%$ 👉 <i>highly model dependent</i> 	
Background	May be considerable or difficult to estimate	Practically zero	For same signal yield, MoEDAL should have better sensitivity 😊
Luminosity	high	factor of 10-50 less	LIMITING FACTOR 😞

Nuclear Track Detectors coverage

- High acceptance in central region $\eta \sim 0$
 - back-to-back pair production means probability $> \sim 70\%$ for at least one SMCP to hit NTD
- For particles over z/β threshold, detection efficiency practically 100%

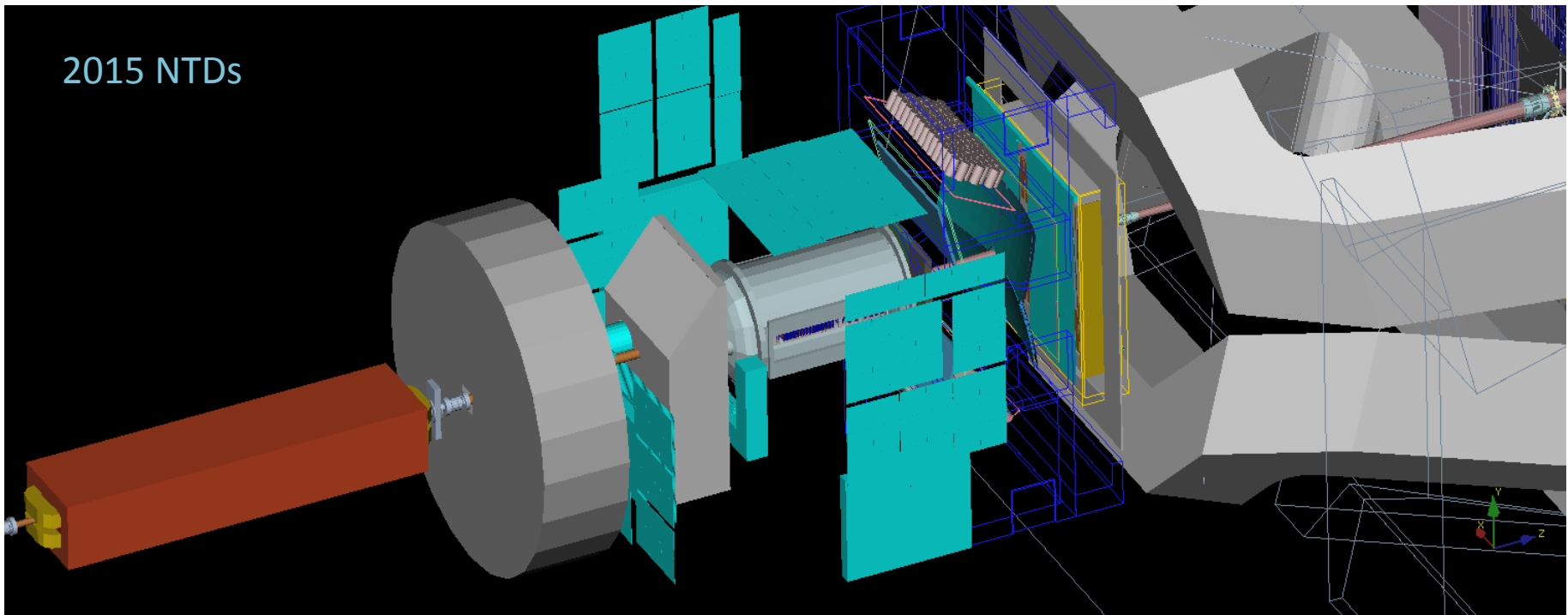

SUSY long-lived particles (*relevant for MoEDAL*)

- Long-lived sleptons (staus mostly)

- **Gauge-mediated symmetry-breaking (GMSB):** stau NLSP decays via gravitational interaction to gravitino LSP

$$\Gamma(\tilde{l} \rightarrow l\tilde{G}) = \frac{1}{48\pi M_*^2} \frac{m_{\tilde{l}}^5}{m_{\tilde{G}}^2} \left[1 - \frac{m_{\tilde{G}}^2}{m_{\tilde{l}}^2} \right]^4$$

- **Coannihilation region in CMSSM:** long lived stau, when $m(\tilde{\tau}) - m(\tilde{\chi}_1^0) < m(\tau)$
 → naturally long lifetime for stau in both cases

- R-hadrons

$$\tilde{\tau} \rightarrow \tau\tilde{\chi}_1^0$$

- **Glunos in Split Supersymmetry:** $\tilde{g}q\bar{q}$, $\tilde{g}qqq$, $\tilde{g}g$
 - long-lived because squarks very heavy
 - gluino hadrons may flip charge as they pass through matter

- **Stops:** $\tilde{t}\bar{q}$, $\tilde{t}qq$

- e.g. stop NLSP in gravitino dark matter

$$\tilde{t} \rightarrow t\tilde{G}$$

- e.g. as LSP in R-parity violating SUSY, long-lived when RPV coupling(s) small

- Long-lived charginos

- **Anomaly-mediated symmetry-breaking (AMSB):** $\tilde{\chi}_1^\pm$ and $\tilde{\chi}_1^0$ are mass degenerate $\Rightarrow \tilde{\chi}_1^\pm$ becomes long-lived

$$\tilde{\chi}_1^\pm \rightarrow \pi^\pm \tilde{\chi}_1^0$$

Results for $\tilde{g}\tilde{g}$, $\tilde{g}\rightarrow jj\tilde{\chi}_1^0$, $\tilde{\chi}_1^0\rightarrow\tau^\pm\tilde{\tau}_1$

$\tilde{\chi}_1^0$ long-lived despite large mass split between $\tilde{\chi}_1^0$ and $\tilde{\tau}_1 \rightarrow$ decays in tracker

(massive) τ^\pm produces a kink between $\tilde{\chi}_1^0$ and $\tilde{\tau}_1$ tracks \Rightarrow large impact parameters

$\tilde{\tau}_1$ metastable, e.g. gravitino LSP \rightarrow detected by MoEDAL

d_{xy}, d_z

End-of-run-3 (2023) luminosity

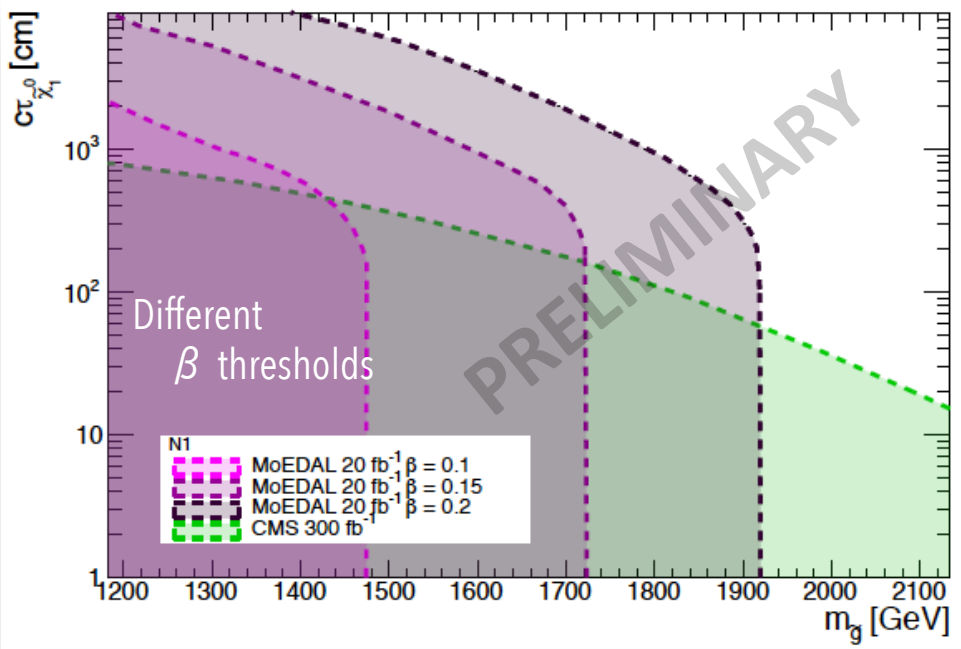

Run 2 (2018) vs. Run-3 (2023) luminosity

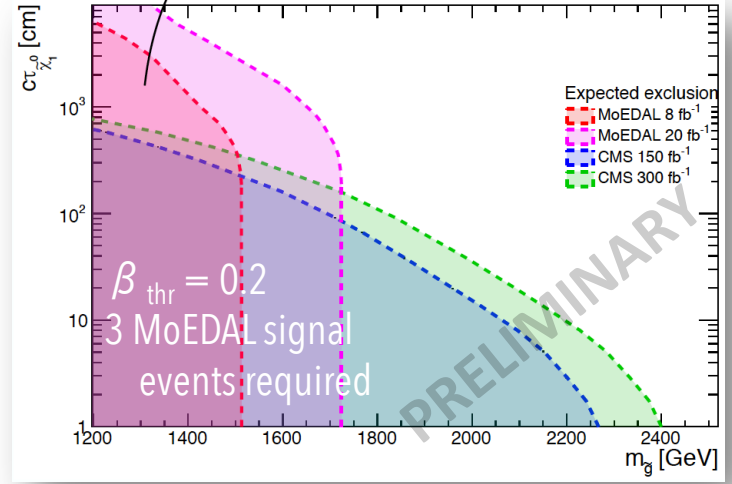

CMS affected two-ways:

- a) no pixel hit
- b) too large impact parameters



- Comparison of CMS exclusion with MoEDAL discovery potential requiring 1 event
- Conservative estimate of MoEDAL luminosity

MoEDAL can cover long-lifetime region inaccessible by ATLAS/CMS even with a moderate NTD performance $z/\beta > 10$

Summary & outlook

- MoEDAL is searching for **(meta)stable highly ionising particles**
 - least tested signals of New Physics
 - predicted in variety of theoretical models
 - design *optimised* for such searches
 - combining various detector technologies
- Results on monopole searches at 8 TeV & 13 TeV published
 - no magnetic monopole detected
 - bounds set significantly extend previous results at high charges
- Looking forward to many more results from Run-II and beyond
 - for other monopole interpretations
 - production via photon fusion
 - spin 1 monopoles
 - with NTDs
 - for electrically-charged particles



Thank you for
your attention!



Spares

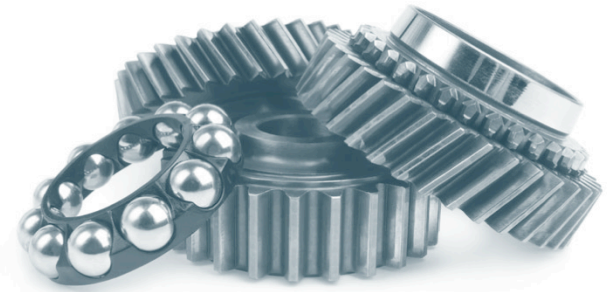

Analysis procedure

✦ Track diameter:

$$\star D = 2v_B [(v_T - v_B)/(v_T + v_B)]^{-1/2}$$

✦ Track depth:

$$\star L = (v_T - v_B) t$$

✦ Reduced etch rate:

$$\star p = v_T / v_B$$

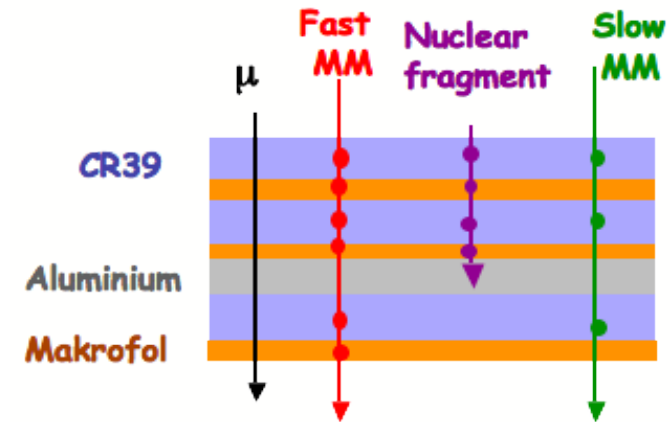
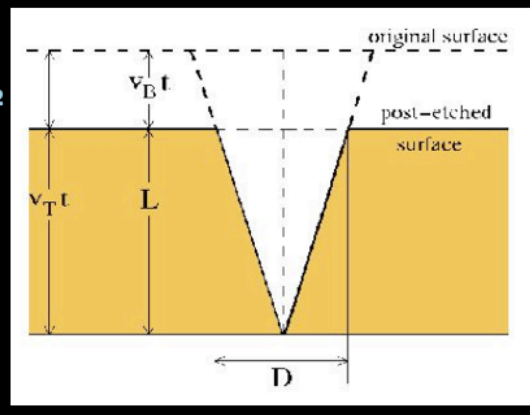

- Electrically-charged particle: $dE/dx \sim \beta^{-2} \rightarrow$ slows down appreciably within NTD \rightarrow opening angle of etch-pit cone becomes **smaller**
- Magnetic monopole: $dE/dx \sim \ln\beta$
 - slow MM: slows down within an NTD stack \rightarrow its ionisation falls \rightarrow opening angle of the etch pits would become **larger**
 - relativistic MM: dE/dx essentially constant \rightarrow trail of equal diameter etch-pit pairs
- The reduced etch rate is simply related to the *restricted energy loss*
 $REL = (dE/dx)_{10nm \text{ from track}}$

Dirac's Monopole

- Paul Dirac in 1931 hypothesized that the magnetic monopole exists
- In his conception the monopole was the end of an infinitely long and infinitely thin solenoid
- **Dirac's quantisation condition:**

$$ge = \left[\frac{\hbar c}{2} \right] n \quad \text{OR} \quad g = \frac{n}{2\alpha} e \quad \left(\text{from } \frac{4\pi e g}{\hbar c} = 2\pi n \quad n = 1, 2, 3.. \right)$$

- Where g is the "magnetic charge" and α is the fine structure constant $1/137$
- This means that $g = 68.5e$ (when $n=1$)!
- The other way around: IF there is a magnetic monopole then **charge is quantised**:

$$e = \left[\frac{\hbar c}{2g} \right] n$$

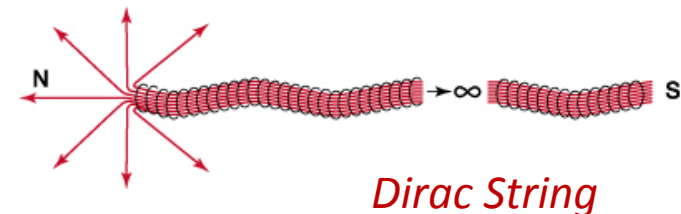
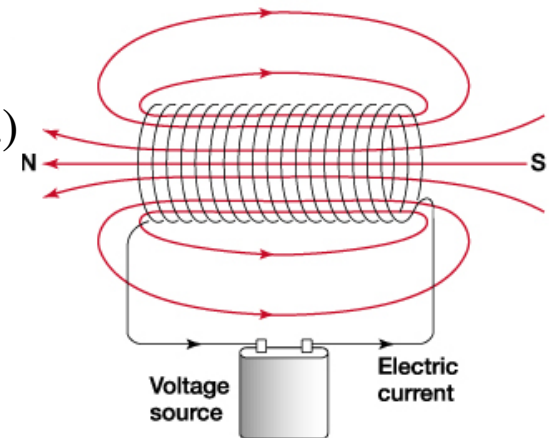
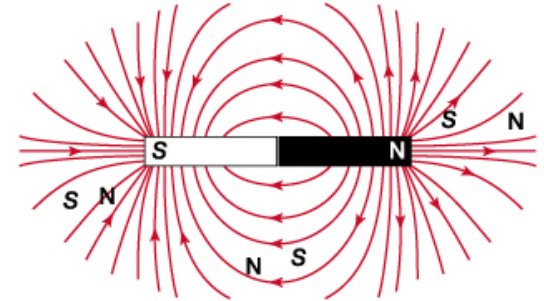

Cross section limits versus mass

Detector: prototype
of **160 kg** of Al rods
Exposure: **0.75 fb⁻¹**
of **8 TeV** *pp* collisions

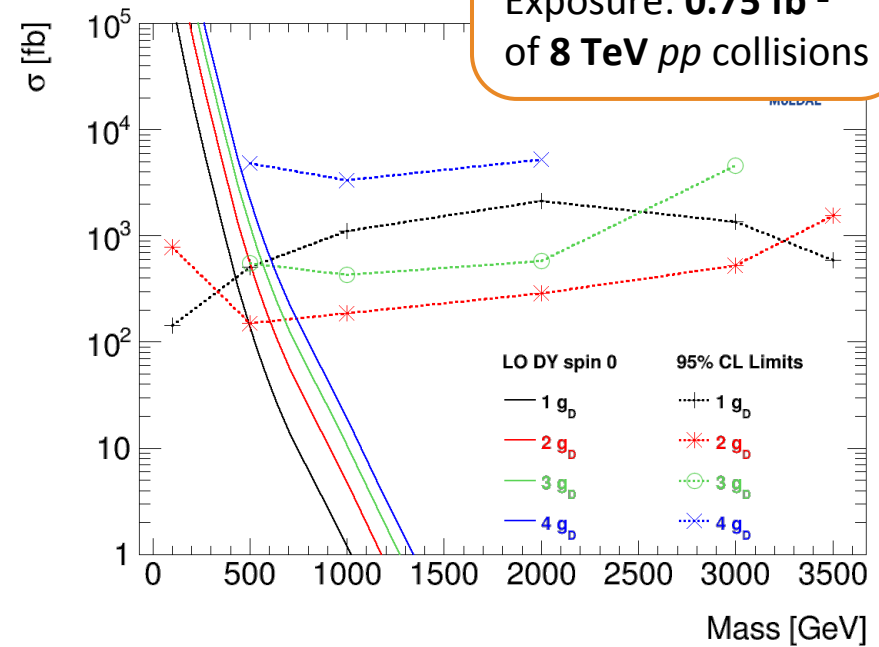
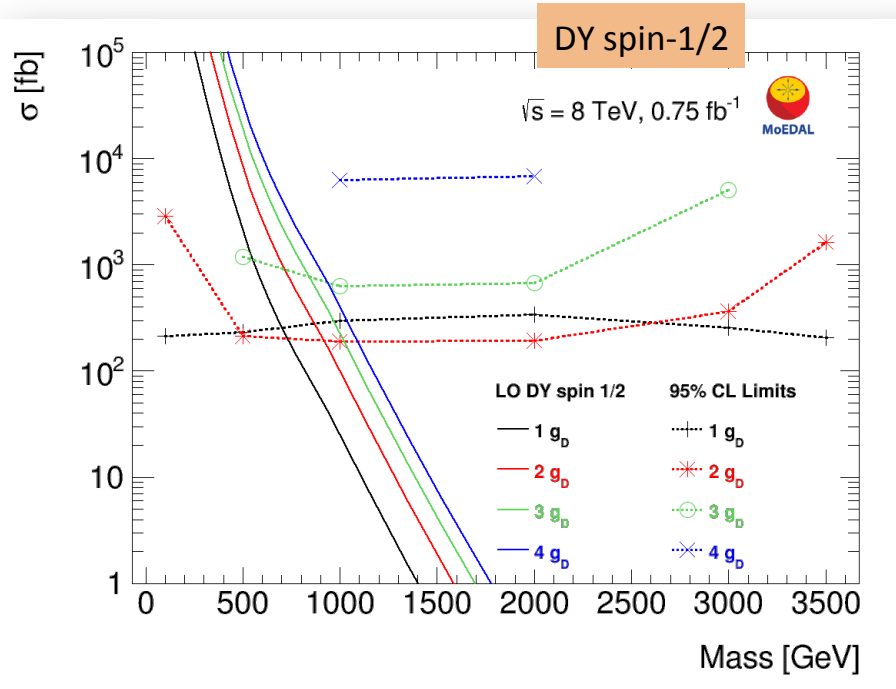

Limits extend up to masses **> 2500 GeV** for the first time at the LHC

- reminder: shown (tiny) LO DY cross sections are not reliable
⇒ makes sense to probe and constrain very high masses

Cross section limits versus charge

Detector: prototype of 160 kg of Al rods
 Exposure: **0.75 fb⁻¹**
 of 8 TeV pp collisions

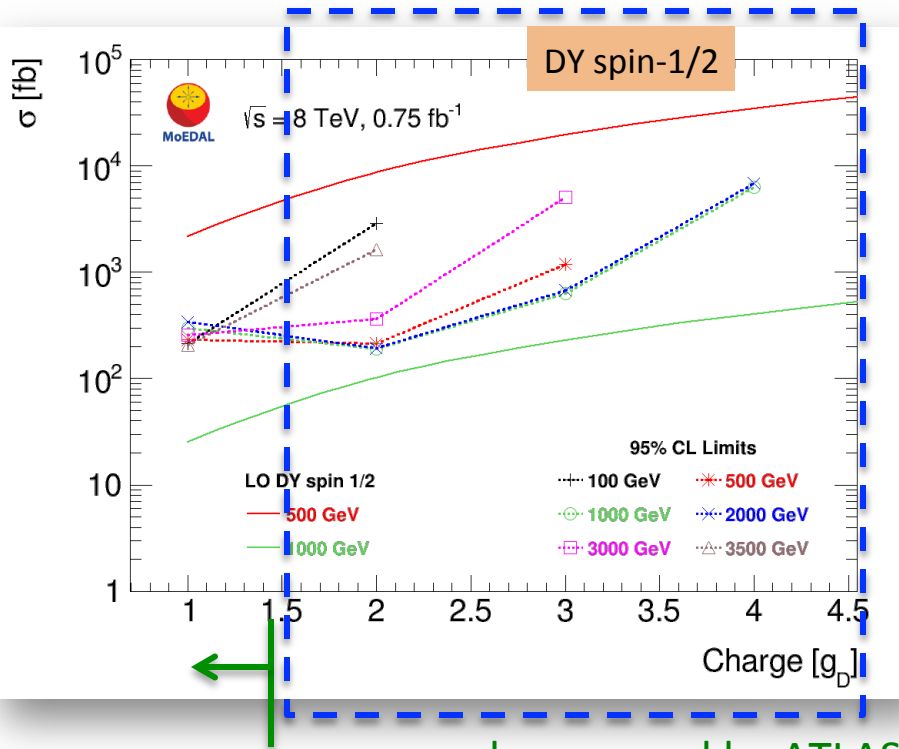

also covered by ATLAS search

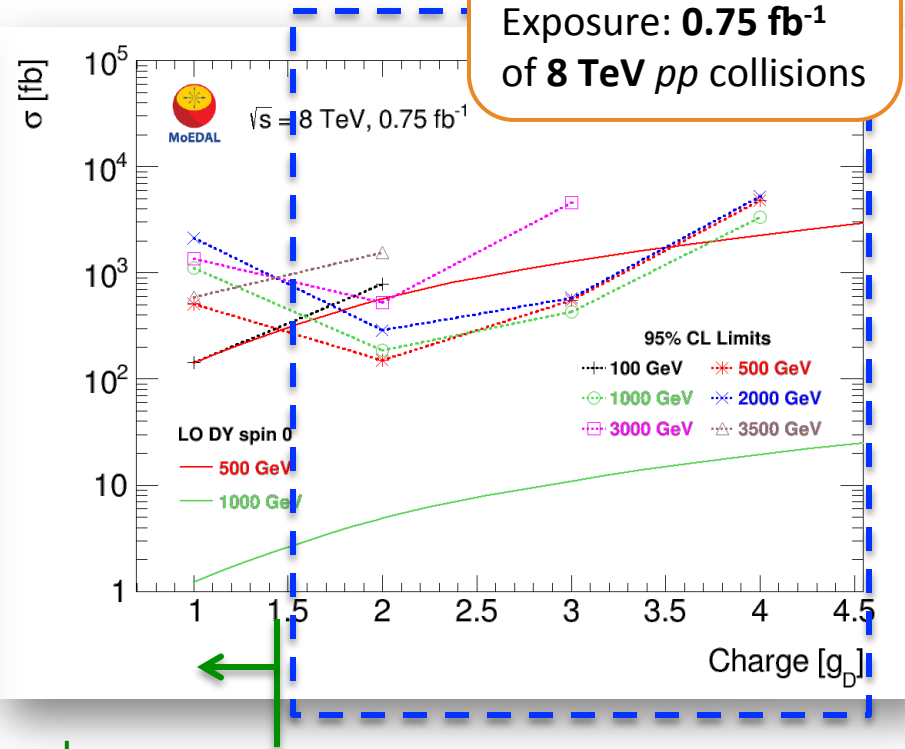

World-best limits for $|g| > 1.5 g_D$

- previously $\sim 400 \text{ GeV}$ at Tevatron [e.g. CDF hep-ex/0509015]
- first time at the LHC**

Complementarity of MoEDAL & other LHC exps

ATLAS+CMS

- Optimised for *singly* electrically charged particles ($z/\beta \sim 1$)
- LHC timing/trigger restricts sensitivity to (nearly) *relativistic* particles ($\beta \approx 1$)
- Typically a largish statistical sample is needed to establish a signal
- ATLAS & CMS cannot be calibrated for highly ionising objects
- Magnetic charge detection via its trajectory in non-bend plane → calibration introduces large systematics

MoEDAL

- Designed to detect charged particles, with effective or actual $z/\beta > 5$
- No trigger/electronics → slowly moving ($\beta < \sim 0.5$) particles are no problem
- One candidate event should be enough to establish a signal (no SM bkg)
- MoEDAL NTDs are calibrated using heavy ion beams
- Magnetic-charge sensitivity directly calibrated in a clear way

MoEDAL strengthens & expands the physics reach of LHC

Doubly-charged Higgs

- Extended Higgs sector in BSM models: $SU_L(2) \times SU_R(2) \times U_{B-L}(1)$ P-violating model
- Higgs triplet model with massive left-handed neutrinos but not right-handed ones
- Common feature: **doubly charged Higgs bosons $H^{\pm\pm}$** as parts of a Higgs triplet
- Lifetime
 - depends on many parameters: Yukawa h_{ij} (long if $< 10^{-8}$), $H^{\pm\pm}$ mass, ...
 - essentially there are no constraints on its lifetime \rightarrow relevant for MoEDAL

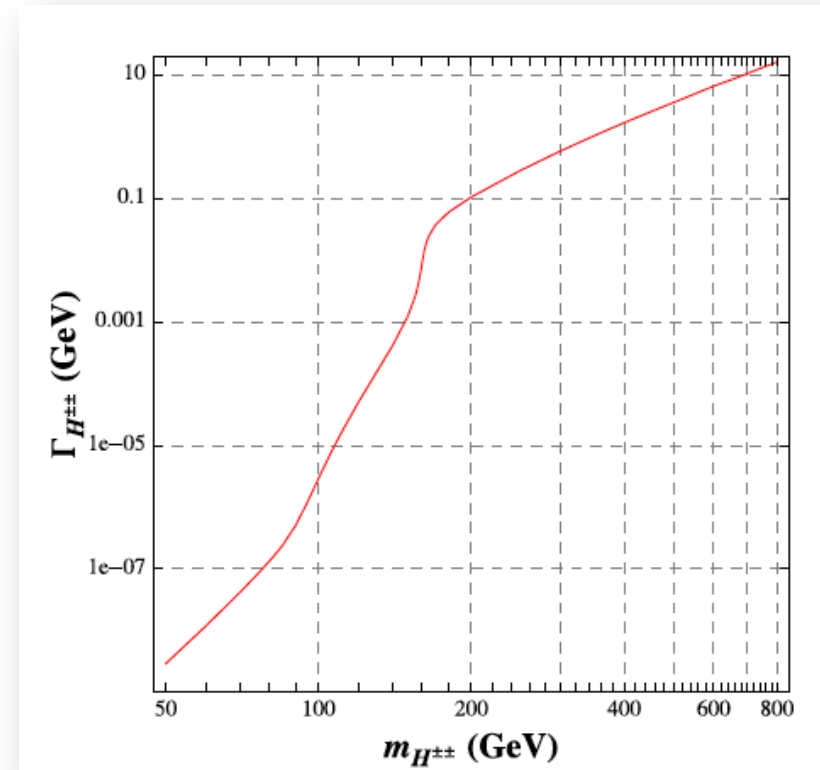

Partial decay width of $H^{\pm\pm} \rightarrow W^\pm W^\pm$

Chiang, Nomura, Tsumura,
Phys.Rev. D85 (2012) 095023 [arXiv:1202.2014]

Black-hole remnants

- In some **Large Extra Dimension** models the formation of **TeV Black Holes (BH)** by high energy SM particle collisions is predicted
 - BH average charge $4/3$
 - slowly moving ($\beta \lesssim 0.3$)
- Charged Hawking BH evaporate but not completely
 - certain fraction of final BH remnants carry **multiple charges**
 - highly ionising, relevant to MoEDAL

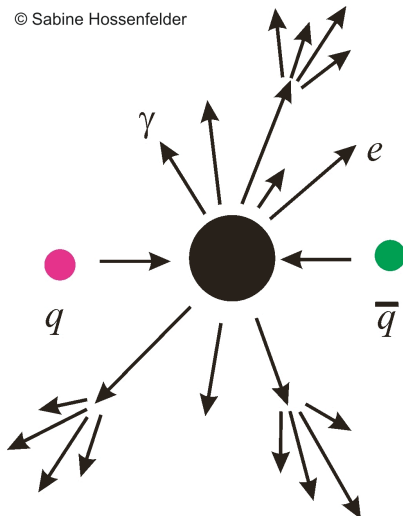

Hossenfelder, Koch, Bleicher,
hep-ph/0507140

