Lecture 21 - Beam Diagnostics & Instrumentation

Professor Emmanuel Tsesmelis
Principal Physicist, CERN
Department of Physics, University of Oxford

Accelerator Physics Graduate Course
John Adams Institute for Accelerator Science
29 November 2017

Introduction

- Beam circulating inside closed vacuum chamber is not visible from outside.
- Access close to accelerator prohibited during operation.
- Equip accelerator with wide range of measuring instruments - **monitors**
 - Establish whether there is beam in machine.
 - Measure physical parameters of machine.

*An accelerator is only as good
as its diagnostic equipment.*

What are Beam Diagnostics?

- Diagnostics are the ‘eyes and ears’ of accelerator:
 - Measure **physical properties** of the beam, like charge, position, transverse and temporal profile.
 - Consist of devices to **sense** these properties (pick-ups) and associated **processing** electronics and **software** (amplifiers, filters, converters, calculations).
 - Essential in the **commissioning** phase to establish operating conditions and tune parameters for optimum performance (beam optics, timing, accelerating field amplitudes and phases).
 - Essential in the **operation** to ensure stable conditions (stable orbit, tune, timing). Thus, diagnostics are required to be reliable and stable in their own right.

OBSERVATION OF BEAM & MEASUREMENT OF BEAM CURRENT

Screens (Phosphor or Scintillator)

- Full 2D transverse profile in one shot.
- Generally destructive to the beam (energy absorbed, scattering of particles as they pass through screen).
- Actuator required to remove screen from beam path.
- Camera shutter should be synchronised to beam arrival for best results.

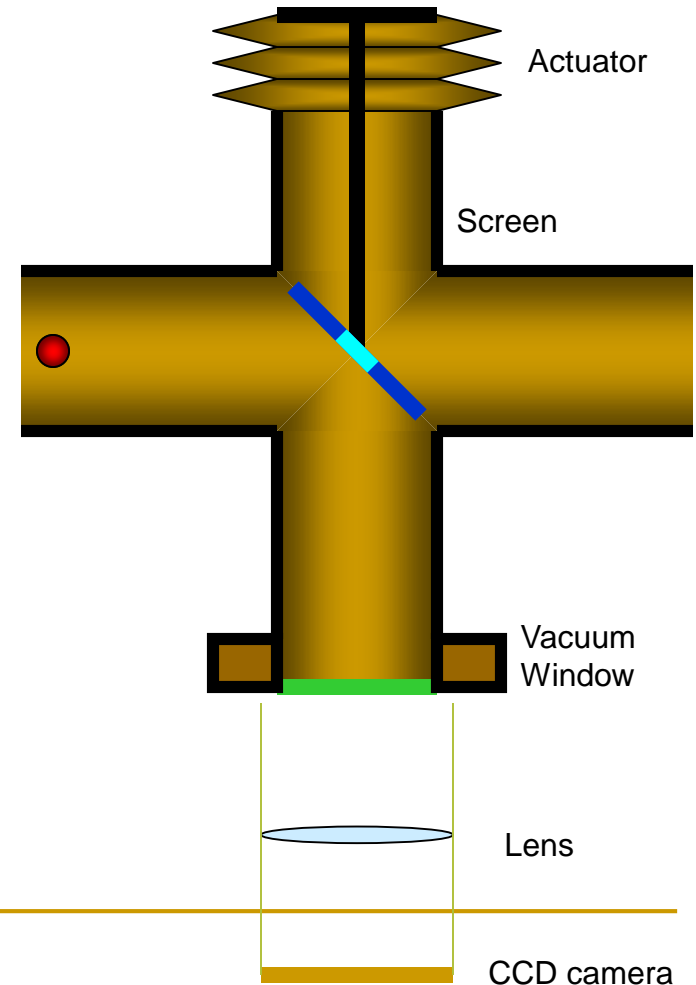

Fluorescent Screen

- Applications
 - Measurement of beam position
 - Beam profile
 - Beam intensity
 - ZnS is effective fluorescent material
 - Mixed with sodium silicate, it is applied in thin layers onto glass, ceramic or metal.
 - Screens emit green light with high light yield.
 - Disadvantages
 - Limited use in high-vacuum environments.
 - Limited lifetime & burn out at beam spot after extended exposure.
-

Fluorescent Screen

- Thicker screens made of Al_2O_3 doped with chrome.
 - Predominantly red light.
 - High tolerance to beam exposure.
 - Low degassing rate and may be used in UHV.

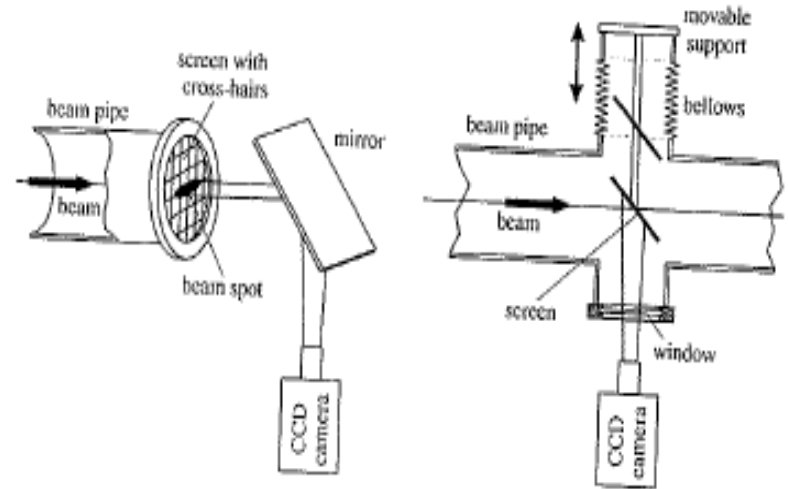

Left – fixed version at the end of linac.

Right – movable screen which may be moved in/out of beam line.

Fluorescent Screen

■ Read-out

- Emitted light viewed using television (CCD) camera in control room.
- CCDs are susceptible to radiation damage.
 - Protect by lead shielding and install at low radiation level locations.

■ Limitations

- Non-linear relationship between light yield and beam intensity
- Long afterglow
 - Several ms to seconds
 - Not possible to resolve time structure of beam (ns. range).



Optical Transition Radiation (OTR)

- Transition Radiation is created when relativistic charged particles cross a dielectric boundary.
- Typically, metal targets are used, as metals have large negative dielectric constant at optical frequencies.
- A part of the emitted photons (OTR) is in the visible spectrum and can be used to image the particle distribution.
- Forward OTR is emitted in a cone around the particle trajectory.
- Backward OTR is emitted in a cone around the 'reflected' particle trajectory.

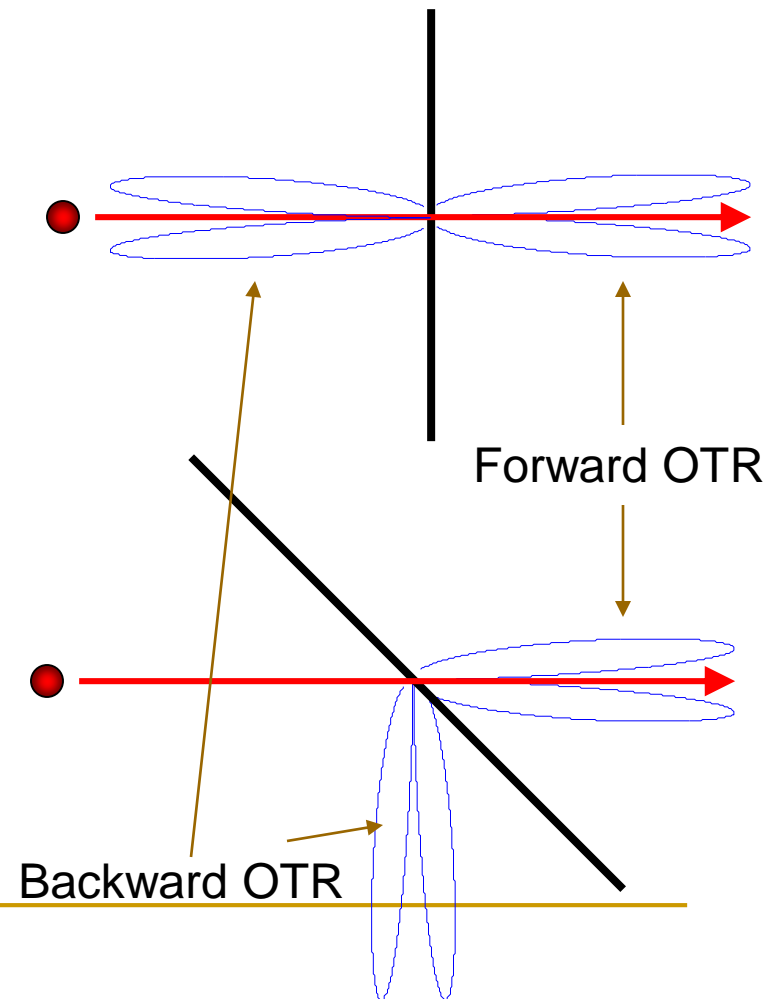

Properties of OTR

- Intensity scales with:

$$I \propto \frac{\theta^2}{(\theta^2 + \gamma^{-2})^2}$$

- Maximum at $1/\gamma$
- Number of (visible) photons per electron:

$$N = \frac{1}{137\pi} (2 \ln \gamma - 1) \cdot \ln \left(\frac{\lambda_{red}}{\lambda_{blue}} \right)$$

- Practically: 1-3%

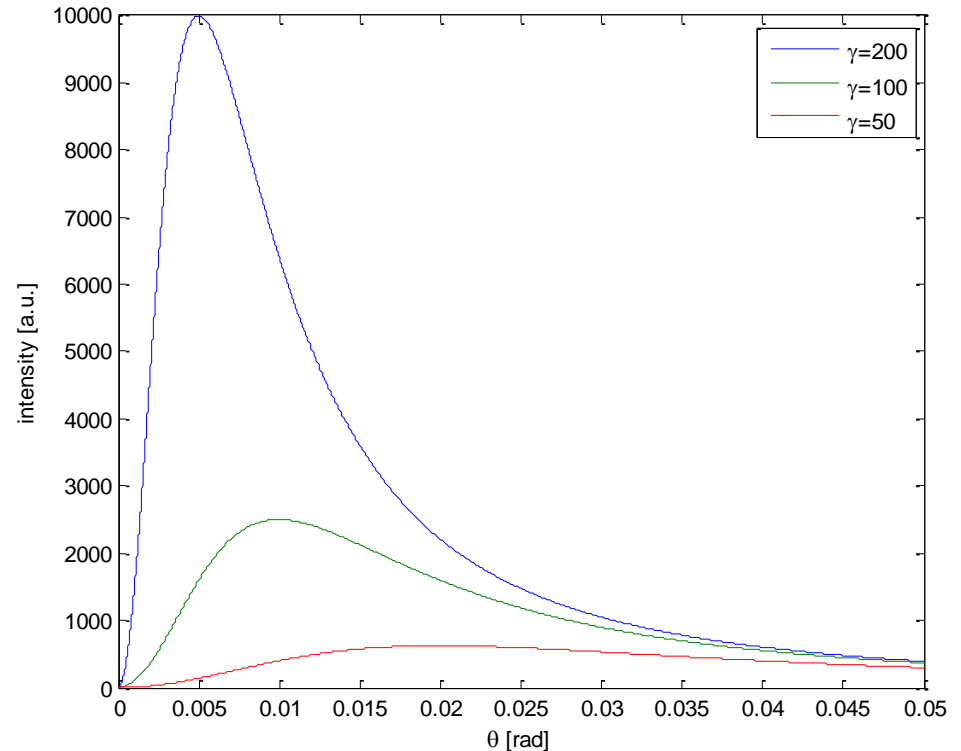

OTR Advantages/Disadvantages

■ Advantages

- Like a phosphor screen, but without resolution limits (resolution possible down to optical wavelength).
- No saturation, linear intensity to destruction threshold ($>10^{12}e^-/mm^2$).

■ Disadvantages

- Few photons per electron, which are emitted in a large angle at low particle energies.
 - Practically only feasible for strongly relativistic particles ($\gamma > 100$).
-

Screens and Optics

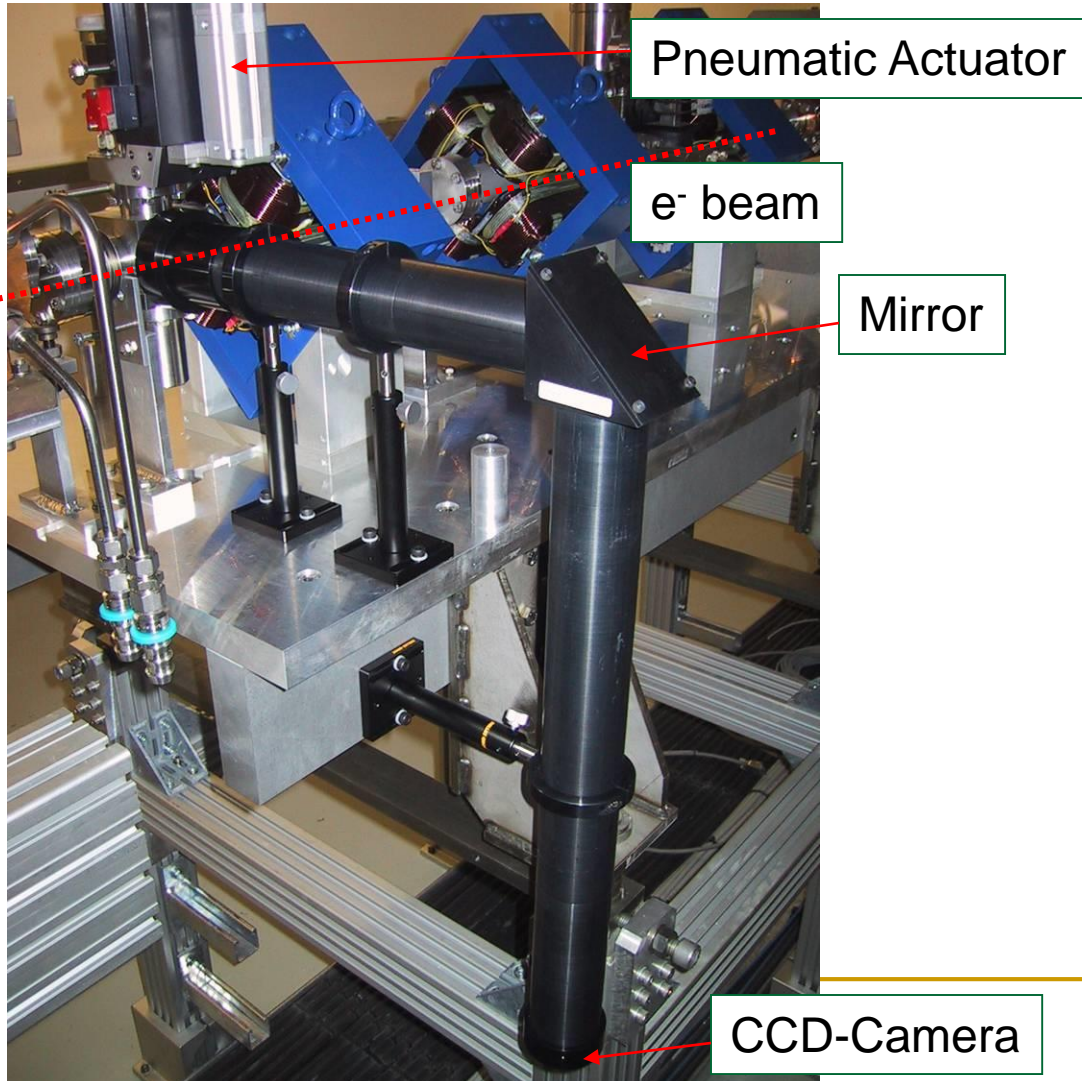

Beam Profiles in the Diamond Injector

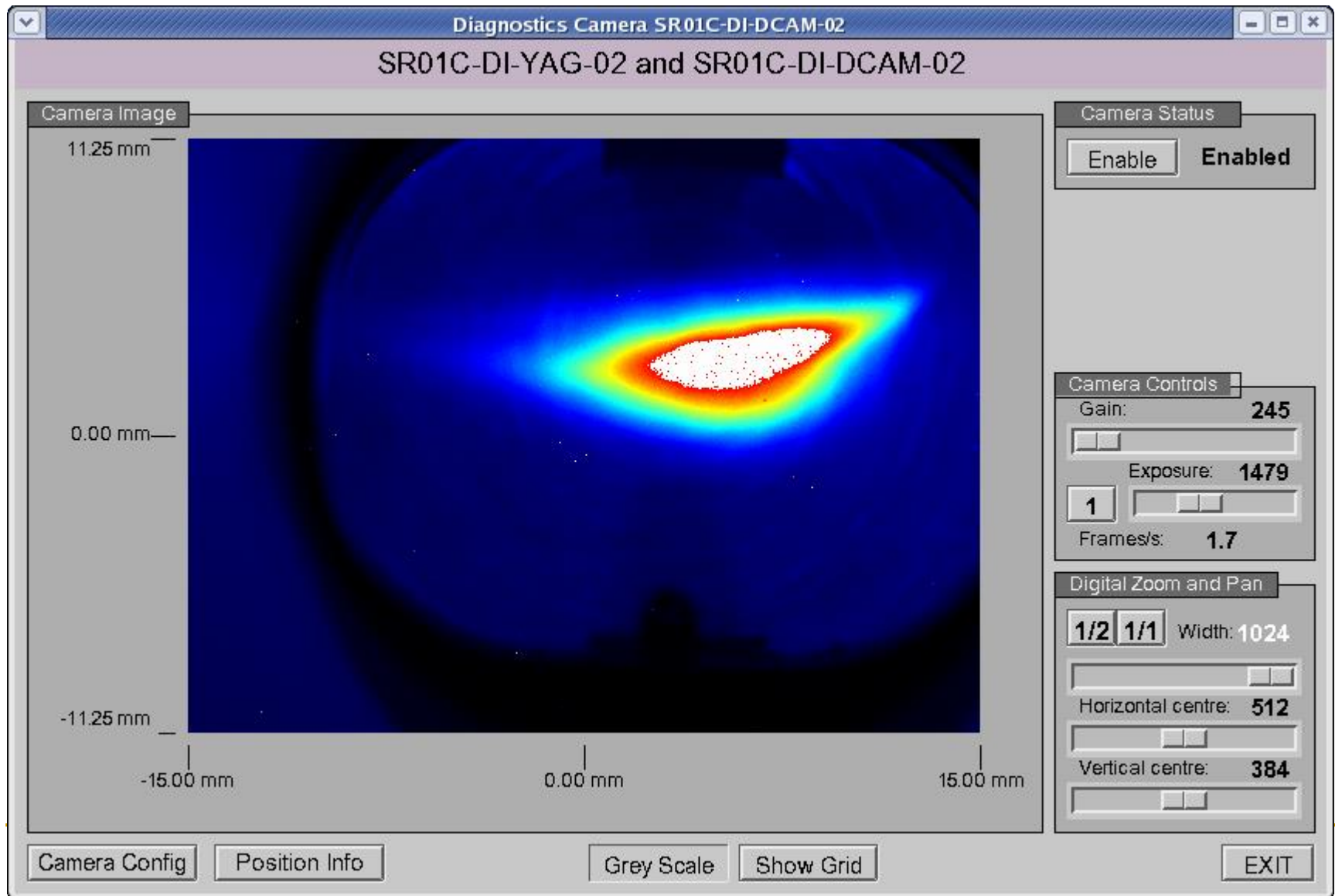

Faraday Cup

■ Applications

- Simplest method to measure beam current/intensity is to completely absorb beam in block of conducting material.
 - Measure captured charge by measuring resulting current.

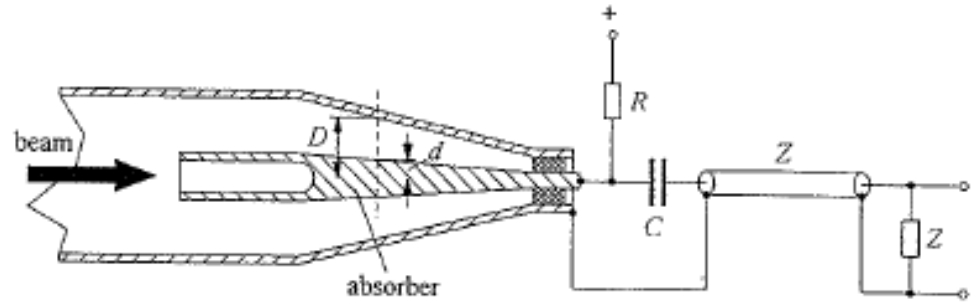

Faraday cup with coaxial structure

- At high energies, penetration depth is large – material block must be very thick.
- Large energy transfer to absorber – strong heating.
- Multiple scattering – transverse broadening of beam -> particle losses
- Secondary particle production by pair production.
- Therefore, Faraday cup restricted to low-energy beam applications.

Faraday Cup Principle

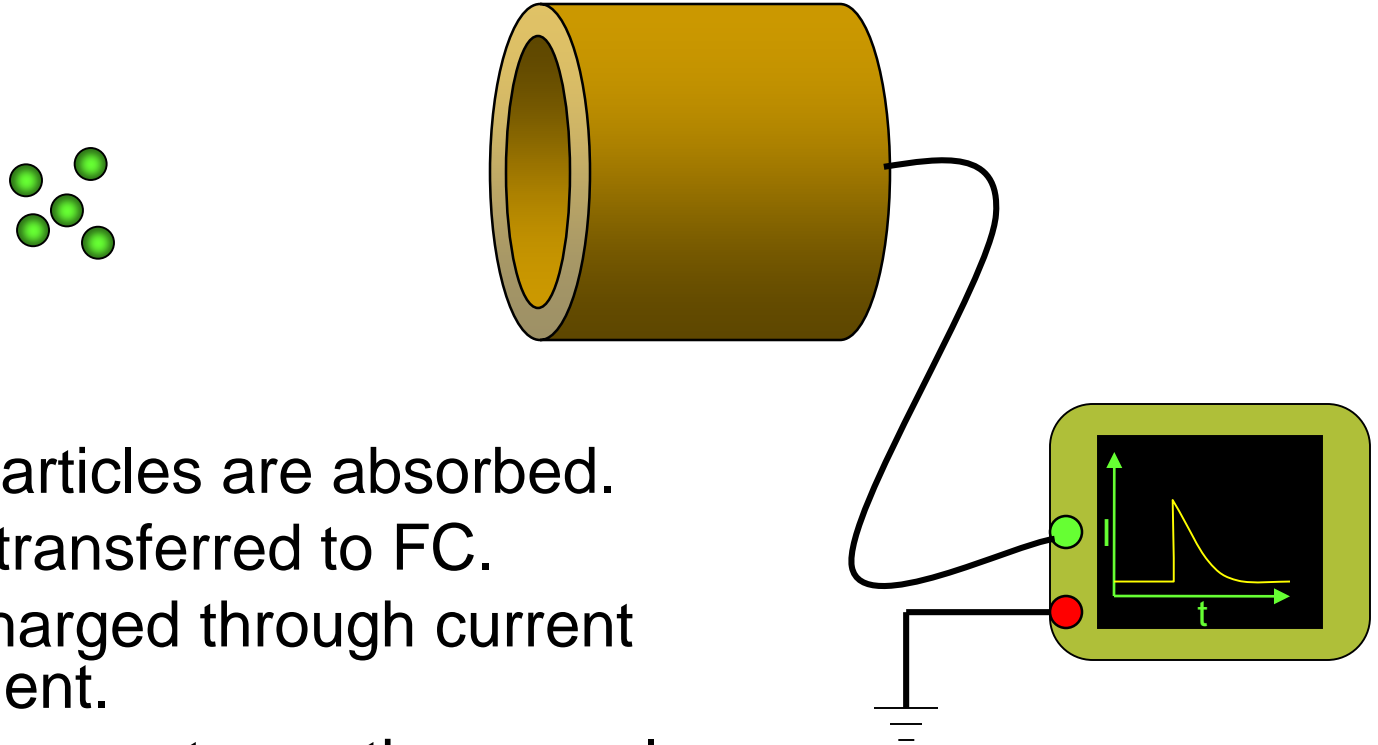

- Charged particles are absorbed.
- Charge is transferred to FC.
- FC is discharged through current measurement.
- Integral of current over time equals charge.

Interaction of Particles with Matter

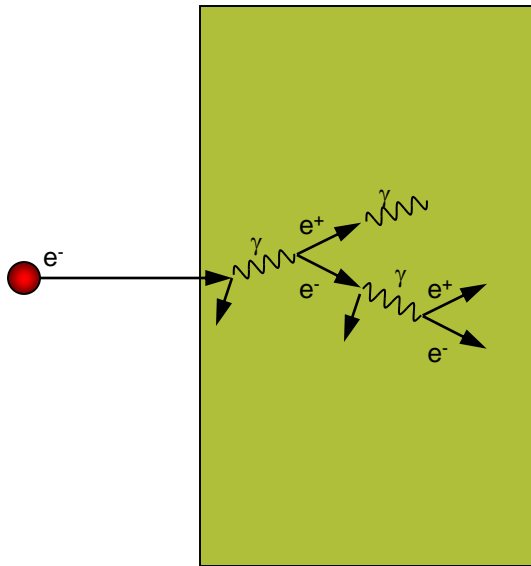

- Need to consider ionisation losses (dominant up to a few MeV), bremsstrahlung and e^+e^- pair production.
- Higher energy particles will need more length or higher density material to be stopped.
- At lower energies (up to a few 10MeV) calculations of absorption length and Moliere radius etc. using empirical formulae will be sufficient.
- At higher energies, simulation of scattering, pair-production and energy deposition is required (e.g. Electron Gamma Shower)

Backscatter

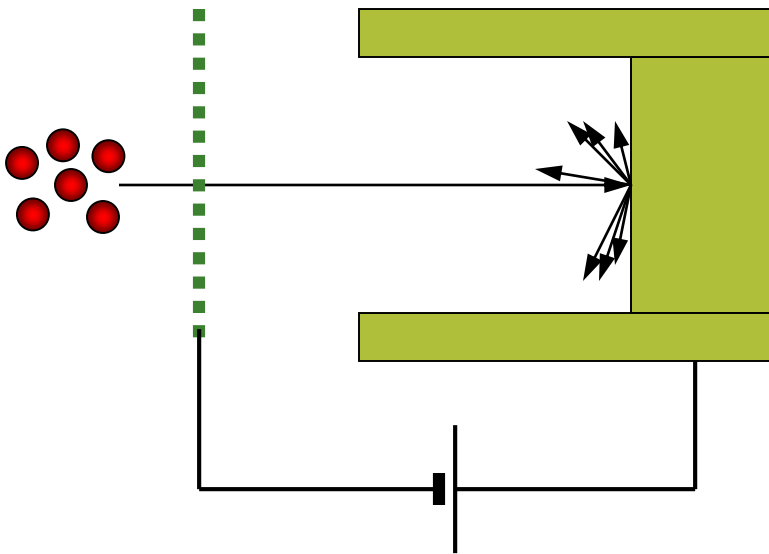

- Angular distribution depends on energy of particles and on density of material.
- Generally least in direct reverse direction.
- Backscattered (or secondary) particles have less energy.
- Low Z material, side walls or biased grid to reduce.

Some Faraday Cups



Graphite insert

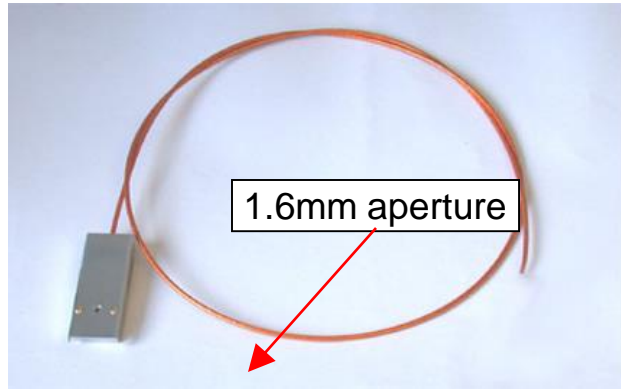

1.6mm aperture

Kimball Physics



Flange mounted, 4W beam power

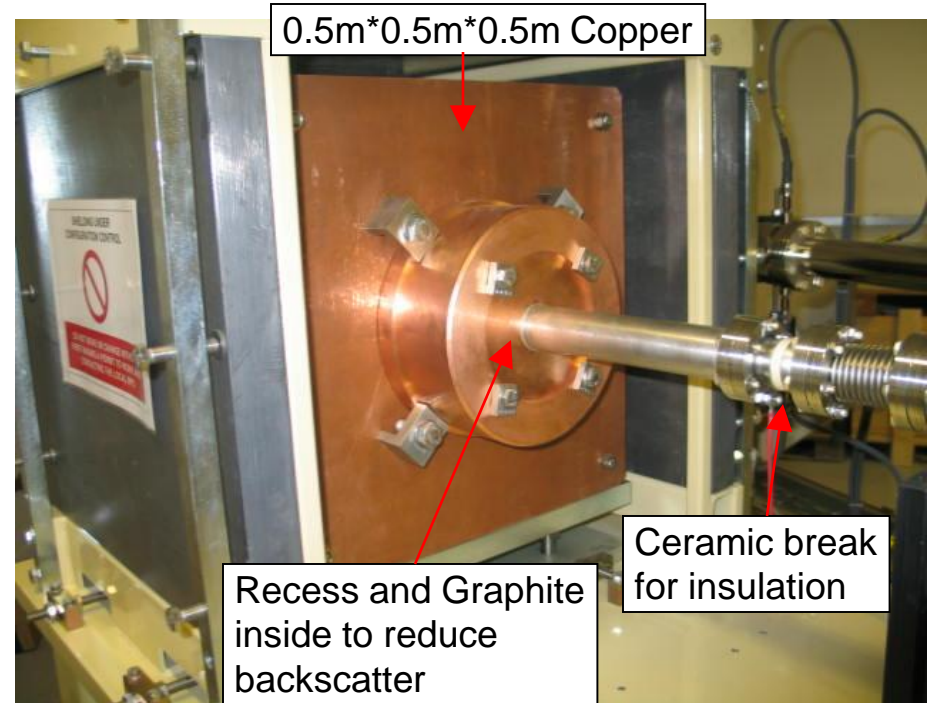

0.5m*0.5m*0.5m Copper

Recess and Graphite inside to reduce backscatter

Ceramic break for insulation

3 GeV FC at the exit of the Diamond Booster

Actuator mounted coaxial FC
Diamond LINAC @ 90 keV and 4 MeV

Wall Current Monitor (WCM)

- Cyclic Accelerator
 - Need to measure the current without disturbing the beam.
- Current
 - Outside vacuum tube

$$\oint \mathbf{B}_{\text{external}} \cdot d\mathbf{r} = 0.$$

- Within vacuum tube

$$\frac{1}{\mu_0} \oint \mathbf{B}_{\text{beam}} \cdot d\mathbf{r} = I_{\text{beam}},$$

- There is a wall current I_{wall} flowing in vacuum chamber

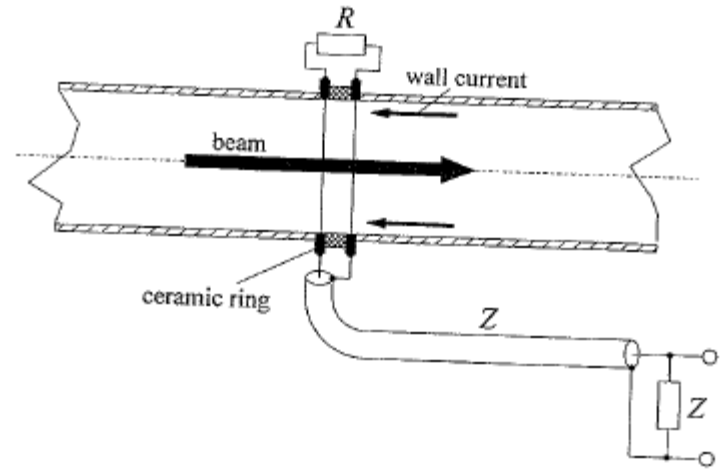

Lay-out of wall current monitor

$$I_{\text{beam}} = -I_{\text{wall}}$$

Wall Current Monitor (WCM)

- Beam current determined by measuring current in vacuum chamber wall.
- Measure voltage V developed over ohmic resistance R ($\sim 1 \Omega$) across a ceramic gap.

$$U_R = R I_{\text{beam}} = -R I_{\text{wall}}.$$

- Large number of resistors are used, connected in parallel around the vacuum chamber
 - Wall current monitor can achieve very high bandwidths (several GHz).
-

Fields and Currents of a Charged Particle at Relativistic Speed

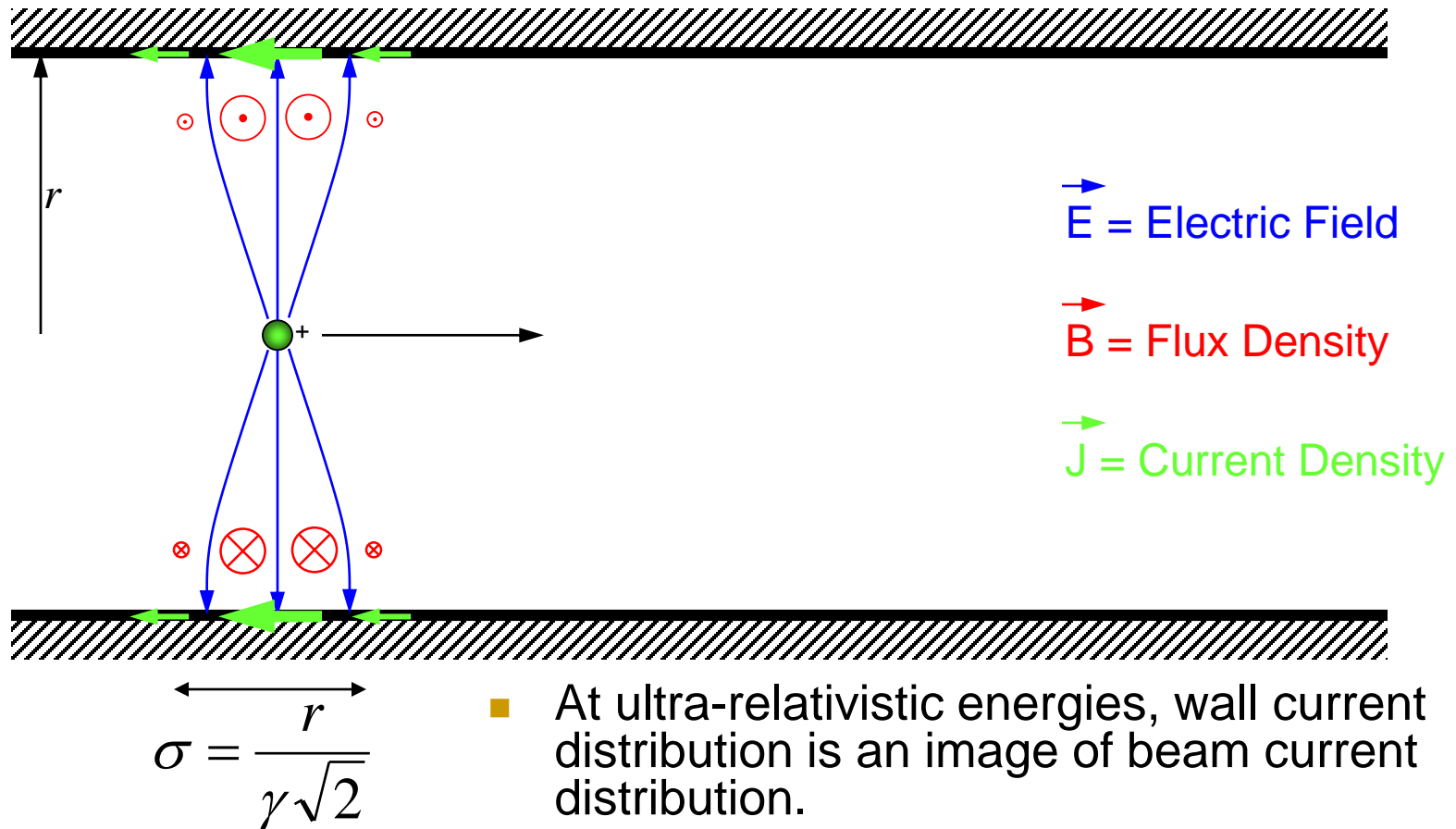

- No field outside tube (only DC magnetic field)

Wall Current Monitor (WCM)

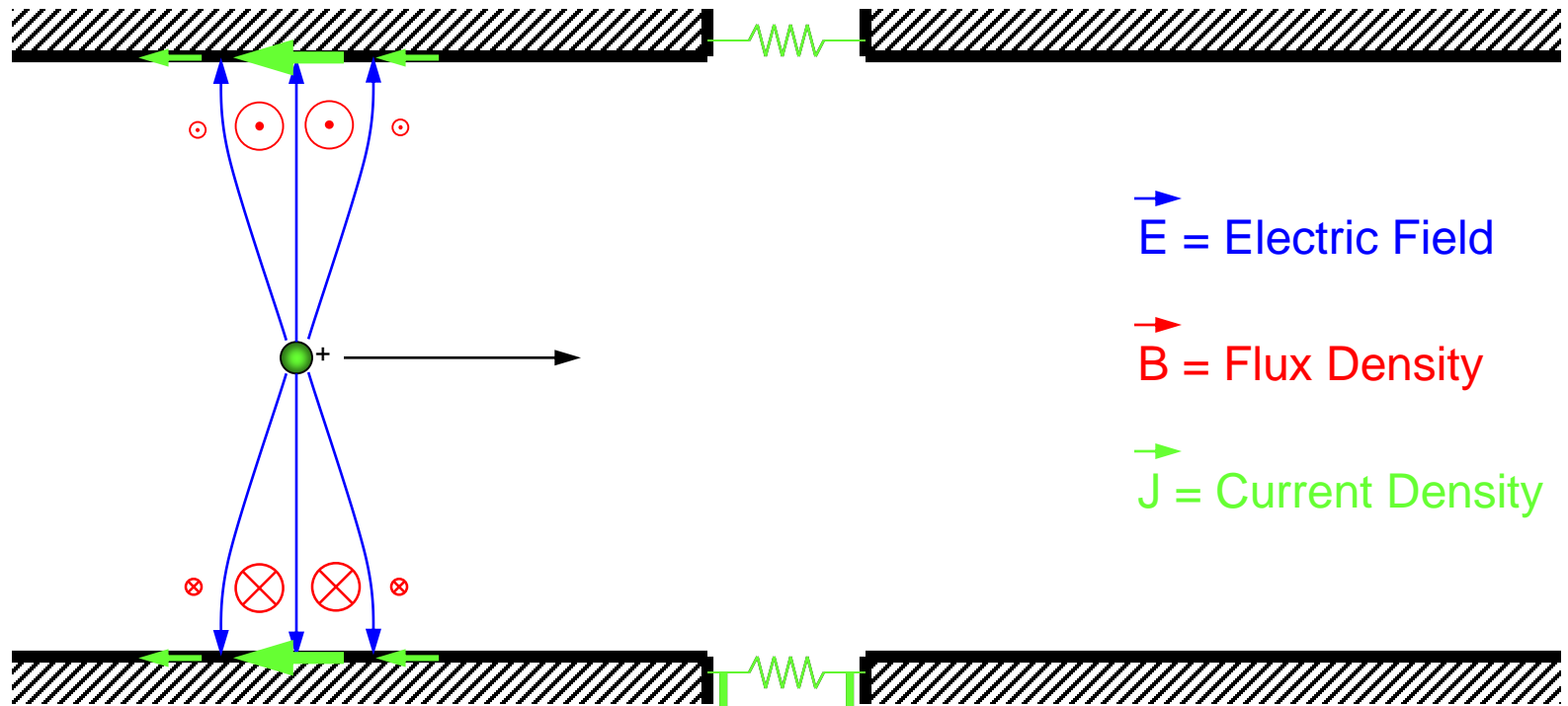

- \vec{E} = Electric Field
- \vec{B} = Flux Density
- \vec{J} = Current Density

Typical resolution 100ps RMS

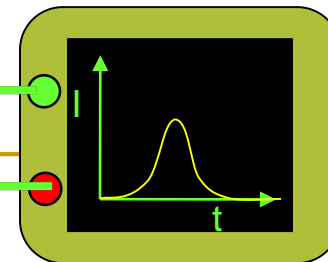

WCM Example Measurements

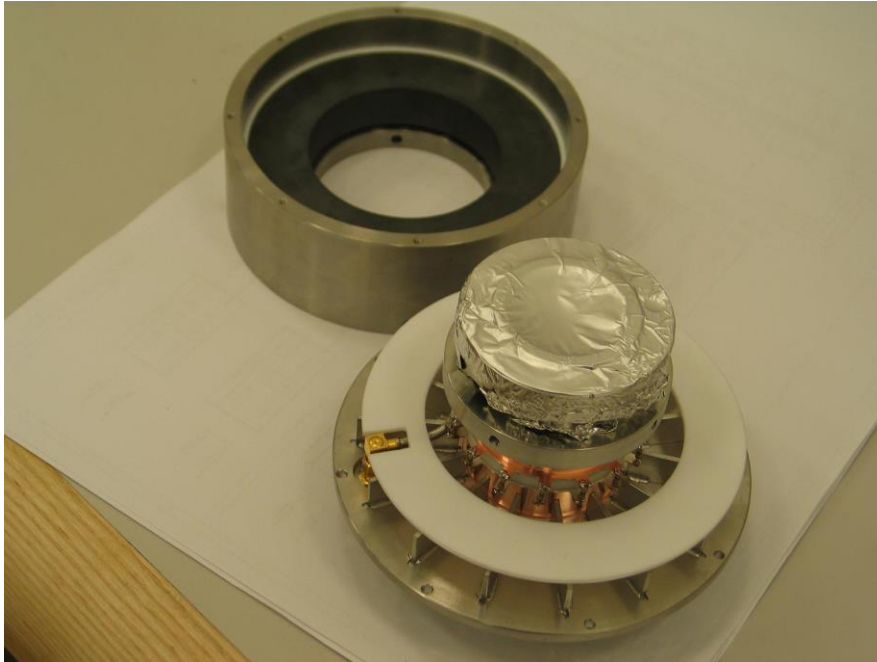

Mechanical Assembly

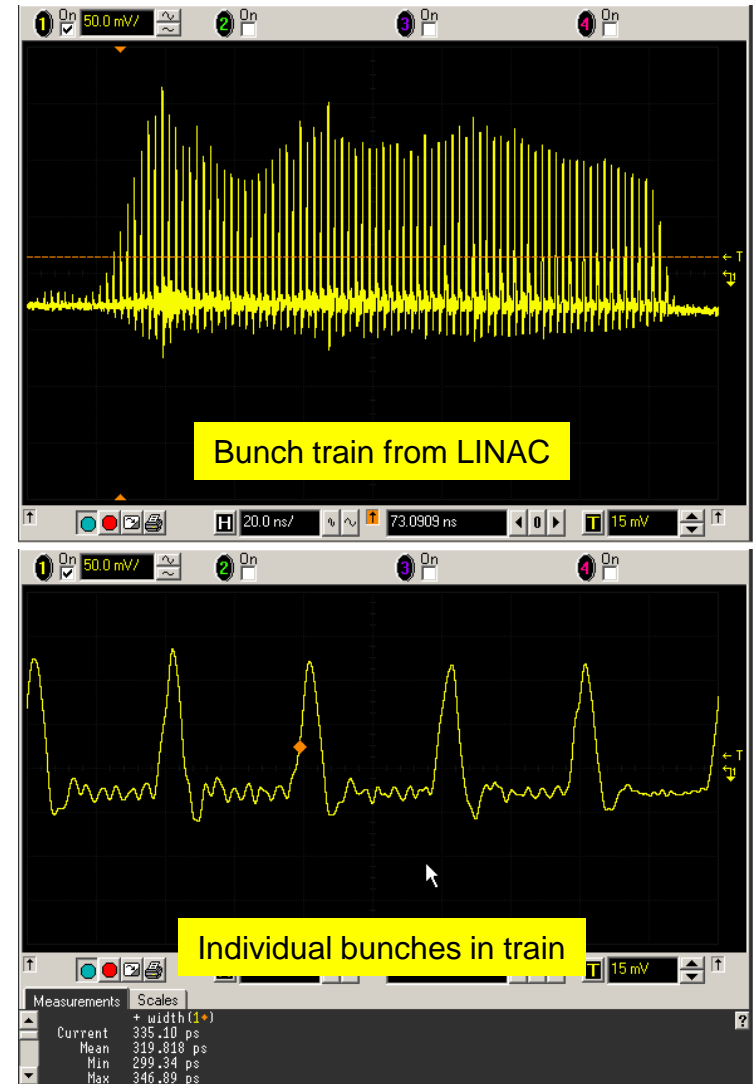

Beam Current Transformer

$$I_{\text{beam}}(t) = \frac{Ne}{\sqrt{2\pi} \tau} \exp\left(-\frac{(t-t_0)^2}{2\tau^2}\right) \quad \text{with} \quad \tau = \frac{\sigma_s}{c}$$

$$B(t) = \frac{\mu_0 \mu_r}{2\pi R_{\text{core}}} I_{\text{beam}}(t)$$

$$U_{\text{ind}}(t) = n A \dot{B}(t) = \frac{\mu_0 \mu_r n A}{2\pi R_{\text{core}}} \dot{I}_{\text{beam}}(t)$$

This arrangement acts like a transformer:

Primary winding – particle beam

Secondary winding – inductive coil

→ *Beam Transformer*

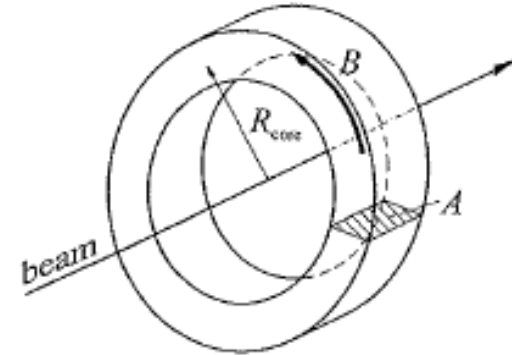

Ideal iron core around particle beam

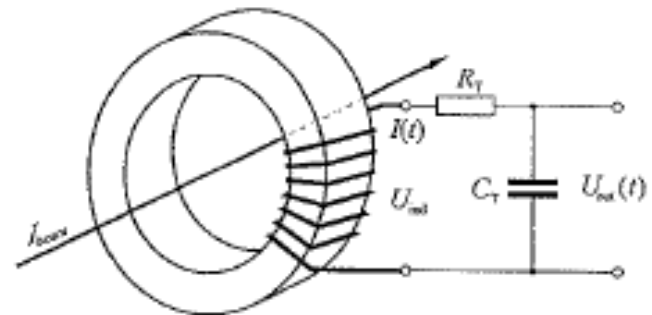

Equivalent circuit of beam transformer

Beam Current Transformer Principle

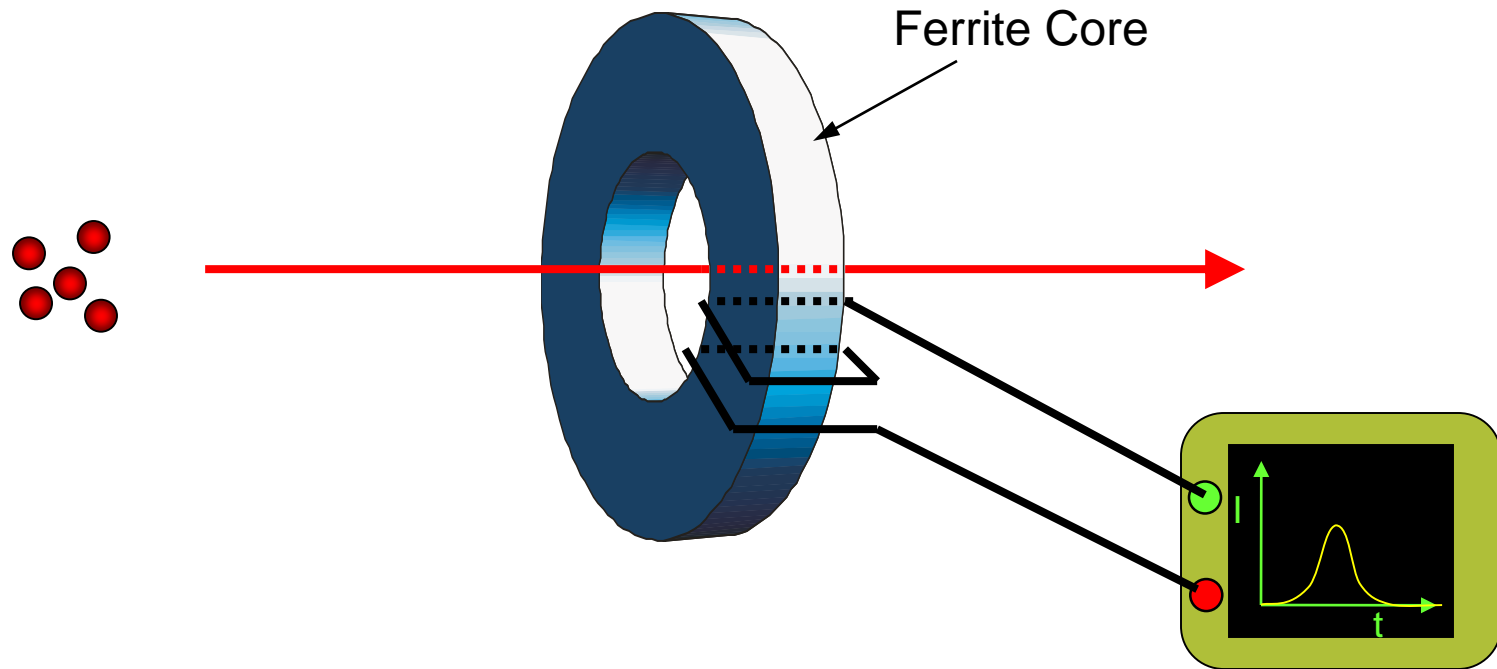

- Charged particles act as 'single turn' in a transformer.
- Proportional current is induced into windings.
- Integral of current over time equals charge.

Beam Current Transformer

- Beam transformer output (secondary) voltage U_{out}

$$U_{out}(t) = \frac{1}{C_T} \int I(t) dt.$$

$$i(t) + \frac{1}{C_T R_T} I(t) = \frac{\dot{U}_{ind}}{R_T}.$$

- $C_T R_T$ long compared to duration of bunch pulses \rightarrow

$$\dot{I}(t) \approx \frac{\dot{U}_{ind}}{R_T} \quad \Rightarrow \quad I(t) \approx \frac{U_{ind}}{R_T} + C_1.$$

- Secondary voltage becomes:

$$U_{out}(t) = \frac{1}{C_T} \int I(t) dt \approx \frac{1}{C_T R_T} \int U_{ind} dt.$$

$$U_{out}(t) = \frac{1}{C_T R_T} \frac{\mu_0 \mu_r n A}{2\pi R_{core}} I_{beam}(t).$$

- Time dependence of output voltage U_{out} is only roughly proportional to beam current $I_{beam}(t)$.
- True for relatively long bunches with limited frequency components
 - For short bunches U_{out} is considerably longer than the current pulse.
 - Area under voltage pulse can be used as good approximation of number of particles.

BEAM LIFETIME IN STORAGE RING



Beam Lifetime in Storage Ring

- Beam circulating in storage ring decays in intensity due to:
 - Collisions with residual gas molecules.
 - Occasional large energy losses through synchrotron radiation (for electrons).
 - Non-linear resonances

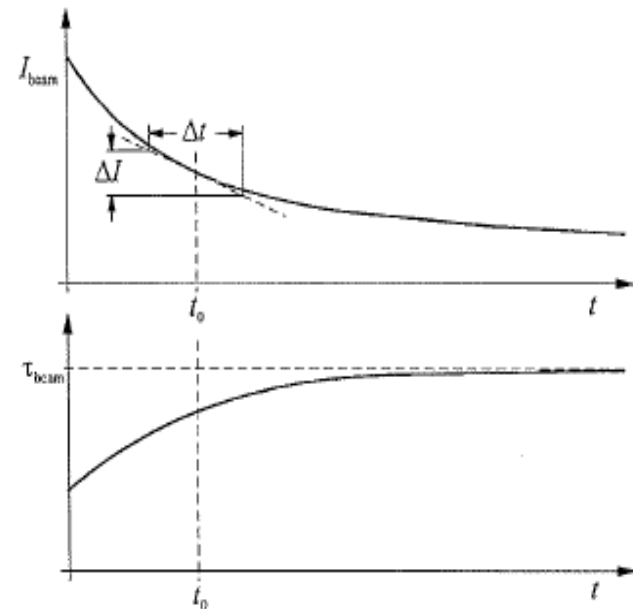

Time dependence of beam current and lifetime

Beam Lifetime in Storage Ring

- Decline in intensity has exponential form with τ_{beam} being the beam lifetime:

$$I(t) = I_0 \exp\left(-\frac{t}{\tau_{beam}}\right).$$

$$dI(t)/dt = -I_0/\tau_{beam} \exp(-t/\tau_{beam}) = I(t)/\tau_{beam}$$

$$\tau_{beam} = \frac{I(t)}{dI/dt}.$$

- Lifetime is not constant during machine operation.
 - Lifetime relatively short at beginning (when intensity is high) because intense synchrotron radiation (for electron beams) causes high level of gas desorption on vacuum chamber surface increasing vacuum pressure.
 - As beam current decreases, vacuum improves and lifetime increases.

Beam Lifetime in Storage Ring

- Using a beam current monitor, the current is continuously monitored, with measurements repeated at frequent intervals.
 - Since beam lifetime can vary from few seconds to many hours (depending on operating conditions), it is useful to vary the time interval between measurements.
 - **Short lifetimes** – beam current varies rapidly & only few measurements required for reliable lifetime measurement
→ short time interval.
 - **Long lifetimes** – individual current measurements must last sufficiently long for statistical fluctuations not to cause large errors in lifetime measurement.
-

MEASUREMENT OF MOMENTUM & ENERGY OF PARTICLE BEAM

Measurement of Momentum & Energy

- Measure angle of deflection in known B-field.

$$d\alpha(r) = \frac{e}{p} B_z(r) ds,$$

$$p = \frac{e}{\alpha_{\text{tot}}} \int_{\text{path}} B_z ds.$$

$$E = \sqrt{p^2 c^2 + (m_0 c^2)^2},$$

$$E = p c = \frac{e c}{\alpha_{\text{tot}}} \int_{\text{path}} B_z ds.$$

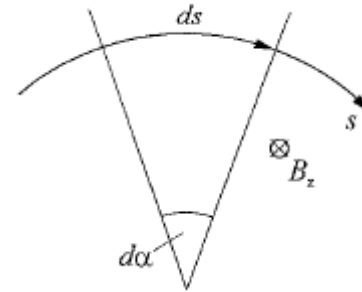

Deflection of a charged particle in a magnetic field.

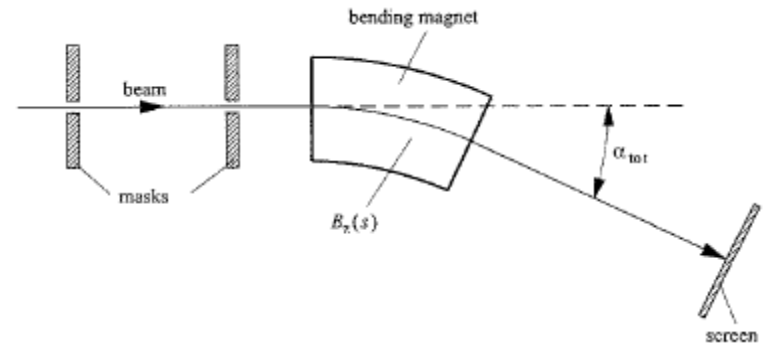

Magnetic spectrometer to measure particle momentum & energy

Measurement of Momentum & Energy

■ Measurement Parameters

- Incoming beam angle must be precisely defined.
 - Fix beam position using precisely aligned screens.
 - Measure bending angle after deflection using fluorescent screen.
- $\int B_z$ required, which is obtained by measurement of the B-field as a function of coil current.
 - Watch out for hysteresis of iron magnets!

■ Cyclic Accelerators

- Total bending angle of all dipole magnets must be 2π .

$$E = \frac{e c}{2\pi} \oint_{\text{dipole}} B_z ds.$$

- Connect additional dipole in series with accelerator dipoles and install precise field gauge within it – e.g. NMR probe.
 - Field and energy continuously monitored.
 - $\Delta E/E \sim 2 \cdot 10^{-4}$.

MEASUREMENT OF TRANSVERSE BEAM POSITION

Transverse Space v Phase Space

- Transverse profile is distribution of particle positions in the x/y plane at a fixed s location.
- Transverse phase space are the distributions of particle positions and directions at a fixed s location.
- Transverse emittances equal 'areas' of phase space distributions.

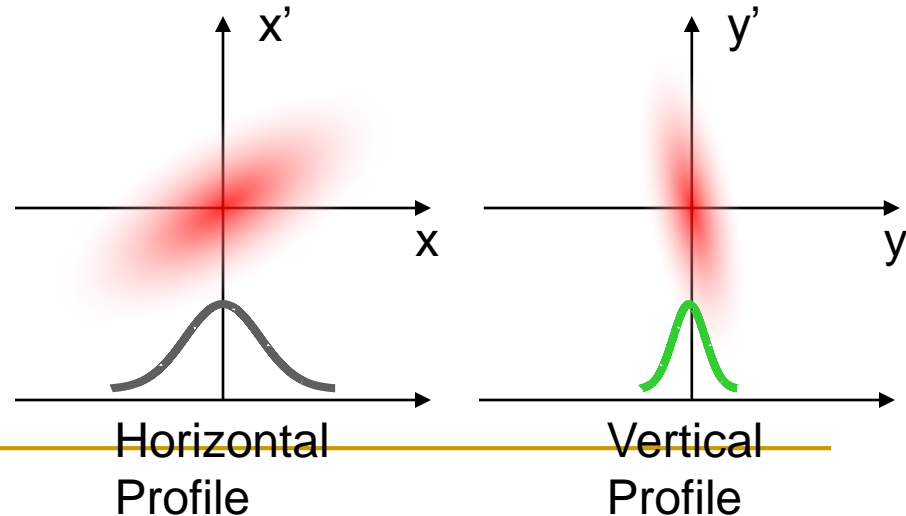
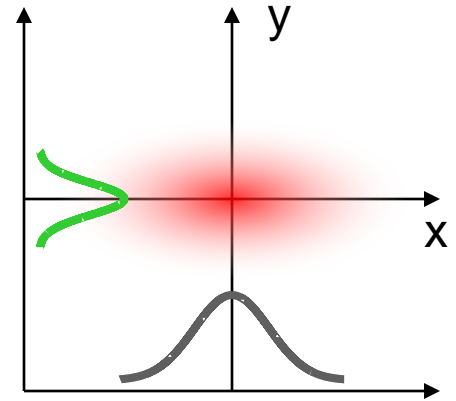

Transverse Beam Position

- Require centre of beam to always lie as close as possible to ideal orbit.
 - Defined by quadrupole axes.
 - Transverse deviation of circulating beam from orbit must be less than 100-150 μm .
 - Measure transverse position of beam at as many points around the accelerator and implement corrective measures.
-

Magnetic Beam Position Monitor

- Measure induced B-field due to beam.
- The difference in signals from the two opposite coils within each pair provides measure of beam position in that plane.
- In order to measure position in both planes simultaneously, install 4 coils arranged at 90° intervals around transformer coil.

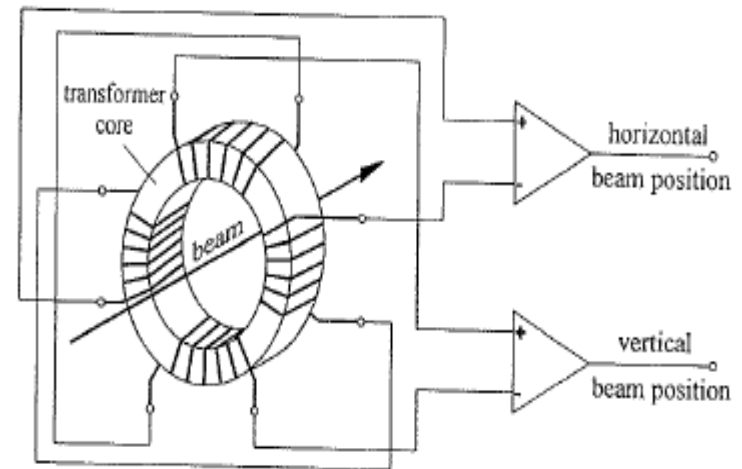

Magnetic beam position monitor

Electrode Beam Position Monitor

- Consists of 4 electrodes (electrical pick-ups) arranged symmetrically around beam axis coupling to E-field.
- Electrodes tilted away from beam axis by 45° in order to reduce amount of synchrotron radiation hitting them directly.

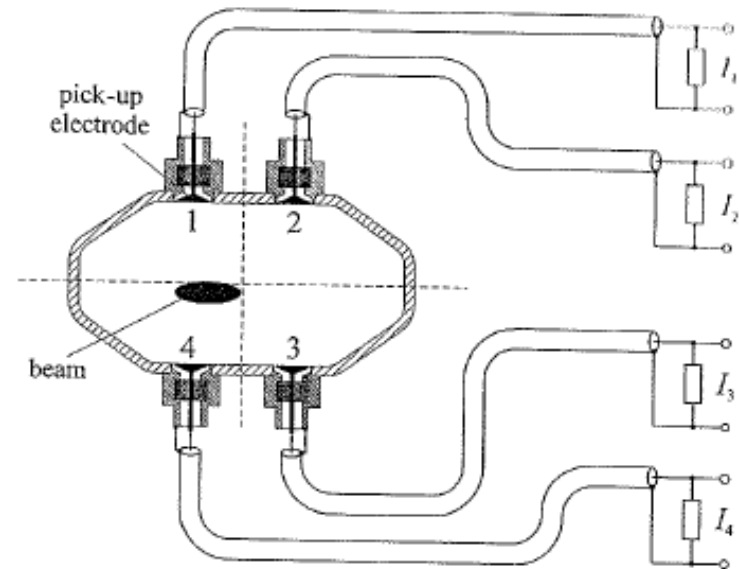

Beam position monitor with four electrodes

$$\Delta x = a \frac{(I_2 + I_3) - (I_1 + I_4)}{\sum_{j=1}^4 I_j}$$
$$\Delta z = a \frac{(I_1 + I_2) - (I_3 + I_4)}{\sum_{j=1}^4 I_j},$$

Monitor with Four Electrodes

- If beam lies exactly in middle of monitors, ideally all signals will have same intensity.
- But there are variations in signal sizes –
 - Electrode tolerance
 - Vacuum chamber geometry
 - Cables and electronics which follow for read-out
- If signal has intensity $I_0 + \Delta I$, will then have position error of

$$\Delta x_{\text{error}} = a \frac{\Delta I}{4 I_0}.$$

- For $a = 35$ mm and want $\Delta x_{\text{error}} < 0.1$ mm then the relative error in an electrode signal may not be larger than

$$\frac{\Delta I}{I_0} = \frac{4 \Delta x_{\text{error}}}{a} < 1.2\%.$$

Monitor with Four Electrodes

- Fundamentally, it is not possible to define with arbitrary precision the point relative to which the beam position is being measured.
 - Monitor connected to vacuum chamber, which is generally fixed to magnets.
 - Magnets positioned with tolerance of ± 0.2 mm.
 - Alignment errors of quadrupoles also create orbit distortions.
 - Even if beam position adjusted so that it has no offset in any of the monitors, this will not necessarily correspond to real ideal orbit.
-

Principle of Wire Scanner

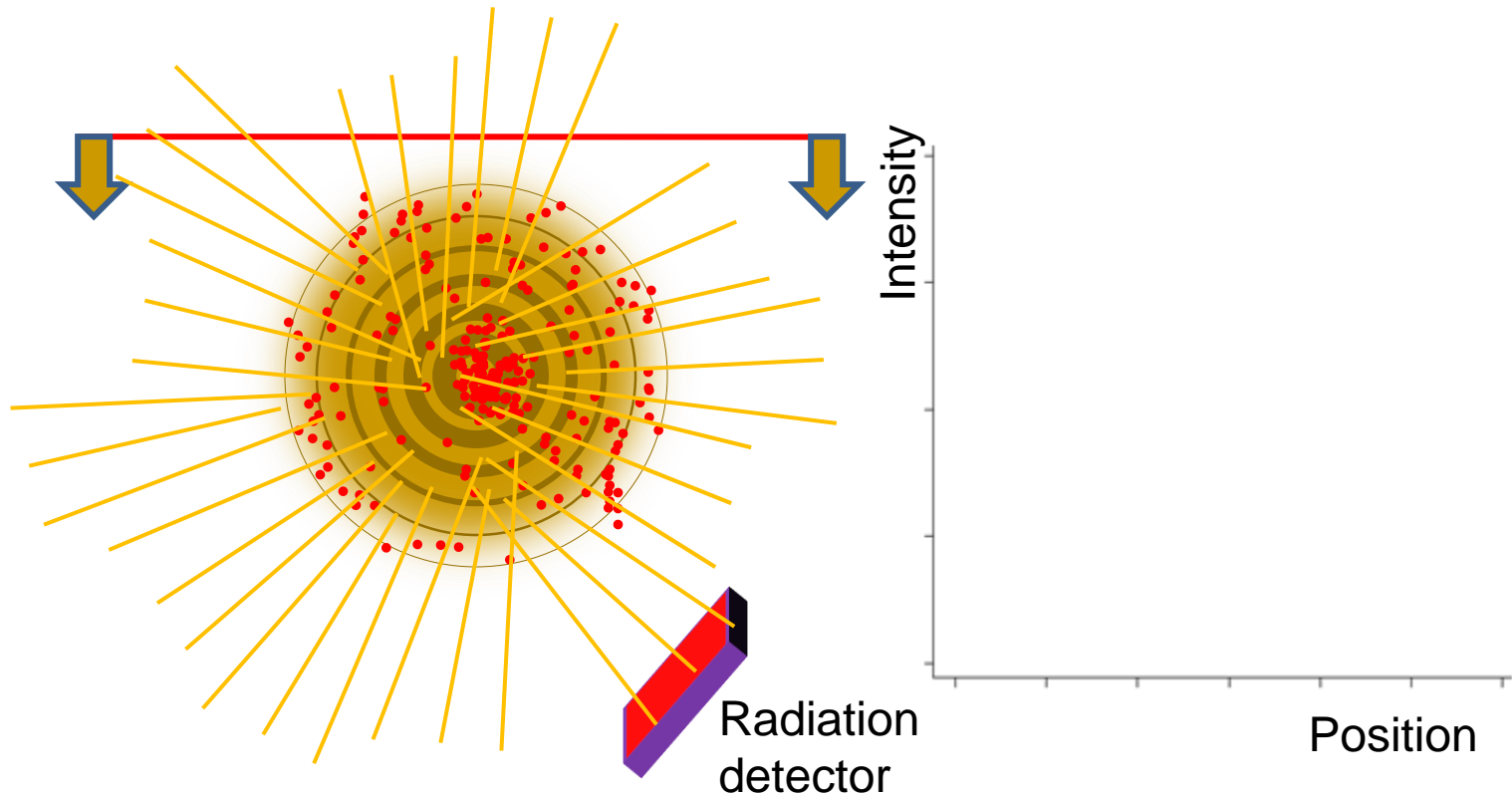

- 1D-Profile is measured either as intensity of radiation (Bremsstrahlung) or as secondary emitted electron current over position of wire.
- Resolution down to wire diameter (5-6 μm).
- Instead of movement, many wires can be used in a 'harp'.

Wire Scanner Designs

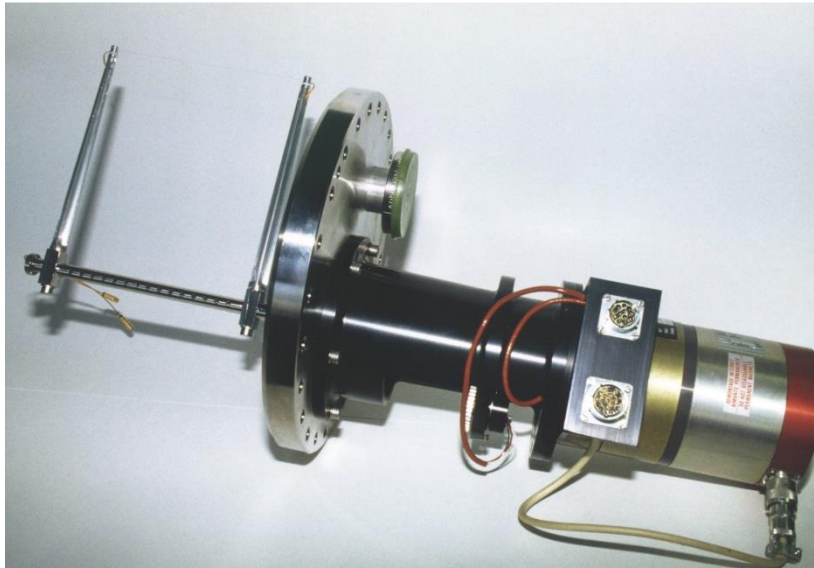

CERN AB/BI

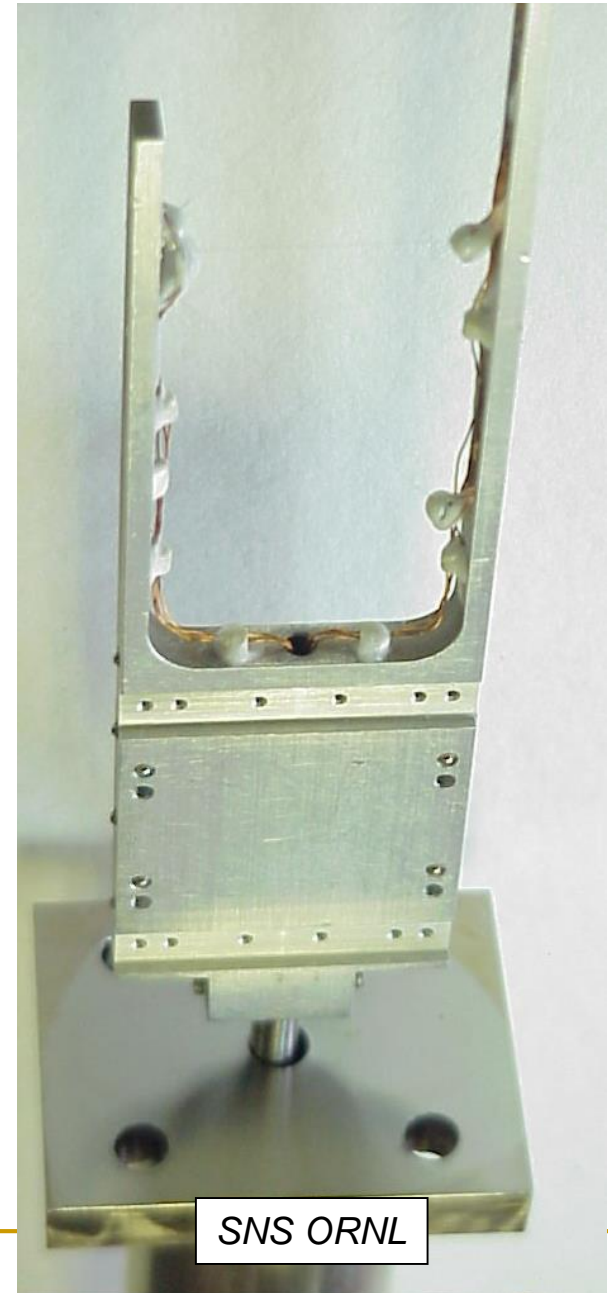
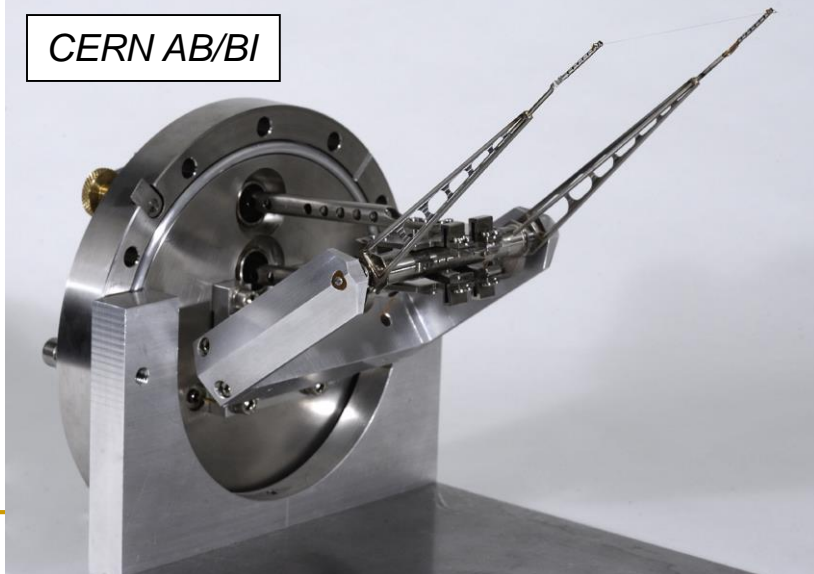

SNS ORNL

Limitations of Wire Scanners

- The smallest measurable beam size is limited by the finite wire diameter of a few microns.
- Higher Order Modes may couple to conductive wires and can destroy them.
- High beam intensities combined with small beam sizes will destroy the wire due to the high heat load, thus scan as fast as possible.
- Emittance blow up.

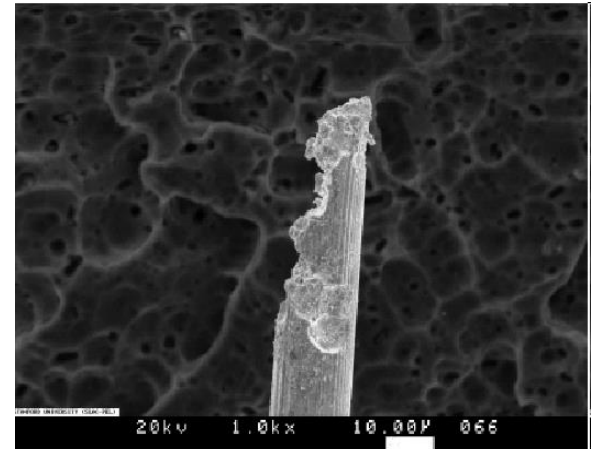

FIGURE 3. Failed 15 μm diameter tungsten wire showing the rough surface resulting from many discharges.

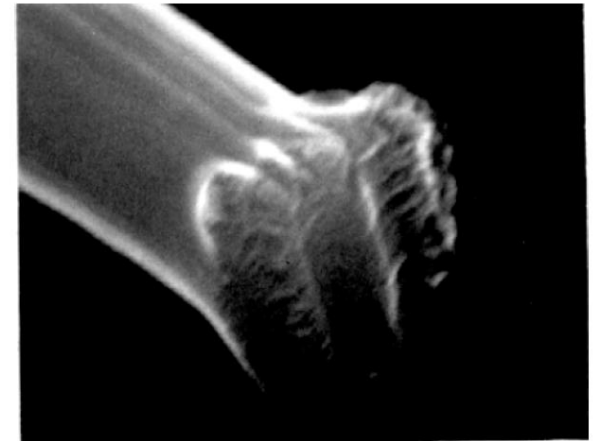

Figure 2: Broken 4 μm carbon wire at SLC. It is possible to observe how successive pulses have eroded the wire.

MEASUREMENT OF BETATRON FREQUENCY & TUNE

Betatron Frequency & Tune

- Once set of beam optics has been installed, the working point – tune Q – must be measured to check that it lies far enough away from strong optical resonances.
 - Tune $Q = q + a$
 - $q = \text{integer}$
 - $0 \leq a \leq 1$
- Measuring tune also allows detection of changes in focusing.
 - B-field imperfection
 - Space charge effect
- Use the tune to monitor stability of the beam focusing during machine operation.
- Amounts to measuring frequency of transverse beam oscillations.

Betatron Frequency and Tune

- The solution of the oscillation equation

$$\ddot{x}(t) + \frac{2}{\tau} \dot{x}(t) + \Omega^2 x(t) = 0$$

$$\Omega = \frac{2\pi}{T_u} a = \omega_u a \quad 0 \leq a \leq 0.5.$$

(assuming very weak damping from synchrotron radiation)

$$x(t) = \exp\left(-\frac{t}{\tau}\right) \left\{ x_0 \cos\left(2\pi a \frac{t}{T_u}\right) + \left[\frac{\beta_0 \dot{x}_0}{c} + \alpha_0 x_0\right] \sin\left(2\pi a \frac{t}{T_u}\right) \right\}$$

- Measurement
 - Fractional tune a
 - If beam undergoes betatron oscillations, measure Ω with fast position monitor since revolution frequency is fixed.
 - Integer tune q
 - Difference between reference orbit and standing betatron oscillation about reference orbit caused by altering steering coil strength.

Betatron Frequency & Tune

- Excite beam into coherent transverse oscillations.
 - Fast bending magnet (10^{-4} Tm) which produces periodic field

$$B(t) = B_0 \sin \omega_{gen} t$$

- Equation of forced motion

$$\ddot{x}(t) + \frac{2}{\tau} \dot{x}(t) + \Omega^2 x(t) = \kappa_{eff} \sin \omega_{gen} t.$$

- As damping is very weak, resonance occurs if $\omega_{gen} = \Omega$

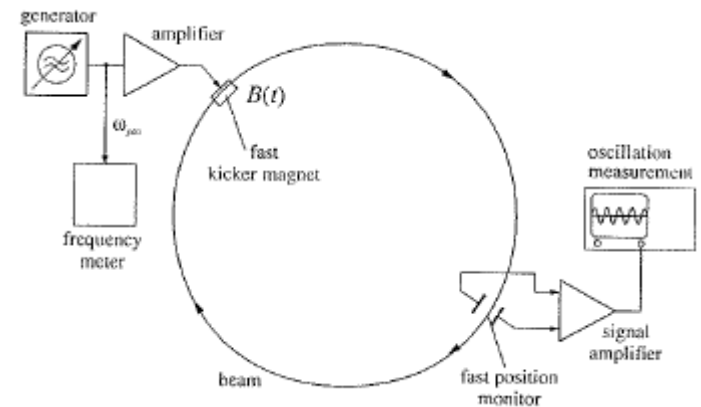

A fast kicker magnet stimulates beam at frequency ω_{gen} , which is varied until resonance is found.

Amplitude of induced betatron oscillation measured using fast position monitor

MEASUREMENT OF BEAM OPTICAL PARAMETERS

Beam Optical Parameters - Dispersion

- Determined from position measurements at several points around the orbit.
- Vary momentum p of particles by Δp while keeping magnet strengths constant.
- Beam position shifts distance

$$\Delta x(s) = D(s) \Delta p/p$$

onto dispersive trajectory.

- Dispersion is

$$D(s_i) = \frac{\Delta x(s_i)}{\Delta p/p} \quad \text{with} \quad \Delta x(s_i) = u(s_i) - u^0(s_i).$$

Beam Optical Parameters - Dispersion

- Change frequency ν_{RF} of accelerating voltage by $\Delta\nu$.
- Since phase focusing means the harmonic number remains constant, circumference of particle trajectory changes and hence no longer matches orbit.
- Stable particle path shifts onto dispersive trajectory \rightarrow corresponding change of momentum Δp

$$\frac{\Delta p}{p} = -\frac{1}{\alpha} \frac{\Delta \nu_{RF}}{\nu_{RF}}$$

Beam Optical Parameters – β Function

- If strength of quadrupole changes by amount Δk , tune of cyclic machine shifts by

$$\Delta Q = \frac{1}{4\pi} \int_{s_0}^{s_0+l} \Delta k \beta(s) ds.$$

- The size of shift is proportional to value of β function in quadrupole.
- Assuming k is constant along quadrupole axis and variation of β function is small in quadrupole

$$\Delta Q = \frac{\Delta k}{4\pi} \int_{s_0}^{s_0+l} \beta(s) ds \approx \frac{\Delta k}{4\pi} \langle \beta \rangle l.$$

- Start from particular set-up of beam optics and impose well-defined change in quadrupole strength Δk .
- By measuring tune Q before & after change the average β function in quadrupole is

$$\langle \beta \rangle = \frac{4\pi}{l} \frac{\Delta Q}{\Delta k}.$$

Beam Optical Parameters - Chromaticity

- Chromaticity measurement essential for correct tuning of sextupoles.
- Vary the momentum of circulating particles and measure tune Q before and after change.
- Momentum varied by changing RF frequency.
- Relationship between change in momentum and tune is far from linear.
 - Measure function $\Delta Q(\Delta p/p)$ whose value in the region around nominal value yields chromaticity.

Acknowledgements and References

- Guenther Rehm, *Diagnostics*, Cockcroft Institute Academic Training Programme 2008-2009
- Klaus Wille, *The Physics of Particle Accelerators*, Oxford University Press, 2005
- Edmund Wilson, *An Introduction to Particle Accelerators*, Oxford University Press, 2006

With special thanks!
