

Perspectives for Future Circular Colliders (1/3)

Lecture 1 : The FCC-ee

- Design study and infrastructure
- Accelerator design and performance
- Interaction region and detectors
- Physics discovery potential
- Strategic vision for the future

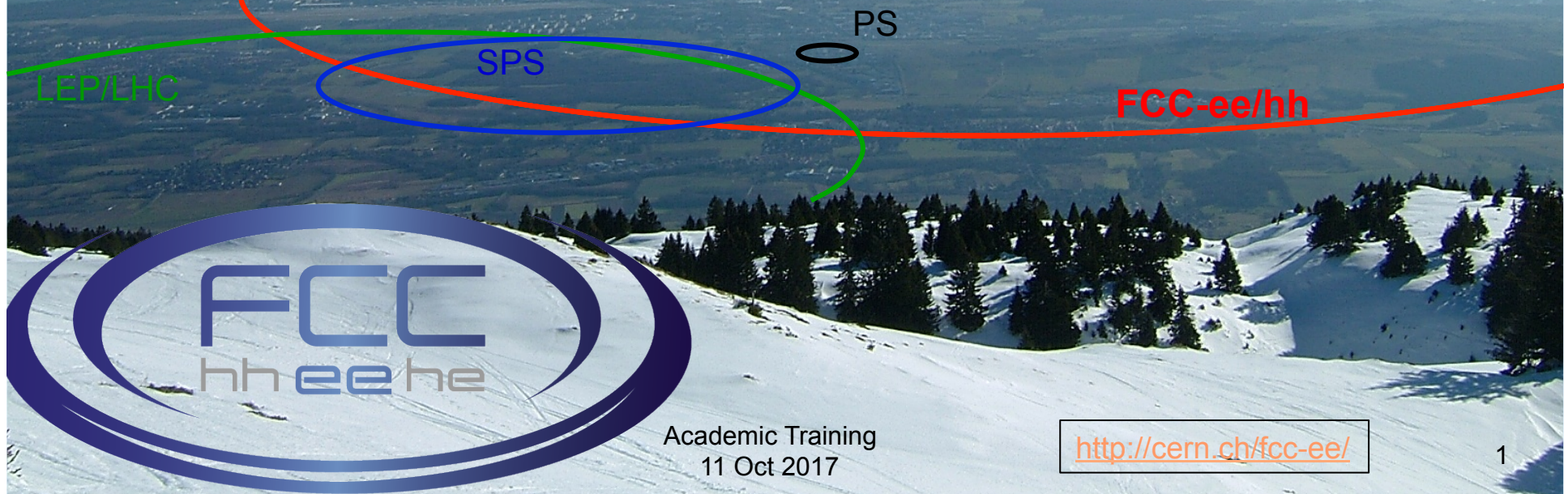

Design Study and Infrastructure

The FCC Design Study

- **Requested from European Strategy (2013)**
 - ◆ “Ambitious post-LHC accelerator project”
 - Study kicked off in Geneva in Feb. 2014
- **International collaboration to study circular colliders (111 institutes)**
 - ◆ Fitting in a new 100 km infrastructure, in the Geneva area
- **Ultimate goal: 100TeV pp collider (FCC-hh)**
 - ◆ Requires R&D for 16T magnets
 - ◆ Defines the infrastructure
- **Possible first steps**
 - ◆ e^+e^- collider (FCC-ee) at the intensity frontier
 - High luminosity, $\sqrt{s} = 90\text{-}400$ GeV
 - ◆ pp collider (HE-LHC) in the LEP/LHC tunnel
 - With FCC-hh technology (16T \rightarrow 28 TeV)
- **Possible add-on**
 - ◆ e-p option (FCC-eh)

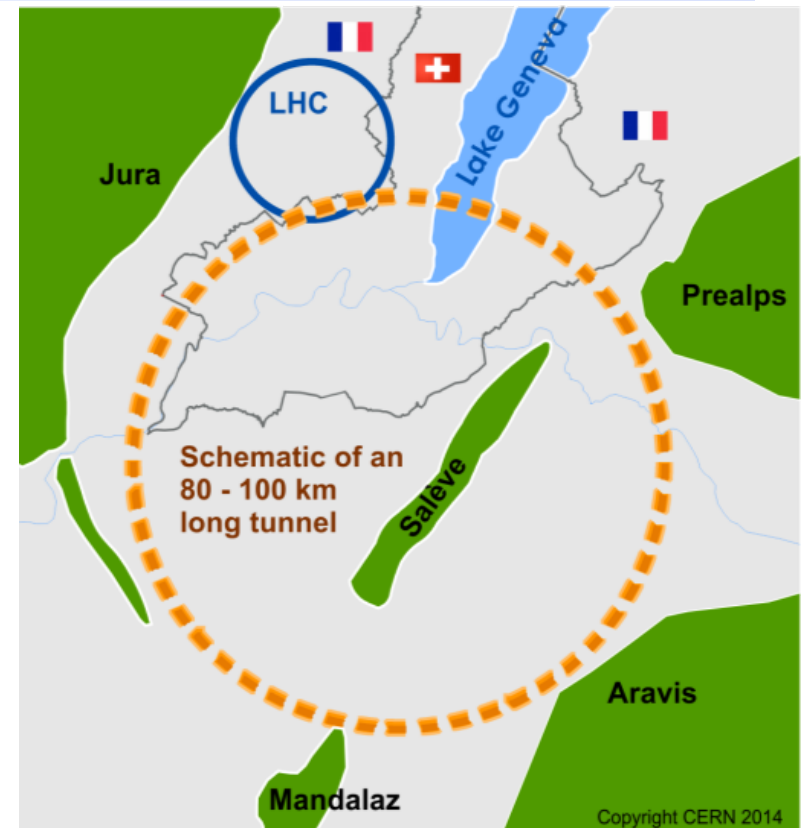

- **European Strategy update (2019)**
 - ◆ Conceptual design report (CDR)
 - ◆ Cost review for tunnel and each collider
 - ◆ Schedules and operation models

The FCC Home

Alignment Location

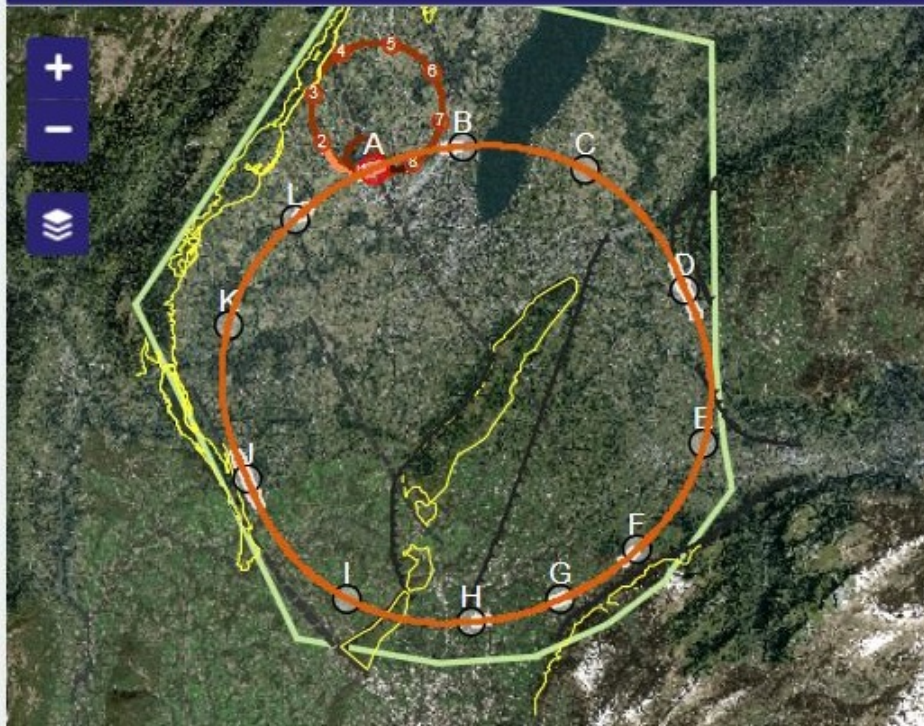

- **Optimized length: 97.5 km**
 - ◆ Accessibility, rock type, shaft depth, etc.
 - ◆ Tried different options from 80 to 100 km
- **Tunneling**
 - ◆ Molasse 90% (easy to dig)
 - ◆ Limestone 5%, Moraines 5% (tougher)
- **Shallow implementation**
 - ◆ 30m below Lemman lakebed
 - ◆ Only one very deep shaft (F, 476m)
 - Alternatives studied (e.g. inclined access)

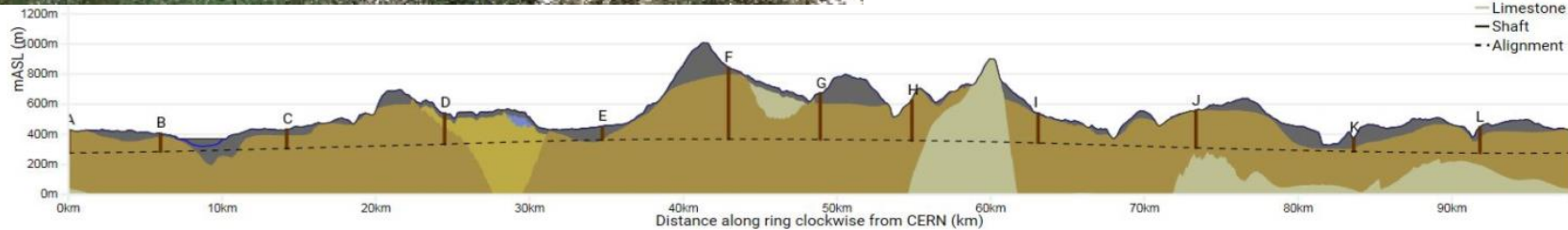

- Quaternary
- Lake
- Wildflysch
- Molasse subalpine
- Molasse
- Limestone
- Shaft
- · Alignment

Geology Intersected by Tunnel

Geology Intersected by Section

84.6%

5.2%

5.5%

4.7%

Same home for ee and hh

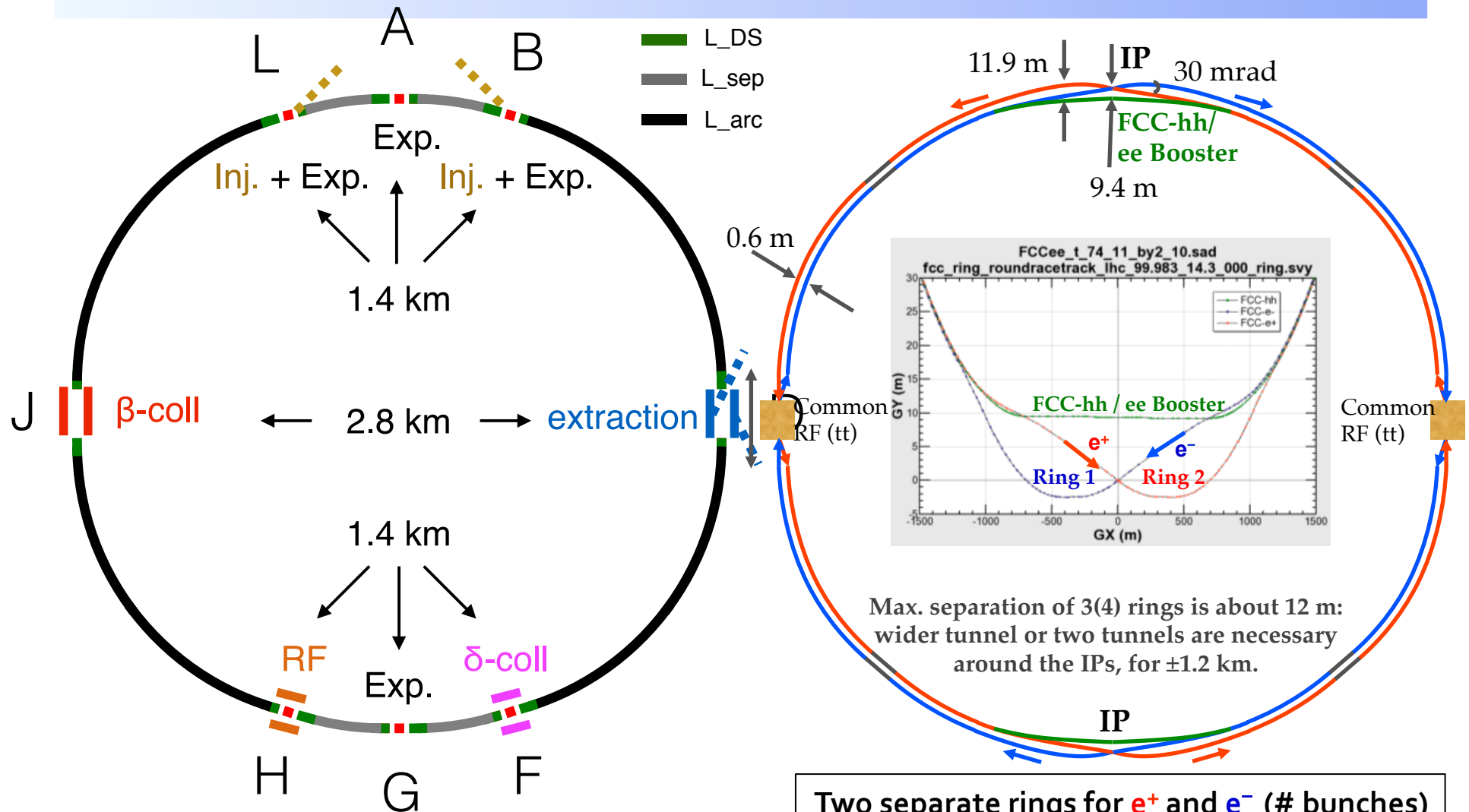

Two main IP's in A, G for both machines

Two separate rings for e^+ and e^- (# bunches)
 A booster for continuous top-up (lifetime)
 Asymmetric interaction region (SR)
 Crossing angle 30 mrad

More sharing

FCC-ee

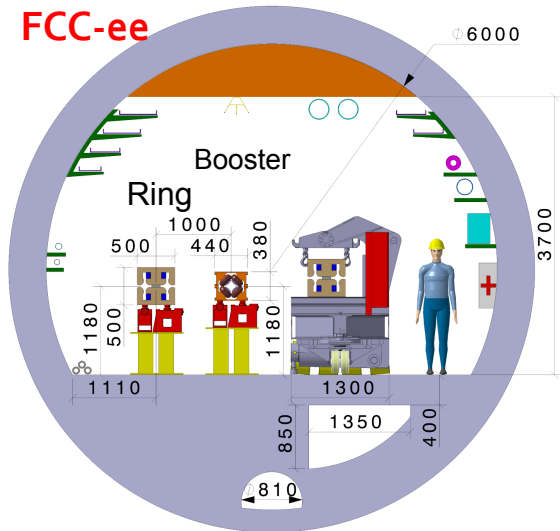

Tunnel enlargement
at points A and G
for ±1.2 km

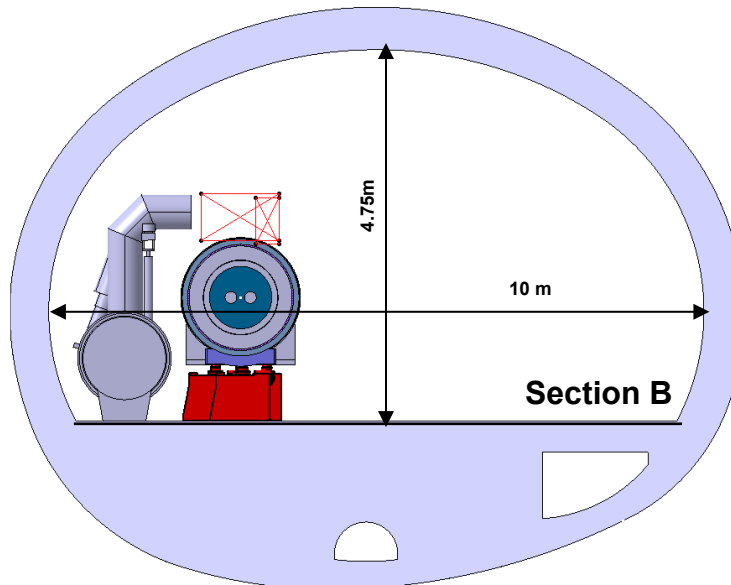

Detector cavern

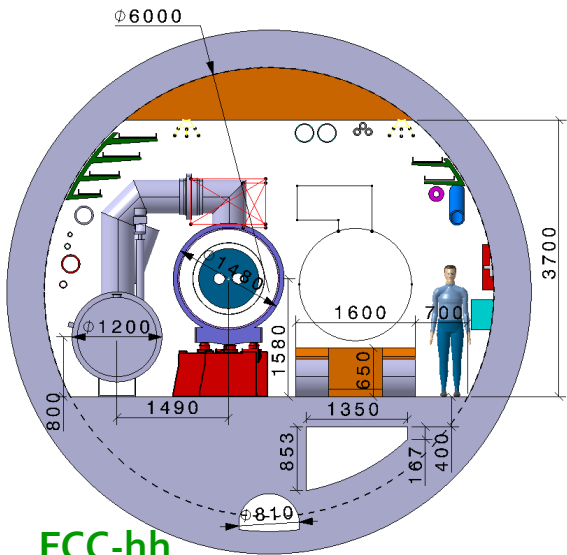
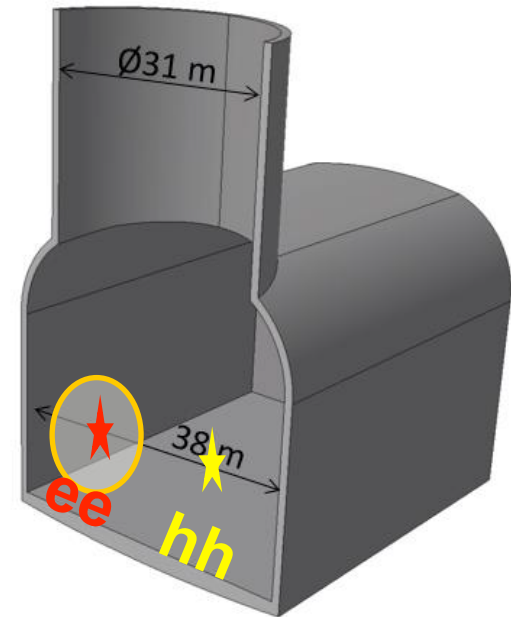

FCC-hh

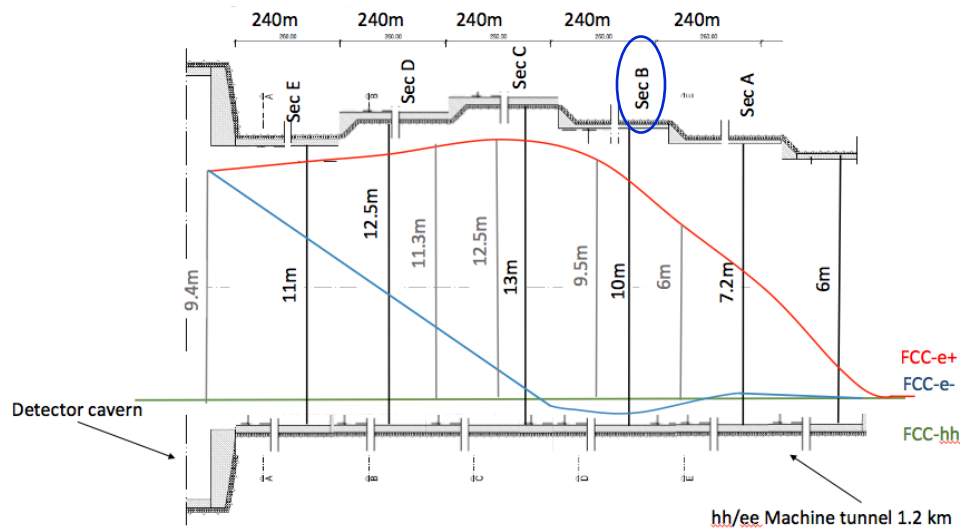

Patrick Janot

FCC-ee injector complex

□ Baseline is comprised of:

- ◆ An e^- and e^+ LINAC (length 250 m @ 25 MV/m) from ~0 to 6 GeV
- ◆ An e^+ production target and an e^\pm damping ring (circumference 250 m)
- ◆ A pre-booster ring (from 6 to 20 GeV) – probably in the SPS tunnel
- ◆ A booster ring (from 20 GeV to the full FCC-ee energy), for continuous top-up injection

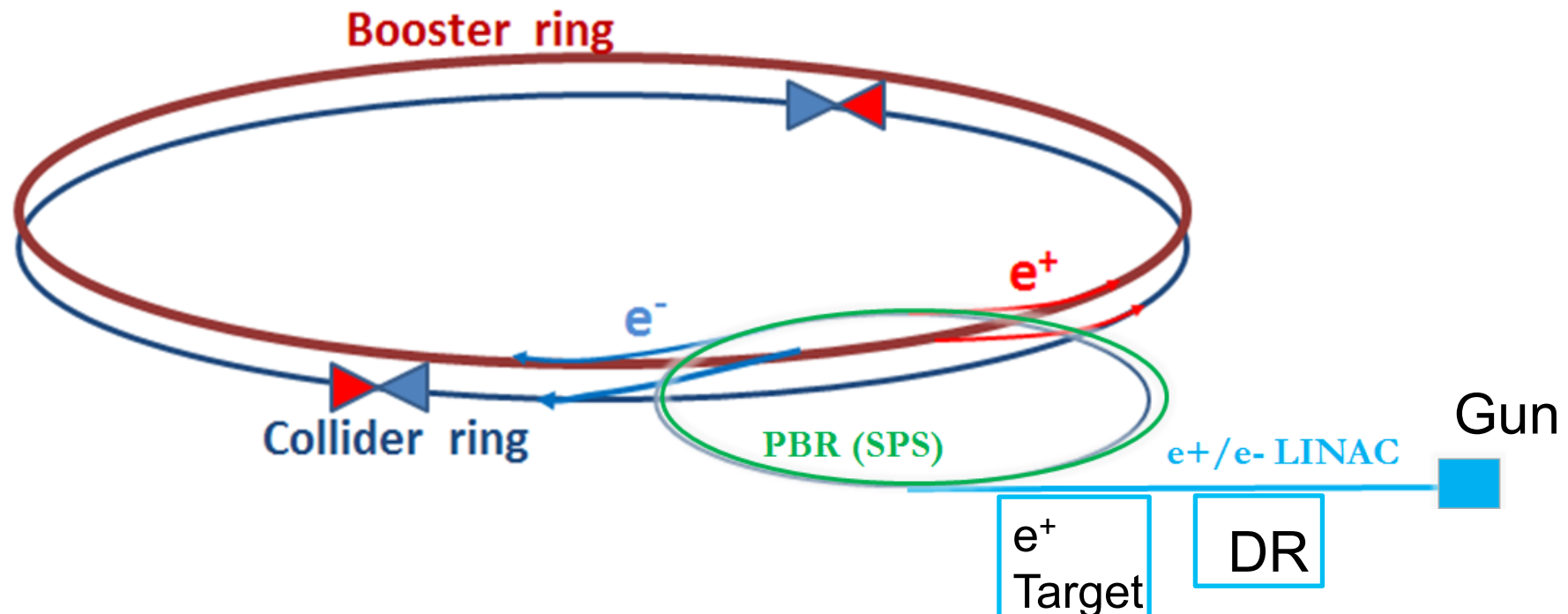

(Draft) Schedule considerations

Compare possible first steps (FCC-ee and HE-LHC)

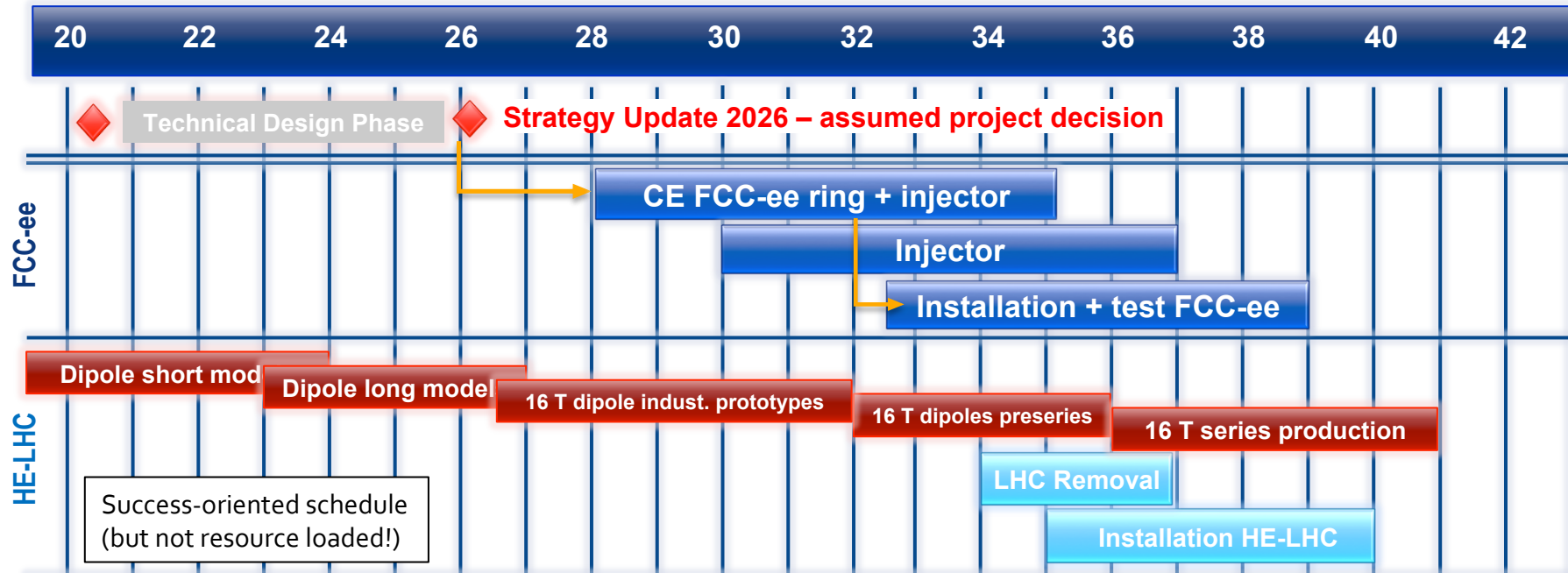

Personal remarks

- Why do we have to wait for two years after the project decision ? FCC-ee needs no 16T magnets
- Why waiting for 5.5 years before starting the installation of FCC-ee ring ?
 - Was done in parallel with Civil Engineering for LEP
- FCC-ee can start physics immediately after the end of HL-LHC – no physics gap at CERN
 - At least six years without physics with the HE-LHC
- FCC-ee buys time for the R&D, prototyping, and production of 16T magnets towards FCC-hh

Accelerator design and performance

FCC-ee centre-of-mass energies

Reminder: European Strategy statement (2013)

e) There is a strong scientific case for an electron-positron collider, complementary to the LHC, that can study the properties of the Higgs boson and other particles with unprecedented precision and whose energy can be upgraded.

Other heavy particles: the Z (91.2 GeV) & W (80.4 GeV) bosons, the top quark (173.3 GeV)

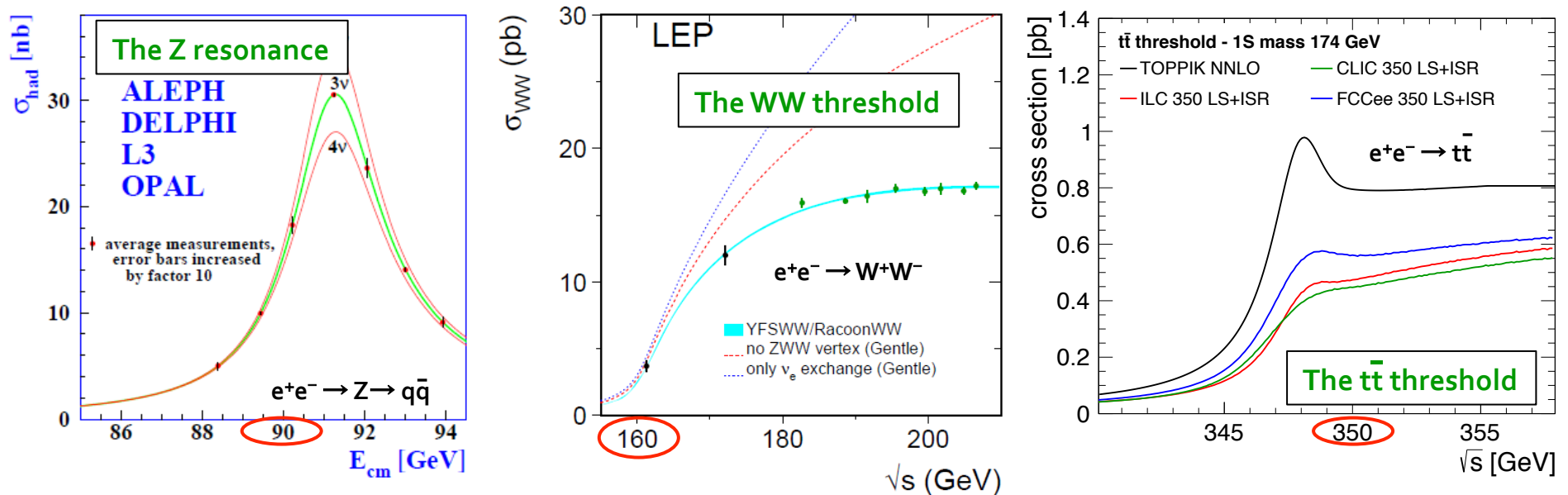

Lighter fermions (e.g., b quark, τ lepton) studied with Z decays

FCC-ee centre-of-mass energies, cont'd

□ Reminder: European Strategy statement (2013)

e) There is a strong scientific case for an electron-positron collider, complementary to the LHC, that can study the properties of the Higgs boson and other particles with unprecedented precision and whose energy can be upgraded.

◆ The Higgs boson ($m_H = 125$ GeV)

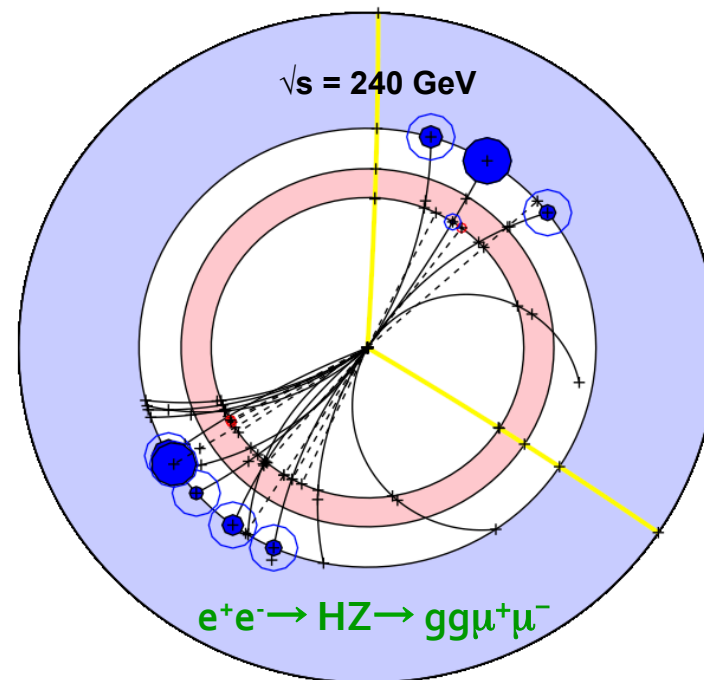
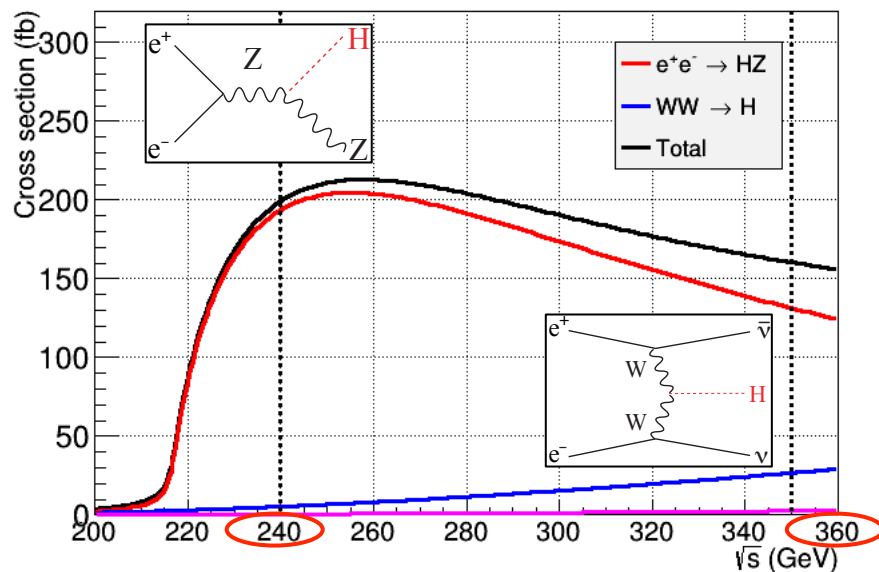

◆ The gluon can be studied with Higgs decays (BR ~ 10%)

FCC-ee baseline luminosities

Reminder: European Strategy statement (2013)

e) There is a strong scientific case for an electron-positron collider, complementary to the LHC, that can study the properties of the Higgs boson and other particles with unprecedented precision and whose energy can be upgraded.

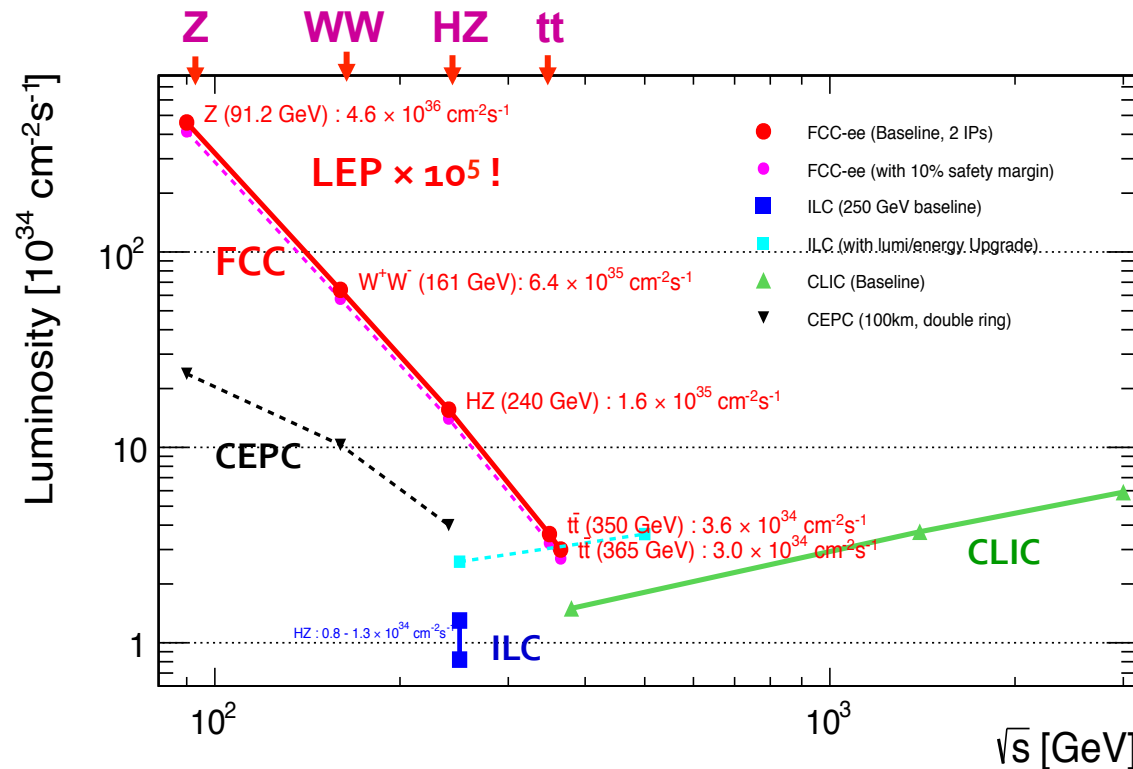

Ultimate precision with

- ◆ 100 000 Z / second (!)
- 1 Z / second at LEP
- ◆ 10 000 W / hour
- 20 000 W in 5 years at LEP
- ◆ 1 500 Higgs bosons / day
- 10-20 times more than ILC
- ◆ 1 500 top quarks / day

... in each detector

The FCC-ee unique discovery potential is multiplied by the presence of the four heavy particles of the standard model in its energy range

FCC-ee energy upgrade

□ **Reminder: European Strategy statement (2013)**

e) There is a strong scientific case for an electron-positron collider, complementary to the LHC, that can study the properties of the Higgs boson and other particles with unprecedented precision and whose energy can be upgraded.

◆ In e^+e^- colliders, an energy upgrade is mostly relevant for

● The production and study of (a) putative new particle(s) at high mass

➤ The domain covered by CLIC (0.4 – 3 TeV) is being explored by the LHC

CLIC becomes an interesting option to consider if a new particle produced in e^+e^- collisions is discovered / hinted at in this range

➤ A much bigger energy step is needed to go further: FCC-hh better suited

● The measurement of the $t\bar{t}H$ and $HHH(H)$ couplings

➤ In combination with FCC-ee, the FCC-hh does better than linear colliders

◆ The energy upgrade of the FCC-ee, i.e. FCC-hh, is the most ambitious scientifically

● The FCC-ee is not only complementary to, but also synergetic with, FCC-hh

□ **Conclusion of the previous four slides: the FCC-ee is the e^+e^- collider that complies best with the 2013 European Strategy statement**

Q: Why is luminosity so much higher than LEP?

A: Design inspired by B factories

- ◆ Fix 100 MW Synchrotron Radiation (SR) at all energies
 - Larger beam currents possible at lower energies
- ◆ Two separate rings for e+ and e-
 - Many bunches to distribute the beam currents, without parasitic collisions
- ◆ Larger ring (×4)
 - $P_{SR} \propto E^4/\rho$
- ◆ Asymmetric IP
 - SR@175 GeV ~ LEP
- ◆ Strong vertical focusing
 - $\beta^* \sim O(1 \text{ mm})$
- ◆ Crab-waisted crossing
 - Optimize colliding area
- ◆ Larger energy acceptance
 - Beamstrahlung limit
- ◆ Continuous injection
 - Better efficiency
 - Smaller asymmetry

	Z	W	H (ZH)	ttbar
beam energy [GeV]	45.6	80	120	182.5
arc cell optics	60/60	90/90	90/90	90/90
emittance hor/vert [nm]/[pm]	0.27/1.0	0.28/1.0	0.63/1.3	1.45/2.7
β^* horiz/vertical [m]/[mm]	0.15/1.8	0.2/1	0.3/1	1/2
SR energy loss / turn (GeV)	0.036	0.34	1.72	9.21
total RF voltage [GV]	0.10	0.44	2.0	10.9
energy acceptance [%]	1.3	1.3	1.5	2.5
energy spread (SR / BS) [%]	0.038 / 0.132	0.066 / 0.153	0.099 / 0.151	0.15 / 0.20
bunch length (SR / BS) [mm]	3.5 / 12.1	3.3 / 7.65	3.15 / 4.9	2.5 / 3.3
bunch intensity [10^{11}]	1.7	1.5	1.5	2.8
no. of bunches / beam	16640	2000	393	39
beam current [mA]	1390	147	29	5.4
SR total power [MW]	100	100	100	100
luminosity [$10^{34} \text{ cm}^{-2}\text{s}^{-1}$]	230	32	7.8	1.5
luminosity lifetime [min]	70	50	42	44
allowable asymmetry [%]	±5	±3	±3	±3

Q: Aren't the machine parameters stretched ?

□ A: Challenging, but ...

◆ Now backed up by a very solid design study (2014-2017)

● Many considerations underwent complete/multi-turn/independent simulations

- Beam-beam instabilities
- Bootstrapping for first full injection
- Flip-flop effect
- Off-momentum dynamic aperture
- Working-point optimization
- Crab waist strength optimized for each \sqrt{s}
- Beamstrahlung and beam lifetime
- Injector cycles and minimum sustainable lifetime
- Etc.

Example:
Suppression of a coherent instability
in the x-z plane

- By reducing β_x^* by a factor 3
- By increasing the momentum compaction factor by a factor 2

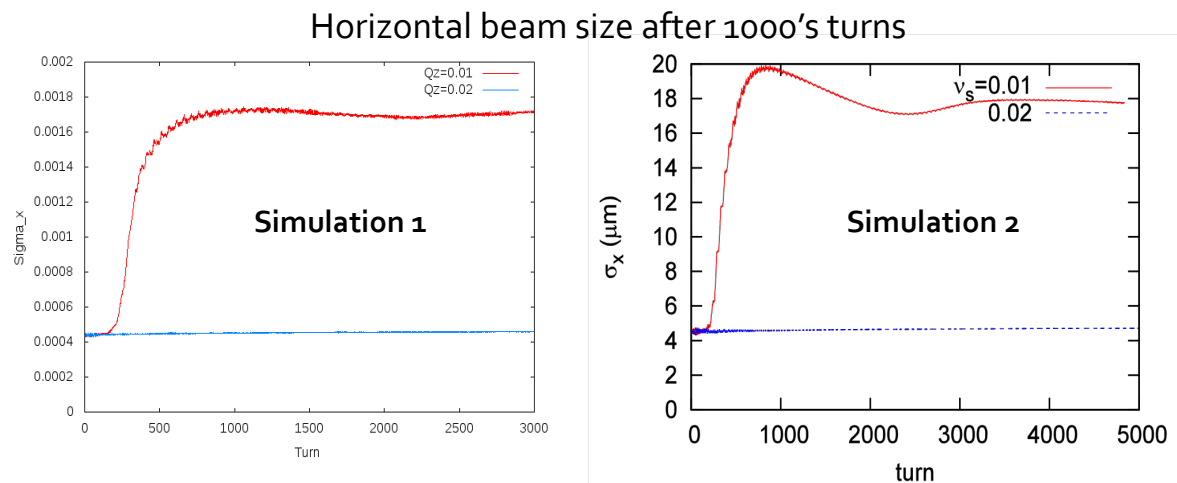

Q: Aren't the machine parameters stretched ?

□ A: Challenging, but ...

- ◆ Now backed up by a very solid design study (2014-2017)
- ◆ Most parameters are being commissioned at SuperKEKB

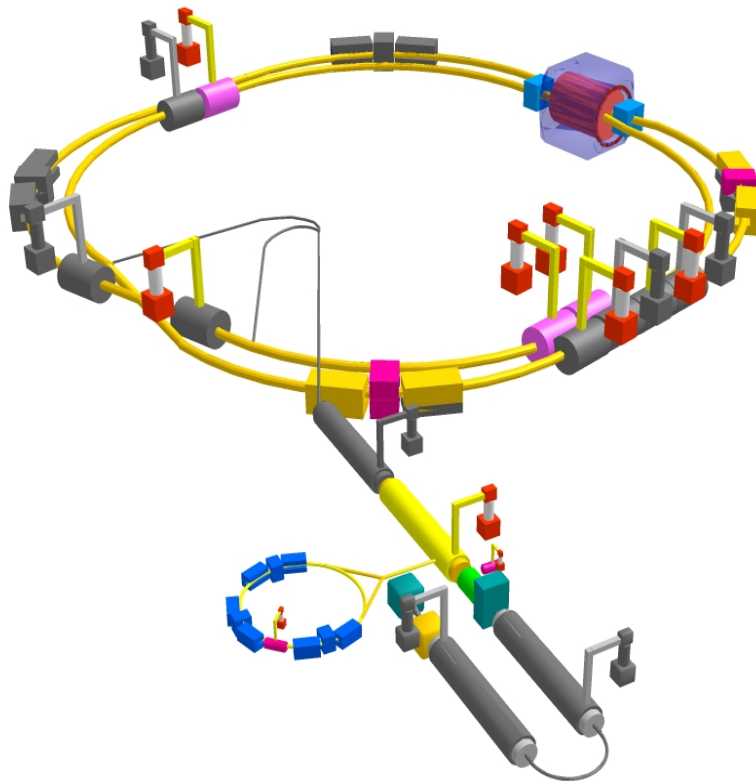

Commissioning Phase 2 starting in Oct. 2017
Phase 3 starting in fall 2018

Some SuperKEKB parameters :

β_y^* : 270 μm

FCC-ee (Z) : 800 μm

ϵ_y/ϵ_x : 0.25%

FCC-ee (tt) : 0.2%

e^+ production rate : $2.5 \times 10^{12} / \text{s}$

FCC-ee (Z) : $0.4 - 2.5 \times 10^{12} / \text{s}$

Beam current : 3.6 A

FCC-ee (Z) : 1.4 A

Off-momentum acceptance : $\pm 1.5\%$

FCC-ee (tt) : $\pm 2.5\%$

Luminosity lifetime : 2.5 minutes

FCC-ee (tt) : 40 minutes

Crossing angle : 83 mrad

FCC-ee : 30 mrad

Centre-of-mass energy: ~ 10 GeV

FCC-ee : 88 - 365 GeV (*)

(*) See next slide

The SCRF system: optimization and staging

Very broad range of operation parameters

- ◆ SR energy loss from 36 MeV to 9.21 GeV
- ◆ Total voltage from 0.1 (Z) to 11 GV (tt)
- ◆ Total current from 5.4 mA (tt) to 3.9 A (Z)
 - Aim at acceleration efficiency and cost reduction at high energy
 - Aim at cell shape and impedance optimization against HOMs at high current
- ◆ Fast acceleration from 20 to 45 – 182.5 GeV in the booster

Solution : Operation staging

- ◆ Start with 400 MHz Nb/Cu cavities @ 4.5K for the Z, WW, and Higgs operation modes

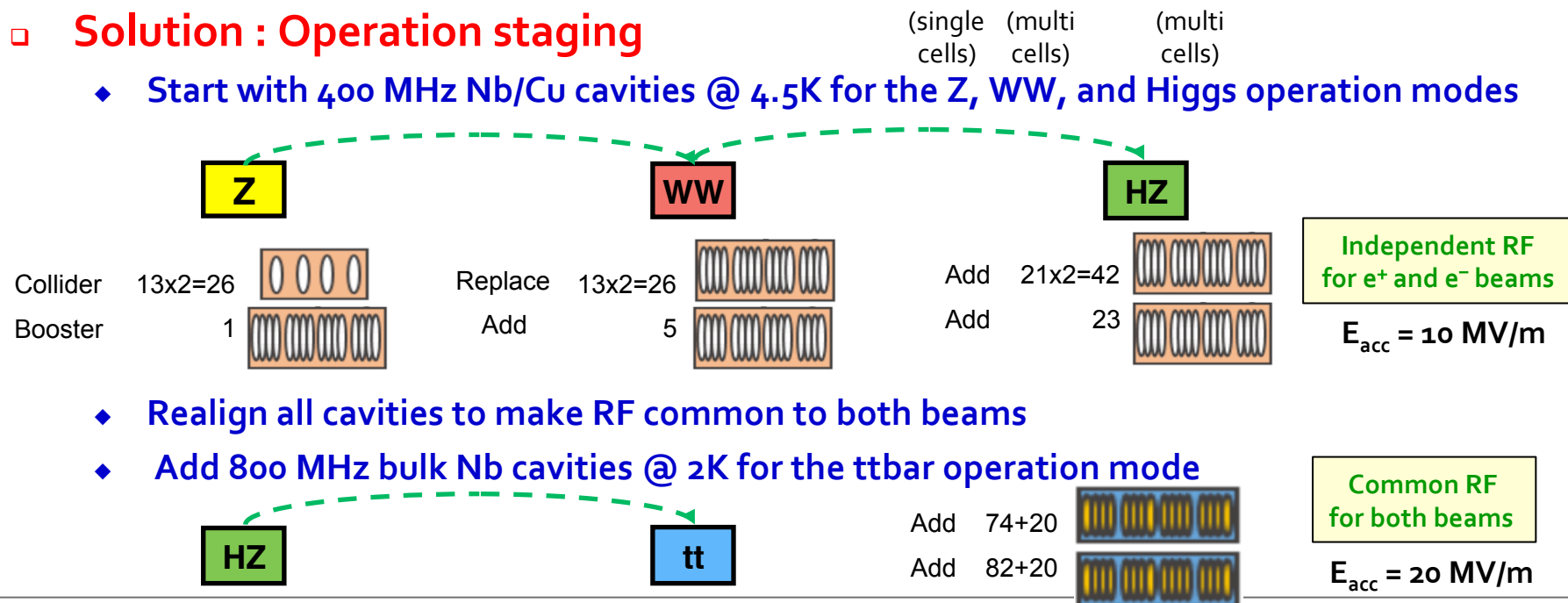

Power consumption

- **The RF system needs to compensate for 100 MW SR losses**
 - ◆ Corresponds to 200 MW electric power with 50% RF power sources (klystrons)
 - Klystron efficiency was ~55% at LEP2
 - ◆ Recent (2015) breakthroughs in klystron design promise 90% efficiency
 - Assume 85% will be achieved and take 10 – 20% margins

lepton collider	Z		W	ZH	$t\bar{t}$	LEP2
luminosity / interaction point [$10^{34} \text{ cm}^{-2}\text{s}^{-1}$]	207	90	19	5	1.3	0.012
total RF power [MW]	163		163	145	145	42
collider cryogenics [MW]	3	2	5	23	39	18
collider magnets [MW]	3		10	24	50	16
booster RF & cryogenics [MW]	4		4	6	7	N/A
booster magnets [MW]	0		1	2	5	N/A
pre-injector complex [MW]	10		10	10	10	10
physics detectors (2) [MW]	10		10	10	10	9
cooling & ventilation [MW]	47		49	52	62	16
general services [MW]	36		36	36	36	9
total electrical power [MW]	276	~275	~288	~308	~364	~120

- ◆ For comparison
 - LHC Run1: 210 MW, HL-LHC: 260 MW, FCC-hh: ~500 MW
 - CLIC: 250 MW (at 380 GeV) to 580 MW (at 3 TeV)

Interaction region and detectors

Requirements and constraints

□ Maximize luminosity

- ◆ Extremely small beta functions at the IP
 - $\beta_y^* = 0.8$ to 2 mm (LEP2: 50 mm)
- ◆ Very low beam emittances (and ratio)
 - $\epsilon_x = 0.27$ to 1.45 nm (LEP2: 22 nm)
 - $\epsilon_y = 1$ to 2.7 pm (LEP2: 250 pm)
- ◆ Crab waist optics
 - Crossing angle = 30 mrad (LEP2: 0 mrad)
- ◆ Calls for a focussing system (quadrupoles, sextupoles) close to the IP
 - $L^* = 2.2$ m chosen for FCC-ee : final focus quads inside the detector

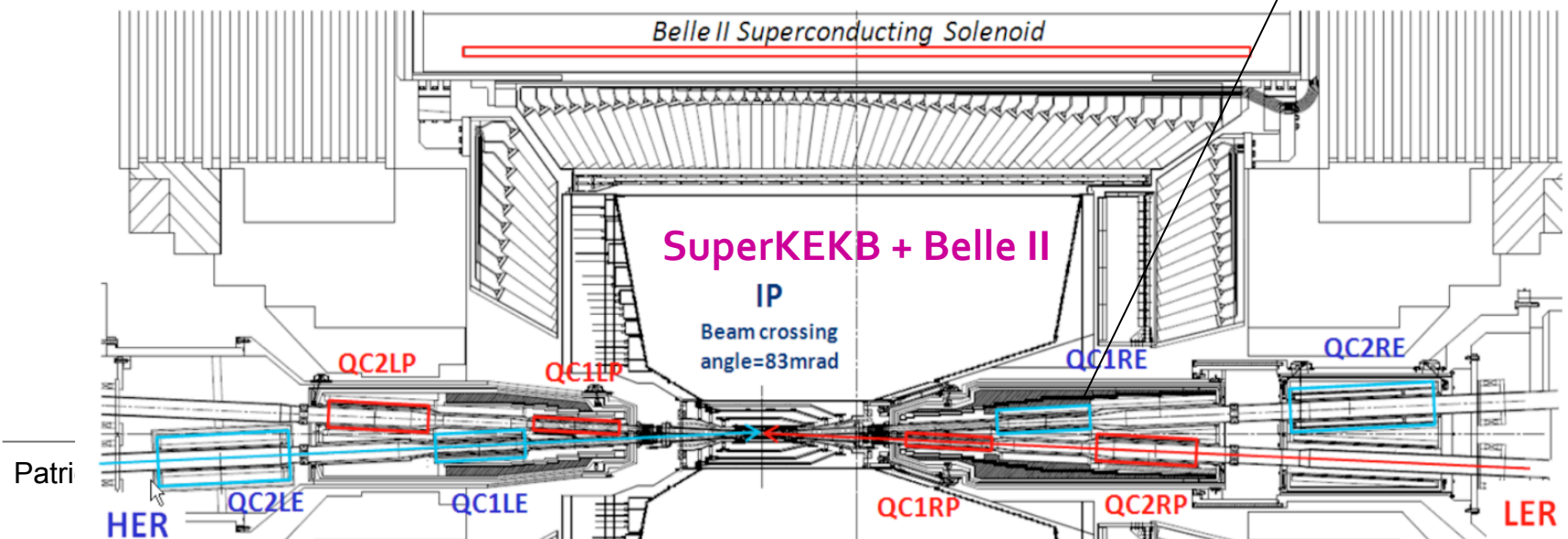
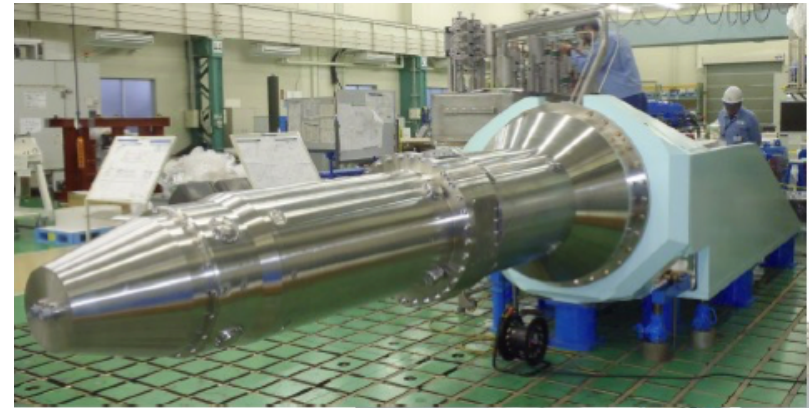

Requirements and constraints, cont'd

- **Minimize adverse effects from the detector**
 - ◆ **Emittance blow-up from detector magnetic field (beam crossing at angle)**
 - **Requires a compensating solenoid even closer to the IP**
 - **Which in turn limits the detector magnetic field to 2T**
 - **And a magnetic shielding around the final focus quads**

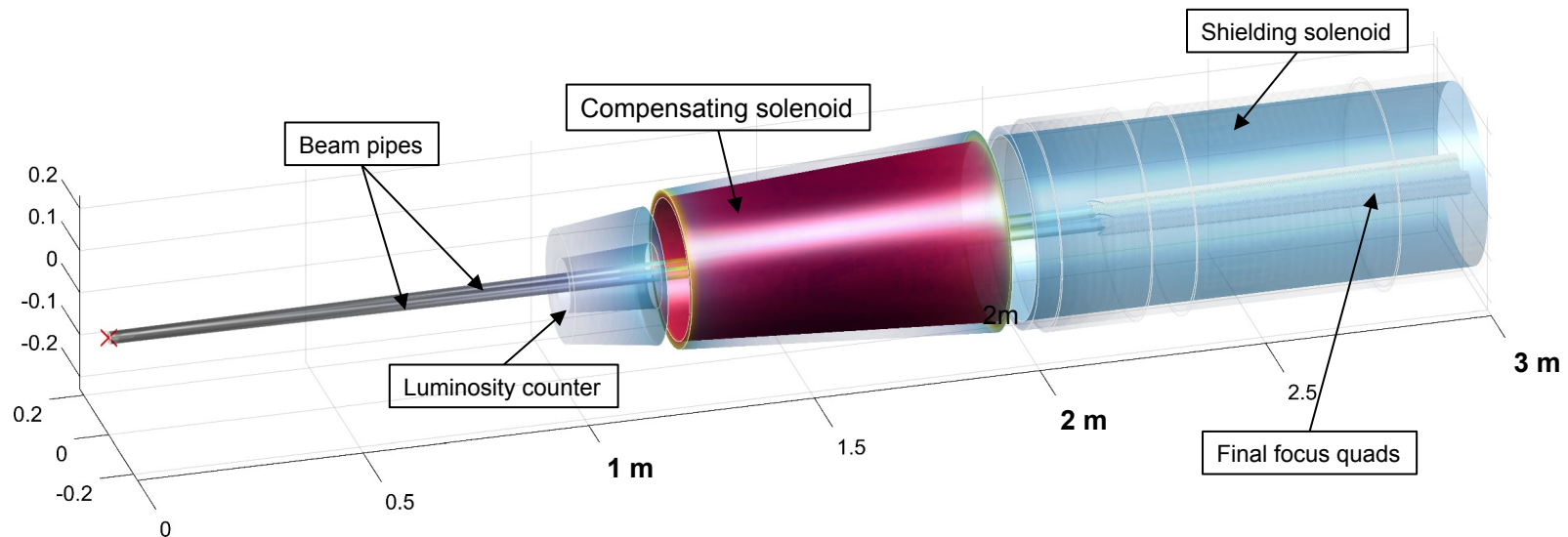

- **Not much room left for the luminosity counter (with low-angle Bhabha $e^+e^- \rightarrow e^+e^-$)**
 - **Front face at 1.2 m from the IP (typically twice closer to IP than at LEP)**

Requirements and constraints, cont'd

- ❑ **Minimize adverse effects on the detector**
 - ◆ Synchrotron radiation still produces important backgrounds in the detector inner layers
 - Reduced to adequate levels with beam pipe shielding

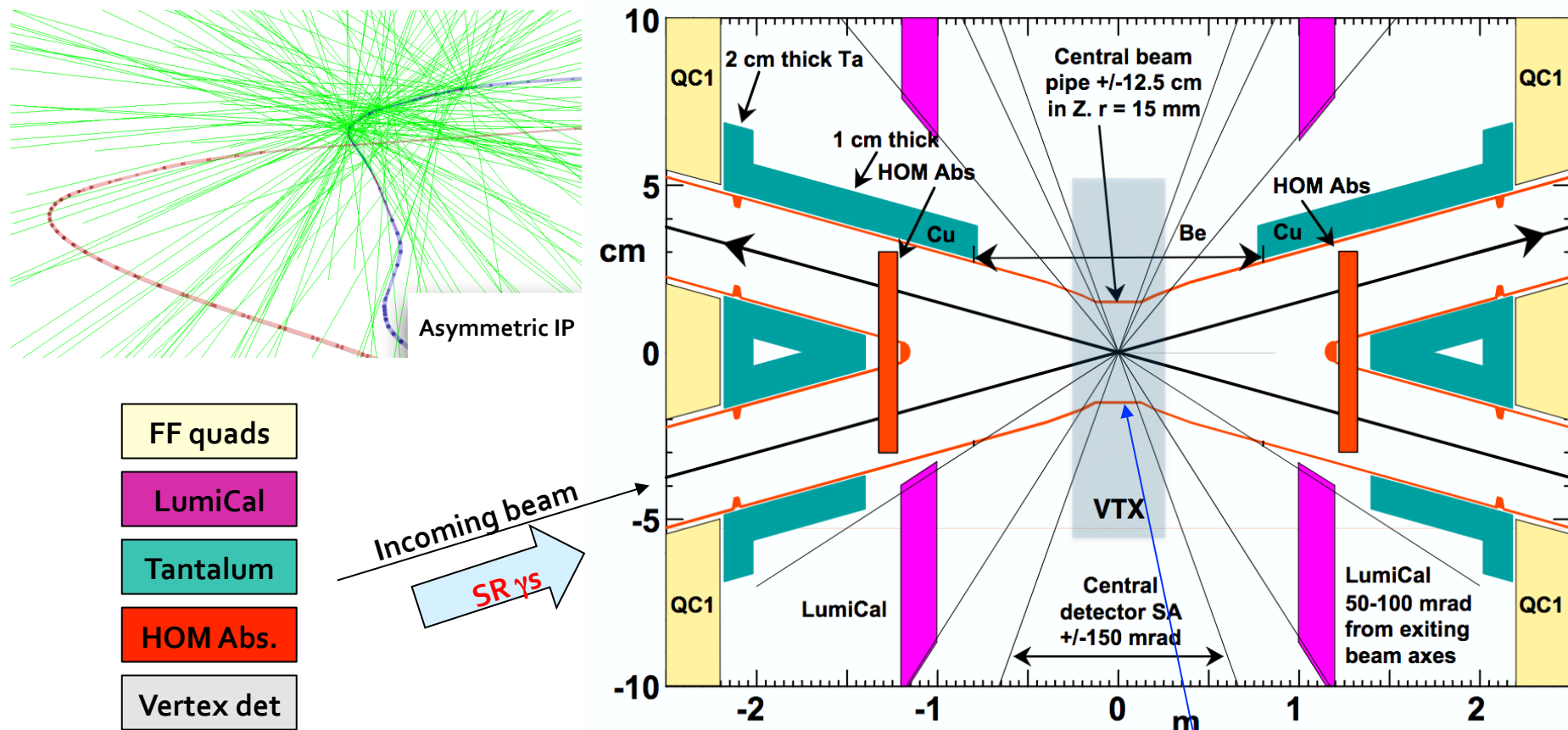

Detector occupancy

□ Dominant backgrounds

- ◆ Synchrotron radiation
- ◆ Interactions between γ s from beamstrahlung
 - $\gamma\gamma \rightarrow e^+e^-$ (#particles / BX: see figure)
 - $\gamma\gamma \rightarrow$ hadrons (0.005 event / BX)

□ Effects on first detector layer

- ◆ Reasonable assumptions
 - Silicon pixel detector
 - Radius : 17 mm
 - Pixel pitch : $25 \times 25 \mu\text{m}^2$
 - Safety factor : 3
- ◆ Full simulation (GuineaPig, GEANT)
 - Estimated occupancy $\sim 5 \times 10^{-4}$ / BX
 - Both at the top and the Z

□ Needs for fast electronics ?

- ◆ At the Z, one bunch crossing every 20 ns
 - Keep occupancy below 1% with electronics integration time $< 0.4 \mu\text{s}$

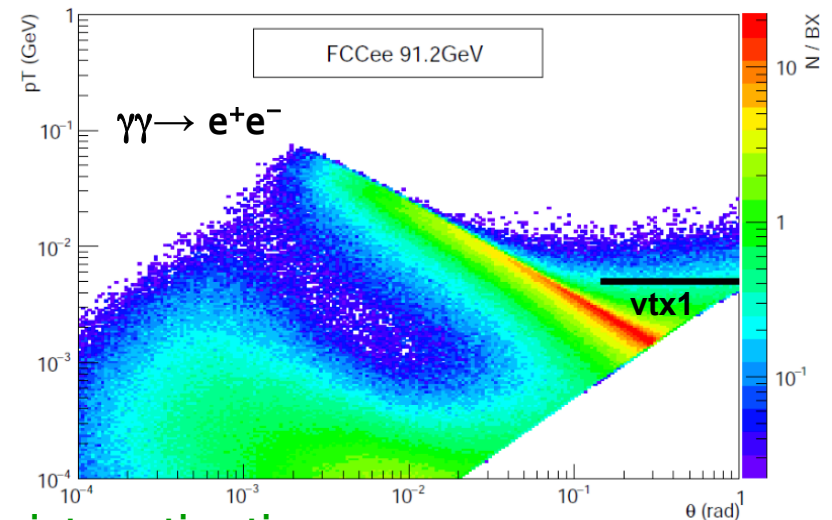
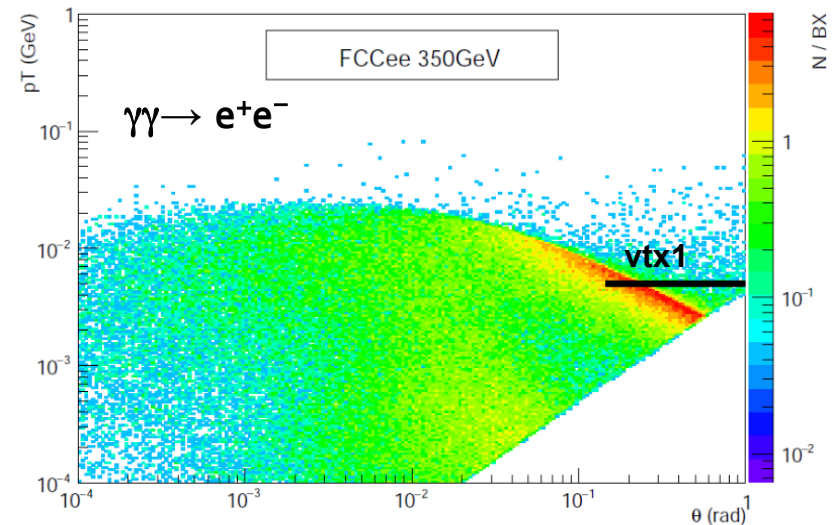

The luminosity monitor

- Design largely inspired from FCAL study for linear colliders
 - ◆ Same geometry works: “just” make it smaller and closer to the IP
 - Centred around the outgoing beam (measures the outgoing particle deviation)

- + Length 10 cm (1.05 to 1.15m)
- + Radius from 5.4 to 14.2 cm
- + 30 layers ($1X_0$) of 3.5mm W + 1mm Si
- + 32×32 Si pads in (r, ϕ) : 3×10^4 channels
- + Mechanical support on FF system
- + Total Acceptance: 45-95 mrad
- + Loose acceptance: 63-83 mrad
- + Tight acceptance: 68-78 mrad
- + $\sigma(e^+e^- \rightarrow e^+e^-) = 6-13$ nb
- + Statistical precision on luminosity:
 - Few 10^{-5} at the Z pole
 - Few 10^{-4} at the $t\bar{t}$ threshold
- + Positioning with $1\mu\text{m}$ precision (!)

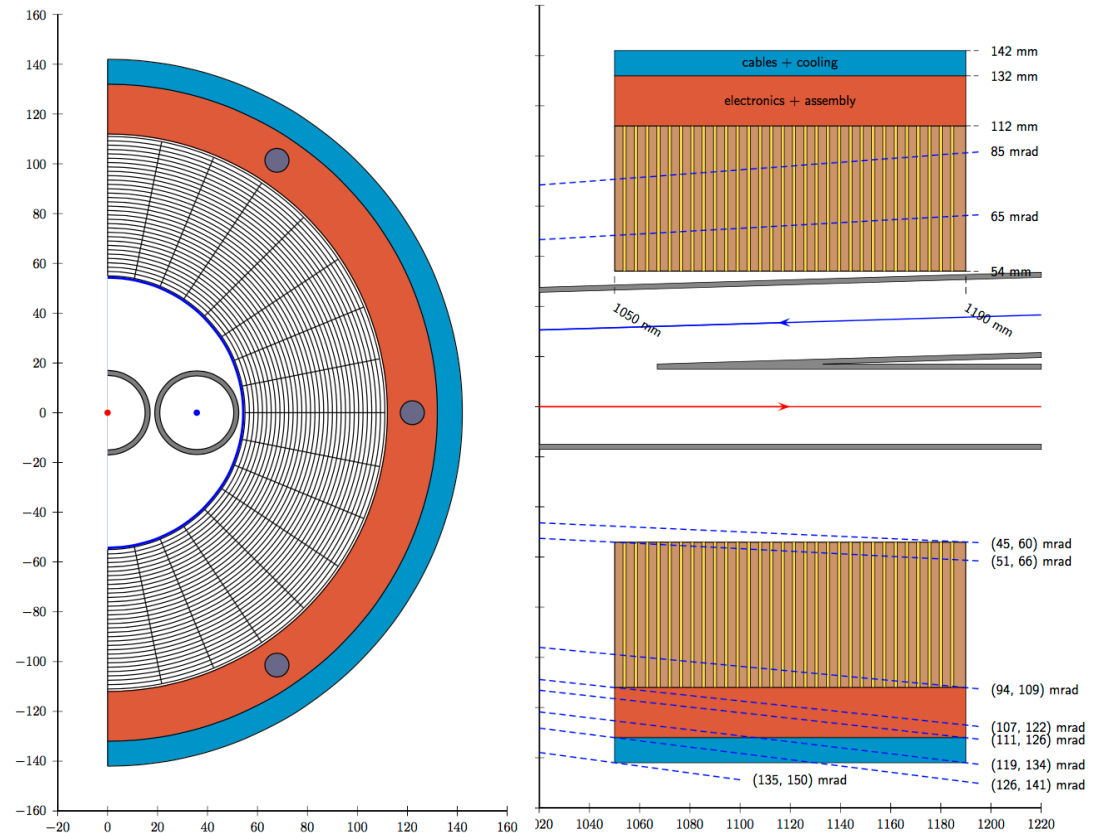

The central detector

- **With 100,000 Z / second / detector, expect more than 2×10^{12} Z / year**
 - ◆ Statistical accuracies on cross sections, asymmetries, etc. of 10^{-5} or better
 - Experimental uncertainties must be controlled at this level too
 - Demands state-of-the-art performance for all detector subsystems
- **Vertex detector**
 - ◆ Excellent b- and c-tagging capabilities : few μm precision for charged particle origin
 - Small pitch, thin layers, limited cooling, first layer as close as possible from IP
- **Tracker**
 - ◆ State-of-the-art momentum and angular resolution for charged particles.
 - Typically $\sigma(1/p) \sim 2 - 3 \times 10^{-5} \text{ GeV}^{-1}$ and $\sigma(\theta, \phi) \sim 0.1 \text{ mrad}$ for 45 GeV muons
 - Almost transparent to particles (as little material as possible)
 - ◆ Particle ID is a valuable additional ability
- **Calorimeters**
 - ◆ Good particle-flow capabilities and energy resolution
 - Transverse segmentation $\sim \text{cm}$: separate clusters from different particles in jets
 - Longitudinal segmentation : identify or even track electron/photon and hadron showers
 - $\sigma(E) \sim 10\% \sqrt{E}$ for e, γ and $\sim 30\% \sqrt{E}$ for pions
 - Inside solenoid coil, or alternatively, extremely thin coil
- **Instrumented return yoke OR large tracking volume outside the calorimeters**
 - ◆ Muon identification and long-lived particle reconstruction

Baseline detector design #1 : All Silicon

□ The CLIC detector is being adapted for FCC-ee

- ◆ Changeover mostly straightforward
 - Smaller beam pipe radius (15mm)
 - Inner pixel layer closer to IP
 - Not instrumented from 0 to 150 mrad
 - Smaller B field
 - Larger tracker radius (1.5 → 2.2m)
 - Smaller energies
 - Thinner HCAL (4.2m → 3.7m)
 - Continuous operation
 - Increased cooling
 - Thicker pixel/tracker layers
 - Reduced calorimeter granularity

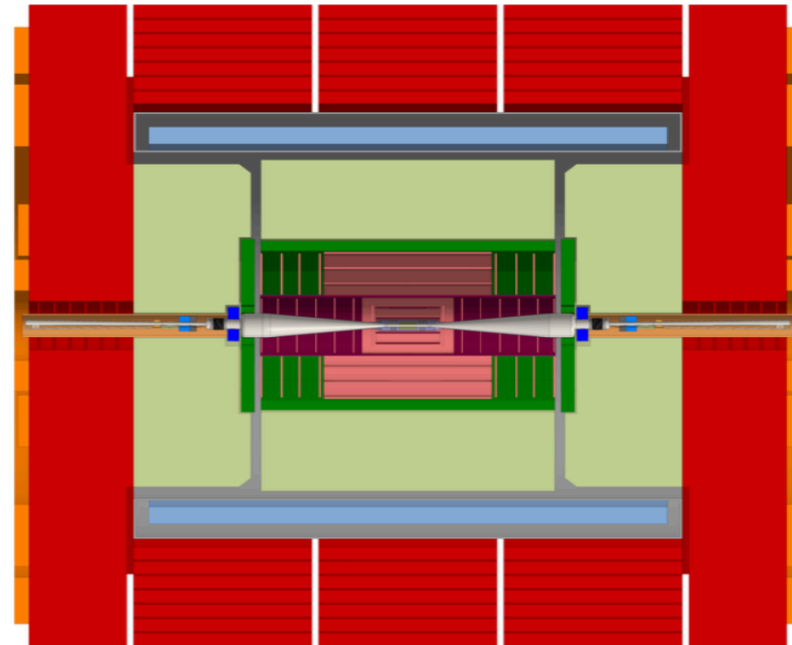

□ Performance being revisited

- ◆ e.g., Pixel detector

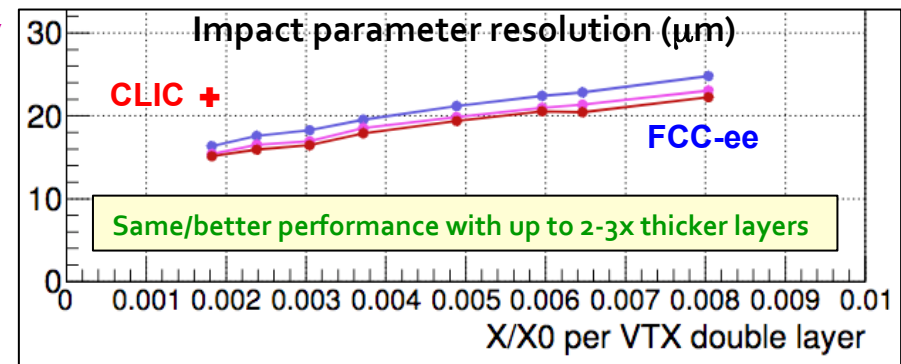
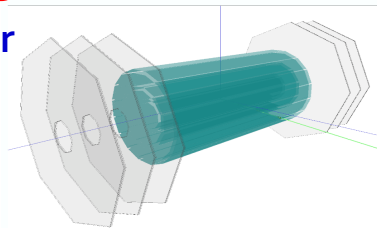

Baseline detector design #2 : IDEA

□ New IDEA, a detector specifically designed for FCC-ee

- ◆ Vertex Si detector
 - With light MAPS technology
 - 7 layers, up to 35cm radius
- ◆ Ultra light wire drift chamber
 - 4m long, 2 m radius, 0.4% X_0
 - 112 layers with Particle ID
- ◆ One Si layer for acceptance determination
 - Precise tracking with large lever arm
 - Barrel and end-caps
- ◆ Ultra-thin 20-30cm solenoid (2T)
 - Acts as preshower ($1X_0$)
 - Or $1X_0$ Pb if magnet outside calo
- ◆ Two μ -RWell layers
 - Active preshower measurement
- ◆ Dual readout fibre calorimeter
 - 2m thick, longitudinal segmentation
- ◆ Instrumented return yoke

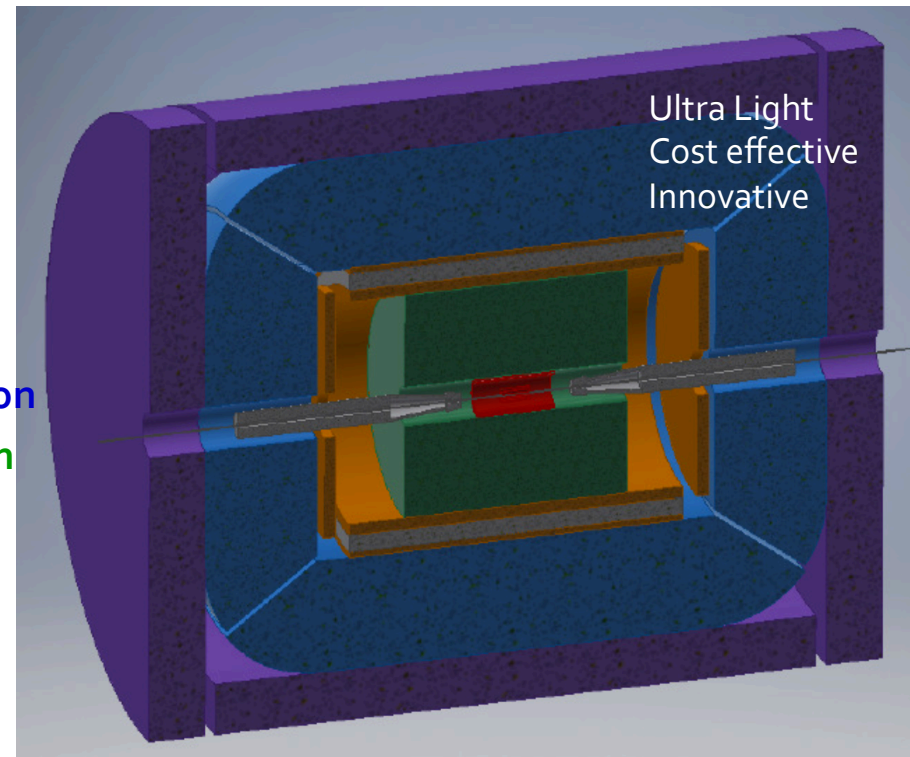

Design, R&D, test beam, performance studies have started and will be continued during the FCC-ee technical design phase. Performance tailored for FCC-ee physics.

FCC-ee physics discovery potential

e) There is a strong scientific case for an electron-positron collider, complementary to the LHC, that can study the properties of the Higgs boson and other particles with unprecedented precision and whose energy can be upgraded.

The FCC-ee discovery potential in a nutshell

- **EXPLORE the 10-100 TeV energy scale**
 - ◆ With precision measurements of the properties of the Z, W, Higgs, and top particles
 - 20-50 fold improved precision on ALL electroweak observables
 - $m_Z, \Gamma_Z, m_W, m_{\text{top}}, \sin^2 \theta_w^{\text{eff}}, R_b, \alpha_{\text{QED}}(m_Z), \alpha_s(m_Z),$ top EW couplings ...
 - 10 fold more precise and model-independent Higgs couplings measurements
- **DISCOVER that the Standard Model does not fit**
 - ◆ Then extra weakly-coupled and Higgs-coupled particles exist
 - ◆ Understand the underlying physics through effects via loops
- **DISCOVER a violation of flavour conservation**
 - ◆ Examples: $Z \rightarrow \tau\mu$ in 5×10^{12} Z decays; or $t \rightarrow cZ, cH$ at $\sqrt{s} = 240$ or 350 GeV
 - ◆ Also a lot of flavour physics in 10^{12} $b\bar{b}$ events, e.g., with $B^0 \rightarrow K^{*0} \tau^+ \tau^-$ or $B_s \rightarrow \tau^+ \tau^-$
- **DISCOVER dark matter as invisible decays of Higgs or Z**
- **DISCOVER very weakly coupled particles in the 5-100 GeV mass range**
 - ◆ Such as right-handed neutrinos, dark photons, ...
 - May help understand dark matter, universe baryon asymmetry, neutrino masses

Synergy with
FCC-hh

Today, we do not know how nature will surprise us: other things may come up with FCC-ee

Precision \Leftrightarrow Discovery !

Electroweak observables are sensitive to heavy particles in “loops”

For example, in the standard model: $\Gamma(Z \rightarrow \mu^+ \mu^-)$ or m_W

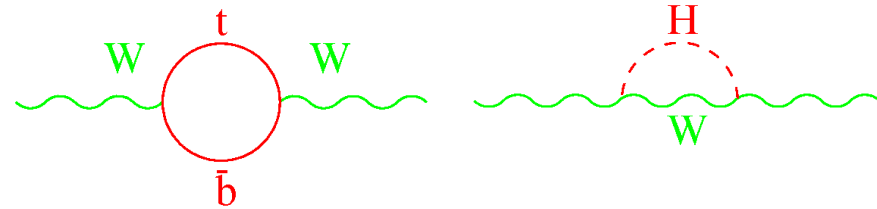
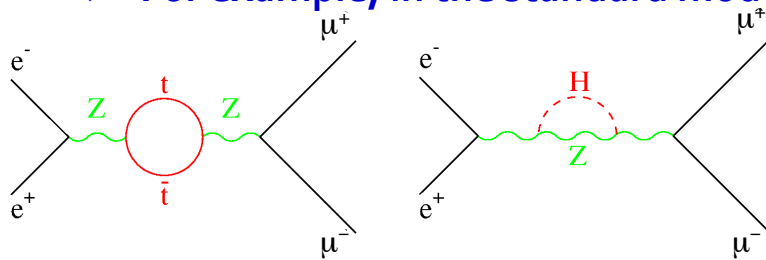

$$\Gamma_{ll} = \frac{G_F}{\sqrt{2}} \frac{m_Z^3}{24\pi} \left(1 + \left[\frac{1}{4} - \sin^2 \theta_W^{eff} \right]^2 \right) \times (1 + \Delta\rho)$$

$$m_W^2 = \frac{\pi \alpha_{QED} (m_Z^2)}{\sqrt{2} G_F \sin^2 \theta_W^{eff}} \times \frac{1}{1 - \Delta r}$$

$$\Delta\rho = \frac{\alpha}{\pi} \frac{m_t^2}{m_Z^2} - \frac{\alpha}{4\pi} \text{Log} \frac{m_H^2}{m_Z^2} + \dots \approx 1\%$$

$$\Delta r = -\frac{\cos^2 \vartheta_W}{\sin^2 \vartheta_W} \Delta\rho + \frac{\alpha}{3\pi} \left[\frac{1}{2} - \frac{1}{3} \frac{\sin^2 \vartheta_W}{1 - \tan^2 \vartheta_W} \right] \text{Log} \frac{m_H^2}{m_Z^2} + \dots \approx 1\%$$

- ◆ With precise measurements of the Z mass, Z width, and Weinberg angle [+ $\alpha_{QED}(m_Z)$]
 - LEP was able to predict m_{top} and m_W (with uncertainty for unknown m_H)
- ◆ With the discovery of the top (Tevatron) at the right mass
 - LEP was able to predict m_H
- ◆ With the discovery of the Higgs (LHC) at the right mass
 - LEP was able to improve the m_W prediction (and measured m_W as well)

Precision \Leftrightarrow Discovery ! , cont'd

- With m_{top} , m_H and m_W known, the standard model has nowhere to go

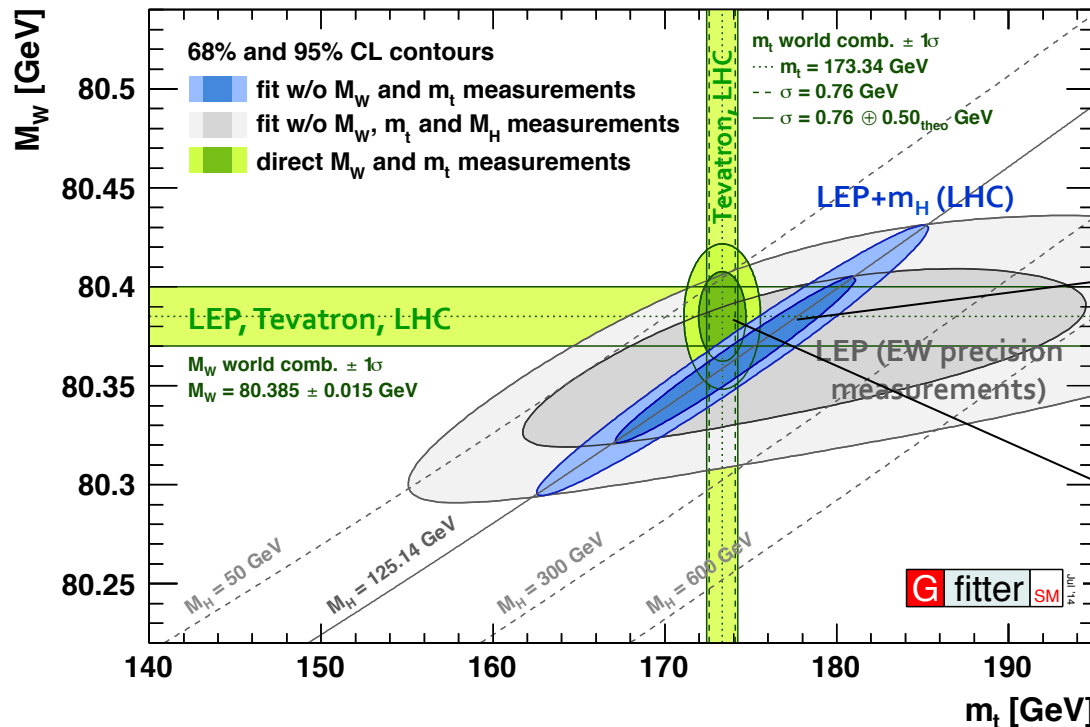

m_W prediction from LEP in the SM

$$M_W = 80.3593 \pm 0.0056_{m_t} \pm 0.0026_{M_Z} \pm 0.0018_{\alpha_{\text{QED}}} \pm 0.0017_{\alpha_S} \pm 0.0002_{M_H} \pm 0.0040_{\text{theo}}$$

$$= 80.359 \pm 0.011_{\text{tot}} \text{ GeV}$$

m_{top} and theory uncertainties dominates today

Similar precision for m_W measurement

- The FCC-ee will significantly improve precision on all fronts
 - More precise measurements become sensitive to other (heavier) particles in the loops
 - Theoretical calculations need to be brought to higher orders (more loops)
 - If one ingredient is missing, the sensitivity to new physics drops / vanishes
 - Full programme (from the Z pole to above the top threshold) well justified

Luminosity goals and operation model

□ **The FCC-ee physics goals require at least**

- ◆ 150 ab⁻¹ at and around the Z pole (\sqrt{s} ~91.2 GeV)
- ◆ 10 ab⁻¹ at the WW threshold (\sqrt{s} ~161 GeV)
- ◆ 5 ab⁻¹ at the HZ cross section maximum (\sqrt{s} ~240 GeV)
- ◆ 0.2 ab⁻¹ at the top threshold (\sqrt{s} ~350 GeV) and 1.5 ab⁻¹ above (\sqrt{s} ~365 GeV)

5×10¹² Z
 10⁸ WW
 10⁶ HZ
 10⁶ t \bar{t}

□ **Operation model (with 10% safety margin) with two IPs**

- ◆ 200 scheduled physics days per year (7 months – 13 days of MD / stops)
- ◆ Hübner factor ~ 0.75 (lower than achieved with KEKB top-up injection, ~0.8)
- ◆ Half the design luminosity in the first two years of Z operation (~LEP1)
- ◆ Machine configuration between WPs changed during Winter shutdowns (3 months/year)

Working point	Z, years 1-2	Z, later	WW	HZ	t \bar{t} threshold	365 GeV
Lumi/IP (cm ⁻² s ⁻¹)	100	200	13	7	1.6	1.3
Lumi/year (2 IP)	26 ab ⁻¹	52 ab ⁻¹	7.8 ab ⁻¹	1.8 ab ⁻¹	0.4 ab ⁻¹	0.35 ab ⁻¹
Physics goal	150		10	5	0.2	1.5
Run time (year)	2	2	1	3	0.5	4

□ **Total running time : 12-13 years (~ LEP)**

Longer shutdown: install 74 RF CMs
 LEP Record: 32 in one shutdown !

Electroweak precision measurements

- Boils down to measuring cross sections and asymmetries

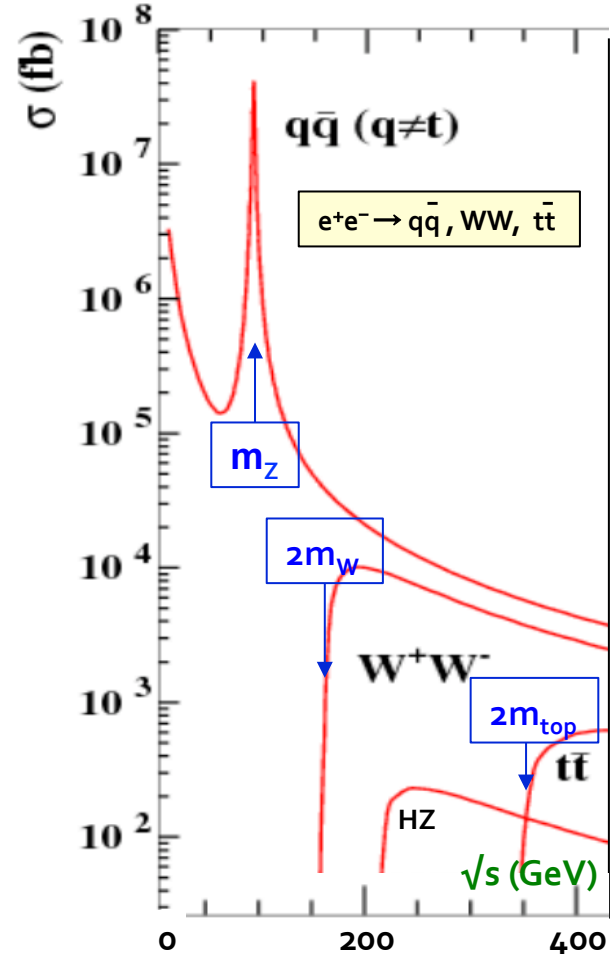

$$e^+e^- \rightarrow \mu^+\mu^-$$

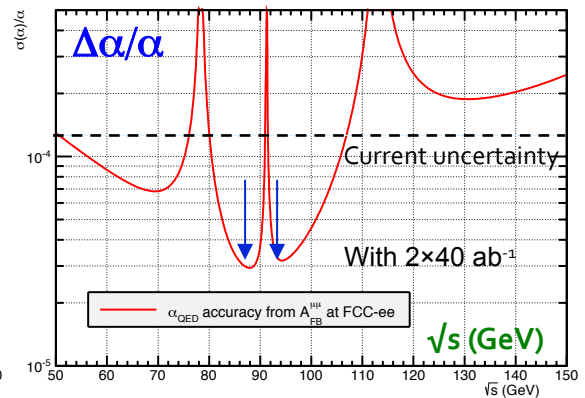
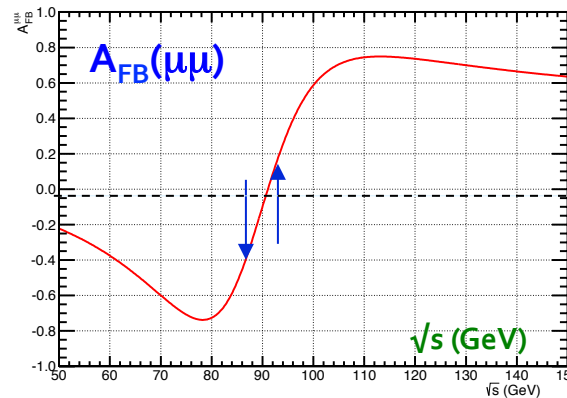
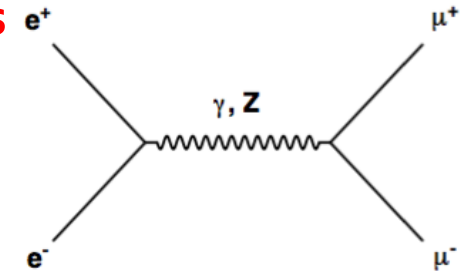

$$A_{FB}^{\mu\mu} = \frac{N_F^{\mu+} - N_B^{\mu+}}{N_F^{\mu+} + N_B^{\mu+}} \approx f(\sin^2 \vartheta_W^{eff}) + \alpha_{QED}(s) \frac{s - m_Z^2}{2s} g(\sin^2 \vartheta_W^{eff})$$

- Measure $\sin^2\theta_W$ with A_{FB} at $\sqrt{s} = m_Z$
- Measure $\alpha_{QED}(m_Z)$ with A_{FB} at $\sqrt{s} = 87.9$ and 94.3 GeV
 - Also useful for the Z resonance scan (m_Z, Γ_Z)

The dominant experimental uncertainties come from the beam energy knowledge

Beam energy calibration

□ Achieve / measure beam transverse polarization

- ◆ For a few 10's of non-colliding "monitoring" bunches – out of 16000 (Z) or 2000 (W)
 - Excellent polarization level at the Z Enough polarization at the W (~LEP at the Z)

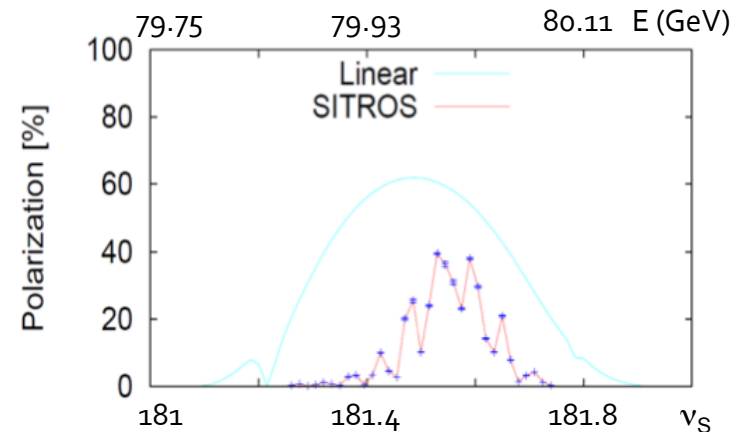
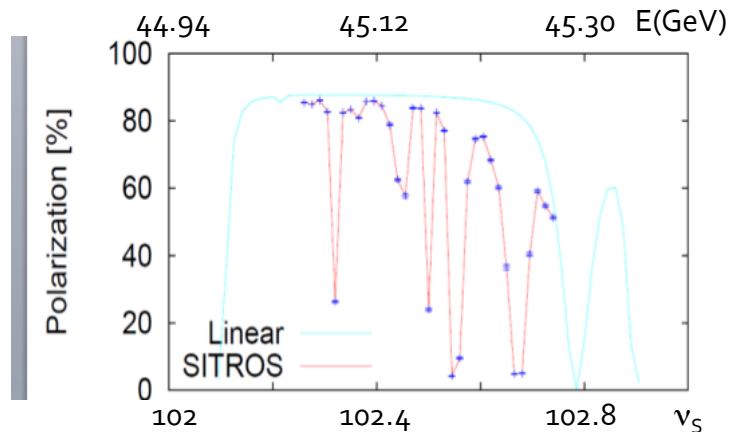

- ◆ Need wigglers to have polarization fast enough during physics run

□ "Continuous" beam energy calibration with resonant depolarization

- ◆ See backup for an explanation of "resonant depolarization"
- ◆ A unique feature of circular e^+e^- colliders!
 - Demonstrated (and used) at LEP, outside physics runs (extrapolation error 2 MeV)
 - Target precision at FCC-ee is ± 100 keV on \sqrt{s} at the Z pole and WW threshold
 - ➔ Crucial for sensitivity to new physics of the electroweak measurements

Summary of precisions achievable at FCC-ee

Observable	Measurement	Current precision	FCC-ee stat.	Possible syst.	Challenge
m_Z (MeV)	Lineshape	91187.5 ± 2.1	0.005	< 0.1	QED corr.
Γ_Z (MeV)	Lineshape	2495.2 ± 2.3	0.008	< 0.1	QED corr.
R_l	Peak	20.767 ± 0.025	0.0001	< 0.001	Statistics
R_b	Peak	0.21629 ± 0.00066	0.000003	< 0.00006	$g \rightarrow bb$
N_ν	Peak	2.984 ± 0.008	0.00004	< 0.004	Lumi meast
$\sin^2\theta_W^{\text{eff}}$	$A_{\text{FB}}^{\mu\mu}$ (peak)	0.23148 ± 0.00016	0.000003	0.000006	Beam energy
$1/\alpha_{\text{QED}}(m_Z)$	$A_{\text{FB}}^{\mu\mu}$ (off-peak)	128.952 ± 0.014	0.004	< 0.004	QED corr.
$\alpha_s(m_Z)$	R_l	0.1190 ± 0.0025	0.00001	0.0001	New Physics
m_W (MeV)	Threshold scan	80385 ± 15	0.3	< 0.5	EW Corr.
N_ν	$e^+e^- \rightarrow \gamma Z, Z \rightarrow \nu\nu, ll$	2.92 ± 0.05	0.001	< 0.001	?
$\alpha_s(m_W)$	$B_{\text{had}} = (\Gamma_{\text{had}}/\Gamma_{\text{tot}})_W$	$B_{\text{had}} = 67.41 \pm 0.27$	0.00018	< 0.0001	CKM Matrix
m_{top} (MeV)	Threshold scan	$173340 \pm 760 \pm 500$	10	20	QCD corr.
Γ_{top} (MeV)	Threshold scan	?	25	?	$\alpha_s(m_Z)$
λ_{top}	Threshold scan	$\mu = 1.2 \pm 0.4$	15%	?	$\alpha_s(m_Z)$

Global Fit and sensitivity to new physics

- **Combining all EW measurements**
 - ◆ **In the context of the SM ... and beyond**

$$\mathcal{L}_{\text{SMEFT}} = \mathcal{L}_{\text{SM}} + \sum_i \frac{c_i}{\Lambda^2} \mathcal{O}_i$$

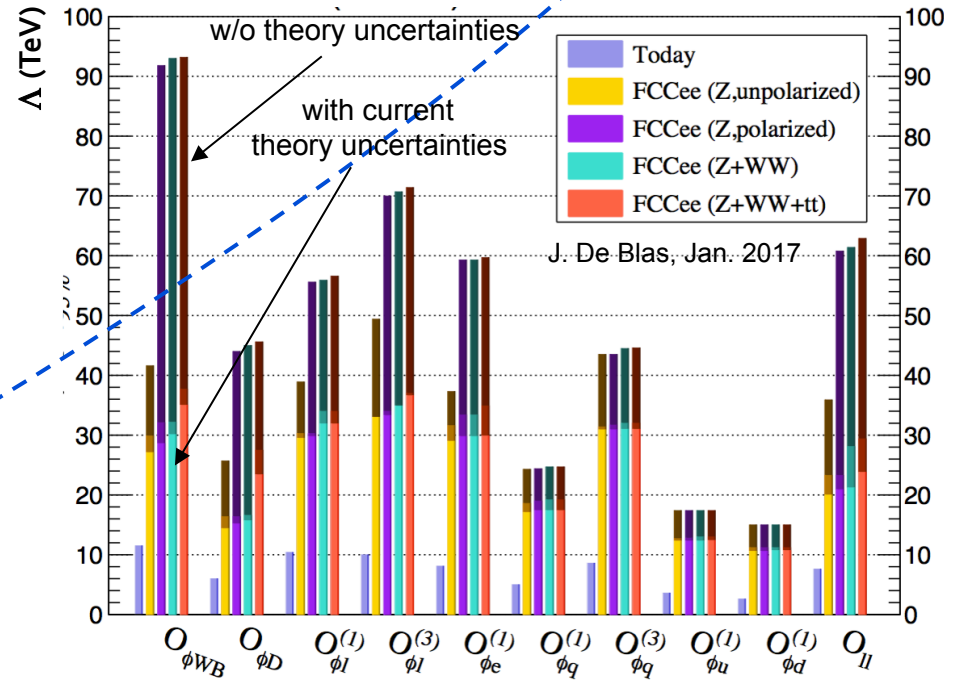
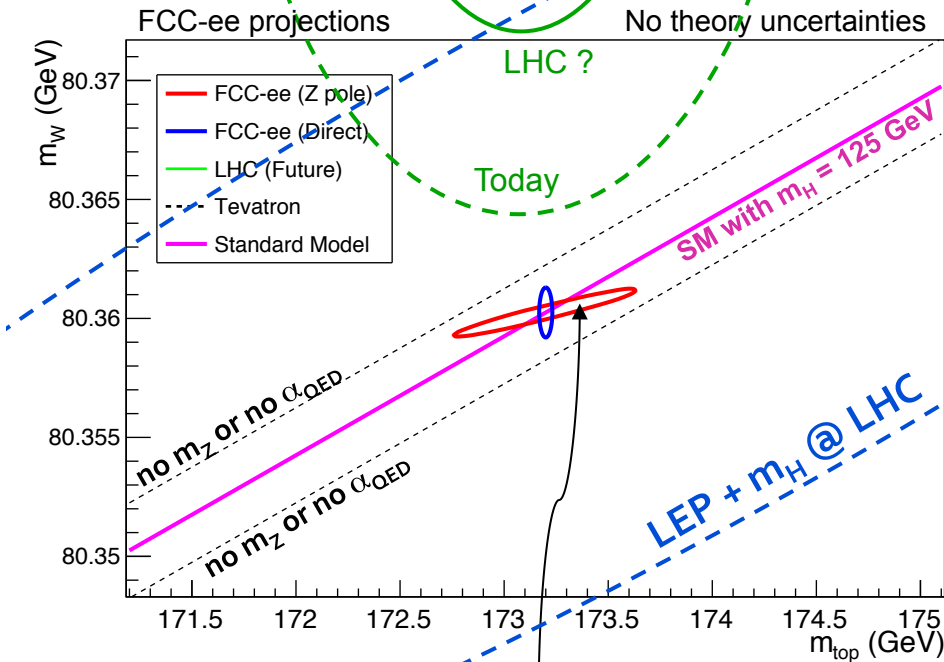

Requires 10-fold improved theory calculations

Points to the physics to be looked for at FCC-hh

- ◆ **New physics: blue and red ellipses may not overlap**
 - **Or even better, data may not fit to the SM**

Today: $\Lambda > 5-10$ TeV

After FCC-ee: $\Lambda > 50-100$ TeV ?

The FCC-ee as a Higgs factory : $\sqrt{s} = 240 \text{ GeV}$

□ Model-independent precision measurements

- ◆ A Higgs boson is tagged by a Z and the recoil mass

$$m_H^2 = s + m_Z^2 - 2\sqrt{s}(E_+ + E_-)$$

- Measure $\sigma(e^+e^- \rightarrow HZ)$
- Deduce g_{HZZ} coupling
- Infer $\Gamma(H \rightarrow ZZ)$
- Select events with $H \rightarrow ZZ^*$
- Measure $\sigma(e^+e^- \rightarrow HZ, \text{ with } H \rightarrow ZZ^*)$

$$\sigma(e^+e^- \rightarrow HZ \rightarrow ZZZ) = \sigma(e^+e^- \rightarrow HZ) \times \frac{\Gamma(H \rightarrow ZZ)}{\Gamma_H}$$

- Deduce the total Higgs boson width Γ_H
 - Select events with $H \rightarrow bb, cc, gg, WW, \tau\tau, \gamma\gamma, \mu\mu, Z\gamma, \dots$
 - Deduce $g_{Hbb}, g_{Hcc}, g_{Hgg}, g_{HWW}, g_{H\tau\tau}, g_{H\gamma\gamma}, g_{H\mu\mu}, g_{HZ\gamma}, \dots$
 - Select events with $H \rightarrow \text{"nothing"}$
 - Deduce $\Gamma(H \rightarrow \text{invisible})$
- ◆ With 10^6 HZ events, expect precisions ranging from 0.1% to 1%

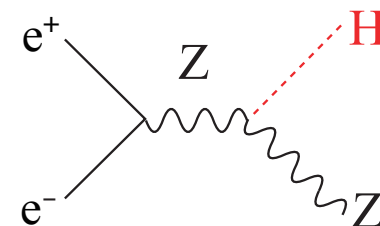
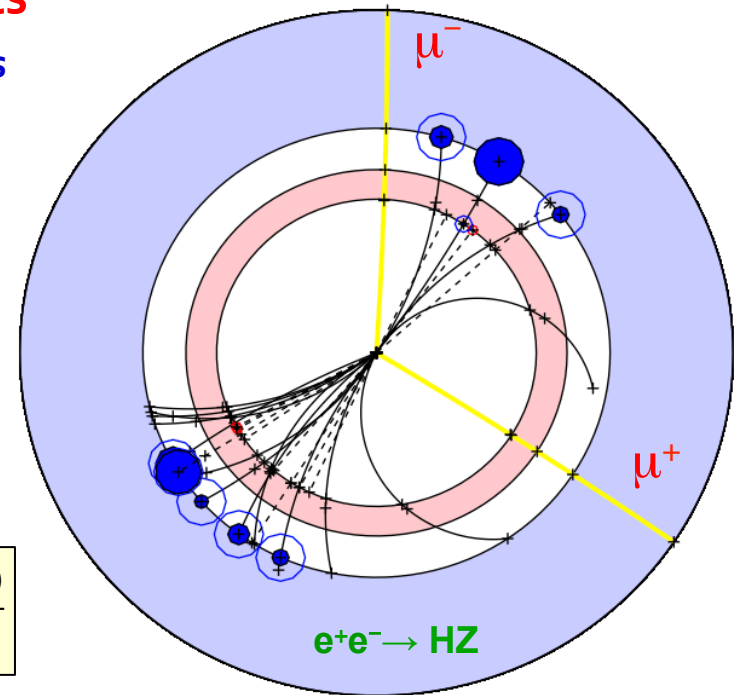

Expected precisions and synergies

- FCC-ee precisions one order of magnitude better than HL-LHC

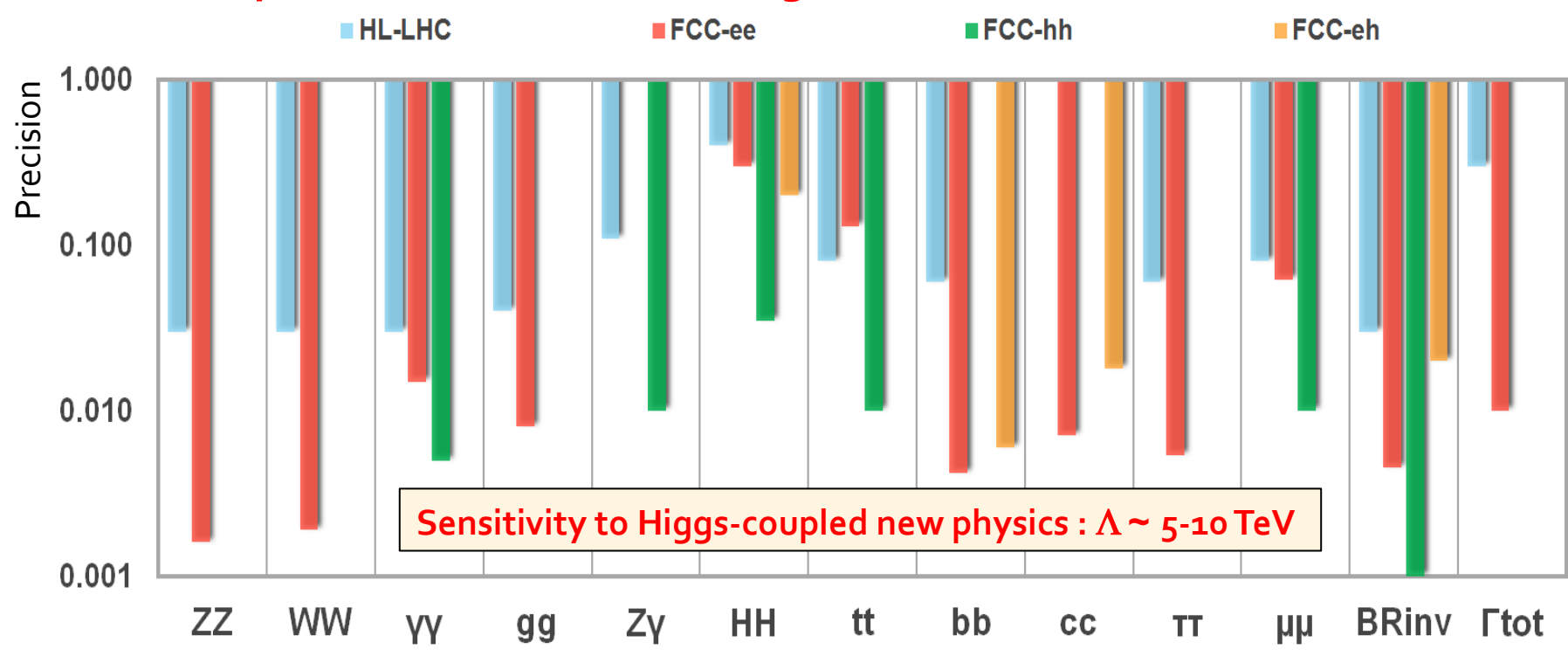

- ◆ FCC-ee precisions are model-independent
- ◆ FCC-eH precisions assume standard model for g_{HZZ} , g_{HWW} , and Γ_H (!)
- ◆ FCC-hh precisions enjoy g_{HZZ} , g_{HWW} and Γ_H as measured by FCC-ee
 - For g_{Htt} , FCC-hh also benefits from the g_{Ztt} measurement from FCC-ee

New-physics model building / testing

- **Pattern of deviations will point to specific new physics**
 - ◆ Example: correlated effect on g_{HZZ} and g_{Hbb} from 4D-Composite Higgs models

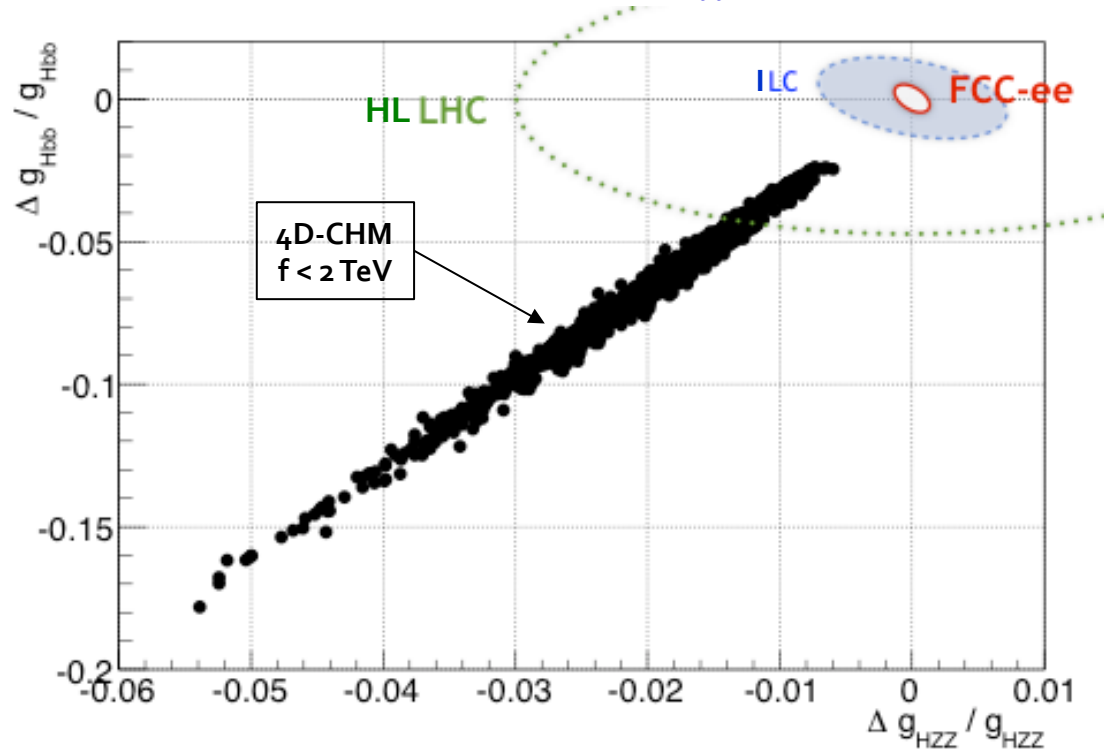

- All other couplings affected in a similar manner
- ◆ FCC-ee sensitivity : $f > 4\text{-}5$ TeV, just from Higgs measurements
 - Expect deviations from other sectors as well (next slides)

New-physics model building / testing, cont'd

4D-Higgs composite models also affect EW couplings

- ◆ Presence of heavy Z' and modified Z_{tt} / Z_{ee} couplings
 - Modify angular and energy distributions of t decay products (l, b)
 - Best precision on Z_{tt} / γ_{tt} couplings at $\sqrt{s} = 365$ GeV (!)

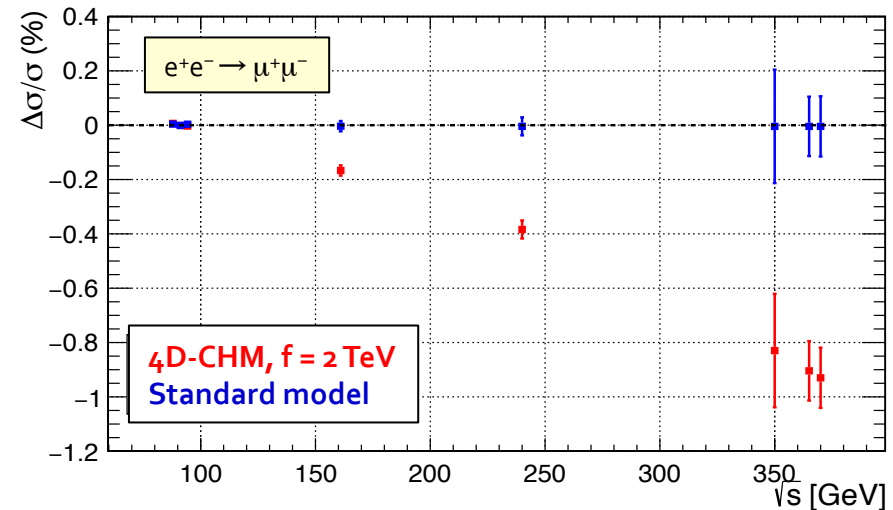
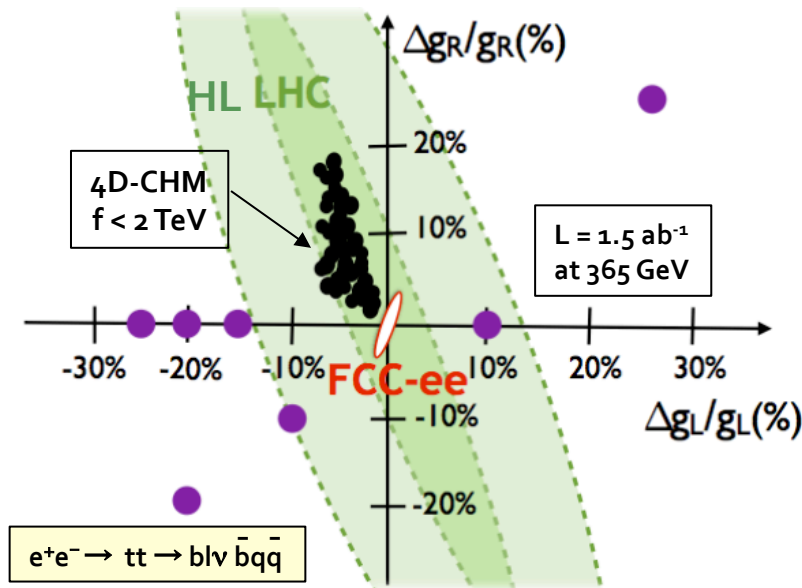
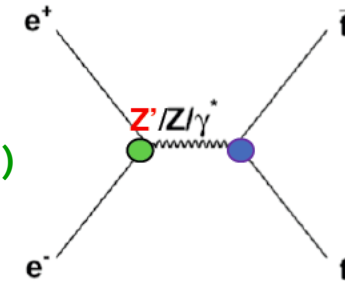

- Also modify cross sections and asymmetries for $e^+e^- \rightarrow \mu^+\mu^-$ at all \sqrt{s}
- ◆ Data do not fit the standard model (by many standard deviations)
 - FCC-ee precision allows the model to be fully characterized up to $f \sim 5$ TeV
 - ➔ (Work in progress)

Flavour physics

Current tensions (several 2-3 σ deviations) of LHCb data with SM predictions

- ◆ In particular, lepton flavour universality is challenged in $b \rightarrow s \ell^+ \ell^-$ transitions
 - For example, the rates of $B^0 (B^+) \rightarrow K^{*0} (K^+) \ell^+ \ell^-$ are different for $\ell = e$ and $\ell = \mu$
 - Differences are also observed in the lepton angular distributions
- ◆ This effect, if real, could be enhanced for $\ell = \tau$, in $B \rightarrow K^{(*)} \tau^+ \tau^-$
 - Extremely challenging in hadron colliders
 - With $10^{12} Z \rightarrow b\bar{b}$, FCC-ee is beyond any foreseeable competition

- ➔ Decay can be fully reconstructed
- ➔ Full angular analysis possible

Also sensitive to new physics: $B_S \rightarrow \mu^+ \mu^-$

- ◆ None found yet at the LHC (~50 events)

$$BR(B_S^0 \rightarrow \mu^+ \mu^-) = (3.0 \pm 0.6^{+0.3}_{-0.2}) \times 10^{-9} \sim \text{SM}$$

- Expect a few 1000's by the end of LHC
- ◆ $B_S \rightarrow \tau^+ \tau^-$ is 250 times more abundant
 - But almost hopeless at the LHC
- ◆ Again, FCC-ee is beyond any foreseeable competition
 - Several 100,000 events expected – reconstruction efficiency under study

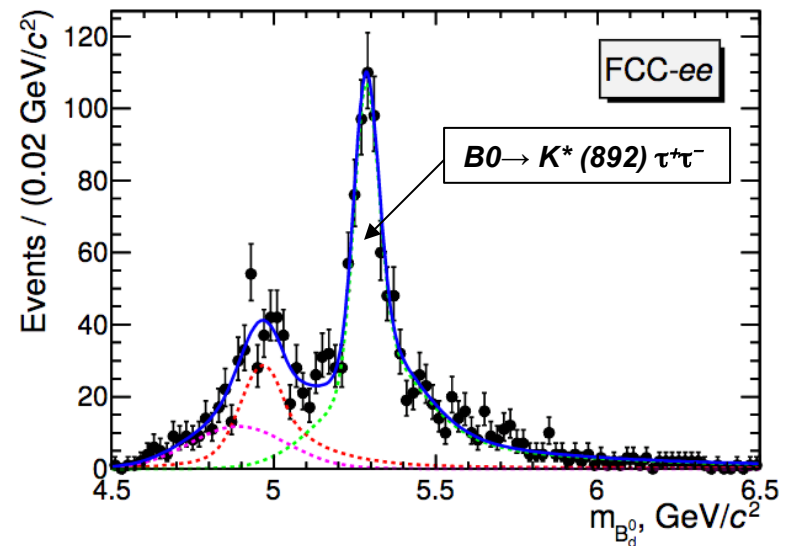

Discovery of very-weakly-coupled particles

□ **“With the Higgs discovery, the standard model is complete”**

◆ **Not quite true : three right-handed neutrinos are missing**

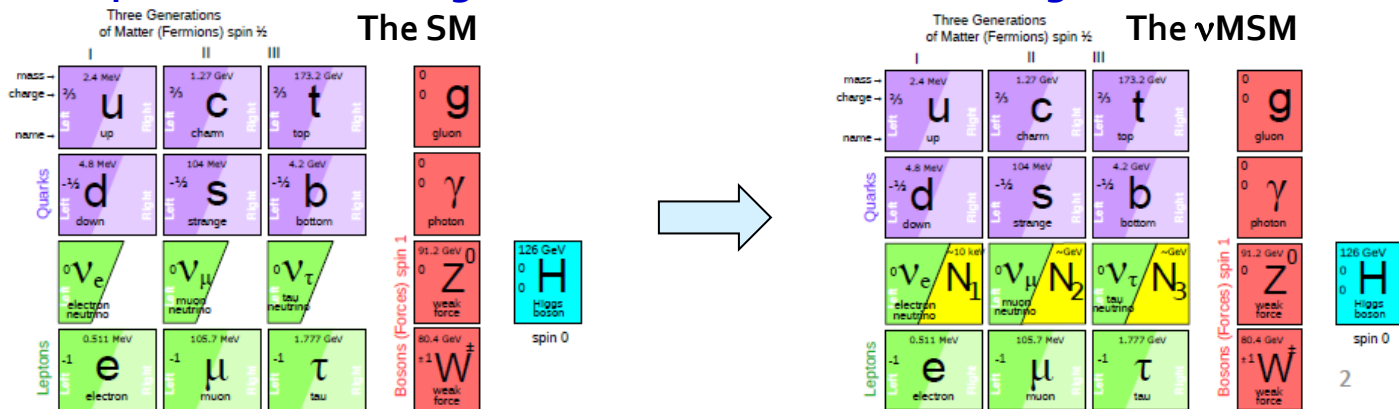

● **Could explain everything: Dark matter, Baryon asymmetry, Neutrino masses**

◆ **Searched for in very rare $Z \rightarrow \nu N_{2,3}$ decays**

● **Followed by $N_{2,3} \rightarrow W^* \ell$ or $Z^* \nu$**

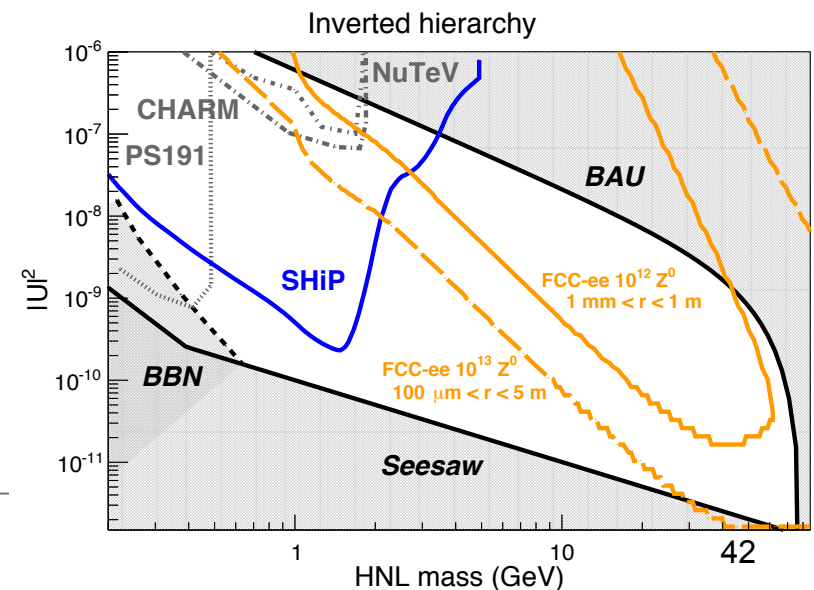
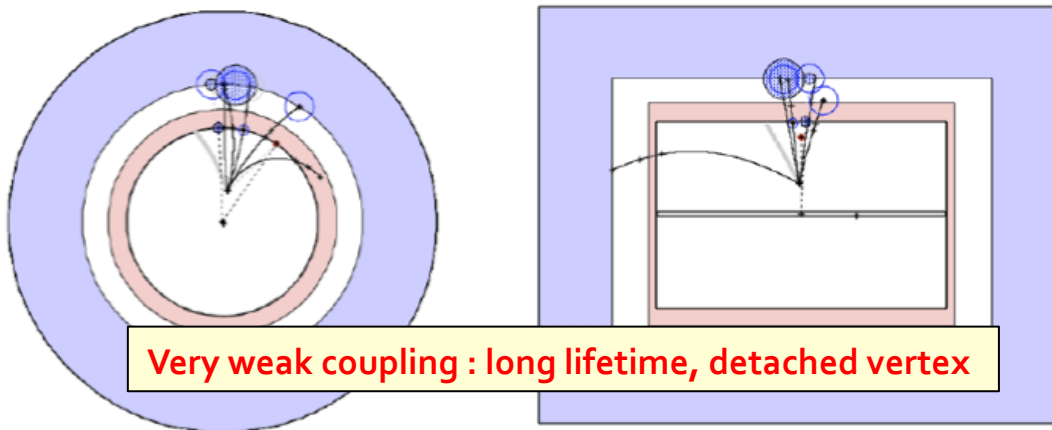

The FCC-ee discovery potential in a nutshell

- **EXPLORE the 10-100 TeV energy scale**
 - ◆ With precision measurements of the properties of the Z, W, Higgs, and top particles
 - 20-50 fold improved precision on ALL electroweak observables
 - ▶ 100 keV for m_Z , 500 keV for m_W , 20 MeV for m_{top} , 3×10^{-5} for $\alpha_{QED}(m_Z)$, 6×10^{-6} for $\sin^2\theta_w^{eff}$
 - 10 fold more precise and model-independent Higgs couplings measurements
- **DISCOVER that the Standard Model does not fit**
 - ◆ Then extra weakly-coupled and Higgs-coupled particles exist
 - ◆ Understand the underlying physics through effects via loops
- **DISCOVER a violation of flavour conservation**
 - ◆ Examples: $Z \rightarrow \tau\mu$ in 5×10^{12} Z decays; or $t \rightarrow cZ, cH$ at $\sqrt{s} = 240$ or 350 GeV
 - ◆ Also a lot of flavour physics in 10^{12} $b\bar{b}$ events, e.g., with $B^0 \rightarrow K^{*0}\tau^+\tau^-$ or $B_s \rightarrow \tau^+\tau^-$
- **DISCOVER dark matter as invisible decays of Higgs or Z**
- **DISCOVER very weakly coupled particles in the 5-100 GeV mass range**
 - ◆ Such as right-handed neutrinos, dark photons, ...
 - May help understand dark matter, universe baryon asymmetry, neutrino masses

Synergy with
FCC-hh

Today, we do not know how nature will surprise us: other things may come up with FCC-ee

**Strategic vision for the future
(Personal concluding remarks)**

What have we learnt since ESU 2013 ?

□ LHC

- ◆ The Run2 at $\sqrt{s}=13$ TeV is proceeding extremely well – already 100 fb^{-1} since 2010
- ◆ The experiments perform equally well, see e.g., EPS-HEP2017 in Venice
- ◆ No convincing hints of strong deviations from standard model just as yet
 - Air is getting thinner and thinner for new physics in the TeV region
- ◆ HL-LHC has become a project: may occupy CERN until 2039, if nothing else come up

□ Policy / Politics

- ◆ Support to HL-LHC from Europe, US, Japan
- ◆ The FCC design study took place, with financial support
 - All configurations studied (ee, hh, eh) with schedule and funding profile by 2018
- ◆ The ILC baseline is now limited to $\sqrt{s} = 250$ GeV instead of 500 GeV (cost and physics)
- ◆ The CLIC first stage is now reduced to $\sqrt{s} = 380$ GeV instead of 500 GeV (physics)
- ◆ China has come up with a conceptual design study of a circular machine
 - Largely “inspired” from FCC
 - ➔ Current focus on a 90-250 GeV e^+e^- machine, followed by a 70 TeV pp collider
- ◆ CERN’s new alternative: HE-LHC@28 TeV, with FCC-hh magnets in the LHC tunnel
 - Note: a high-lumi 90-250 GeV e^+e^- machine (LEP3) could use the same tunnel
 - ➔ Proposed in 2011, cost effective, but not advertized (“would undercut the FCC-ee”)

What will we know by ESU 2019 ?

- **If new physics is found by the end of LHC Run2**
 - ◆ It will – hopefully – point to the best new accelerator to build
 - Will in turn make it easier to get financial/political/societal support
 - ◆ This hypothesis is, unfortunately, getting less and less likely
- **Much greater challenge if no new physics is convincingly found**
 - ◆ Cannot continue indefinitely with R&D towards all possible future facilities
 - A choice will have to be made in 2019-2020
- **Physics absolutely need an e^+e^- EW factory with $90 < \sqrt{s} < 400$ GeV**
 - ◆ Four e^+e^- collider studies on the planet (ILC, CLIC, CEPC, FCC) in the energy range !
 - Today's lecture hinted at what could be the best choice
 - FCC covers the whole range (unlike ILC, CLIC, CEPC): Z, W, H, and top.
with the highest luminosities (20×ILC at 250 GeV, 10^5 ×LEP at 90 GeV)
with unique discovery potential to very high scale and very small couplings
is technologically ready today – future R&D can only improve the case
seems to be (close to) affordable within CERN constant budget
 - ◆ Much harder to make a convincing physics case for e^+e^- colliders with $\sqrt{s} > 400$ GeV
 - Exploration of the energy frontier best done with a hadron collider (e.g., FCC-hh)

(Even more personal) remarks : HE-LHC vs FCC-ee

□ HE-LHC : the best first step for FCC-hh ?

◆ Similar remark for HE-LHC wrt FCC to that made for LEP₃ wrt FCC-ee

● The HE-LHC does strategically undercut the long-term plan to reach 100 TeV

1. The HE-LHC in direct competition with FCC-ee (in budget, in time)
2. The HE-LHC leaves a gap in physics at CERN for at least 6-7 years
3. The choice of HE-LHC leaves CERN vulnerable to the possibility that a lepton collider is built elsewhere with worse performance, but still sufficient to render the case for FCC-ee more difficult to make
4. The HE-LHC, similarly, also weakens the case for FCC-hh in two ways: it reduces the increment in centre-of-mass energy, and no more FCC-ee (see below)
5. The HE-LHC keeps physicists doing physics with the same techniques for many many years (especially after 30 years of LHC and HL-LHC, and before 30 years of FCC-hh): it may not be a very healthy plan to maintain CERN attractiveness ?

□ FCC-ee : the best first step for FCC-hh ?

◆ It is complementary and synergetic on many fronts [also turns 2., 3., 4., 5. into advantages]

1. It gives a preview of the new physics to be searched for, up to a scale of 100 TeV
2. It significantly reduces systematic uncertainties on many FCC-hh measurements
3. It provides handles to understand the underlying theory upon particle discovery at the FCC-hh
4. It provides the infrastructure (tunnel, experimental shafts, cryogenics, ...) at reasonable cost
5. It buys time to develop 16T (or – why not? – 20T) magnets for FCC-hh at lower cost
6. It can even be a springboard for a FCC- $\mu\mu$ (circular $\mu^+\mu^-$ collider with $\sqrt{s} = 6, 28, \text{ or } 100 \text{ TeV?}$)

A successful model !

Back to the future ...

PHYSICS WITH VERY HIGH ENERGY

e^+e^- COLLIDING BEAMS

L. Camilleri, D. Cundy, P. Darriulat, J. Ellis, J. Field,
H. Fischer, E. Gabathuler, M.K. Gaillard, H. Hoffmann,
K. Johnsen, E. Keil, F. Palmonari, G. Preparata, B. Richter,
C. Rubbia, J. Steinberger, B. Wiik, W. Willis and K. Winter

ABSTRACT

This report consists of a collection of documents produced by a Study Group on Large Electron-Positron Storage Rings (LEP). The reactions of

- ◆ Did these people know that we would be running HL-LHC in the same tunnel more than 60 years later ?

CERN 76-18
8 November 1976

e^+e^- 1989-2000

pp 2010-2039

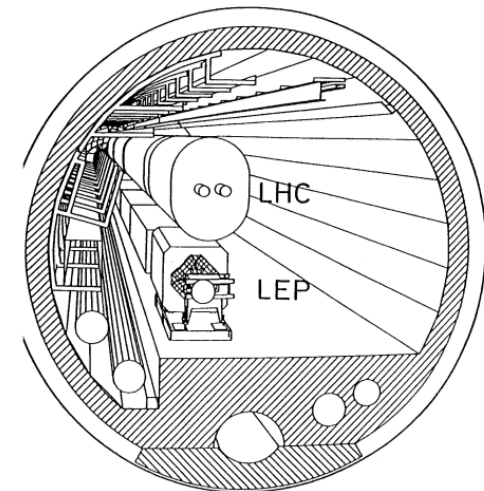

LARGE HADRON COLLIDER
IN THE LEP TUNNEL

Let's not be shy !

The FCCs are shaping up as the most natural, complete, and powerful aspiration of HEP for its long-term future

Backup slides

LEP civil engineering

Planned schedule

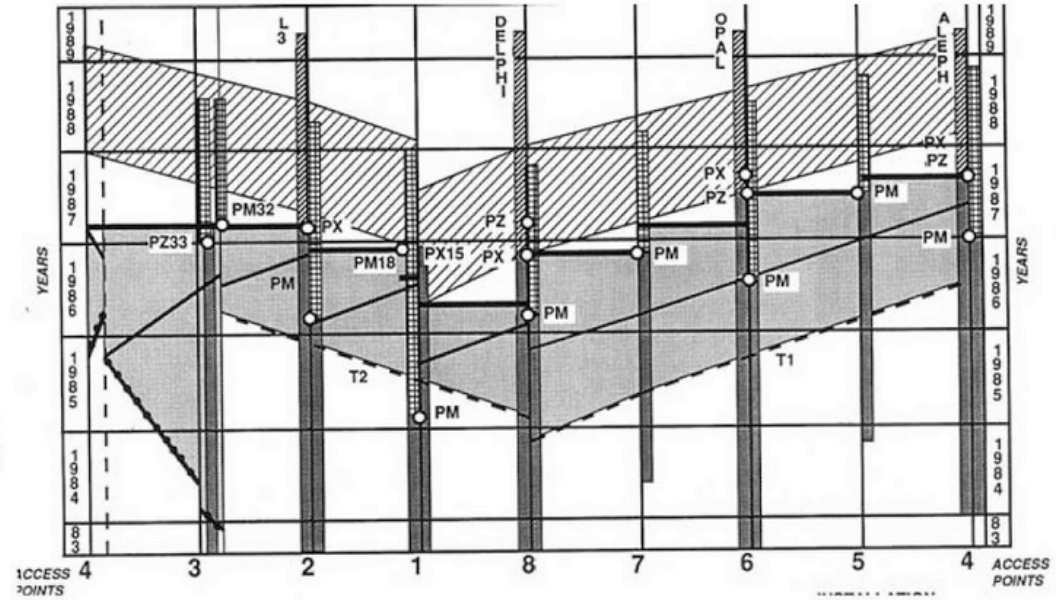

Actual progress

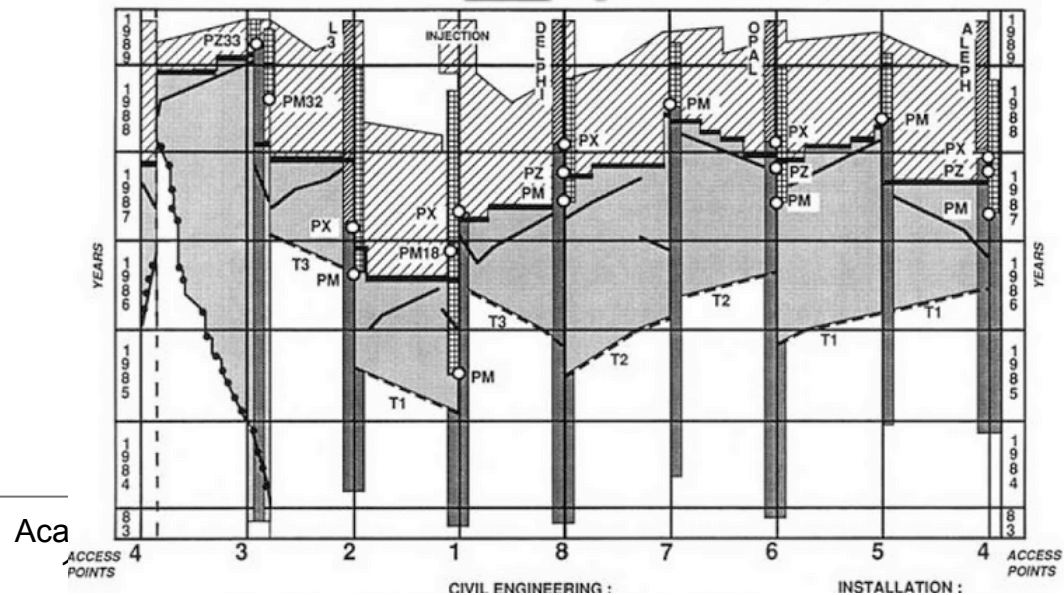

HL-LHC schedule (April 2017)

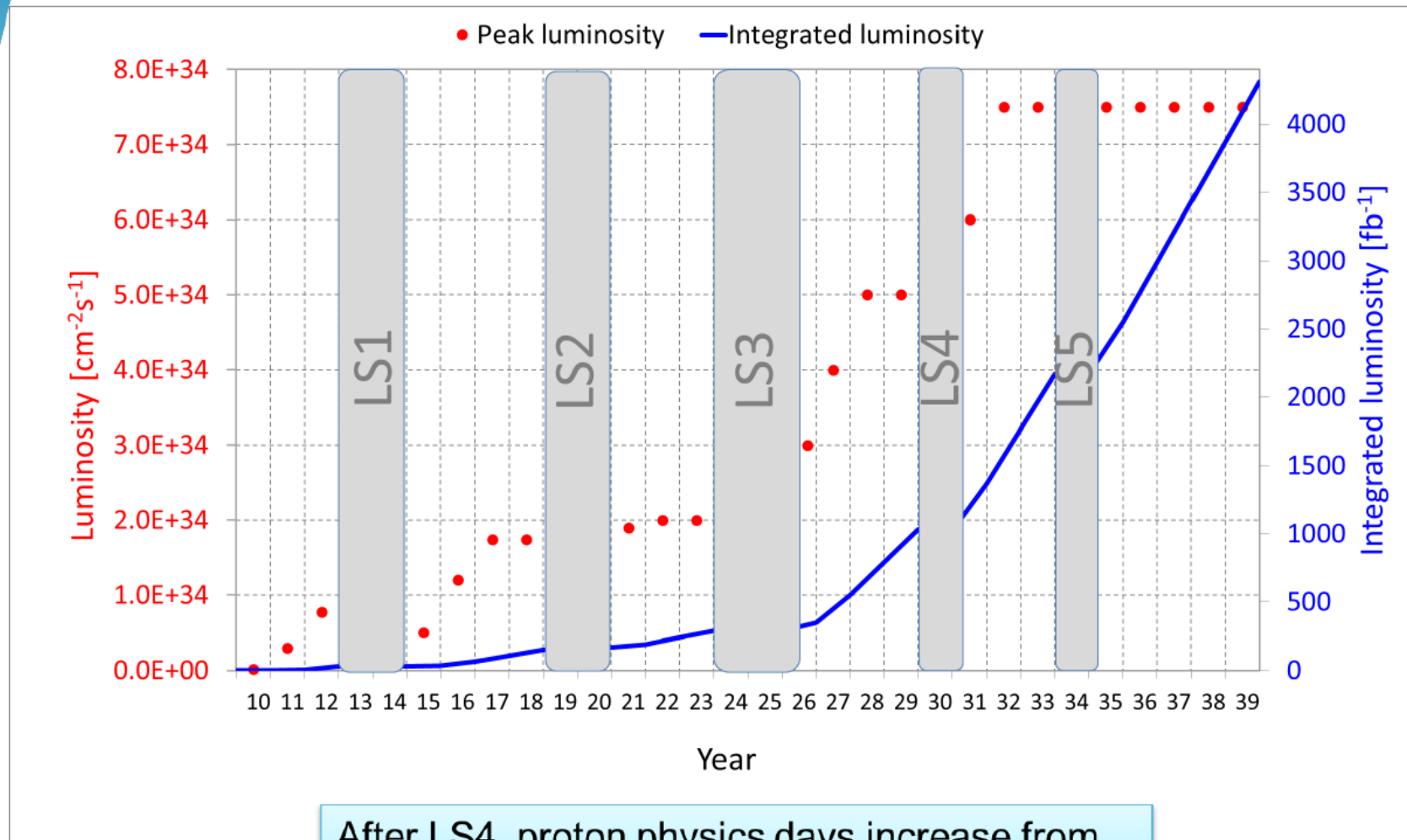

After LS4, proton physics days increase from standard 160 days to 200 and after LS5 to 220

Energy calibration with resonant depolarization

- **Reminder: Measurement of the beam energy at LEP**
 - ◆ Ultra-precise measurement unique to circular colliders

Electron with momentum \mathbf{p} in a uniform vertical magnetic field \mathbf{B} :

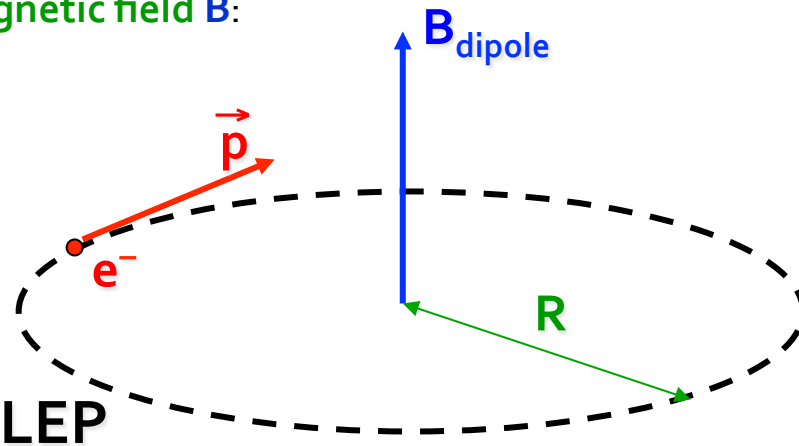

$$L = 2\pi R = 27\text{km}$$

$$\mathbf{E} \sim \mathbf{p} = e \mathbf{B} R = (e/2\pi) \mathbf{B} L$$

In real life, \mathbf{B} non uniform, ring not circular

$$E = \frac{e}{2\pi} \oint_{\text{LEP}} B dl$$

To be measured

The electrons get transversally polarized (i.e., their spin tends to align with \mathbf{B})

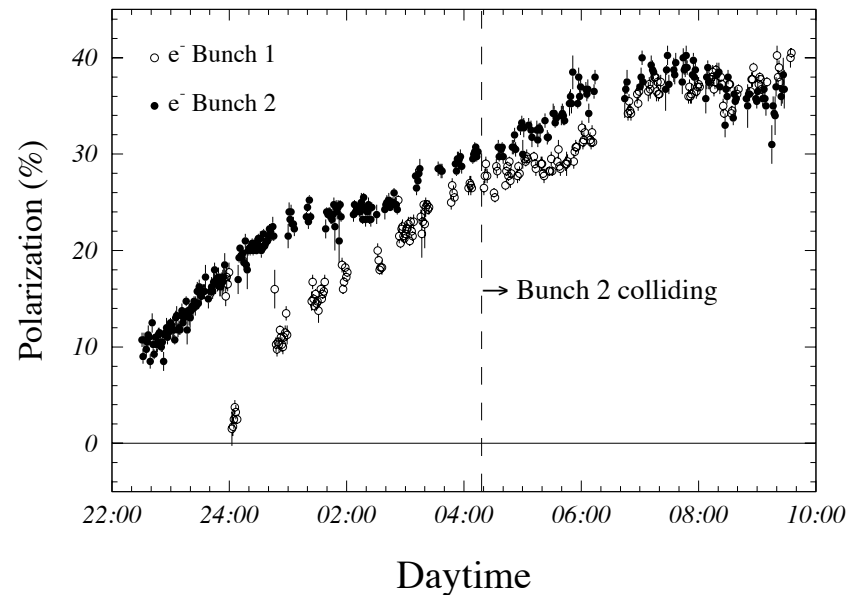

Slow process (especially at FCC-ee)

- ◆ $P = 10\%$ in 2.9h at 45 GeV (Z pole)
- ◆ $P = 10\%$ in 1.6h at 80 GeV (WW threshold)

Energy calibration with resonant depolarization

- The spin precesses around **B** with a frequency proportional to **B** (Larmor precession)
 - ◆ Hence, the number of revolutions ν_s for each LEP turn is proportional to **BL** (or $\int B dl$)

$$\nu_s = \frac{g_e - 2}{2m_e} \times E_{\text{beam}}$$

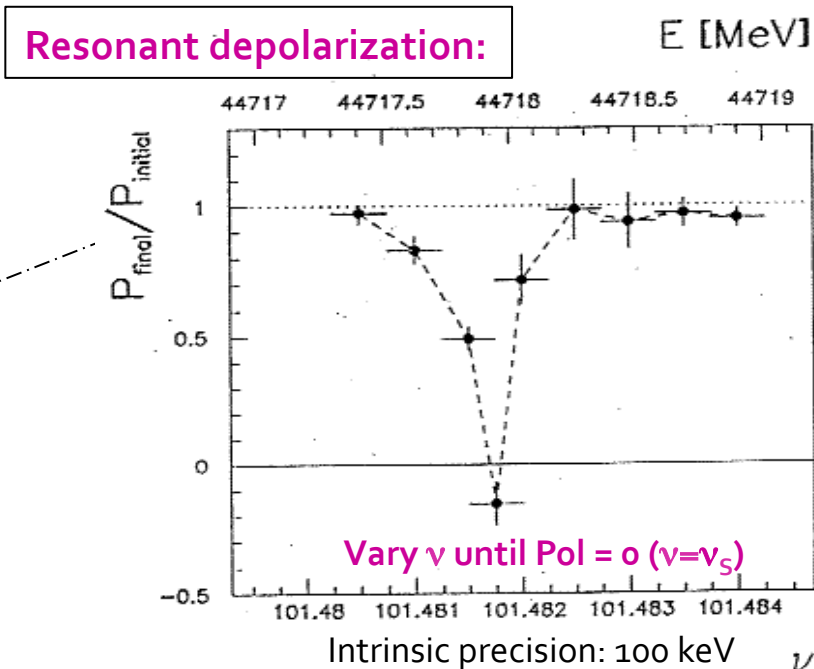
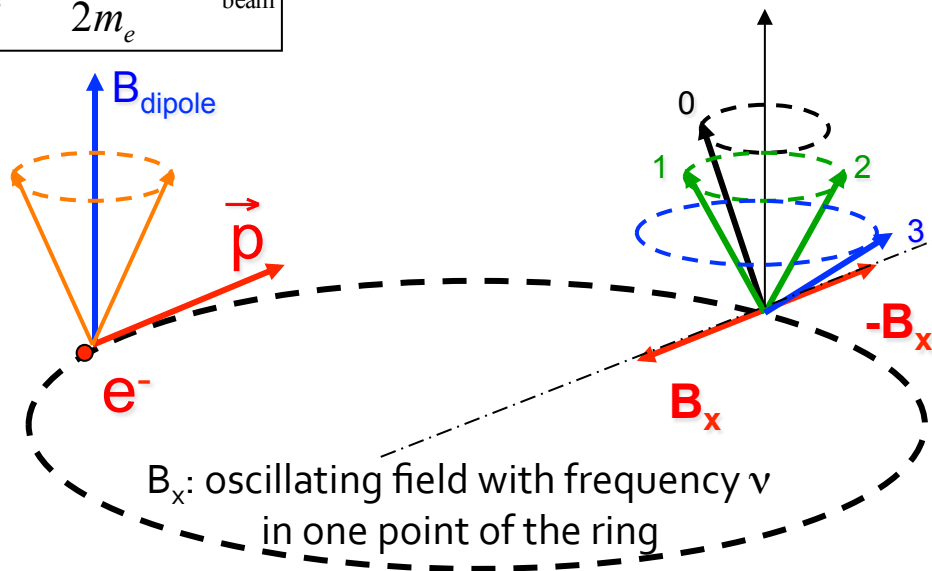

- ◆ LEP was colliding 4 bunches of e^+ and e^-
 - Specific calibration runs were needed: extrapolation error ~ 2.2 MeV
- ◆ FCC-ee will have 10,000's of bunches.
 - Use ~ 100 "single" bunches to measure E_{BEAM} with resonant depolarization
 - Each measurement gives 100 keV precision, with no extrapolation uncertainty

Theoretical limitations

□ SM predictions (using other inputs)

◆ After LEP

$$M_W = 80.3593 \pm 0.0056_{m_t} \pm 0.0026_{M_Z} \pm 0.0018_{\Delta\alpha_{\text{had}}} \\ \pm 0.0017_{\alpha_S} \pm 0.0002_{M_H} \pm 0.0040_{\text{theo}}$$

$$\sin^2\theta_{\text{eff}}^{\ell} = 0.231496 \pm 0.000030_{m_t} \pm 0.000015_{M_Z} \pm 0.000035_{\Delta\alpha_{\text{had}}} \\ \pm 0.000010_{\alpha_S} \pm 0.000002_{M_H} \pm 0.000047_{\text{theo}}$$

◆ Requires additional measurements

- Dominant uncertainties explain why we want high Z statistics, and ttbar running

Theoretical limitations

□ SM predictions (using other inputs)

◆ After FCC-ee

$$M_W = 80.3593 \pm \underbrace{0.0002}_{m_t} \pm 0.0001 I_Z \pm 0.0004 \Delta\alpha_{\text{had}} \\ \pm 0.0005 \pm 0.0001 \alpha_S \pm 0.0000 M_H \pm \underbrace{0.0040}_{\text{theo}}$$

$$\sin^2\theta_{\text{eff}}^l = 0.231496 \pm 0.0000015 \underbrace{m_t}_{\pm 0.000001} \pm 0.000001 M_Z \pm \underbrace{0.000006}_{\Delta\alpha_{\text{had}}} \\ \pm 0.000006 \pm 0.0000014 \alpha_S \pm 0.000000 M_H \pm \underbrace{0.000047}_{\text{theo}}$$

◆ Requires additional measurements

- Dominant uncertainties explain why we want high Z statistics, and ttbar running

◆ Experimental errors will be 20-50 times smaller than present errors

- BUT also 10-30 times smaller than present level of theory uncertainties !

□ Will require significant theoretical effort for a 10-fold improvement

◆ Need for multi-loop (3 or more) calculations in the future

- Suggest including manpower for theory calculations in the project cost

Theoretical limitations: work has started

Theoretical uncertainties for electroweak and Higgs-boson precision measurements at the FCC-ee

Conveners: A. Freitas¹, S. Heinemeyer²,
Contributors: M. Beneke³, A. Blondel⁴, A. Hoang⁵, P. Janot⁶, J. Reuter⁷,
C. Schwinn⁸, and S. Weinzierl⁹

Intrinsic uncertainties: \Rightarrow always a limiting factor!

Quantity	FCC-ee	Current intrinsic unc.	Projected unc.
M_W [MeV]	1	4 ($\alpha^3, \alpha^2\alpha_s$)	1
$\sin^2 \theta_{\text{eff}}^l$ [10^{-5}]	0.6	4.5 ($\alpha^3, \alpha^2\alpha_s$)	1.5
Γ_Z [MeV]	0.1	0.5 ($\alpha_{\text{bos}}^2, \alpha^3, \alpha^2\alpha_s, \alpha\alpha_s^2$)	0.2
R_b [10^{-5}]	6	15 ($\alpha_{\text{bos}}^2, \alpha^3, \alpha^2\alpha_s$)	7
R_l [10^{-3}]	1	5 ($\alpha_{\text{bos}}^2, \alpha^3, \alpha^2\alpha_s$)	1.5

Look into the future. Bookkeeping with three loops

$Z \rightarrow b\bar{b}$			
Number of topologies	1 loop	2 loops	3 loops
		1	14 \rightarrow^A 7 \rightarrow^B 5
Number of diagrams	15	2383 $\rightarrow^{A,B}$ 1114	490387 $\rightarrow^{A,B}$ 120187
Fermionic loops	0	371	116091
Bosonic loops	15	2012	374296
Planar	1T/15D	13T/2250D	186T/426753D
Non-planar	0	1T/133D	25T/63634D

$Z \rightarrow e^+e^-, \dots$			
Number of topologies	1 loop	2 loops	3 loops
		1	14 \rightarrow^A 7 \rightarrow^B 5
Number of diagrams	14	2012 $\rightarrow^{A,B}$ 880	397690 $\rightarrow^{A,B}$ 91271
Fermionic loops	0	301	92397
Bosonic loops	14	1711	305293
Planar	1	13	186
Non-planar	0	1	25

Genuine virtual loops (alTALC, qgraf, FeynArts).

(A) - no tadpoles, no product of lower loops, (B) - symmetry included 19 / 46

Mini workshop: Precision EW and QCD calculations for the FCC studies: methods and techniques

12-13 January 2018

<https://indico.cern.ch/event/669224/>

MB: ϵ^0 [8-dim], $1/\epsilon$ [7-dim]; SD: ϵ^0 [8-dim], $1/\epsilon$ [7-dim];

J. Gluza

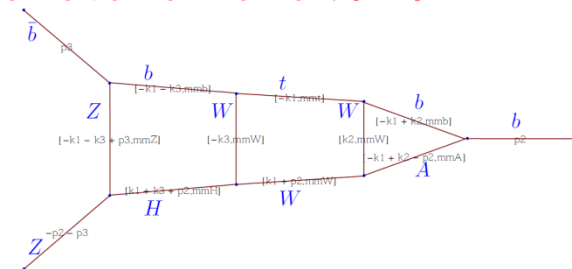

Towards FCC- $\mu\mu$?

- **Why high energy muon colliders ?**
 - ◆ Muons are leptons (like electrons)
 - Collisions at the full energy, small physics background, (E,p) conservation
 - ➔ Muons can a priori do all what electrons can do
 - ◆ Muons are heavy (like protons)
 - Negligible synchrotron radiation, no beamstrahlung
 - ➔ Small circular colliders, up to very large \sqrt{s}
 - ➔ Excellent energy definition (up to a few 10^{-5})
 - ◆ Muons are naturally longitudinally polarized (100%)
 - Because arising from π^\pm decays to $\mu^\pm\nu_\mu$
 - ➔ Ultra-precise beam energy and beam energy spread measurement
- **Recent intriguing approach to muon collider**
 - ◆ Produce muon beams with low emittance with $e^+e^- \rightarrow \mu^+\mu^-$ at production threshold
 - The threshold e^+ energy for $\mu^+\mu^-$ production on a thin target (e^-) is ... 43.7 GeV !
 - ➔ Can use the FCC-ee e^+ ring (or the FCC-ee booster) as μ accumulation and internal target ring !

Towards FCC- $\mu\mu$?

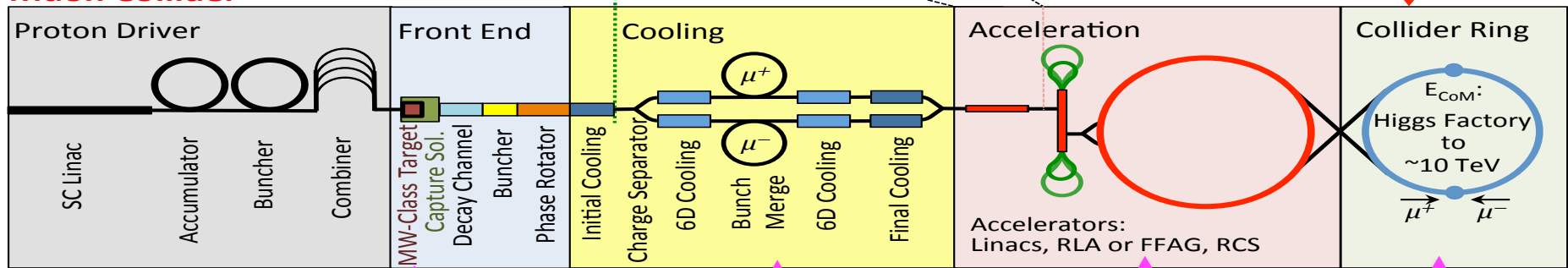

key challenges

$\sim 10^{13}\text{-}10^{14} \mu / \text{sec}$
tertiary particle $p \rightarrow \pi \rightarrow \mu$:

fast cooling
($\tau=2\mu\text{s}$)
by 10^6 (6D)

fast acceleration
mitigating μ decay

background
from μ decay

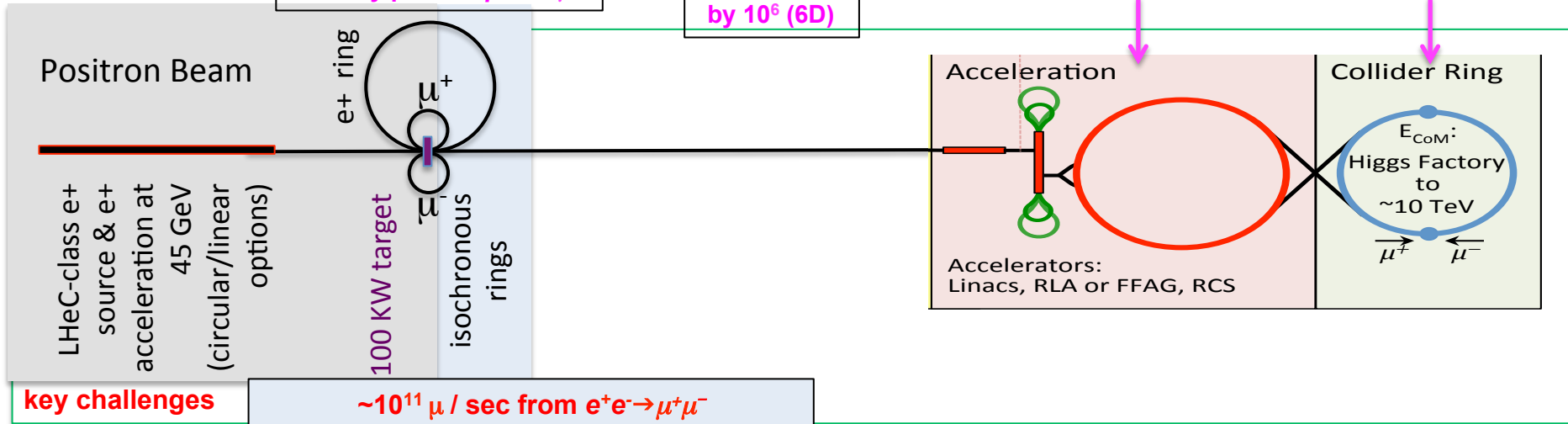

key challenges

$\sim 10^{11} \mu / \text{sec}$ from $e^+e^- \rightarrow \mu^+\mu^-$

Key R&D

$10^{15} e^+/\text{sec}$, 100 kW class target, NON destructive process in e^+ ring

Towards FCC- $\mu\mu$?

- Then inject, accelerate, and collider muons in, e.g., LHC
 - ◆ Before they decay (~1000 turns)
 - $\sqrt{s} = 14$ TeV
 - ~ 7 GeV SRF
 - Pulsed magnets
 - Cost ~ LHC?

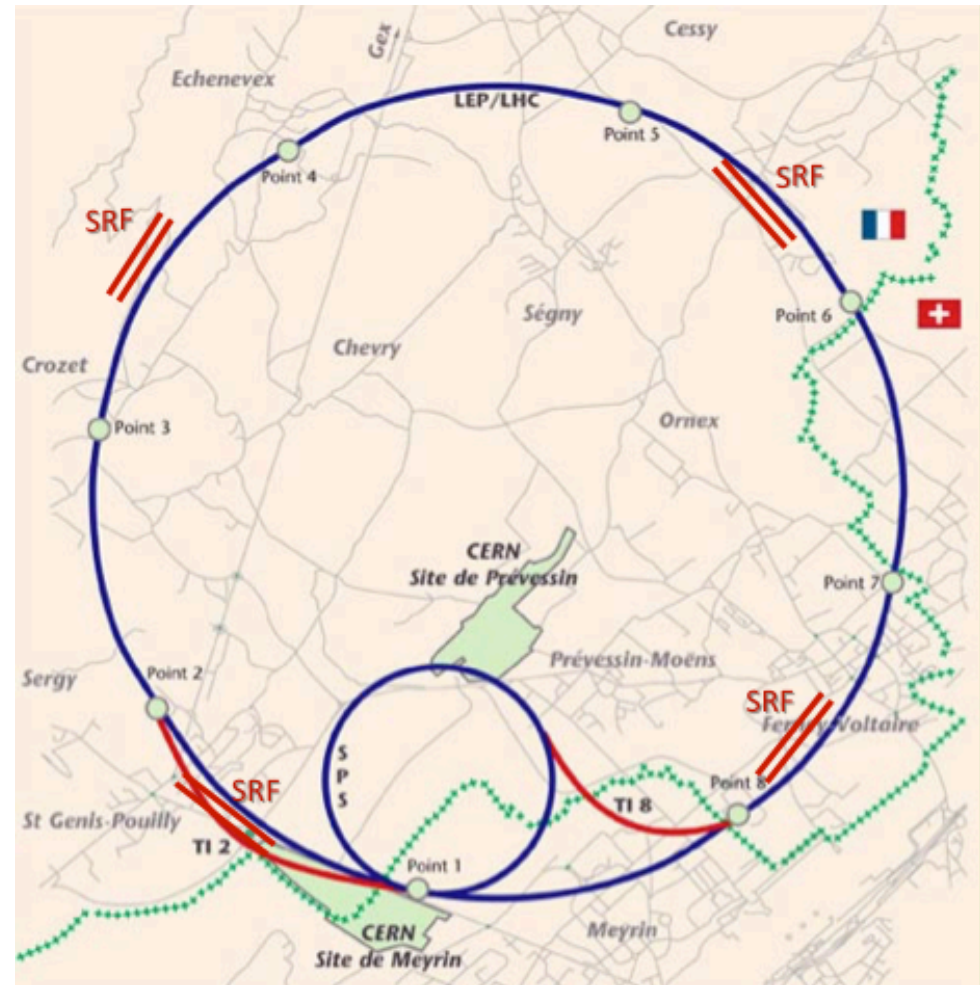

Towards FCC- $\mu\mu$?

- **Q: And how about a linear e^+e^- collider at high energy instead ?**
 - ◆ E.g., with 1 GV/m plasma acceleration (30 km = 30 TeV!)

- **A1 : Power consumption prohibitive**

- ◆ Need ~ 3 GW at 10 TeV !

- **A2 : Beamstrahlung, SR**

- ◆ $\gamma\gamma \rightarrow$ hadrons (pileup)
- ◆ $\sqrt{s_{\text{eff}}} \ll \sqrt{s}$

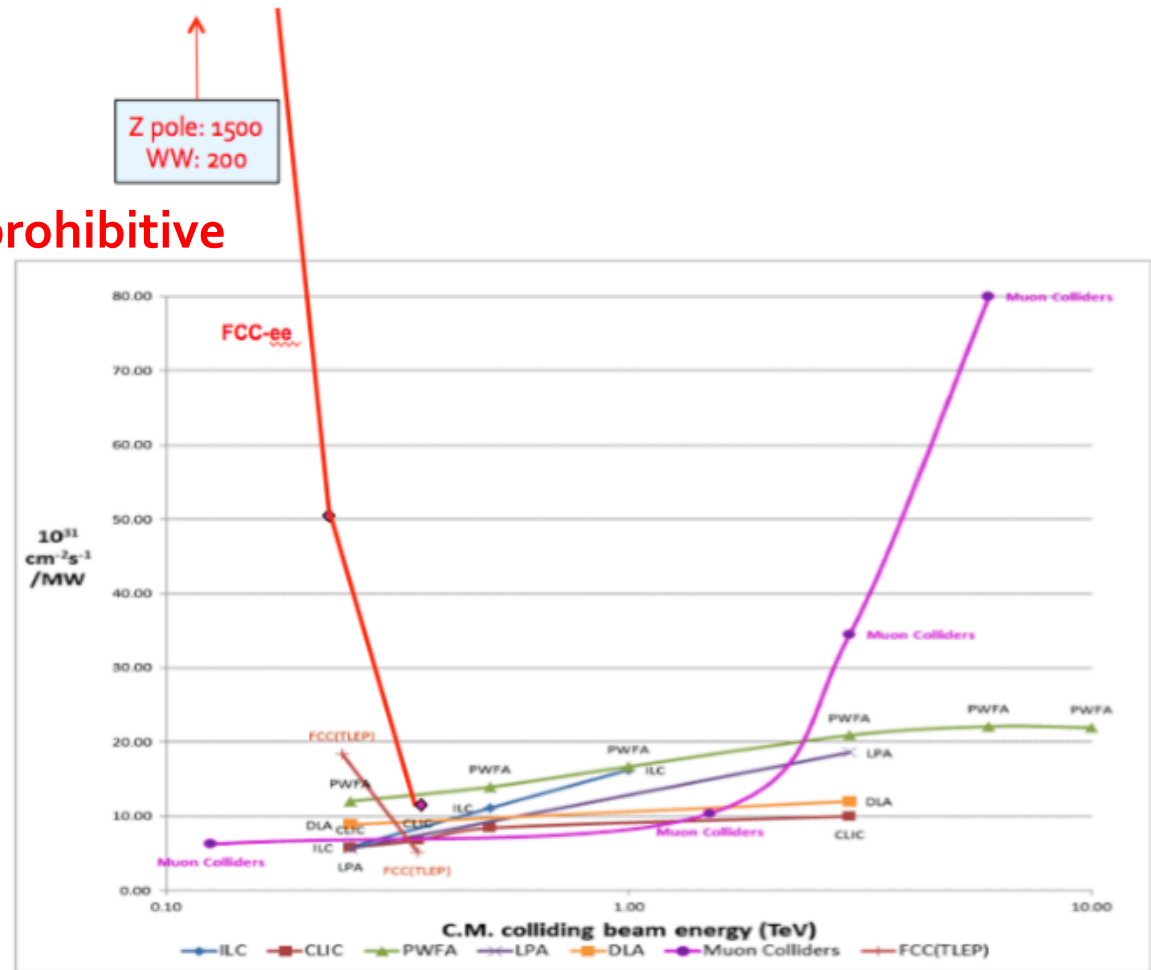

Even more personal views : China

- **Will China be in a position to build an e^+e^- Higgs factory ?**
 - ◆ Maybe followed by a hadron collider ?
 - Financially, yes ! But ...
 - ... size of the community, expertise, scientific and organizational structure
 - In both accelerator and particle physics
 - ... and political progress not as fast as anticipated

- **There will be, most probably, only one such machine in the world**

- **Don't underestimate the value of CERN**
 - ◆ ... and its 60-years track record and treaty in comparison

- **CERN should continue to expand geographically**
 - ◆ With new associate member states
 - ◆ With financial contributions of associate members
 - ◆ ... and maybe persuade China to make a large in-kind contribution to accelerator ?

The road to the CDR

- **Seven volumes to be ready for the European Strategy Update (2019)**
 - ◆ Available in October 2018

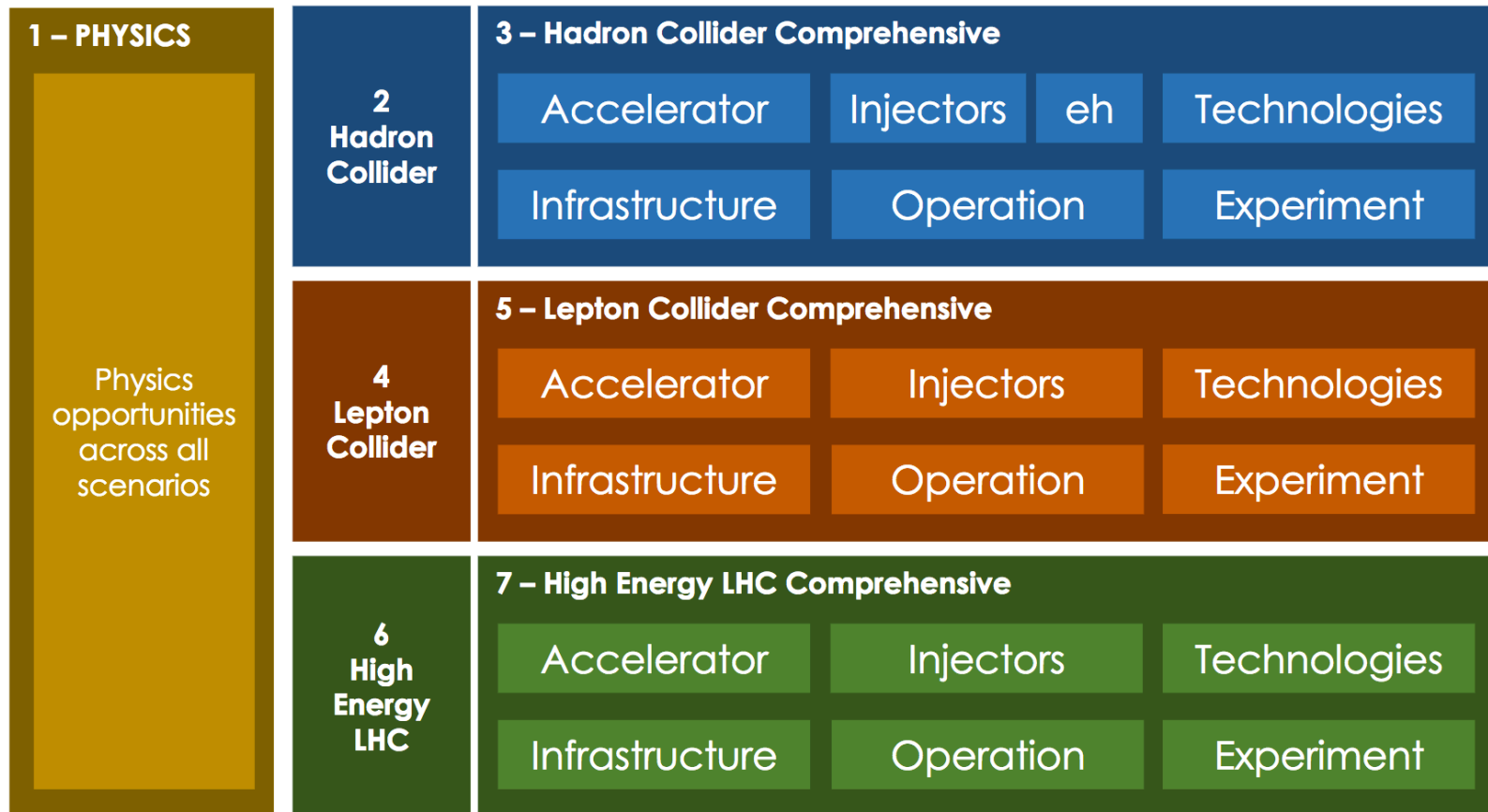

FCC Week 2018

- Last collaboration meeting before the European Strategy update

FCC Week Amsterdam (NL)

- Beurs van Berlage Conference Centre
- Monday 9 April – Friday 13 April 2018
- EASITrain satellite WS on 14.4.
- Recommended by LOC
- Hotel dispatching by Beurs via Web-based system
- Lunch + 3 coffee breaks/day
- Welcome dinner + banquet

