

Part3: Beam dynamics



JUAS 2018

- Multi-particles beam
- Longitudinal dynamics
 - Acceleration
 - Bunching
 - Synchronicity
- Transverse dynamics



Why beam dynamics?



- LINAC: Accelerate particles on a **linear path**.
- Accelerate particle beams in **controlled condition** : Generate a flux of particles at a precise energy and confined in a small volume in space.

-> We have to define how **to accelerate and focus** the beam

Main Linac parameters:

Particles

Output energy

Beam current

Frequency

Pulse length

Repetition rate

Multi-particles beam



- A bunch of particles is characterized by its distribution in the 6D-phase space.

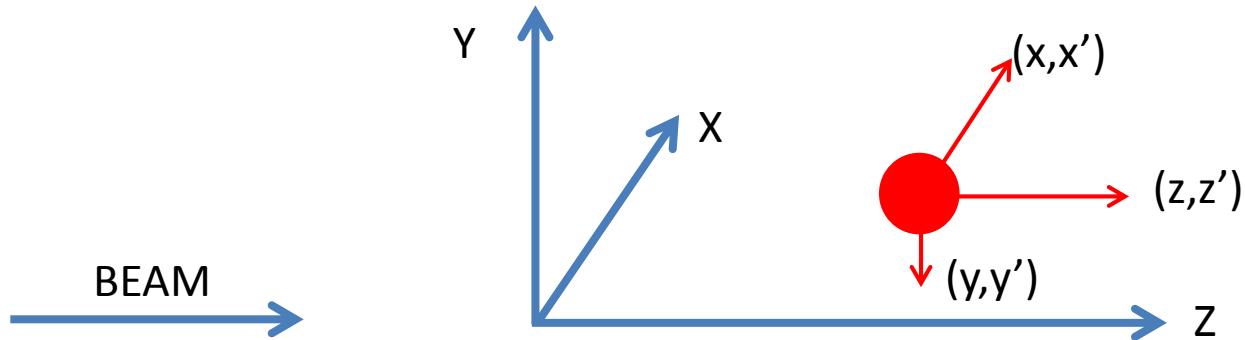

Ele: 0 [0 m] NGOOD : 89476 / 89476

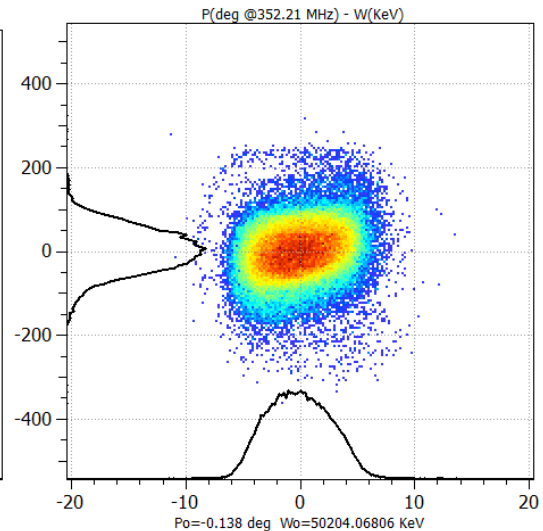
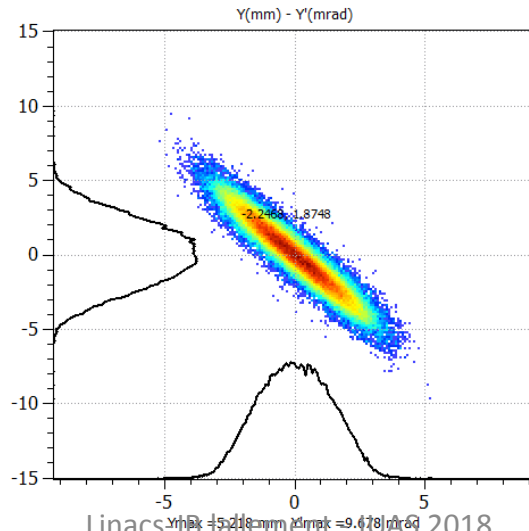
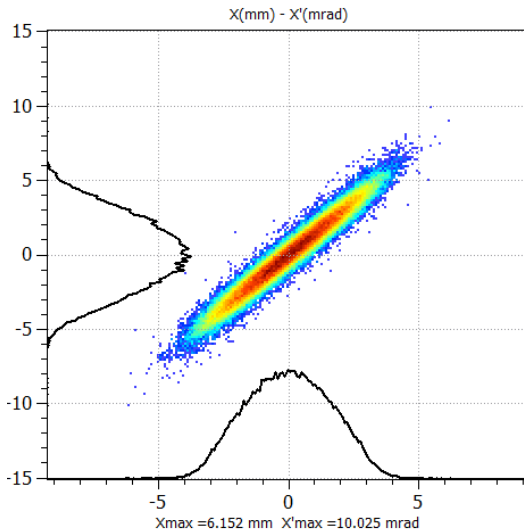

Multi-particles beam

- A bunch of particles is characterized by its distribution in the 6D-phase space.

The ellipse equation used in beam dynamics calculation is:

$$\gamma x^2 + 2\alpha x x' + \beta (x')^2 = \varepsilon$$

Where $\varepsilon = E/\pi$, is the emittance (area of the ellipse) divided by π .

α , β and γ are called the Twiss or Courant-Snyder parameters and are related by:

$$\beta\gamma - \alpha^2 = 1$$

$$x_m = \sqrt{\beta\varepsilon} \quad \text{and} \quad x'_m = \sqrt{\gamma\varepsilon}$$

The RMS emittance is $\varepsilon_{rms} = \sqrt{\overline{x^2} \overline{x'^2} - \overline{xx'}^2}$

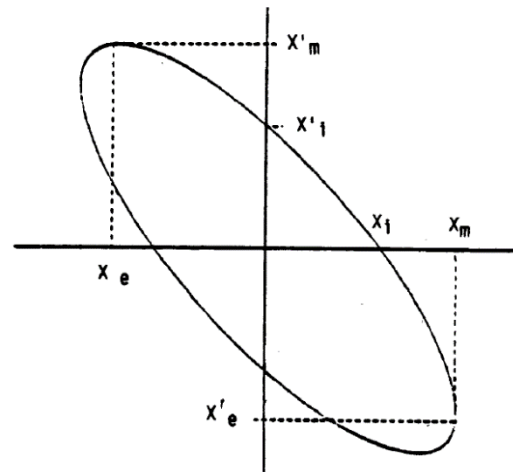
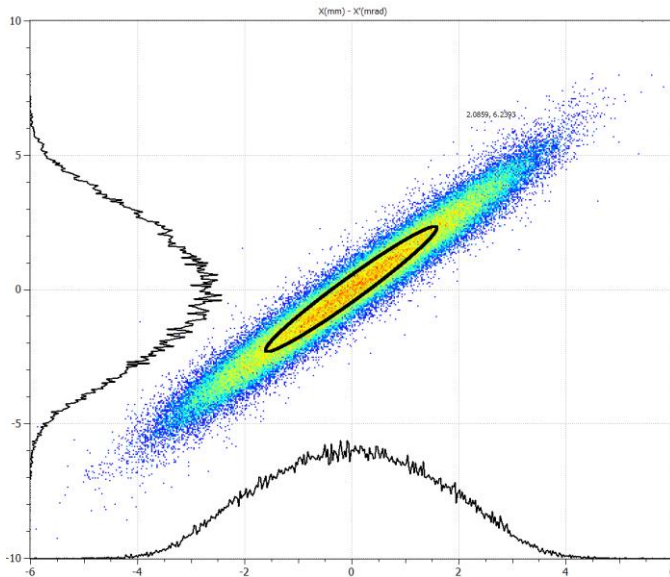

Multi-particles beam

- A bunch of particles is characterized by its distribution in the 6D-phase space.

The ellipse equation used in beam dynamics calculation is:

$$\gamma x^2 + 2\alpha x x' + \beta (x')^2 = \varepsilon$$

Where $\varepsilon = E/\pi$, is the emittance (area of the ellipse) divided by π .

α , β and γ are called the Twiss or Courant-Snyder parameters and are related by:

$$\beta\gamma - \alpha^2 = 1$$

$$x_m = \sqrt{\beta\varepsilon} \quad \text{and} \quad x'_m = \sqrt{\gamma\varepsilon}$$

The RMS emittance is $\varepsilon_{rms} = \sqrt{\overline{x^2} \overline{x'^2} - \overline{xx'}^2}$

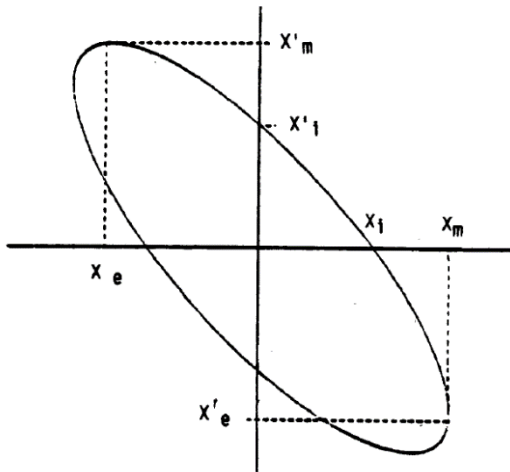

- α is a measure of the focalisation.
- β proportional to the square of the beam size.
Always positive
- γ proportional to the square of the divergence.
Always positive

In the absence of nonlinear forces, the ellipse area, the emittance, is constant : Liouville's theorem

Multi-particles beam

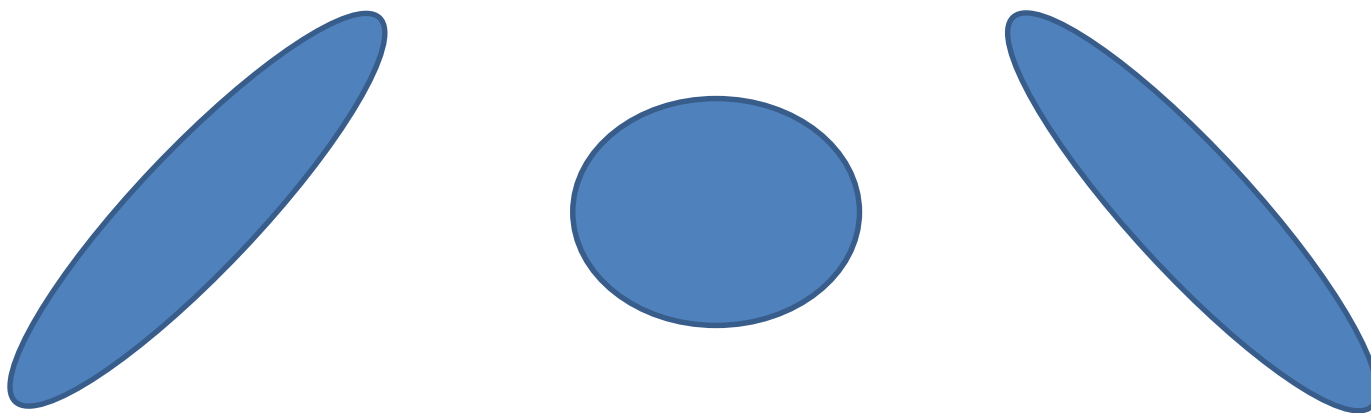
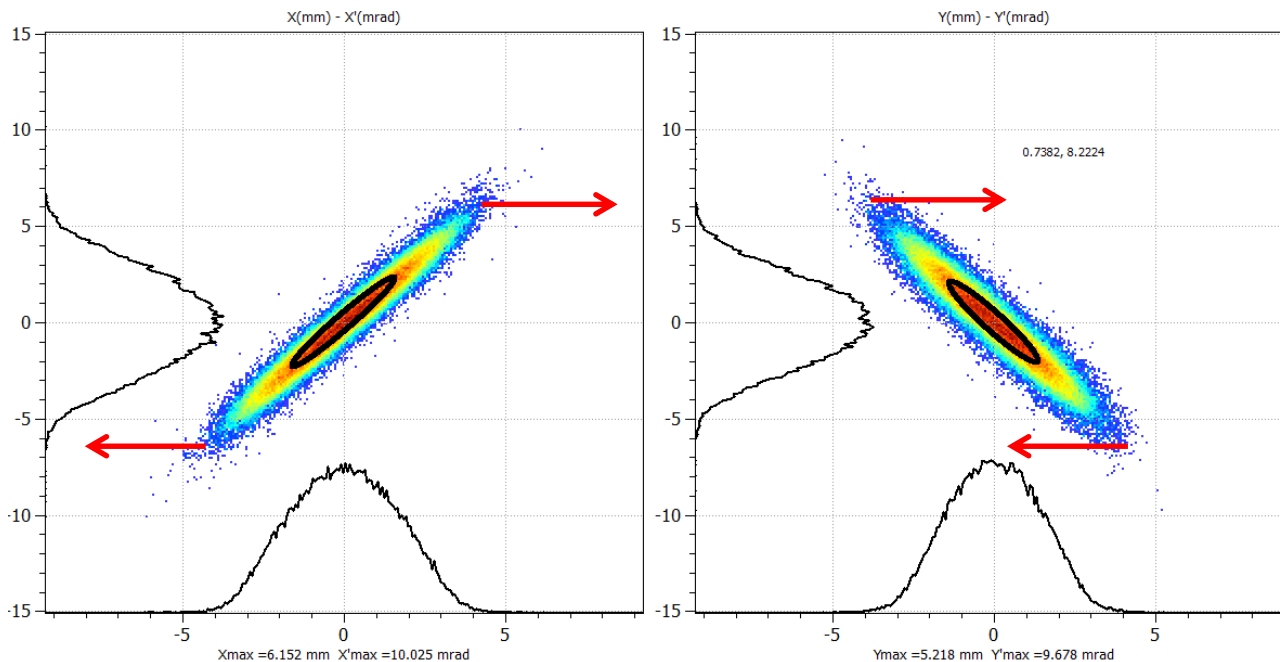

$\alpha < 0$: beam defocused, $\alpha = 0$: parallel beam, $\alpha > 0$: focused beam

Longitudinal dynamics



Linac convention: Remember $\Delta W = q \cdot E_0 \cdot L \cdot T \cdot \cos(\phi)$
Energy gain maximum when $\phi = 0$

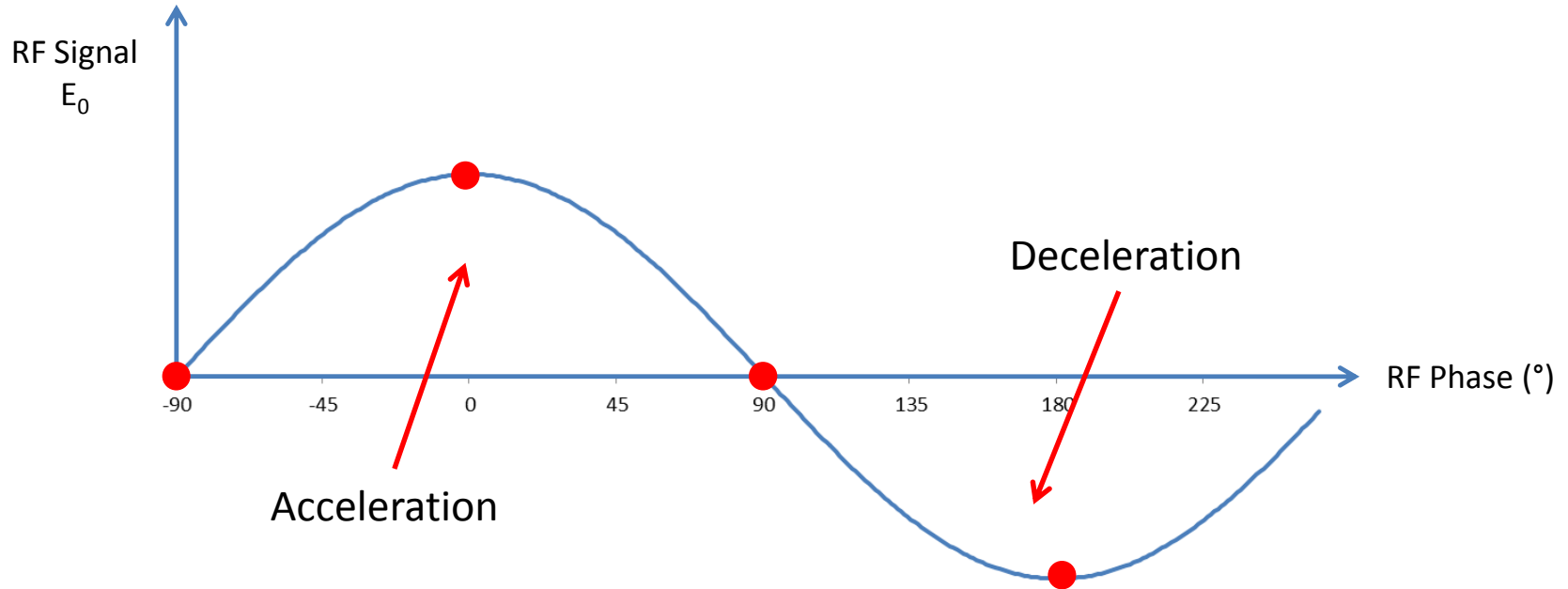

The bunch should only see accelerating field !



Phase, time and longitudinal position of a particle are the same thing.
Always referring to the synchronous particle: A imaginary particle at exact velocity in synchronism with the Linac RF law.

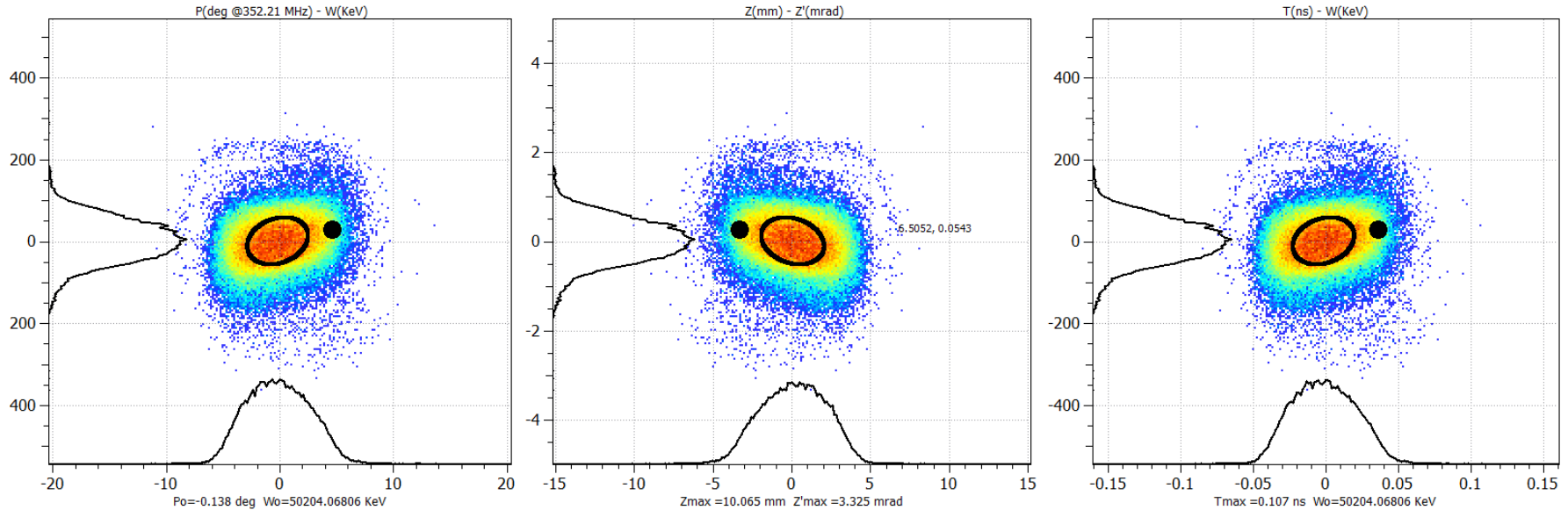

Distance from bunch to bunch: $\beta\lambda$ corresponds to 360° and 1 RF period in time $1/f$.

Ex. at 352.2 MHz and protons at 50 MeV

$\beta=0.314$, $\lambda=c/f$, $\beta\lambda=267$ mm, $T=2.84$ ns.

In one RF period, a 50 MeV proton travels over 267 mm during 2.87 ns.

On the plot $\rightarrow 4.5^\circ \rightarrow -3.3$ mm $\rightarrow 3.55e^{-11}$ s

Bunching



More in details, effect on a bunch of particles

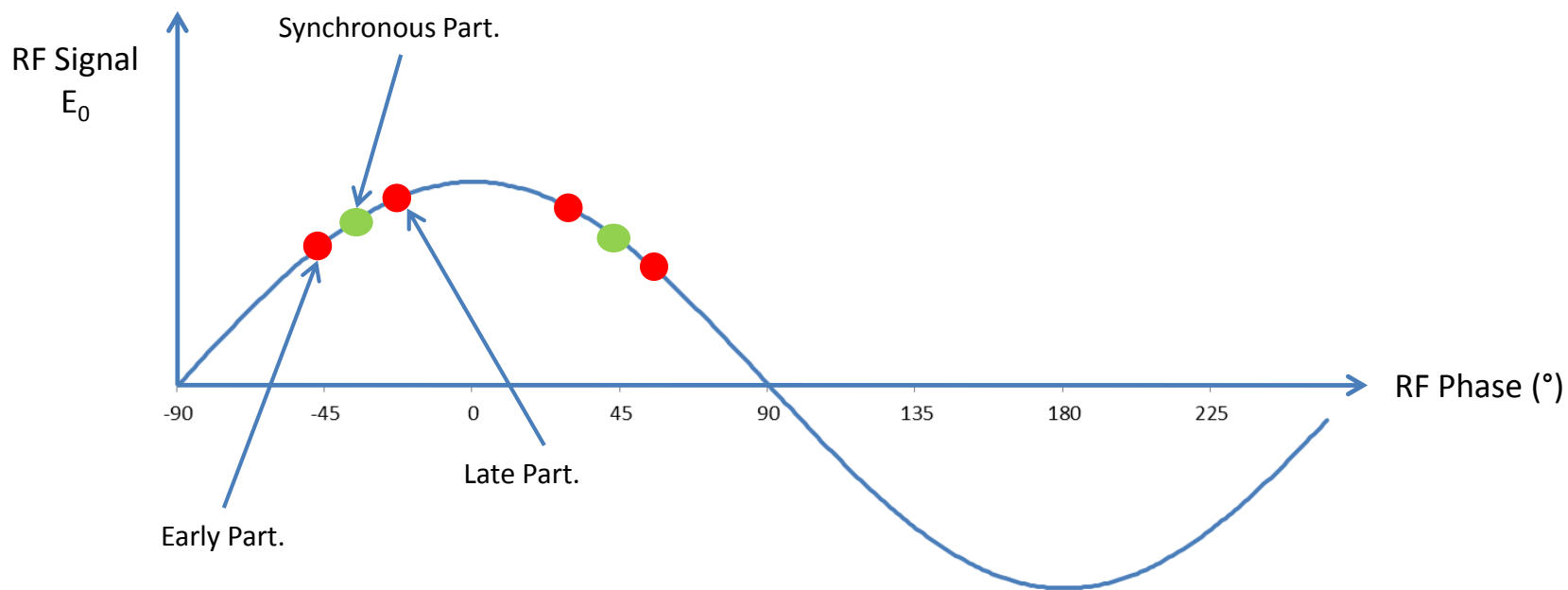

The synchronous part. gets the correct kick – by definition
The late part. gains slightly more energy
The early part. Gains slightly less energy.



Bunching / Focusing

Bunching

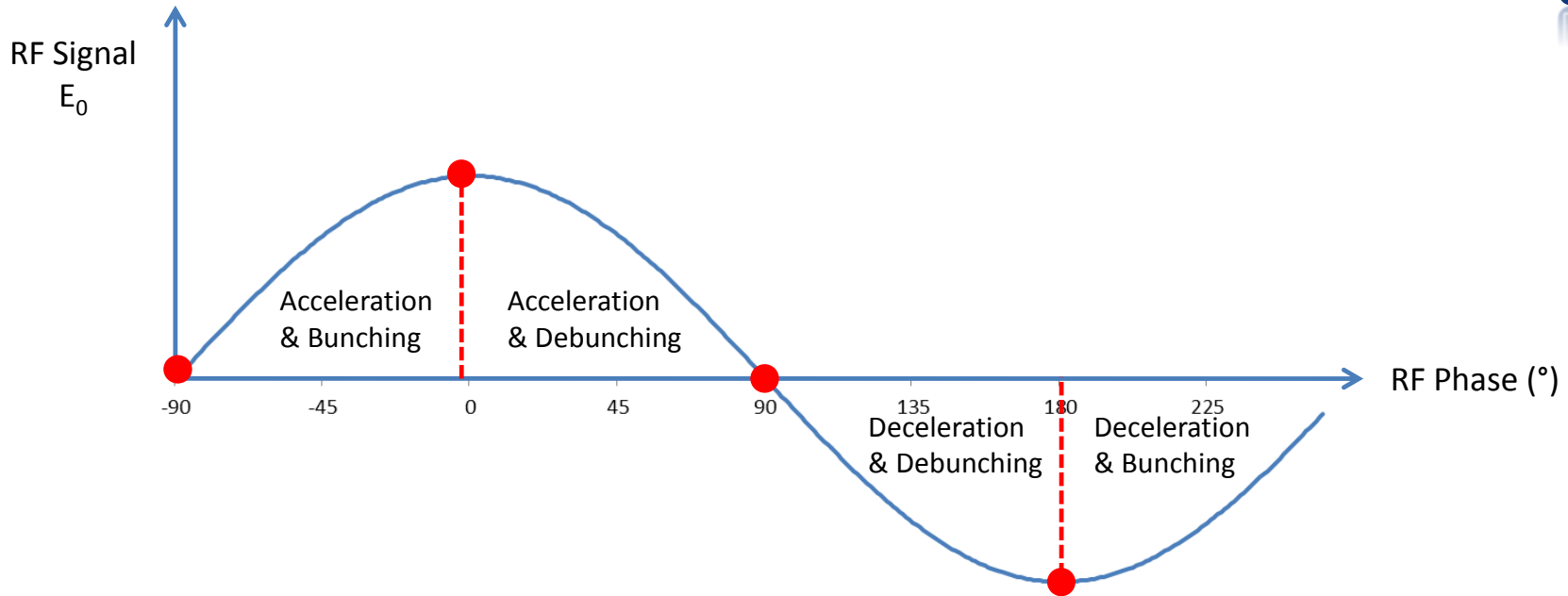

Energy gain for the synchronous particle
Energy gain for a particle with phase ϕ

$$\Delta W_s = qE_0LT \cos(\phi_s)$$

$$\Delta W = qE_0LT \cos(\phi)$$

$$\frac{d}{ds} \Delta W = qE_0T \cdot [\cos(\phi_s + \Delta\phi) - \cos\phi_s]$$

For $\phi - \phi_s$ small

$$\frac{d}{ds} \Delta\phi = \omega \left(\frac{dt}{ds} - \frac{dt_s}{ds} \right) = \frac{\omega}{c} \left(\frac{1}{\beta} - \frac{1}{\beta_s} \right) \cong -\frac{\omega}{\beta_s c} \frac{\Delta\beta}{\beta_s} = -\frac{\omega}{mc^3 \beta_s^3 \gamma_s^3} \Delta W$$

Separatrix

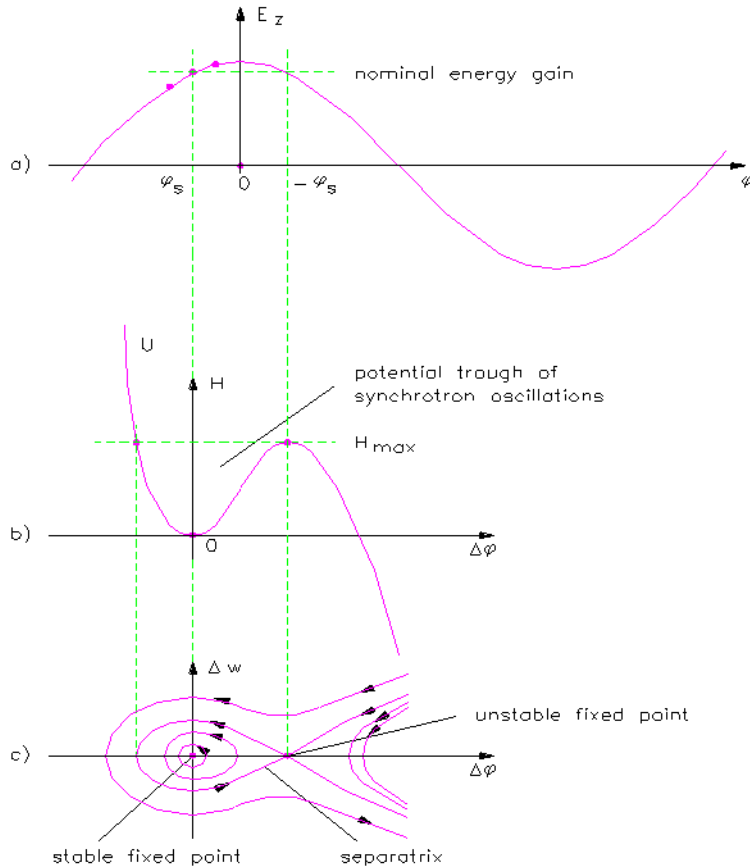

RF electric field as function of phase.

Potential of synchrotron oscillations

Trajectories in the longitudinal phase space each corresponding to a given value of the total energy (stationary bucket)

Tutorial !



- Equation for the canonically conjugated variables phase and energy with Hamiltonian (total energy of oscillation):

$$\frac{\omega}{mc^3 \beta_s^3 \gamma_s^3} \left\{ \frac{\omega}{2mc^3 \beta_s^3 \gamma_s^3} (\Delta W)^2 + qE_0 T [\sin(\varphi_s + \Delta\varphi) - \Delta\varphi \cos \varphi_s - \sin \varphi_s] \right\} = H$$

- For each H we have different trajectories in the longitudinal phase space. Equation of the separatrix (the line that separates stable from unstable motion)

$$\frac{\omega}{2mc^3 \beta_s^3 \gamma_s^3} (\Delta W)^2 + qE_0 T [\sin(\varphi_s + \Delta\varphi) + \sin \varphi_s - (2\varphi_s + \Delta\varphi) \cos \varphi_s] = 0$$

- Maximum energy excursion of a particle moving along the separatrix

$$\Delta \hat{W}_{\max} = \pm 2 \left[\frac{qmc^3 \beta_s^3 \gamma_s^3 E_0 T (\varphi_s \cos \varphi_s - \sin \varphi_s)}{\omega} \right]^{\frac{1}{2}}$$

Separatrix

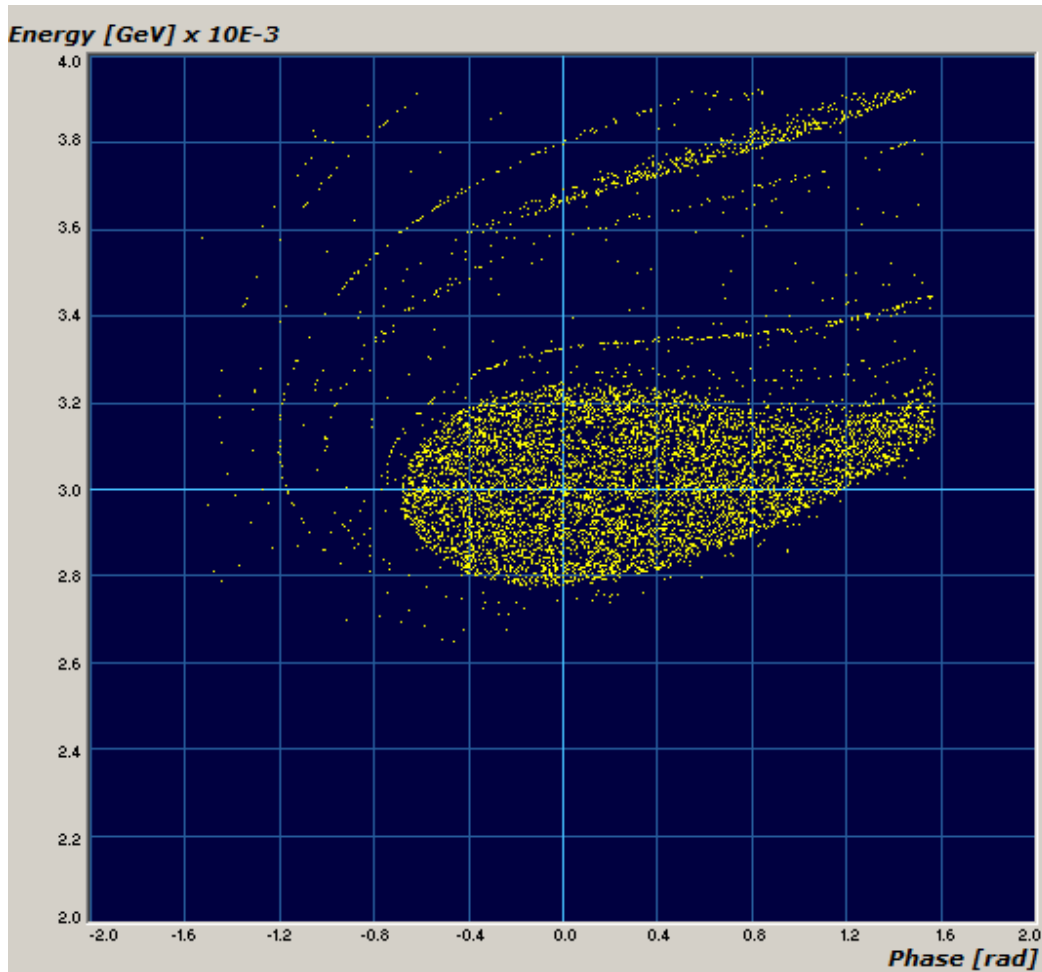

Longitudinal acceptance

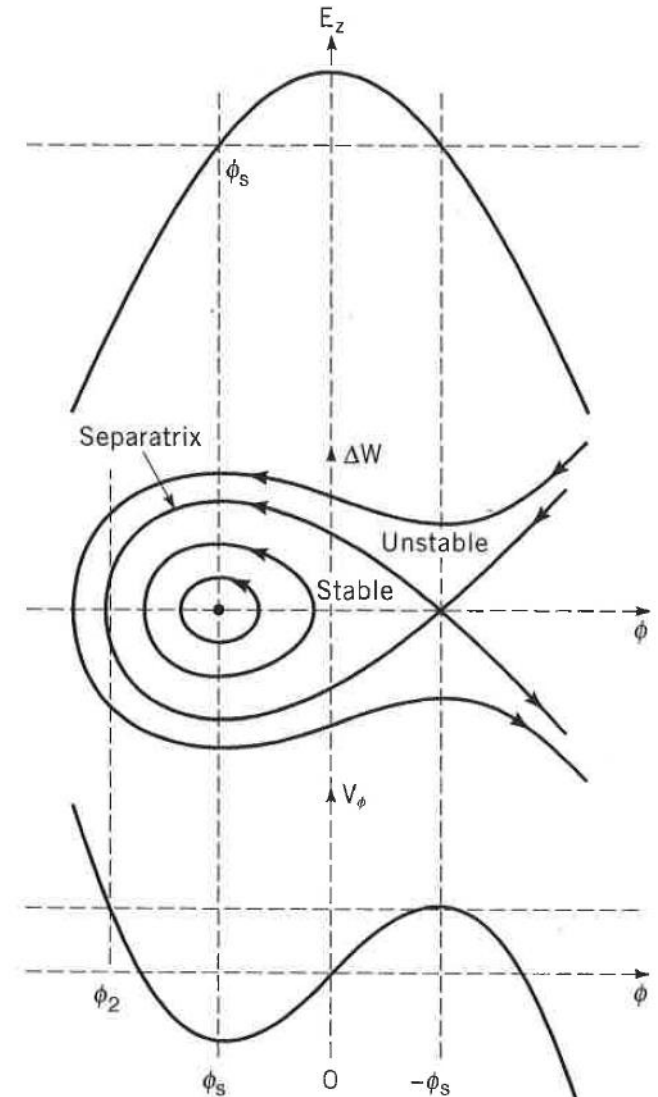

Long. phase advance



By accelerating on the rising slope of the positive RF wave we have a longitudinal force keeping the beam bunched.
This force is characterized by the longitudinal phase advance.

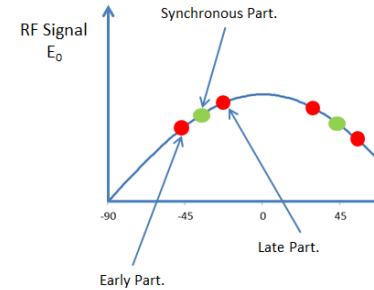

Longitudinal phase advance per unit of length

$$k_{0l} = \sqrt{\frac{2\pi q E_0 T \sin(-\varphi_s)}{mc^2 \beta_s^3 \gamma^3 \lambda}}$$

Longitudinal phase advance per period
If a period is $[N\beta\lambda]$

$$\sigma_{0l} = \sqrt{\frac{2\pi q E_0 T N^2 \lambda \sin(-\varphi_s)}{mc^2 \beta_s \gamma^3}}$$

More details on phase advance in Transverse plane !!!

Synchronicity



Adapting the cavity geometry to the velocity of the particle.

- Case1 : $\beta_s = \beta_g$ -> structure is continuously changing to adapt to the synchronous particle velocity change.
- Case2 : $\beta_s \approx \beta_g$ -> structure is adapted in step to the synchronous particle velocity change. Phase slippage.
- Case3 : $\beta_s = \beta_g \approx 1$. Constant structure.

Synchronicity – Case1



- Case1 : $\beta_s = \beta_g \rightarrow$ structure is continuously changing to adapt to the synchronous particle velocity change.

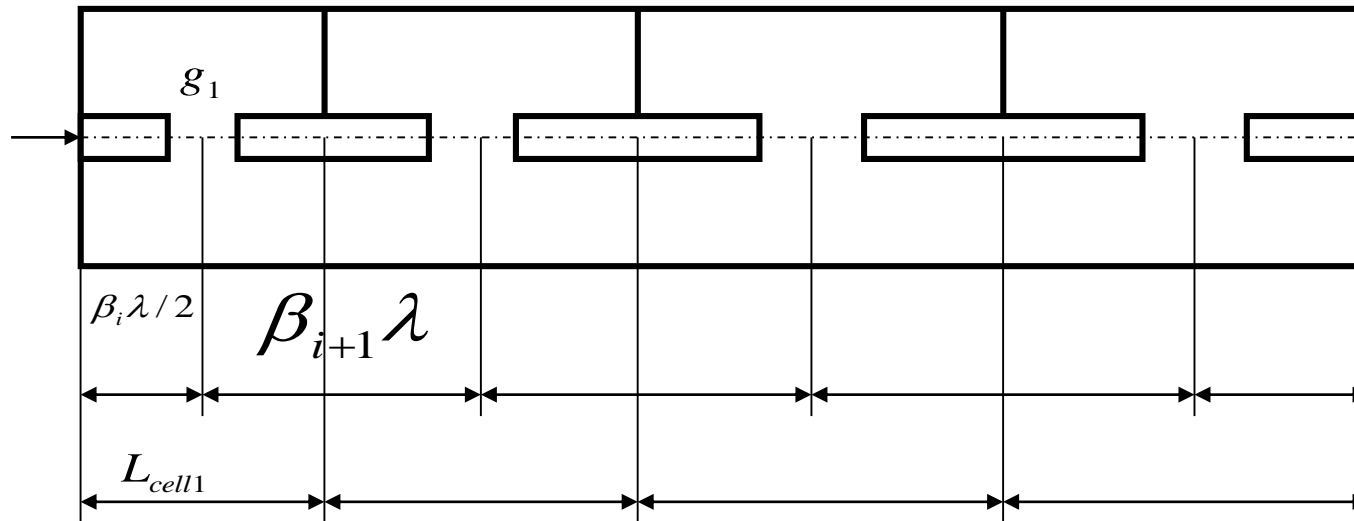

- fix phase RF and gap length
- the syncr. particle should travel a distance L in one RF period
- assume that the particle goes to mid gap with the initial velocity.
- at mid gap the particle velocity is increased by an amount corresponding to the effect of the integrated electric field times the transit time factor. $\Delta W = qE_0 T L \cos(\Phi)$
- the particle drifts with this velocity till the end of the cell
- and so on and so on.....

Synchronicity – Case1

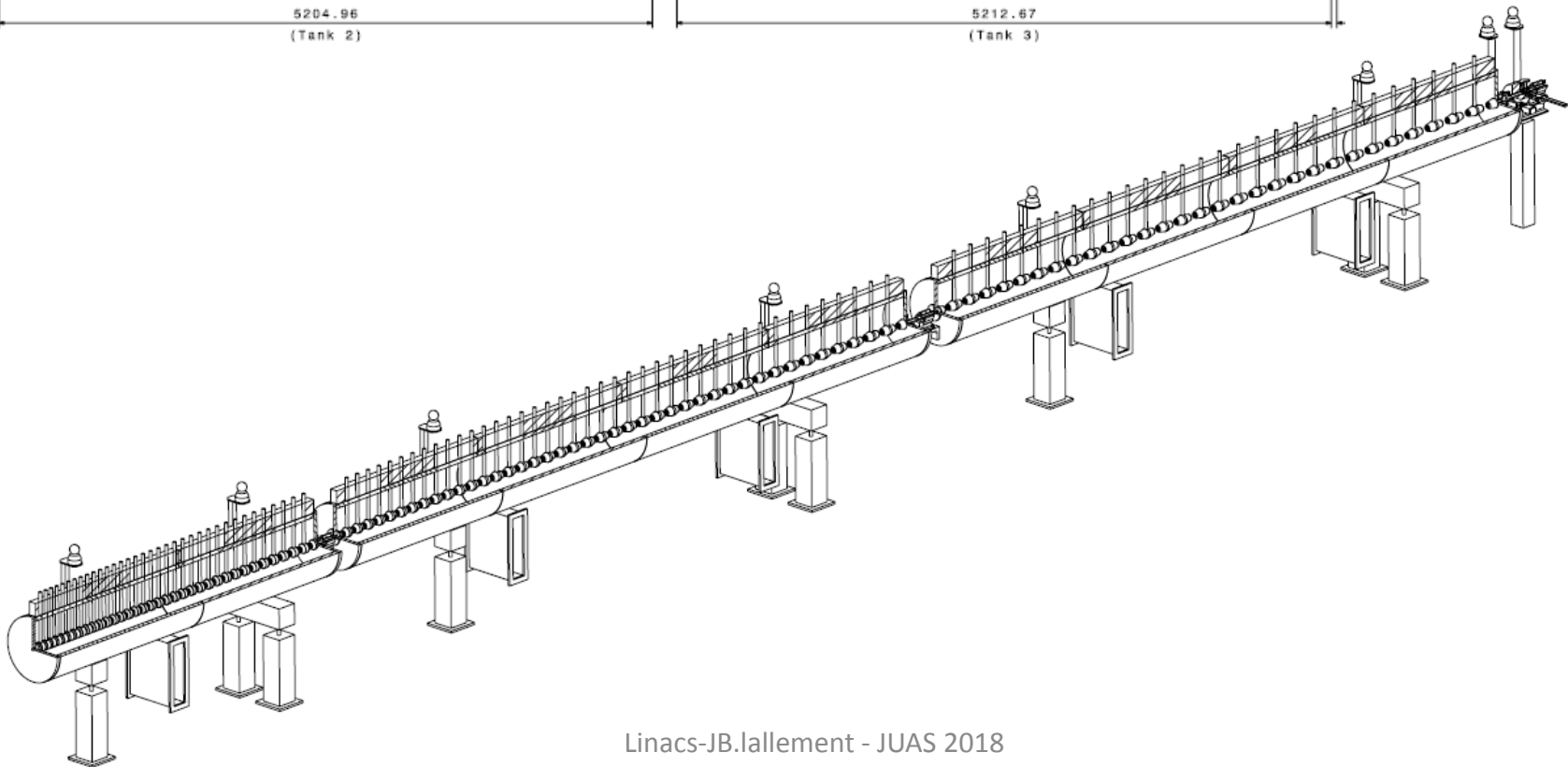
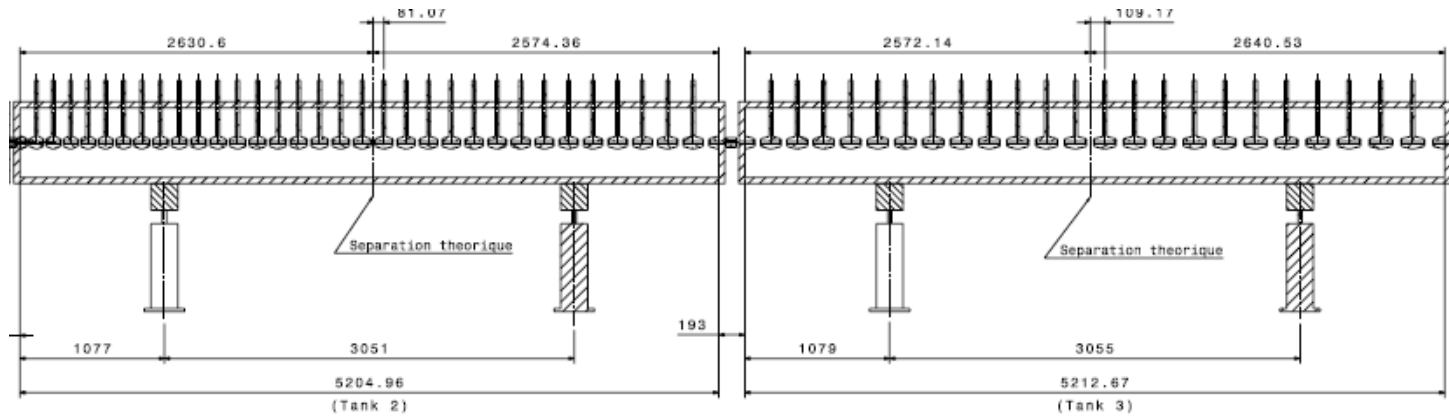

Synchronicity – Case2

- Case2 : $\beta_s = \beta_g \rightarrow$ structure is adapted in step to the synchronous particle velocity change. Phase slippage

For simplifying the construction and therefore keeping the cost down, cavities are not individually tailored to the evolution of the beam velocity but they are constructed in blocks of identical cavities. It implies phase slippage.

Example of phase slippage: CERN design for a 352 MHz SC linac.

Four sections:

$\beta = 0.52$ (120 - 240 MeV)

$\beta = 0.7$ (240 - 400 MeV)

$\beta = 0.8$ (400 MeV - 1 GeV)

$\beta = 1$ (1 - 2.2 GeV)

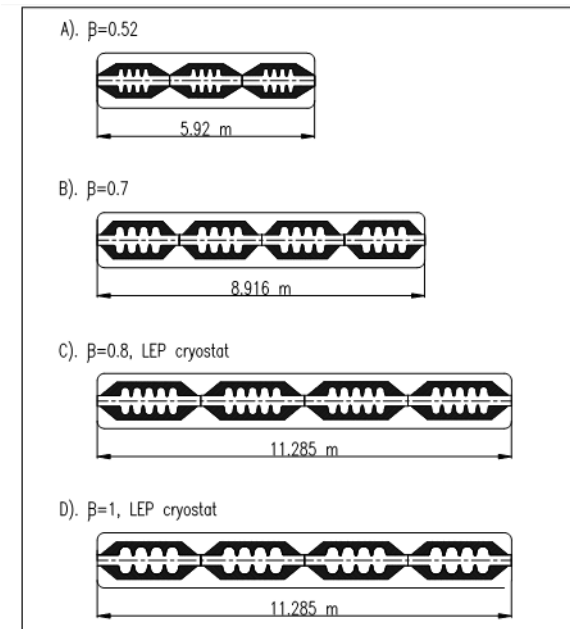
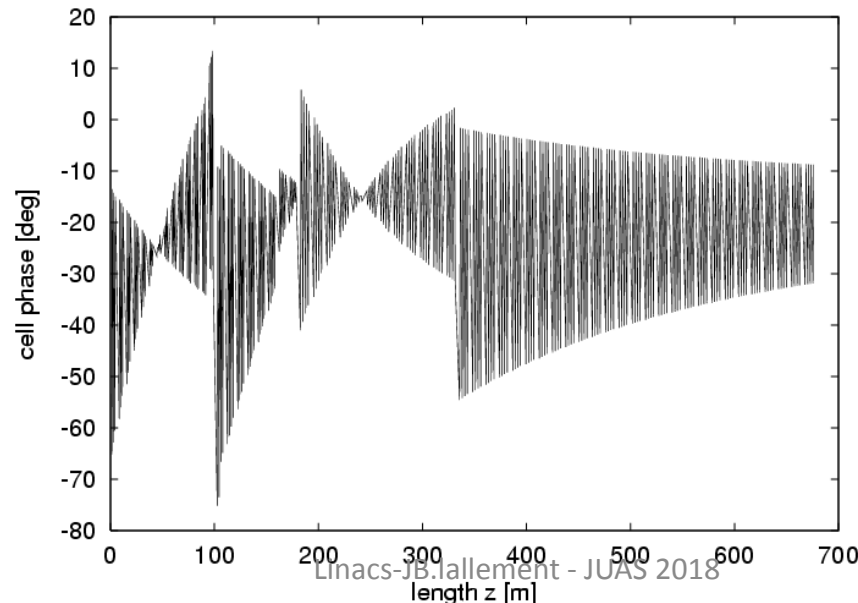

Transverse beam dynamics



We accelerate and keep the beam bunched in longitudinal, we still have to keep it small in the transverse planes !!!

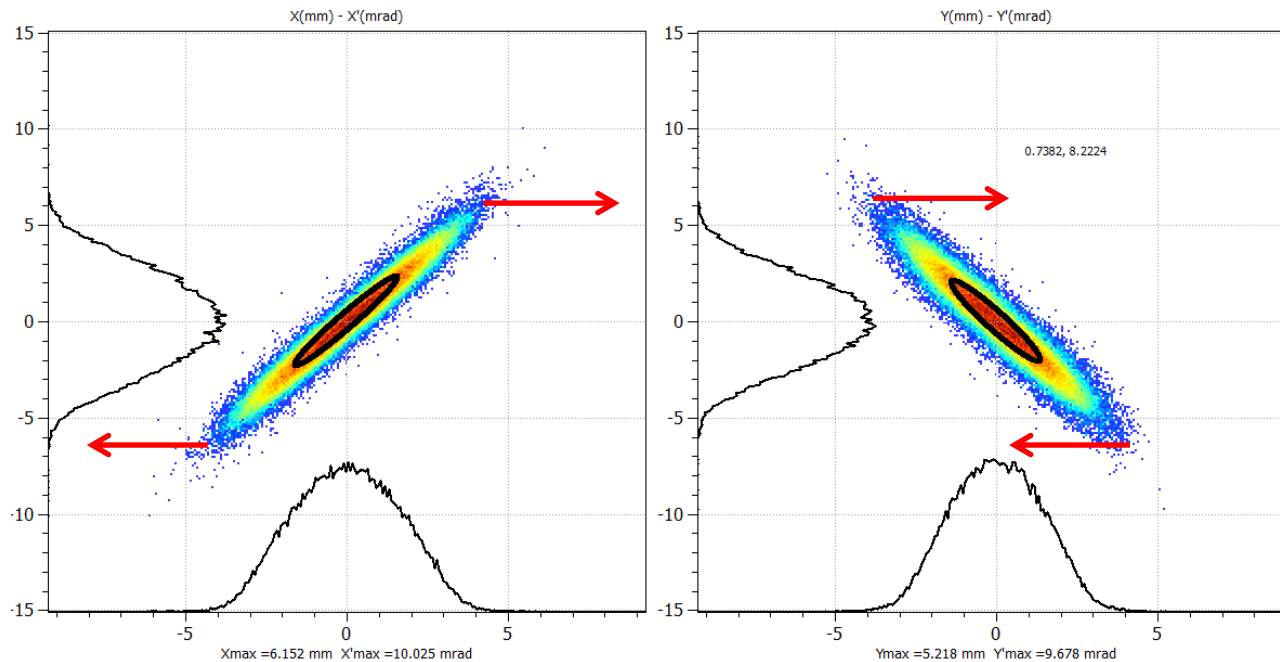

Focusing force

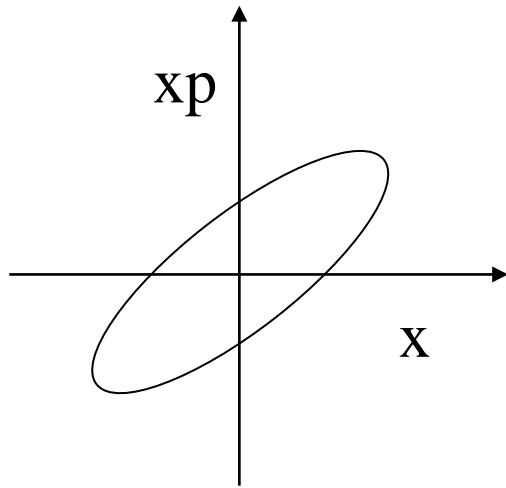

Defocused beam

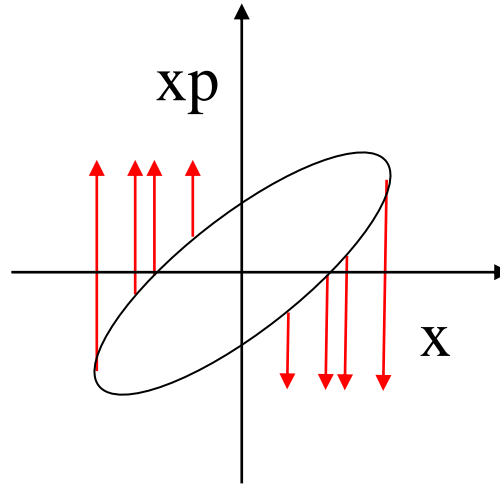

Apply force towards the axis
proportional to the distance from
the axis: $F(x)=-Kx$

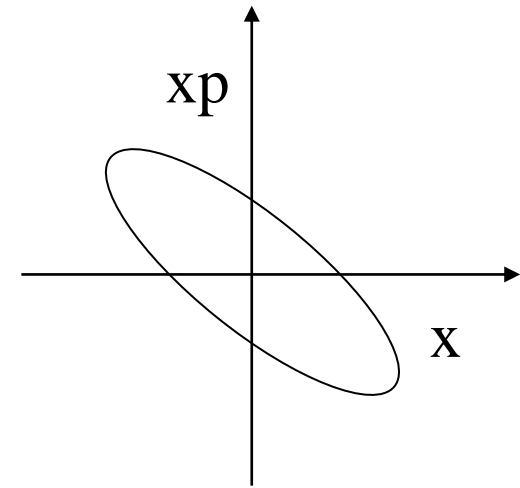

Focused beam

Magnetic focusing: $\vec{F} = q\vec{v} \times \vec{B}$

Depends on part. velocity

Electric focusing: $\vec{F} = q \cdot \vec{E}$

Independent of part. velocity

Magnetic Quadrupole

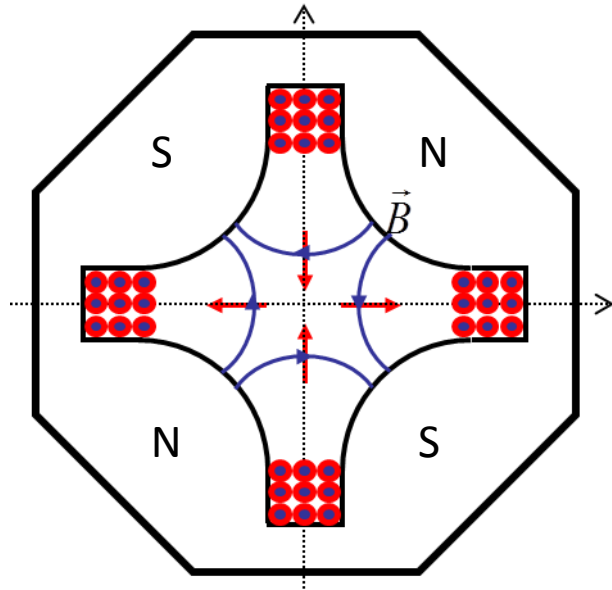

G is the quadrupole gradient [T/m]

Magnetic field

$$\begin{cases} B_x = -G \cdot y \\ B_y = G \cdot x \end{cases}$$

Magnetic force

$$\begin{cases} F_x = -q \cdot v \cdot G \cdot x \\ F_y = q \cdot v \cdot G \cdot y \end{cases}$$

Focusing in one plane, defocusing in the other

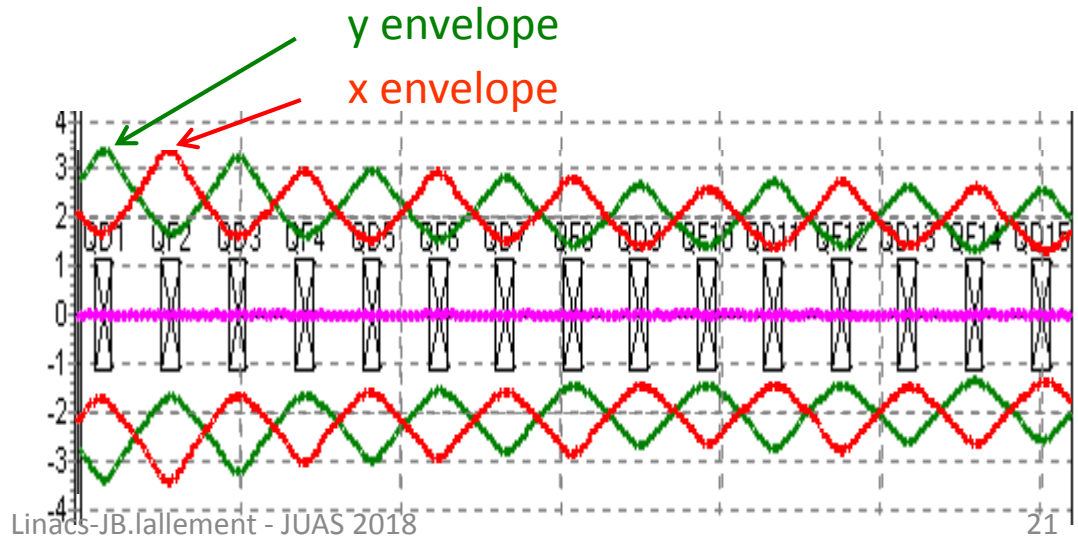
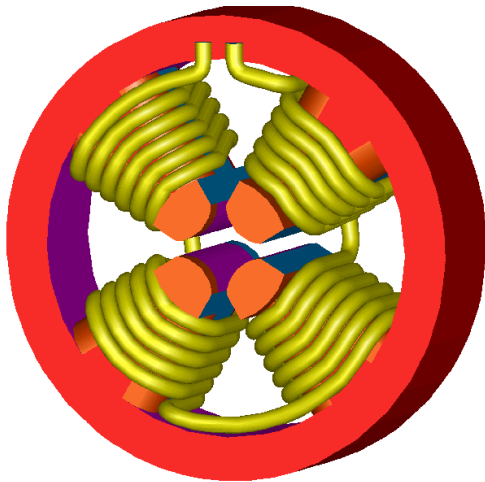

Focusing channel



Focusing in one plane, defocusing in the other !!!
We need to alternate focusing and defocusing quadrupoles.
Many possible solutions. Some examples are:

- FD (FODO)



- FFDD



- Triplets



- FODO



- Etc.....

For a regular focusing channel, the 4D transverse phase space is identical after each period!

FD focusing



TraceWin - CEA/DSM/Irfu/SACM

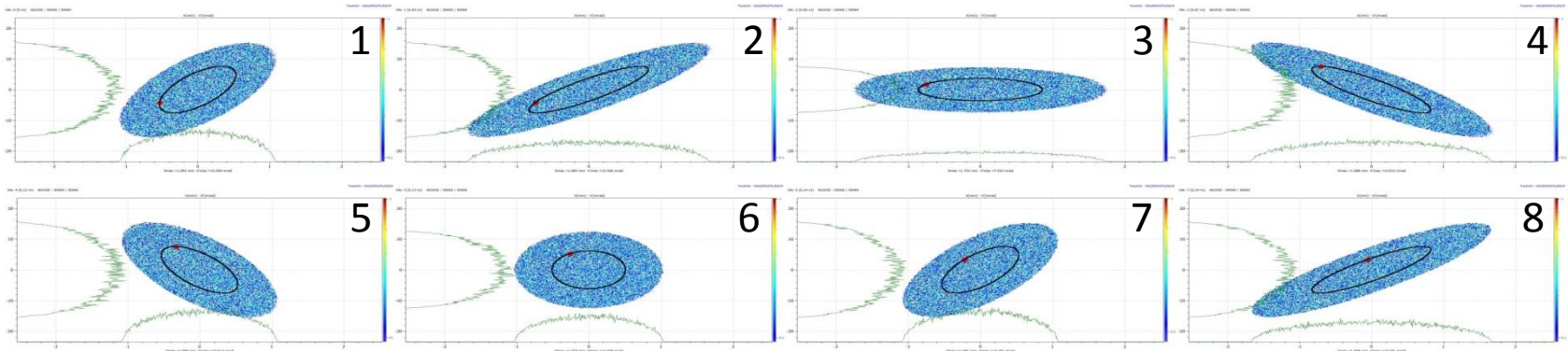
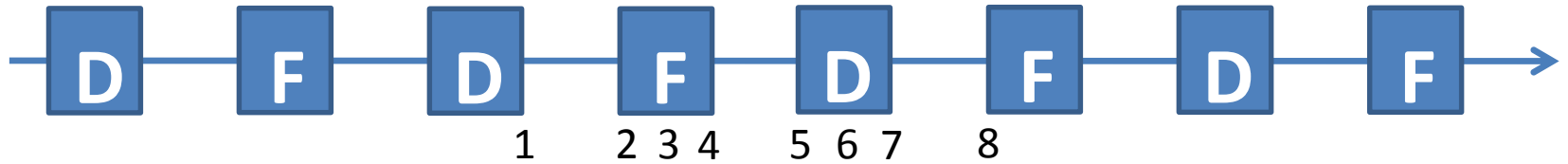
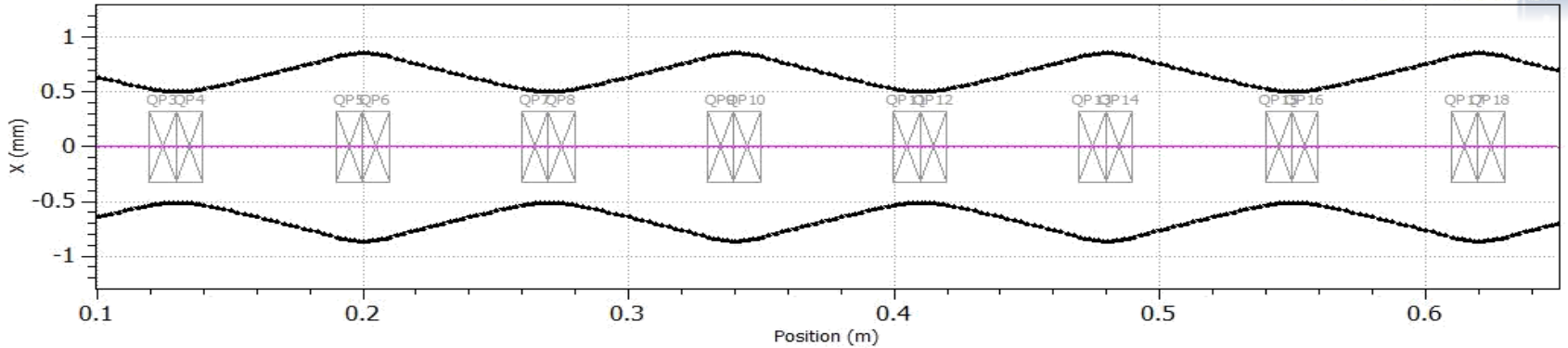

The beam is **matched**, after every period, α , β and γ , the twiss parameters are identical.

FD focusing

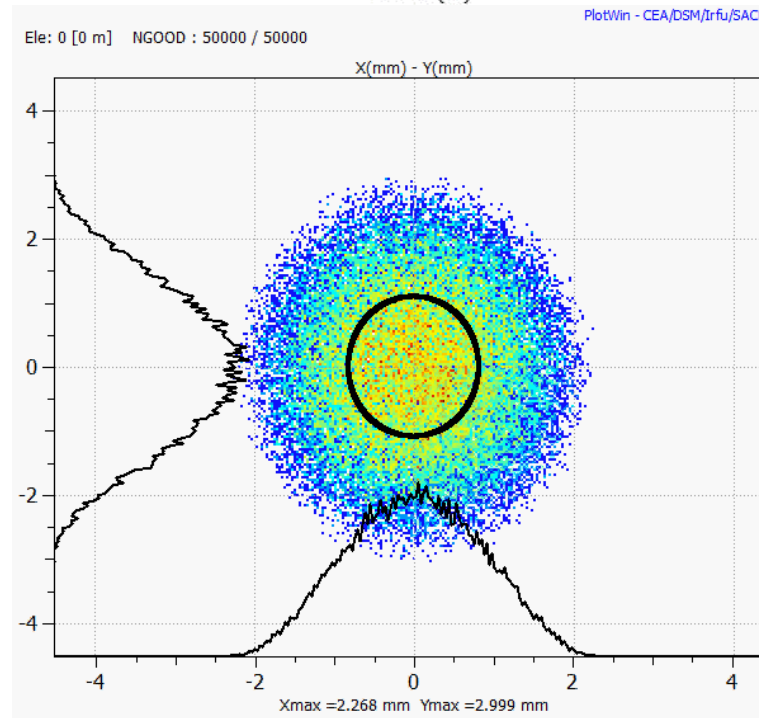
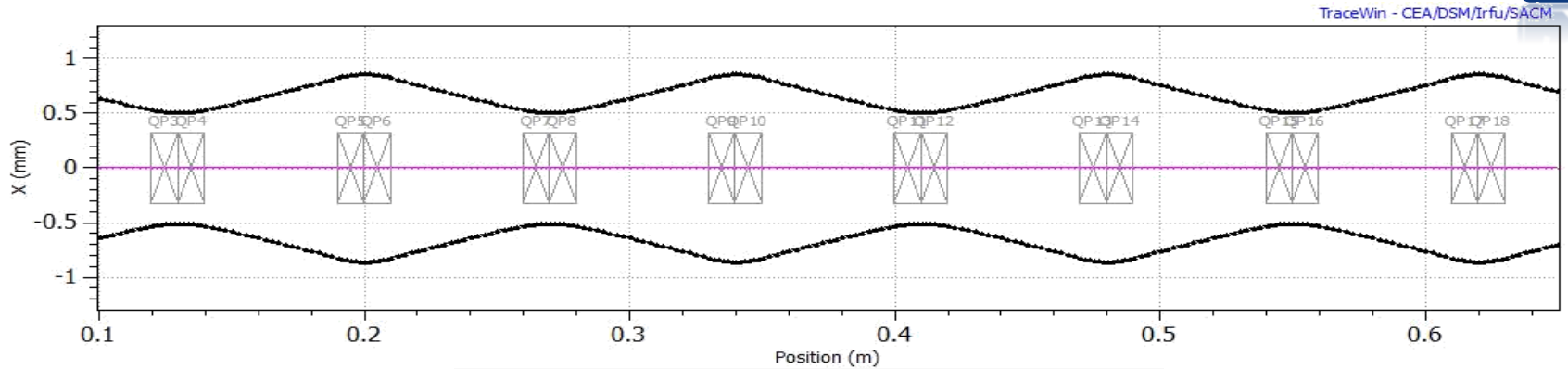

Mismatched beam



Mismatching:

Emittance growth & Halo formation through

- Non linear forces (external or space charge)
- Resonance of some particle motion with core oscillation (space charge)

Ex. 100 mA proton beam thru a 5 – 85 MeV DTL

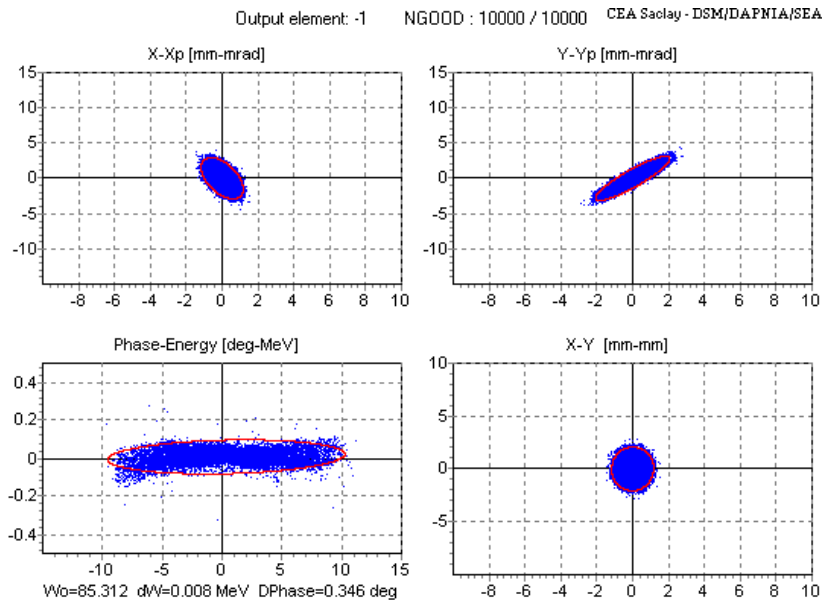

Matched beam

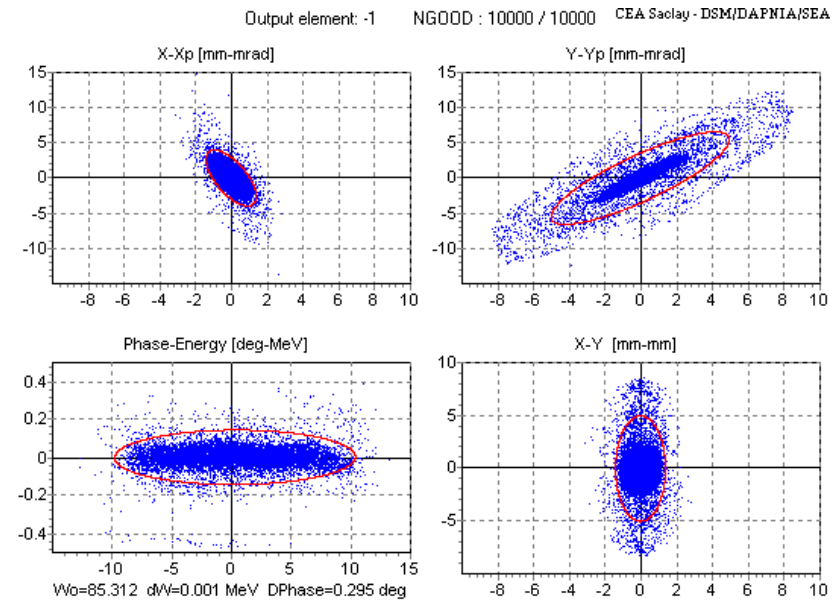

Mismatched beam

Transverse Phase advance



As in the longitudinal plane, we can define the transverse phase advance. It defines the “focusing strength”.

Can be defined as,
phase advance over s

$$\sigma_t = \int_0^z \frac{1}{\beta(z)} dz$$

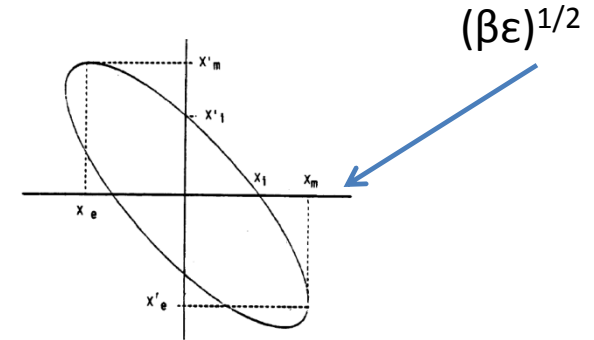

Exemple:

Lattice	Period	σ_0 (per period)	k_0 per meter
FD	2L	$\frac{qGLL}{\beta\gamma mc}$	$\frac{qGl}{2\beta\gamma mc}$
FFDD	4L	$\frac{2\sqrt{2}qGLL}{\beta\gamma mc}$	$\frac{\sqrt{2}qGl}{2\beta\gamma mc}$

Tutorial !

Where $L = \beta\lambda$ (relativistic beta)
 l : length of the quadrupoles
 G : Gradient

Zero current transverse phase advance !

Transverse Phase advance

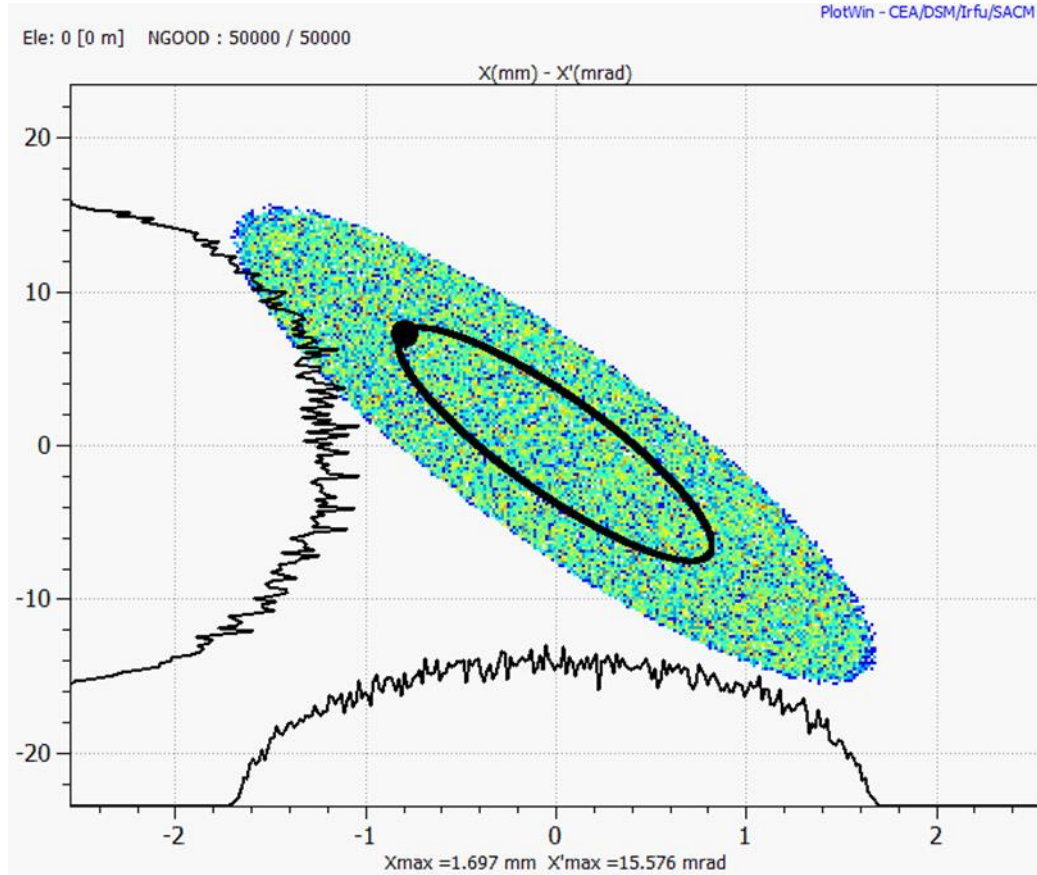

Video: Design a FD channel with zero current and 60° phase advance per period.
After every period, beam ellipse is the same.

After 6 periods, the highlighted particle is back in its initial position.

$$6 \text{ periods} * 60^\circ = 360^\circ$$

Transverse Phase advance

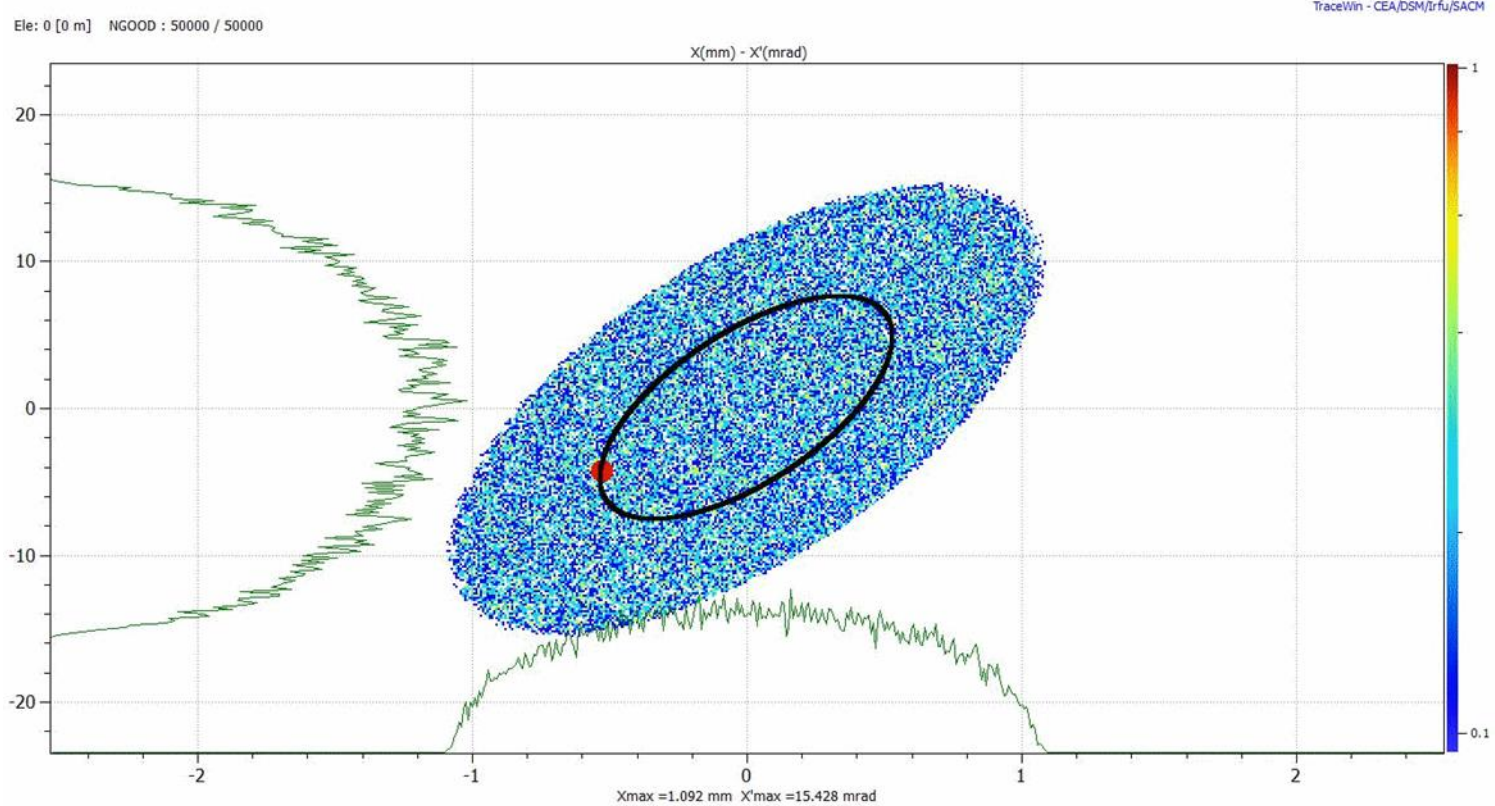

Design a FD channel with zero current and 60° phase advance per period.
After every period, beam ellipse is the same.
After 6 periods, the highlighted particle is back in its initial position.

$$6 \text{ periods} * 60^\circ = 360^\circ$$

Transverse Phase advance



We follow two particles on the RMS ellipse along a FD channel.
In black the RMS envelope

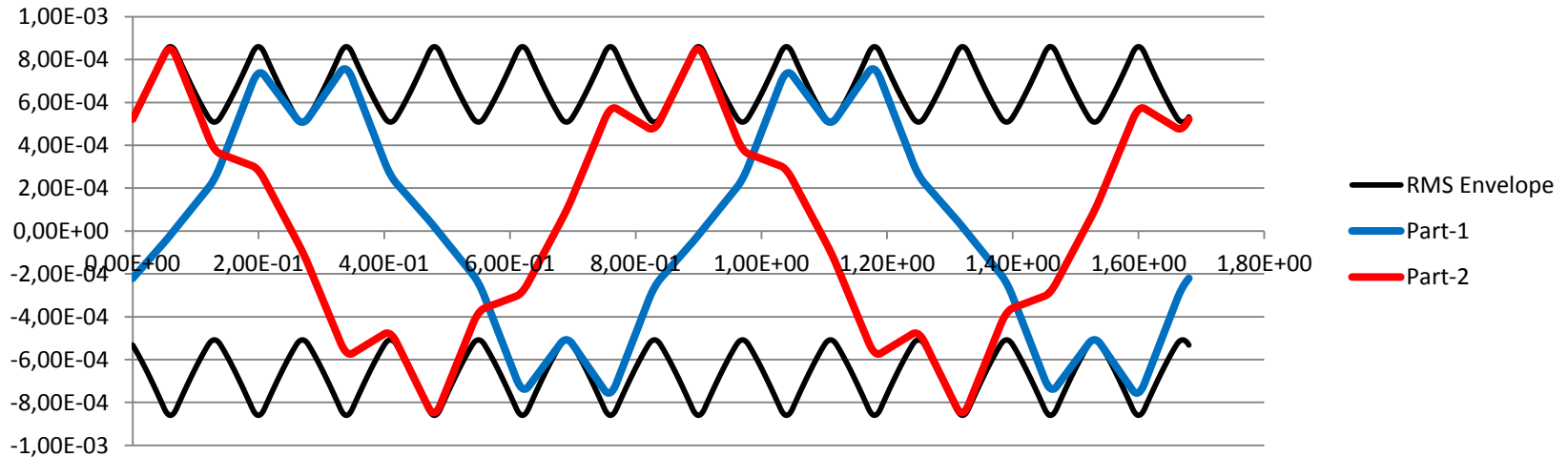

6 oscillations of the envelope before the particles are back at their initial positions.
 60° phase advance per period.

Transverse Phase advance

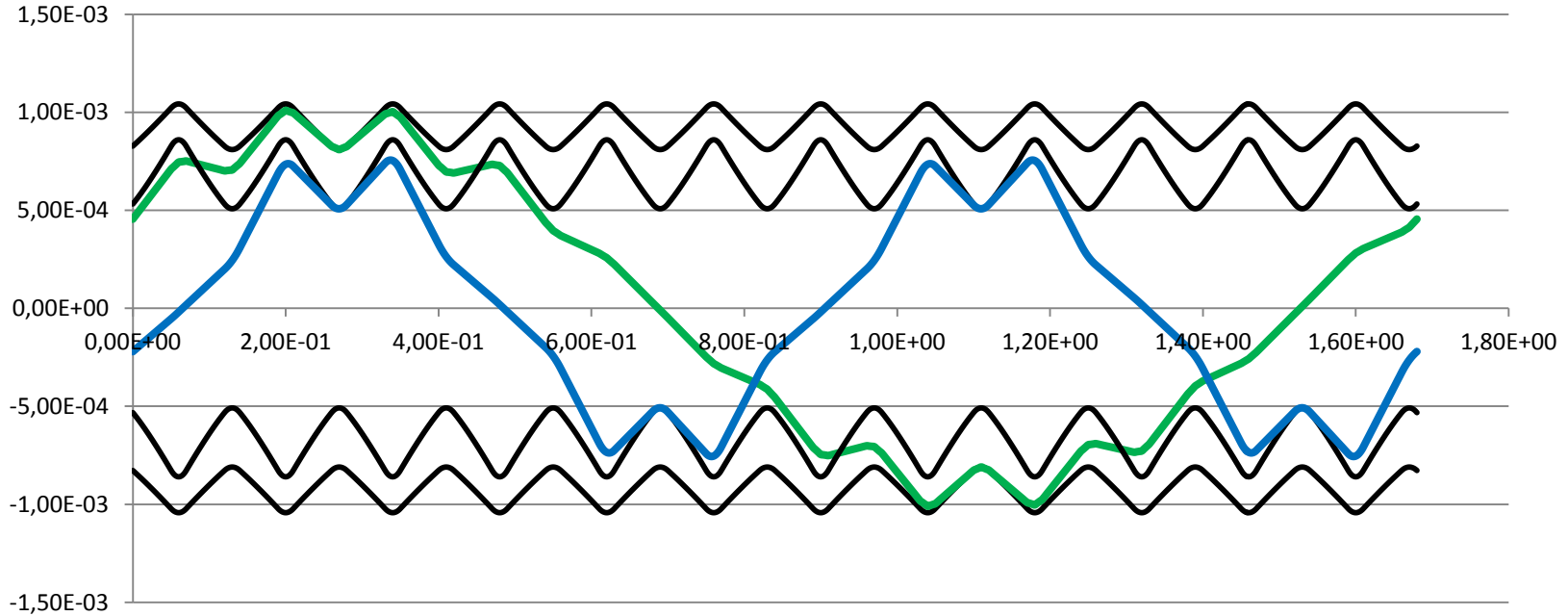

Same structure: 60° and 30° phase advance per period.

- Envelope is larger for smaller phase advance
- Particle oscillations twice slower : Blue - 60° , Green – 30° .

Transverse Phase advance

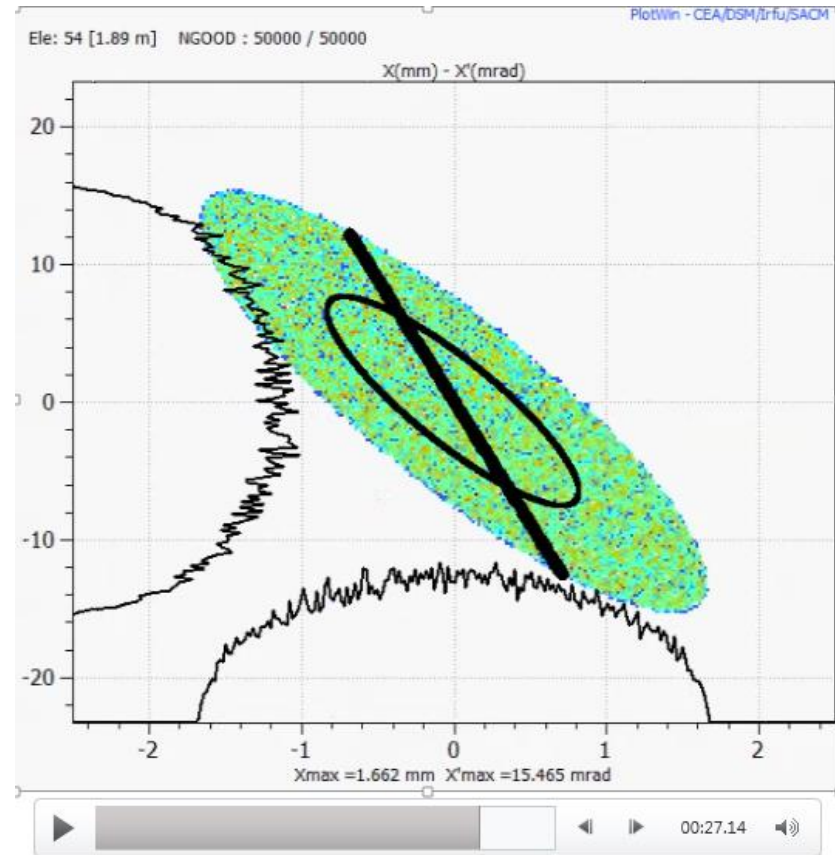
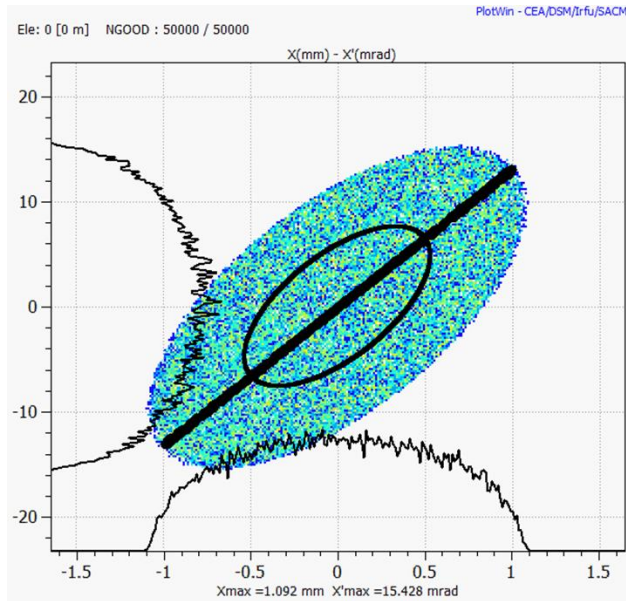

Video:

Ideal case, no RF defocusing, no space charge. Particles stay on a line.

RF defocusing

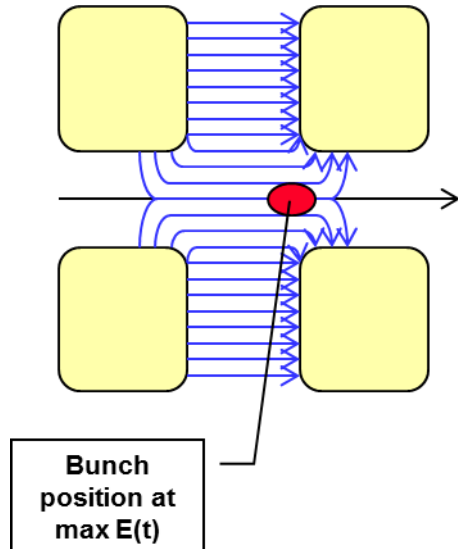

3 main reasons for RF defocusing
In order of importance

- The fields vary in time as the particles cross the gap.
- The fields acting on the particle depend on the radial particle displacement, which varies across the gap.
- The particle velocity increases while the particle crosses the gap, so that the particle does not spend equal times in each half of the gap.

A transverse defocusing force opposite to the quadrupole focusing.
The transverse phase advance per meter becomes:

Tutorial !

$$k_{ot} = \sqrt{\left(\frac{qGl}{2mc\beta\gamma}\right)^2 - \frac{\pi qE_0 T \sin(-\phi)}{mc^2 \lambda (\beta\gamma)^3}}$$

RF defocusing

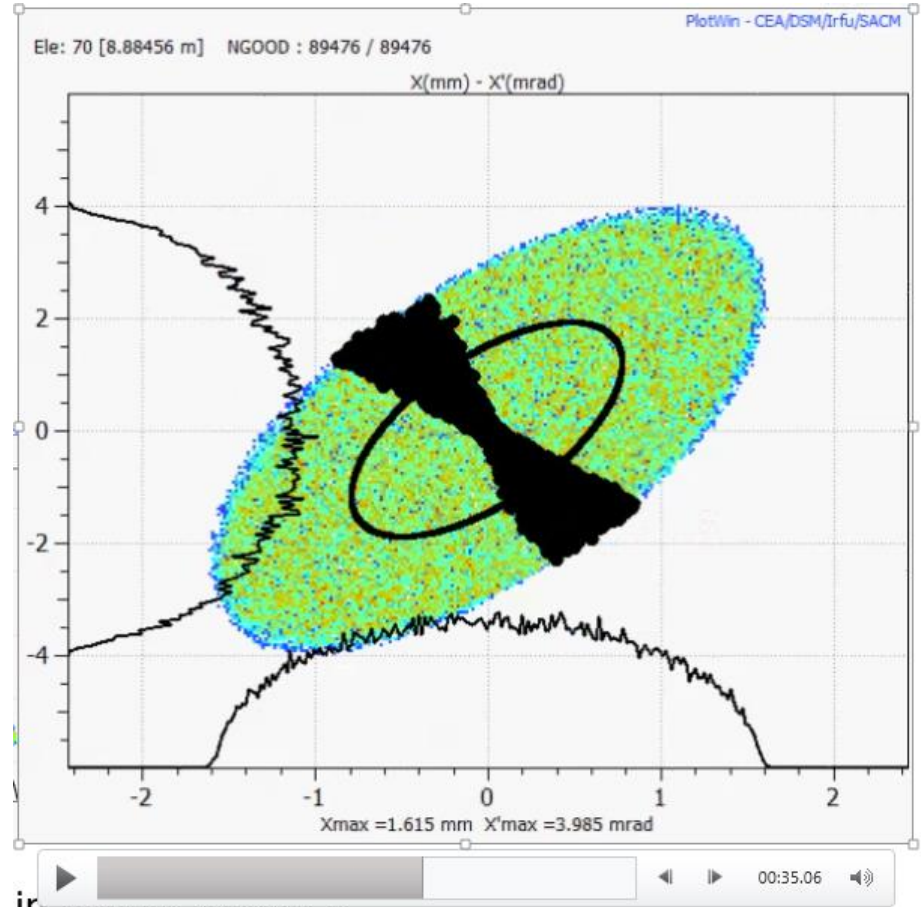
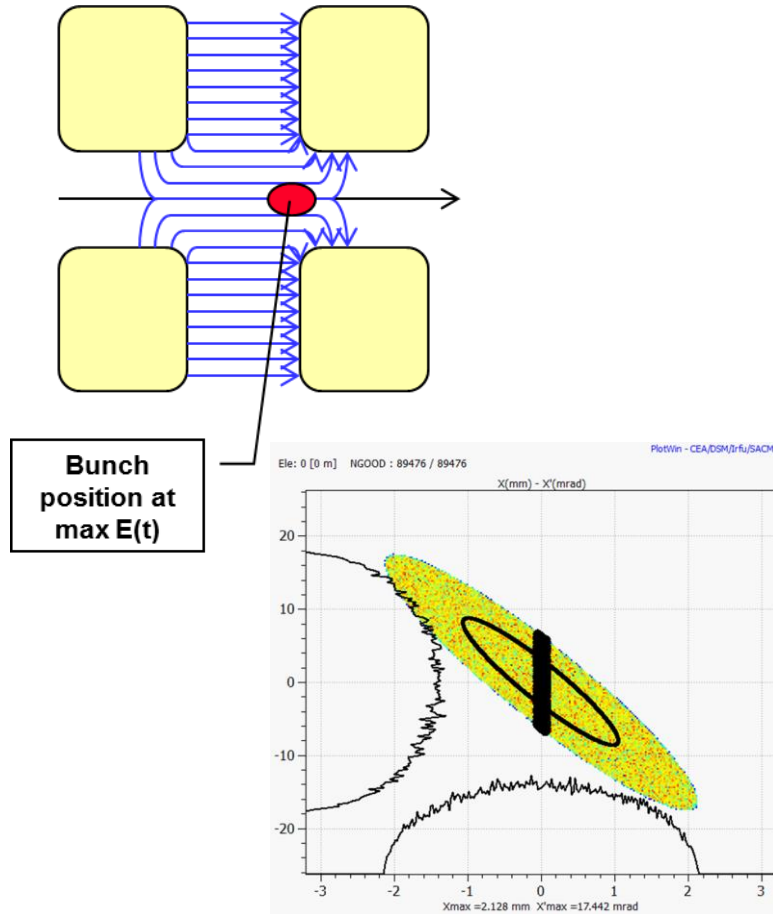

Video:
RF defocusing, no space charge. The line is a bit distorted.

One word on space charge



We have to keep into account the space charge forces when determining the transverse and longitudinal focusing.

Part of the focusing goes to counteract the space charge forces.

Assuming an uniformly charged ellipsoid:

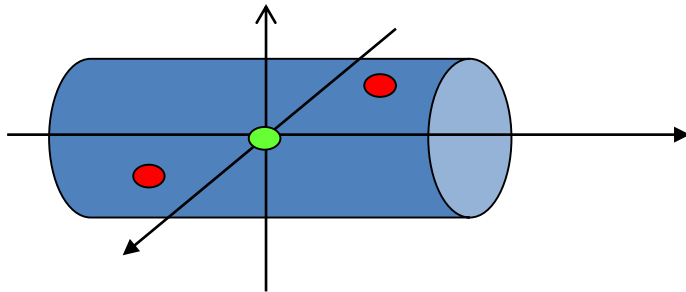

Effect is zero on the beam centre:
Contribution of red particles cancel out

$$E_x = \frac{1}{4\pi\epsilon_0} \frac{3I\lambda}{c\gamma^2} \frac{1-f}{r_x(r_x+r_y)r_z} x$$

$$E_y = \frac{1}{4\pi\epsilon_0} \frac{3I\lambda}{c\gamma^2} \frac{1-f}{r_y(r_x+r_y)r_z} y$$

$$E_z = \frac{1}{4\pi\epsilon_0} \frac{3I\lambda}{c} \frac{f}{r_x r_y r_z} z$$

The transverse phase advance per meter becomes:

I = beam current
 $r_{x,y,z}$ = ellipsoid semi-axis
 f = form factor
 Z_0 = free space impedance (377 Ω)

$$k_{ot} = \sqrt{\left(\frac{qGl}{2mc\beta\gamma}\right)^2 - \frac{\pi q E_0 T \sin(-\phi)}{mc^2 \lambda (\beta\gamma)^3} - \frac{3Z_0 q I \lambda (1-f)}{8\pi mc^2 \beta^2 \gamma^3 r_x r_y r_z}}$$

Transverse Phase Advance -SC



$$k_{ot} = \sqrt{\left(\frac{qGl}{2mc\beta\gamma}\right)^2 - \frac{\pi qE_0 T \sin(-\phi)}{mc^2 \lambda (\beta\gamma)^3} - \frac{3Z_0 q I \lambda (1-f)}{8\pi mc^2 \beta^2 \gamma^3 r_x r_y r_z}}$$

↑
↑
↑

Quadrupole focusing
RF Defocusing
Space Charge

Ratio of Phase advance with and without current along the Linac4 DTL:

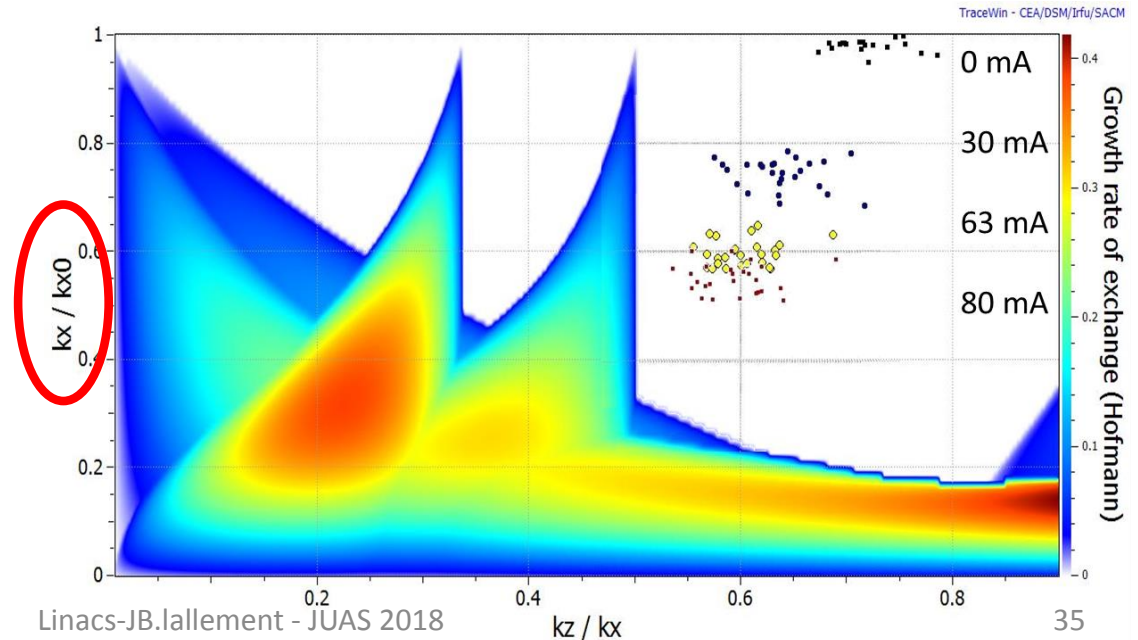

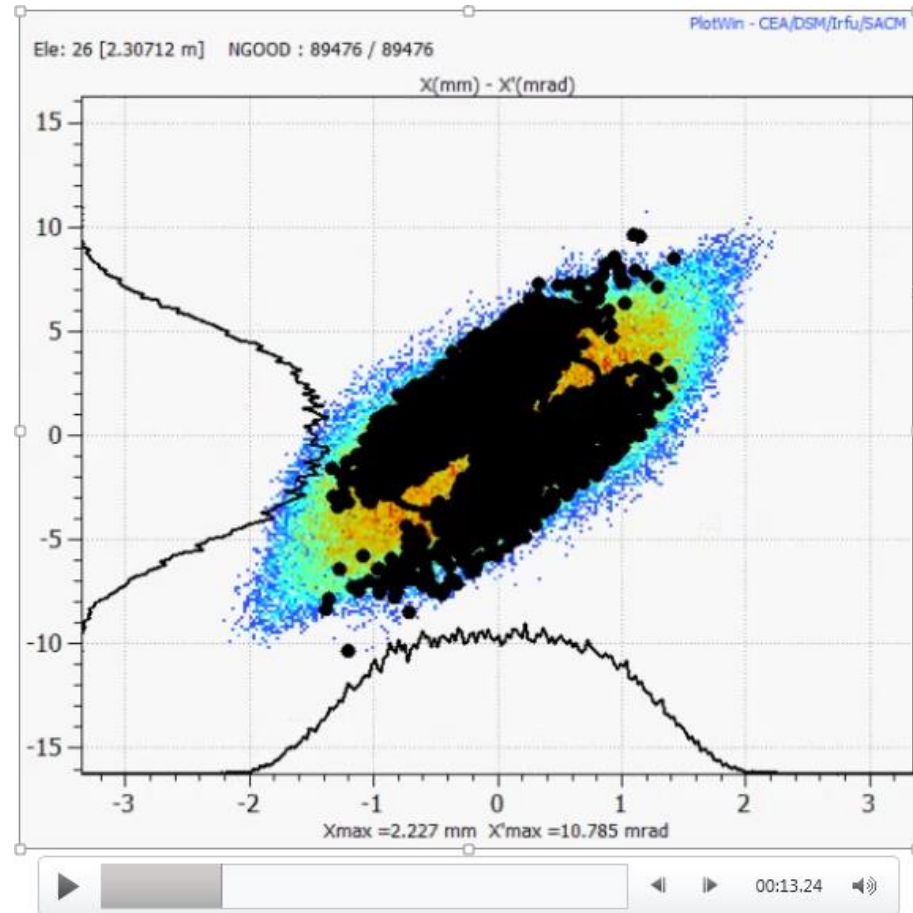
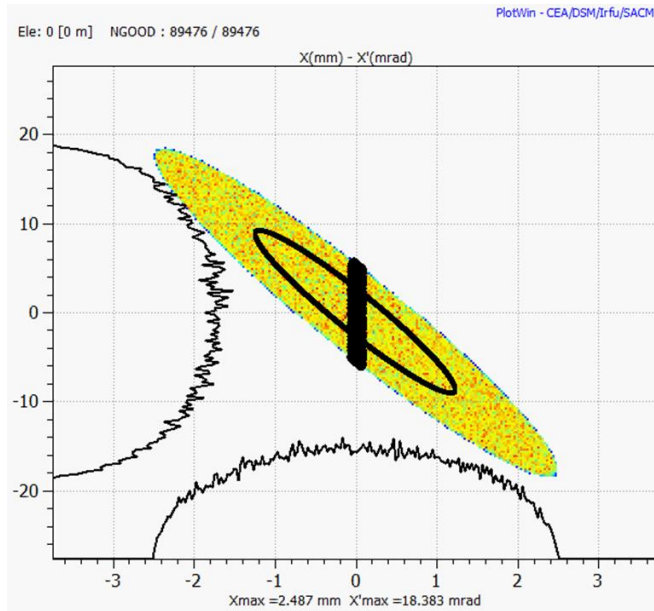

Video:

RF defocusing and space charge. Complete mixing of the particles. All the particles do not experience the same phase advance.

Non linear forces: Filamentation



- Velocity of rotation in the phase space without space charge does not depend on the amplitude (see movie).
- With non linear space charge, it does. Some areas of the phase space move at different velocities.

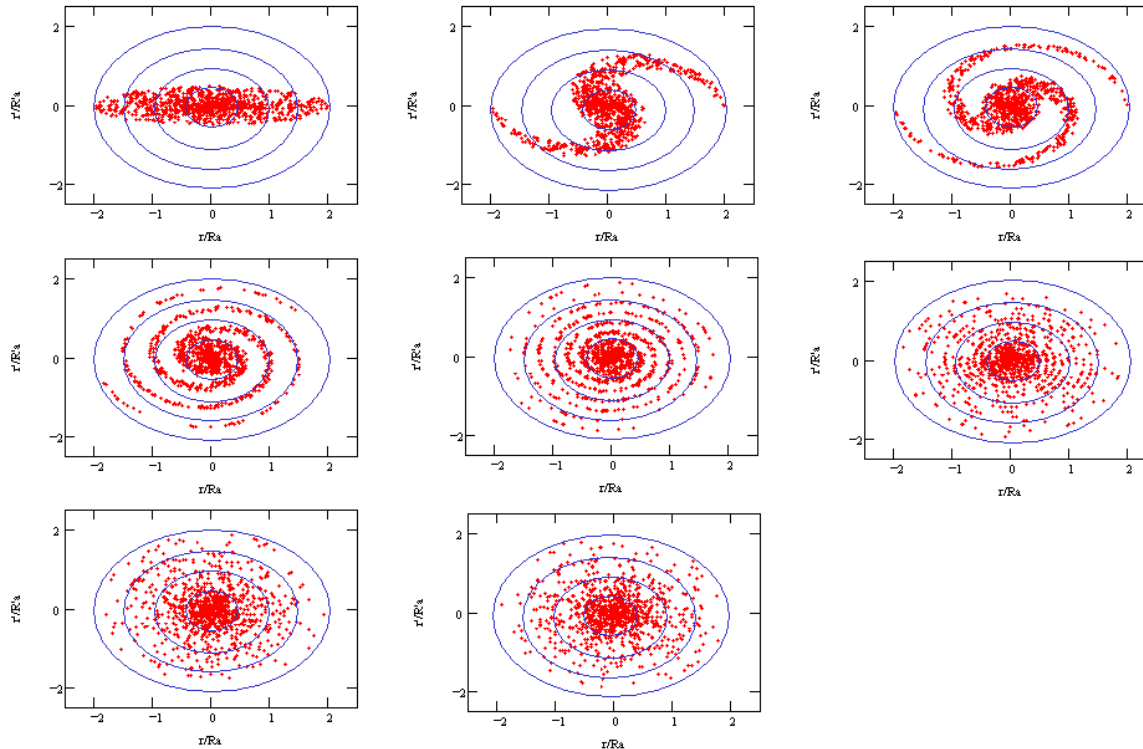

- This generate emittance growth.

Some design prescriptions



- Transverse phase advance at zero current not equal to 90° per period ($< 90^\circ$).
- Smooth variation of the phase advance (beam current independent).
- Avoid resonances.

Ex. Linac4 DTL design.

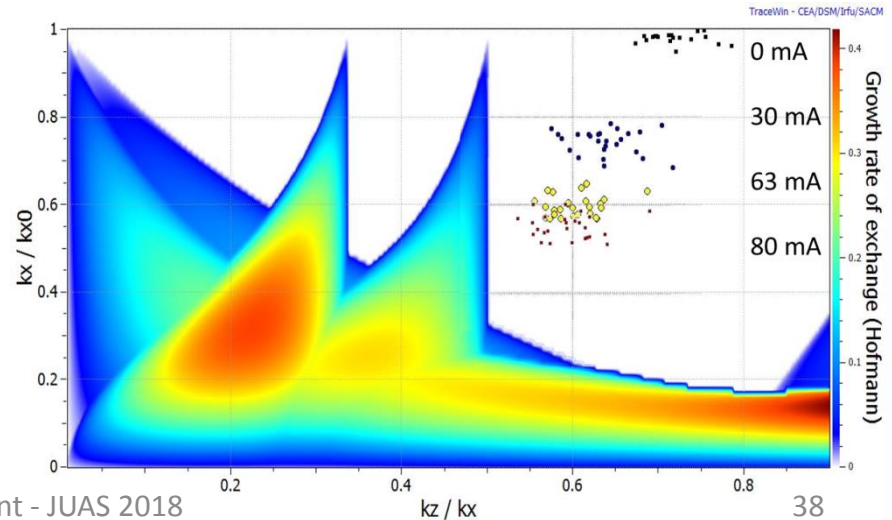
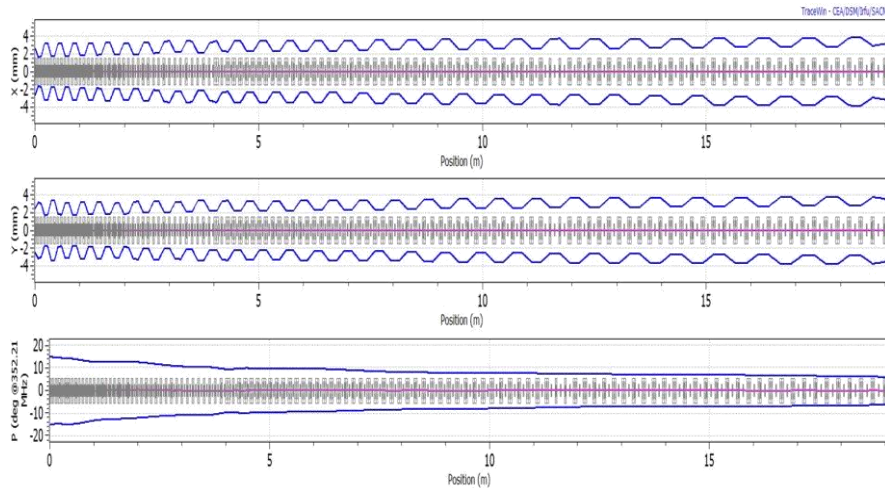
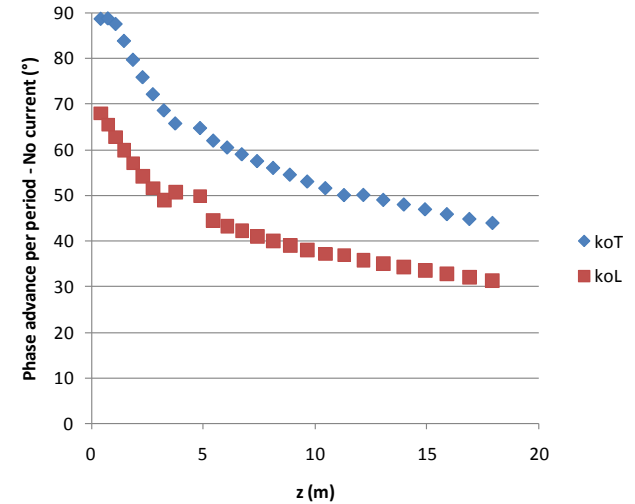

Summary of Part.3



- Transverse and longitudinal focusing
- Bunching
- Beam phase space / Emittance ellipse
- Phase advance
- Focusing channel
- RF defocusing
- Space charge