

Overview of the CERN Accelerator Complex

CERN Lab 1954

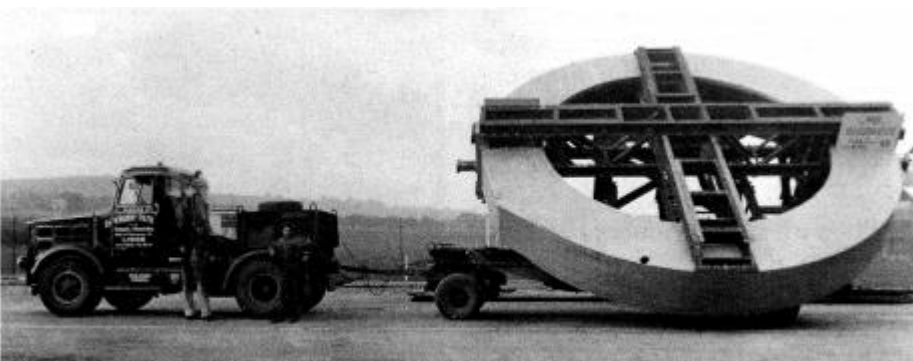

1957: Synchrocyclotron → 600 MeV, 15.7 m, 33 years of operation



1952: Geneva selected by the provisional Council as site for CERN
1953: approved by referendum in Canton Genève
1954: the first shovel of earth was dug on the Meyrin site

JUAN 2015 - 12 January 2015

Reyes Alemany, Beams Department, CERN

CERN Lab 2018

8

JURA

CMS

ALICE

SPS
ATLAS

LHCb

BOOSTER PS

~ 70 000 m of accelerators (including transfer lines)

LEM
GENEVA

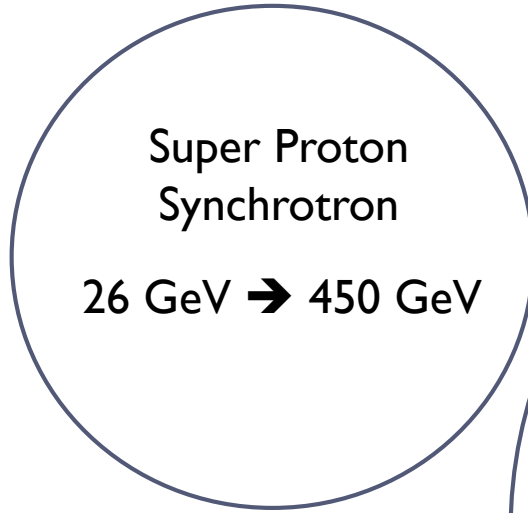
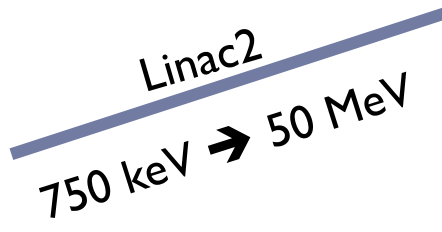
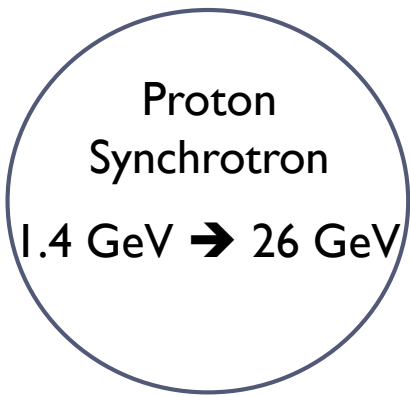

90 keV → 750 keV

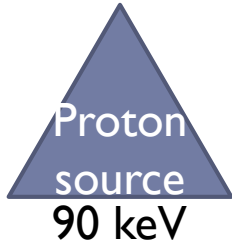
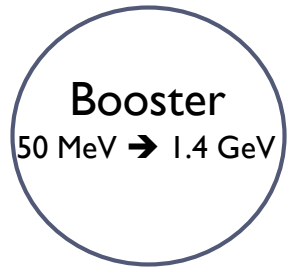

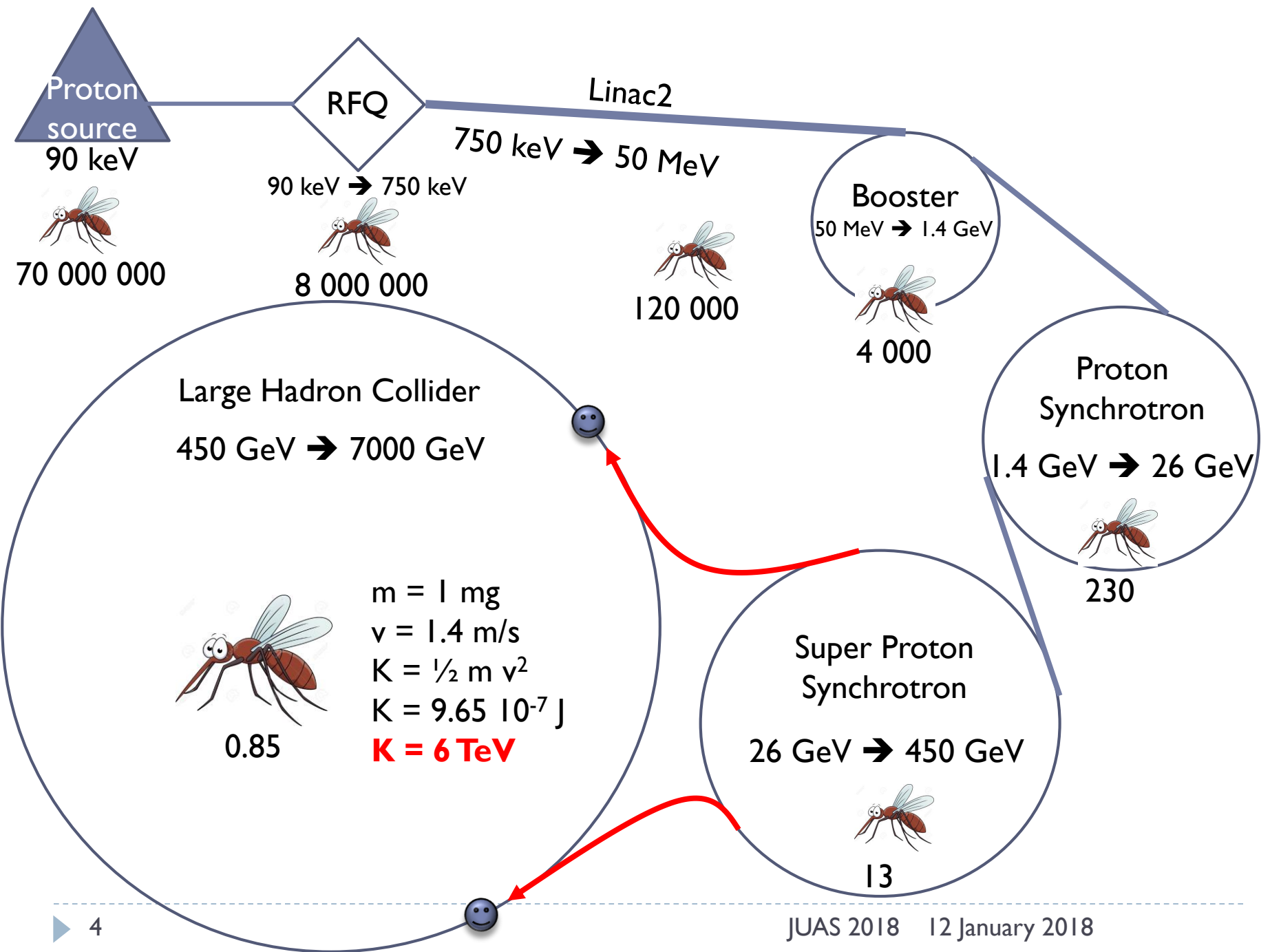

PS accelerator complex

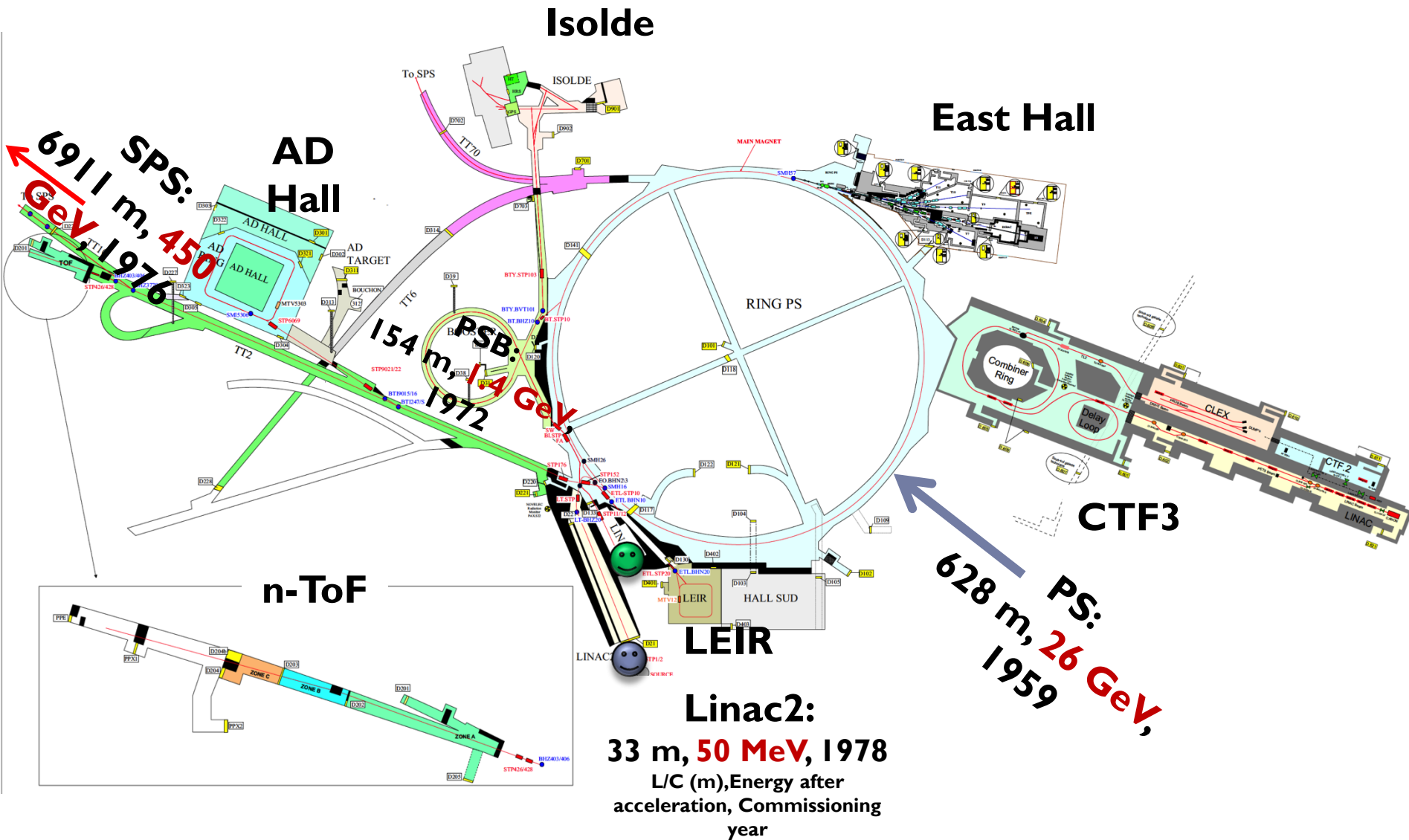

The Proton Beam Starts Here ...

- The source cage houses the HV platform at 90 kV.



Duoplasmatron Proton Source

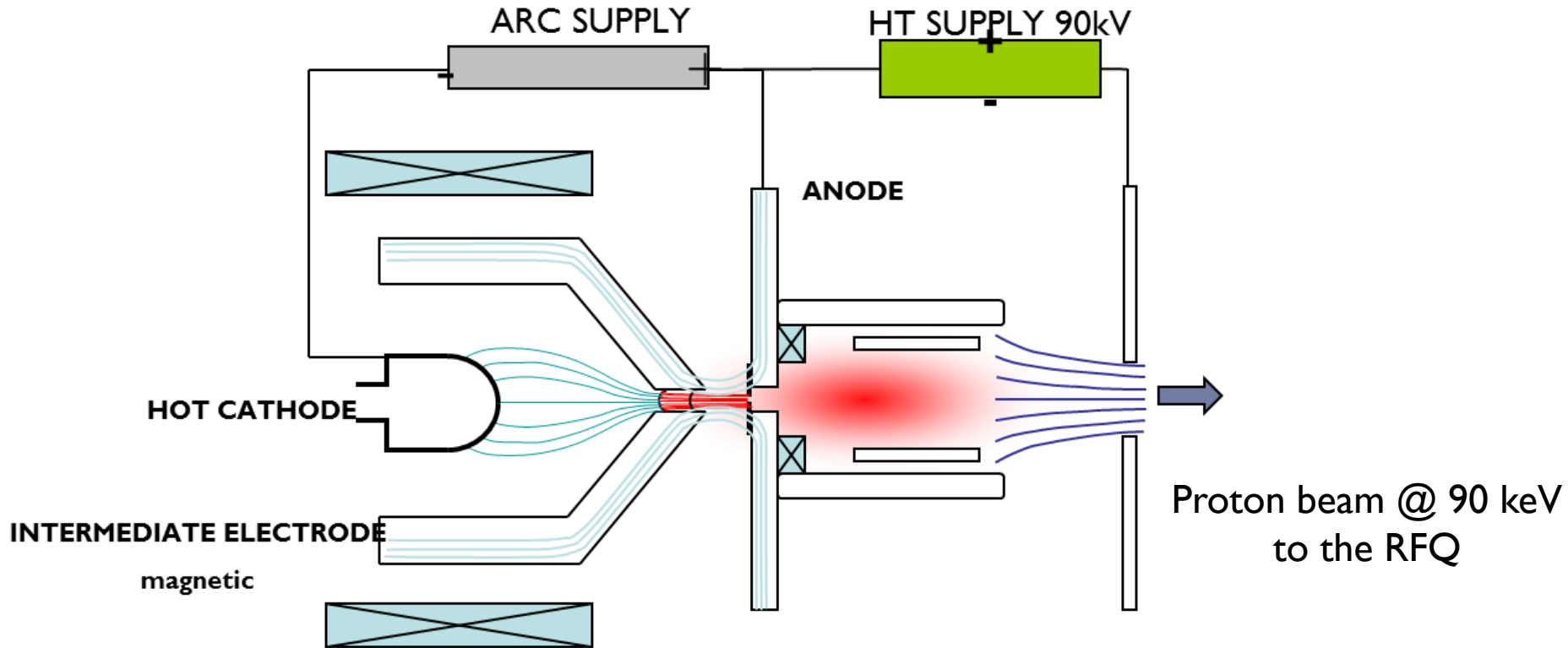

Protons (at 90 keV) are produced by creating a plasma using H_2 which is charged due to interaction with free electrons from the cathode. The plasma is then accelerated and becomes an ion beam.

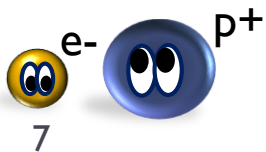

Duoplasmatron Proton Source

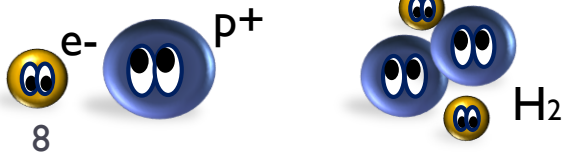
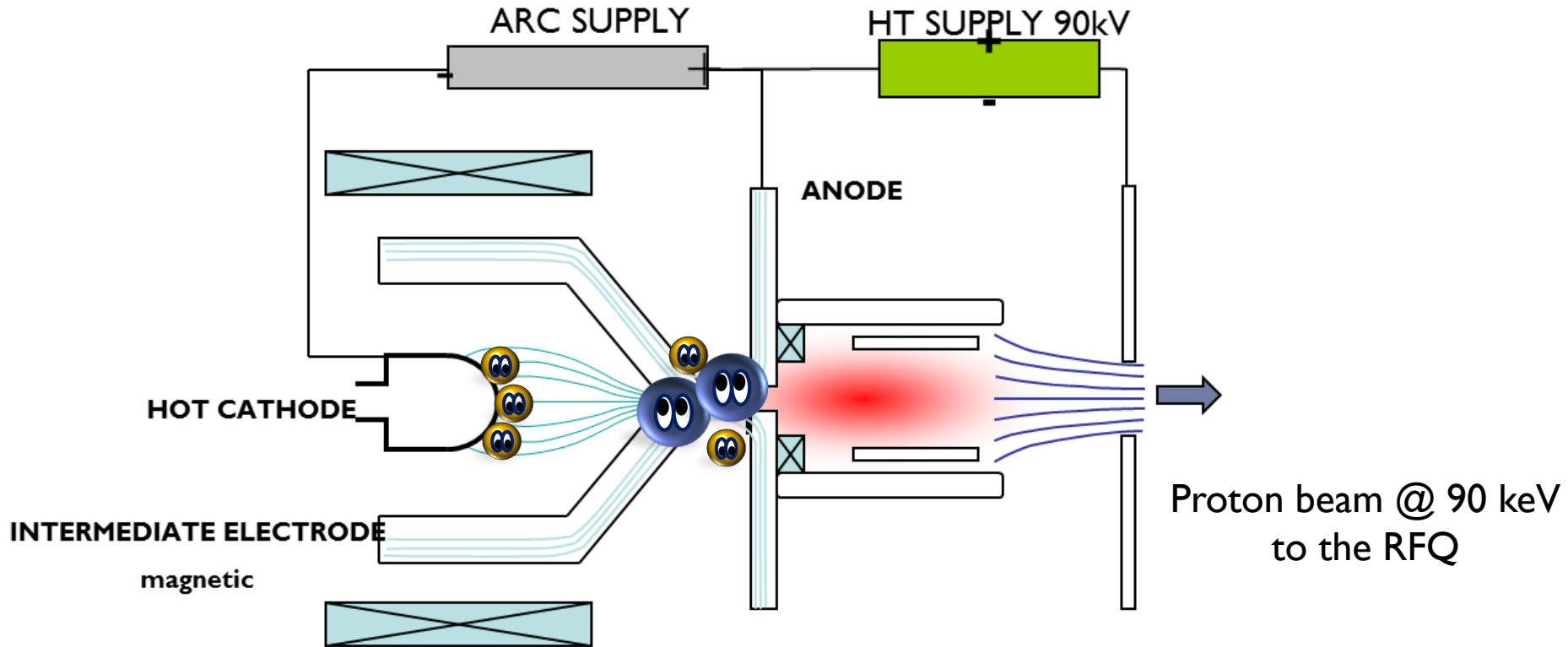

Protons (at 90 keV) are produced by creating a plasma using H_2 which is charged due to interaction with free electrons from the cathode. The plasma is then accelerated and becomes an ion beam.

Radio Frequency Quadrupole

- RFQ is a linear accelerator that **FOCUSES, BUNCHES & ACCELERATES** with **HIGH EFFICIENCY** (90% w.r.t. 50% of conventional accelerators) and **PRESERVES THE EMITTANCE**
- The whole beam dynamics depends upon the shape of the vane tips

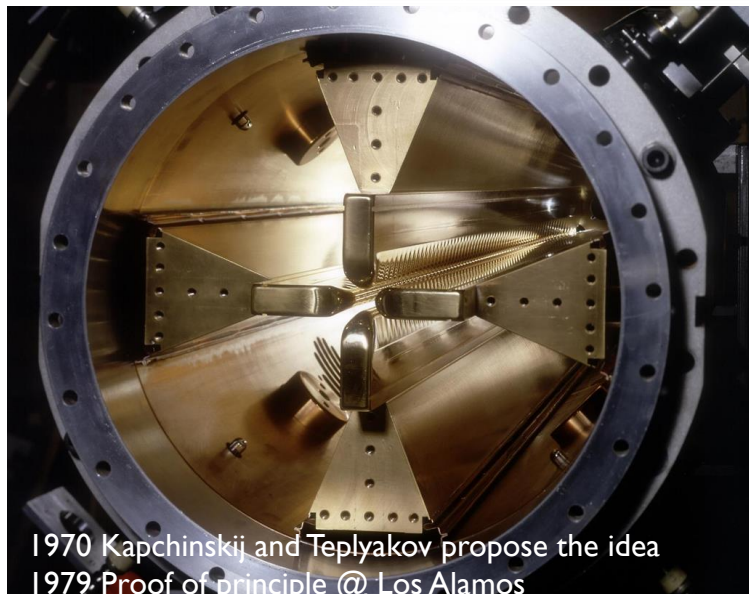
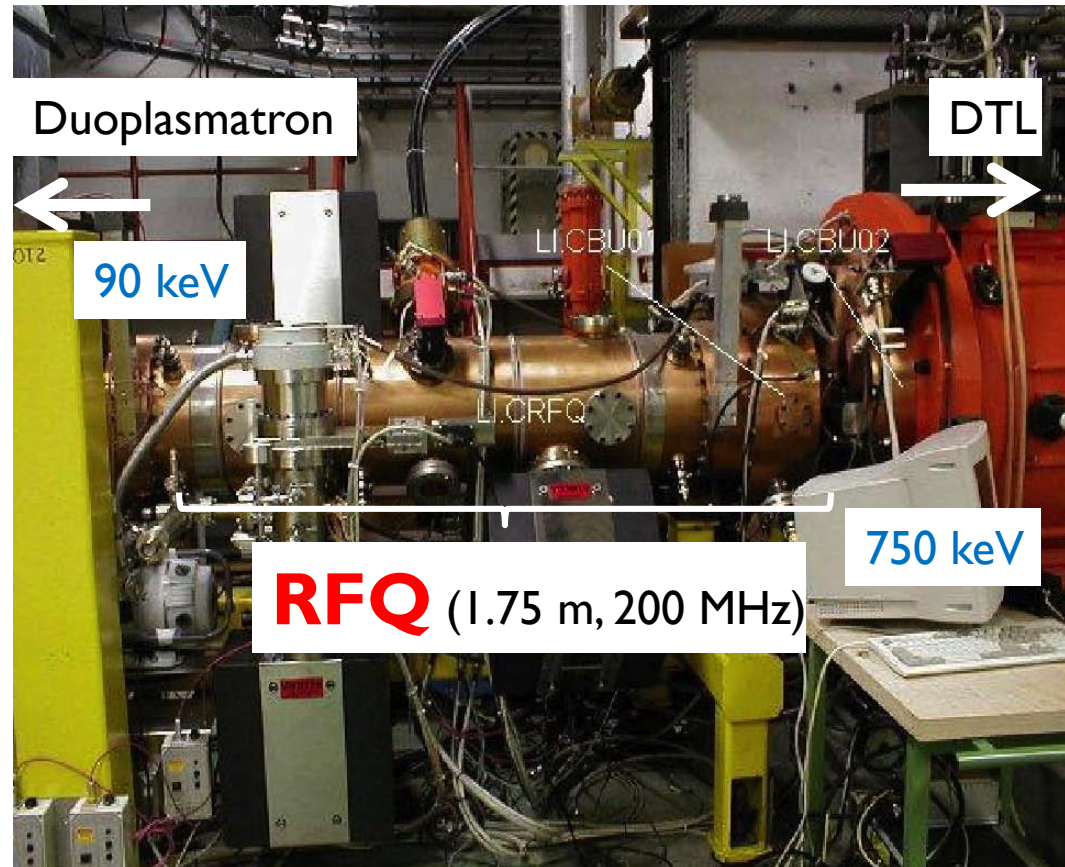
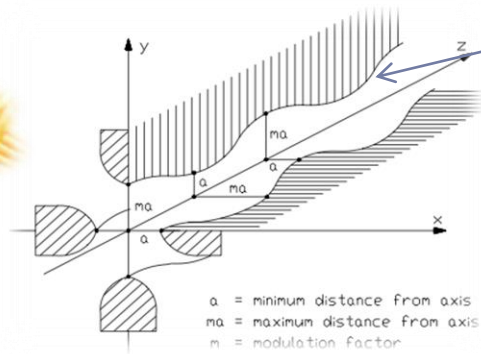
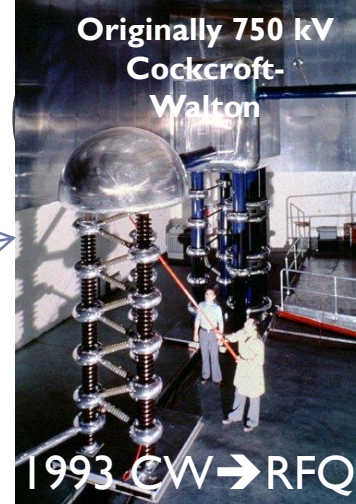

Linac 2



DTL (Alvarez structure 1945)

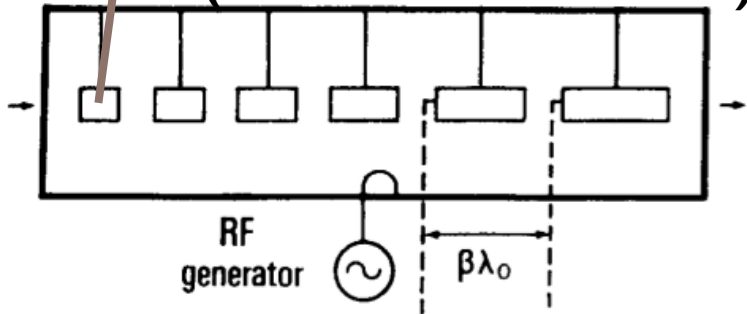

Drift tubes and spacing become larger as the energy increases
Focusing quads inside drift tubes

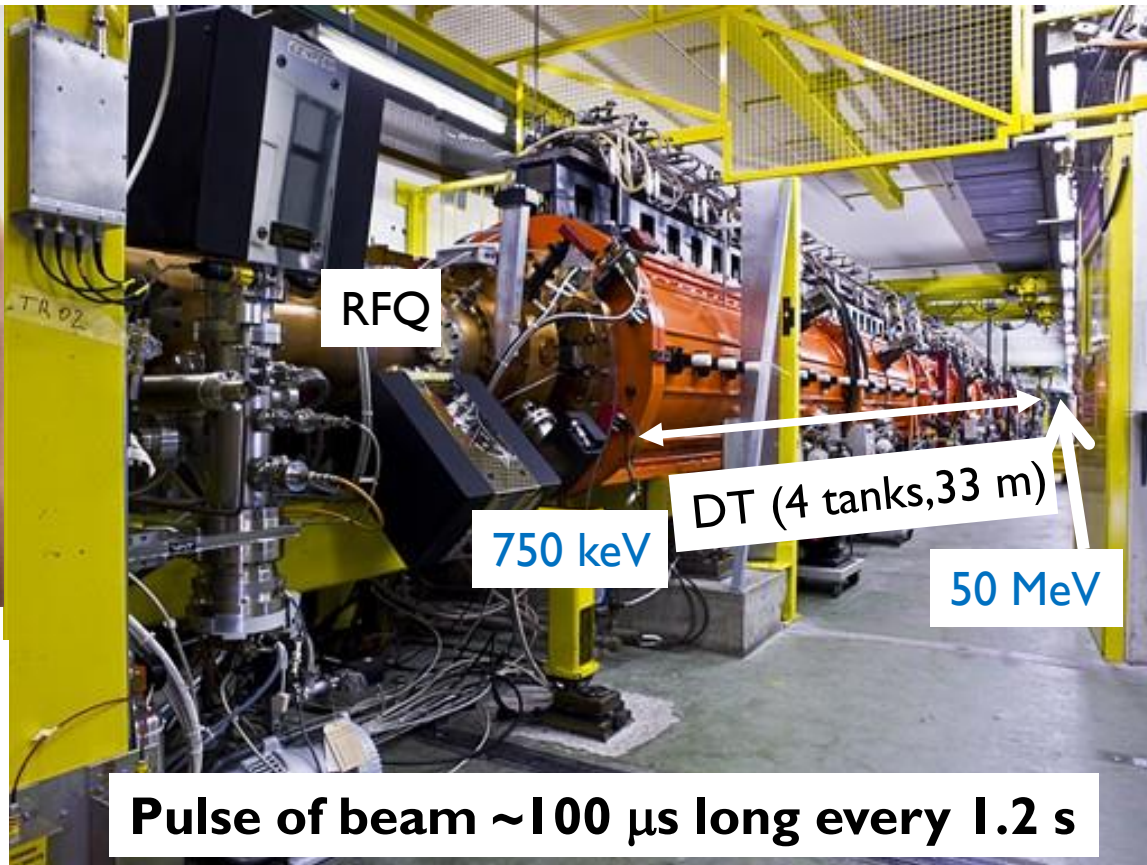

Pulse of beam $\sim 100 \mu\text{s}$ long every 1.2 s

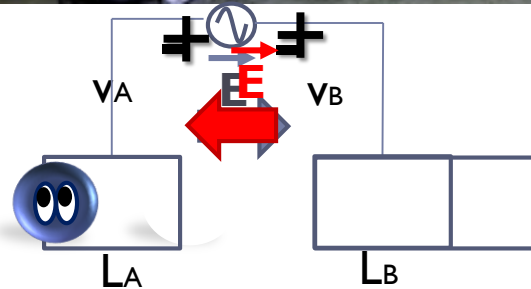

$$V_A < V_B \rightarrow L_B > L_A$$

$$\rightarrow L = v T_{\text{rf}} = \beta_{\text{rel}} \lambda_0$$

PS Booster

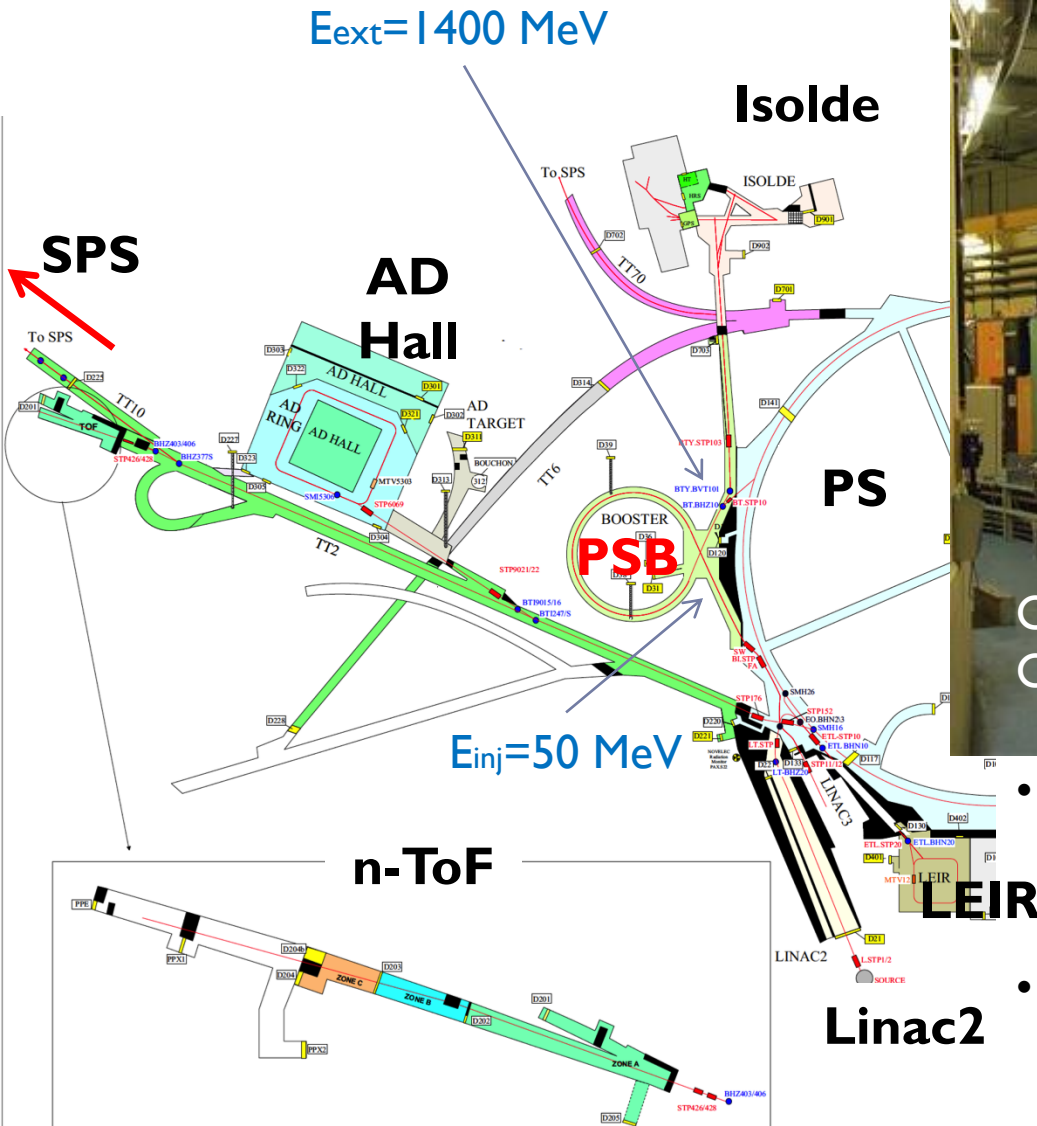

C = 154 m
Commissioned in 1972

- **Synchrotron with 4 vertically stacked rings, each 1/4 of PS Circumference**
- **Duty cycle 1.2 s → two cycles needed to fill the PS with protons for LHC**

Proton Synchrotron (PS)

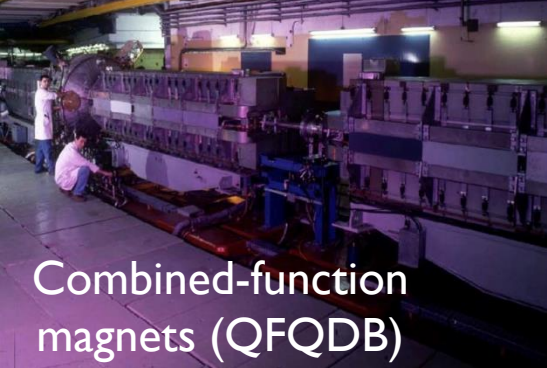

Combined-function magnets (QFQDB)

oldest functioning machine at CERN
the first Alternating Gradient Machine!

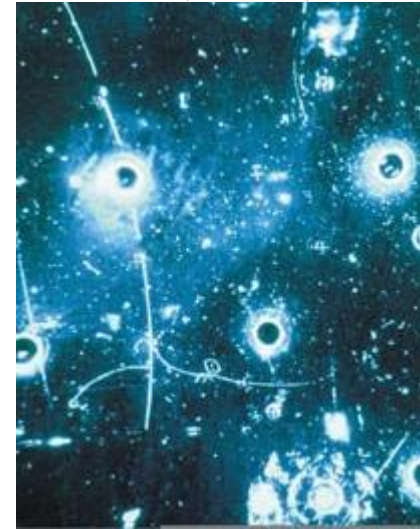

1970-1976



GARGAMELLE

First evidence of weak neutral currents (Z^0)

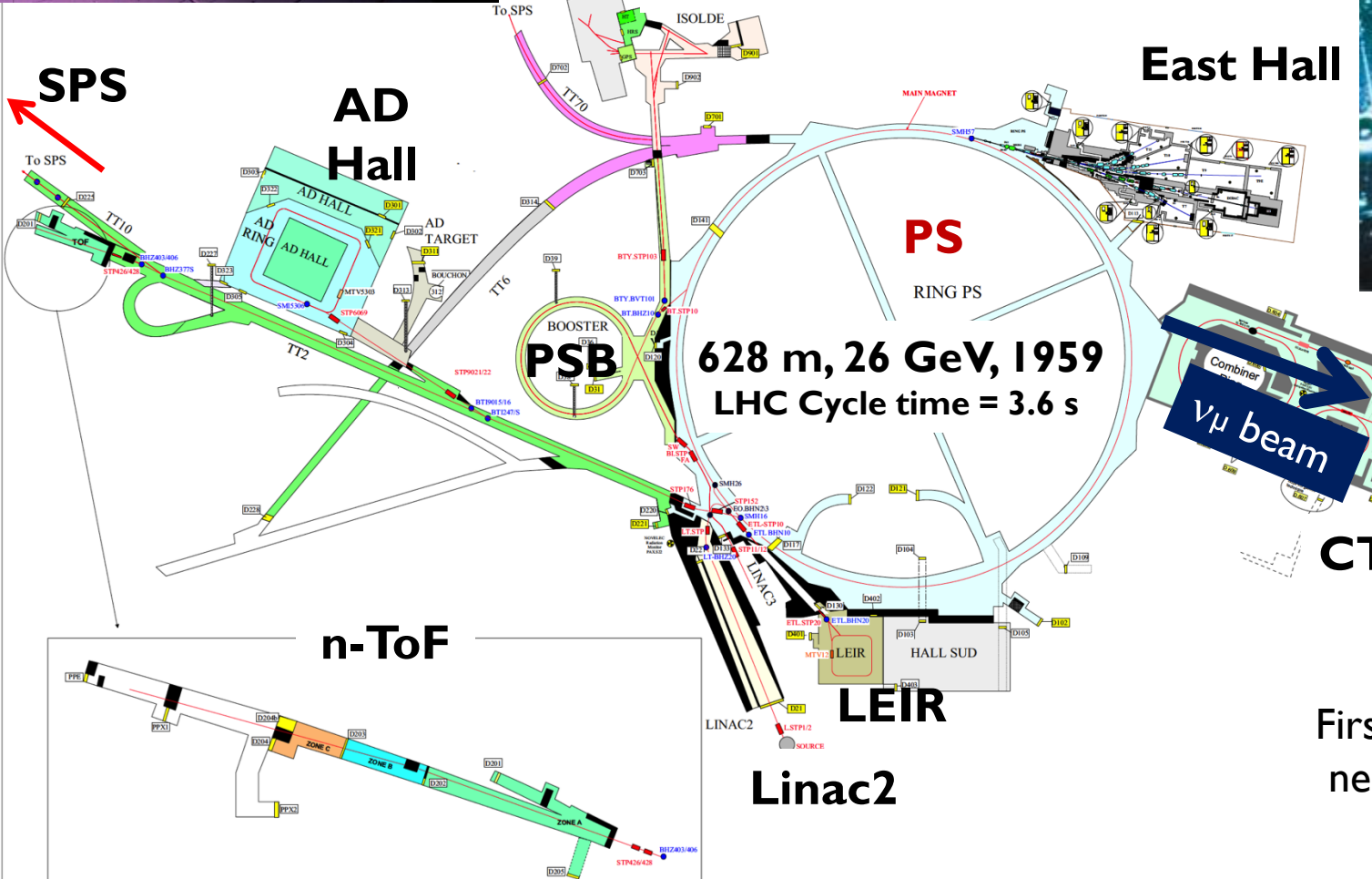

Proton Synchrotron (PS)

BOOSTER (1.4 GeV) → PS (26 GeV) → SPS (450 GeV) → LHC

BOOSTER (4 rings)

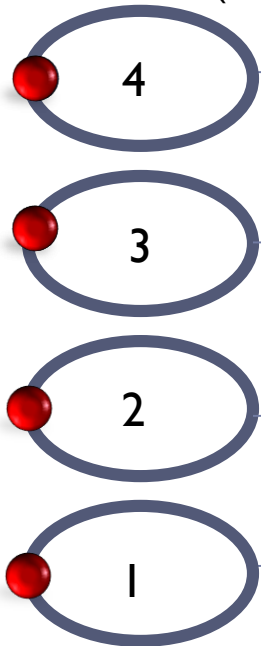

$h=1$

Two injections from
BOOSTER to PS
(2 x 1.2 s)

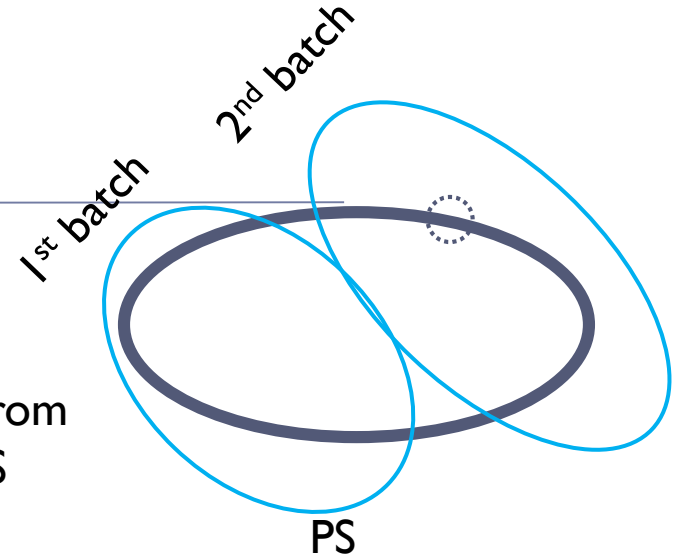

$h=7$ (6 buckets filled + 1 empty)

All operational beams cross **transition**
(Transition energy 6.1 GeV)

Proton Synchrotron (PS)

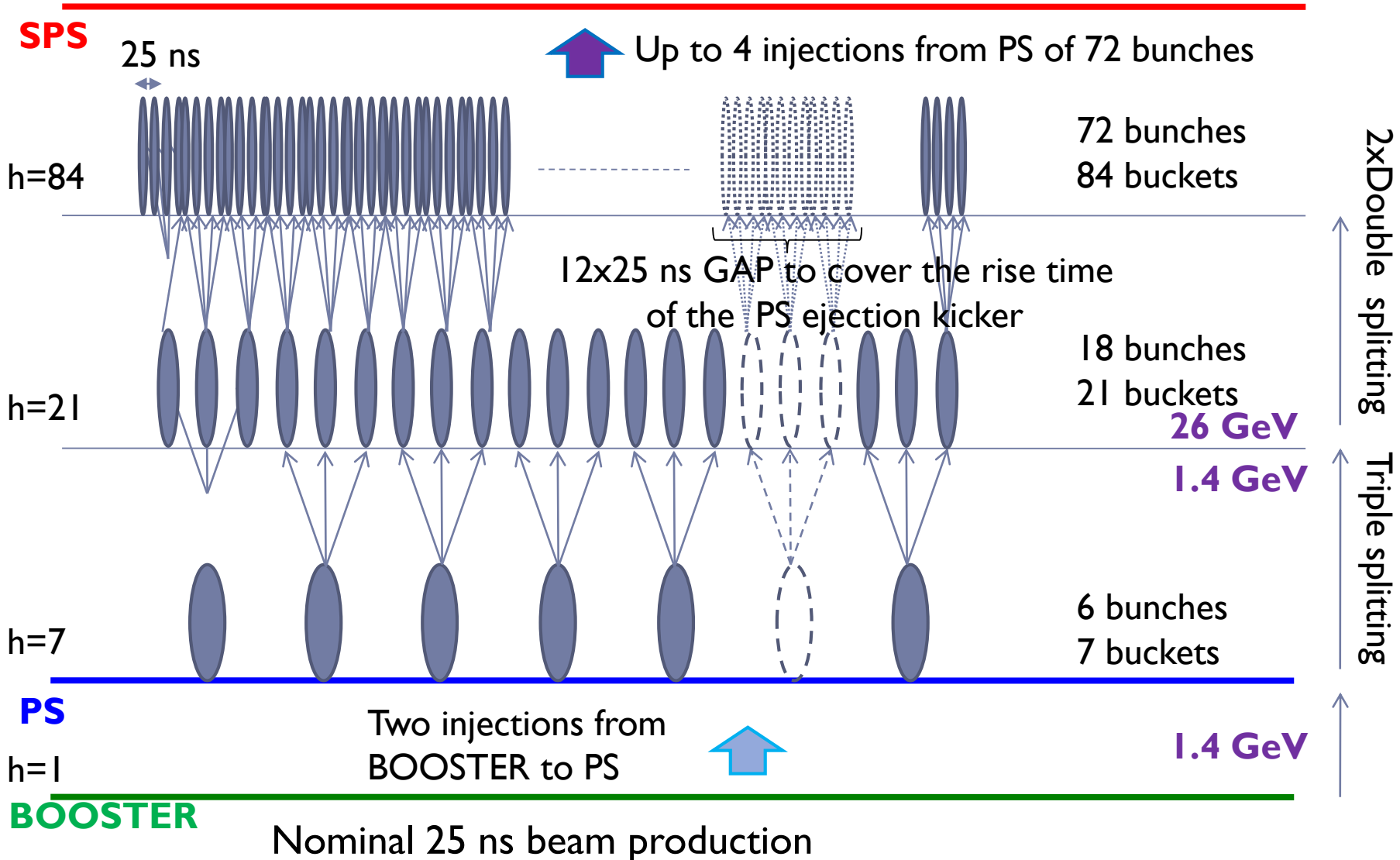

Super Proton Synchrotron (SPS)

North area

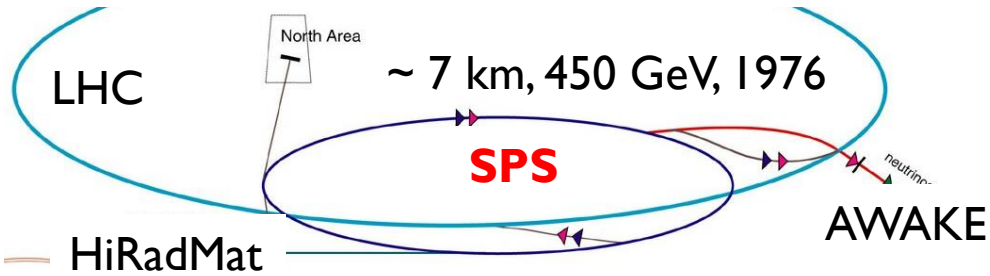

Sp \bar{p} S



- has probed the inner structure of protons
- investigated matter antimatter asymmetry
- searched for exotic forms of matter

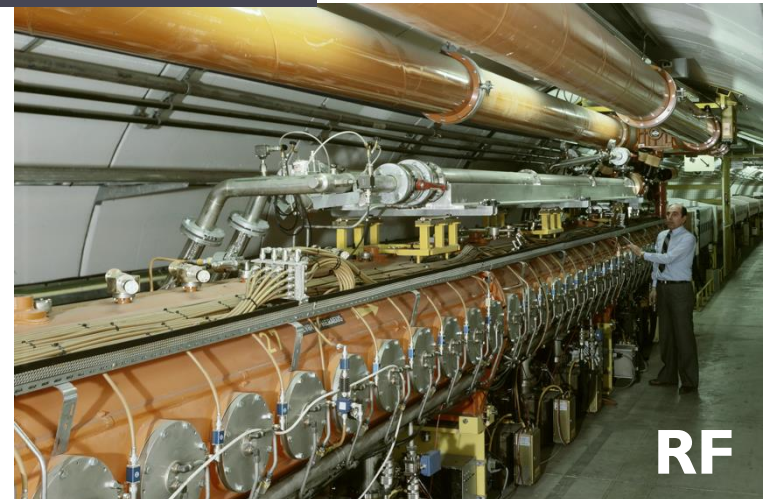
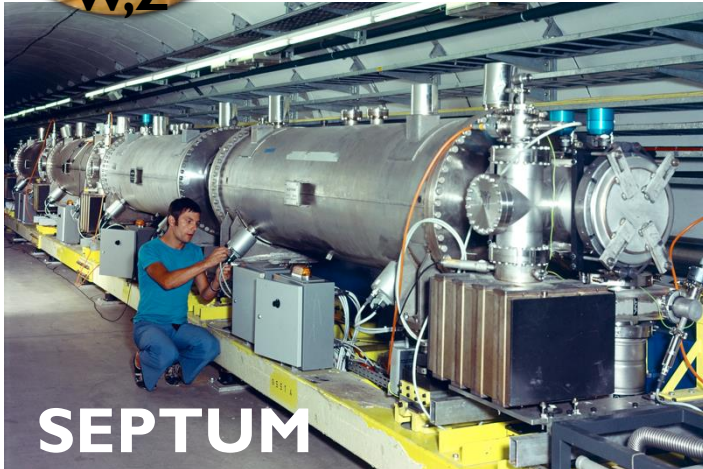

Fast cycle machines E.g. SPS

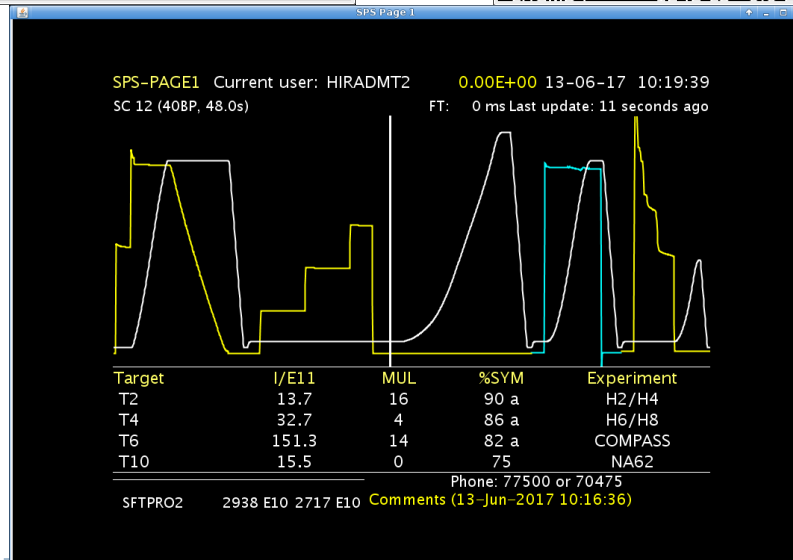
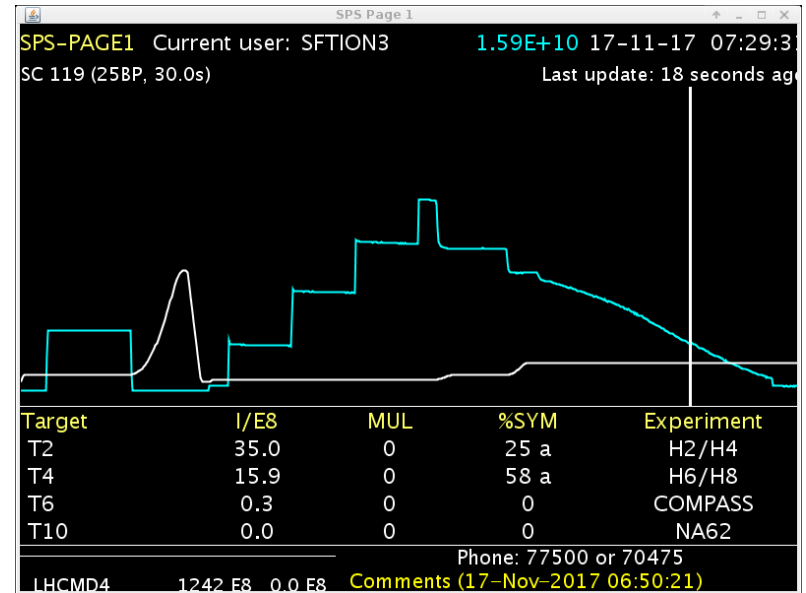
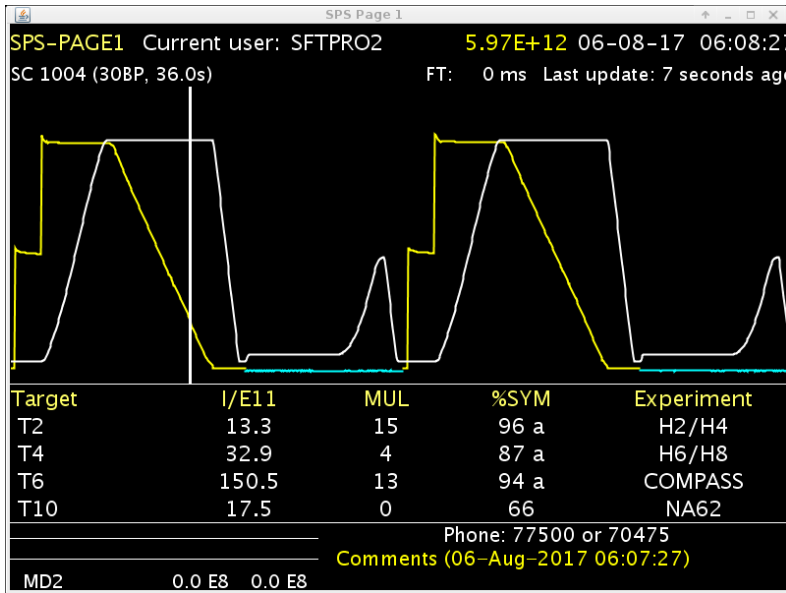

Large Hadron Collider (LHC)

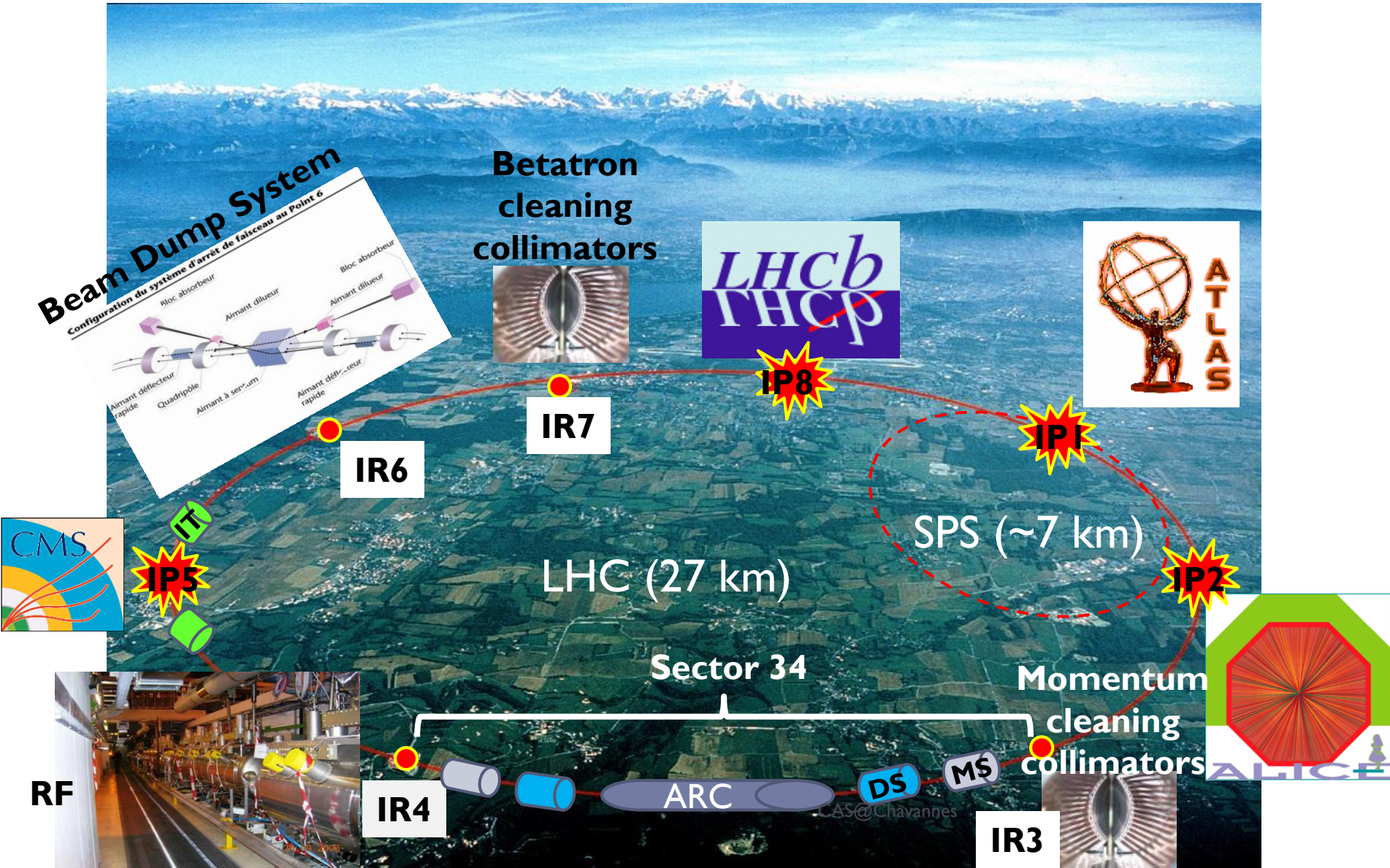

Large Hadron Collider (LHC)

Geometry of the main dipoles

(Total of 1232 cryodipoles)



LHC DIPOLE : STANDARD CROSS-SECTION

13894 AL-CD-AM - PB 137 - 9894 000

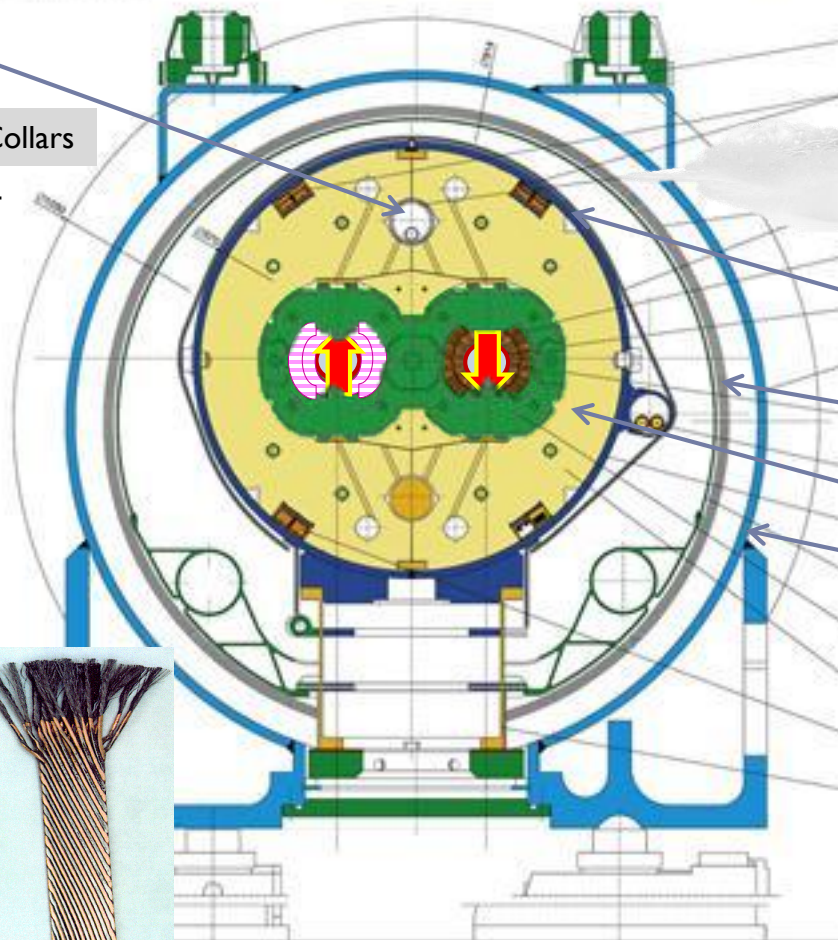

Heat exchanger

Beam pipe (Ultrahigh beam vacuum 10^{-10} Torr like at 1000 km over sea)

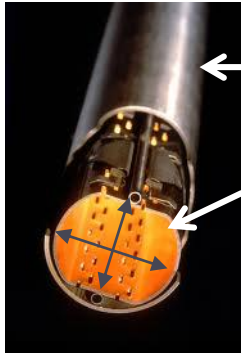

Cold bore non-magnetic austenitic steel
Beam Screen (Stainless Steel + Cu)
36.9 mm
46.5 mm

Collars

He Vessel

Thermal shield

Iron yoke

Vacuum vessel (10^{-6} mbar)

Superconducting coils

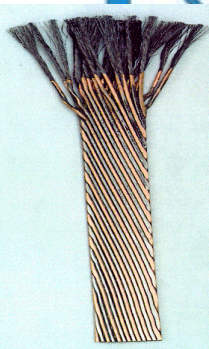
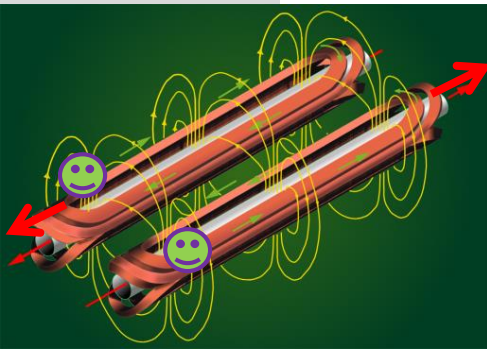

L ~ 15 m
8.3 T, 11.87 kA
T = 1.9 K, ~27.5 ton

Large Hadron Collider (LHC)

LHC arc cells = FoDo lattice* with
 $\sim 90^\circ$ phase advance per cell in the V & H plane

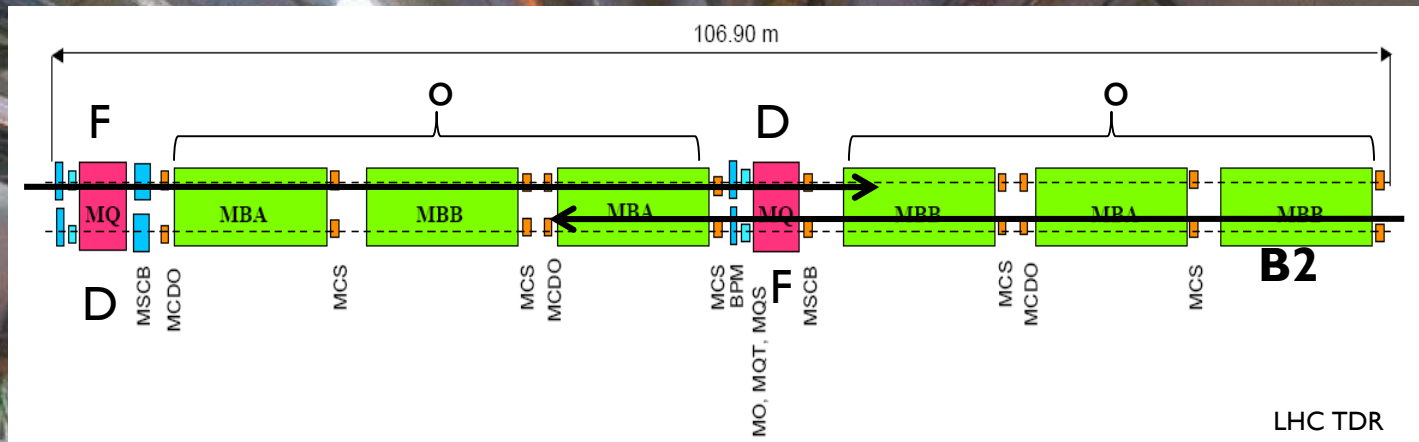

- MB:** main dipole
- MQ:** main quadrupole
- MQT:** Trim quadrupole
- MQS:** Skew trim quadrupole
- MO:** Lattice octupole (Landau damping)
- MSCB:** Skew sextupole + Orbit corrector (lattice chroma+orbit)
- MCS:** Spool piece sextupole
- MCDO:** Spool piece octupole + Decapole
- BPM:** Beam position monitor

Integrated Performance

- ATLAS / CMS : 50 fb^{-1}
 - LHCb: 2 fb^{-1}
 - ALICE: $19 \mu\text{b}^{-1}$
- } 2017
- The total integrated luminosity since the start of LHC is approaching 125 fb^{-1}

Beyond expectations

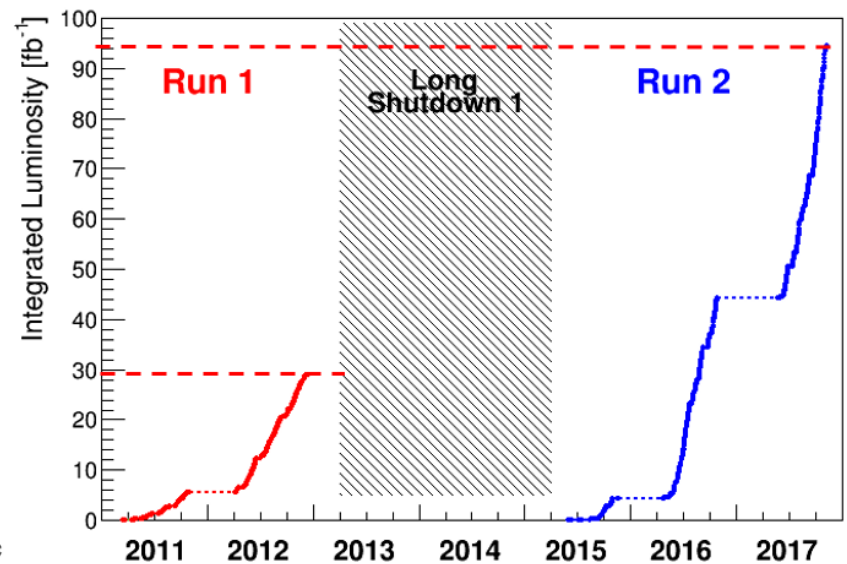
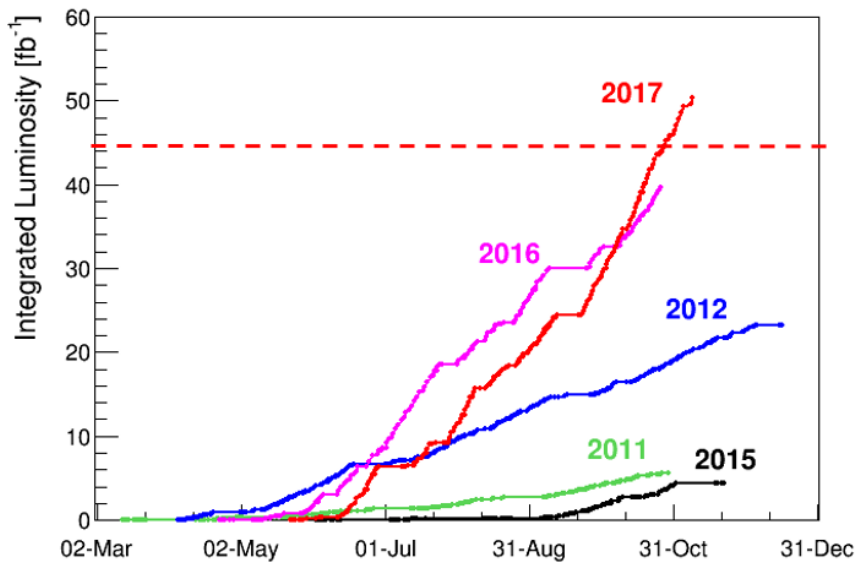

Ion Chain

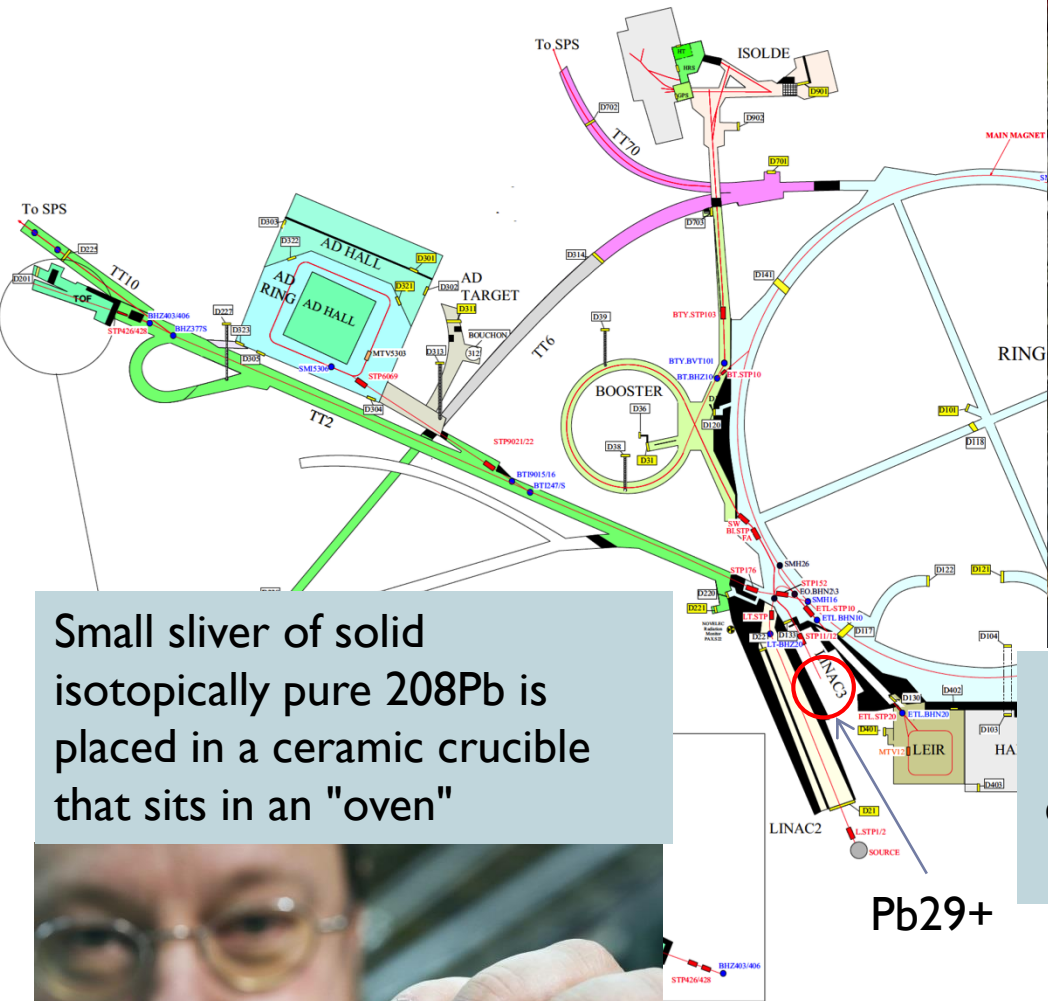
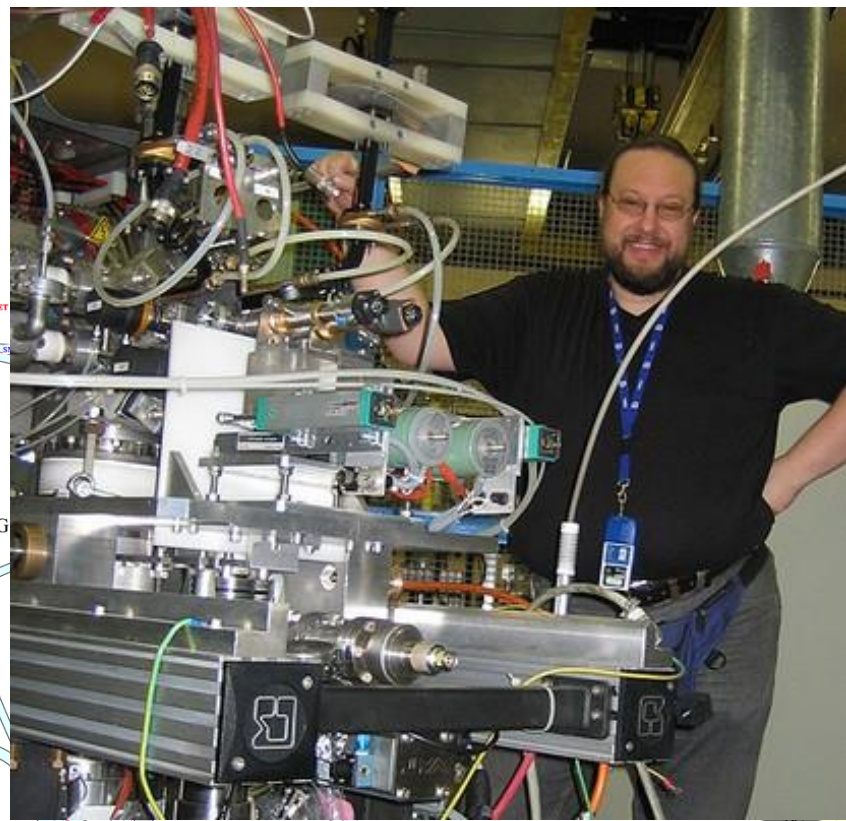

Small sliver of solid isotopically pure ^{208}Pb is placed in a ceramic crucible that sits in an "oven"

The metal is heated to around 800°C and ionized to become plasma. Ions are then extracted from the plasma and accelerated up to 2.5 keV/nucleon .



Pb29+

The source can also be set up to deliver other species...
Ar and Xe

Linac 3

Stripping foil Pb29+ → Pb54+
Stripping Efficiency is 20%

Interdigital-H (IH) linac
4.2 MeV/nucleon

RFQ

Pb29+ 2.5 keV/nucleon

Spectrometer to select Pb29+

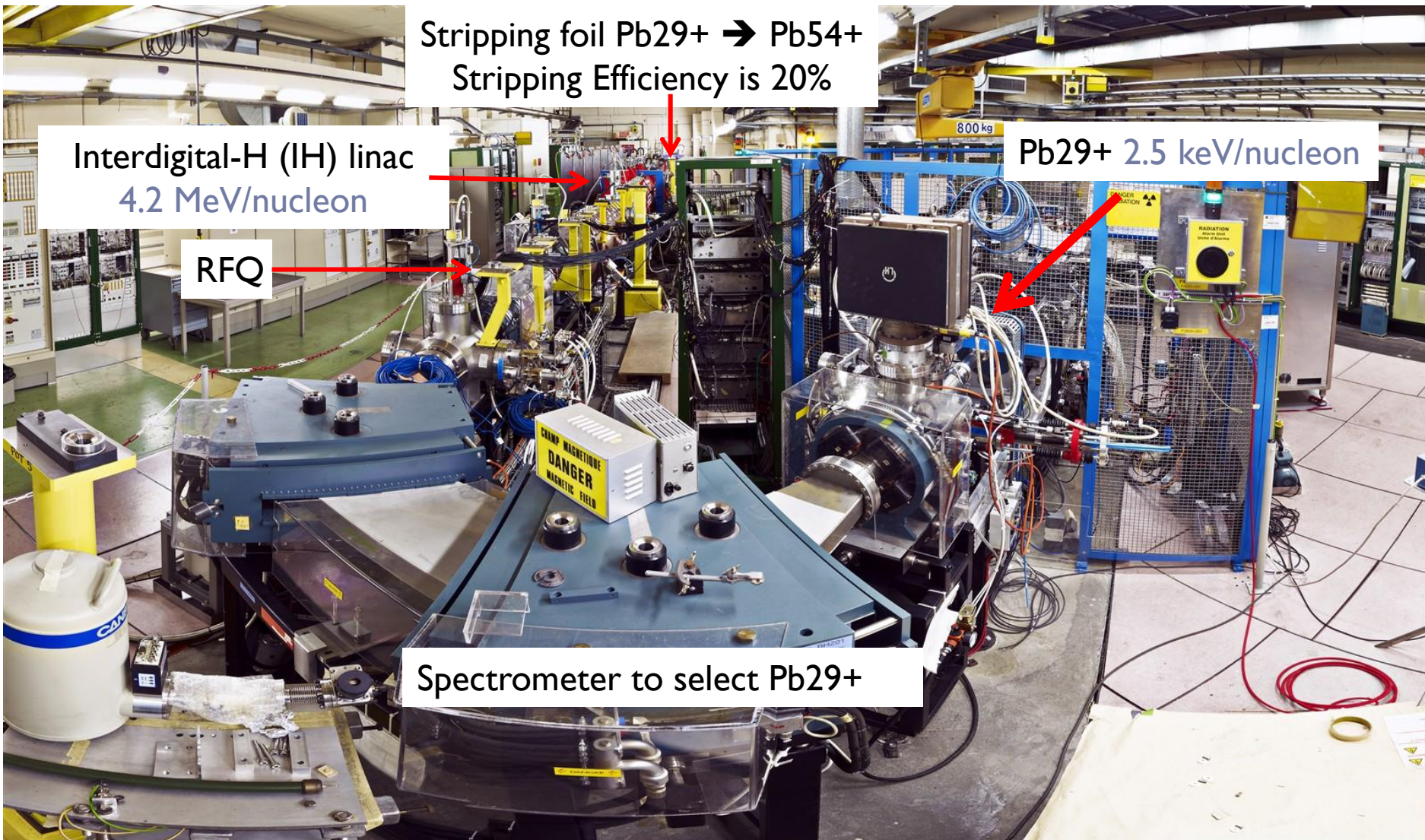

Ion Chain : Low Energy Ion Ring (LEIR)

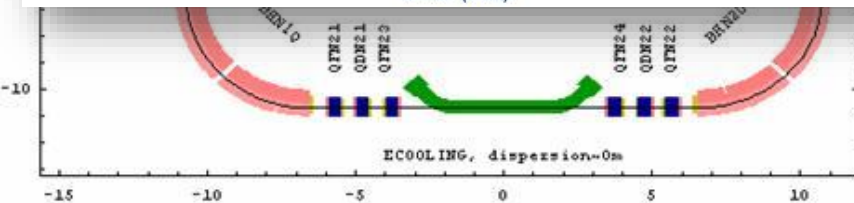
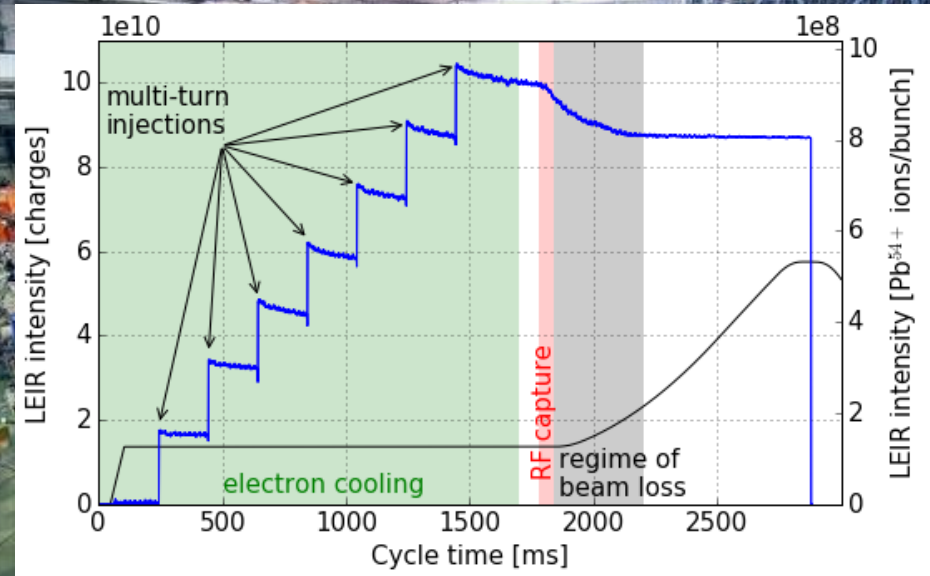
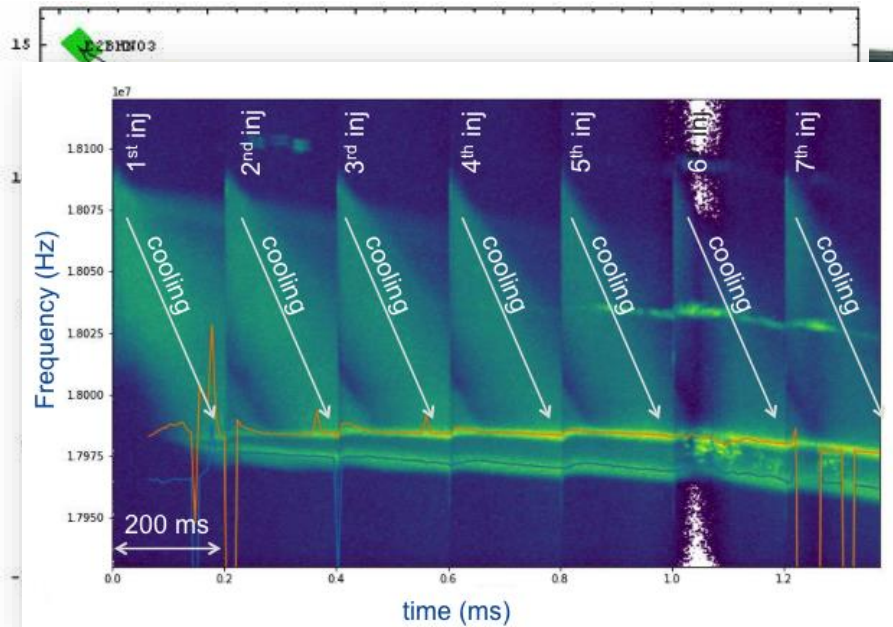

LEIR Accumulates the 200 ms pulses from Linac3; then splits into 2 bunches

Electron Cooling is used to achieve the required brightness

Acceleration to 72 MeV/nucleon before transfer to the PS

LEIR Cycle is 3.6 s

The Pb⁵⁴⁺ is finally fully stripped to Pb⁸²⁺ in the transfer line from PS to SPS

What else besides injection into LHC our CERN Accelerator Complex does?



There is quite some amazing physics going on beyond the LHC

ANTIMATTER'S
GONE MISSING ...

WHEN DID THIS
HAPPEN, SIR?

ABOUT 15
BILLION YEARS
AGO ...

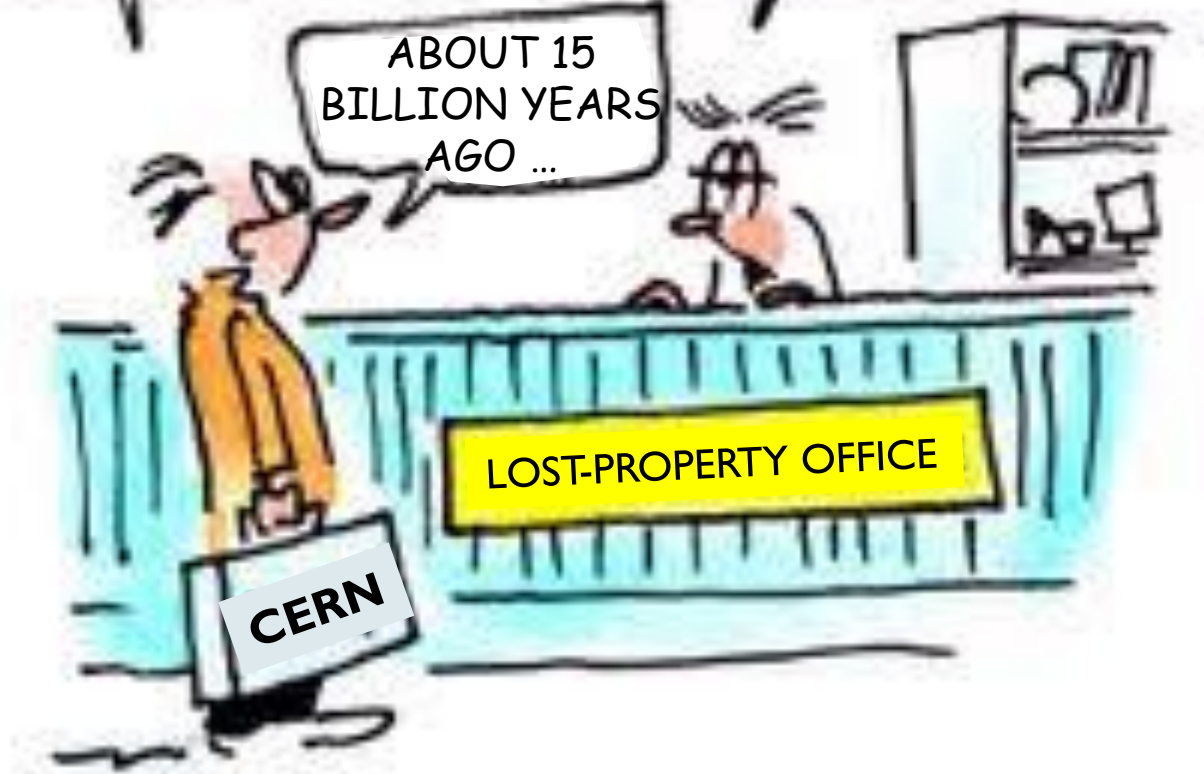

History of the Antiproton Decelerator Chain

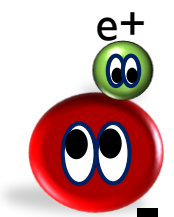
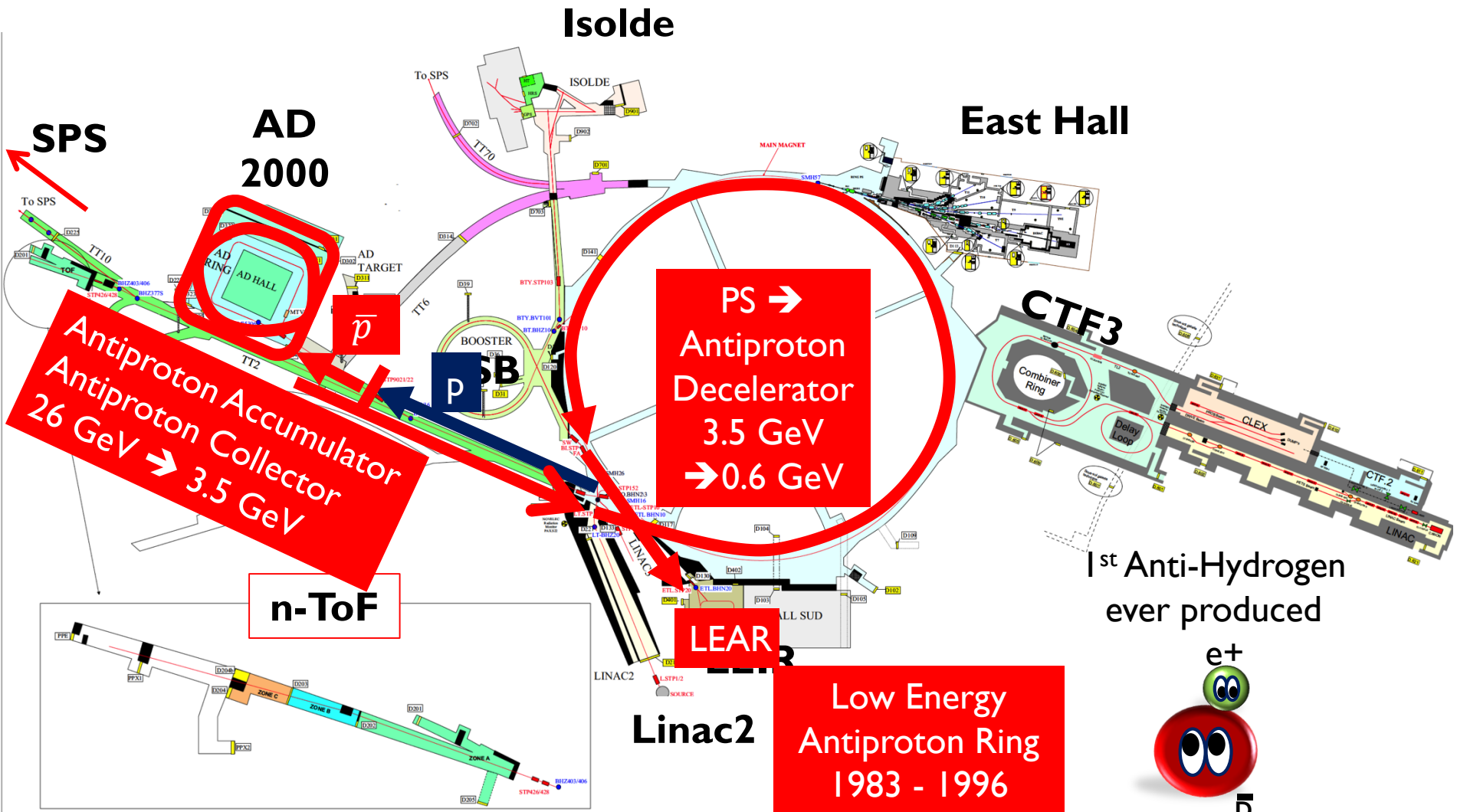



Antiproton Decelerator : AD

Built in 1999 (from the old AC)
 26 GeV/c PS Proton beam produces \bar{p}
 (1 in 10^7) which are focused and
 captured in the AD and decelerated to
 100 MeV/c (5.3 MeV)

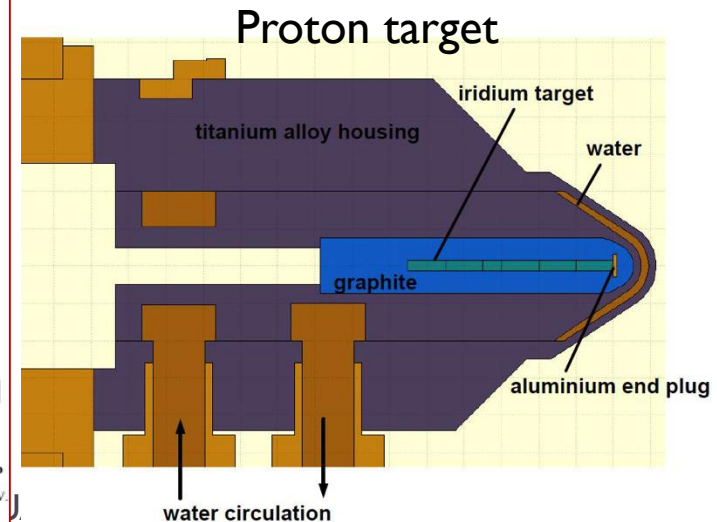
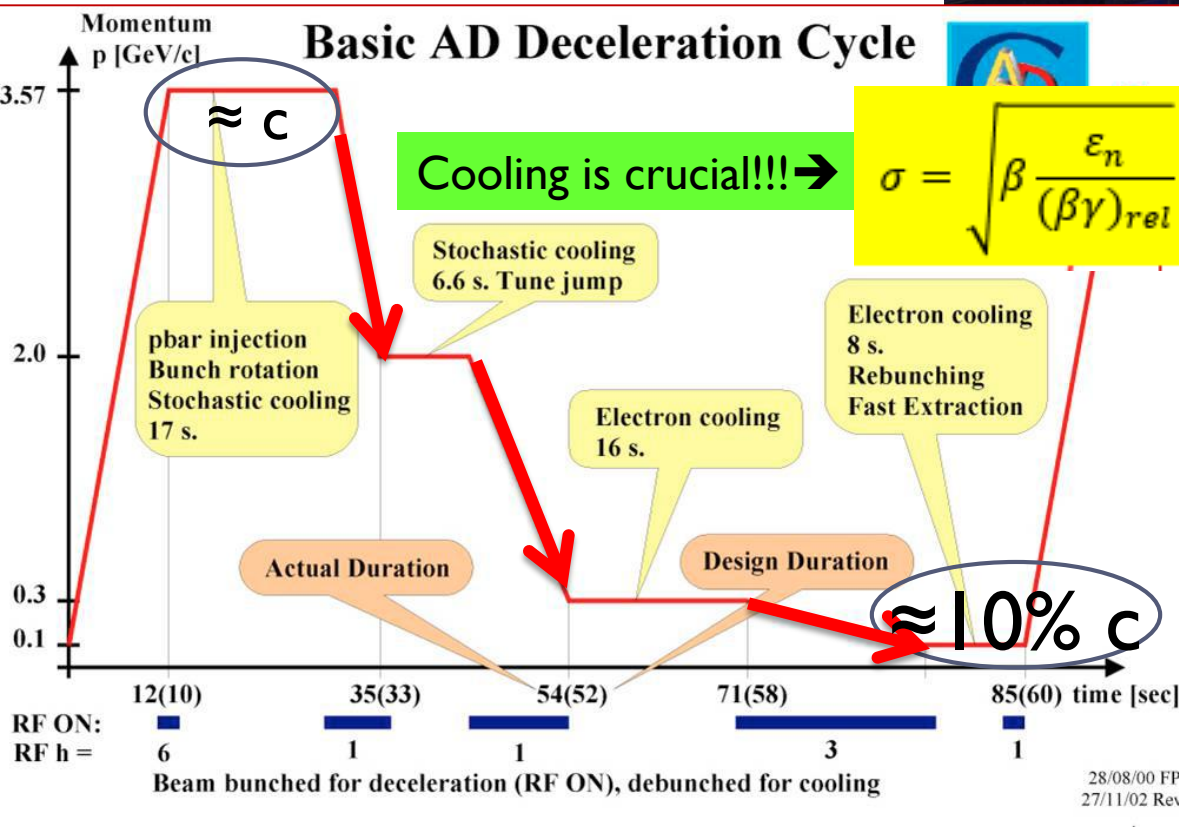
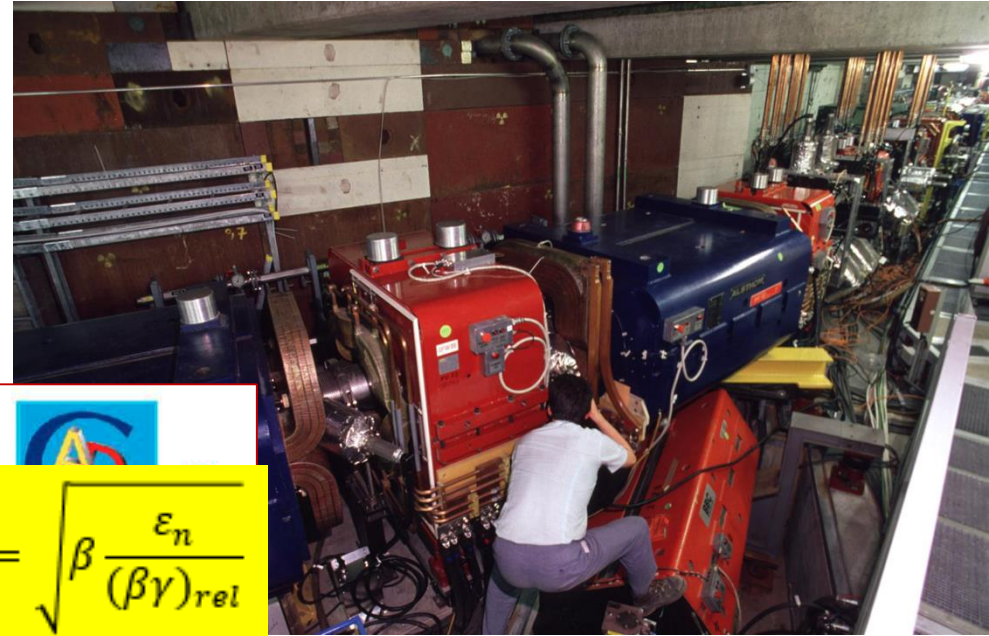

AD Layout

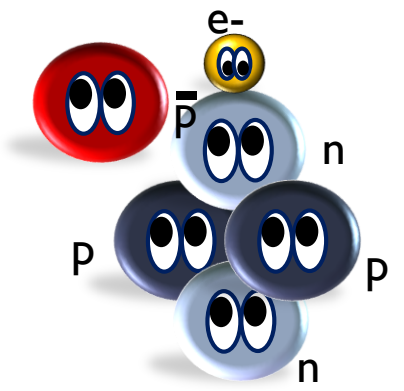
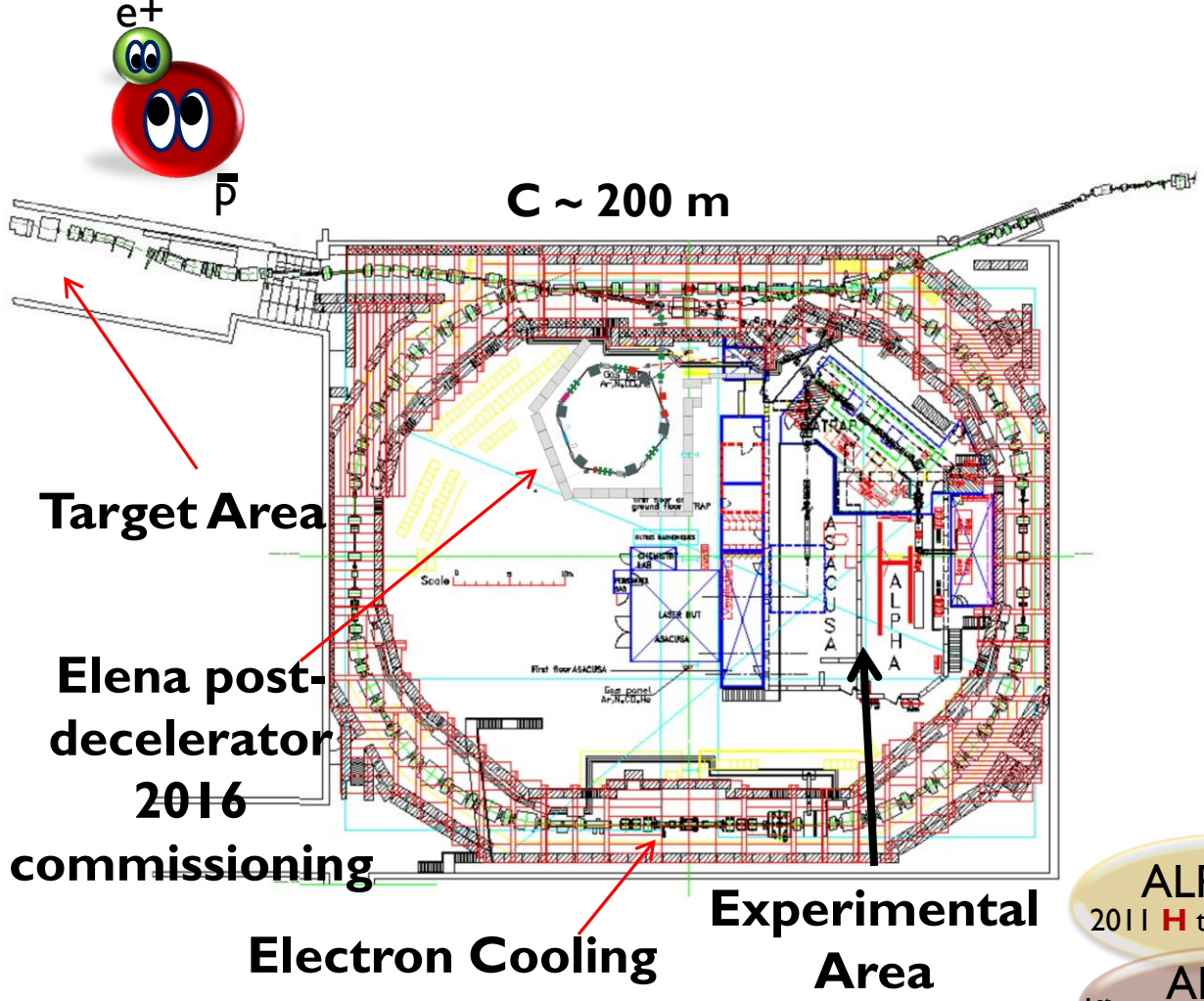

Target Area

Elena post-decelerator

2016

commissioning

Electron Cooling

Experimental Area

- ASACUSA
Antiprotonic helium $\rightarrow m \bar{p}$
- ALPHA
2011 \bar{H} trapped for 16'
- AEGIS
1st meas. of gravitational effect on \bar{H}
- GBAR⁽¹⁾
Gravitational effect on \bar{H}
- ATRAP
2002 first glimpse inside \bar{H}
- BASE
 \bar{p} magnetic moment

Elena ... More Deceleration

Today's set-up

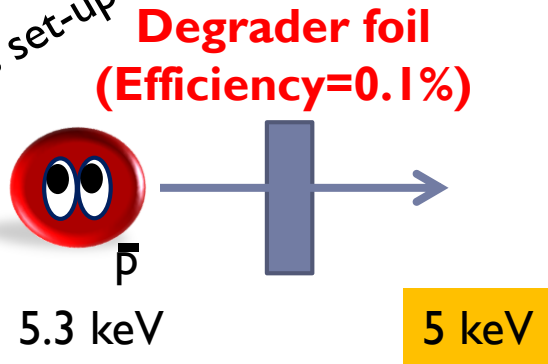

ELENA will overcome this problem + will be able to deliver beams almost simultaneously to all four experiments resulting in an essential gain in total beam time for each experiment. This also opens up the possibility to accommodate an extra experimental zone.

**A second stage of deceleration after AD Momentum: 100 – 13.7 MeV/c
Kinetic : 5.3 – 0.1 MeV**

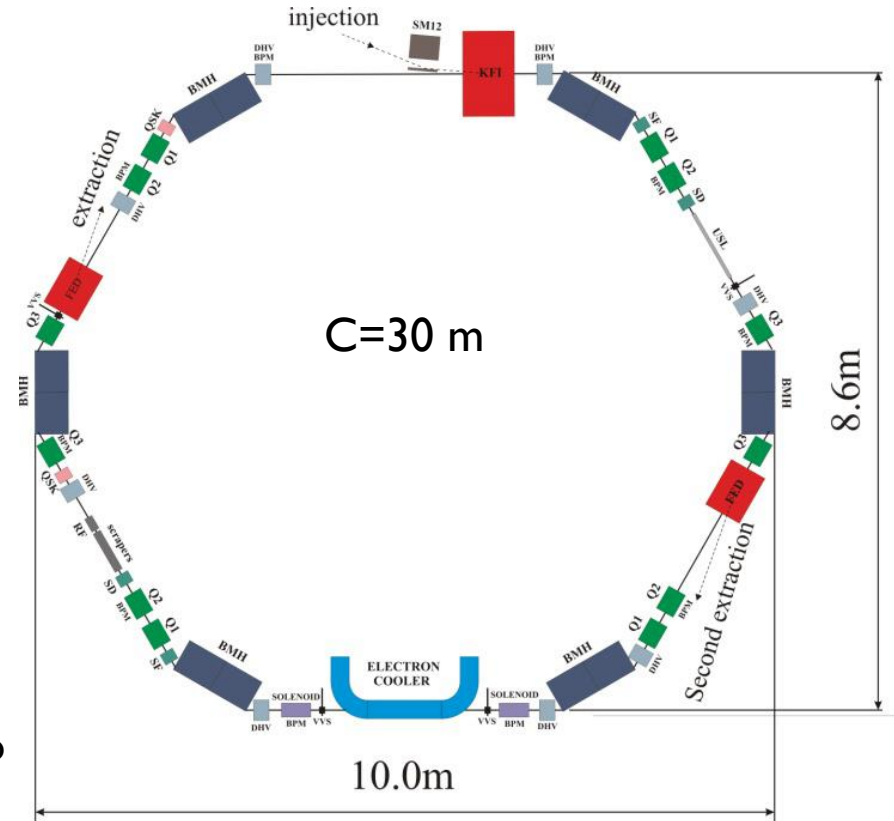

**Commissioning in 2016
Operation 2017**

ISOLDE Synchrotron: 1967-1990

ISOLDE PSB: 1992

PSB Experimental Areas: ISOLDE

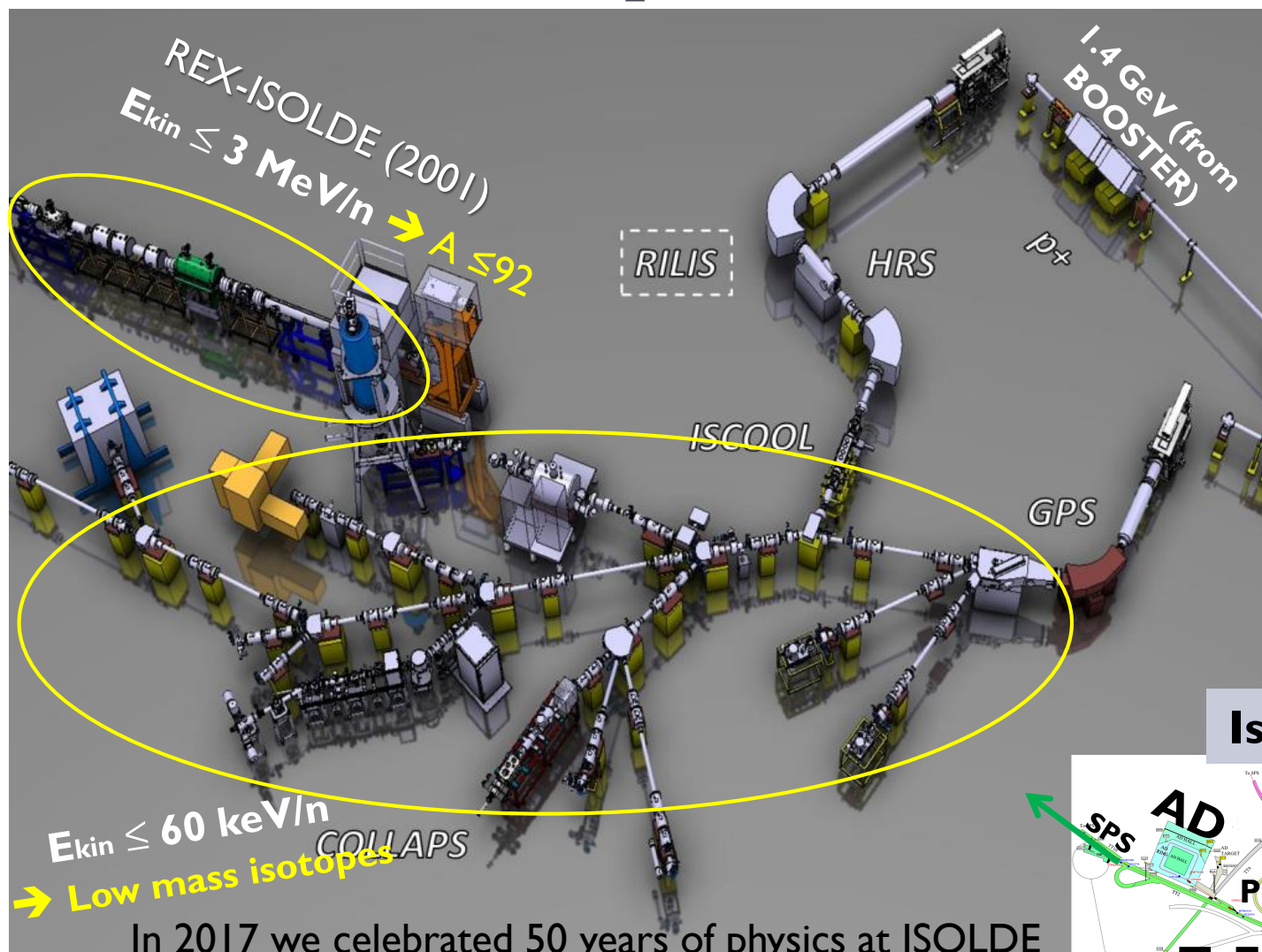

Solid and liquid target materials \rightarrow wide spectrum of radioactive isotopes up to $Z \leq 92$.
 Radioactive isotopes are produced via proton-induced target fragmentation, spallation and fission reactions

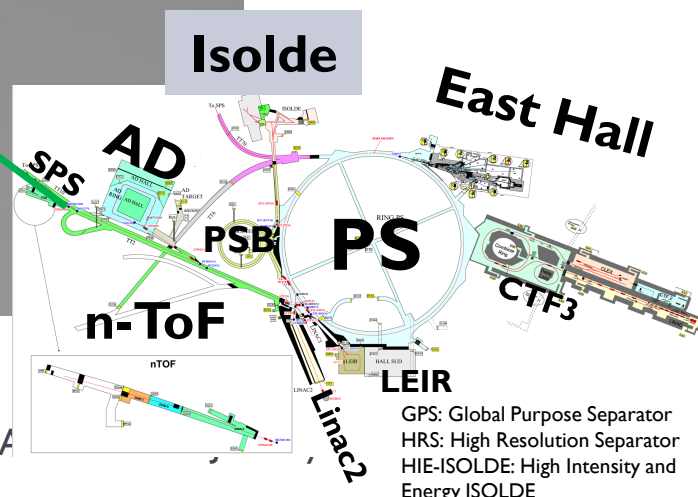

In 2017 we celebrated 50 years of physics at ISOLDE (Isotope mass Separator On-Line Device)

- \rightarrow on October 16, 1967 the first radioactive beam
- \rightarrow CERN's longest-running experiment site

Next generation of nuclear physics:

HIE-ISOLDE (+SC RF): $E_{kin} \leq 10 \text{ MeV/n} \rightarrow A \leq 200$

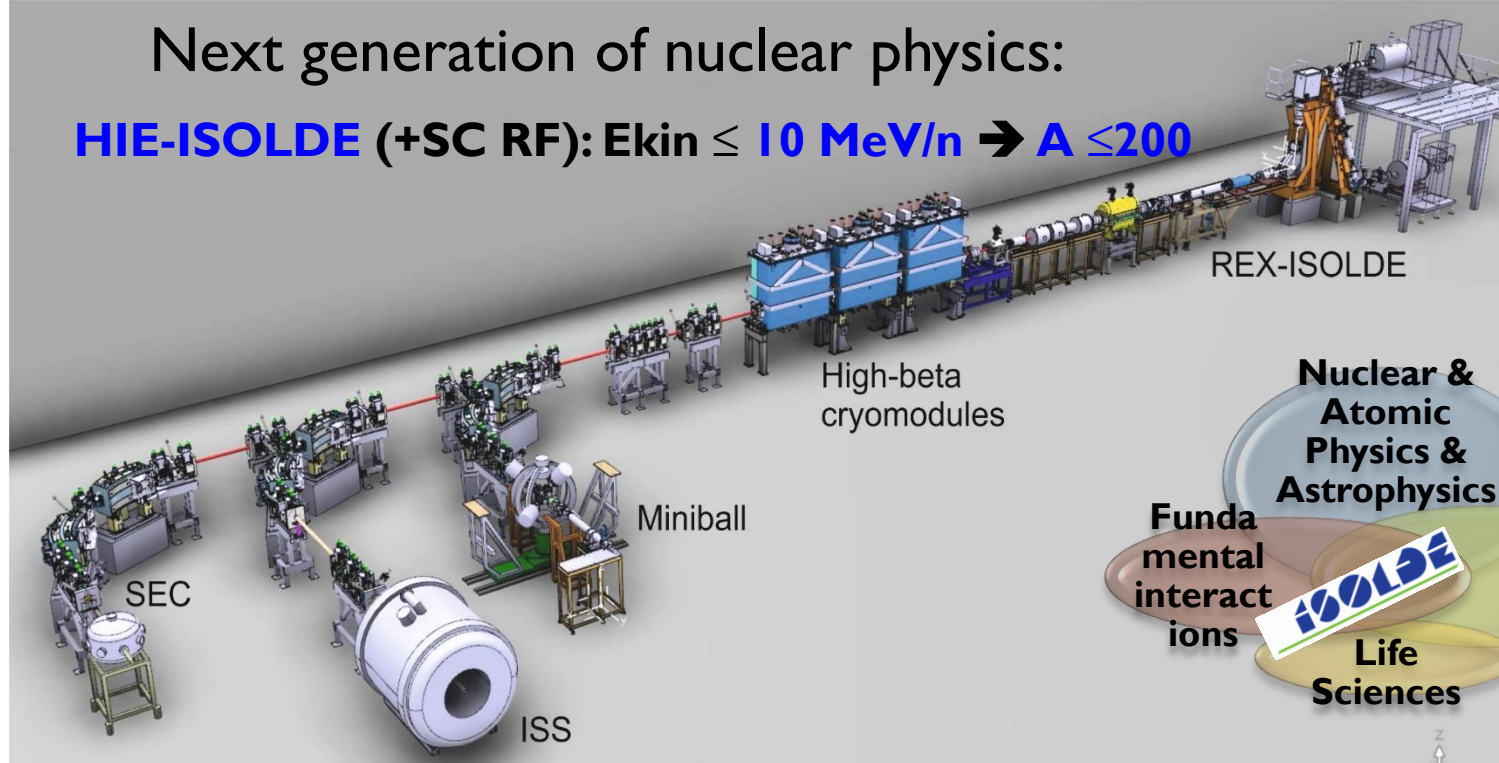

→ wide range of radioisotopes, some of which can be produced only at CERN thanks to the unique ISOLDE facility, for hospitals and research centres in Switzerland and across Europe.

→ devise and test unconventional radioisotopes with a view to developing new approaches to fight cancer

PS Experimental Areas: East Hall



Study the influence of galactic cosmic rays on the **Earth's climate** through the media of aerosols and clouds

Detector Calibration

Proton & neutron irradiation facilities

CLIMATE

SATELLITE EXPERIMENTS

East Hall

PS

CTF3

LEIR

n-ToF

Linac2

P^+ (26 GeV)

Bdg 157



ALICE

ATLAS

CMS

IRRAD
CHARM

Secondary Beams:
Momentum range 1-15 GeV/c
Electrons, Hadrons & Muons
Max $1-2E^{+6}$ particles per spill

Resonant Extraction with a spill length of ~ 400 ms

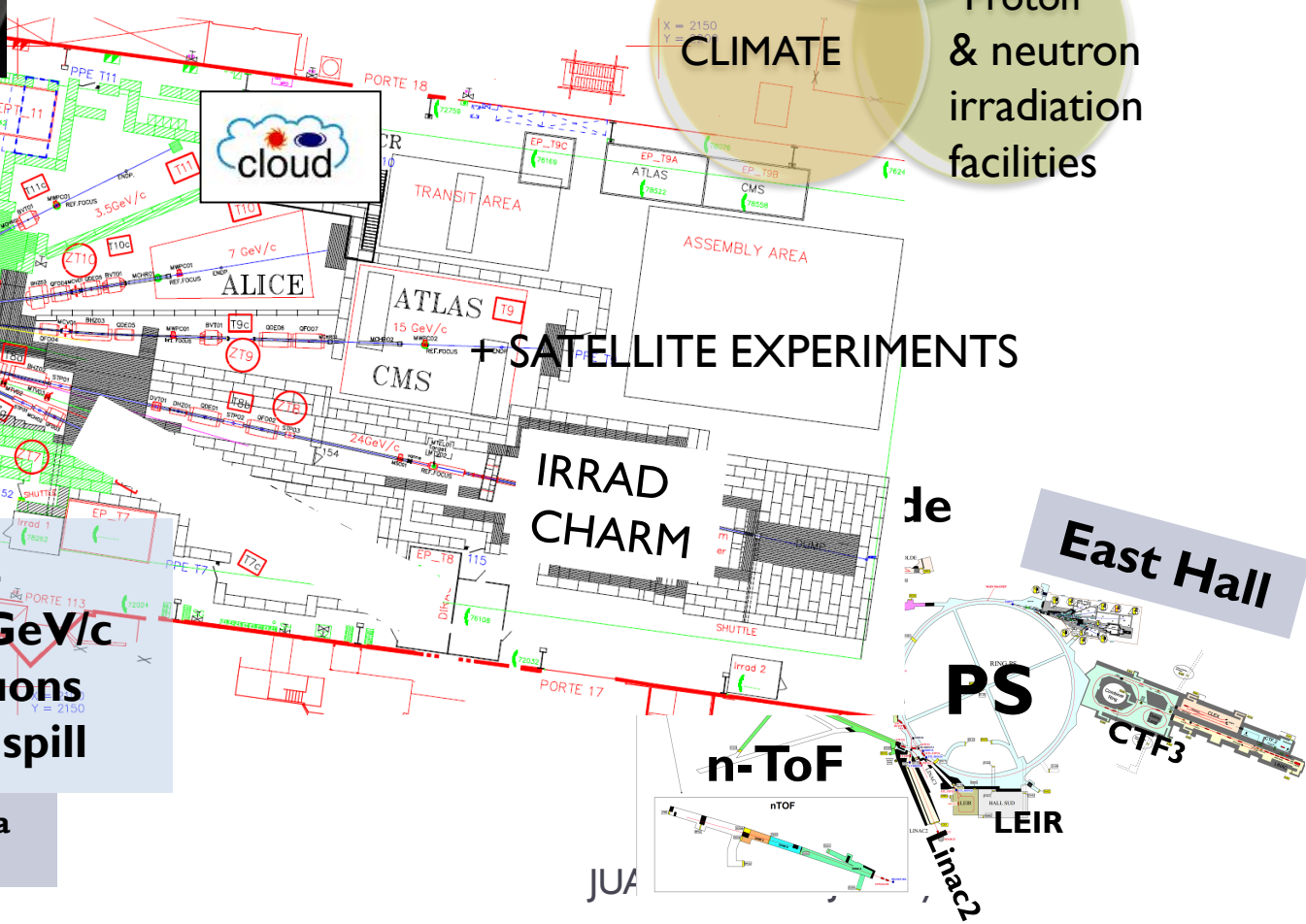

PS Experimental Areas: n-TOF



Study of neutron-induced reactions

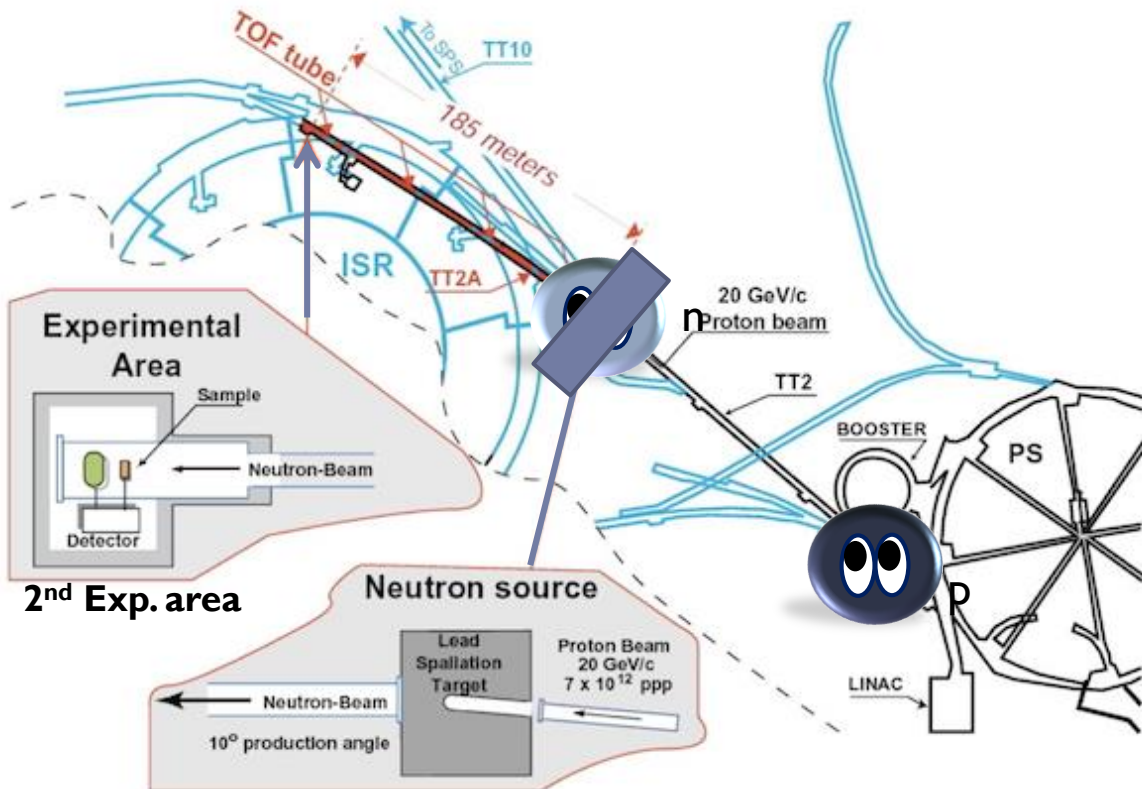

- Transmutation of nuclear waste
- Stellar Nucleosynthesis
- Symmetry Breaking in compound nuclei

Each primary proton produces ~300 neutrons
 Neutron → meV - GeV

The neutron kinetic energy is determined by **time-of-flight**

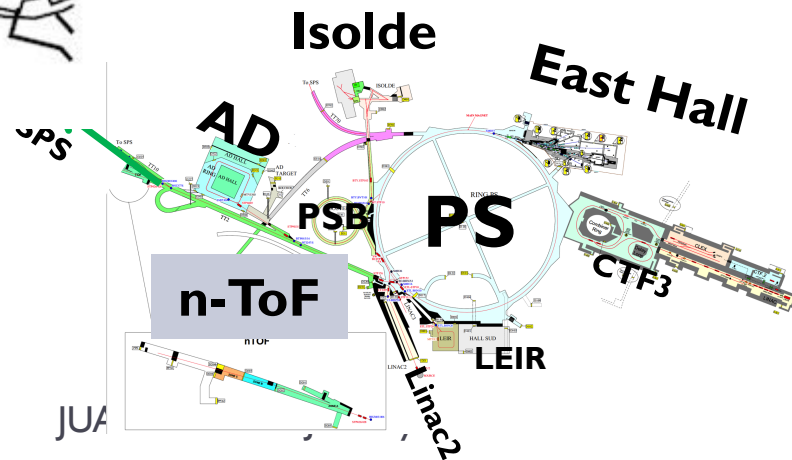

SPS Experimental Areas: North Area

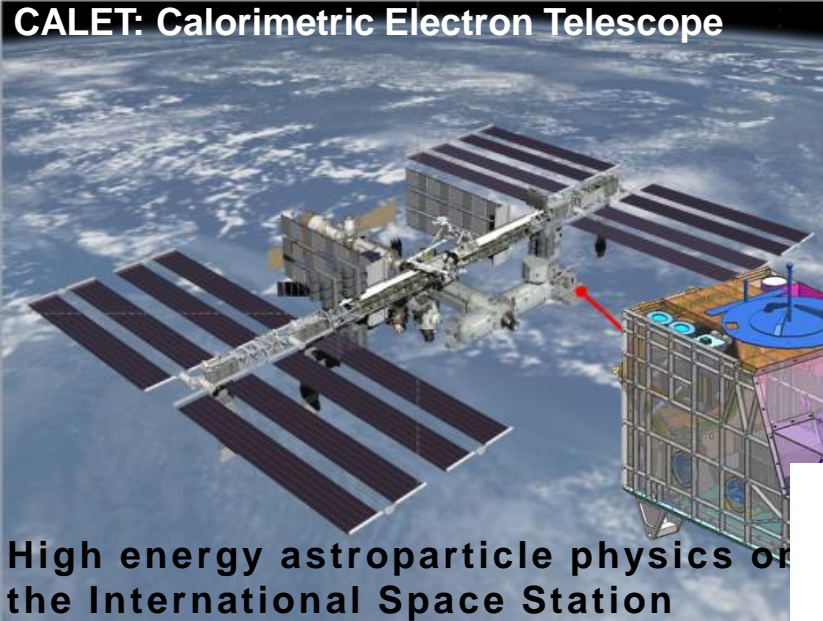

- 7 beam lines (tot:5.8 km)
- 3 experimental halls
- ~ 2000 scientist/year
- Slow extraction
- 3 primary targets
- Ion physics program: (Be, Ar, Xe)
- ~ 50 different clients/year

NA61/SHINE (QCD experiment)

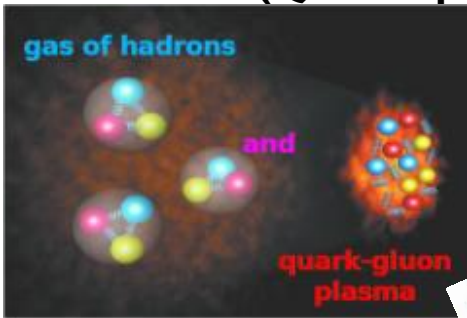

Russian regular satellite Clarify the Cosmic Rays origin

North Experimental Area

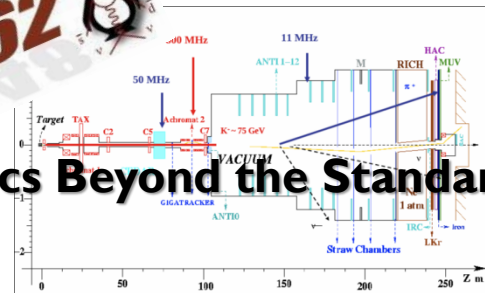

Physics Beyond the Standard Model

HiRadMat

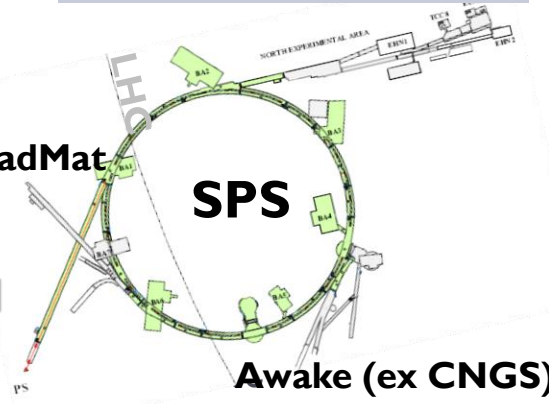

JUAS 2018

COMPASS: Common Muon and Proton Apparatus for Structure and Spectroscopy

SPS Experimental Areas: *AWAKE*

Proof-of-principle:

- Inject 10-20 MeV electron beam
- acceleration of electrons to **multi-GeV energy range** in the wakefield driven by protons.

→ first proton driven PWA experiment world-wide

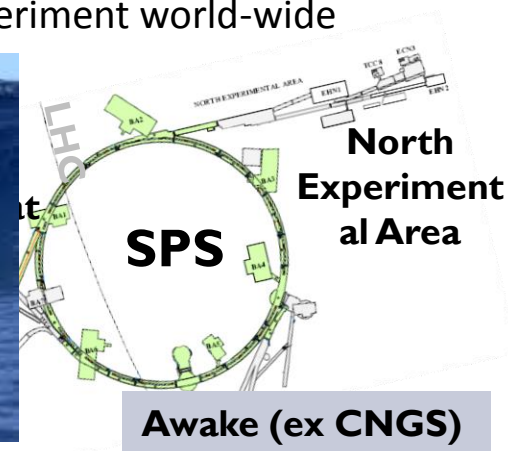

AWAKE



- Probe beam given
- e⁻ line commissioning
- Bunch rotation

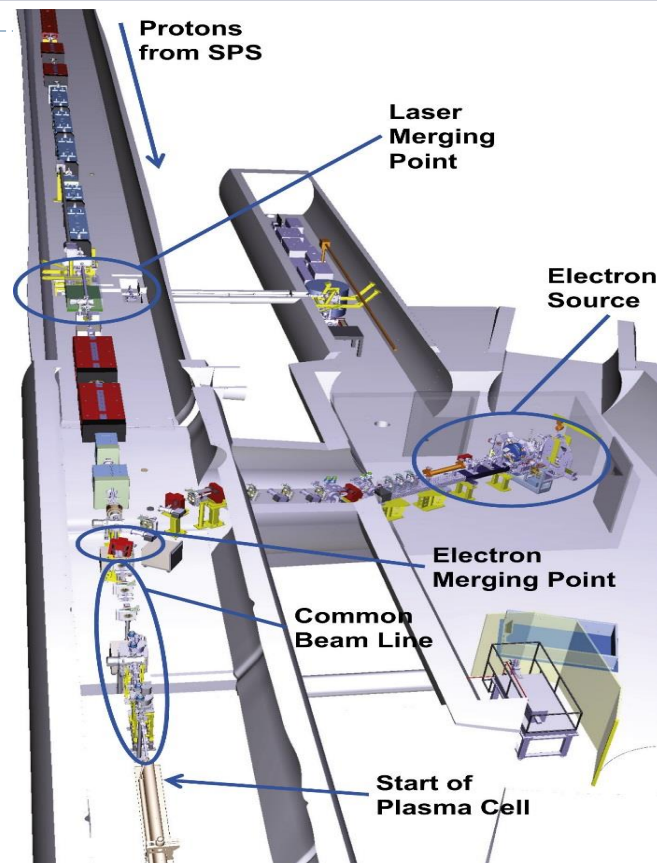
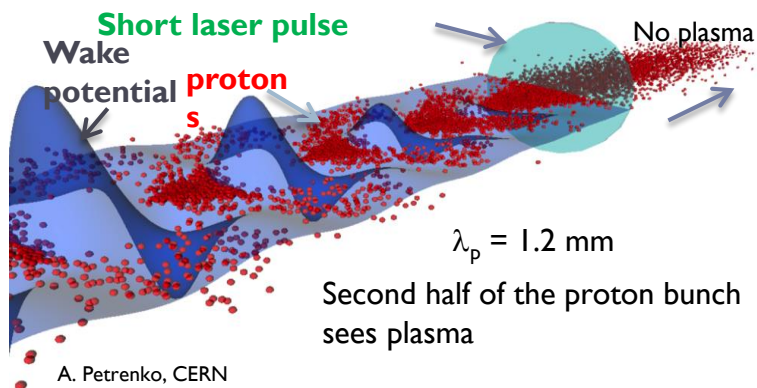

2017: 1st milestone reached!

First demonstration of seeded self-modulation of a high energy proton bunch in plasma

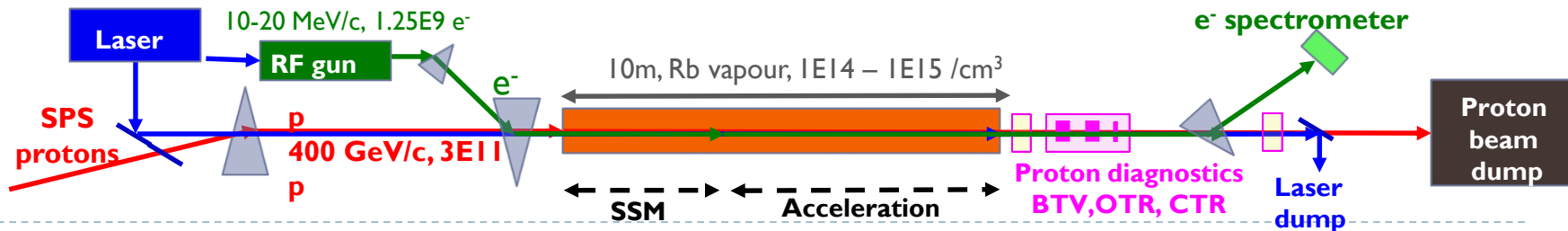

12 January 2018

JUAS 2018

36

SPS Experimental Areas:

Current and Future Accelerators operate with higher energy, higher intensity, smaller size beams.

LHC nominal beam (2808 bunches with 1.5 10^{11} p+/b at 7 TeV) energy = **362 MJ/beam**
→ energy equivalent to

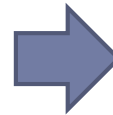

HiRadMat is a facility designed, to study the impact of intense pulsed beam on materials

- Thermal management
- Radiation Damage to materials
- Thermal shock – beam induced pressure waves

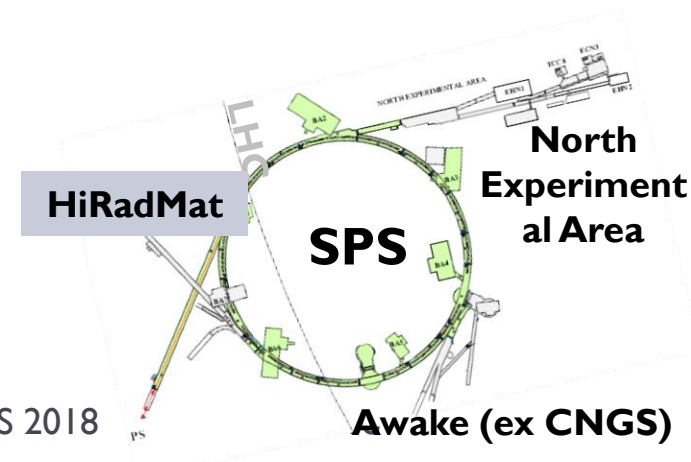

SPS Experimental Areas:

Current and Future Accelerators operate with higher energy, higher intensity, smaller size beams.

LHC nominal beam (2808 bunches with 1.5 10¹¹ p⁺/b at 7 TeV) energy = **362 MJ/beam**
 → energy equivalent to



Elkin (@155 km/h) ≈ 360 MJ

Simulation: 8 LHC bunches @5 TeV impacting a Tungsten collimator jaw

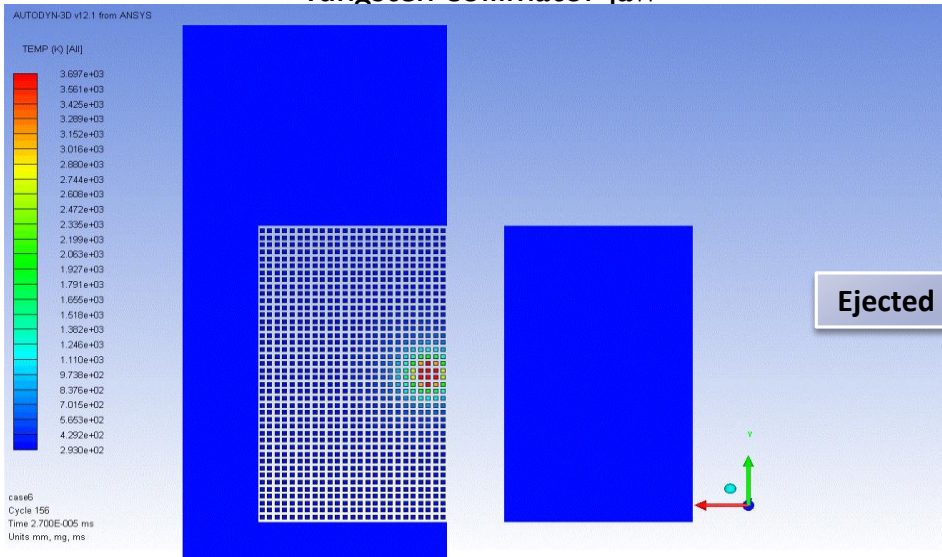

HiRadMat is a facility designed, to study the impact of intense pulsed beam on materials

- Thermal management
- Radiation Damage to materials
- Thermal shock – beam induced pressure waves

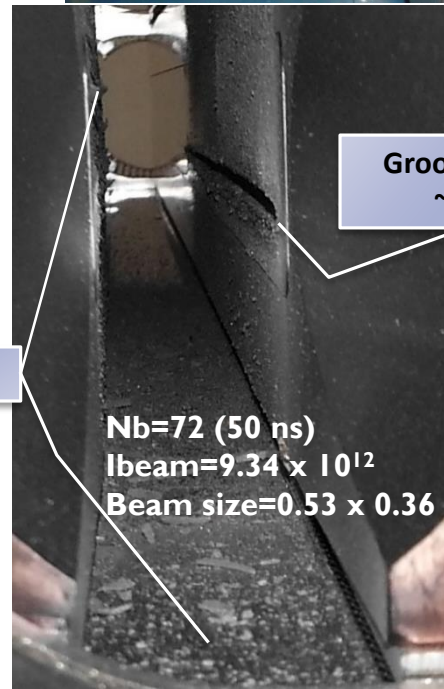

Groove height ~ 1 cm

Ejected W fragments

Nb=72 (50 ns)
 I_{beam}=9.34 x 10¹²
 Beam size=0.53 x 0.36



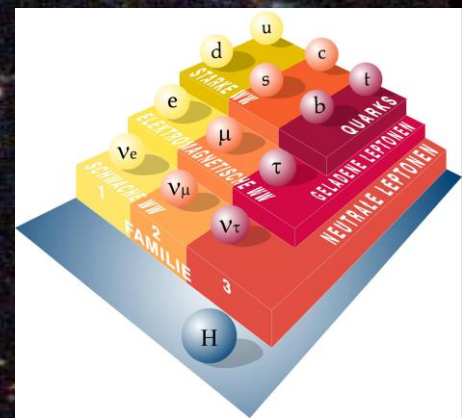

A visualization of the cosmic web, showing a complex network of filaments and clusters of galaxies. The background is dark, with numerous bright orange and red points representing galaxies. The filaments are formed by these points connected by thin lines, creating a web-like structure. The overall appearance is that of a vast, interconnected network of matter in the universe.

*Reconstruction of Dark Matter distribution based on
observations*

*Budget: Dark Matter: 33 %
Dark Energy: 66 %
Anything else (including us) 1%*

CERN Lab 20???

LHC

HE_LHC:
27 km 33 TeV 20T

VHE_LHC:
100 km 100 TeV

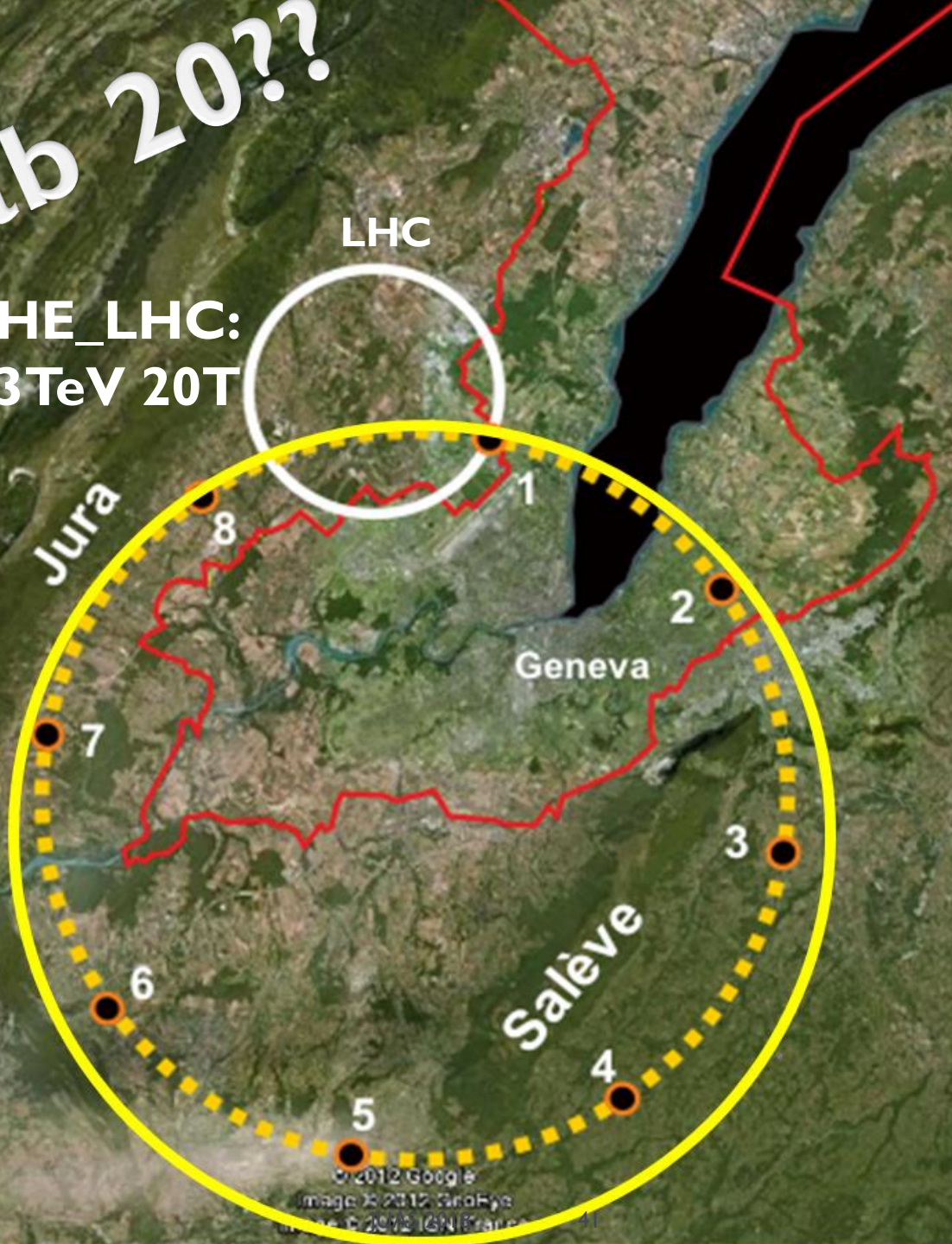

- LHC Tunnel
- - - VHE_LHC (80 km)
- VHE_LHC (100 km)

Backup slides

CERN injector accelerator complex

Isolde

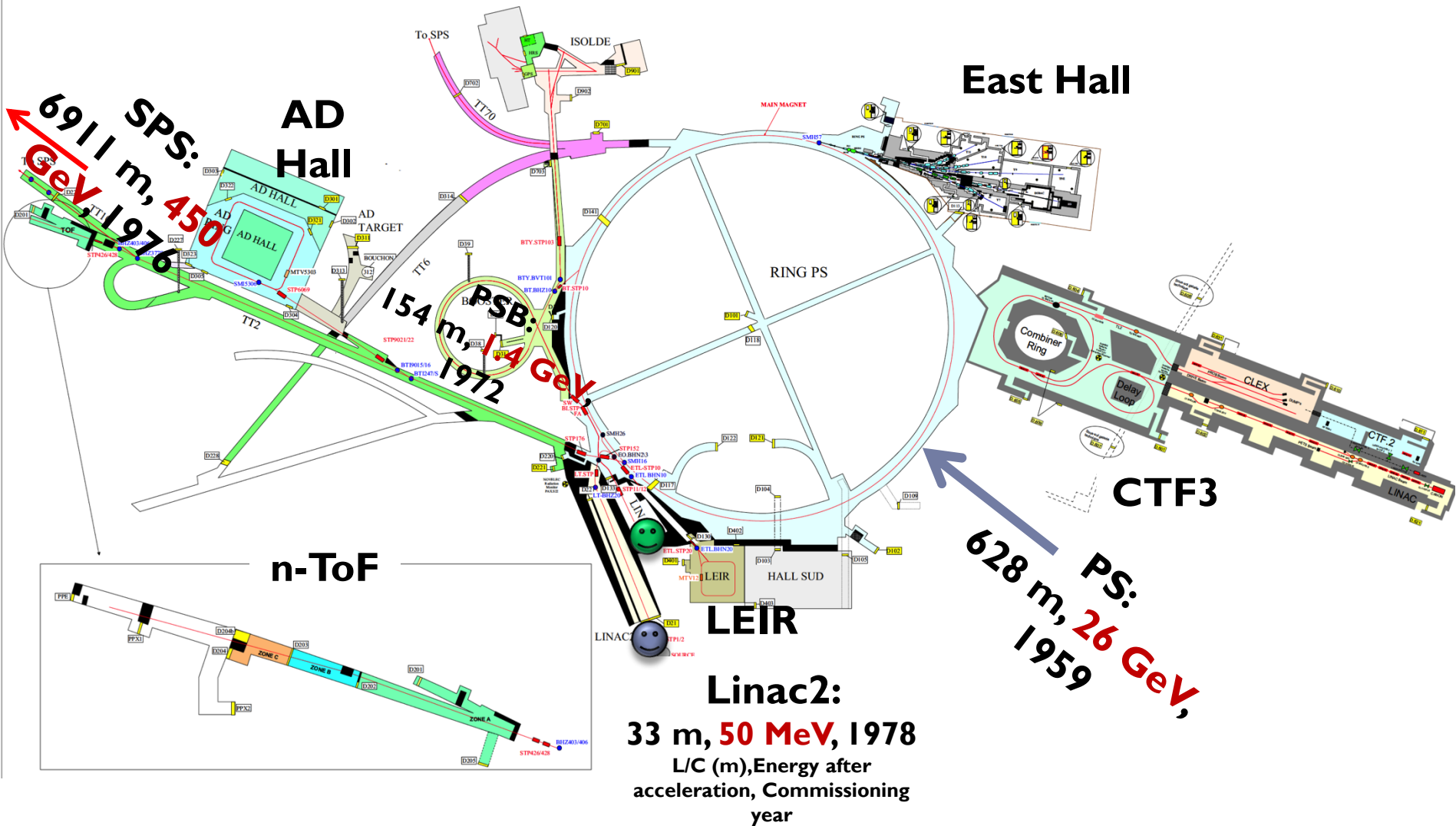

Further Reading

The LHC Design Report Volume 1: The LHC Main Ring, CERN-2004-003-V-1,
<http://cds.cern.ch/record/782076/files/CERN-2004-003-V1.pdf>

The LHC Design Report Volume 1: The LHC Infrastructure and Services, CERN-2004-003-V-2,
<http://cds.cern.ch/record/782076/files/CERN-2004-003-V2.pdf>

The LHC Design Report Volume 3: The LHC Injector Chain : CERN-2004-003-V-3:
<http://cds.cern.ch/record/823808/files/CERN-2004-003-V3.pdf>

Fifty years of the CERN Proton Synchrotron: Volume 1 :CERN-2011-004,
<http://cds.cern.ch/record/1359959/files/cern-2011-004.pdf>

Fifty years of the CERN Proton Synchrotron: Volume 2 :CERN-2013-005,
<http://cds.cern.ch/record/1597087/files/CERN-2013-005.pdf>

Linac4 Technical Design Report::
<http://cds.cern.ch/record/1004186/files/ab-2006-084.pdf>

Elena Conceptual Design Report:
<http://cds.cern.ch/record/1309538/files/CERN-BE-2010-029.pdf>

AWAKE Technical Design Report:
<http://cds.cern.ch/record/1537318/files/SPSC-TDR-003.pdf>

HiRadMat:
<http://cds.cern.ch/record/1403043/files/CERN-ATS-2011-232.pdf>

Generating a 25ns Bunch Train in the PS

- **Longitudinal bunch splitting (basic principle)**

- Reduce voltage on principal RF harmonic and simultaneously rise voltage on multiple harmonics (adiabatically with correct phase, etc.)

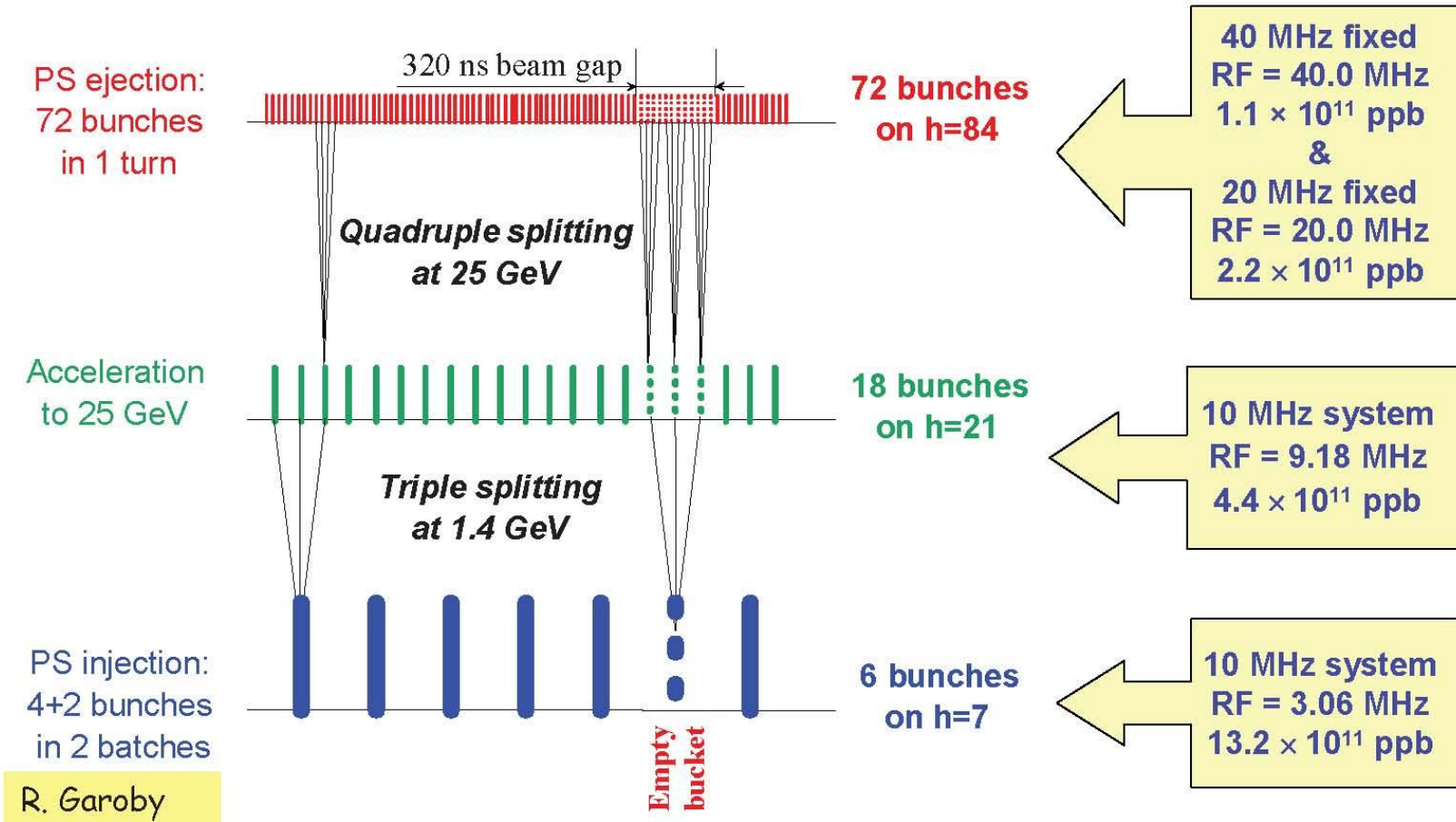

Use double splitting at 25 GeV to generate 50ns bunch trains instead

Proton Synchrotron (PS)

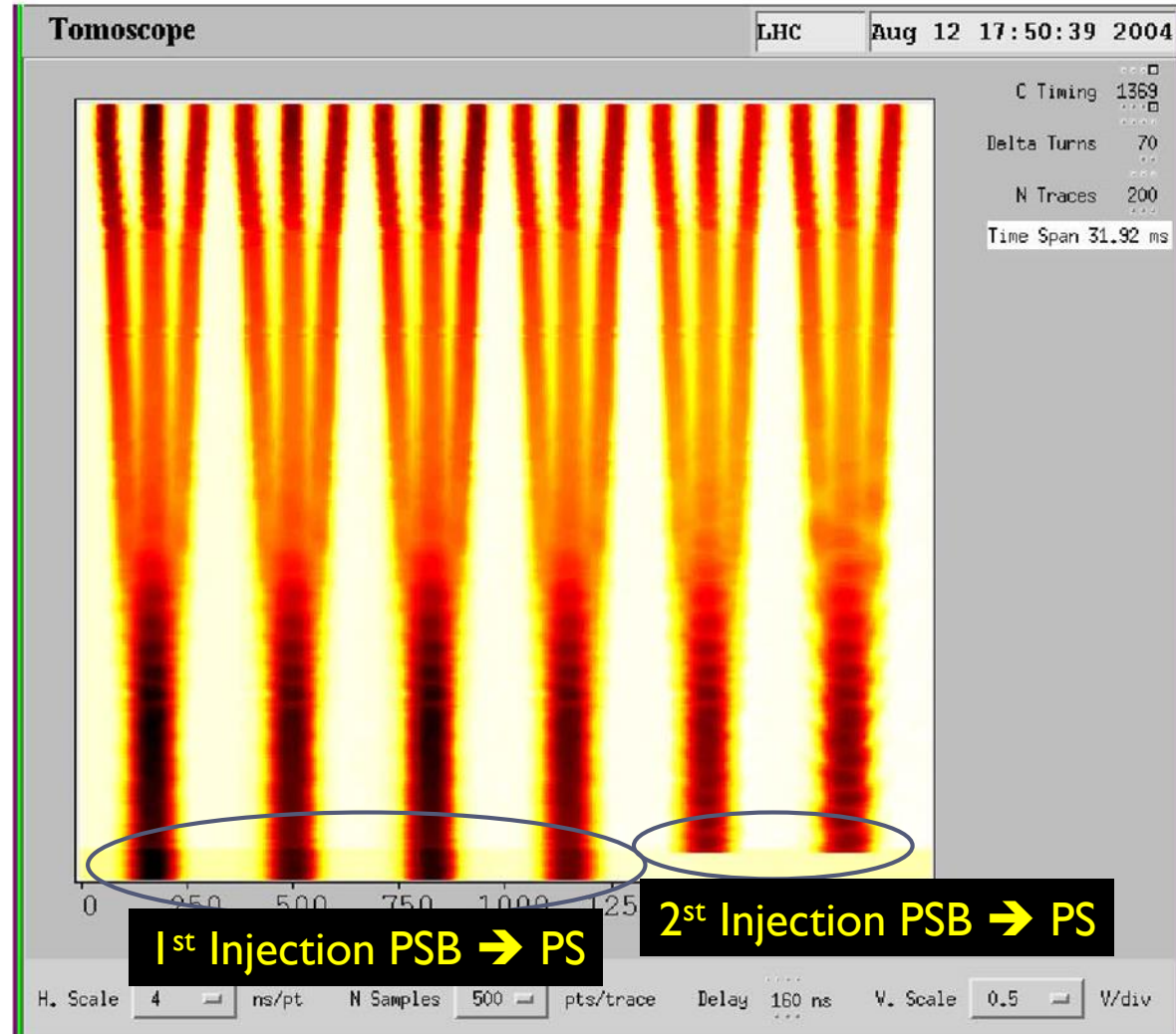
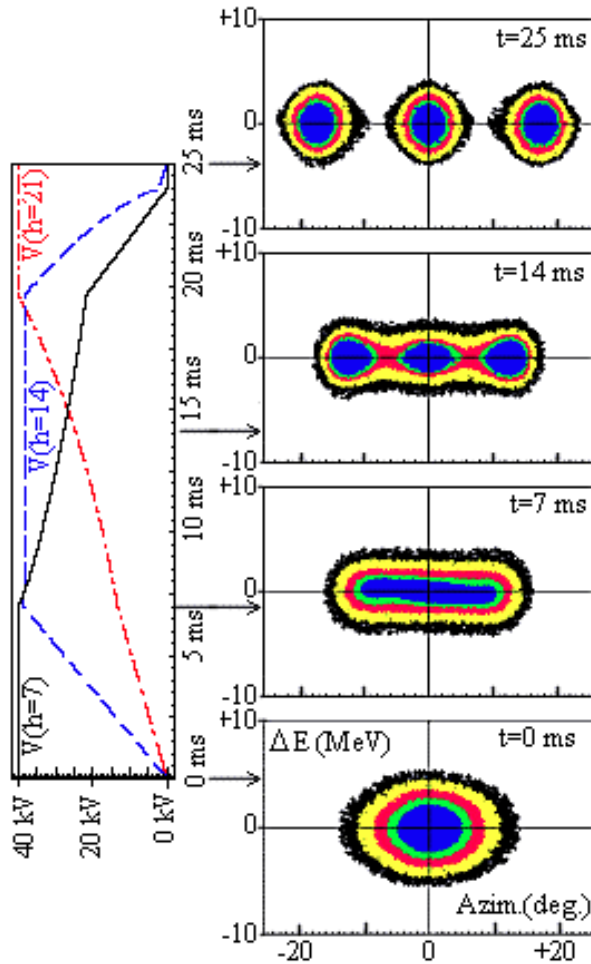

The PS is the machine in the LHC Injector Chain where the Longitudinal characteristics of the LHC beam are determined

Large Hadron Collider (LHC)

Golden formula (you should know by heart)

$$B\rho = \frac{p}{Ze}$$

FIXED, no choice

Circumference → FIXED!!! by LEP

$$\rho \approx \frac{26658.9 \text{ m}}{2\pi} \cdot 66\% \approx 2780 \text{ m}$$

~ 66% of the lattice elements are dipoles

p = nucleon momentum → defined by the physics case → TeV range → **7 TeV**

$$B = \frac{p}{\rho Ze} \approx 3.33 \frac{p \left(\frac{\text{GeV}}{c}\right)}{\rho(\text{m})} = 8.39 \text{ T}$$

We need SUPERCONDUCTING technology

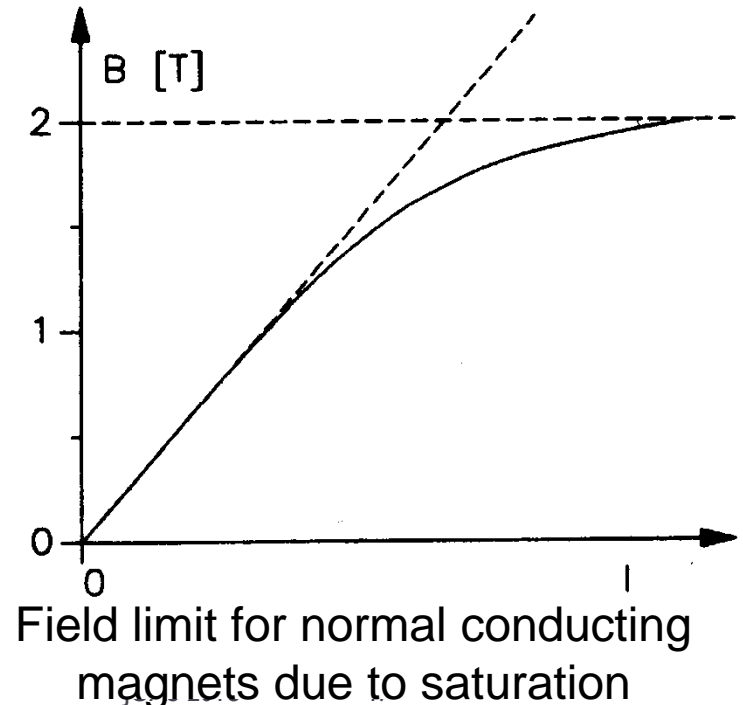

Large Hadron Collider (LHC)

Production rate of events is determined by the cross section Σ_{react} and a parameter L that is given by the design of the accelerator:
 ... the luminosity

$$R = L * \Sigma_{\text{react}} \approx 25 \frac{1}{10^{-15} b} 10^{-12} b = \text{some } 1000H$$

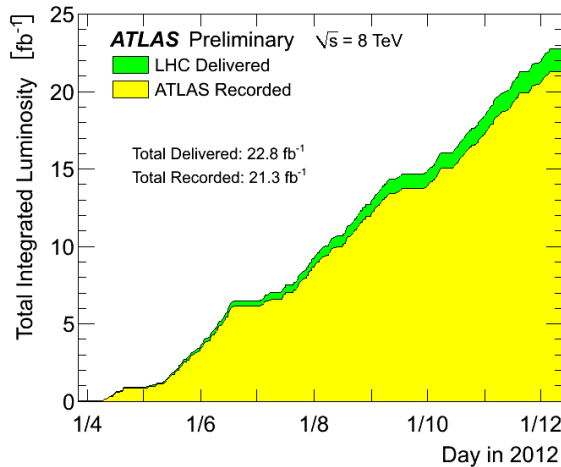

remember:
 $1b = 10^{-24} \text{ cm}^2$

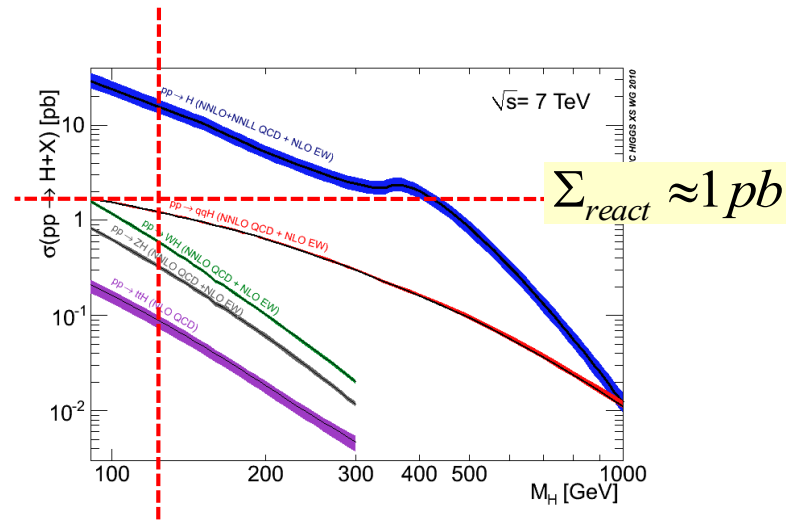

Integrated luminosity during RUN I

$$\int L dt \approx 25 \text{ fb}^{-1}$$

Official number: 1400 clearly identified Higgs particles “on-tape”

Overall Protons Delivered in 2012

Facility	Protons Delivered	% of Total
Isolde	1.15×10^{20}	63.8%
CNGS	3.9×10^{19}	21.6%
n-TOF	1.9×10^{19}	10.2%
The rest	8.13×10^{18}	4.5%
LHC	3.25×10^{16}	0.018%
Total	1.81×10^{20}	

Colliders are very Efficient!

The LHC Physics Program Used 0.018% of the protons produced in CERN accelerators during 2012!

- ❖ Intensities as delivered to the facility, upstream losses ignored,
- ❖ Beams for Machine Setup and Studies Excluded
- ❖ The total delivered protons represents roughly 0.27mg (rest mass!)

Large Hadron Collider (LHC)

Superconducting cables of Nb-Ti

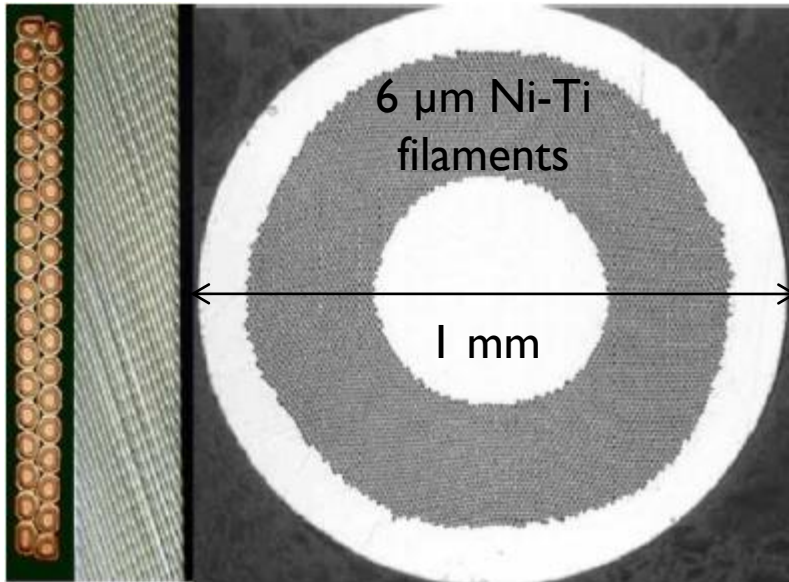

LHC ~ 27 km circumf. with 20 km of superconducting magnets operating @8.3 T. An equivalent machine with normal conducting magnets would have a circumference of 100 km and would consume 1000 MW of power → we would need a dedicated nuclear power station for such a machine. LHC consumes ~ 10% nuclear power station

Liquid Nitrogen

Cold compressors

He gas → liquid @ 4.2 K → superfluid @ 2.17 K

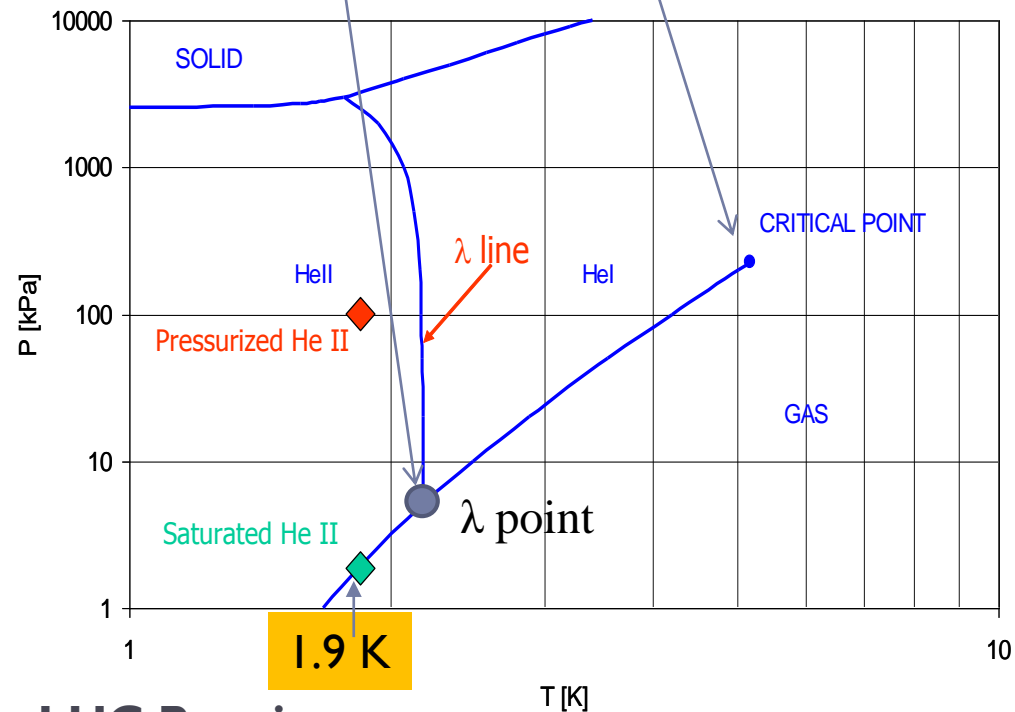

LHC Requires

- 90,000 T of liquid Nitrogen
- 130 T of Liquid Helium to keep it cold

June 1994
first full scale prototype dipole

June 2007 First sector cold

ECFA-CERN workshop

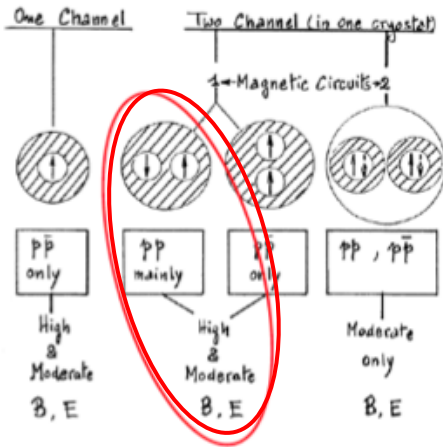

April 2008
Last dipole down



1994 project approved by council (1-in-2)



SSC

25 y

cancelled

Main contracts signed



First set of twin 1 m prototypes Over 9 T

LEP/LIBRARY
CFR
PRELIMINARY PERFORMANCE ESTIMATE
S. Myers and
1. Introduction
This analysis was stimulated by new large pp and pp colliders are active. Indeed, a first look at the basic performance of pp rings in the LEP tunnel seems over-possible start of such a p-LEP project discuss is, in fact, rather obvious, but of our knowledge, not been presented so



2002 String 2

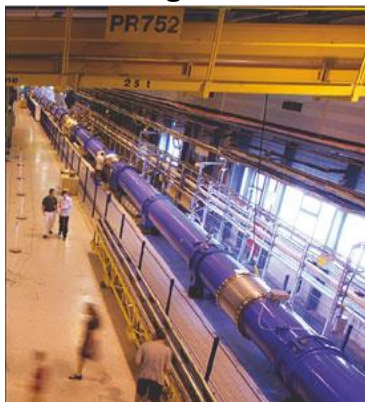

November 2006
1232 delivered



September 10, 2008
First beams around

August 2008

First injection test

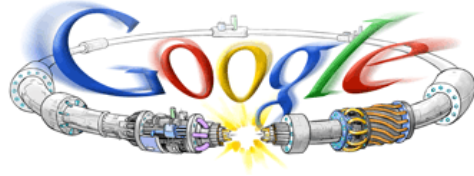
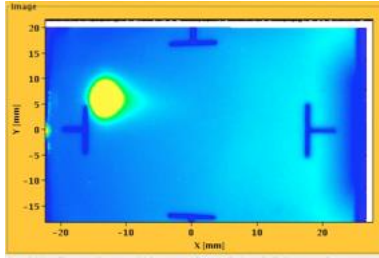

Sept. 10, 2008
First beams around

Repair and Consolidation

November 29, 2009
Beam back

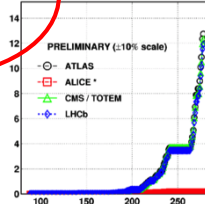

October 14, 2010
 $L = 1 \times 10^{32}$
248 bunches

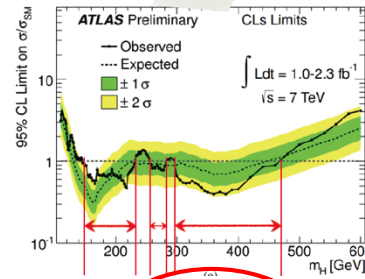

October, 2011
 3.5×10^{33} , 5.7 fb^{-1}
First Hints!!

June 28 2011
1380 bunches
1380

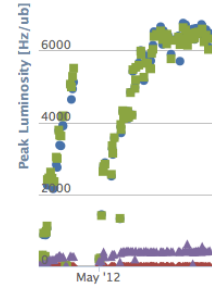

May 2012
Ramping
Performance

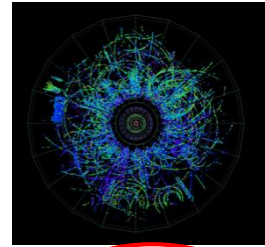

Feb. 2013
p-Pb⁸²⁺
New Operation
Mode

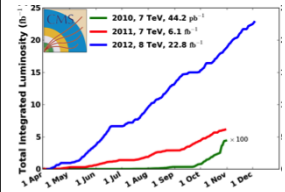

March 14th 2012
Restart
with Beam

Nov. 2012
End of p⁺ Run I

2008

2009

2010

2011

2012

2013

Sept. 19, 2008
Disaster

March 30, 2010
First collisions at 3.5 TeV

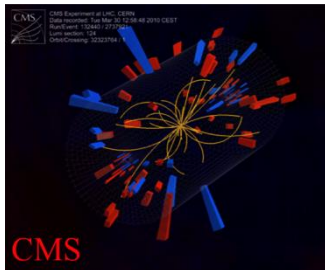

November 2010
Pb⁸²⁺ Ions



November 2011
Second Ion Run

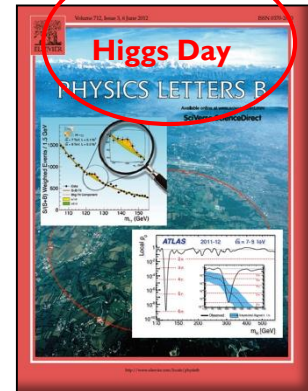

LSI

Filling the LHC (2012)

	25 ns (design)	50 ns (2012)	25 ns (2012)#
Energy per beam [TeV]	7	4	4
Intensity per bunch [$\times 10^{11}$]	1.15	1.7	1.2
Norm. Emittance H&V [μm]	3.75	1.8	2.7
Number of bunches	2808	1380	N.A.#
β^* [m]	0.55	0.6	N.A.#
Peak luminosity [$\text{cm}^{-2}\text{s}^{-1}$]	1×10^{34}	7.7×10^{33}	N.A.#

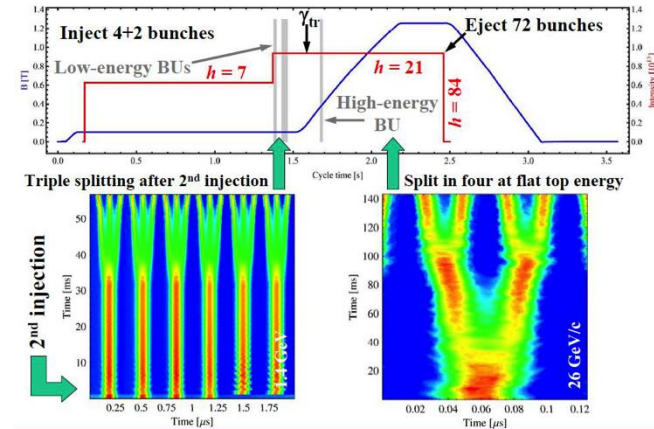

→ Each bunch from the Booster divided by 6 → $6 \times 3 \times 2 \times 2 = 72$

The 25 ns PS production scheme (2012)

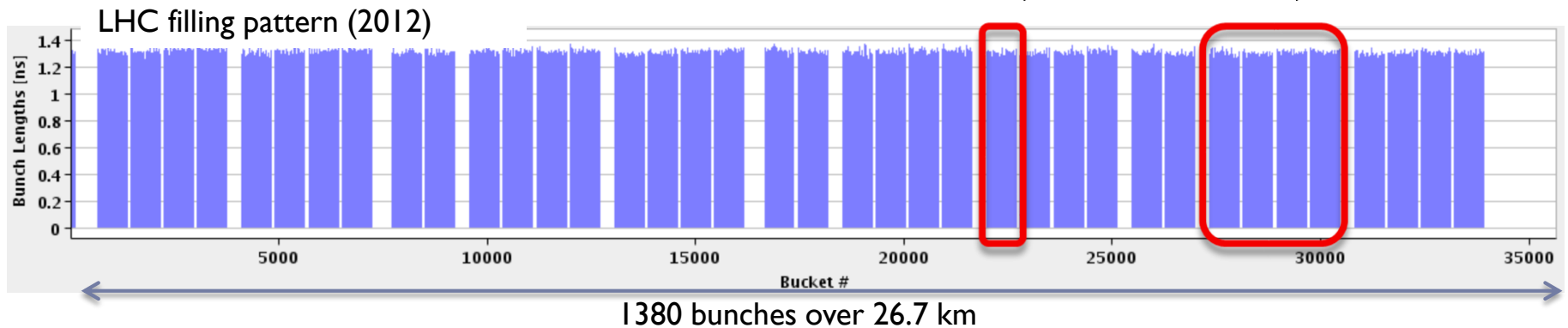

The 25 ns was only used for scrubbing and tests in 2012

CTF 3 – CLIC Test Facility

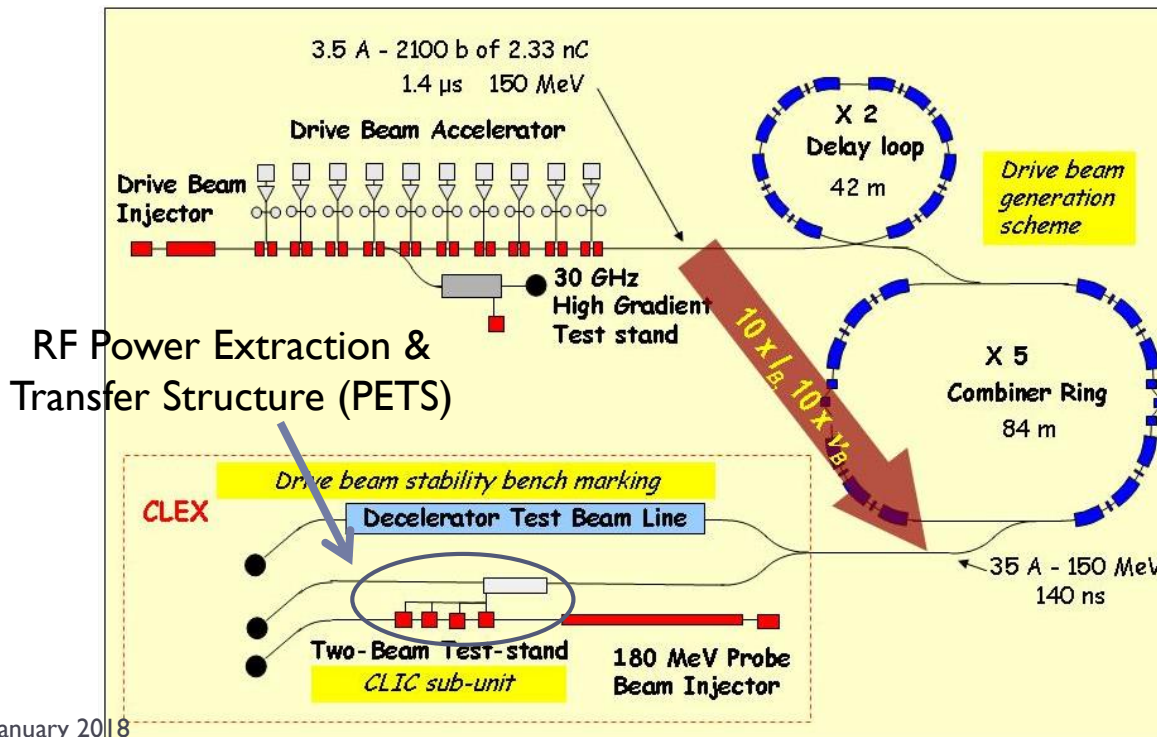
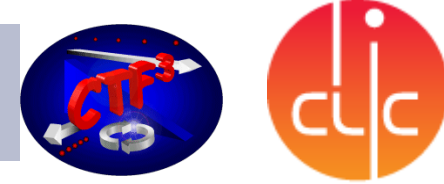

CLIC goal:

Drive Beam 100 A, 239 ns
2.38 GeV \rightarrow 240 MeV

Main Beam 1.2 A, 156 ns
9 GeV \rightarrow 1.5 TeV

CTF 3 – CLIC Test Facility

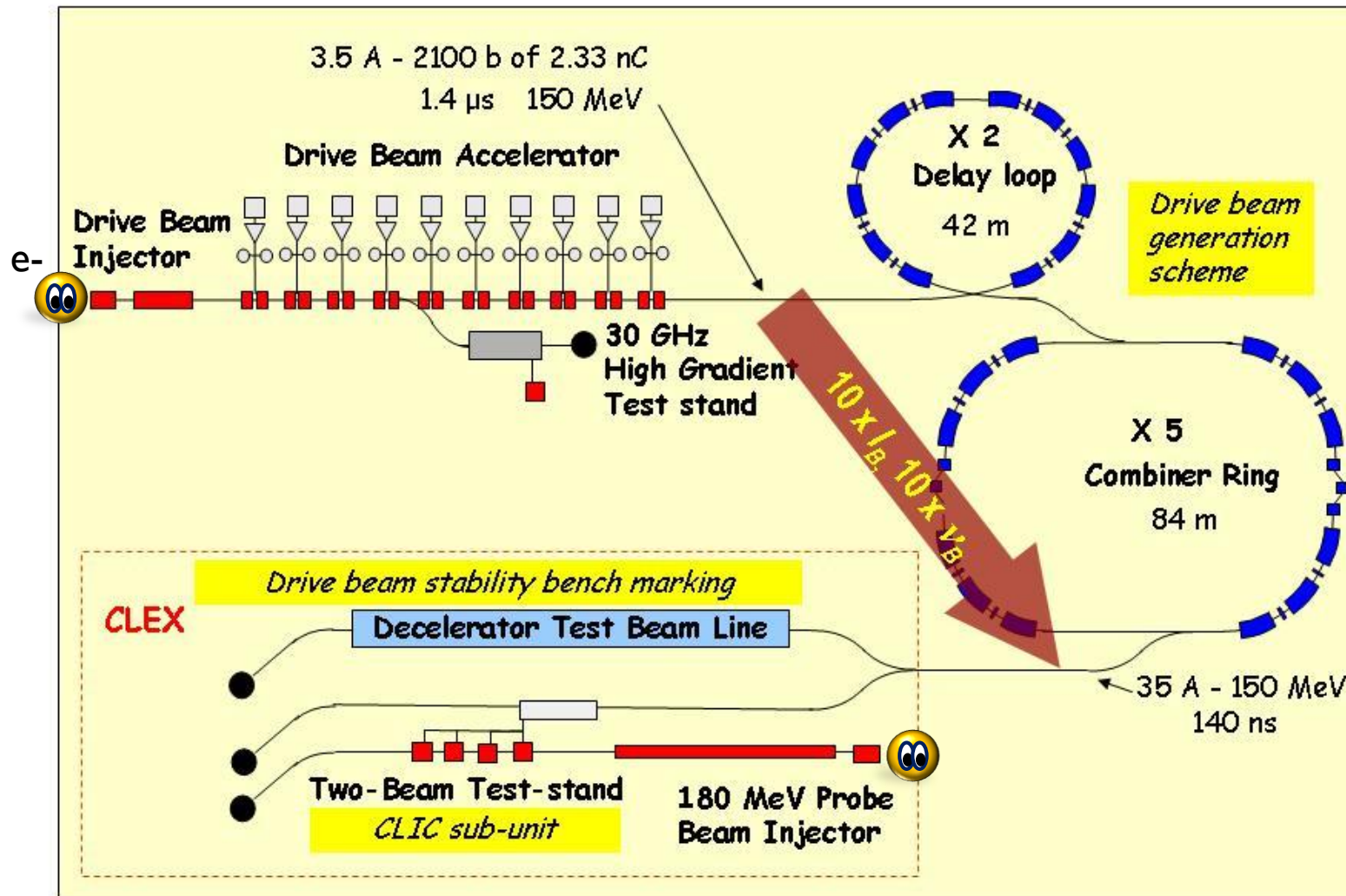
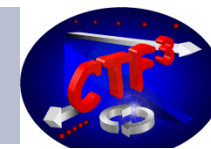

CTF 3 – CLIC Test Facility

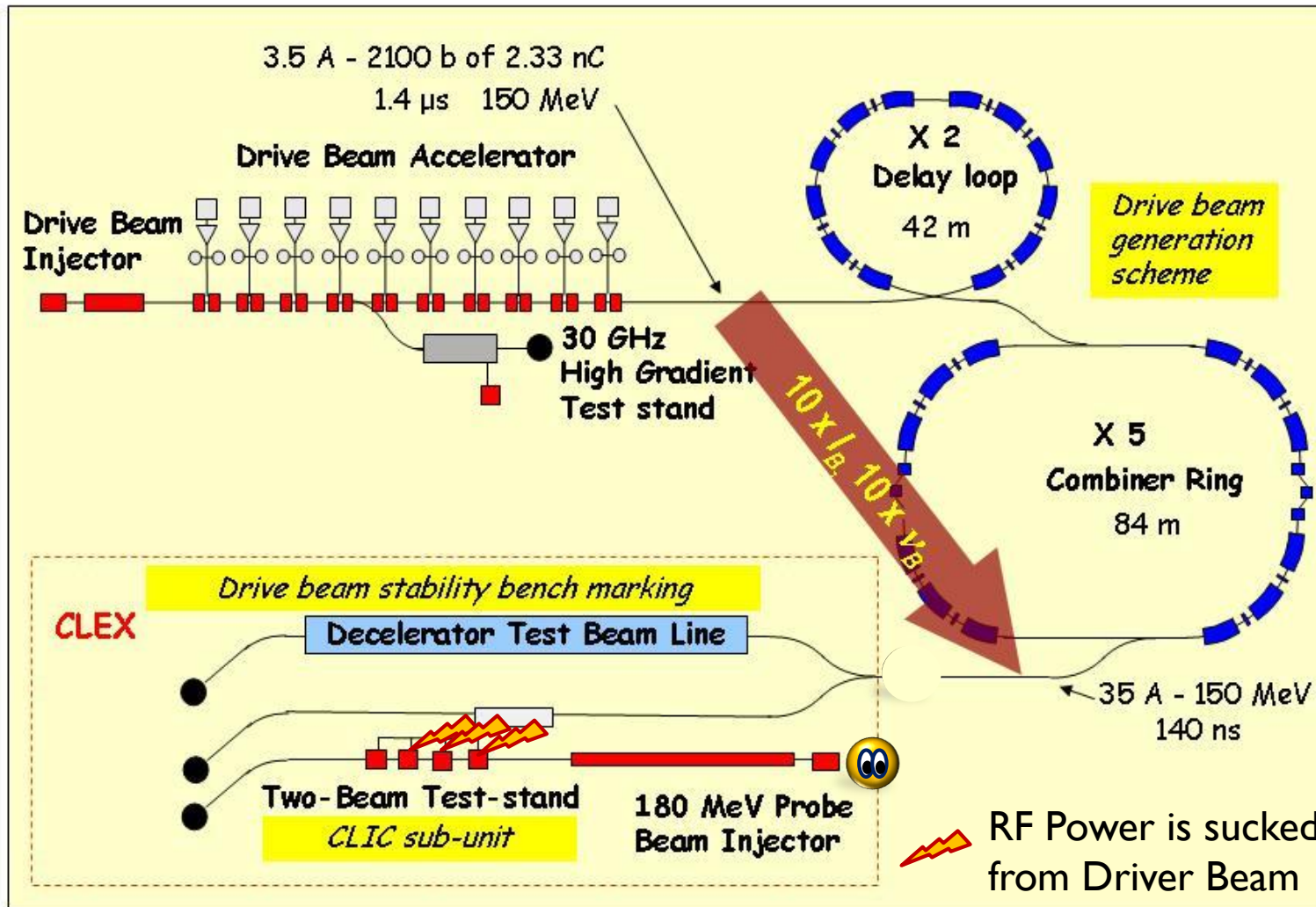
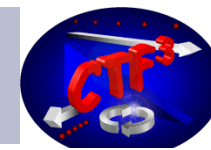

High Light Of HEP -Year

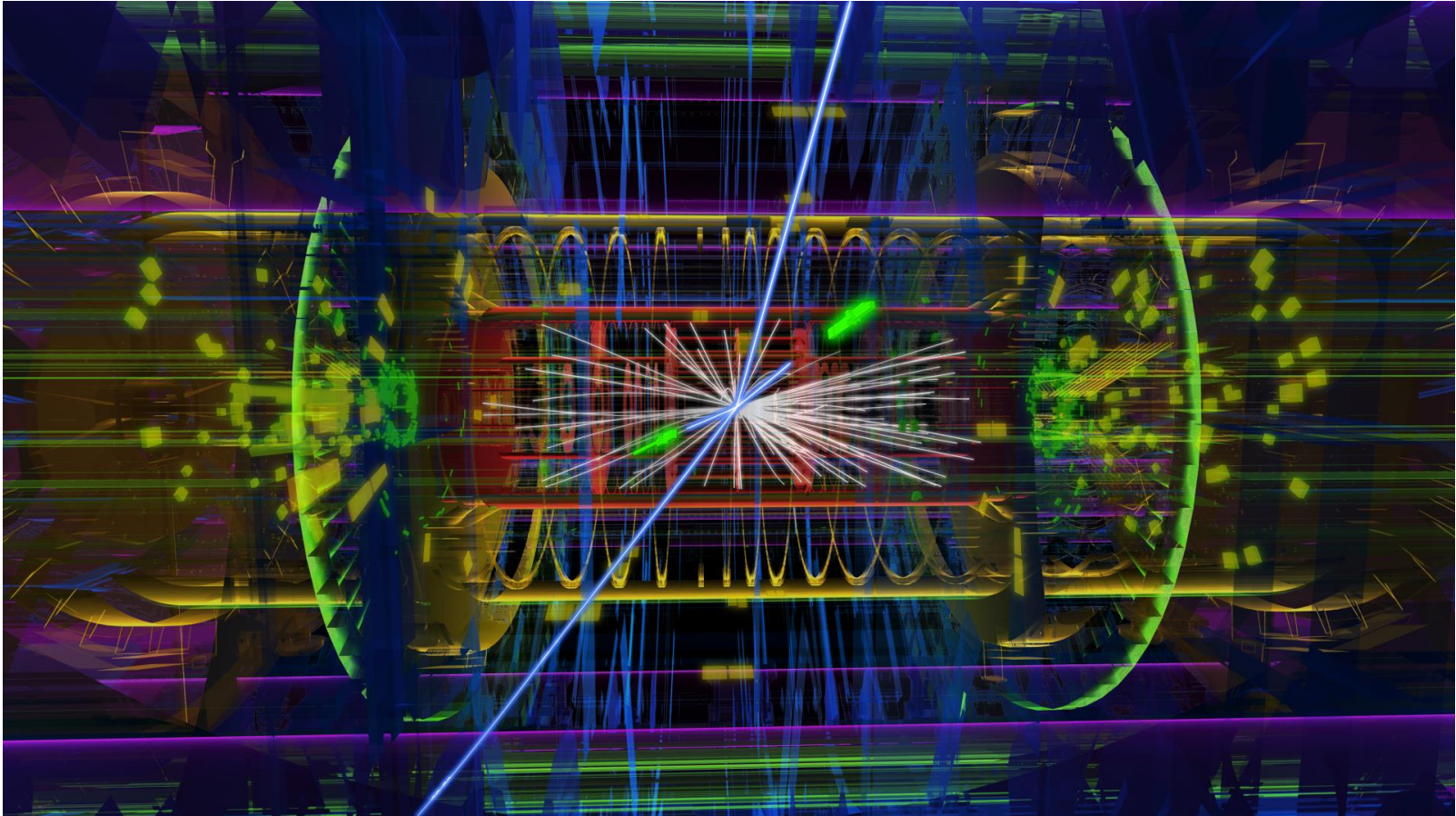

ATLAS event display: Higgs => two electrons & two muons

Linac4 : Replacing Linac2

Linac4 : Approved in 2007 as a replacement to Linac2

- Energy 160 MeV (cf 50 MeV in Linac2) Doubles the space charge tune shift limit at injection into the PS Booster
- H- Injection : CERN is one of the few labs still using p^+
- Connection to PSB LS2 (~ 2019)

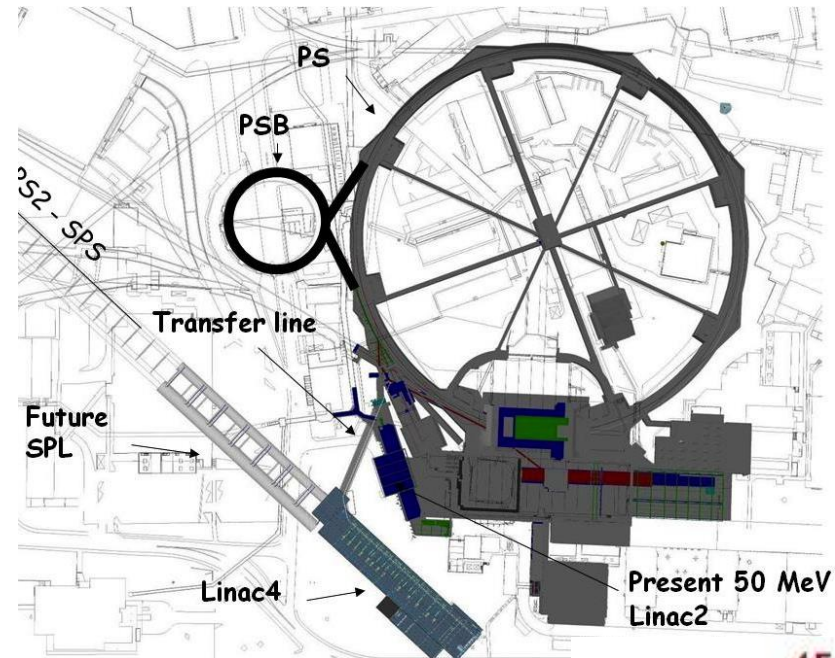

50 MeV → 160 MeV

$$0.31 \cdot 1.12 = 0.35 \rightarrow 0.52 \cdot 1.37 = 0.70$$

$$\Delta Q_{\text{LINAC4}} \approx 0.5 \Delta Q_{\text{LINAC2}}$$

$$\Delta Q_{SC} \propto \frac{N_b}{\epsilon_{X,Y}} \cdot \frac{R}{\beta\gamma^2}$$

with N_b : number of protons/bunch

$\epsilon_{X,Y}$: norm. transverse emittances

R : mean radius of the accelerator

Delivers 40 mA, 400 μ s pulses at 2 Hz



JUAS 2018 12 January 2018

352.2 MHz

H⁻ Injection

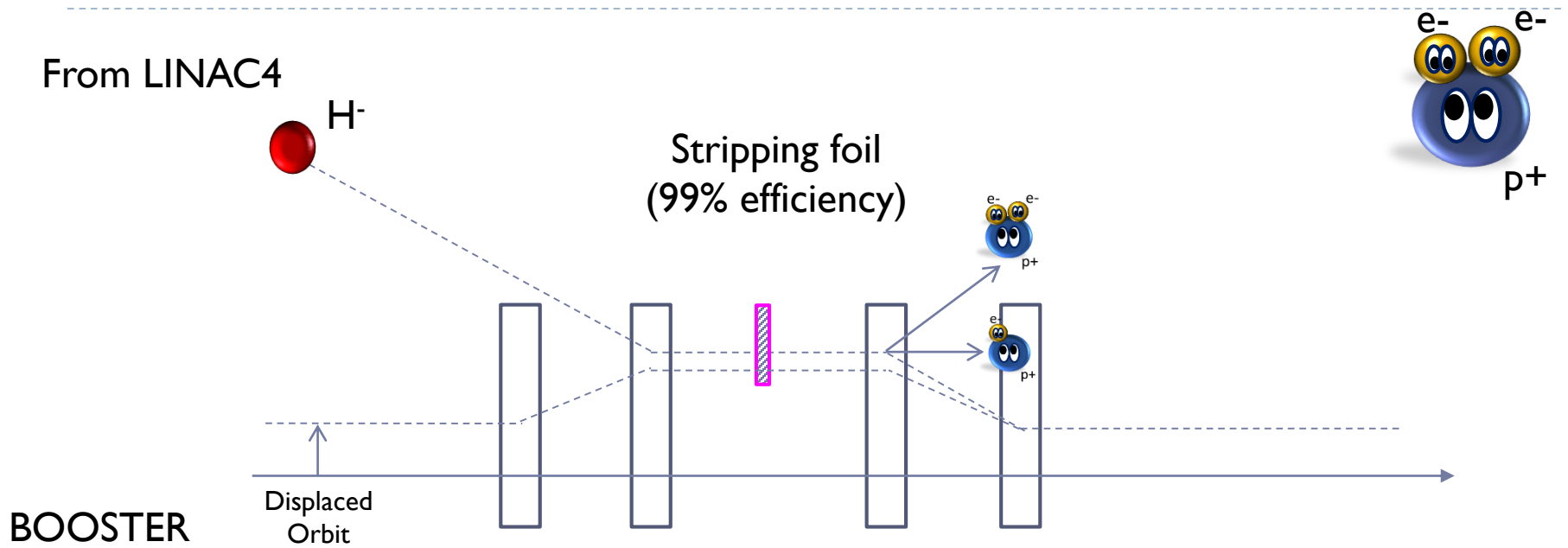



H⁻ Injection

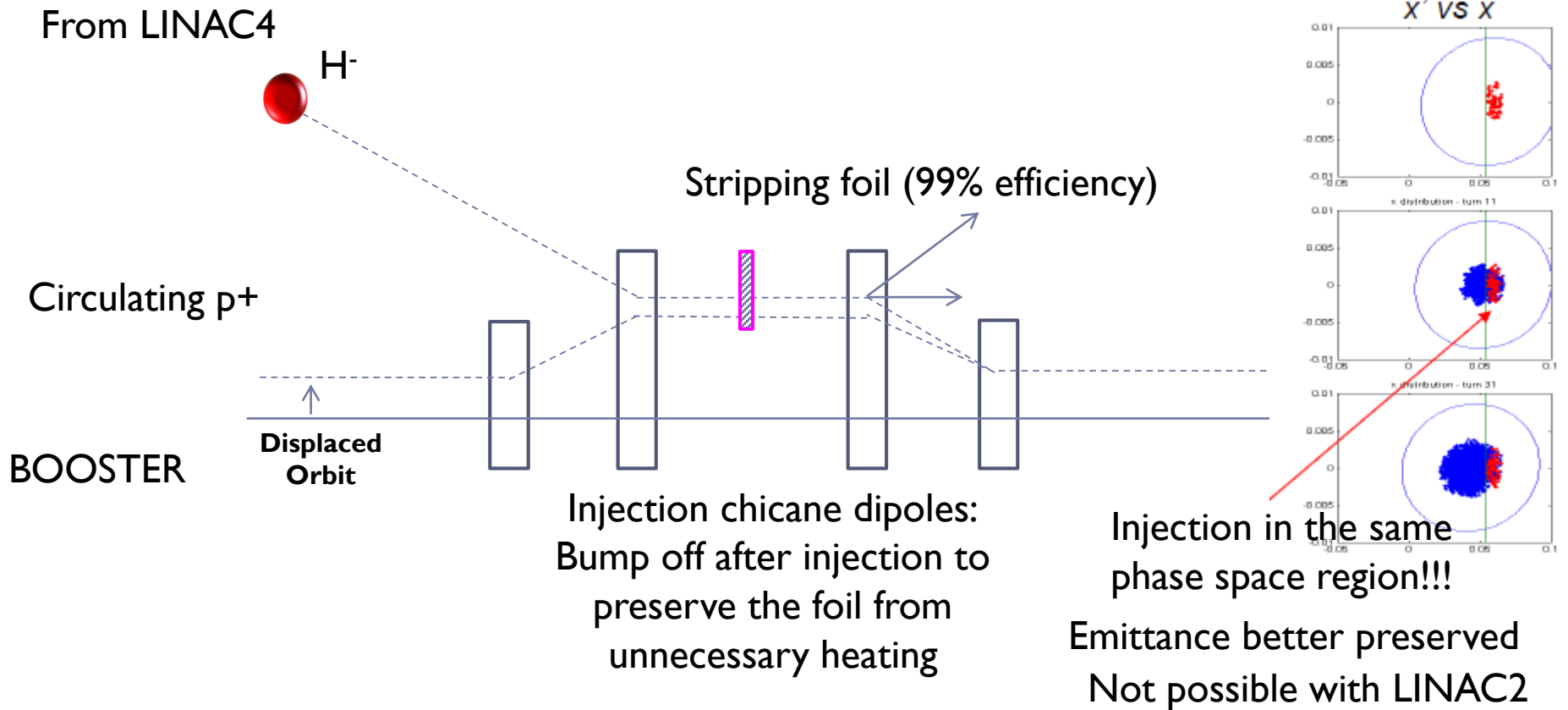

The most important plus! → since we can afford a SPACE CHARGE $\Delta Q_{50\text{MeV}}$ →

But $\Delta Q_{\text{LINAC4}(160\text{MeV})} \approx 0.5 \Delta Q_{\text{LINAC2}(50\text{MeV})}$

$$\Delta Q_{SC} \propto \frac{N_b}{\epsilon_{X,Y}} \cdot \frac{R}{\beta\gamma^2}$$

$N_b^{\text{LINAC4}} \approx 2 N_b^{\text{LINAC2}}!!!$

Let me open a parenthesis here to talk about

EMITTANCE and PHASE SPACE



(Phase space and emittance)

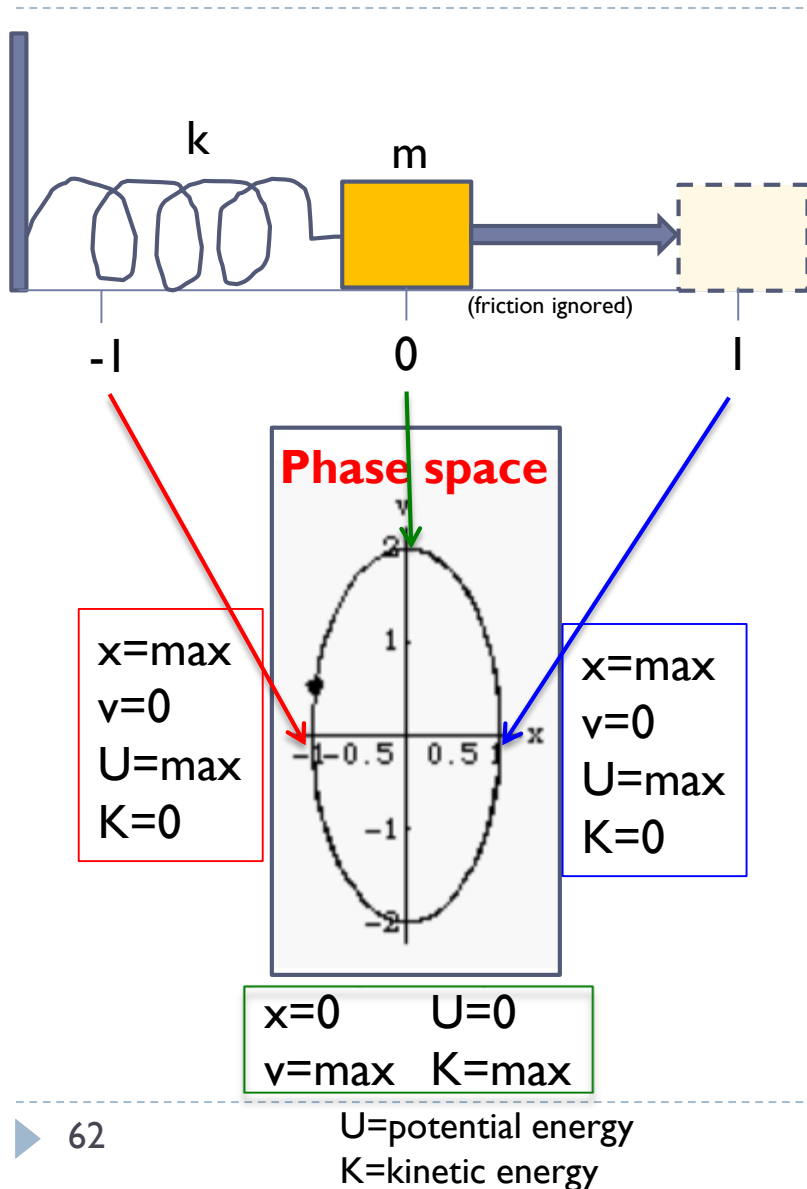

Analysis of $x=f(t) \rightarrow$ provides information about the **path** taken by the system **BUT NOT** about the **energy**.

Analysis of $v=f(t) \rightarrow$ provides information about the **energy** of the system **BUT NOT** about the **trajectory** taken.

... Let's be inventive and try to analyse the evolution of the velocity as a function of position $v=f(x)$

(Phase space and emittance)

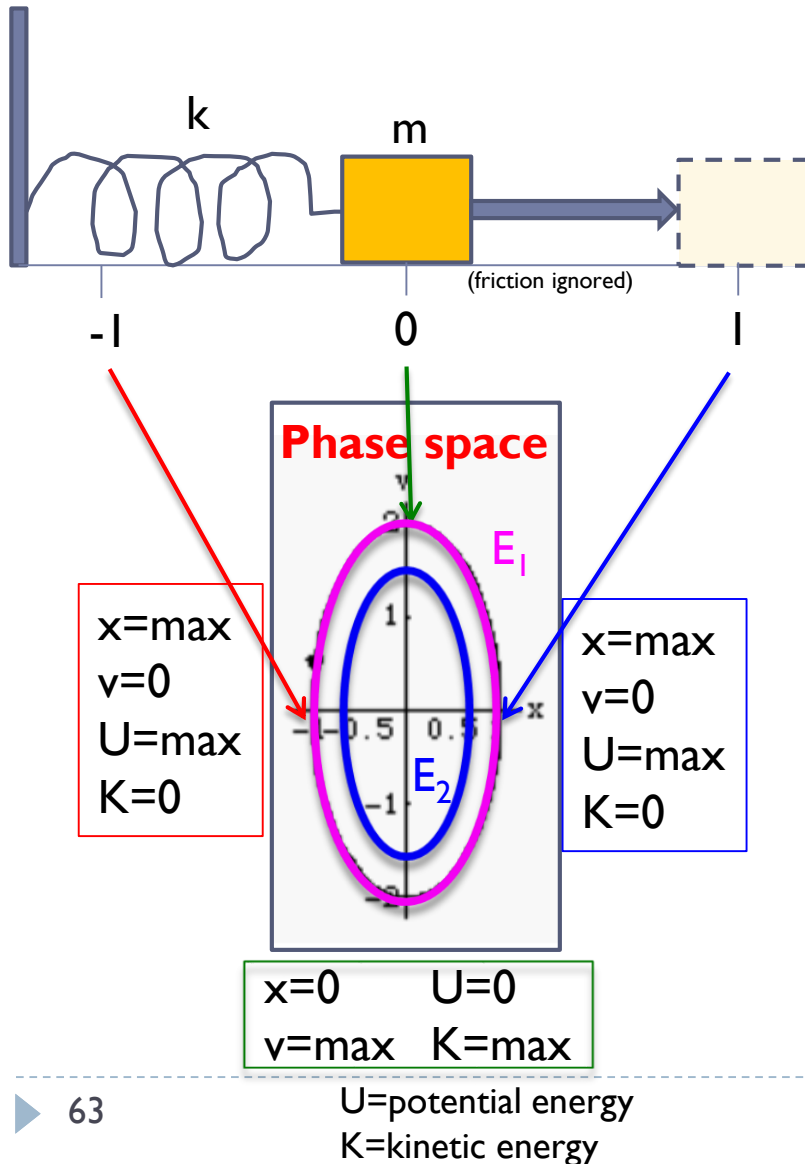

- ◆ Each point (x,v) in the ellipse represents an STATE of the physical system with well define position and velocity.
- ◆ All the points (x,v) in the ellipse have the SAME ENERGY (E_1)
- ◆ If the initial elongation is smaller, then we get a smaller ellipse with energy E_2 ($E_2 < E_1$).
- ◆ If we change K the ellipse shape will change.

A beam of charged particles in an accelerator subjected to focusing and defocusing forces have the same dynamics as the system above. The beam dynamics also reproduces an ellipse in phase space ...

(Phase space and emittance)

All particles with the **same initial betatron amplitude** (equivalent to x) at a given position in the accelerator (or time) but different phases or momentum due to momentum spread (equivalent to v), describe the **same ellipse** turn after turn

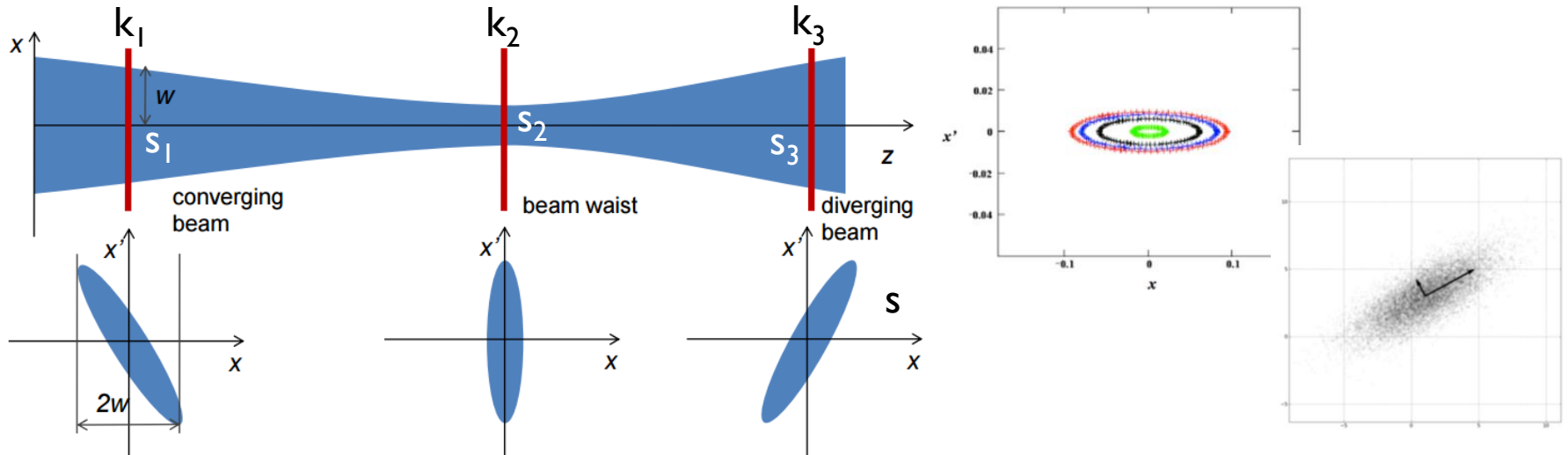

Along a beam line, the orientation and aspect ratio of the ellipse varies, **BUT THE AREA** remains **CONSTANT** in the absence of non-linear forces or acceleration

AREA \approx EMITTANCE (\mathcal{E})

Beam size $\rightarrow \sigma = \sqrt{\mathcal{E}\beta}$ (in places without dispersion)

Let me use the BOOSTER injection to talk
about

TUNE, PHASE SPACE PAINTING,
SPACE CHARGE BRIGHTNESS



PS Booster: $E_{inj}=50\text{MeV}$, $C=154\text{ m}$

Pulse from LINAC2 = $100\ \mu\text{s}$

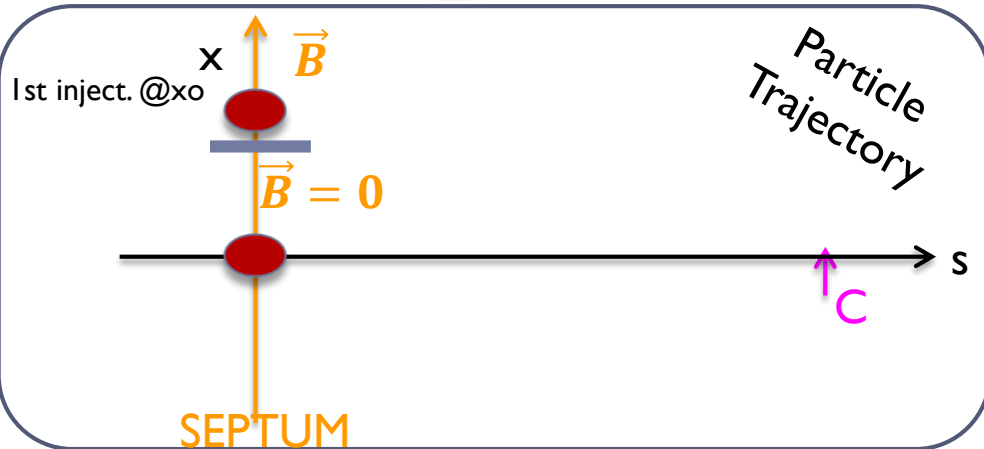
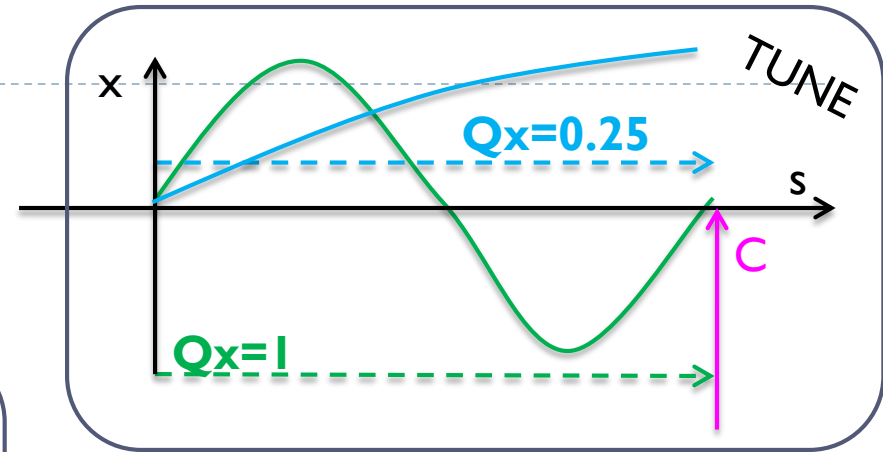
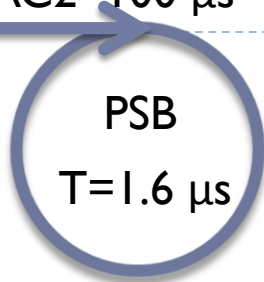

PS Booster: $E_{inj}=50\text{MeV}$, $C=154\text{ m}$

Pulse from LINAC2 = $100\ \mu\text{s}$

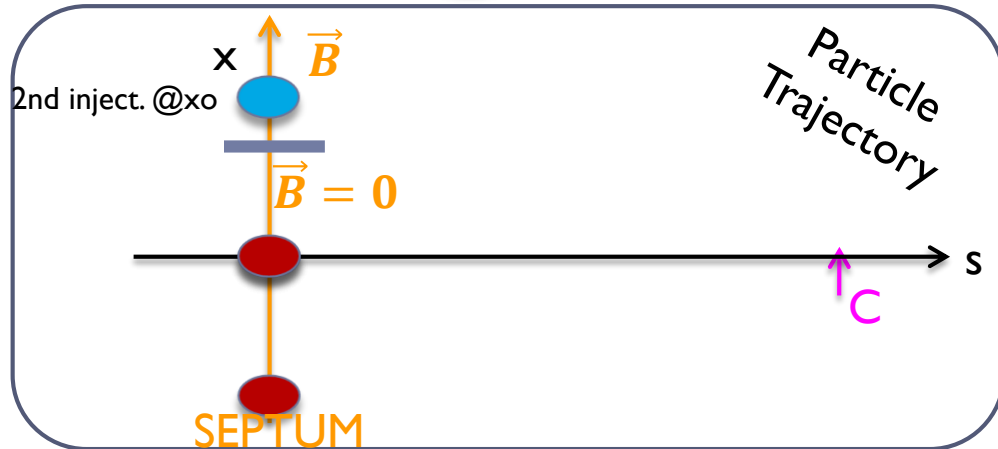
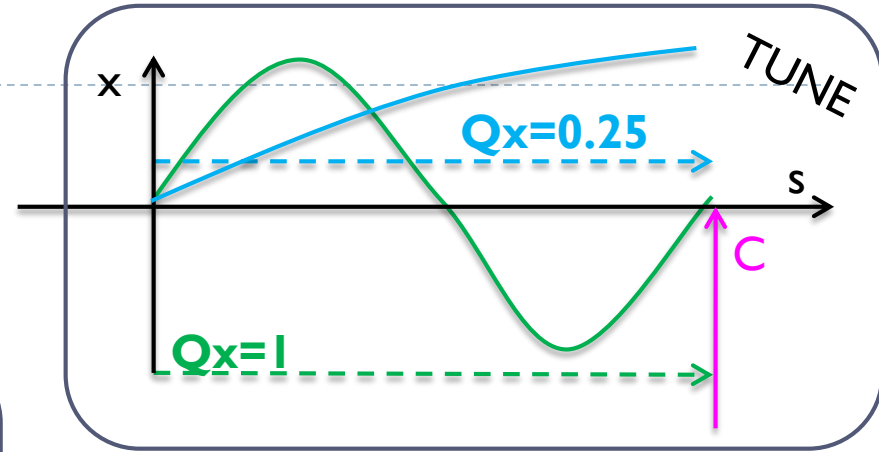
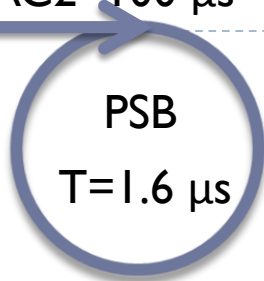

PS Booster: $E_{inj}=50\text{MeV}$, $C=154\text{ m}$

Pulse from LINAC2 = $100\ \mu\text{s}$

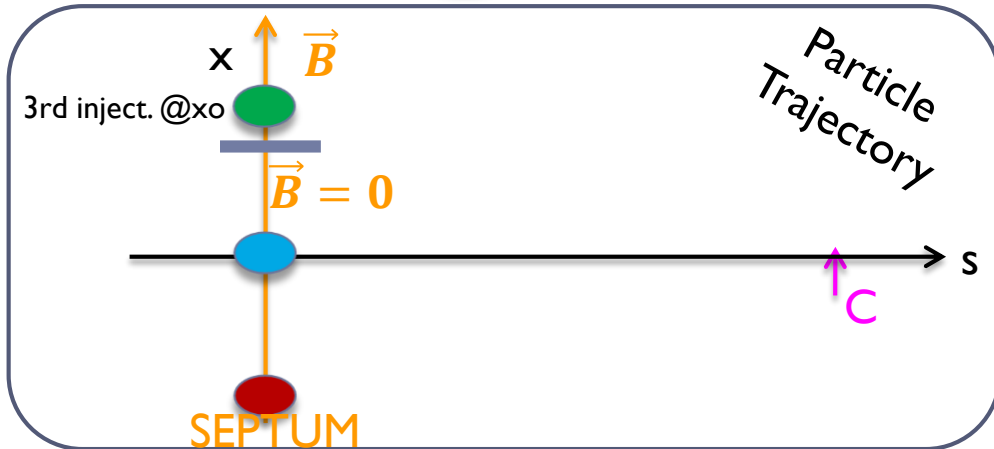
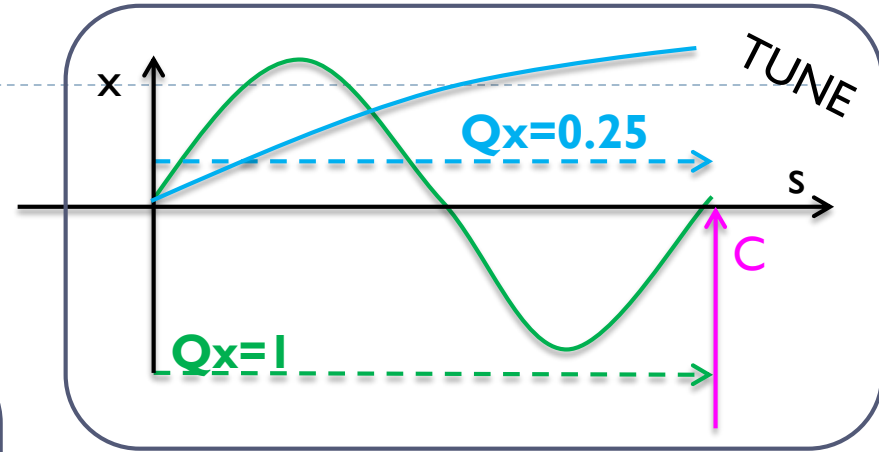
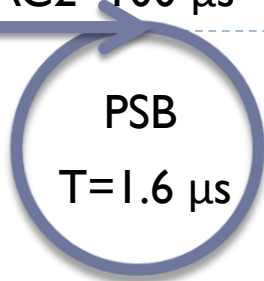

PS Booster: $E_{inj}=50\text{MeV}$, $C=154\text{ m}$

Pulse from LINAC2 = $100\ \mu\text{s}$

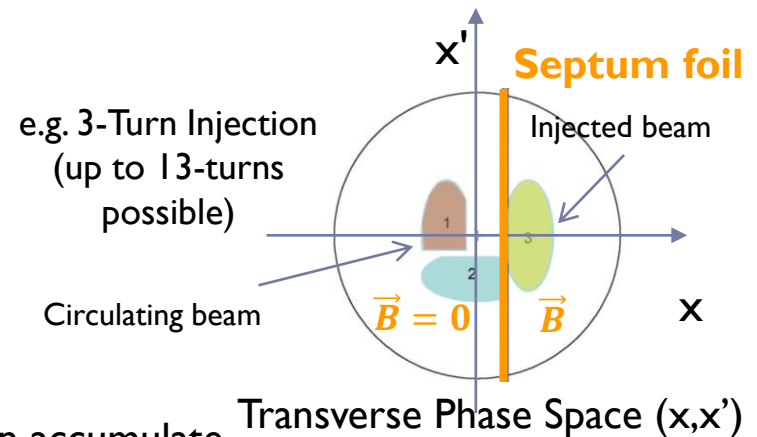
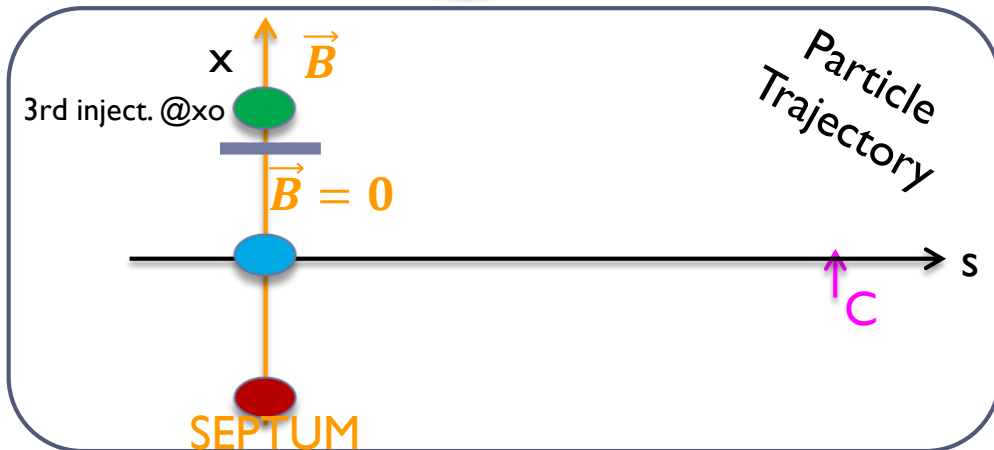
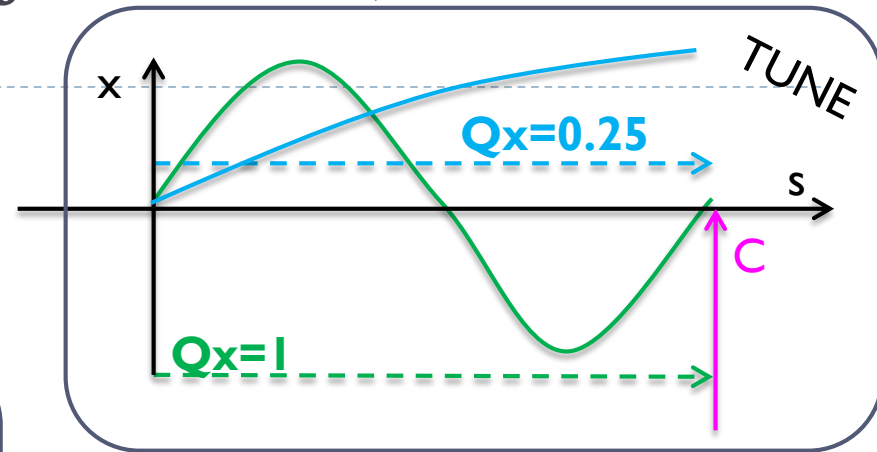
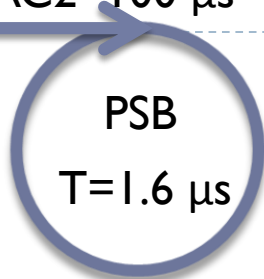

- The bigger the number of turns the more intensity we can accumulate
- The problem is that the longer the injection takes, the more time the particles have to fill the whole available phase space + SPACE CHARGE \rightarrow emittance increases \rightarrow beam size increases
- **The Booster is the machine in the LHC Injector Chain where the transverse brightness of the LHC beam is determined**

$$\text{Brightness} = \text{Intensity}/\text{Emittance}$$

(Space Charge in One Slide)

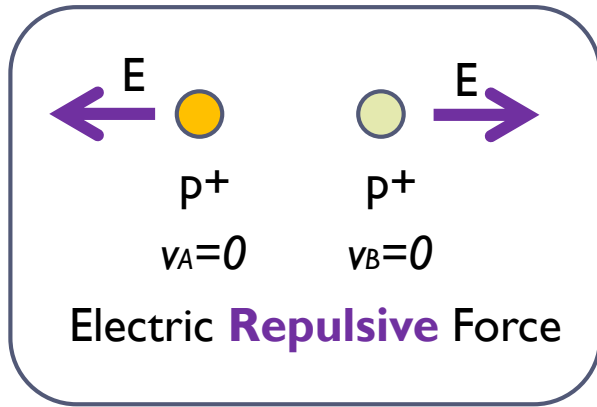

+

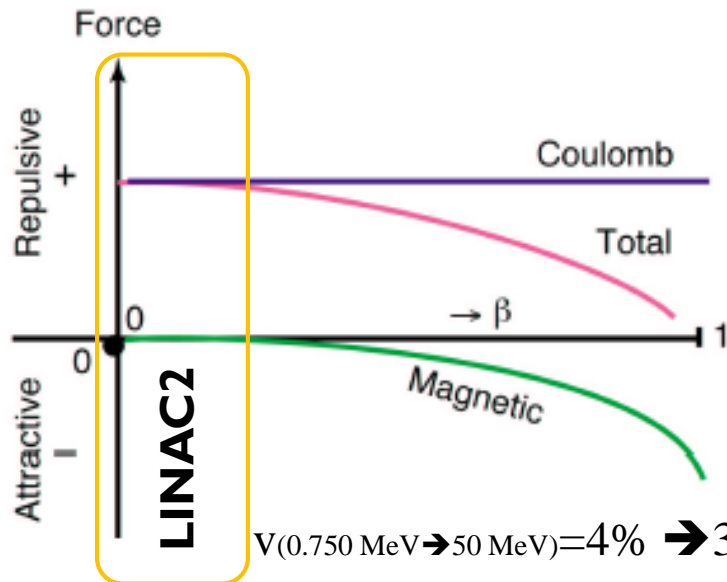
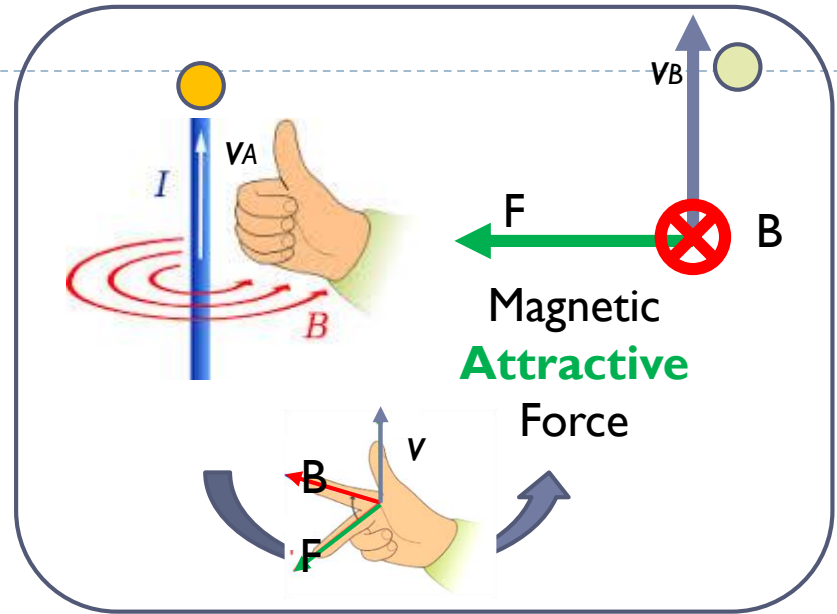

$$\beta = \frac{v}{c}$$

$v(0.750 \text{ MeV} \rightarrow 50 \text{ MeV})=4\% \rightarrow 31\% \text{ of } c$

Particles in the beam feel a strong repulsive force = defocusing quadrupole \rightarrow

change in tune

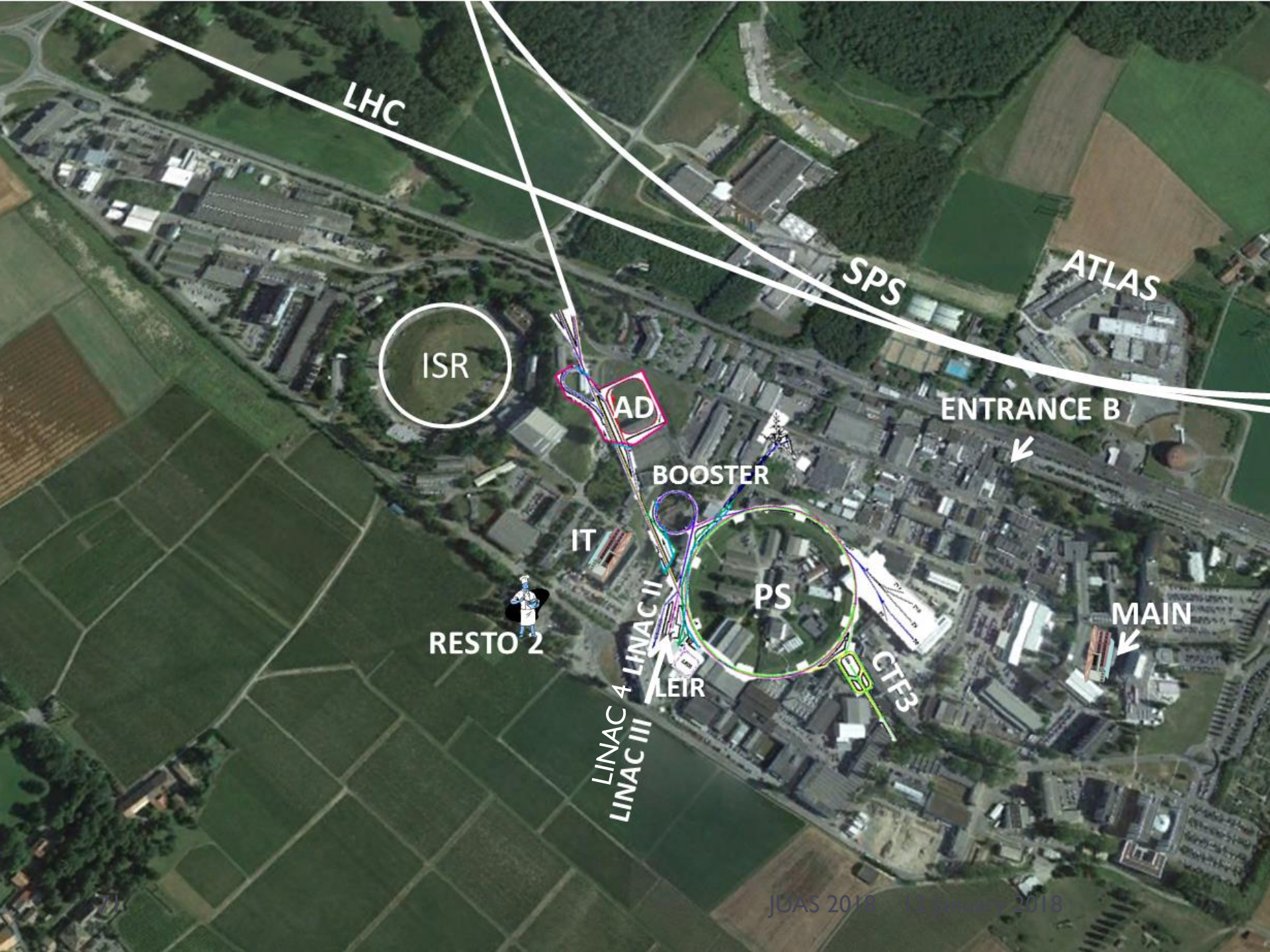

LHC

SPS

ATLAS

ISR

AD

ENTRANCE B

BOOSTER

IT

PS

MAIN

RESTO 2

LINAC 4
LINAC III
LINAC II

LEIR

CTF3