



2018 Joint Universities Accelerator School

Superconducting Magnets Section II

Paolo Ferracin

(paolo.ferracin@cern.ch)

European Organization for Nuclear Research (CERN)



Outline

- **Section I**
 - Particle accelerators and magnets
 - Superconductivity and practical superconductors
- **Section II**
 - **Magnetic design**
- **Section III**
 - Coil fabrication
 - Forces, stress, pre-stress
 - Support structures
- **Section IV**
 - Quench, training, protection

Magnetic design Introduction

- The magnetic design is one of the first steps in the a superconducting magnet development
- It starts from the **requirements** (from accelerator physicists, researchers, medical doctors...others)
 - A field “**shape**”
 - Dipole, quadrupole, etc
 - A field **magnitude**
 - Usually with low T superconductors from 5 to 20 T
 - A field **homogeneity**
 - Uniformity inside a solenoid, harmonics in a accelerator magnet
 - A given **aperture** (and **volume**)
 - Some cm diameter for accelerator magnets, much more for detectors and fusion magnets

- **How much** conductor do we need to meet the requirements?
- And in **which configuration**?
- **Outline**
 - How do we create a **perfect field**?
 - How do we express the field and its “**imperfections**”?
 - How do we **design a coil** to minimize field errors?
 - Which is the **maximum field** we can get?
 - **Overview** of different designs

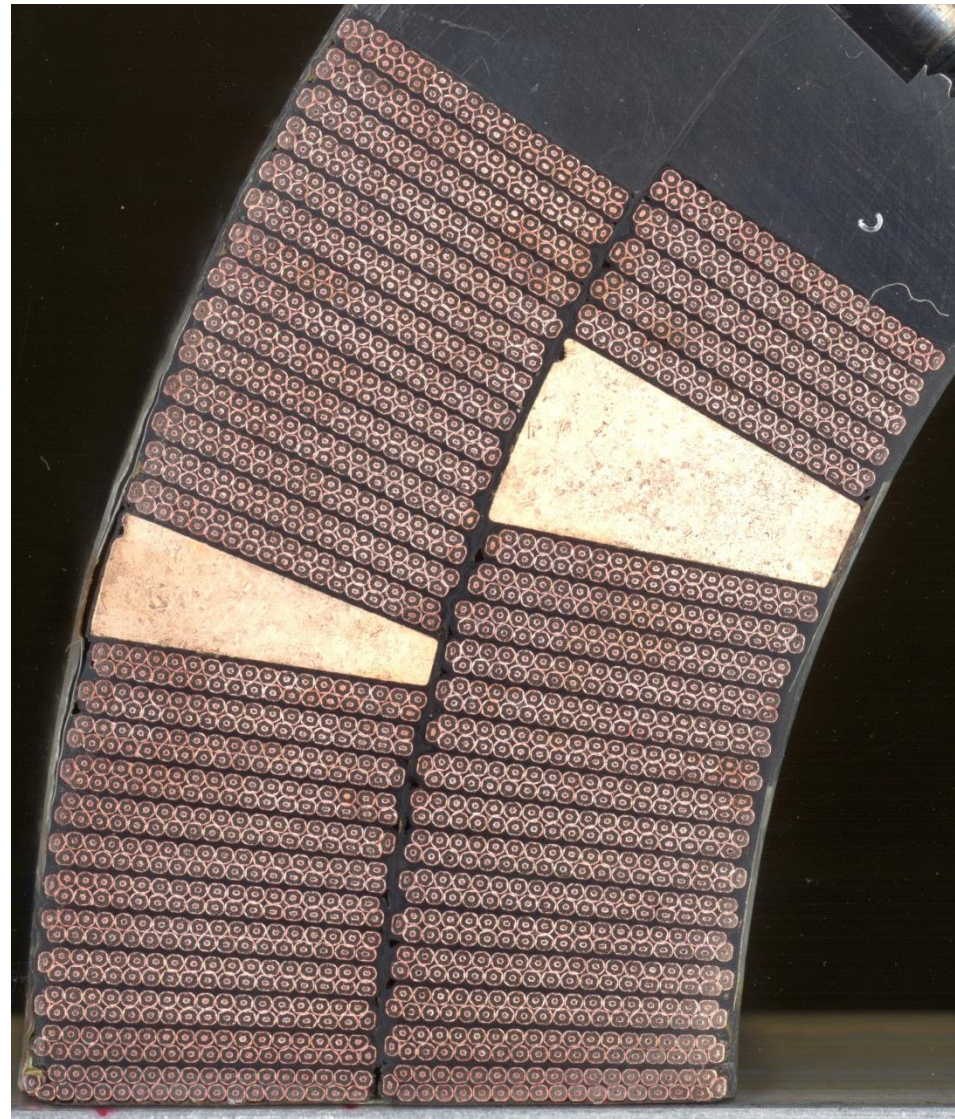



References

● Magnetic design

- K.-H. Mess, P. Schmuser, S. Wolff, "*Superconducting accelerator magnets*", Singapore: World Scientific, 1996.
- Martin N. Wilson, "*Superconducting Magnets*", 1983.
- Fred M. Asner, "*High Field Superconducting Magnets*", 1999.
- S. Russenschuck, "*Field computation for accelerator magnets*", J. Wiley & Sons (2010).

- P. Ferracin, E. Todesco, S. Prestemon, "*Superconducting accelerator magnets*", US Particle Accelerator School, www.uspas.fnal.gov.
 - Units 5, 8, 9 by E. Todesco
- A. Jain, "*Basic theory of magnets*", CERN 98-05 (1998) 1-26

- L. Rossi, E. Todesco, "*Electromagnetic design of superconducting quadrupoles*", Phys. Rev. ST Accel. Beams 10 (2007) 112401.
- L. Rossi and Ezio Todesco, "*Electromagnetic design of superconducting dipoles based on sector coils*", Phys. Rev. ST Accel. Beams 9 (2006) 102401.

Perfect dipole field

Intercepting circles (or ellipses)

- Within a cylinder carrying j_0 , the field is perpendicular to the radial direction and proportional to the distance to the centre r :

$$B = -\frac{\mu_0 j_0 r}{2}$$

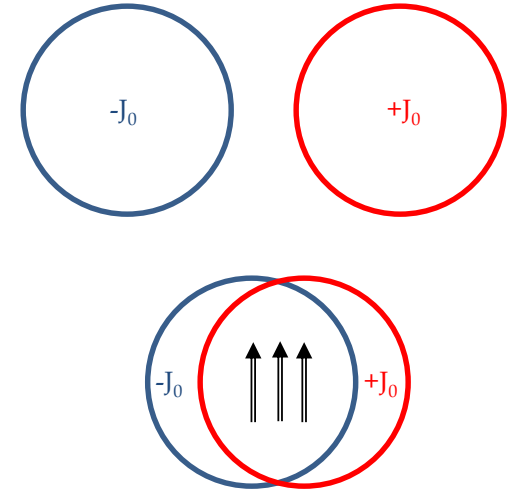

- Combining the effect of two intersecting cylinders

$$B_x = \frac{\mu_0 j_0 r}{2} \{-r_1 \sin \theta_1 + r_2 \sin \theta_2\} = 0$$

$$B_y = \frac{\mu_0 j_0 r}{2} \{-r_1 \cos \theta_1 + r_2 \cos \theta_2\} = -\frac{\mu_0 j_0}{2} s$$

- A uniform current density in the area of two **intersecting circles** produces a pure dipole
 - The aperture is not circular
 - Not easy to simulate with a flat cable
- Similar proof for **intersecting ellipses**

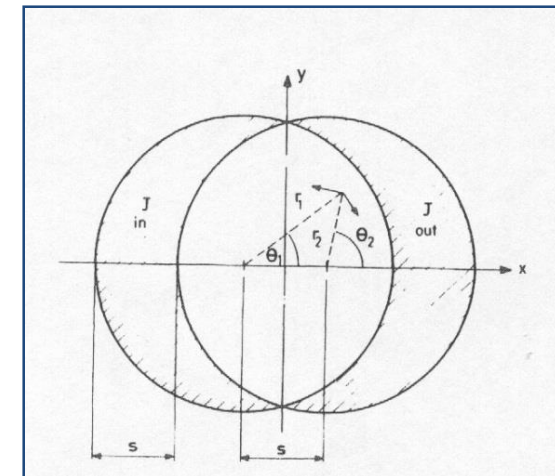

by M. Wilson

Perfect dipole field

Thick shell with $\cos\theta$ current distribution

- If we assume
 - $J = J_0 \cos\theta$ where J_0 [A/m²] is \perp to the cross-section plane
 - Inner (outer) radius of the coils = a_1 (a_2)

- The generated field is a **pure dipole**

$$B_y = -\frac{\mu_0 J_0}{2} (a_2 - a_1)$$

- Linear dependence on **coil width**

- **Easier** to achieve with a Rutherford cable

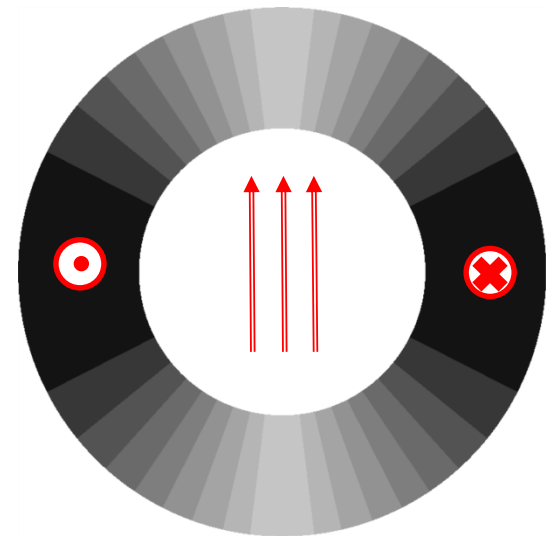
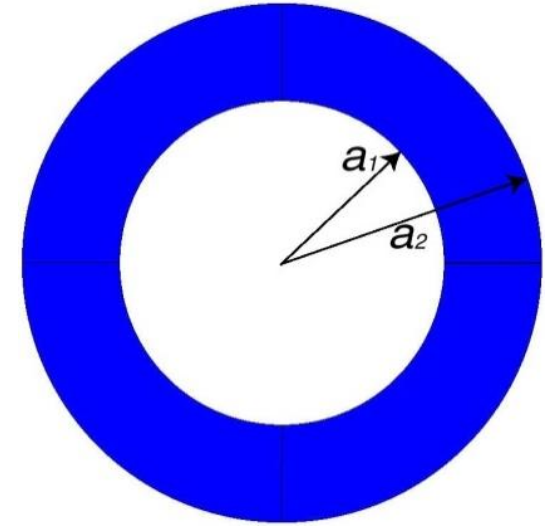

Perfect quadrupole field

- **Intercepting ellipses** or circles
- Thick shell with **$\cos 2\theta$ current distribution**
- If we assume
 - $J = J_0 \cos 2\theta$ where J_0 [A/m²] is \perp to the cross-section plane
 - Inner (outer) radius of the coils = a_1 (a_2)

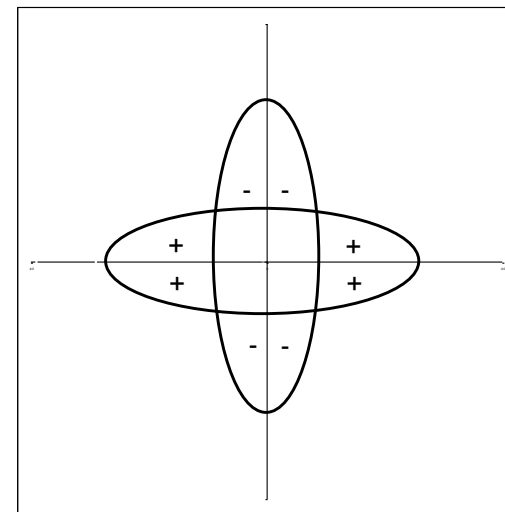

$$G = \frac{B_y}{r} = -\frac{\mu_0 J_0}{2} \ln \frac{a_2}{a_1}$$

- And so on...
 - Perfect sextupoles: **$\cos 3\theta$** or **3** intersect. ellipses
 - Perfect $2n$ -poles: **$\cos n\theta$** or **n** intersecting ellipses

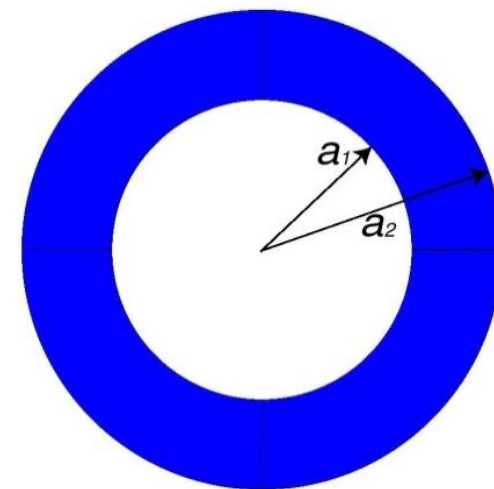

From ideal to practical configuration

- How can I reproduce **thick shell with a $\cos\theta$** distribution with a cable?
 - Rectangular cross-section and constant J
- First “rough” approximation
 - **Sector dipole**
- Better ones
 - More **layers** and **wedges** to reduce J towards 90°
- As a result, the field is **not perfect** anymore
 - How can I express in improve the “imperfect” field inside the aperture?

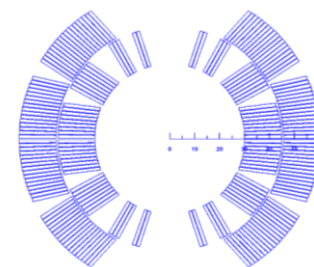
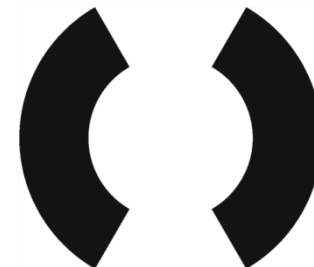
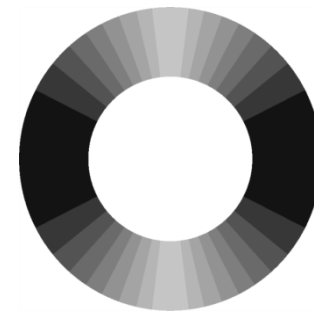

- **How much** conductor do we need to meet the requirements?
- And in **which configuration**?
- **Outline**
 - How do we create a **perfect field**?
 - How do we express the field and its **“imperfections”**?
 - How do we **design a coil** to minimize field errors?
 - Which is the **maximum field** we can get?
 - **Overview** of different designs

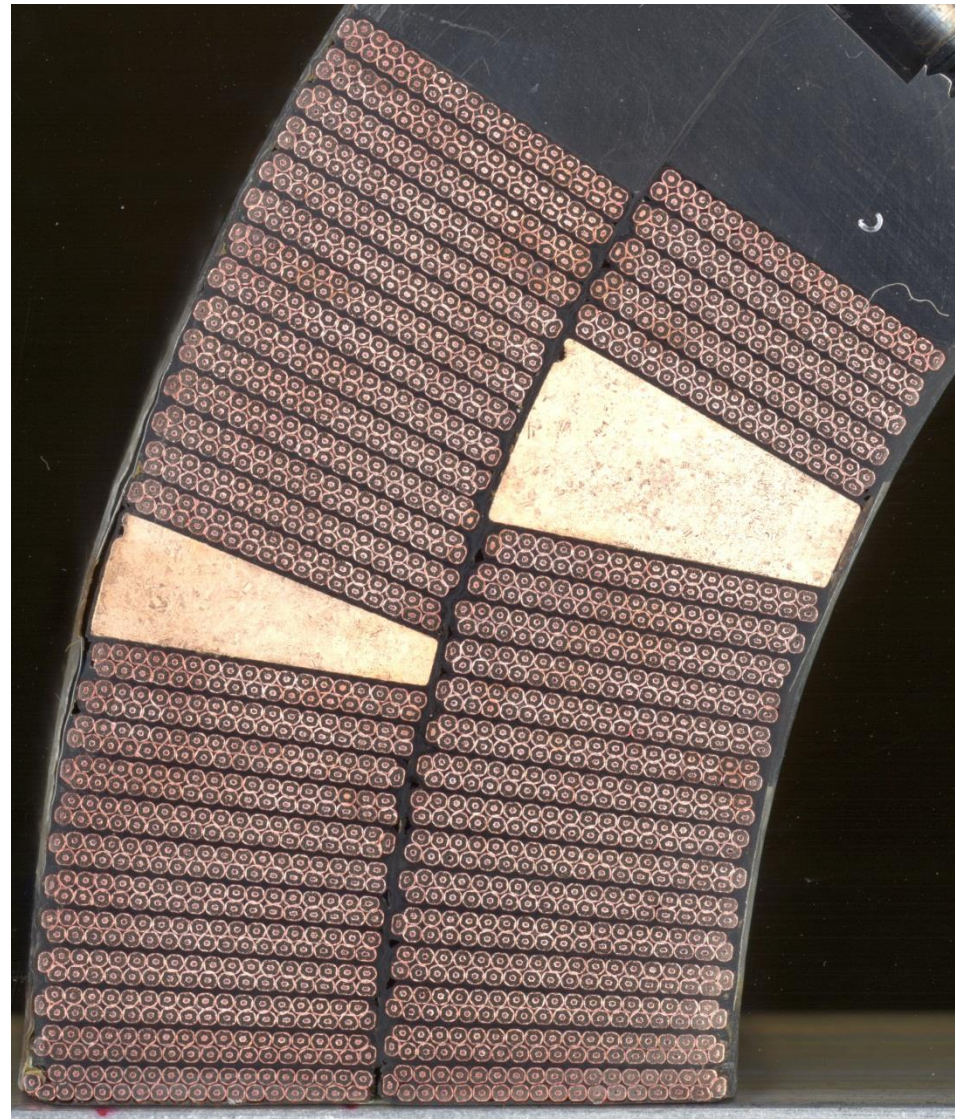

Field representation

Maxwell equations

- **Maxwell equations** for magnetic field

$$\nabla \cdot \mathbf{B} = \frac{\partial B_x}{\partial x} + \frac{\partial B_y}{\partial y} + \frac{\partial B_z}{\partial z} = 0 \quad \nabla \times \mathbf{B} = \mu_0 \mathbf{J} + \mu_0 \epsilon_0 \frac{\partial \mathbf{E}}{\partial t}$$

- In absence of charge and magnetized material

$$\nabla \times \mathbf{B} = \left(\frac{\partial B_y}{\partial z} - \frac{\partial B_z}{\partial y}, \frac{\partial B_z}{\partial x} - \frac{\partial B_x}{\partial z}, \frac{\partial B_x}{\partial y} - \frac{\partial B_y}{\partial x} \right) = 0$$

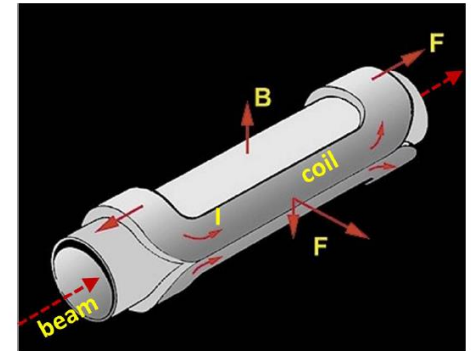

- If $\frac{\partial B_z}{\partial z} = 0$ (constant longitudinal field), then

$$\frac{\partial B_x}{\partial x} + \frac{\partial B_y}{\partial y} = 0 \quad \frac{\partial B_x}{\partial y} - \frac{\partial B_y}{\partial x} = 0$$

Field representation

Analytic functions

- If $\frac{\partial B_z}{\partial z} = 0$

Maxwell gives

$$\frac{\partial B_y}{\partial x} - \frac{\partial B_x}{\partial y} = 0$$

$$\frac{\partial B_y}{\partial y} + \frac{\partial B_x}{\partial x} = 0$$

$$\begin{cases} \frac{\partial f_x}{\partial x} - \frac{\partial f_y}{\partial y} = 0 \\ \frac{\partial f_x}{\partial y} + \frac{\partial f_y}{\partial x} = 0 \end{cases}$$

Cauchy-Riemann conditions

and therefore the function $B_y + iB_x$ is analytic

$$B_y(x, y) + iB_x(x, y) = \sum_{n=1}^{\infty} C_n (x + iy)^{n-1}$$

where C_n are **complex coefficients**

$$B_y(x, y) + iB_x(x, y) = \sum_{n=1}^{\infty} C_n (x + iy)^{n-1} = \sum_{n=1}^{\infty} (B_n + iA_n) (x + iy)^{n-1}$$

- Advantage: we reduce the description of the field to a (simple) series of complex coefficients

Field representation Harmonics

- What are these coefficients (or **harmonics**)?

$$B_y(x, y) + iB_x(x, y) = \sum_{n=1}^{\infty} C_n (x + iy)^{n-1} = \sum_{n=1}^{\infty} (B_n + iA_n) (x + iy)^{n-1}$$

- For $n=1 \rightarrow$ *dipole*

$$B_y + iB_x \Rightarrow (B_1 + iA_1)$$

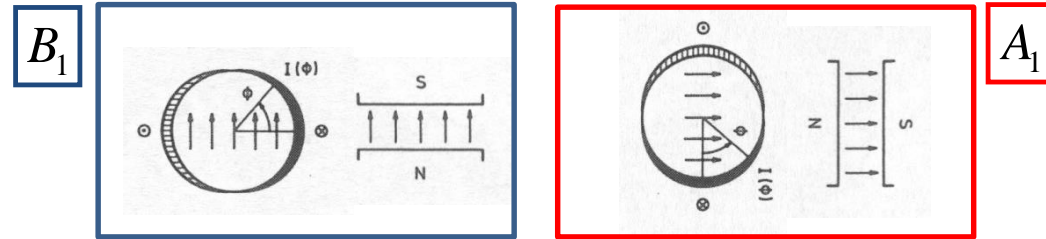

- For $n=2 \rightarrow$ *quadrupole*

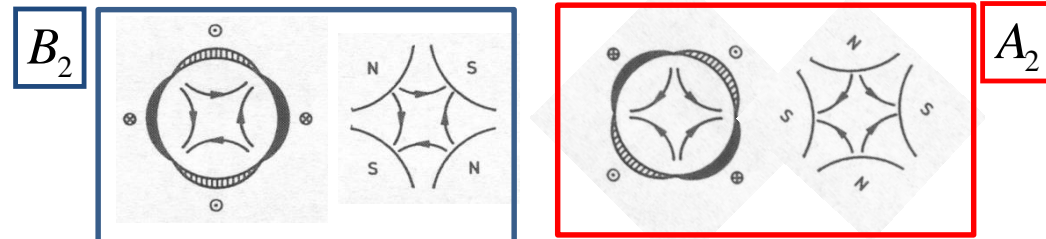

by K.-H. Mess, et al.

$$B_y + iB_x \Rightarrow (B_2 + iA_2)(x + iy) = (B_2x + iB_2y) + (iA_2x - A_2y)$$

Field representation Harmonics

- So, each coefficient corresponds to a “pure” multipolar field

$$B_y(x, y) + iB_x(x, y) = \sum_{n=1}^{\infty} C_n (x + iy)^{n-1} = \sum_{n=1}^{\infty} (B_n + iA_n) (x + iy)^{n-1}$$

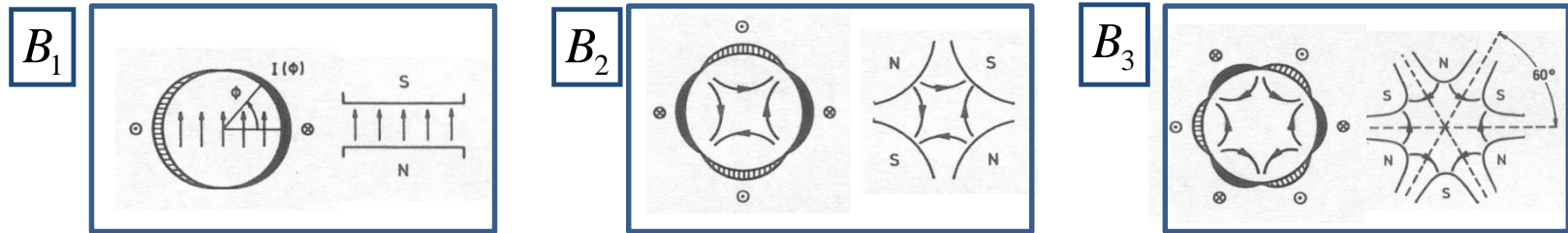

by K.-H. Mess, *et al.*

- The field harmonics are rewritten as (EU notation)

$$B_y + iB_x = 10^{-4} B_1 \sum_{n=1}^{\infty} (b_n + ia_n) \left(\frac{x + iy}{R_{ref}} \right)^{n-1}$$

- We factorize the **main component** (B_1 for dipoles, B_2 for quadrupoles)
- We introduce a **reference radius** R_{ref} to have dimensionless coefficients
- We **factorize** 10^{-4} since the deviations from ideal field are $\sim 0.01\%$
- The coefficients b_n, a_n are called **normalized multipoles**
 - b_n are the **normal**, a_n are the **skew** (adimensional)

Field representation Harmonics

$$B_y + iB_x = 10^{-4} B_1 \sum_{n=1}^{\infty} (b_n + ia_n) \left(\frac{x + iy}{R_{ref}} \right)^{n-1}$$

- The coefficients b_n , a_n are called normalized multipoles
 - b_n are the normal, a_n are the skew (adimensional)
- Reference radius is usually chosen as 2/3 of the aperture radius

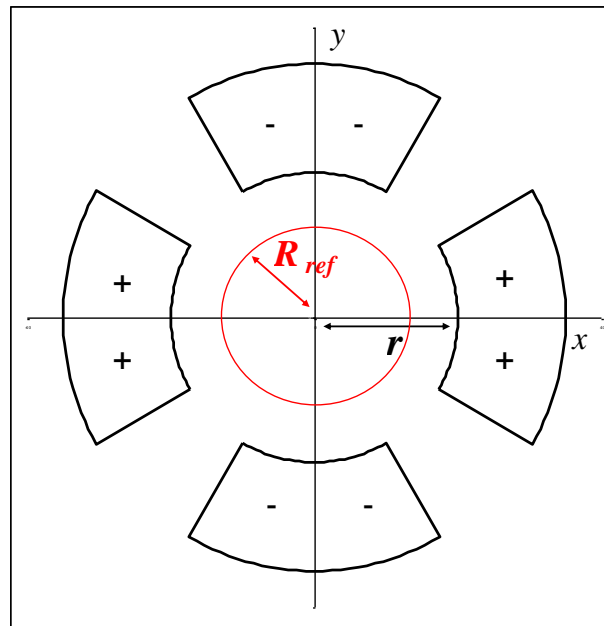

Field representation Harmonics

- One can demonstrate that with line currents with a **dipole** or a **quadrupole symmetry**, most of the **multipoles cancelled**
- For $n=1 \rightarrow$ *dipole*
 - Only b_3, b_5, b_7, \dots are present
- For $n=2 \rightarrow$ *quadrupole*
 - Only $b_6, b_{10}, b_{14}, \dots$ are present
- ...and so on
- These multipoles are called ***allowed multipoles***
- The field quality optimization of a coil lay-out concerns only a **few** quantities
 - For a dipole, usually b_3, b_5, b_7 , and possibly b_9, b_{11}

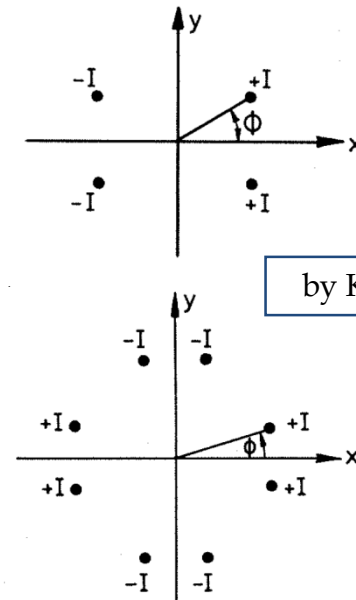

by K.-H. Mess, *et al.*

Back to the original issue: From ideal to practical configuration

- How can I reproduce **thick shell with a $\cos\theta$** distribution with a cable?

- Rectangular cross-section and constant J

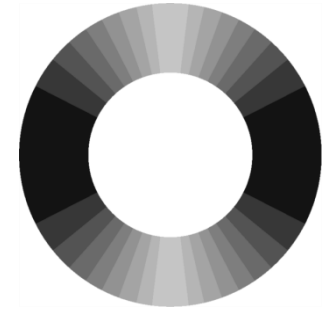

- First “rough” approximation

- **Sector dipole**



- Better ones

- More **layers** and **wedges** to reduce J towards 90°

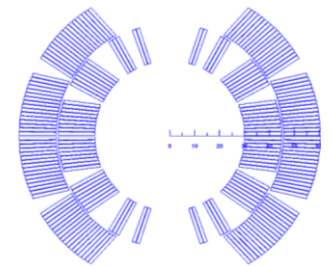

- Now, I can use the multipolar expansion to **optimize** my “practical” **cross-section**

- **How much** conductor do we need to meet the requirements?
- And in **which configuration**?
- **Outline**
 - How do we create a **perfect field**?
 - How do we express the field and its “**imperfections**”?
 - How do we **design a coil** to minimize field errors?
 - Which is the **maximum field** we can get?
 - **Overview** of different designs

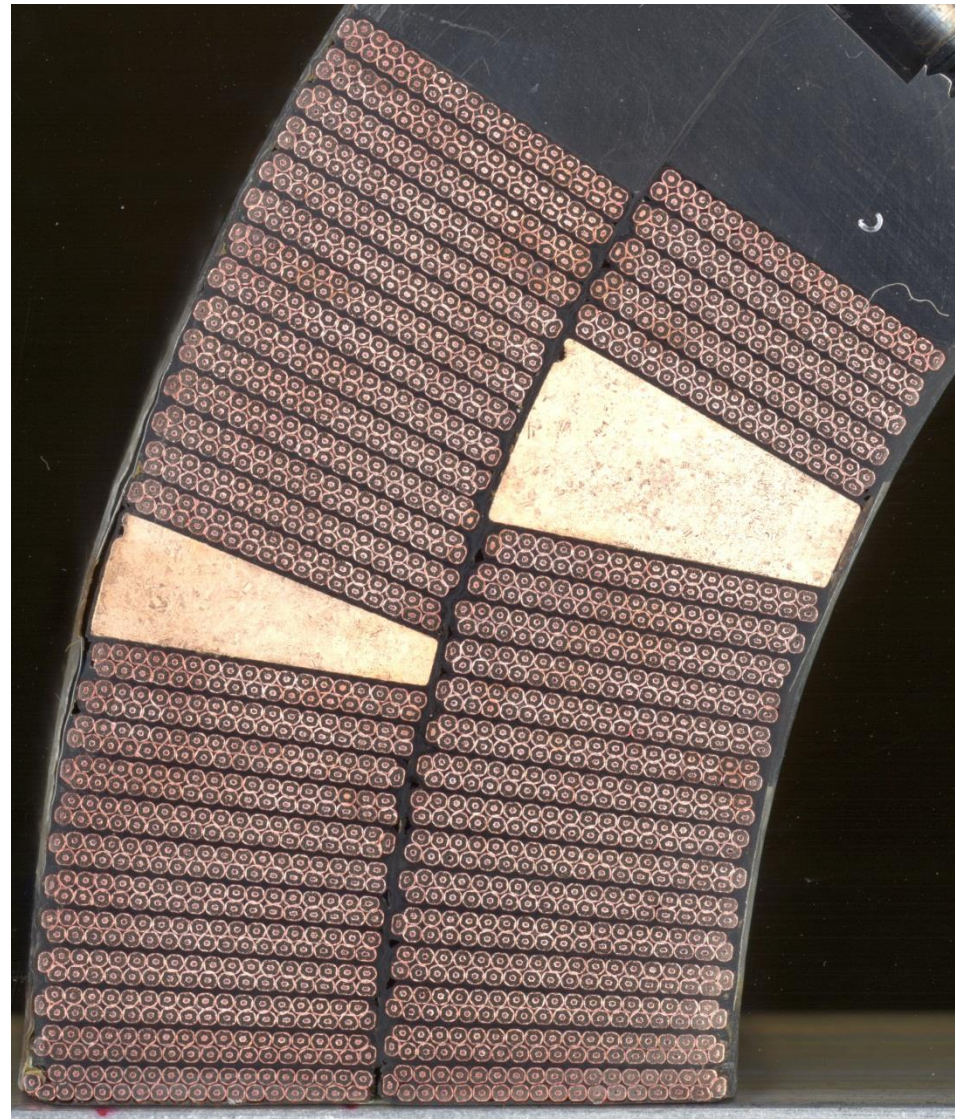

A “good” field quality dipole

Sector dipole

- We compute the central field given by a **sector dipole** with uniform current density j
- We start from **Biot-Savart law** and integrate

$$I \rightarrow j\rho d\rho d\theta$$

- And we obtain

$$B_1 = -2 \frac{j\mu_0}{2\pi} \int_{-\alpha}^{\alpha} \int_r^{r+w} \frac{\cos\theta}{\rho} \rho d\rho d\theta = -\frac{2j\mu_0}{\pi} w \sin\alpha$$

$$B_n = -\frac{j\mu_0 R_{ref}^{n-1}}{\pi} \frac{2 \sin(\alpha n)}{n} \frac{(r+w)^{2-n} - r^{2-n}}{2-n}$$

- **Multipoles n** are proportional to $\sin(n \text{ angle of the sector})$
 - They can be made **equal to zero** !

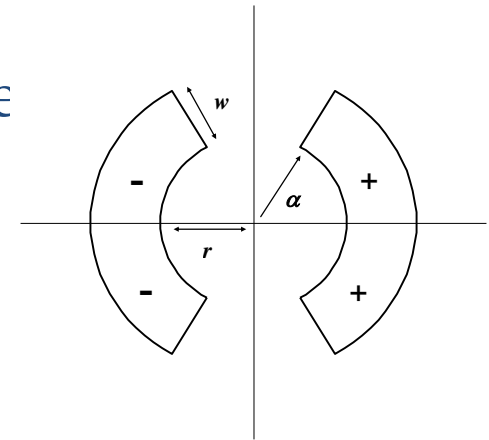

A “good” field quality dipole

Sector dipole

- First allowed multipole **B_3 (sextupole)**

$$B_3 = \frac{\mu_0 j R_{ref}^2}{\pi} \frac{\sin(3\alpha)}{3} \left(\frac{1}{r} - \frac{1}{r+w} \right)$$

for $\alpha = \pi/3$ (i.e. a 60° sector coil) one has $B_3 = 0$

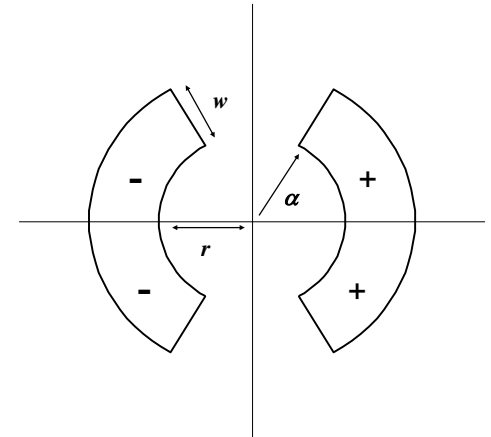

- Second allowed multipole **B_5 (decapole)**

$$B_5 = \frac{\mu_0 j R_{ref}^4}{\pi} \frac{\sin(5\alpha)}{5} \left(\frac{1}{r^3} - \frac{1}{(r+w)^3} \right)$$

for $\alpha = \pi/5$ (i.e. a 36° sector coil) or for $\alpha = 2\pi/5$ (i.e. a 72° sector coil) one has $B_5 = 0$

- With one sector one cannot set to zero both multipoles ... let us try with more sectors !

A “good” field quality dipole

Sector dipole

- Coil with **two sectors**

$$B_3 = \frac{\mu_0 j R_{ref}^2}{\pi} \frac{\sin 3\alpha_3 - \sin 3\alpha_2 + \sin 3\alpha_1}{3} \left(\frac{1}{r} - \frac{1}{r+w} \right)$$

$$B_5 = \frac{\mu_0 j R_{ref}^4}{\pi} \frac{\sin 5\alpha_3 - \sin 5\alpha_2 + \sin 5\alpha_1}{5} \left(\frac{1}{r^3} - \frac{1}{(r+w)^3} \right)$$

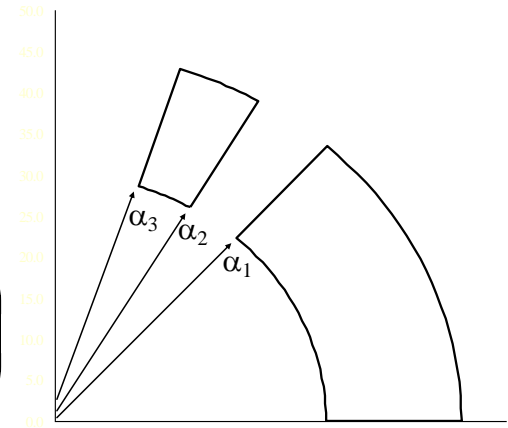

- Note: we have to work with **non-normalized multipoles**, which can be added together
- Equations to set to zero B_3 , B_5 and B_5

$$\begin{cases} \sin(3\alpha_3) - \sin(3\alpha_2) + \sin(3\alpha_1) = 0 \\ \sin(5\alpha_3) - \sin(5\alpha_2) + \sin(5\alpha_1) = 0 \end{cases}$$

- There is a **one-parameter family of solutions**, for instance $(48^\circ, 60^\circ, 72^\circ)$ or $(36^\circ, 44^\circ, 64^\circ)$ are solutions

A “good” field quality dipole Sector dipole

- With one wedge one can set to zero three multipoles (B_3 , B_5 and B_7)

- What about **two wedges** ?

$$\sin(3\alpha_5) - \sin(3\alpha_4) + \sin(3\alpha_3) - \sin(3\alpha_2) + \sin(3\alpha_1) = 0$$

$$\sin(5\alpha_5) - \sin(5\alpha_4) + \sin(5\alpha_3) - \sin(5\alpha_2) + \sin(5\alpha_1) = 0$$

$$\sin(7\alpha_5) - \sin(7\alpha_4) + \sin(7\alpha_3) - \sin(7\alpha_2) + \sin(7\alpha_1) = 0$$

$$\sin(9\alpha_5) - \sin(9\alpha_4) + \sin(9\alpha_3) - \sin(9\alpha_2) + \sin(9\alpha_1) = 0$$

$$\sin(11\alpha_5) - \sin(11\alpha_4) + \sin(11\alpha_3) - \sin(11\alpha_2) + \sin(11\alpha_1) = 0$$

One can **set to zero five multipoles** (B_3 , B_5 , B_7 , B_9 and B_{11})
 $\sim [0^\circ-33.3^\circ, 37.1^\circ-53.1^\circ, 63.4^\circ-71.8^\circ]$

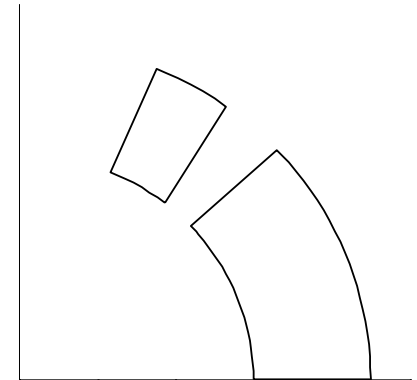

One wedge, $b_3=b_5=b_7=0$
 $[0^\circ-43.2^\circ, 52.2^\circ-67.3^\circ]$

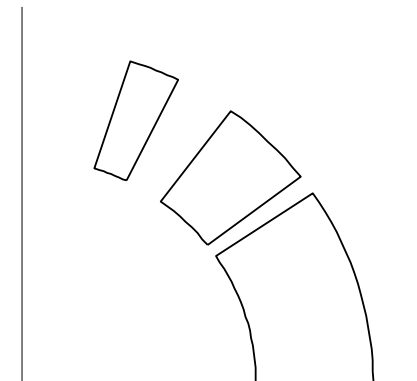

Two wedges, $b_3=b_5=b_7=b_9=b_{11}=0$
 $[0^\circ-33.3^\circ, 37.1^\circ-53.1^\circ, 63.4^\circ-71.8^\circ]$

A “good” field quality dipole Sector dipole

- Let us see two coil lay-outs of real magnets
 - The **RHIC dipole** has **four blocks**

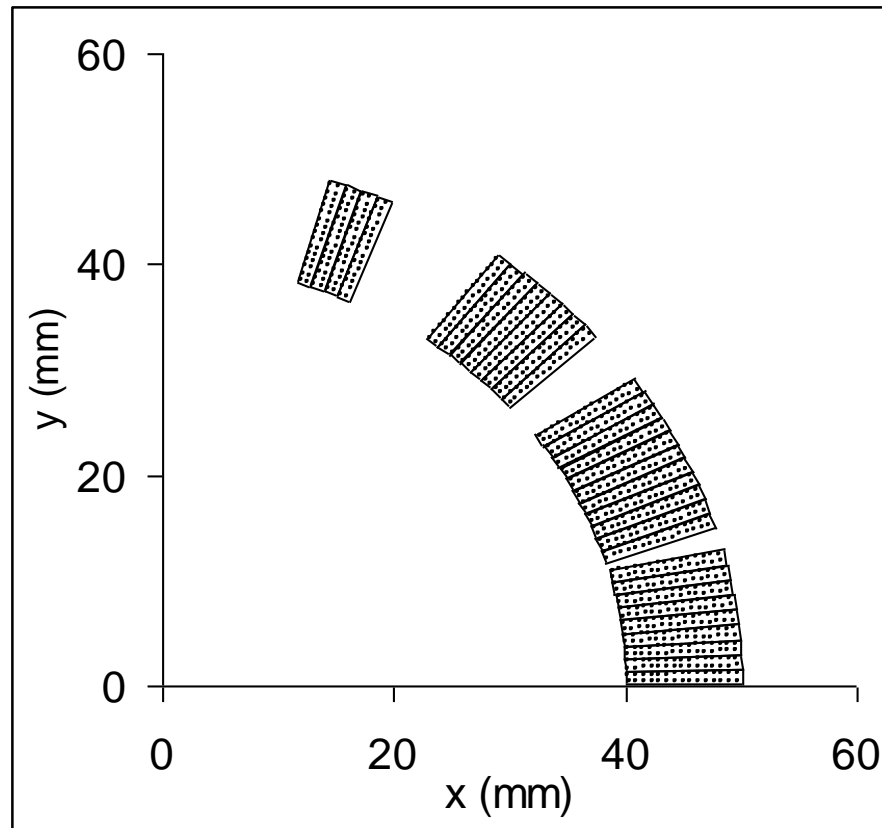

A “good” field quality dipole Sector dipole

- Limits due to the cable geometry
 - Finite thickness → **one cannot produce sectors of any width**
 - Cables cannot be key-stoned beyond a certain angle, **some wedges can be used to better follow the arch**
- One does not always aim at having zero multipoles
 - There are other contributions (iron, persistent currents ...)

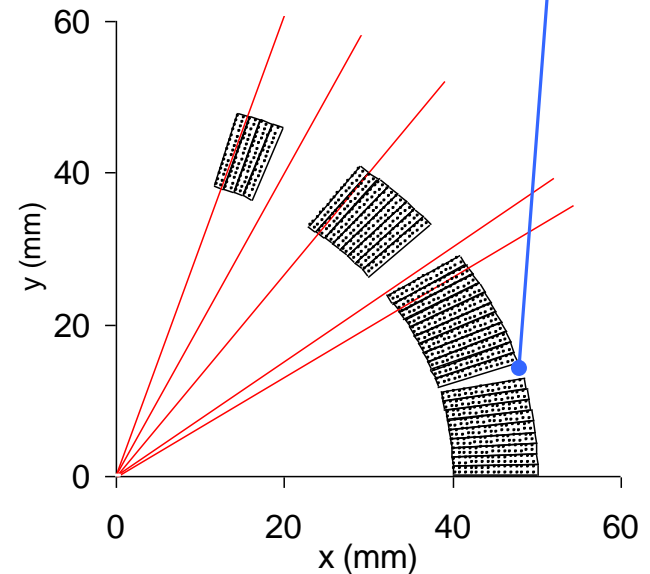
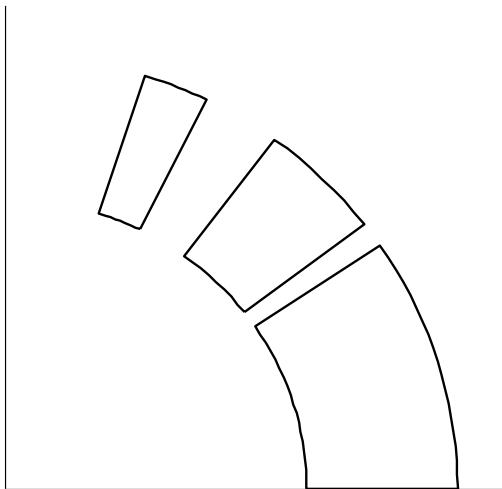

A “good” field quality dipole Sector quadrupole

- For a sector coil **with one layer**, the same results of the dipole case hold with the following transformation
 - **Angles** have to be **divided by two**
 - **Multipole orders** have to be **multiplied by two**
- First allowed multipole B_6 (dodecapole)

$$B_6 = \frac{\mu_0 j R_{ref}^5}{\pi} \frac{\sin(6\alpha)}{6} \left(\frac{1}{r^4} - \frac{1}{(r+w)^4} \right)$$

for $\alpha = \pi/6$ (i.e. a **30° sector coil**) one has $B_6 = 0$

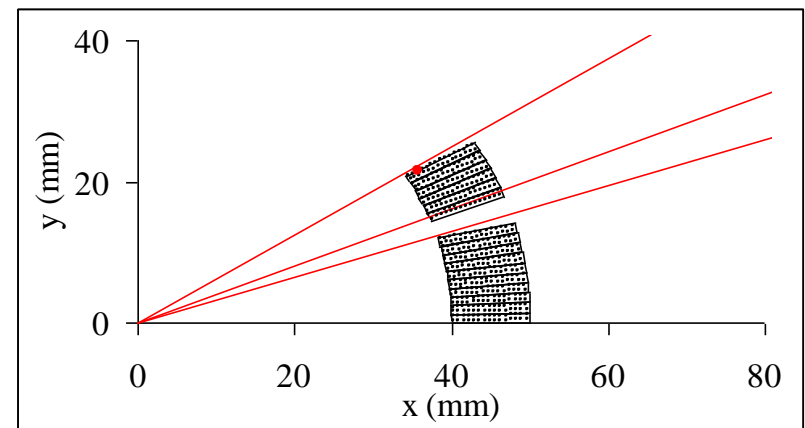
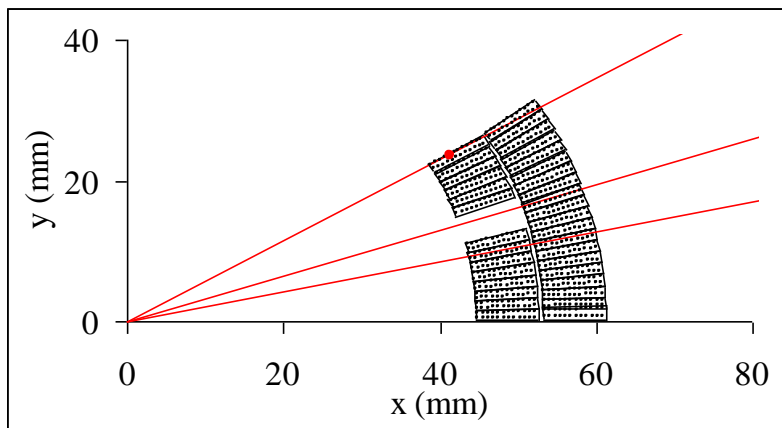

Magnetic design

- **How much** conductor do we need to meet the requirements?
- And in **which configuration**?
- **Outline**
 - How do we create a **perfect field**?
 - How do we express the field and its “**imperfections**”?
 - How do we **design a coil** to minimize field errors?
 - Which is the **maximum field** we can get?
 - **Overview** of different designs

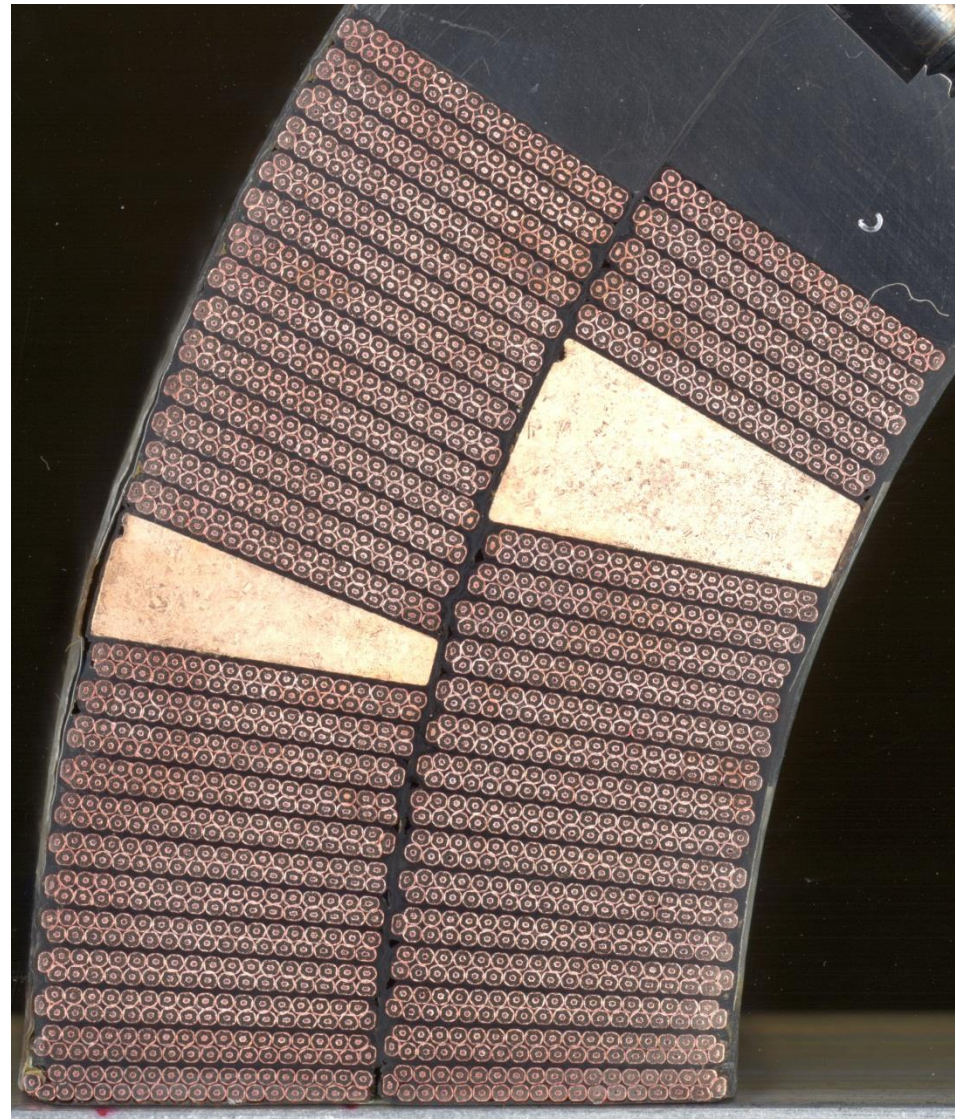

Maximum field and coil thickness

Dipoles

- We recall the equations for the **critical surface**

- Nb-Ti (linear approximation)

$$j_{sc,c}(B) = s(B_{c2}^* - B),$$

- with $s \sim 6.0 \times 10^8$ [A/(T m²)] and $B_{c2}^* \sim 10$ T at 4.2 K or 13 T at 1.9 K

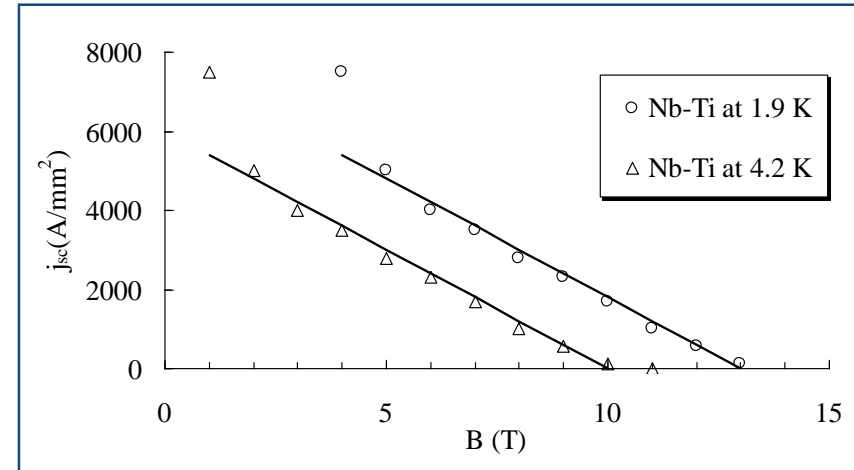

- The current density flowing in the insulated cable is reduced by a factor κ (**filling ratio**)

- It ranges from $1/4$ to $1/3$

$$j_c(B) \equiv \kappa j_{sc,c}(B) \qquad j_c(B) = \kappa s (B_{c2}^* - B)$$



Maximum field and coil thickness

Dipoles

- We characterize the coil by two parameters

$$B \equiv \gamma_c j \qquad B_p \equiv \lambda B = \lambda \gamma_c j$$

- γ_c : how much **field in the centre** is given **per unit of current density**
 - For a sector dipole

$$B_1 = -\frac{2\mu_0 j}{\pi} w \sin \alpha$$

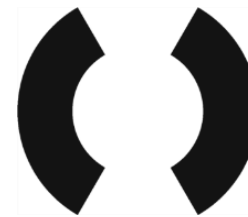

- λ : ratio between **peak field and central field**
 - For a sector and in general is $\lambda = 1.05 - 1.15$
 - hyperbolic fit: $a \sim 0.045$

$$\lambda(w, r) \sim 1 + \frac{ar}{w}$$

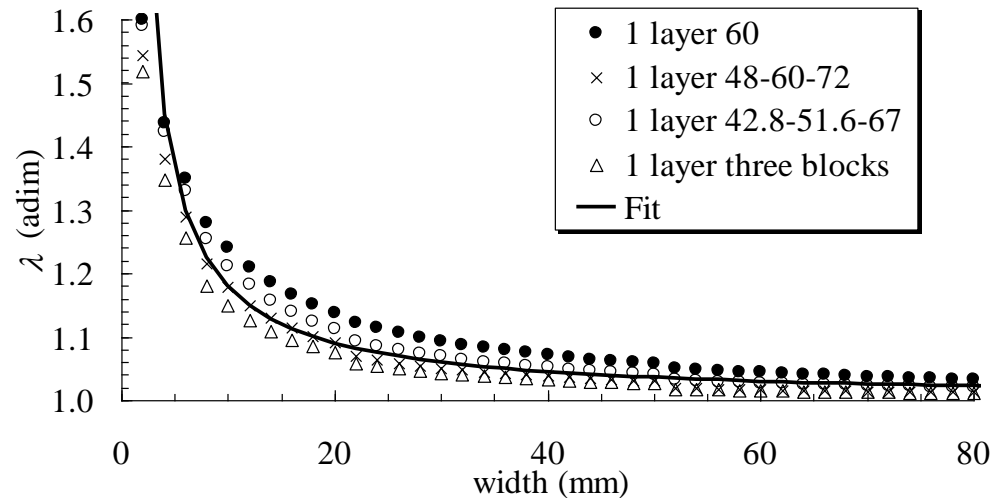

Maximum field and coil thickness

Dipoles

- We can now compute what is the **highest peak field** that can be reached in the dipole

$$B_{p,ss} = \frac{\lambda \gamma_c \kappa S}{1 + \lambda \gamma_c \kappa S} B_{c2}^*$$

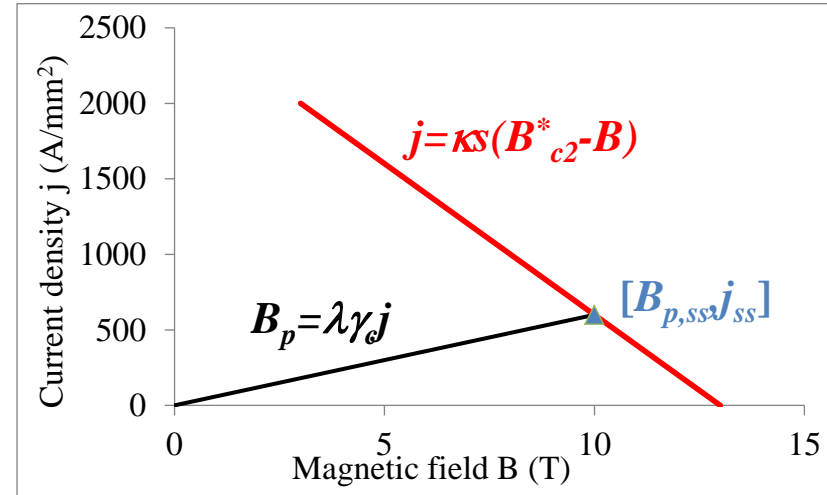

- The **maximum current density** in the superconductor
 - short sample limit*

$$j_{ss} = \frac{\kappa S}{1 + \lambda \gamma_c \kappa S} B_{c2}^*$$

- And the **bore short sample field** (in the centre not on the conductor)

$$B_{ss} = \frac{\gamma_c \kappa S}{1 + \lambda \gamma_c \kappa S} B_{c2}^*$$

Maximum field and coil thickness

Dipoles

● Maximum bore field

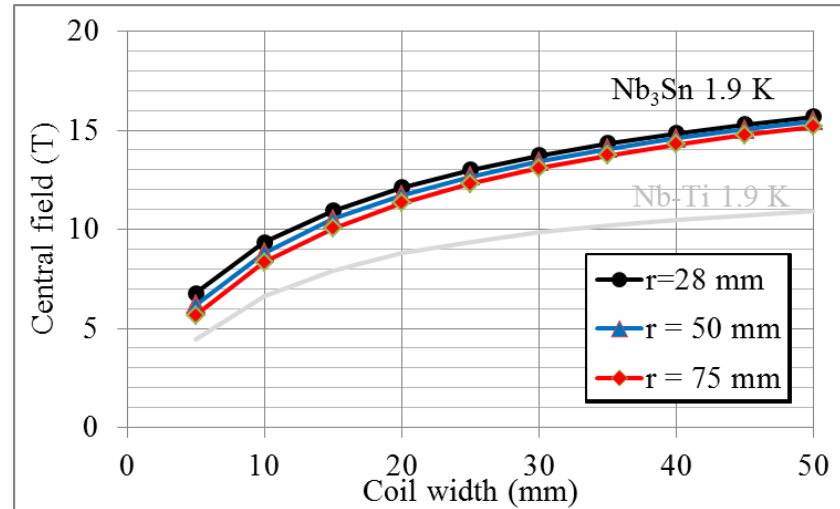
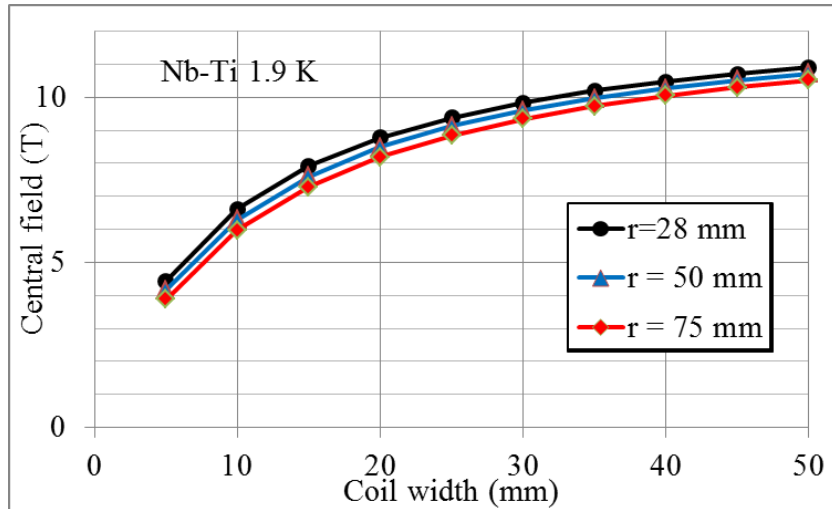

- Magnets have to work at a given distance from the critical surface, i.e. they are **never operated at short sample conditions**
 - At short sample, any small perturbation quenches the magnet
 - One usually operates at a **fraction of the loadline: 60% to 90%**

Maximum gradient and coil thickness Quadrupoles

- We characterize the coil by two parameters

$$\gamma_c \equiv \frac{G}{j} \quad \lambda \equiv \frac{B_p}{rG}$$

- γ_c : how much **gradient** is given **per unit of current density**

- For a sector quadrupole

$$G = -\frac{2j_o\mu_0}{\pi} [\sin 60] \ln\left(1 + \frac{w}{r}\right)$$



- λ : ratio between **peak field and gradient** $\cdot r$

- A good fit, with $a_{-1} \sim 0.04$ and $a_1 \sim 0.11$ is

$$\lambda(w, r) = a_{-1} \frac{r}{w} + 1 + a_1 \frac{w}{r}$$

- reasonable values is**
 $\lambda \sim \lambda_0 = 1.15$

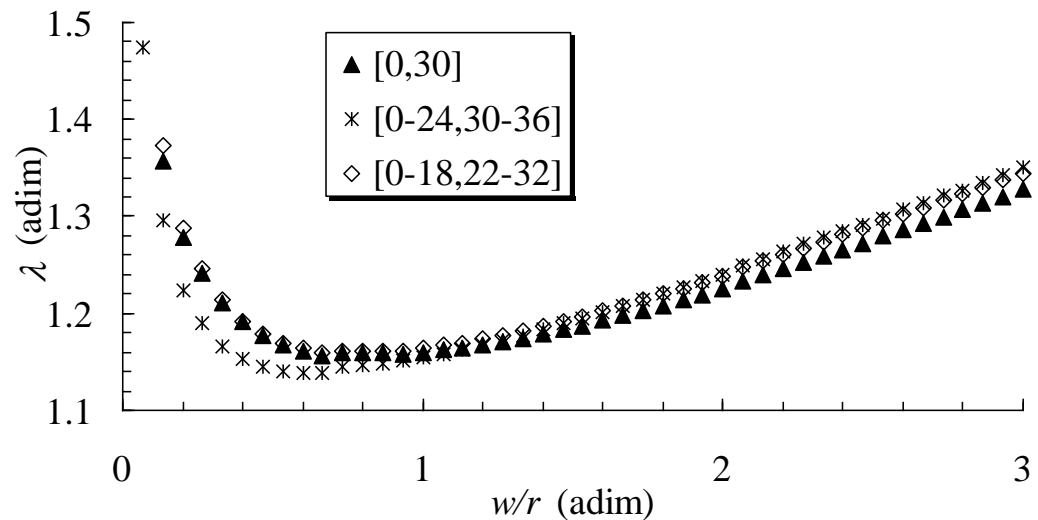

Maximum gradient and coil thickness Quadrupoles

- Therefore, the **maximum field, current and gradient**

$$B_{p,ss} = \frac{\lambda r \gamma_c \kappa S}{1 + \lambda r \gamma_c \kappa S} B_{c2}^* \quad j_{ss} = \frac{\kappa S}{1 + \lambda r \gamma_c \kappa S} B_{c2}^* \quad G_{ss} = \frac{\gamma_c \kappa S}{1 + \lambda r \gamma_c \kappa S} B_{c2}^*$$

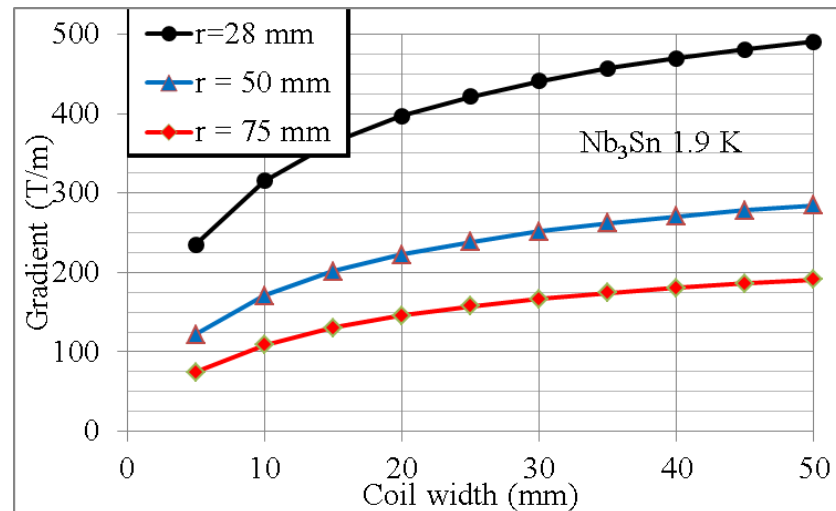
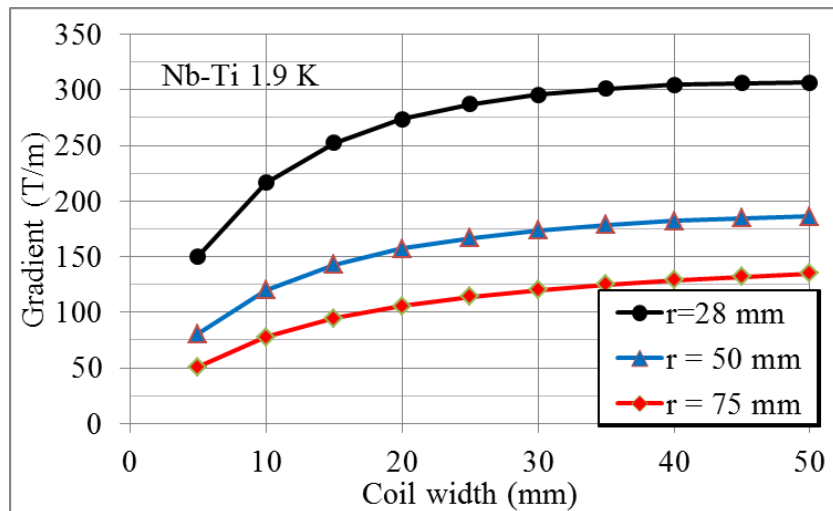

- Unlike dipoles, no point in making coils extremely large!

Iron yoke

- Keep the **return magnetic flux** close to the coils, thus avoiding fringe fields
- In some cases the iron is partially or totally contributing to the **mechanical structure**
- Considerably **enhance the field** for a given current density
 - The increase is relevant (10-30%), getting higher for thin coils
 - This allows using lower currents, easing the protection

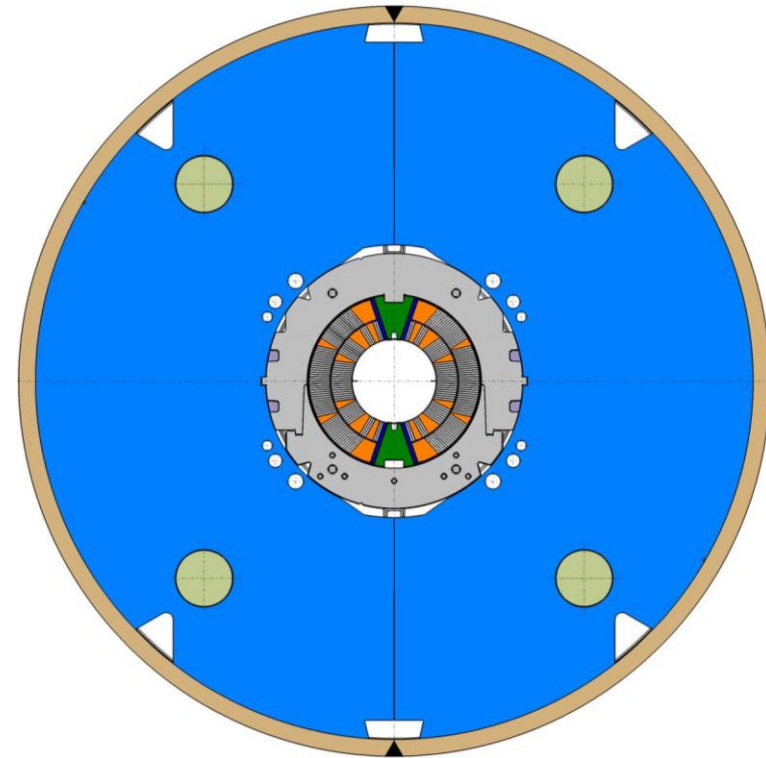

Iron yoke

- A **rough estimate** of the **iron thickness** necessary to avoid fields outside the magnet
 - The iron cannot withstand more than 2 T
 - **Shielding condition** for dipoles: $rB \sim t_{iron} B_{sat}$
 - i.e., the iron thickness times 2 T is equal to the central field times the magnet aperture – One assumes that all the field lines in the aperture go through the iron (and not for instance through the collars)
 - Example: in the LHC main dipole **the iron thickness is 150 mm**

$$t_{iron} \sim \frac{rB}{B_{sat}} = \frac{28 * 9}{2} \sim 130 \text{ mm}$$

- Shielding condition for quadrupoles: $\frac{r^2 G}{2} \sim t_{iron} B_{sat}$

Iron yoke

- The iron yoke contribution can be estimated analytically for **simple geometries**
 - Circular, non-saturated iron: **image currents** method
 - Iron effect is equivalent to add to each current line a second one

- at a distance $\rho' = \frac{R_I^2}{\rho}$
- with current $I' = \frac{\mu - 1}{\mu + 1} I$

- Limit of the approximation: iron is not saturated (less than 2 T)

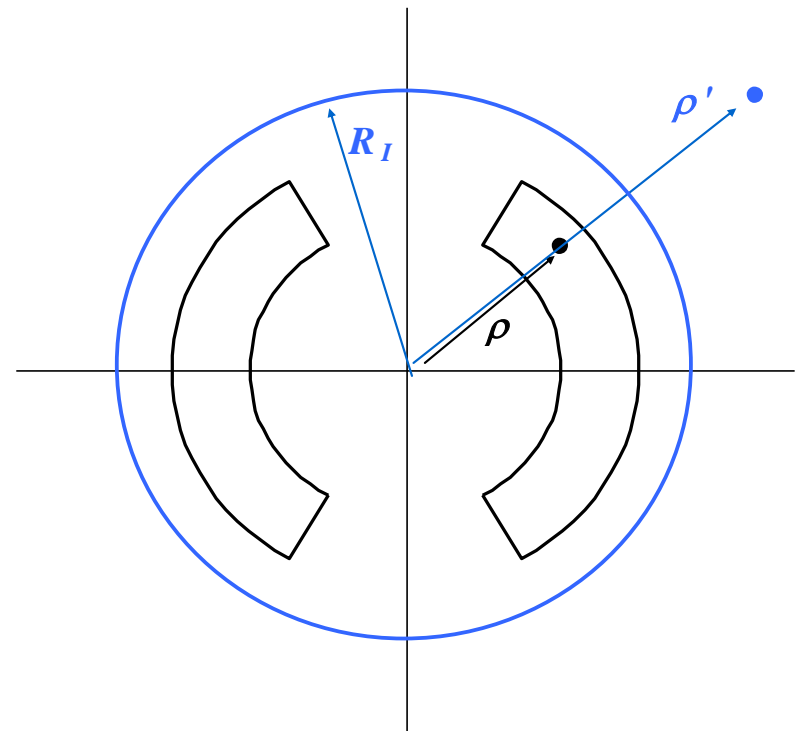

Iron yoke

- Impact of the iron yoke on short sample field
 - Large effect (25%) on RHIC dipoles (thin coil and collars)
 - Between **4% and 10%** for most of the others (both Nb-Ti and Nb₃Sn)

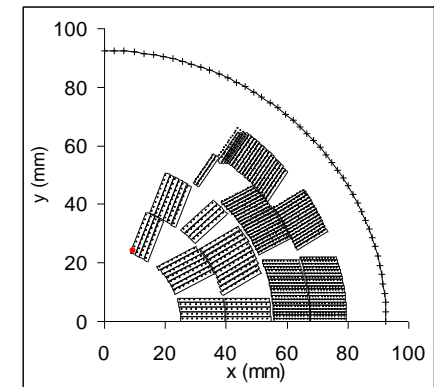
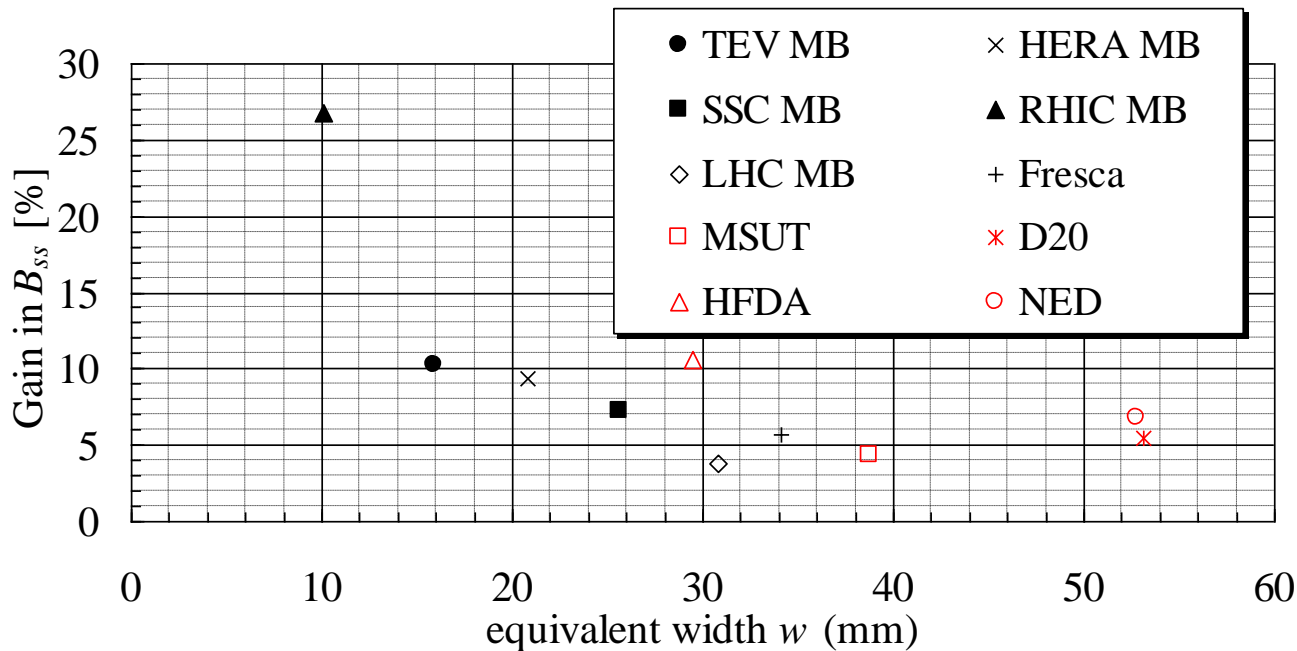

D20 and yoke

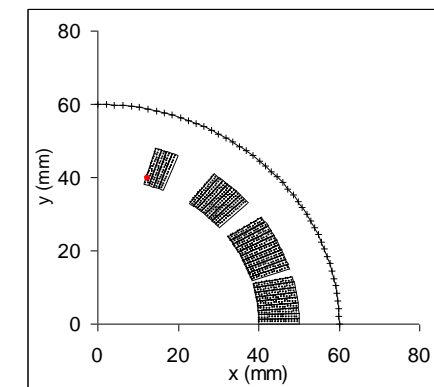

RHIC main dipole and yoke

- **Similar approach** can be used in **quadrupoles**
 - **Large effect on RHIC** quadrupoles (thin coil and collars)
 - Between **2% and 5%** for most of the others
 - The effect is smaller than in dipoles since the contribution to B_2 is smaller than to B_1

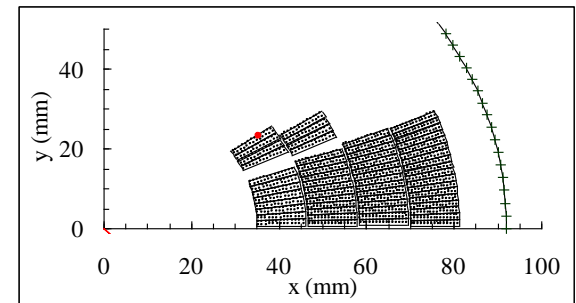
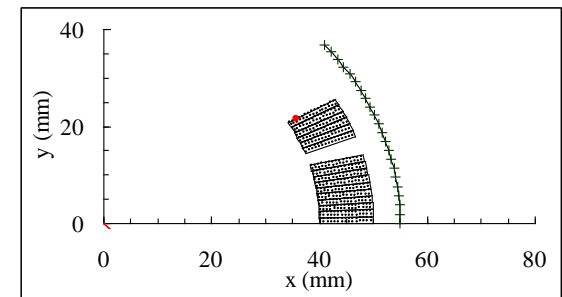
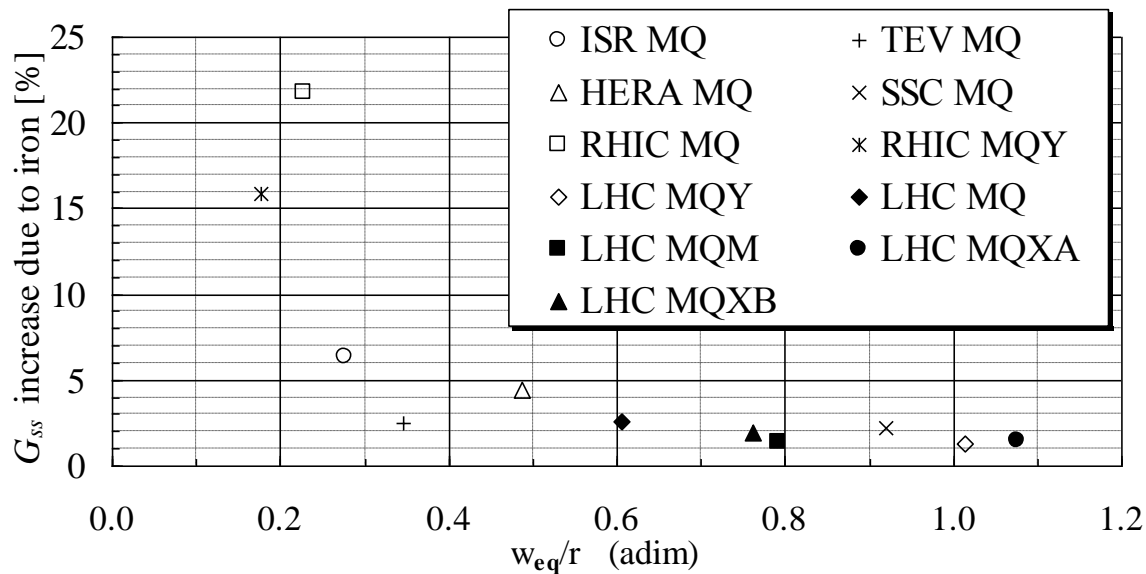

- **How much** conductor do we need to meet the requirements?
 - And in **which configuration**?
 - **Outline**
 - How do we create a **perfect field**?
 - How do we express the field and its “**imperfections**”?
 - How do we **design a coil** to minimize field errors?
 - Which is the **maximum field** we can get?
- **Overview** of different designs

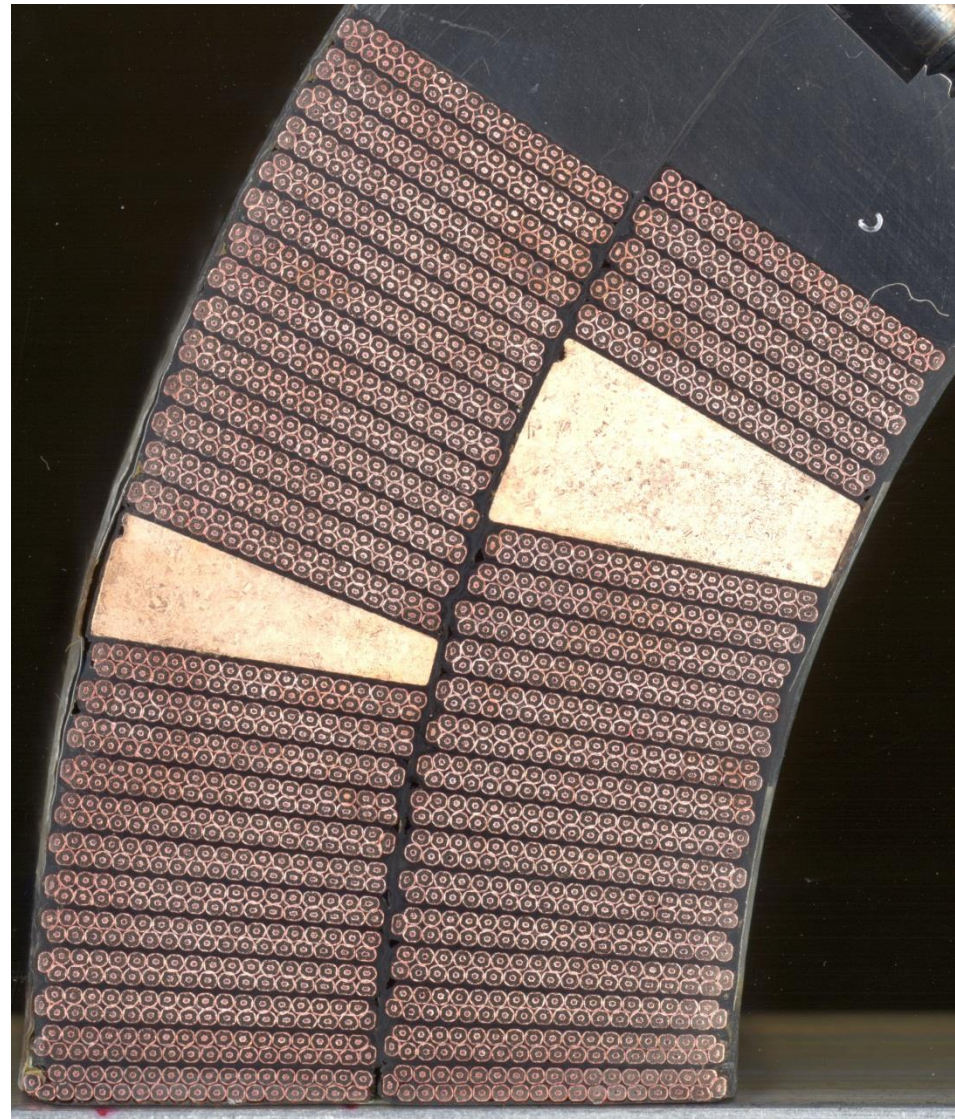

A review of dipole lay-outs

- Tevatron MB

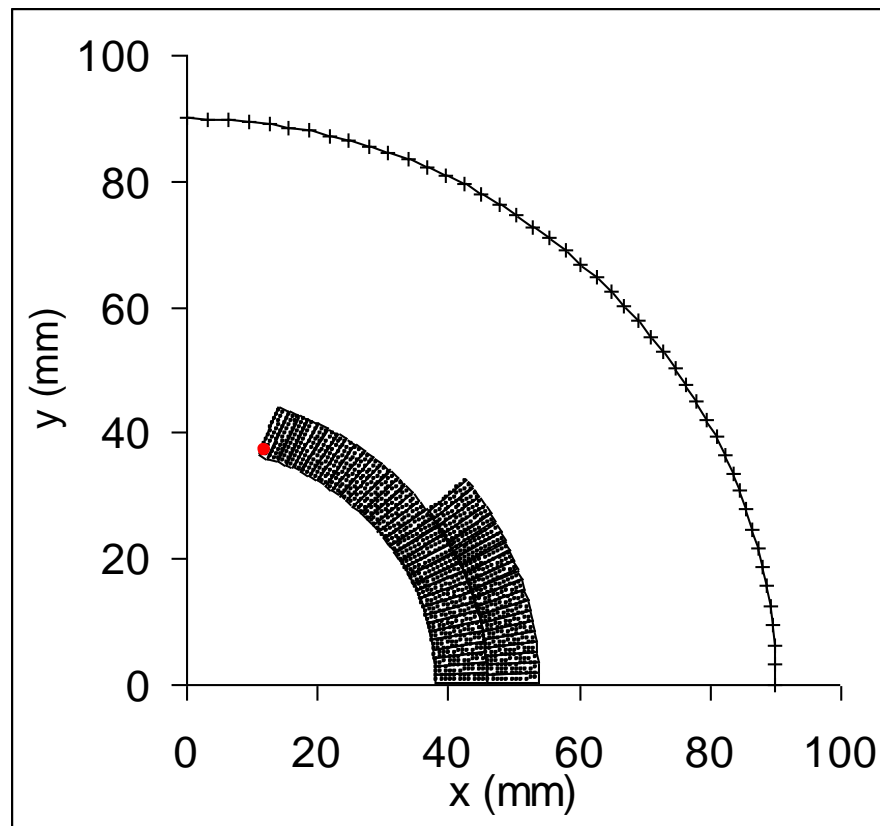

A review of dipole lay-outs

- RHIC MB

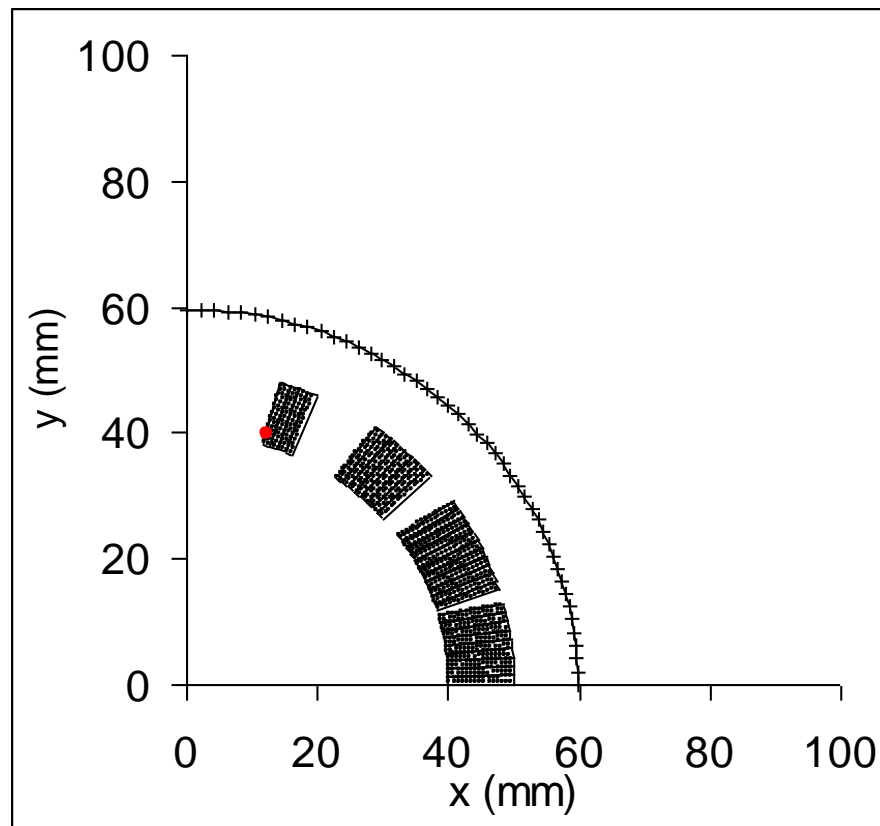

A review of dipole lay-outs

- HERA MB

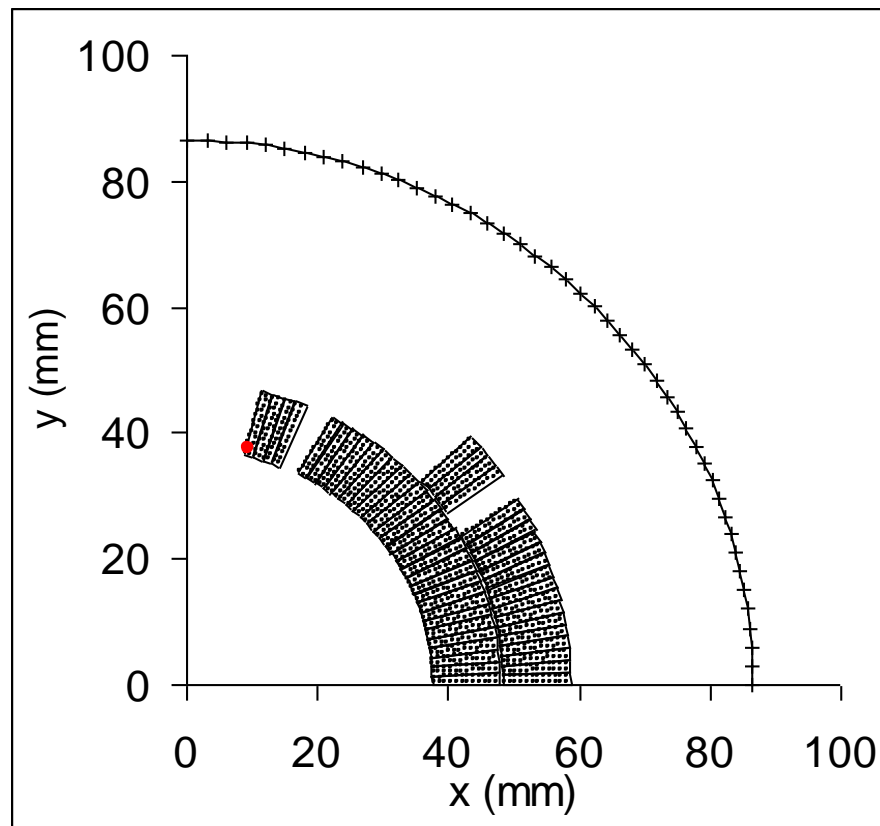

A review of dipole lay-outs

- SSC MB

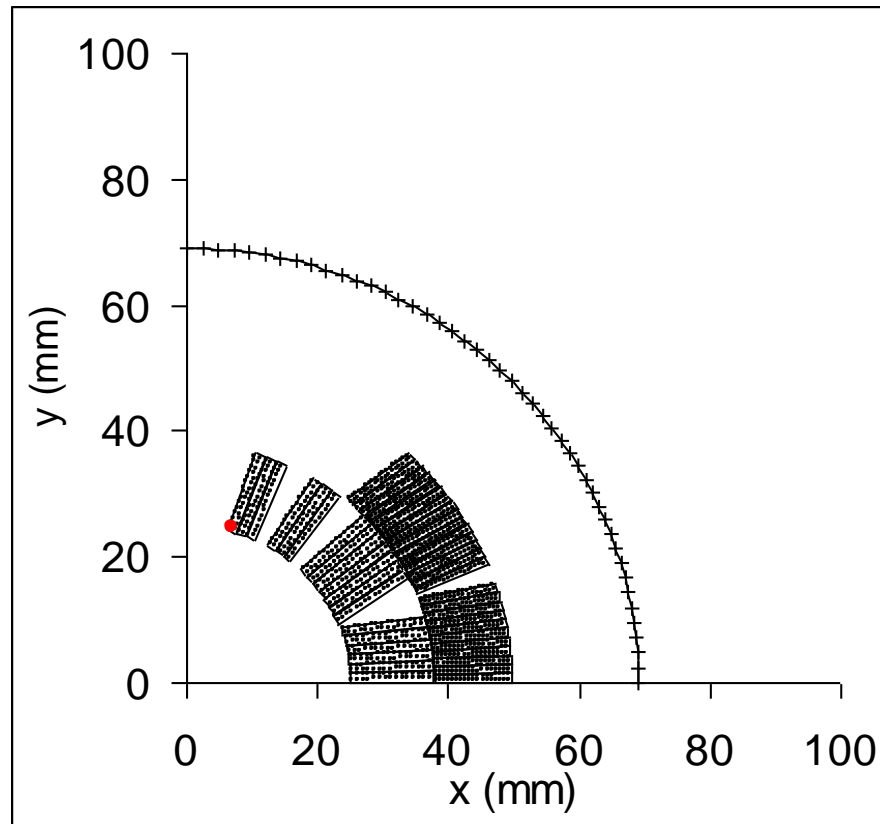

A review of dipole lay-outs

- HFDA dipole

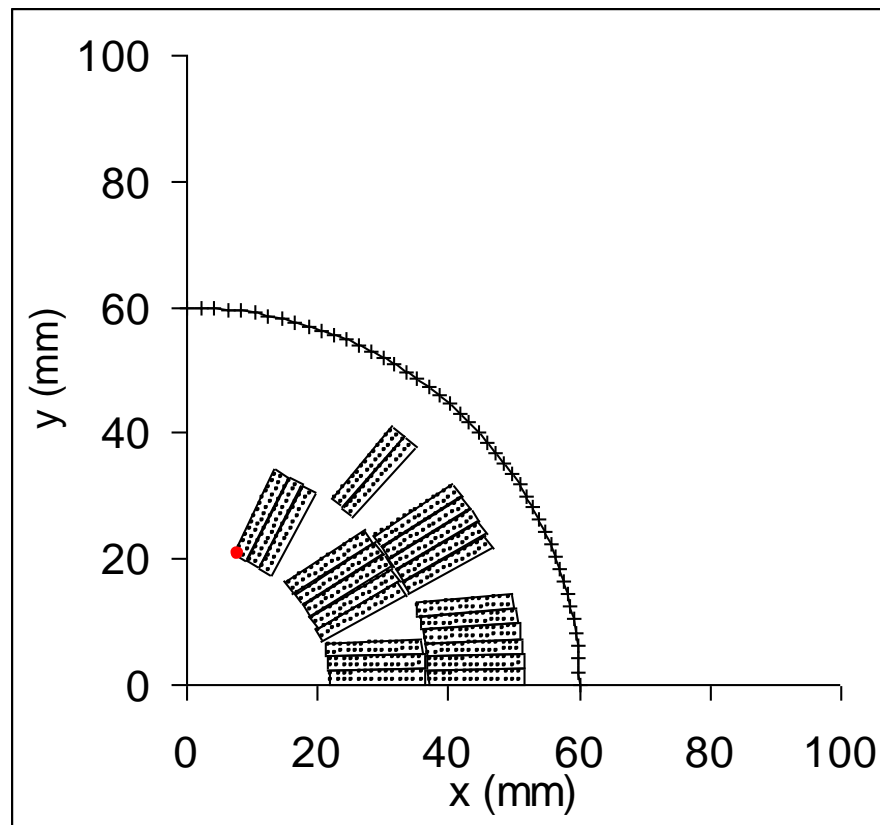

A review of dipole lay-outs

- LHC MB

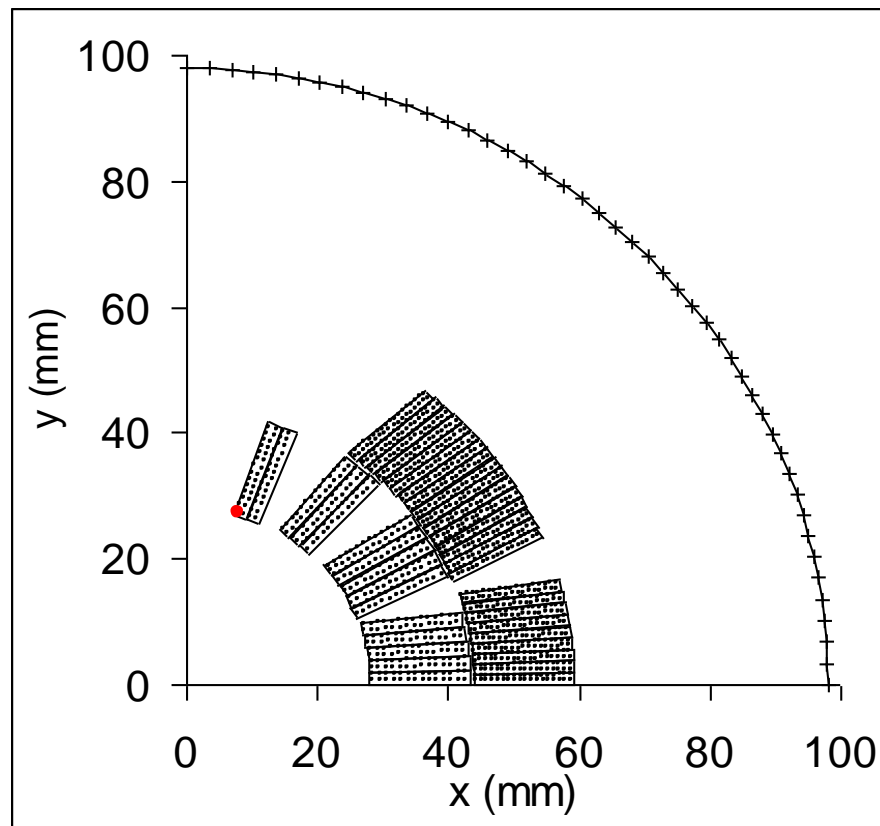

A review of dipole lay-outs

- **FRESCA**

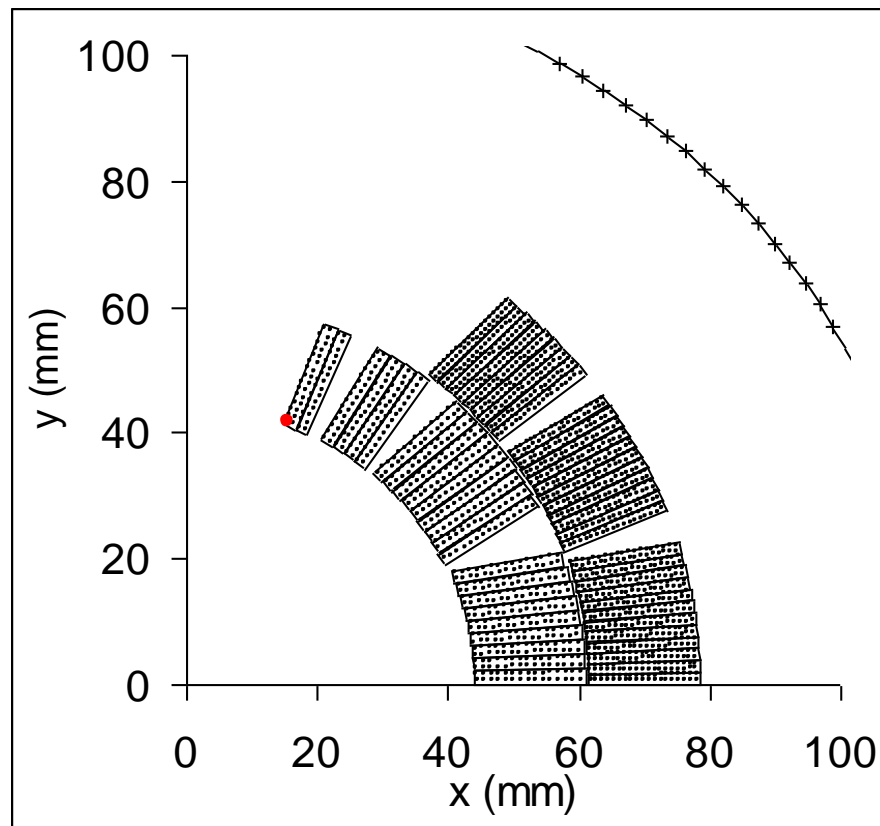

A review of dipole lay-outs

- MSUT

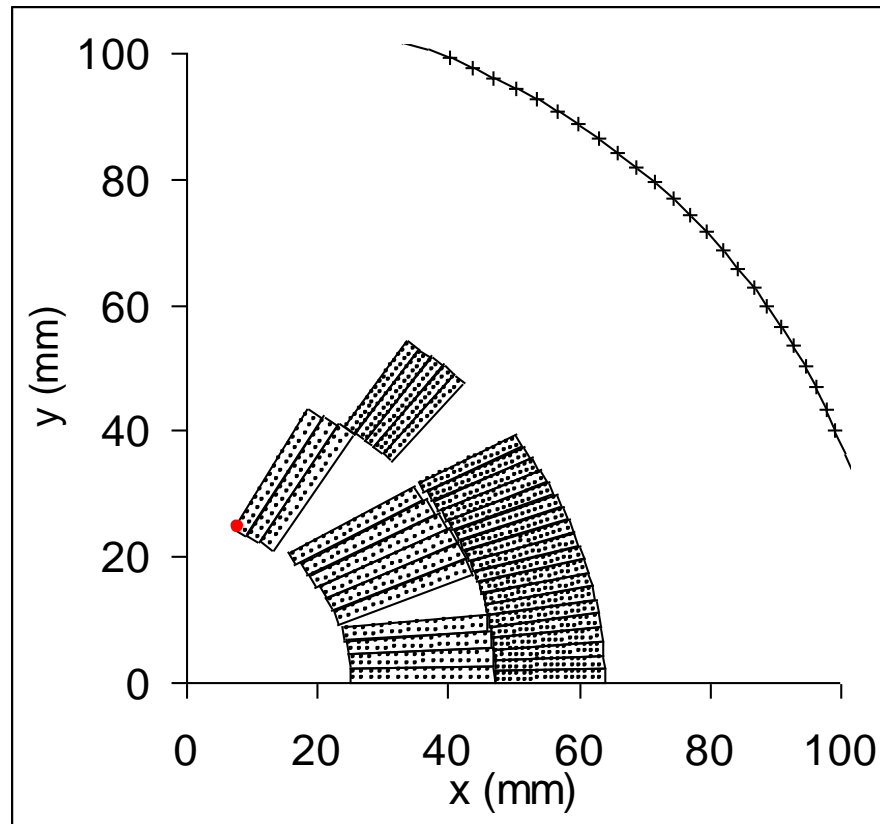

A review of dipole lay-outs

- D20

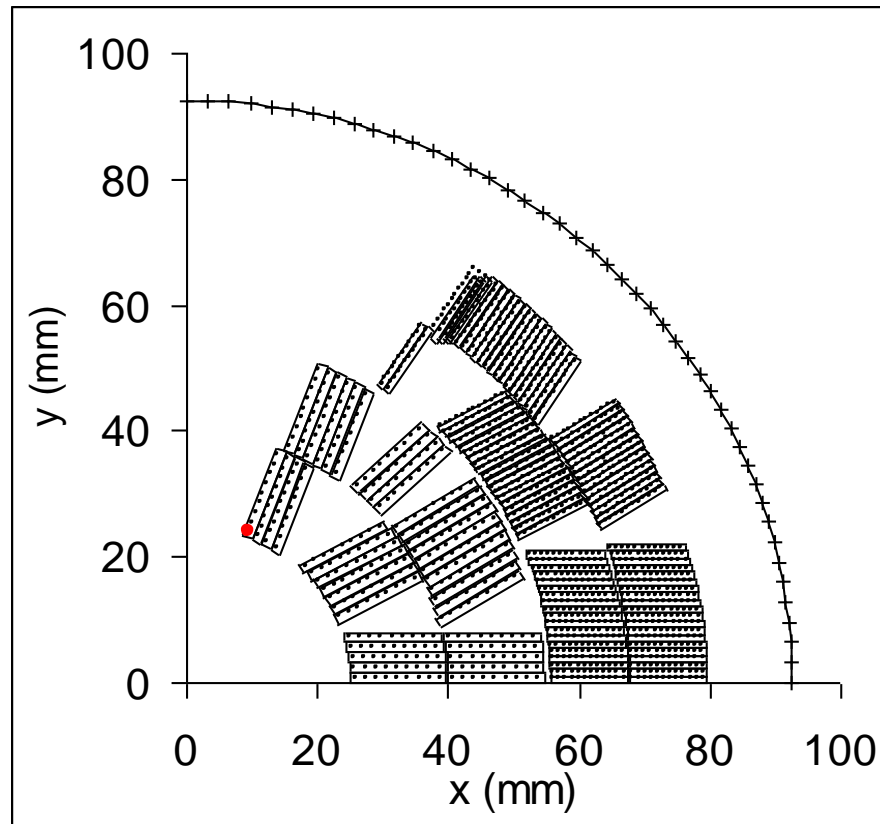

A review of dipole lay-outs

- HD2

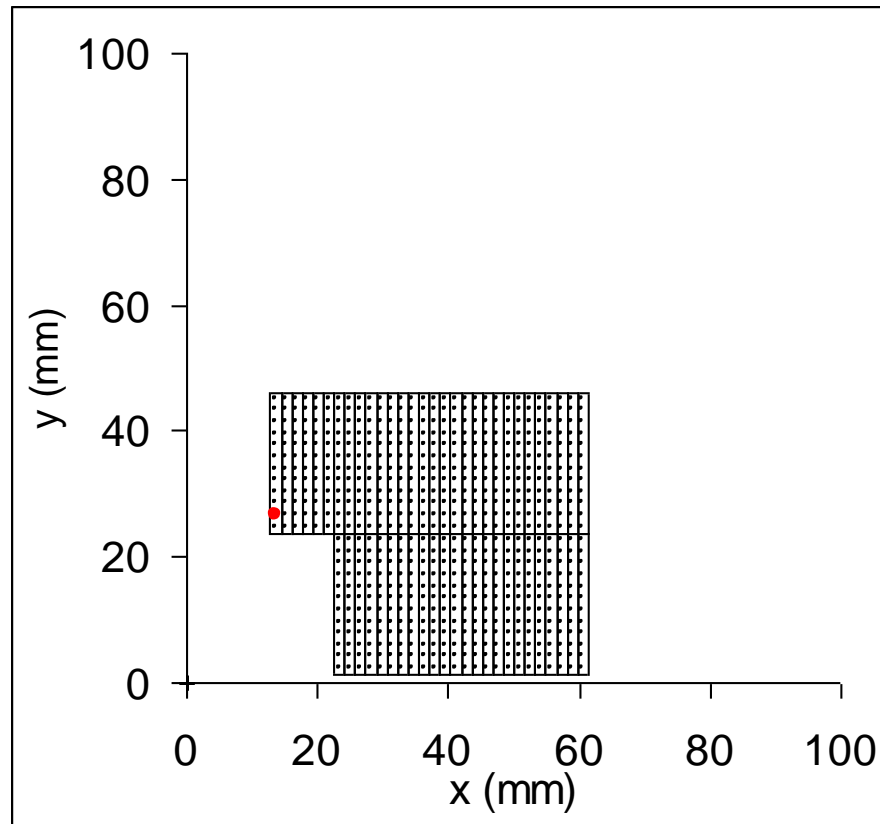

RHIC MQX

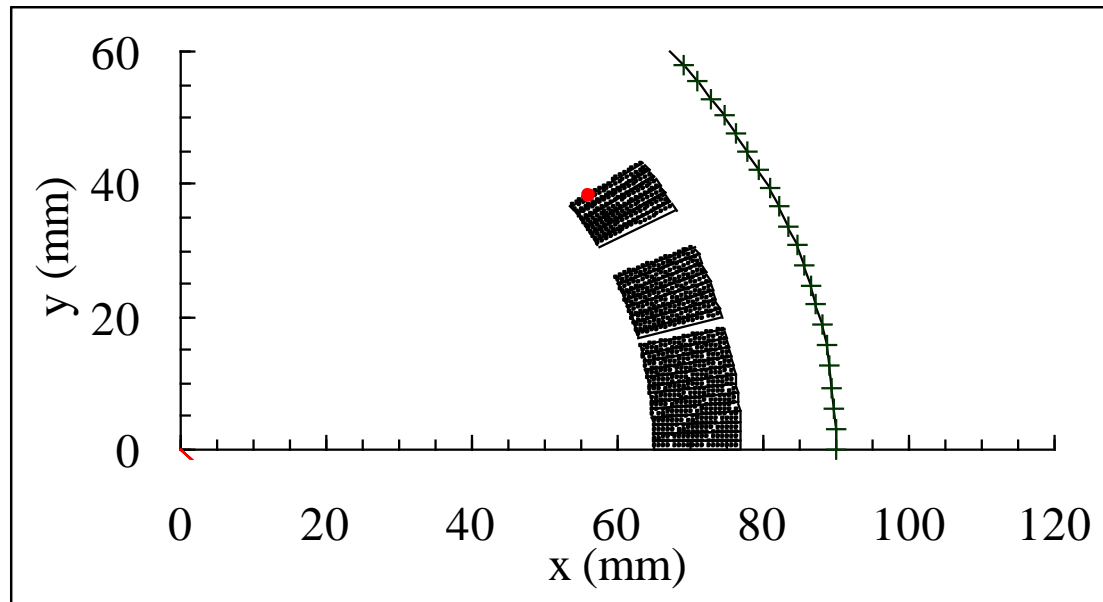

RHIC MQ

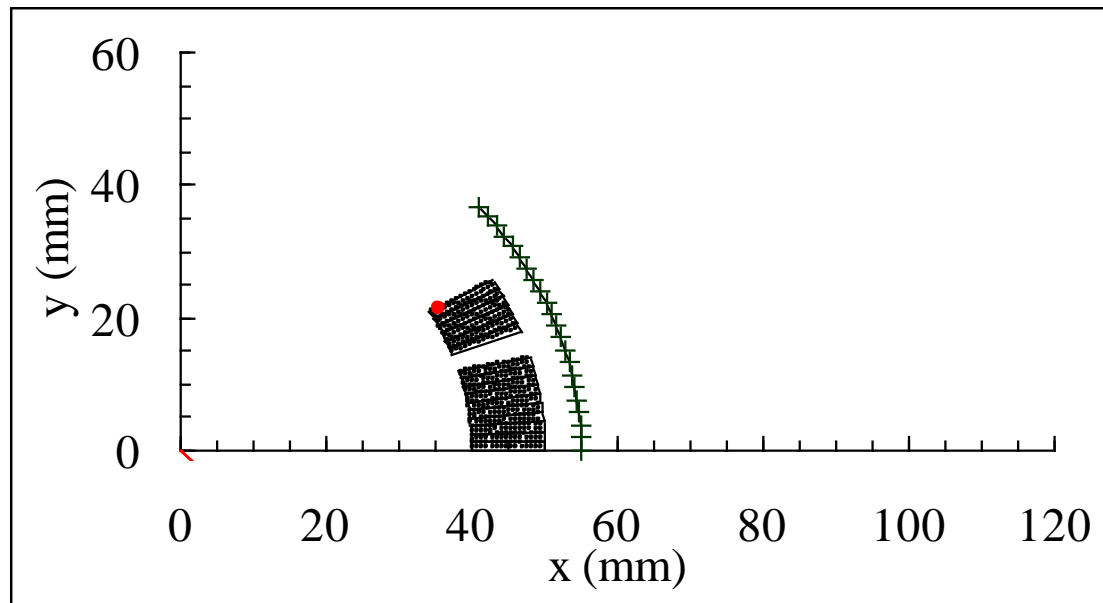

LEP II MQC

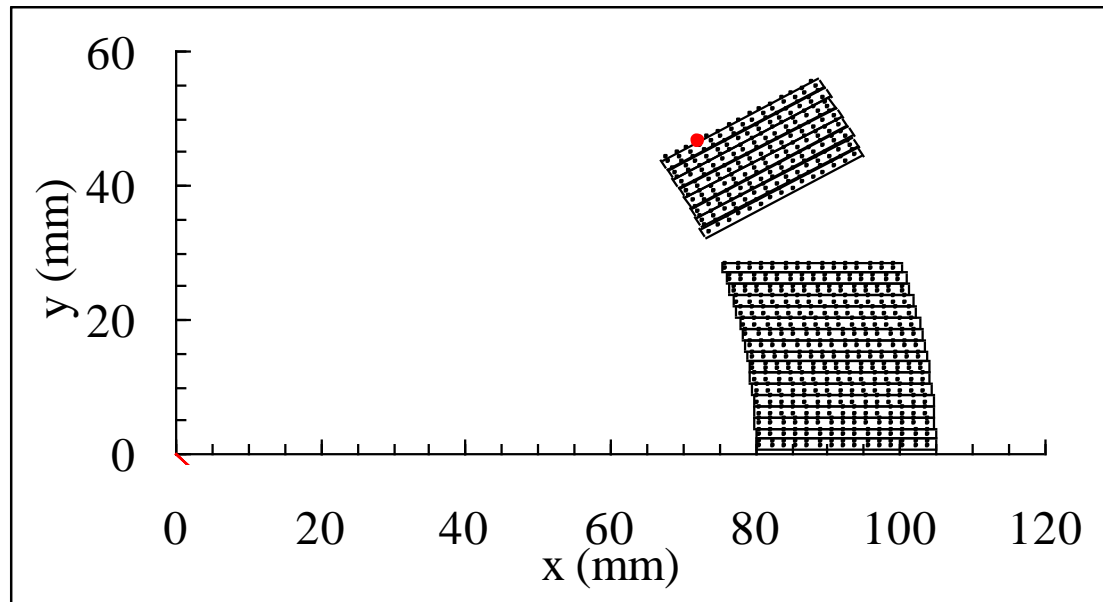

LEP I MQC

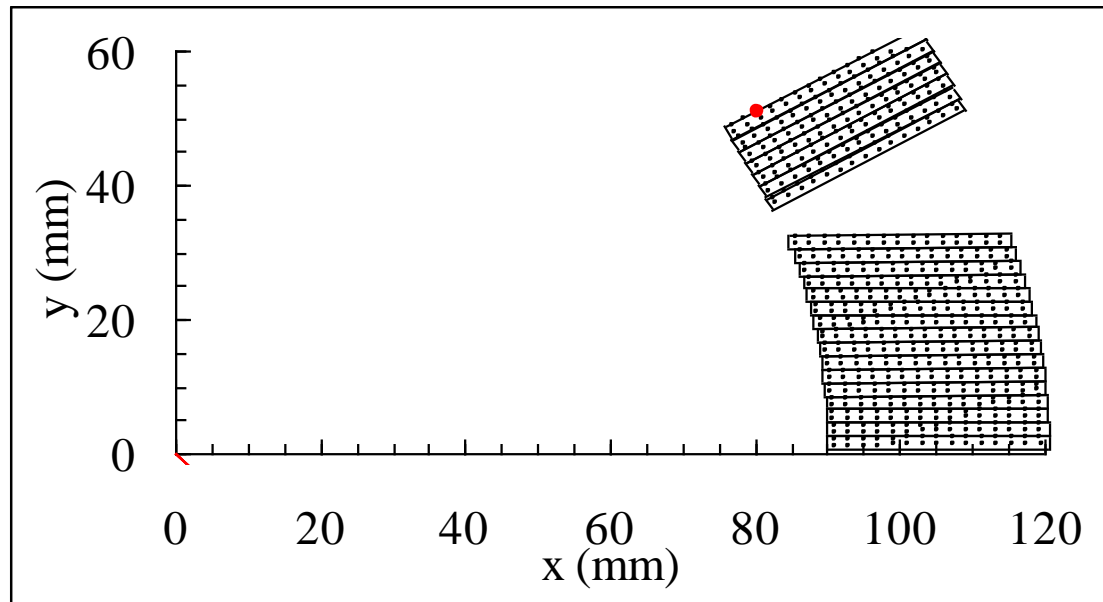

Tevatron MQ

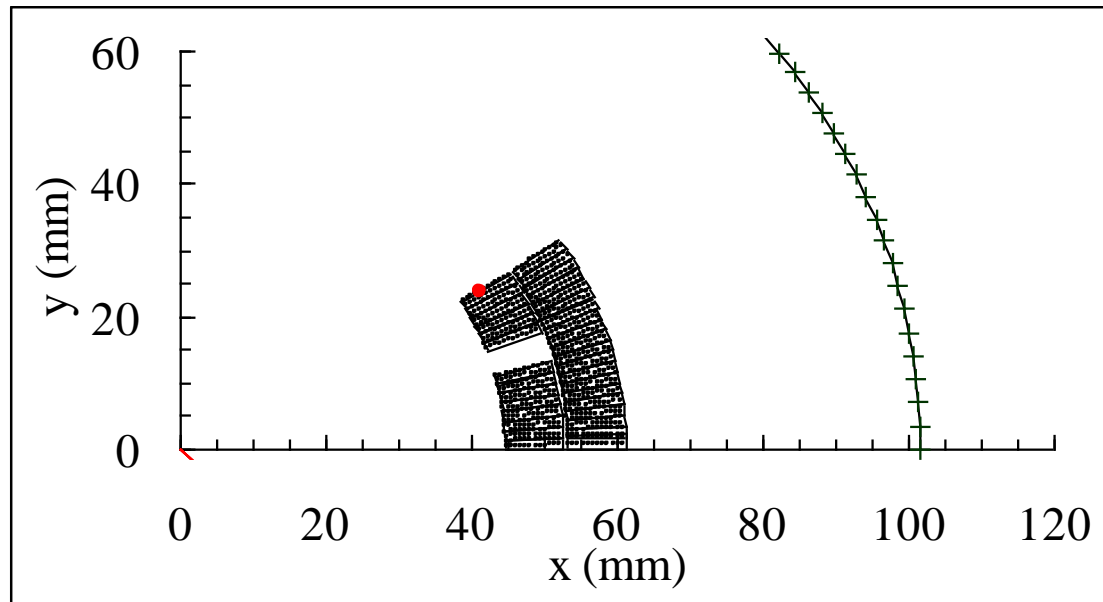

HERA MQ

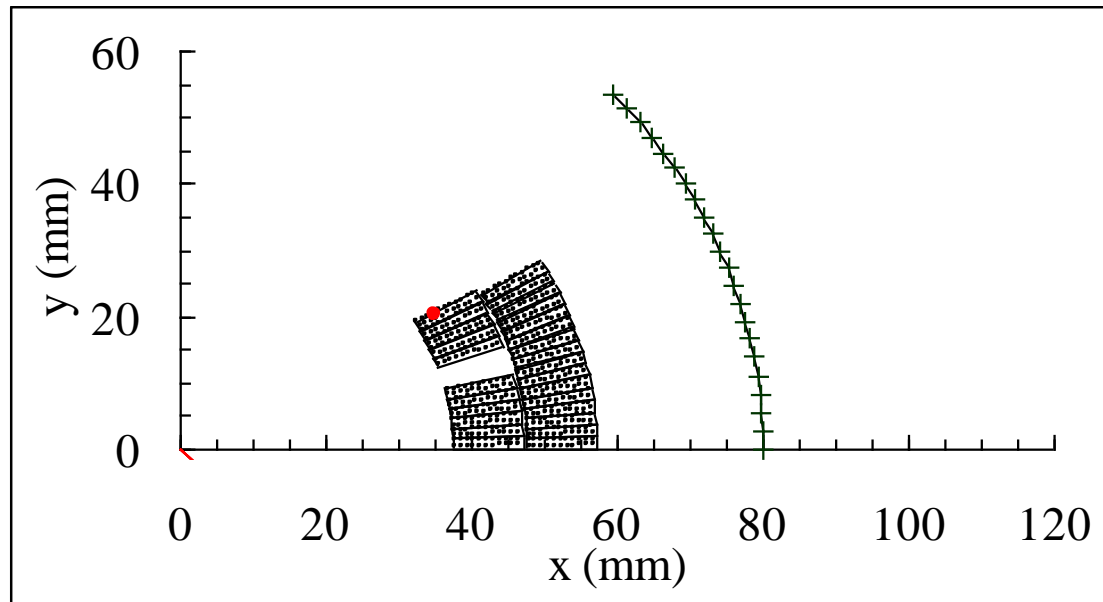

Review of quadrupole lay-outs

LHC MQM

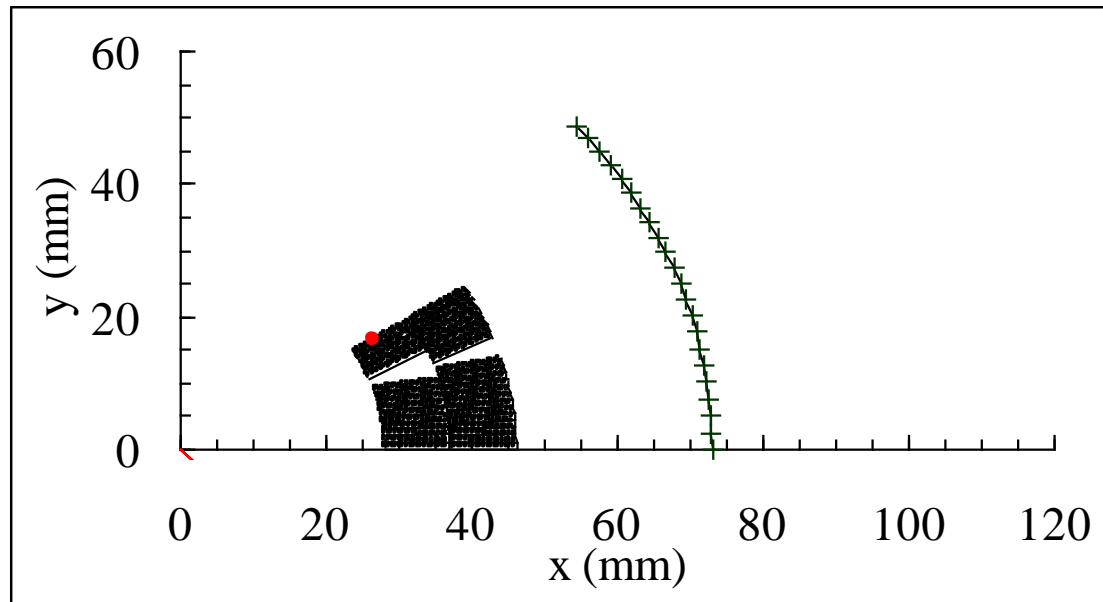

LHC MQY

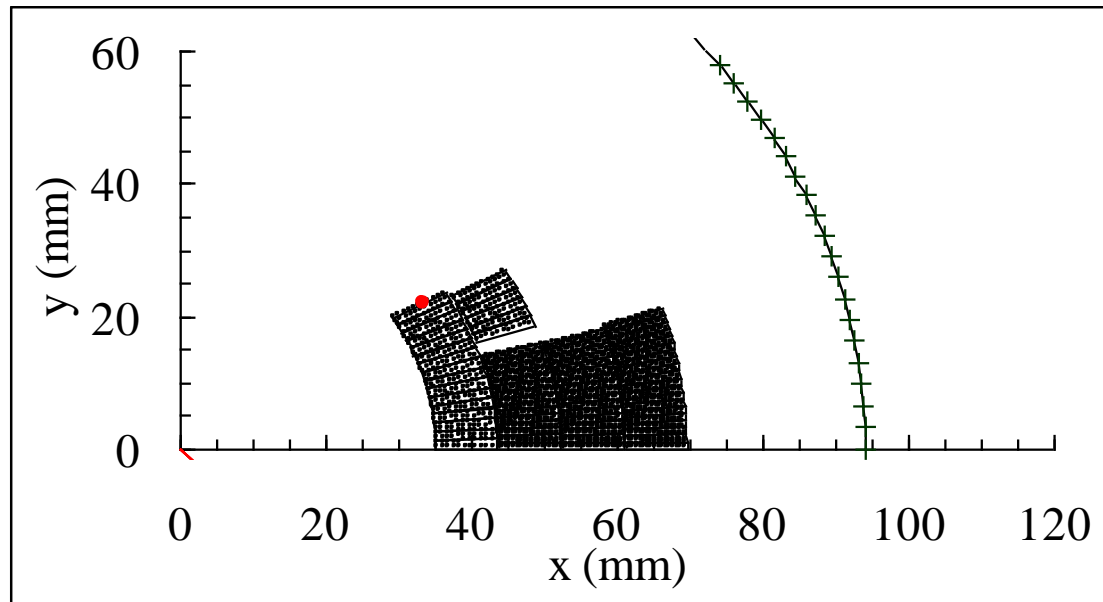

Review of quadrupole lay-outs

LHC MQXB

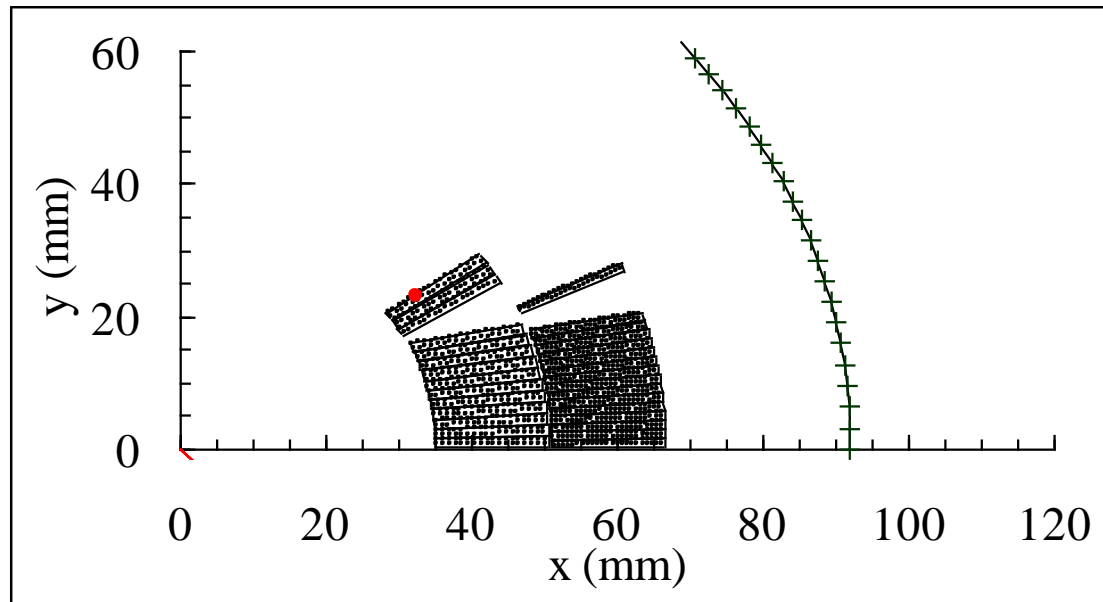

Review of quadrupole lay-outs

SSC MQ

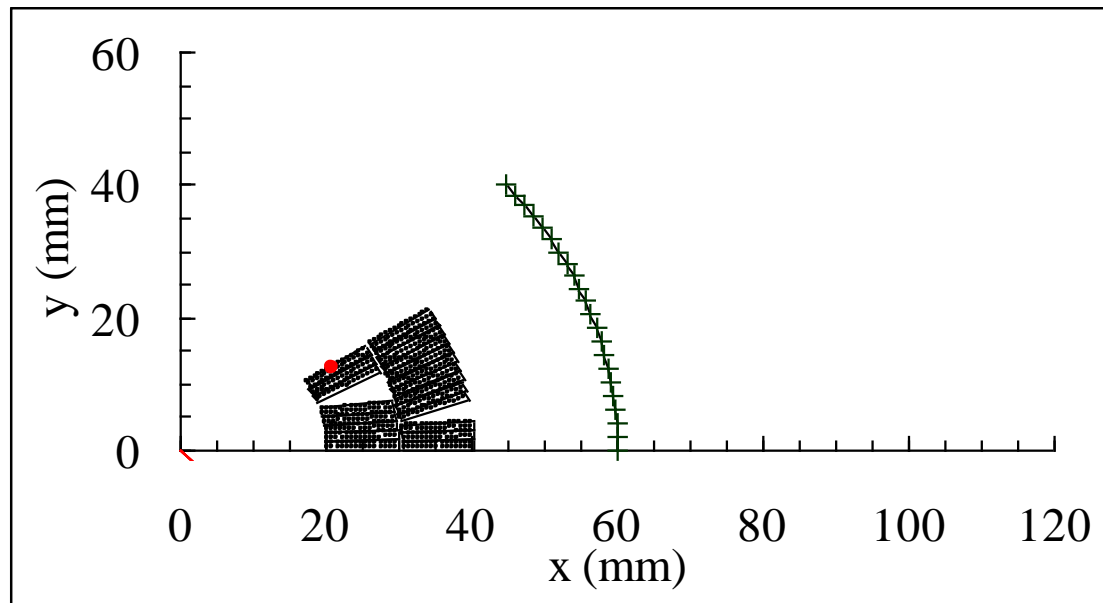

LHC MQ

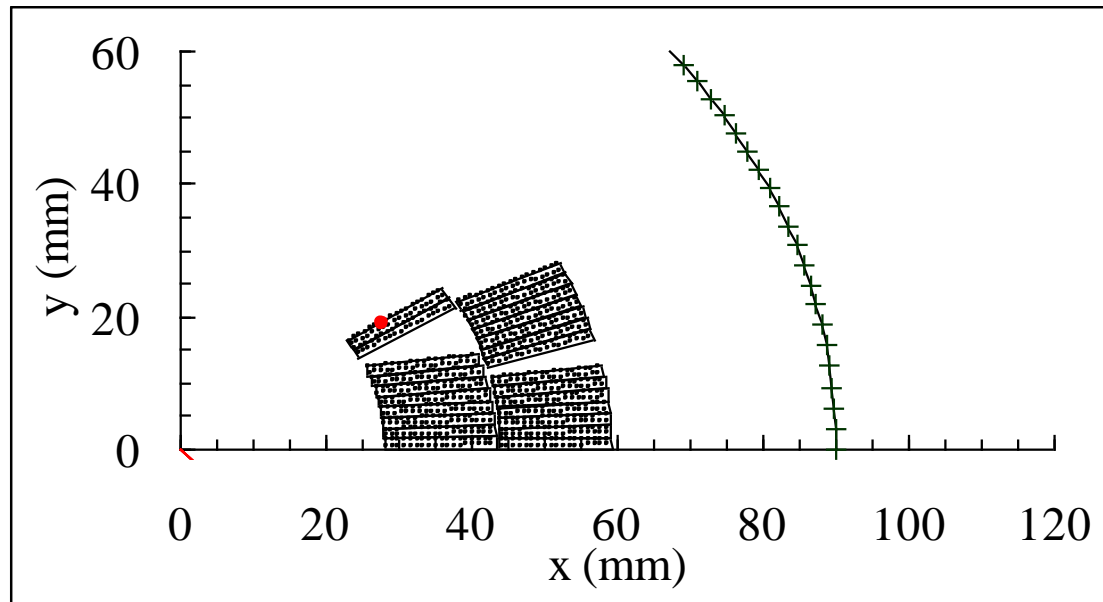

Review of quadrupole lay-outs

LHC MQXA

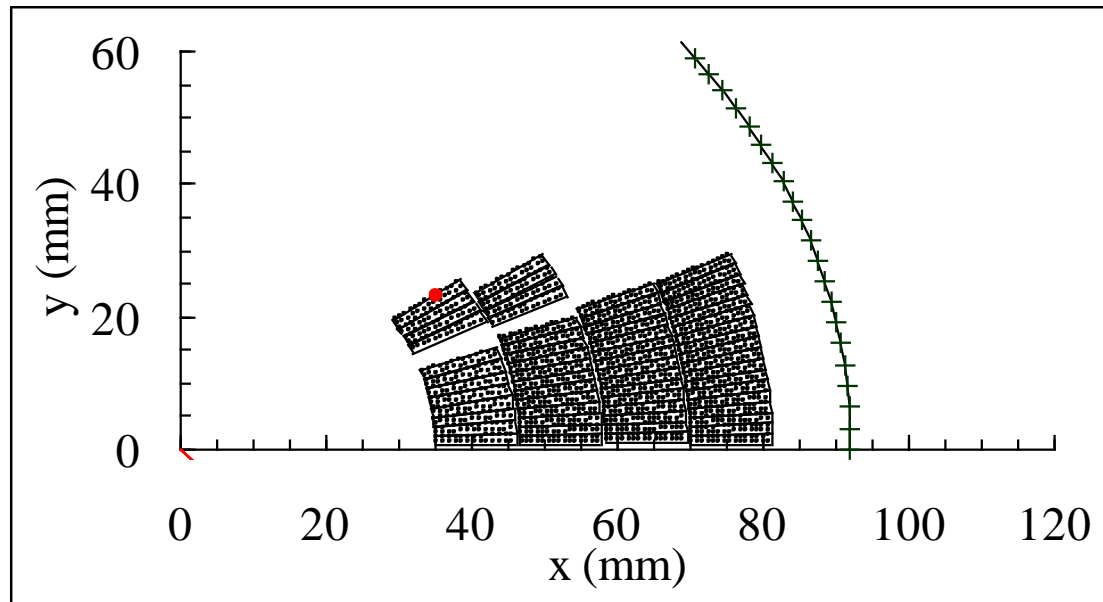

LHC MQXC

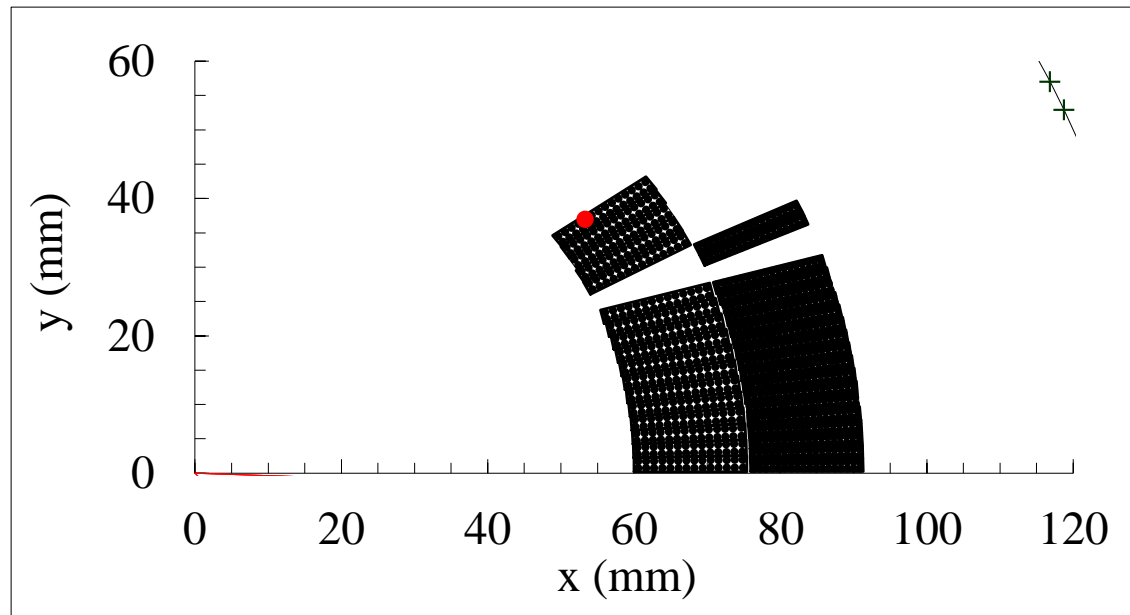

LARP HQ

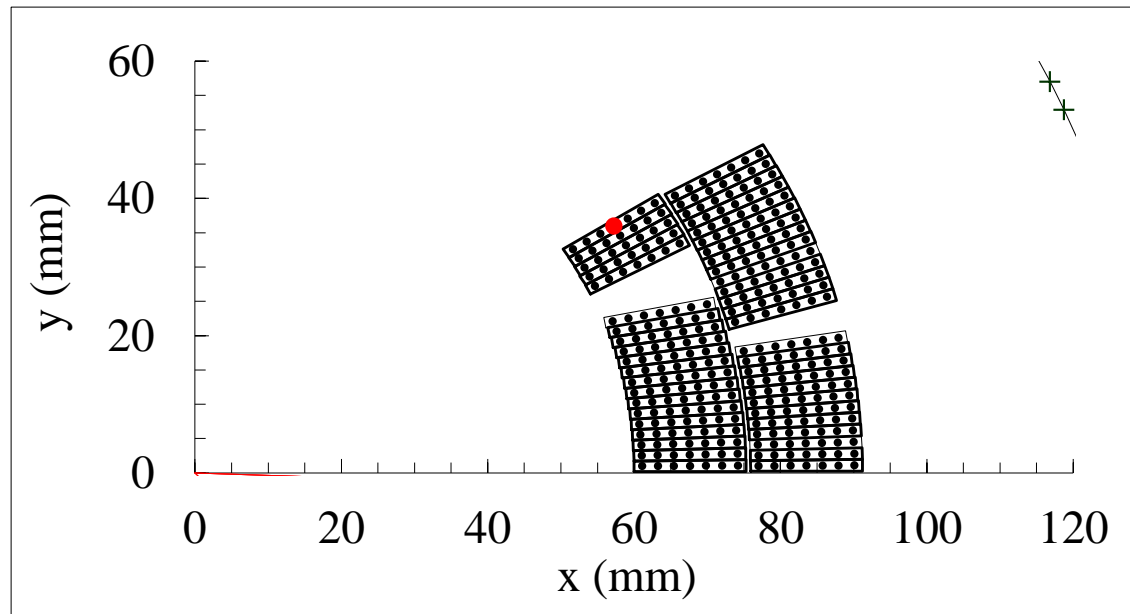



Appendix

- Important property: starting by the multipolar expansion of a current line (Biot-Savart law)

$$B(z) = B_y(z) + iB_x(z)$$

$$B(z) = \frac{I\mu_0}{2\pi(z - z_0)} = -\frac{I\mu_0}{2\pi z_0} \frac{1}{1 - \frac{z}{z_0}}$$

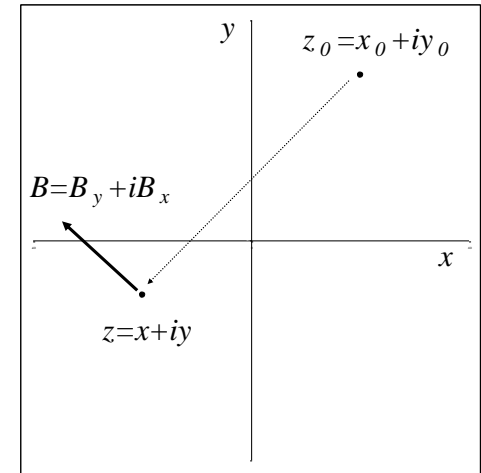

$$B(z) = -\frac{I\mu_0}{2\pi z_0} \sum_{n=1}^{\infty} \left(\frac{z}{z_0} \right)^{n-1} = -\frac{I\mu_0}{2\pi z_0} \sum_{n=1}^{\infty} \left(\frac{R_{ref}}{z_0} \right)^{n-1} \left(\frac{x + iy}{R_{ref}} \right)^{n-1}$$

$$B_y + iB_x = 10^{-4} B_1 \sum_{n=1}^{\infty} (b_n + ia_n) \left(\frac{x + iy}{R_{ref}} \right)^{n-1} \quad b_n + ia_n = -\frac{I\mu_0 10^4}{2\pi z_0 B_1} \left(\frac{R_{ref}}{z_0} \right)^{n-1}$$

A “good” field quality dipole Sector quadrupole

- Let's look at the quadrupoles
- First allowed multipole B_6 (dodecapole)

$$B_6 = \frac{\mu_0 j R_{ref}^5}{\pi} \frac{\sin(6\alpha)}{6} \left(\frac{1}{r^4} - \frac{1}{(r+w)^4} \right)$$

for $\alpha = \pi/6$ (i.e. a **30° sector coil**) one has $B_6 = 0$

- Second allowed multipole B_{10}

$$B_{10} = \frac{\mu_0 j R_{ref}^8}{\pi} \frac{\sin(10\alpha)}{10} \left(\frac{1}{r^8} - \frac{1}{(r+w)^8} \right)$$

for $\alpha = \pi/10$ (i.e. a **18° sector coil**) or for $\alpha = \pi/5$ (i.e. a **36° sector coil**) one has $B_{10} = 0$

- The conditions look similar to the dipole case ...

