



Accelerator Driven Systems



Jean-Luc BIARROTTE
CNRS-IN2P3, France
jlbiarrotte@admin.in2p3.fr



MYRRHA Research
and Transmutation
Endeavour



- 1. Introduction**
- 2. The P&T strategy**
- 3. The MYRRHA project**
- 4. The reference ADS linac concept**
- 5. Main R&D achievements**
- 6. Conclusion**



MYRRHA Research
and Transmutation
Endeavour

THE FRAMEWORK PROGRAMME FOR RESEARCH AND INNOVATION

HORIZON 2020

1. Introduction

High power proton accelerators

Production of **intense flux of secondary particles**
relevant for several domains of fundamental or applied science

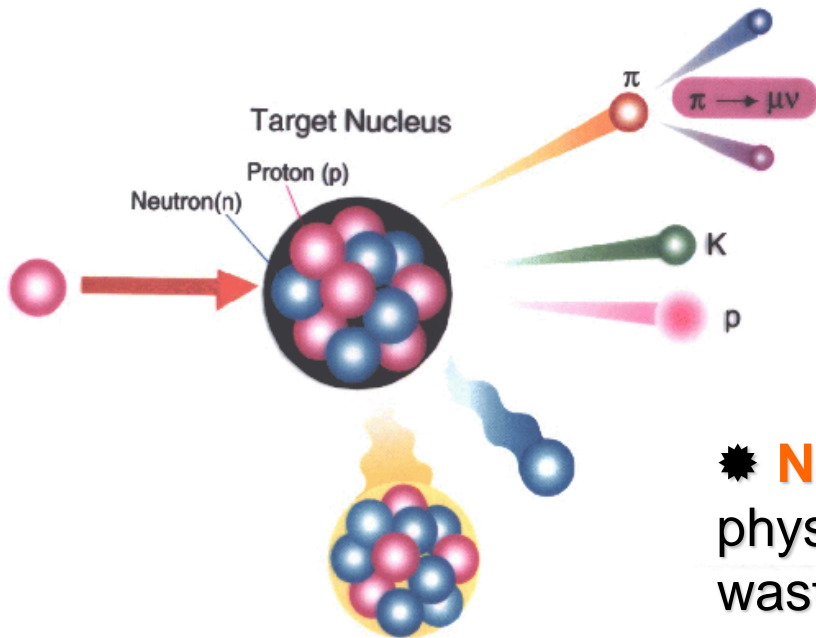

☀ Muons, neutrinos...
for **Particle physics**

☀ **Neutrons** for condensed matter physics, material physics, irradiation, transmutation of long-lived nuclear wastes...

☀ Radioactive ions... for **Nuclear physics**

Example #1: SPIRAL-2 (GANIL) & EURISOL

✦ SPIRAL-2 project @ GANIL (Caen, F)

- Physics of exotic nuclei mainly, using the ISOL method
- Primary beams: protons, deuterons, heavy ions, up to 200 kW CW
- Phase 1 (driver linac) under commisioning

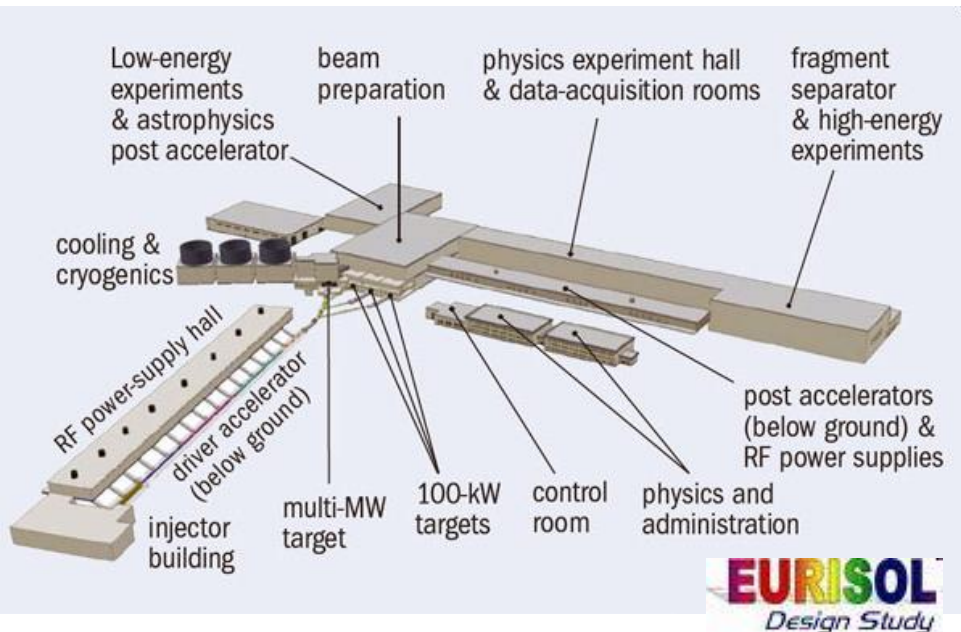
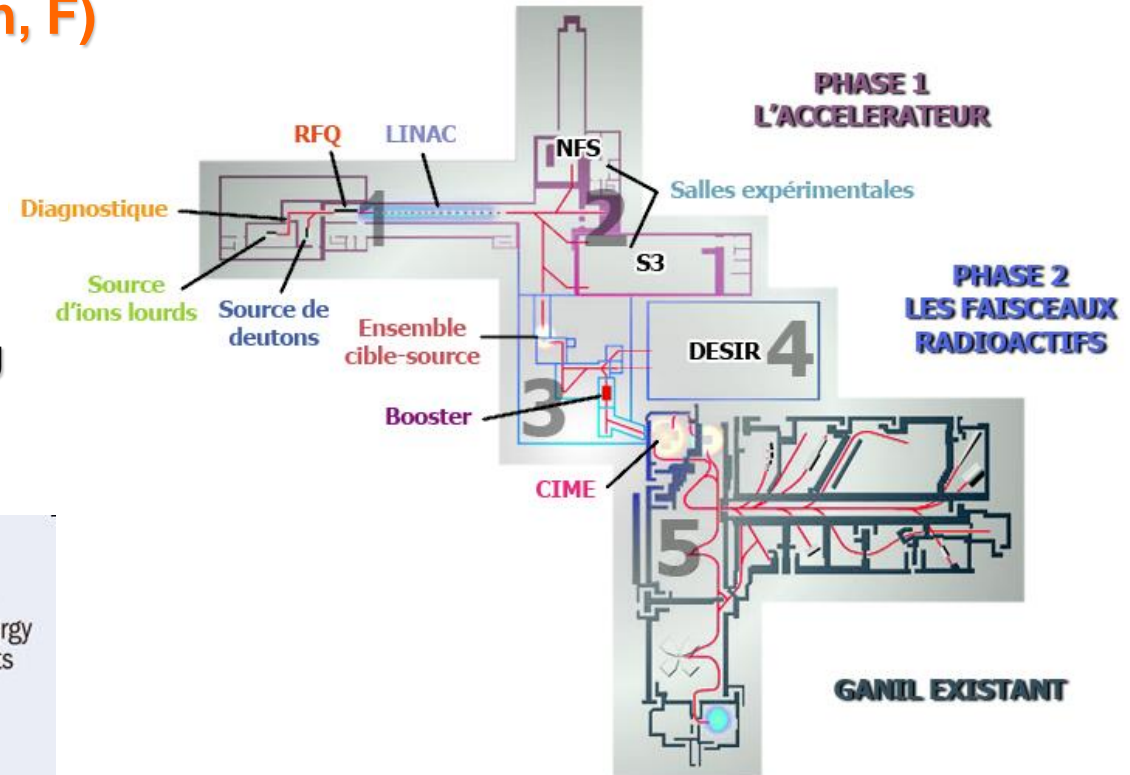

✦ EURISOL project

- New generation radioactive ion beam facility (ISOL method)
- Primary beams up to 5 MW

Example #2: SPL project (CERN)

★ SPL project @ CERN

- LHC luminosity upgrade
- Neutrino physics (π , μ decay, or ${}^6\text{He}$, ${}^{18}\text{Ne}$ decay)
- SPL project presently stopped
- LINAC 4 (160 MeV) under commissioning

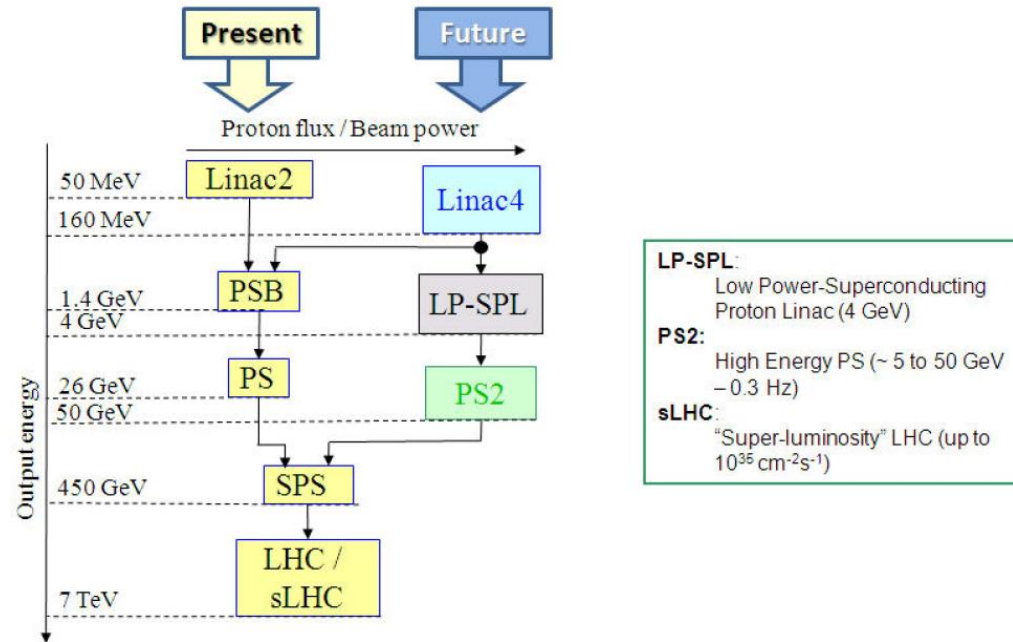
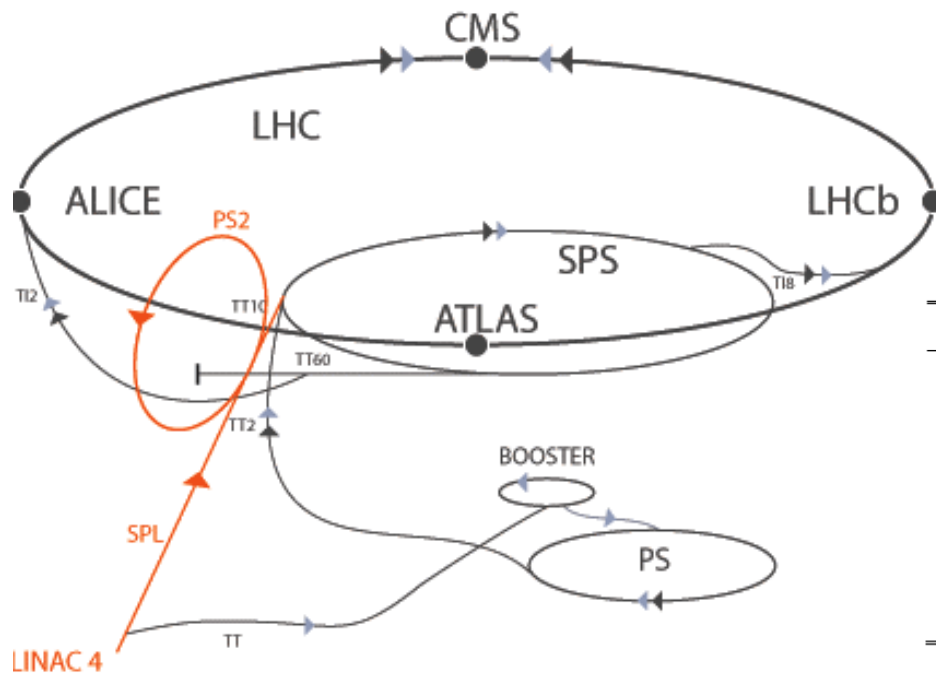

Table 2: Low Power and High Power SPL beam characteristics

	LP-SPL	HP-SPL Option 1	HP-SPL Option 2
Maximum kinetic energy [GeV]	4	4 or 5 ^a	4 or 5 ^a
Average beam current during pulse [mA]	20	20	40 ^b
Pulsing rate [Hz]	2	50	50
Pulse duration [ms]	0.9	0.9	1.2 ^b
Beam power [MW]	0.14	2.25 @ 2.5 GeV or 4.5 MW at 5 GeV	5 @ 2.5 GeV and 4 MW at 5 GeV

^a Required for a neutrino factory.

^b Required for 2 simultaneous users of high beam power or for 5 MW at 2.5 GeV

Example #3: SNS (Oak Ridge, USA)



History of Beam Power on Target

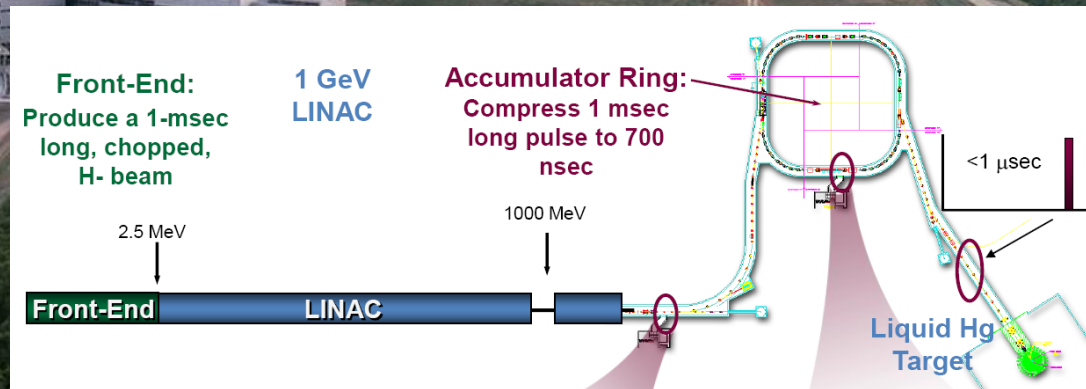
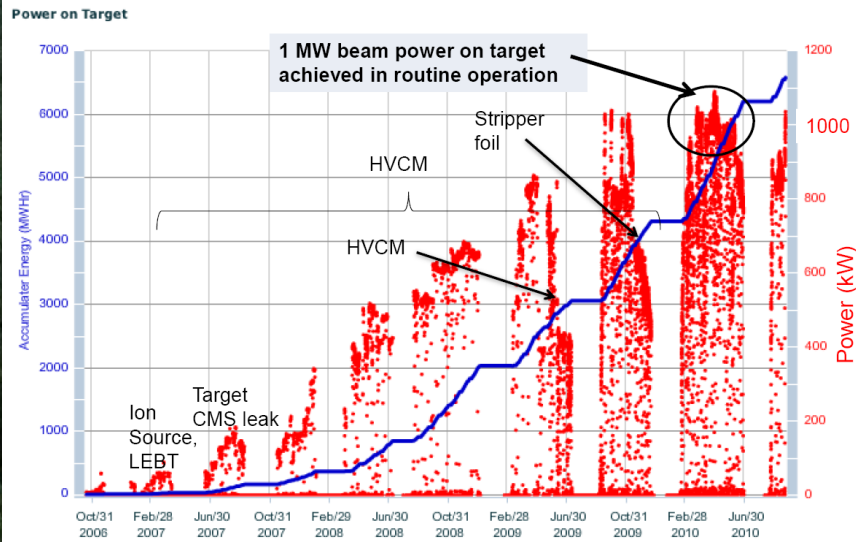

SNS-03671-2005

A few other machines & projects

✿ J-PARC facility (Japan)



✿ ESS project (Sweden)

✿ PSI (Switz.)



✿ MYRRHA project (Belgium)

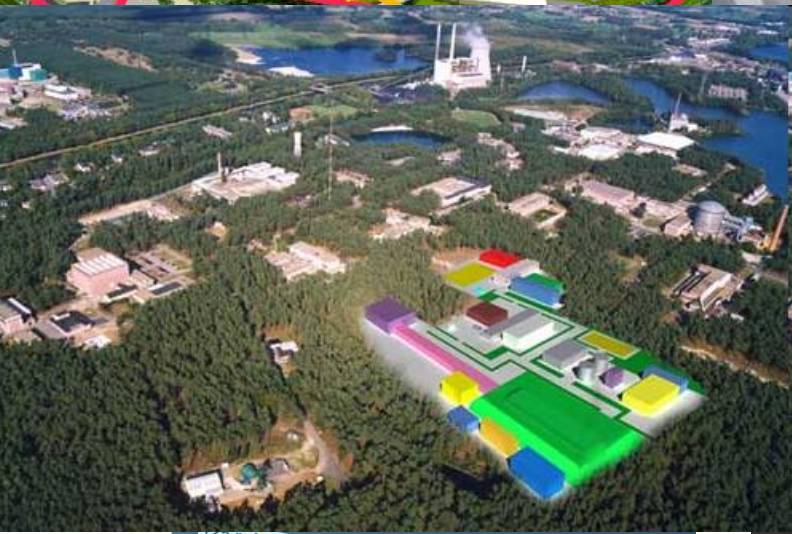
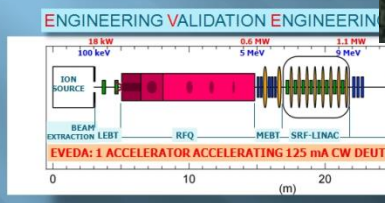
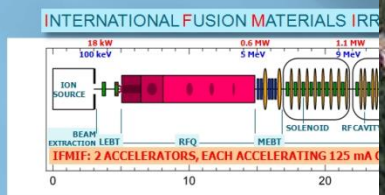

✿ FAIR project (Germany)

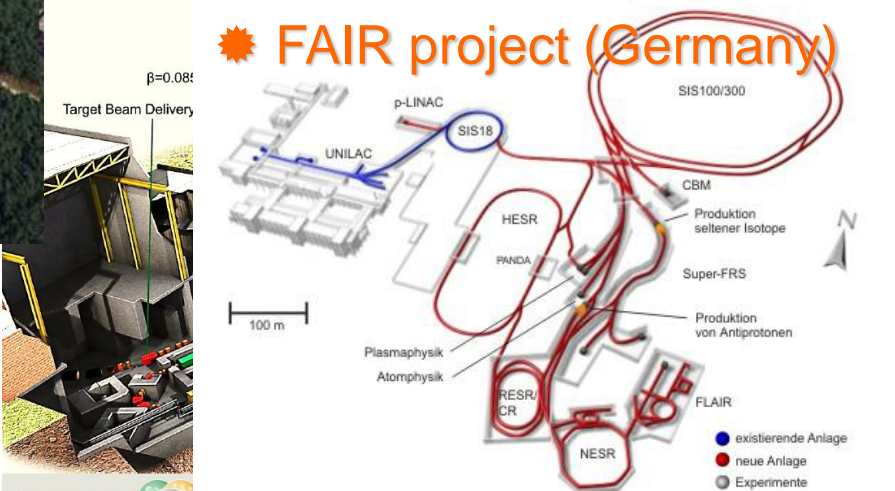

✿ IFMIF project

✿ F-RIB (US)



U.S. Department of Energy Office of Science
Michigan State University

Challenges and Progress, HIAI 2012, Chicago
M. Leitner, SRF 2013, Slide 8

Main associated challenges

These high power machines require an **excellent beam transmission** to be allowed to operate: beam loss level must be $< 10^{-6}$ per meter typically

✱ Physics of intense hadron beams

- Management of space charge effects
- Understanding of beam halo generation during transport

✱ R&D on new technologies

- Accelerating cavities (RFQ, superconducting cavities)
- Diagnostics for intense hadron beams, Machine Protection System
- New generation targets (MegaWatt)
- High power Radio-Frequency elements

✱ Increased demand for flexibility and reliability

- Higher & higher beam availability is required
- High diversity of primary beam in a single machine (nuclear physics application)
- Beam interruptions forbidden (ADS application)



2. The P&T strategy (Partitionning & Transmutation)

Formation of nuclear wastes

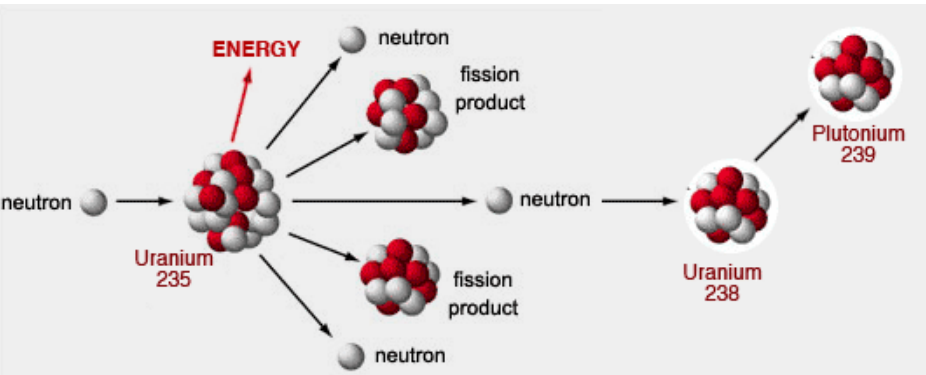

➤ Major (U, Pu) & Minor Actinides (AM)

Figure A1-IV
CHAÎNE D'ÉVOLUTION DES NOYAUX LOURDS EN REACTEUR REP

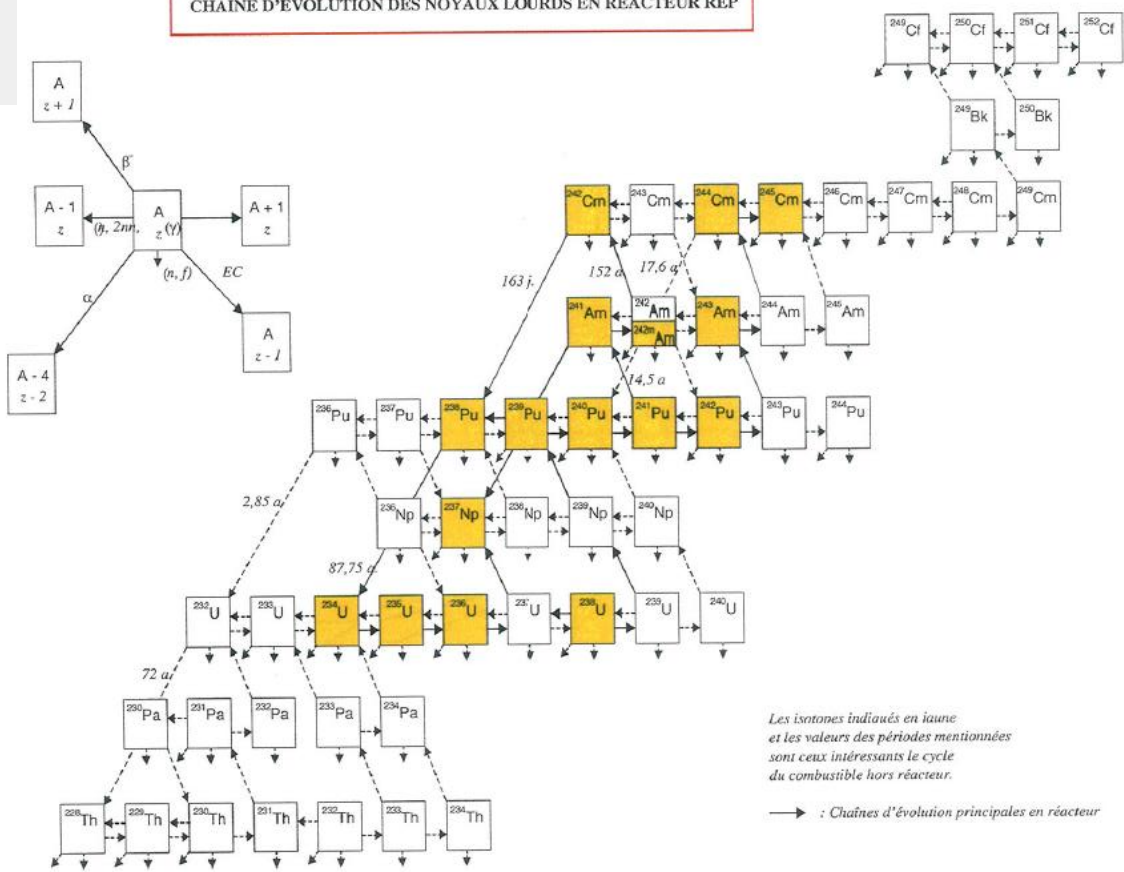

Les isotopes indiqués en jaune et les valeurs des périodes mentionnées sont ceux intéressants le cycle du combustible hors réacteur.
→ : Chaînes d'évolution principales en réacteur

➤ Fission Products

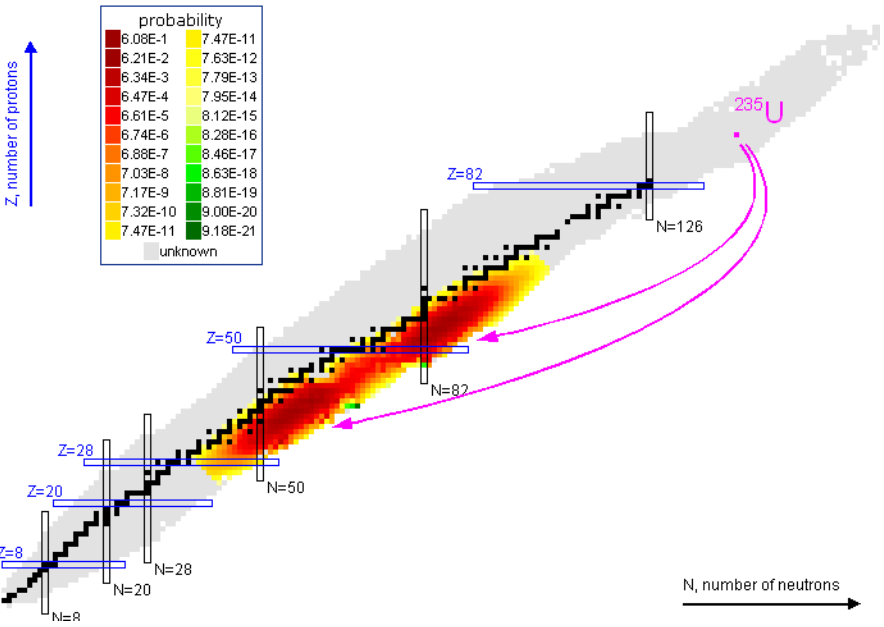

Nuclear wastes: present situation

- About 2500 tons of Spent Nuclear Fuel are produced every year by the 145 reactors of EU
- High Level Wastes represent 0.2% in volume & 95% in radiotoxicity and are long-term dominated by **Minor Actinides** (MA, especially ^{241}Am)
- Reference solution for HLW management = long-term **geological disposals**



The Yucca Mountain Nuclear Waste Repository (USA)
project de-funded in 2011

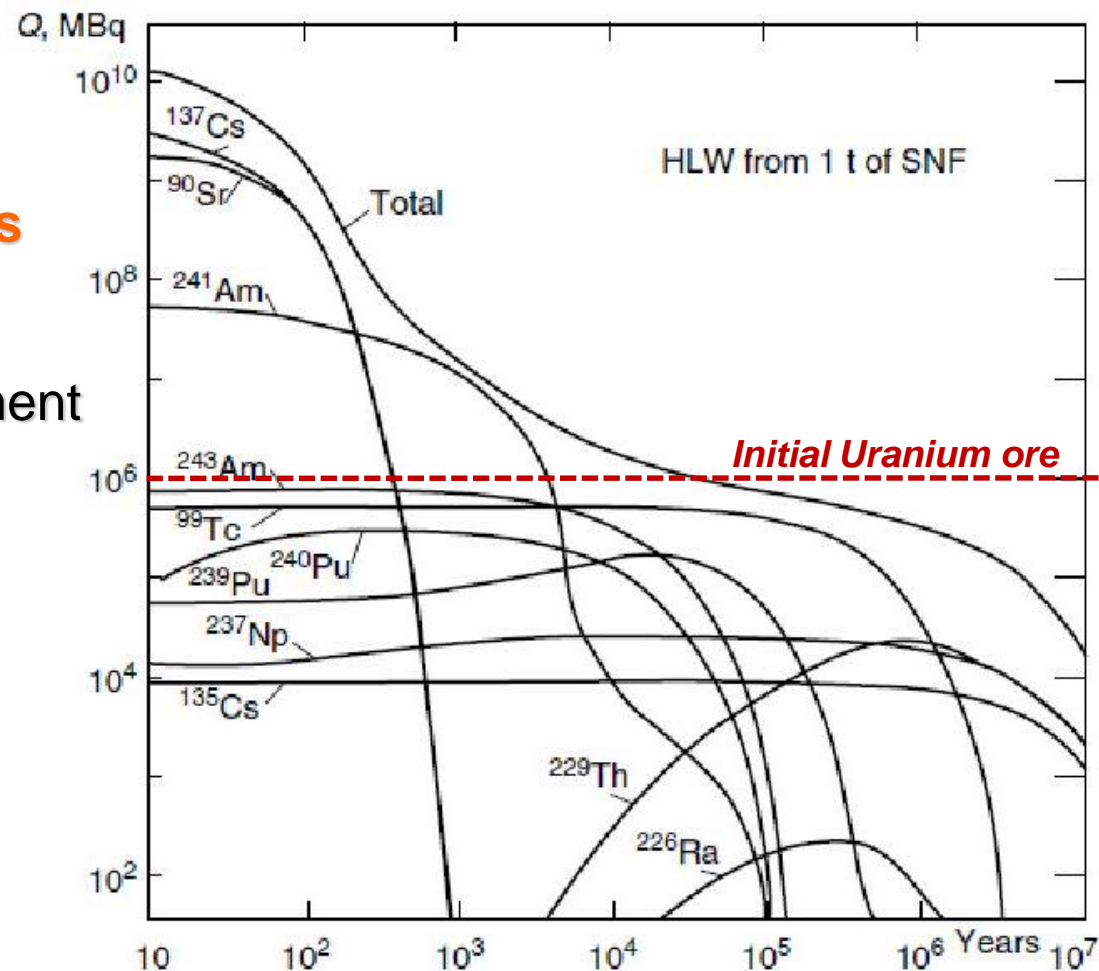

Spent fuel reprocessing

- In France (La Hague), **spent fuel is reprocessed**
- U and Pu are extracted (partitionning) to be reused as fuel: MOX, future Gen.IV reactors...
- High-level wastes are conditioned (vitrification) & stored...



Schéma d'un colis primaire de déchets C vitrifiés R7T7.



Motivation for Partitioning & Transmutation

➤ **Partitioning & Transmutation (P&T) strategy:** reduce radiotoxicity, volume and heat loads of long-lived nuclear wastes (especially MA) before geological storage

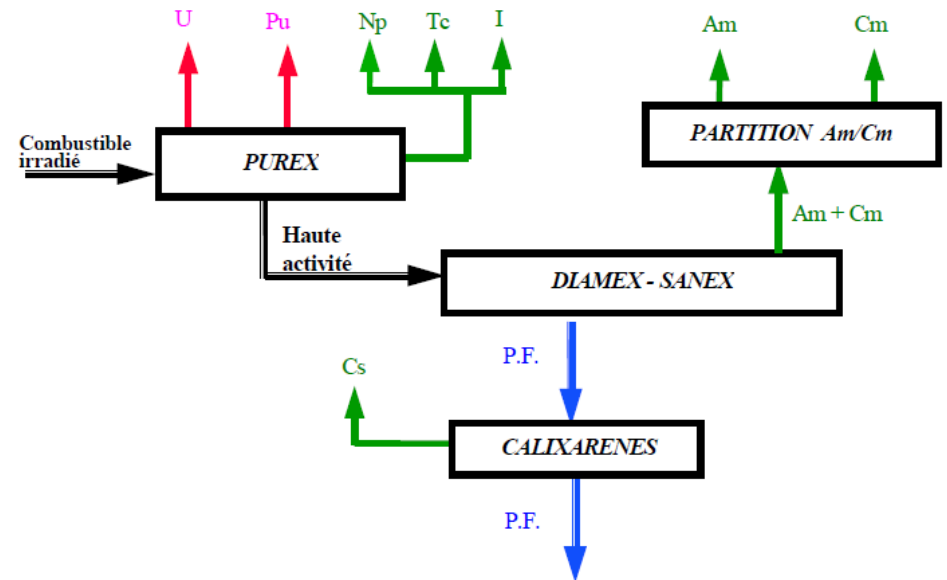
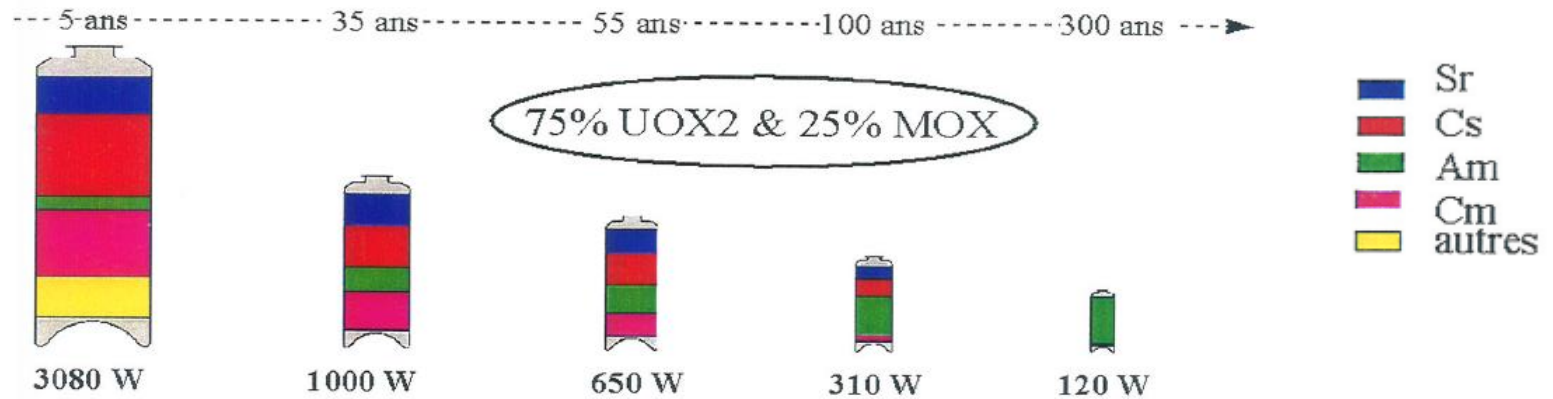
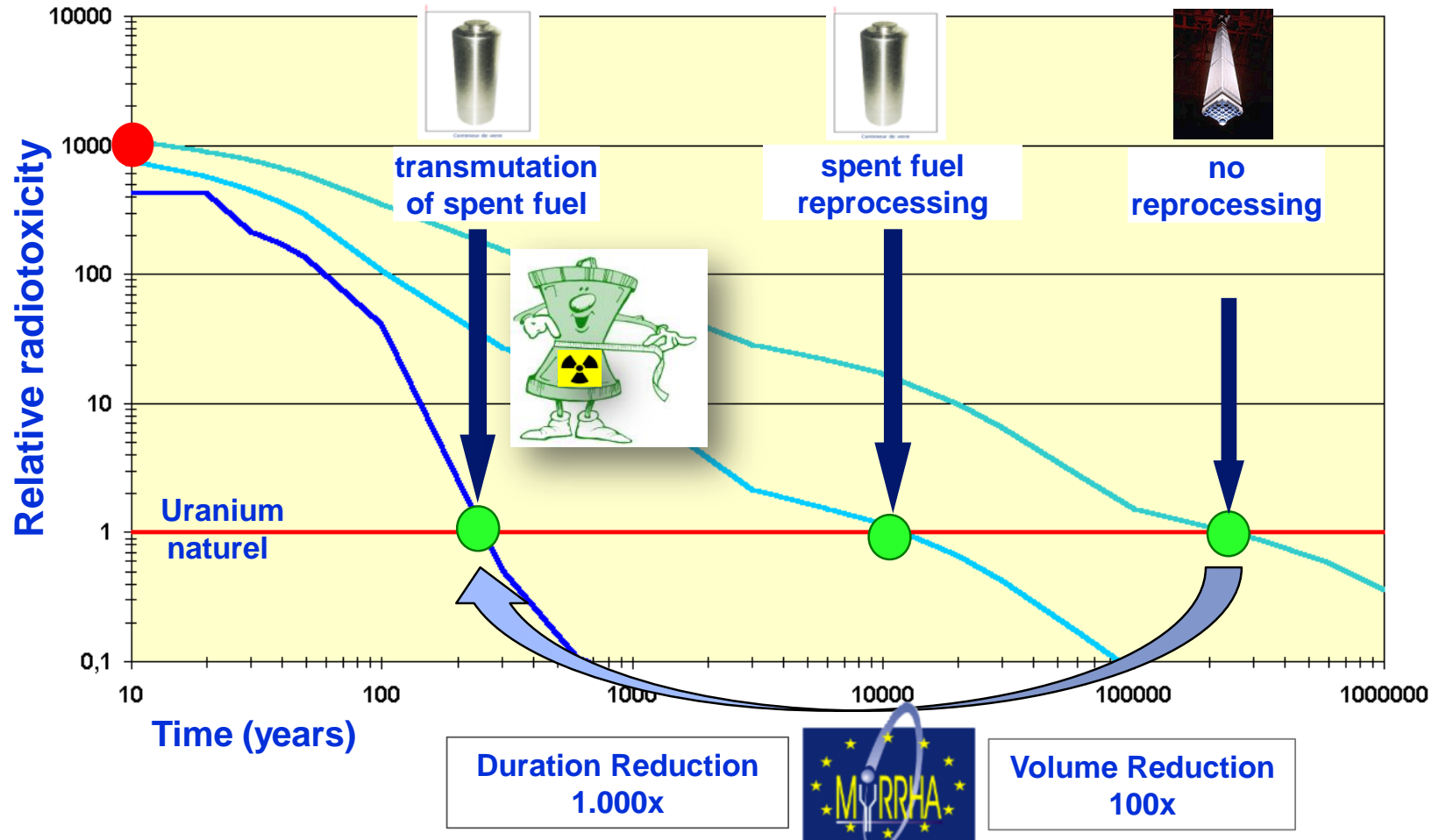

H. Aït Abderrahim (SCK•CEN)

Present options for transmutation of Minor Actinides

Transmutation of MA into fission products is efficient only if:

- Fission to capture cross section ratio is high enough
- Enough neutrons are available to feed the transmutation process

=> **Need for a fast neutron spectrum**

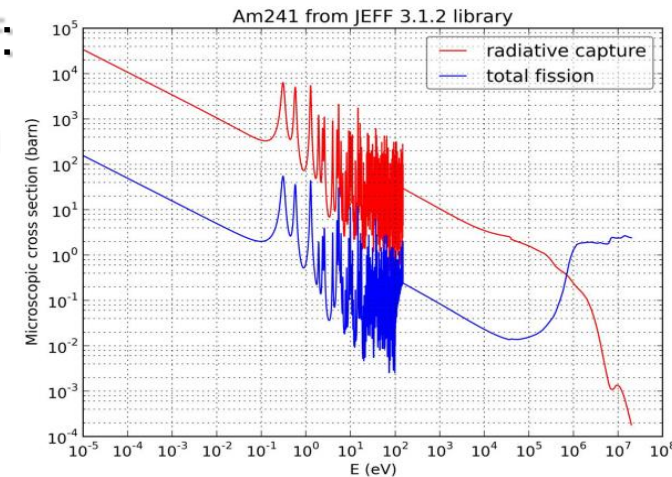

In which type of fast reactor could we transmute ?

- In the next generation **GEN-IV nuclear power plants** (critical Fast Reactors)
 - ✓ homogeneous mode with low AM content in fuel (< 3%) for safety reasons
 - ✓ heterogeneous mode (MA blankets)

➤ In a few **dedicated MA burners** (subcritical Accelerator Driven Systems), highly loaded with MA

=> sensitive compromise btwn **safety / economics / proliferation / politics...**

ADS (Accelerator Driven System)

ADS sub-critical systems = present reference solution for dedicated “transmuter” facilities

- Suited for various strategies on nuclear energy
- One “small” 400 MW_{th} industrial ADS could burn about 100kg of MA / year (→ 10 to 20 units for EU)
- Not competitive for electricity production

ADS reactor specificities

- Neutron multiplication factor $k_{\text{eff}} < 1$ (typically between 0.93 & 0.97)
- Minimal probability of runaway reaction: no control rods, no safety rods required
- Driven by external neutron source (proton beam + spallation target)
- Some very fast neutrons (> 20 MeV) in the core
- The beam tube may break containment barriers

$$P_{fi} = \eta_{sp} \cdot \frac{\varphi^* \cdot k}{\nu(1-k)} \cdot \frac{i}{C} \cdot E_f$$

where, η_{sp} = spallation neutron yield (≈ 30 for Pb target)
 k = neutron multiplication factor
 φ^* = source importance (≈ 1.5)
 ν = neutrons emitted per fission (≈ 2.5)
 E_f = energy generated per fission ($\approx 3.1 \times 10^{-10}$ W)
 i = accelerator current
 C = charge of a proton ($= 1.6 \times 10^{-19}$ C)

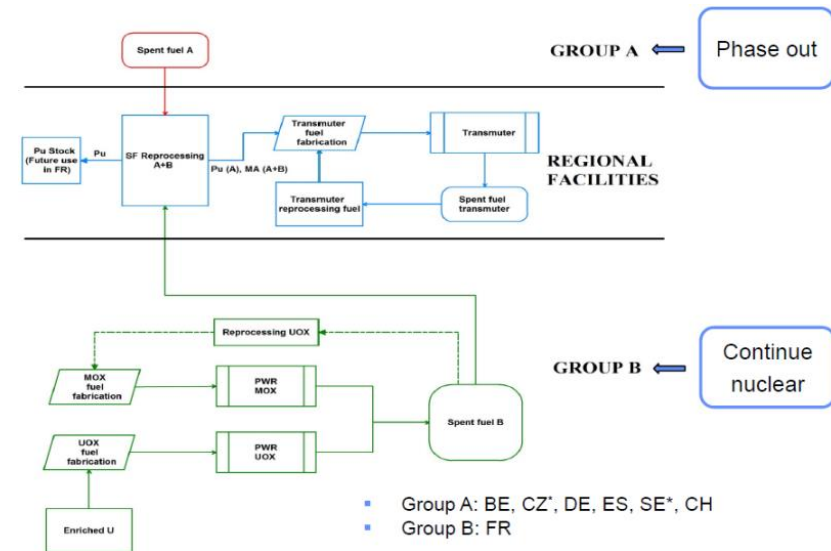

G. Van den Eynde (SCK•CEN)

On the path of ADS demonstration

Design & low-power experiments

- Several ADS design activities since the 90's (US, Europe, Japan, China, India...)
- Several low-power coupling experiments:
 - ❑ FEAT, MUSE, GUINEVERE in Europe
 - ❑ KART in Japan, etc.

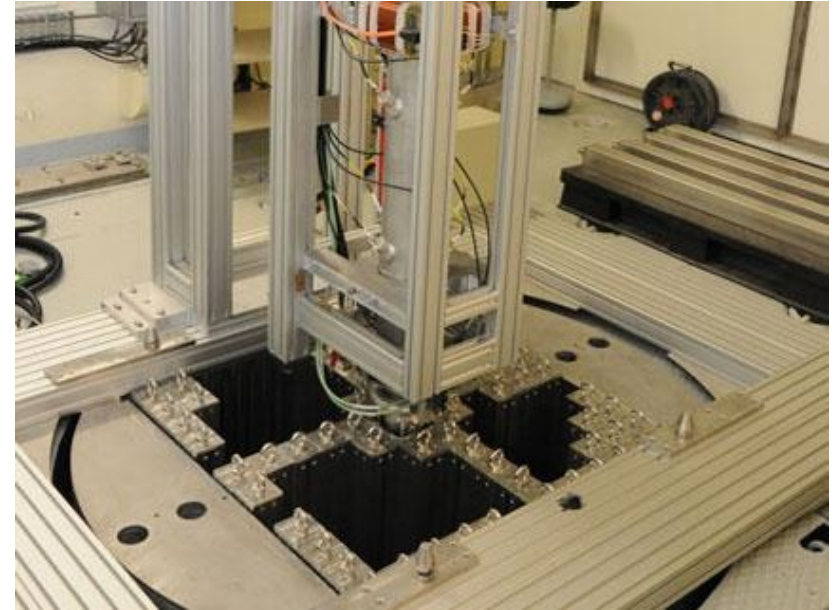

*The Guinevere experiment in SCK*CEN (Belgium), operated since 2011*

High-power ADS demonstration is on-going...

➤ C-ADS project in China

- ❑ 10 MW_{th} ADS (stage 1)
- ❑ 500 MW_{th} ADS (stage 2)

➤ MYRRHA project in EU/Belgium

- ❑ 100 MW_{th} ADS

Background in France & Europe since 1990

- (FR) **Law « Bataille » n° 91-1381, 30 december 1991**
=> French roadmap for research on radioactive waste management
- (EU) ETWG report on ADS, 2001
- (EU-FP5) **PDS-XADS** project (2001-2004)
- (EU-FP6) **EUROTRANS** programme (2005-2010)
- (EU-FP7 + H2020) On-going programmes (2011-2019)
- (FR) **Law n°2006-739, 28 june 2006**
=> Following-up the law « Bataille », with focus on sustainability



Article 3 (...) 1. La séparation et la transmutation des éléments radioactifs à vie longue. **Les études et recherches correspondantes sont conduites en relation avec celles menées sur les nouvelles générations de réacteurs nucléaires** mentionnés à l'article 5 de la loi n° 2005-781 du 13 juillet 2005 de programme fixant les orientations de la politique énergétique ainsi que sur les réacteurs pilotés par accélérateur dédiés à la transmutation des déchets, **afin de disposer, en 2012, d'une évaluation** des perspectives industrielles de ces filières et de mettre en exploitation un **prototype d'installation avant le 31 décembre 2020** ; (...)

P&T = small part of a complex equation...

Energy demand growth



Changes in temperature, sea level and Northern Hemisphere snow

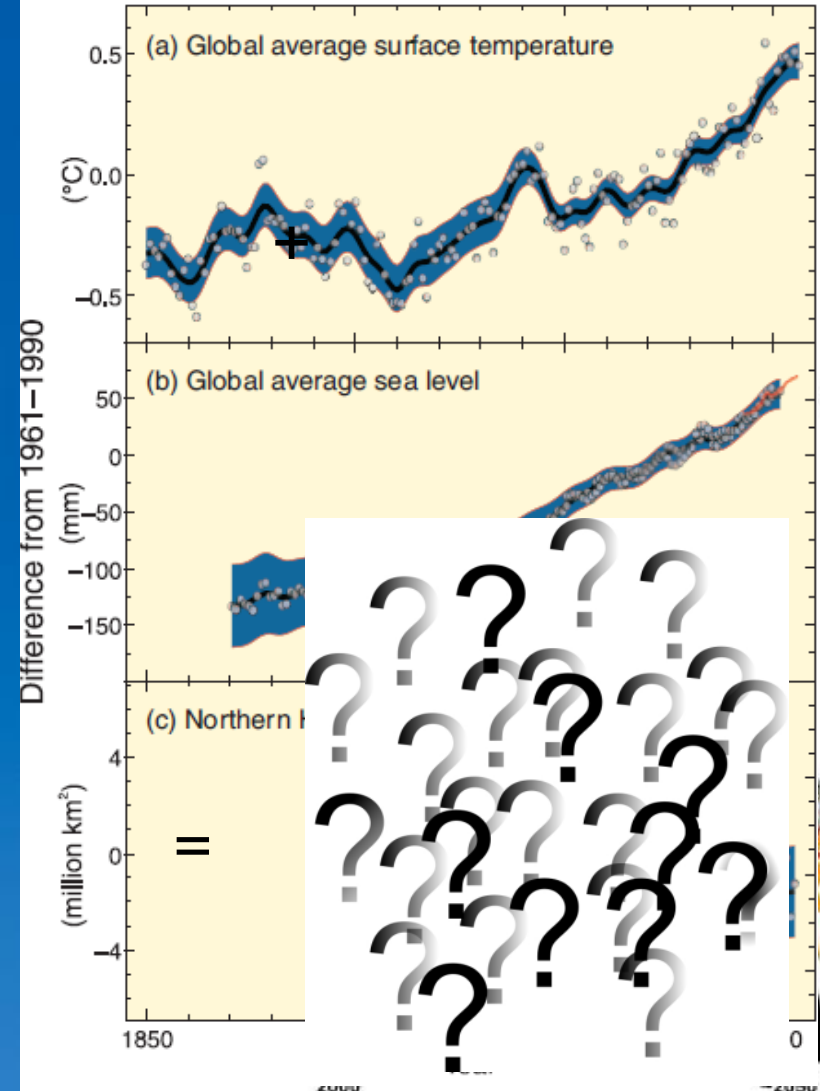



3. The MYRRHA project

MYRRHA as an ADS demonstrator

Demonstrate the physics and technology of an Accelerator Driven System (ADS) for transmuting long-lived radioactive waste

- Demonstrate the **ADS concept** (coupling accelerator + spallation source + power reactor)
- Demonstrate the **transmutation** (experimental assemblies)

Main features of the ADS demo

- 50-100 MWth power
- Highly-enriched MOX fuel
- Pb-Bi Eutectic coolant & target
- k_{eff} around 0.95 in subcritical mode
- 600 MeV, 2.5 - 4 mA proton beam

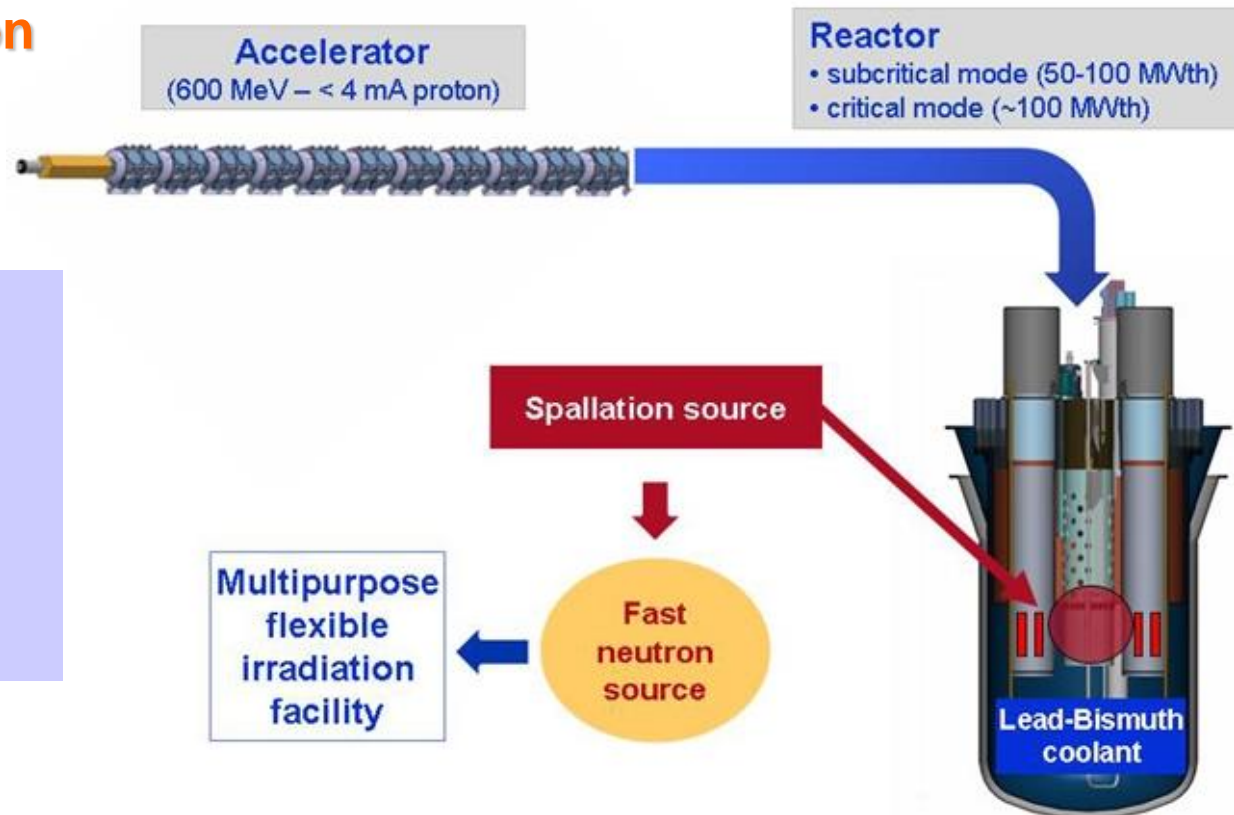

The MYRRHA project

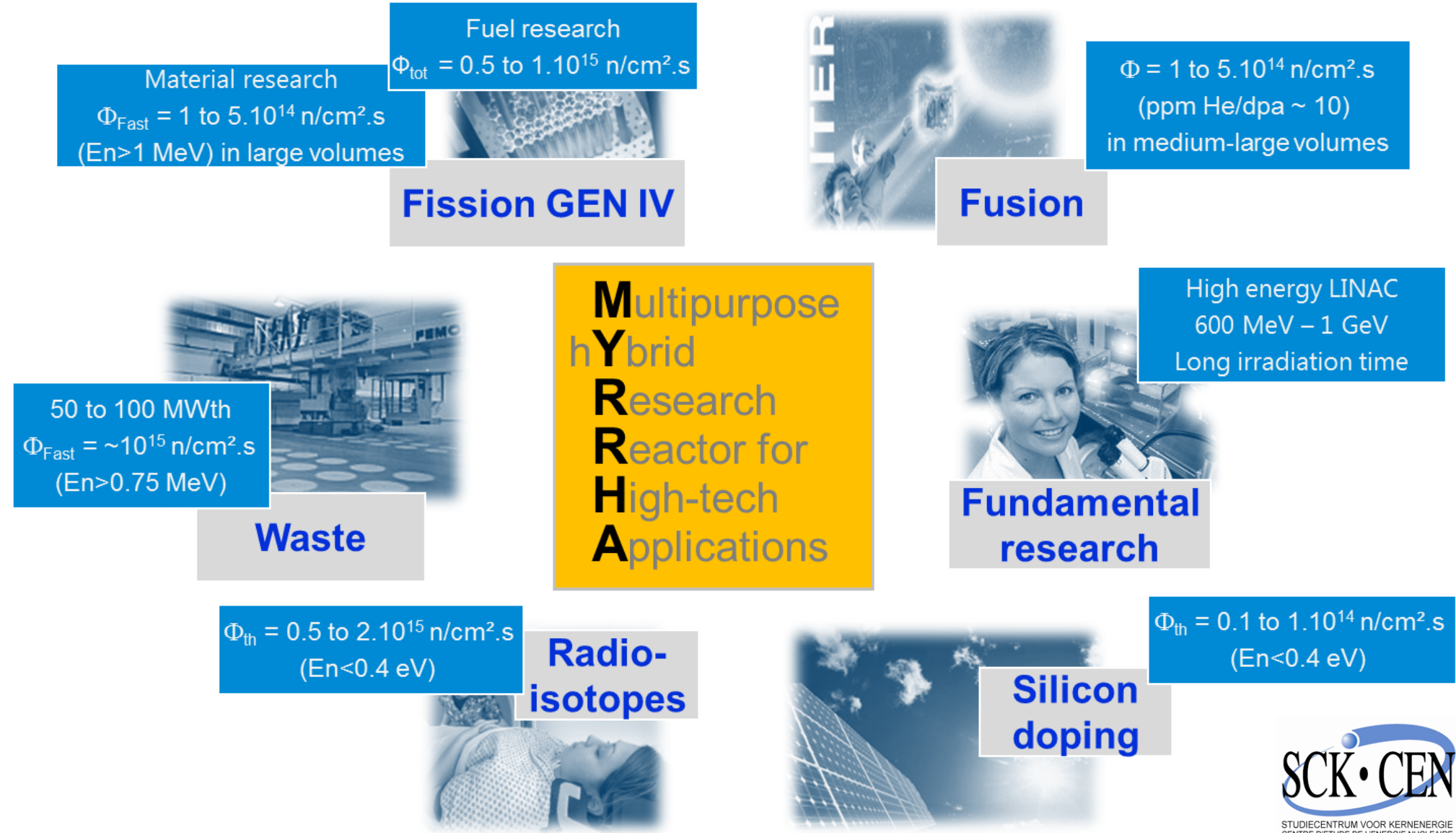

MYRRHA as a flexible irradiation facility

Serve as:

- A supporting infrastructure for **Gen. IV liquid-metal based reactor** concepts
- A European **fast spectrum irradiation facility**

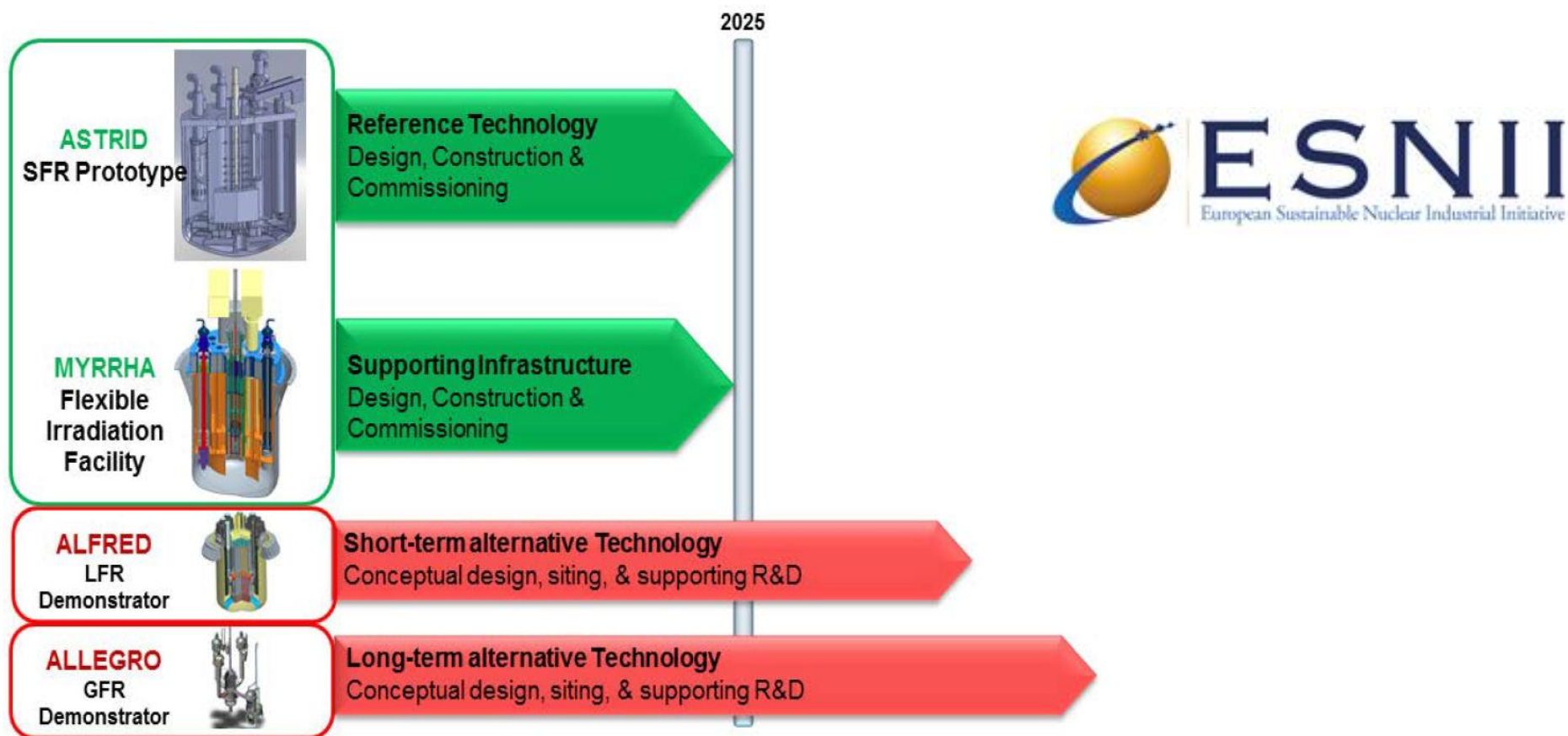

MYRRHA as a replacement for BR2

MYRRHA: a multipurpose irradiation facility at

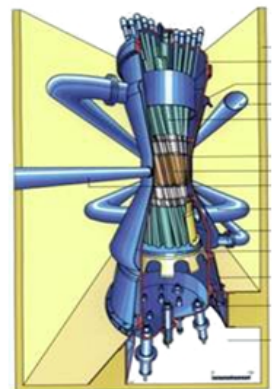

1962
BR2

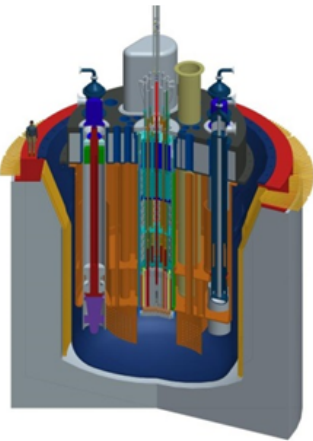
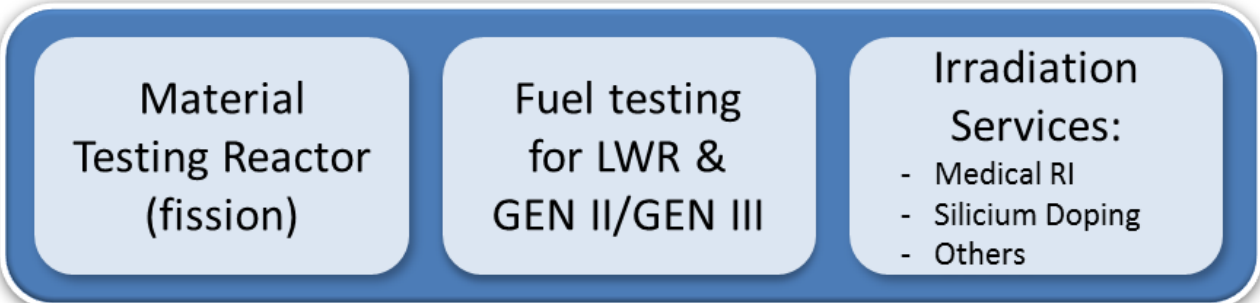

2024
MYRRHA

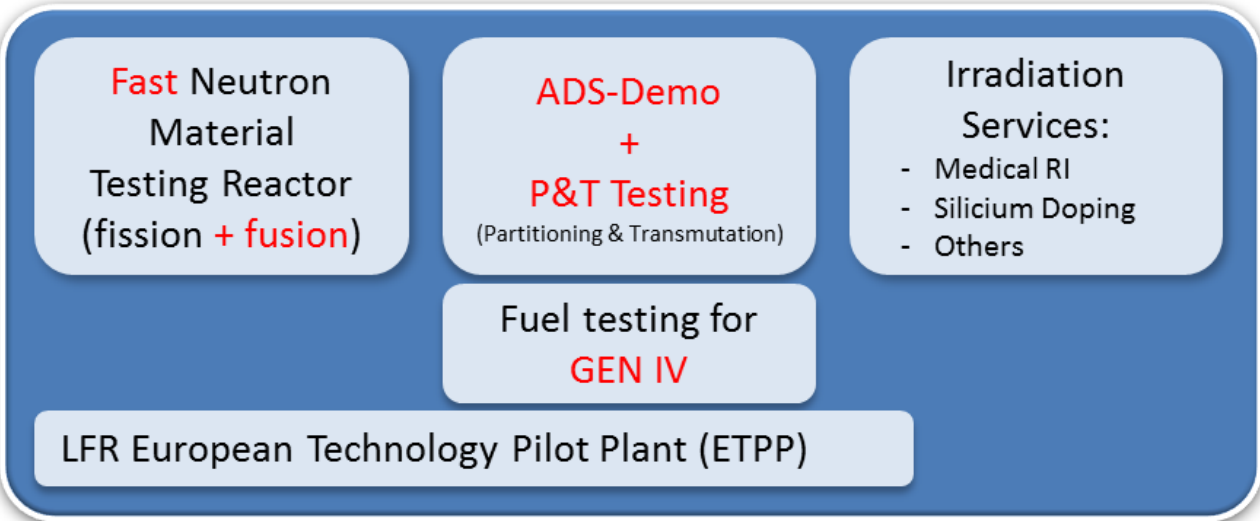

MYRRHA reactor layout (V1.6)

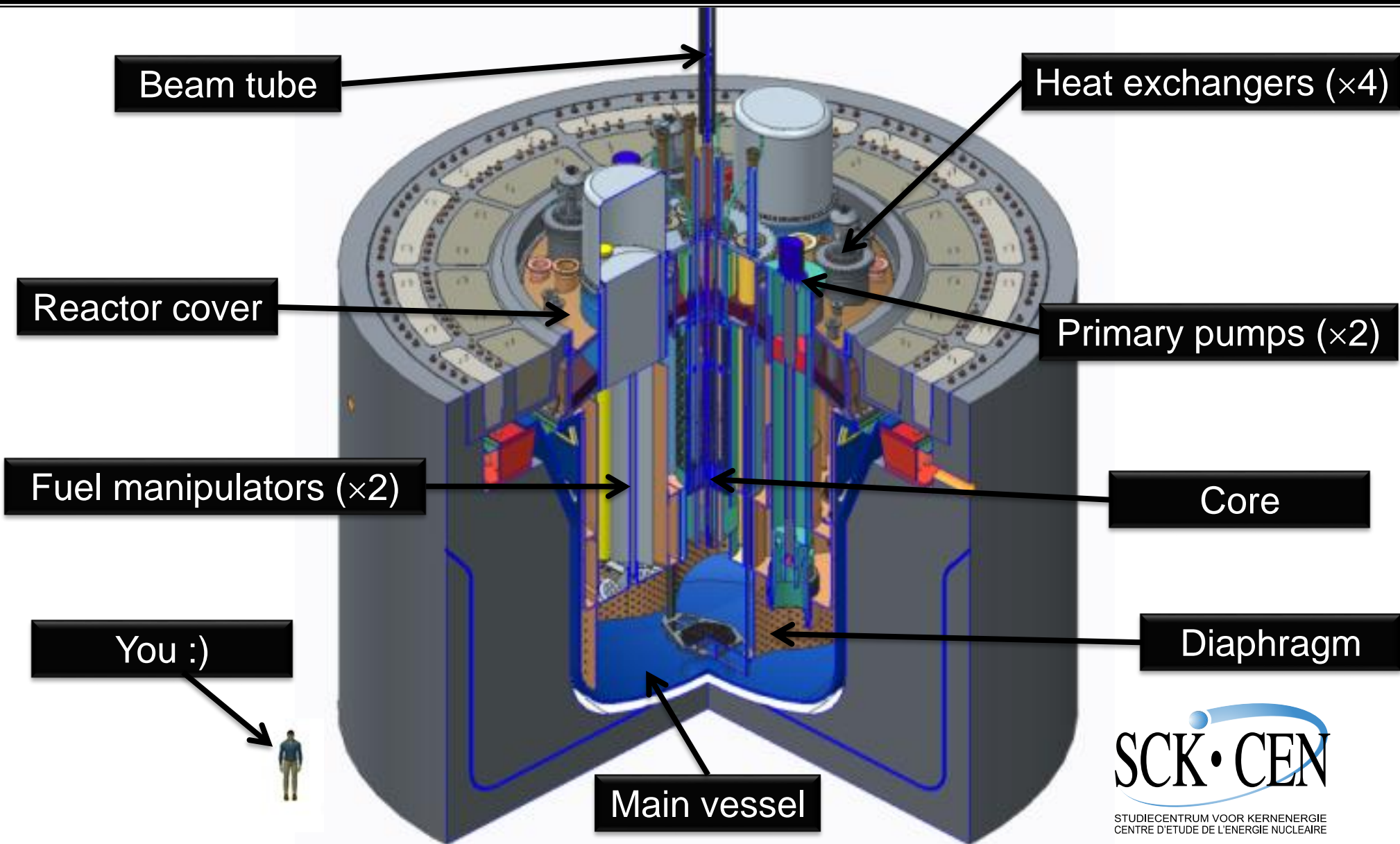

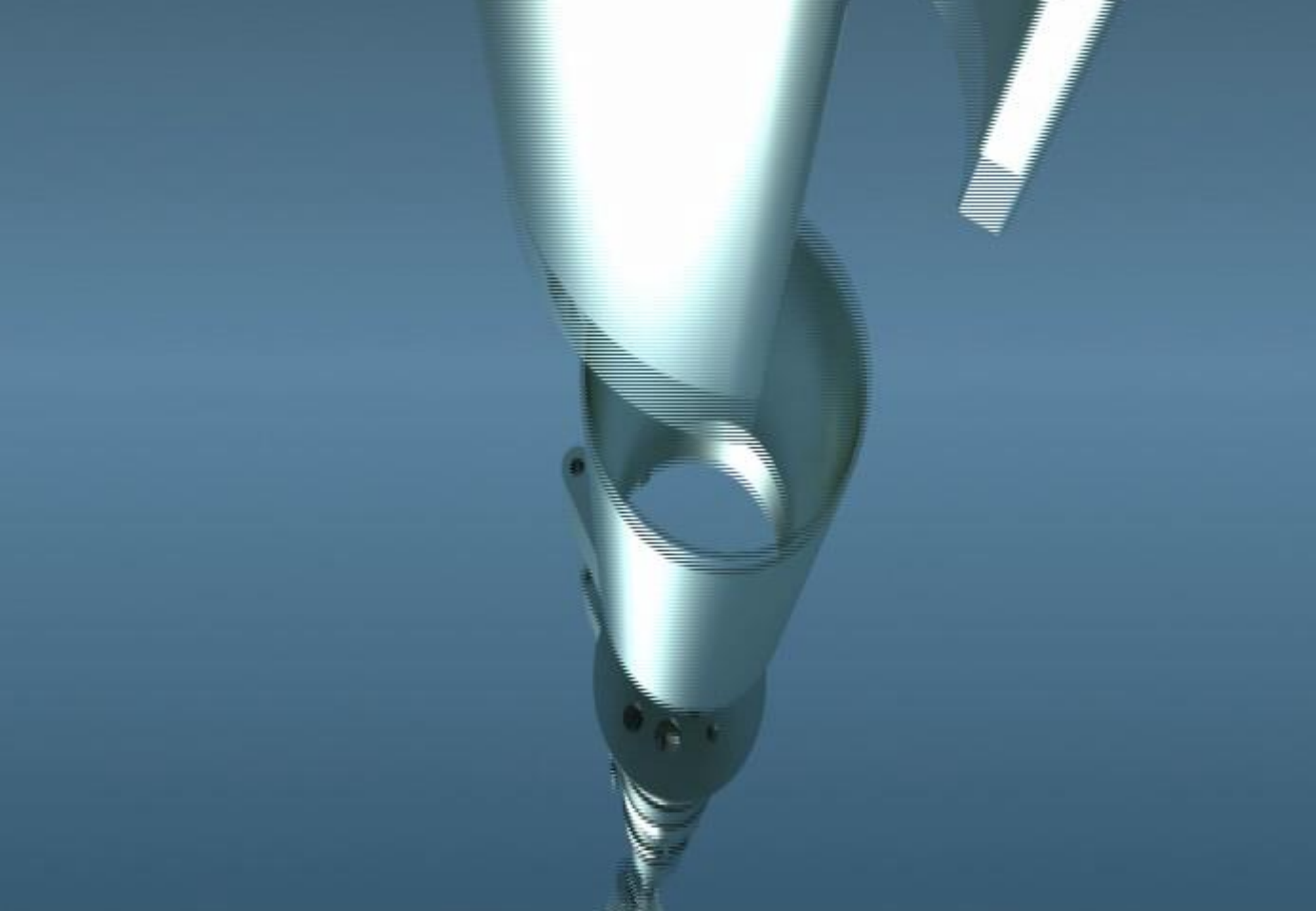

MYRRHA key dates

- **1998:** first studies
- **2002:** pre-design “**Myrrha Draft 1**” (*cyclotron 350 MeV*)
- **2002-2004:** studied as one of the 3 reactor designs within the **PDS-XADS FP5 project** (*cyclotron turns into linac, fault-tolerance concept is introduced*)
- **2005:** updated design “**Myrrha Draft 2**” (*350 MeV linac*)
- **2005-2010:** studied as the XT-ADS demo within the **IP-EUROTRANS FP6 project** (*600 MeV linac conceptual design, R&D activities w/ focus on reliability*)
- **2010:** MYRRHA is on **the ESFRI list**, and is **officially supported by the Belgium government** at a 40% level
- **2010-2015:** engineering design, licensing process, assessments on a possible international consortium, w/ support from the **CDT, FREYA & MAX FP7 projects**
- **Present situation:**
 - Engineering design is going on, w/ support from the **MYRTE H2020 project**
 - **Phased approach strategy** is launched (**w/ 100 MeV linac as a 1st step!**)

MYRRHA in the 2014 BE Government Declaration

De regering zal het behoud van excellentie in het onderzoek naar de nucleaire veiligheid en informatie voor de burger, de omgeving en nucleaire infrastructuur op Belgisch grondgebied nastreven.

Ze zal het MYRRHA-project of evenwaardige projecten van het SCK progressief ondersteunen om het noodzakelijke onderzoek naar innovatieve oplossingen voor hoogradioactief afval, naar de kwalificatie van fusiereactormaterialen, naar het behoud van de medische radio-isotopenproductie in ons land en naar fundamenteel kernfysisch onderzoek optimaal verder te zetten in een internationale context, in samenwerking met universiteiten, onderzoekscentra en zusterorganisaties van het SCK.

Le gouvernement visera le maintien de l'excellence dans la recherche dans les domaines de la sûreté nucléaire et de l'information du citoyen, de l'environnement et des infrastructures nucléaires sur le territoire belge.

Il soutiendra progressivement le projet MYRRHA ou des projets équivalents du CEN en vue de poursuivre de manière optimale, dans un contexte international, les recherches nécessaires concernant des solutions innovantes pour les déchets hautement radioactifs, la qualification des matériaux des réacteurs à fusion, le maintien de la production de radio-isotopes médicaux dans notre pays et de recherche nucléaire fondamentale, en collaboration avec les universités, les centres de recherche et les organisations sœurs du CEN.

The Belgian Government will support in a progressive way the MYRRHA project or any equivalent project at SCK•CEN aiming to continue the needed research for innovative solutions for High level waste, qualification of materials for fusion, the production of radioisotopes for medical applications in our country and fundamental nuclear research in collaboration with the universities and sister organisation of SCK•CEN

Very indicative roadmap

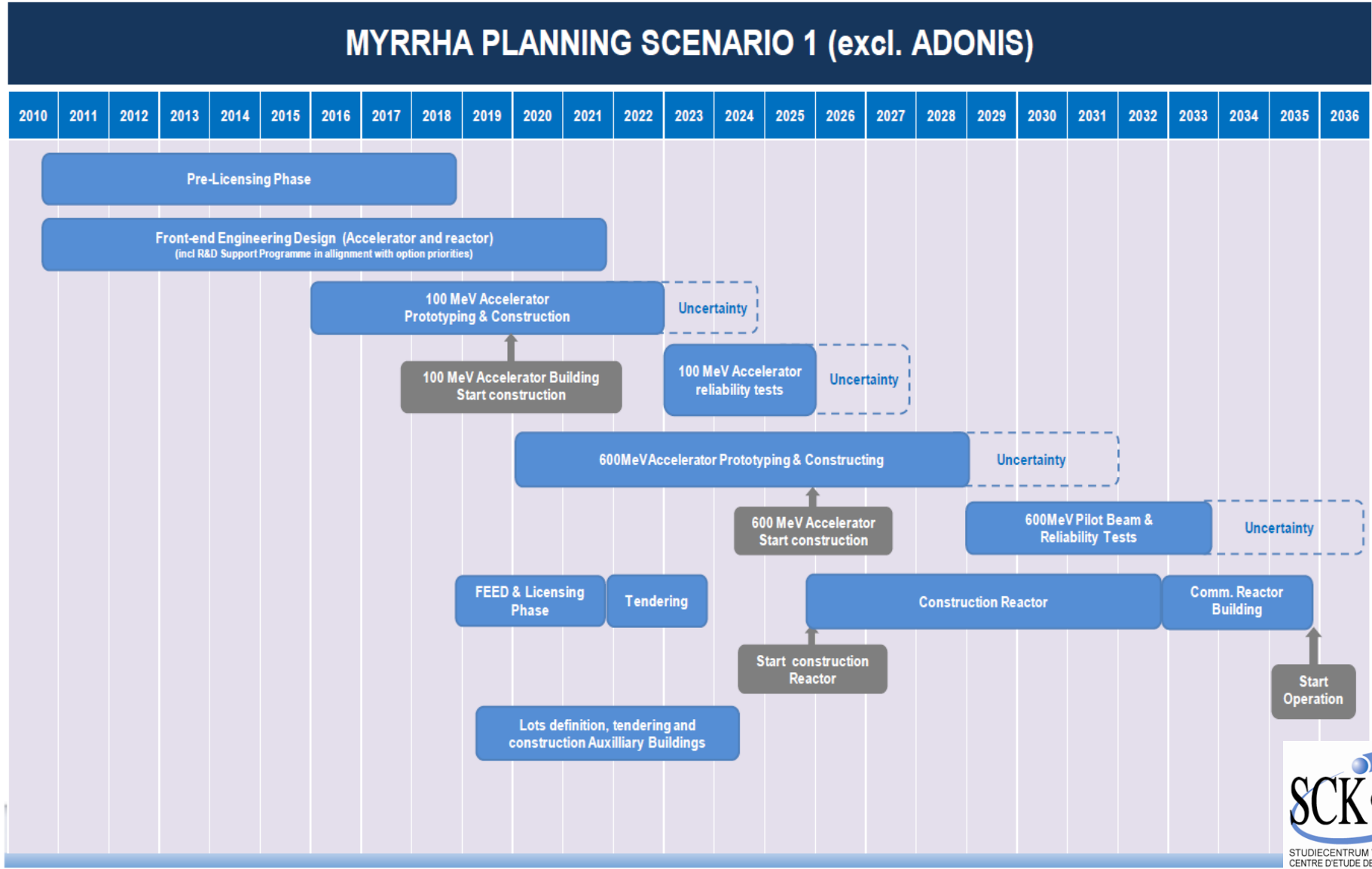



4. The reference ADS linac concept

ADS proton beam requirements

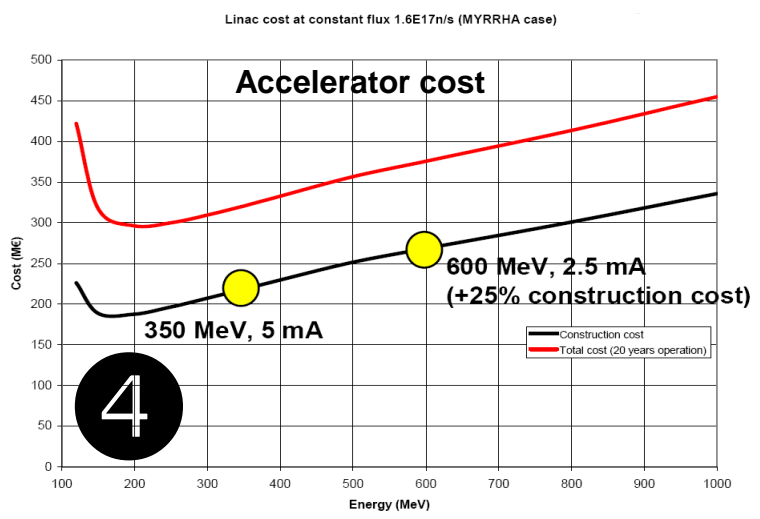
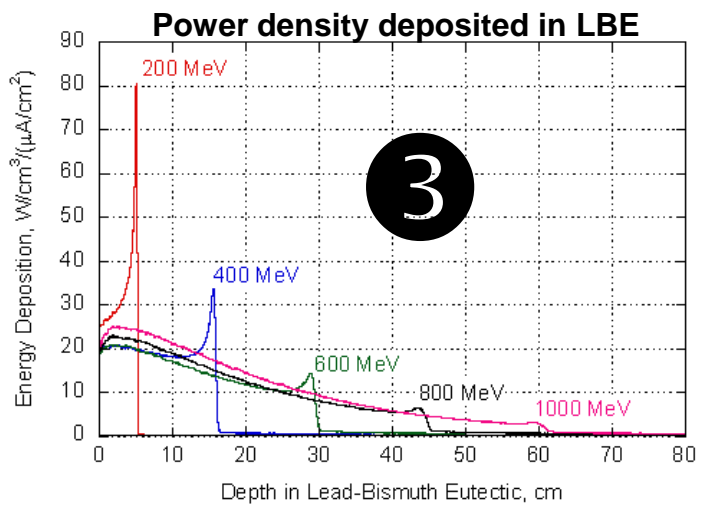
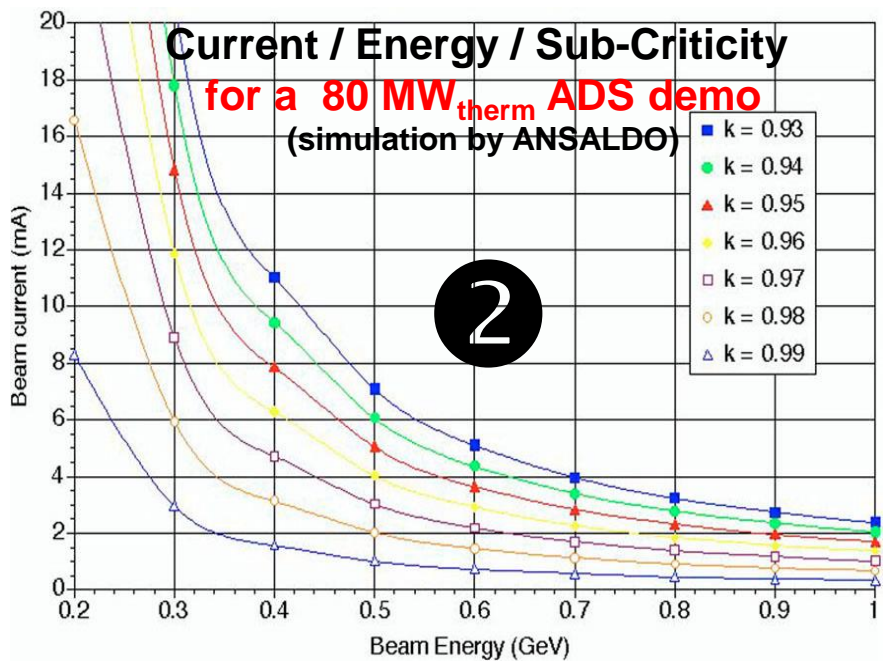
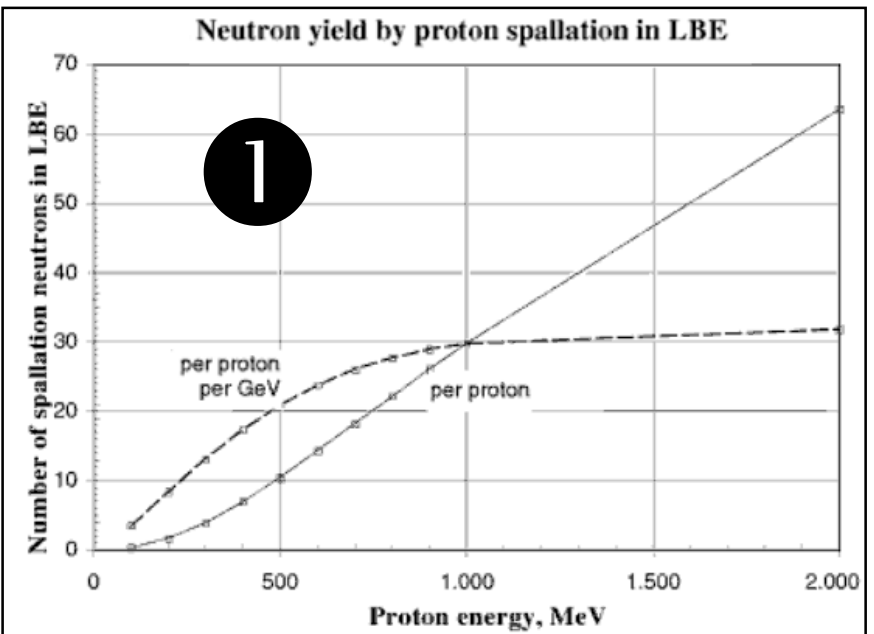

MYRRHA proton beam requirements

→ High power proton beam (up to 2.4 MW)

Proton energy	600 MeV
Peak beam current	0.1 to 4.0 mA
Repetition rate	1 to 250 Hz
Beam duty cycle	10^{-4} to 1
Beam power stability	$< \pm 2\%$ on a time scale of 100ms
Beam footprint on reactor window	Circular $\varnothing 85\text{mm}$
Beam footprint stability	$< \pm 10\%$ on a time scale of 1s
# of allowed beam trips on reactor longer than 3 sec	10 maximum per 3-month operation period
# of allowed beam trips on reactor longer than 0.1 sec	100 maximum per day
# of allowed beam trips on reactor shorter than 0.1 sec	unlimited

Panorama of high-power hadron accelerators

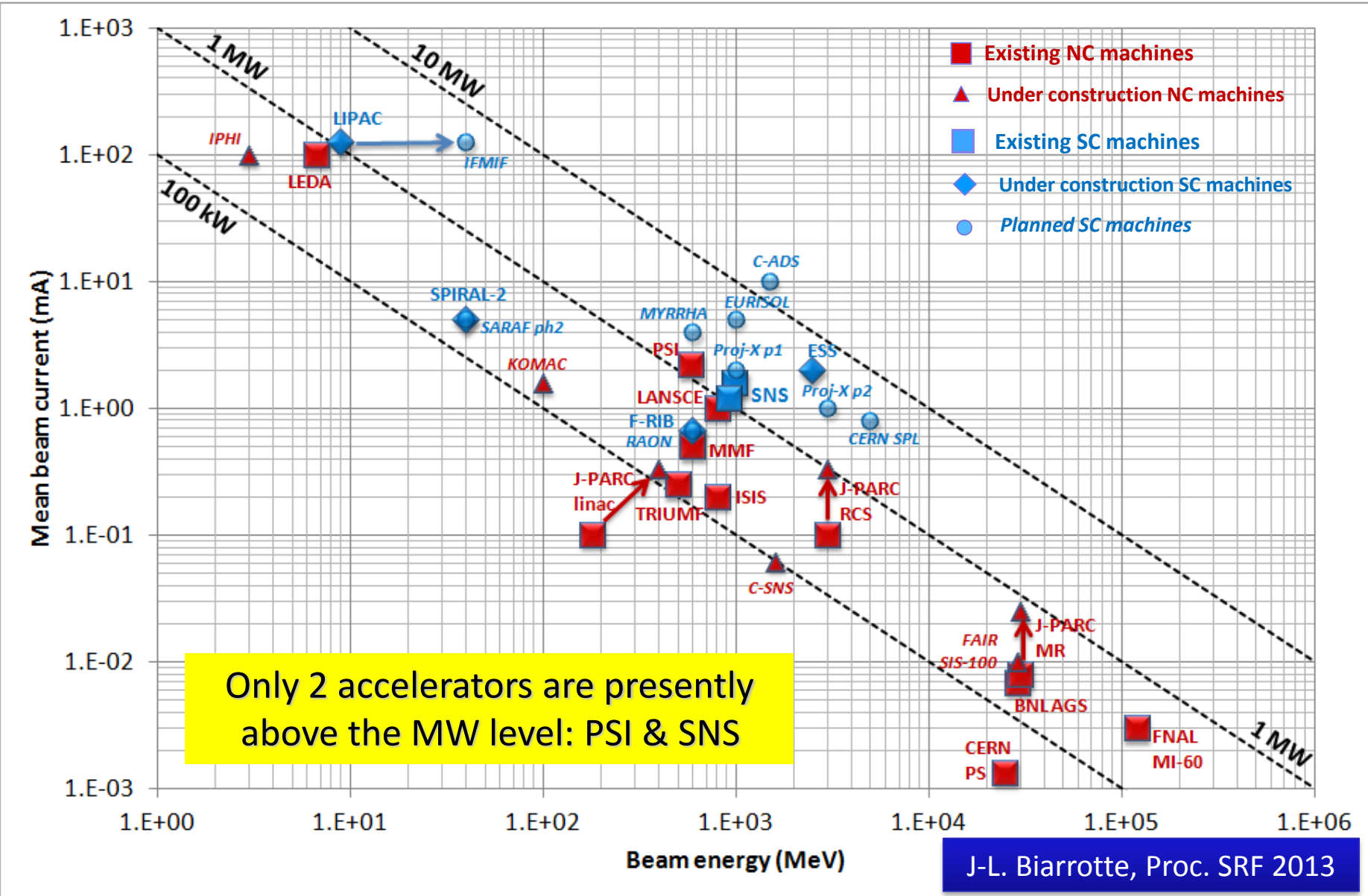

MYRRHA proton beam requirements

→ High power proton beam (up to 2.4 MW)

Proton energy	600 MeV
Peak beam current	0.1 to 4.0 mA
Repetition rate	1 to 250 Hz
Beam duty cycle	10^{-4} to 1
Beam power stability	$< \pm 2\%$ on a time scale of 100ms
Beam footprint on reactor window	Circular $\varnothing 85\text{mm}$
Beam footprint stability	$< \pm 10\%$ on a time scale of 1s
# of allowed beam trips on reactor longer than 3 sec	10 maximum per 3-month operation period
# of allowed beam trips on reactor longer than 0.1 sec	100 maximum per day
# of allowed beam trips on reactor shorter than 0.1 sec	unlimited

→ Extreme reliability level

The ADS reliability requirement

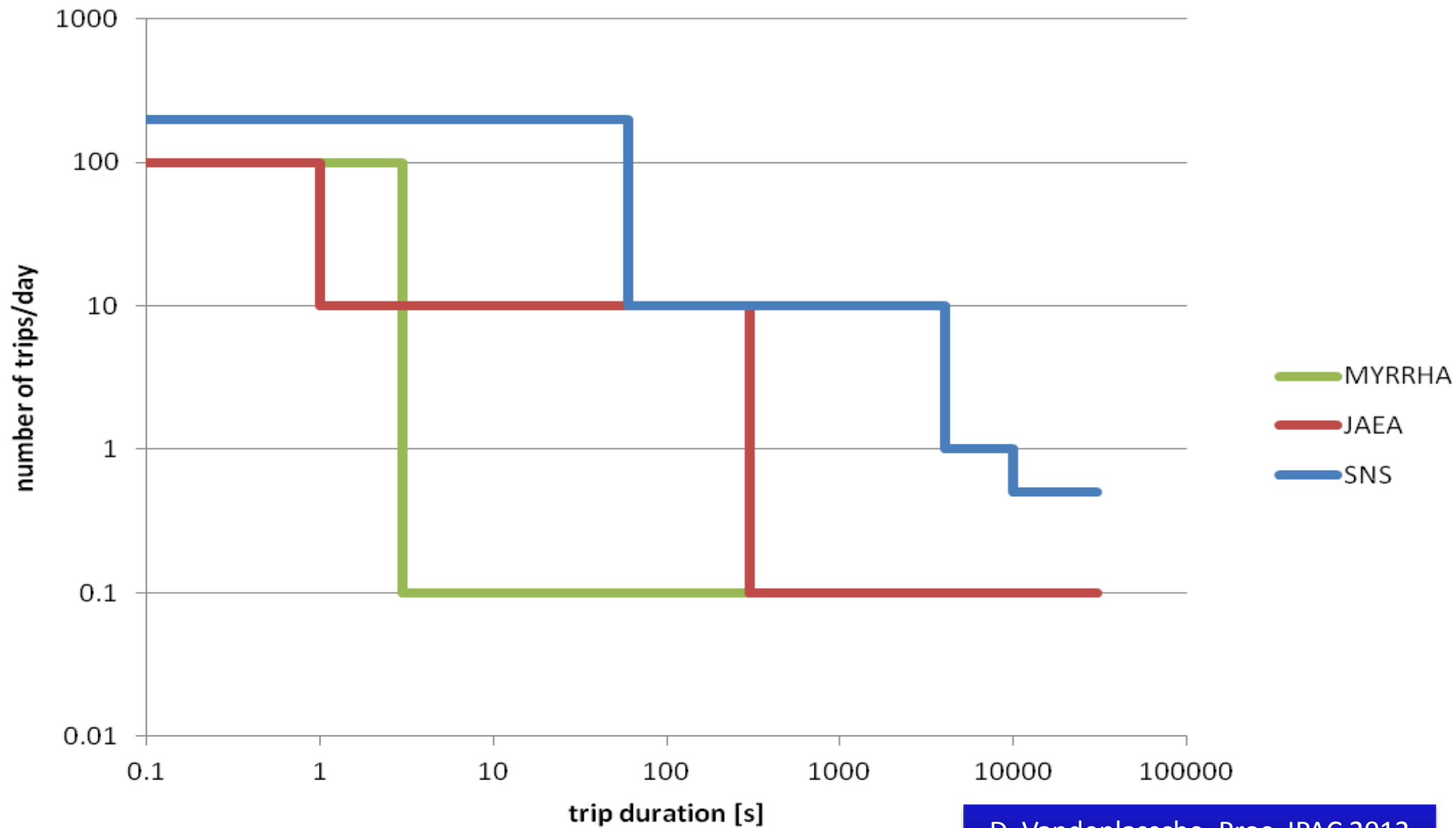

D. Vandeplassche, Proc. IPAC 2012

The ADS reliability requirement

- ✱ **Beam trips longer than 3 sec** must be very rare:
 - To limit thermal stress & fatigue on the target window, reactor structures & fuel assemblies
 - To ensure a 80% availability – given the foreseen reactor start-up procedures
- ✱ **Present MYRRHA specifications:** <10 beam trips per 3-month operation period (i.e. MTBF > 250h) – derived from the PHENIX reactor operation analysis
 - Far above present HPPA accelerator performance – MTBF is a few hours at PSI or SNS
 - Far above present ADS specifications in US or Japan – based on simulations
- ✱ **In any case, reliability guidelines are needed for the ADS accelerator design:**
 - **Strong design** i.e. robust optics, simplicity, low thermal stress, operation margins...
 - **Redundancy** (serial where possible, or parallel) to be able to tolerate failures
 - **Repairability** (on-line where possible) and efficient maintenance schemes

Strategy for a fault in the injector = parallel redundancy

1 Initial configuration

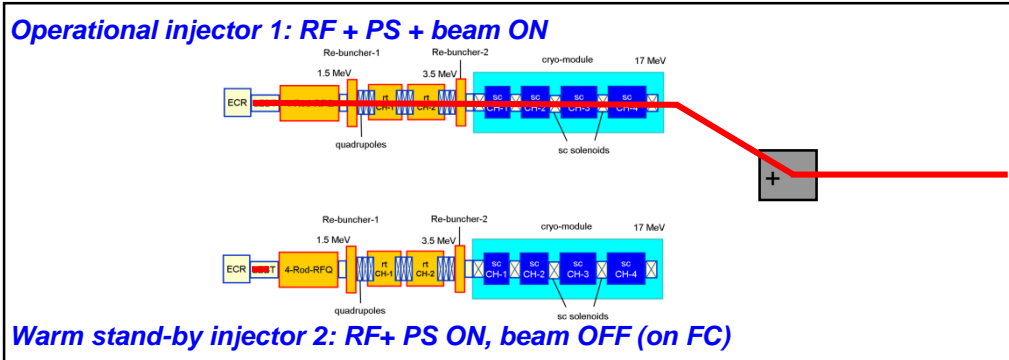

3 The failure is localized in injector

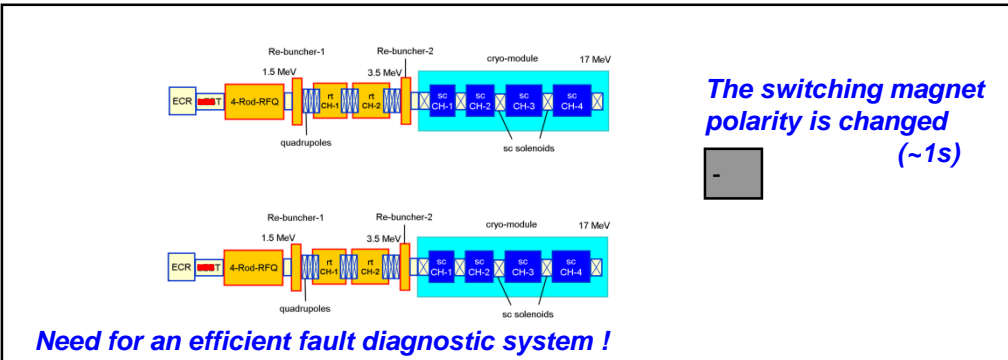

2 A failure is detected anywhere

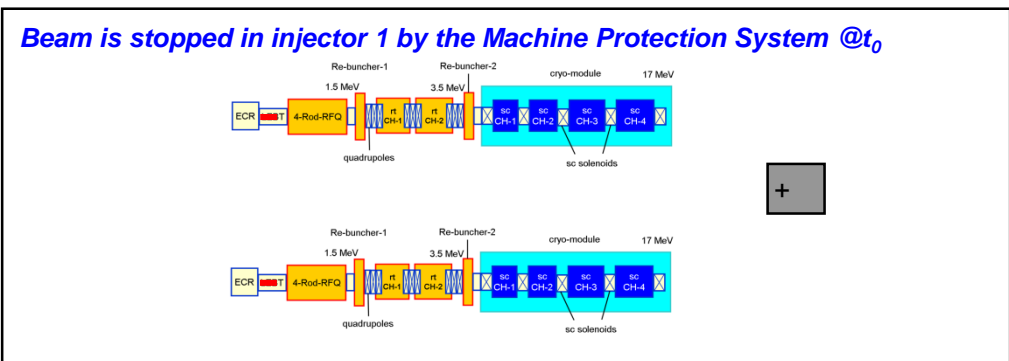

4 Beam is resumed

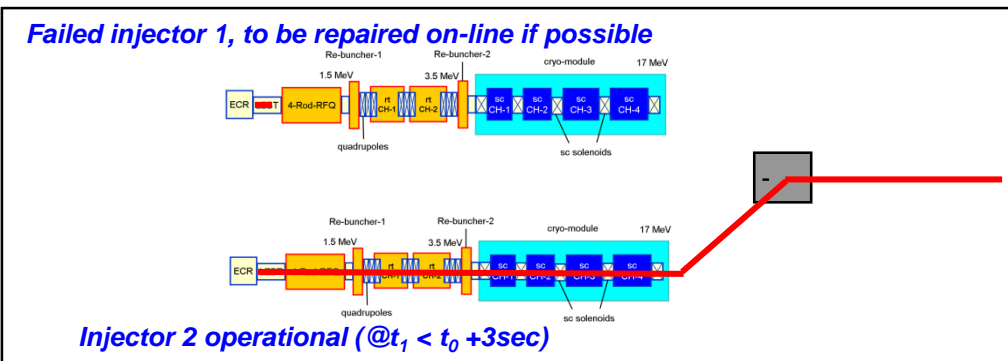

Strategy for a fault in the main linac = serial redundancy

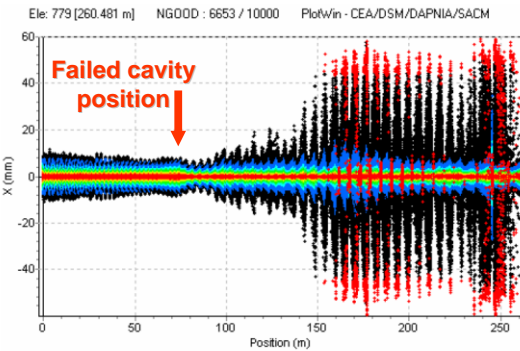
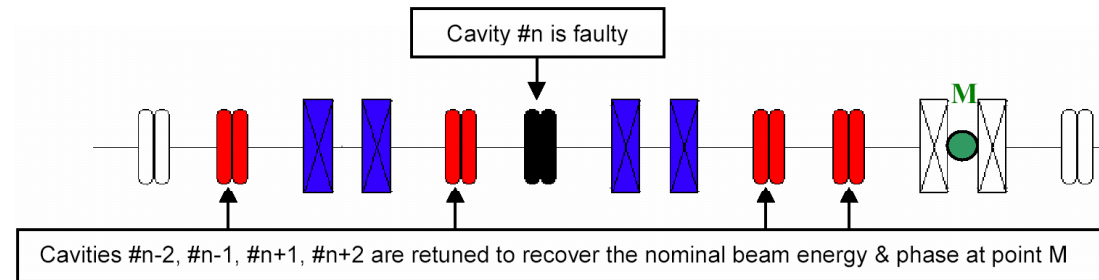

Figure 12 : Transverse beam distribution at 220 μ s, in red are plotted the losses

- 1 A failure is detected anywhere
→ Beam is stopped by the MPS in injector at t_0
- 2 The fault is localized in a SC cavity RF loop
→ Need for an efficient fault diagnostic system

- 3 New V/ϕ set-points are updated in cavities adjacent to the failed one
→ Set-points determined via virtual accelerator application and/or at the commissioning phase



- 4 The failed cavity is detuned (to avoid the beam loading effect)
→ Using the Cold Tuning System

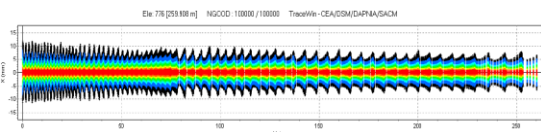

- 5 Once steady state is reached, beam is resumed at $t_1 < t_0 + 3\text{sec}$
→ Failed RF cavity system to be repaired on-line if possible

Layout of the MYRRHA linac

INJECTOR BUILDING

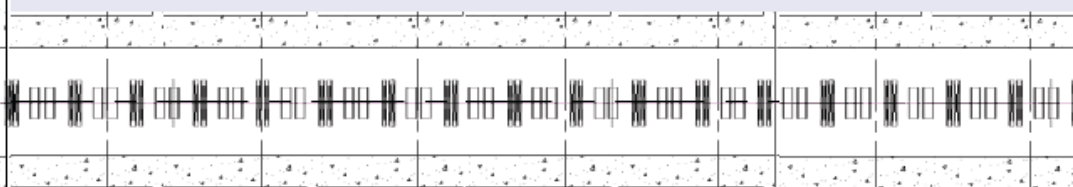
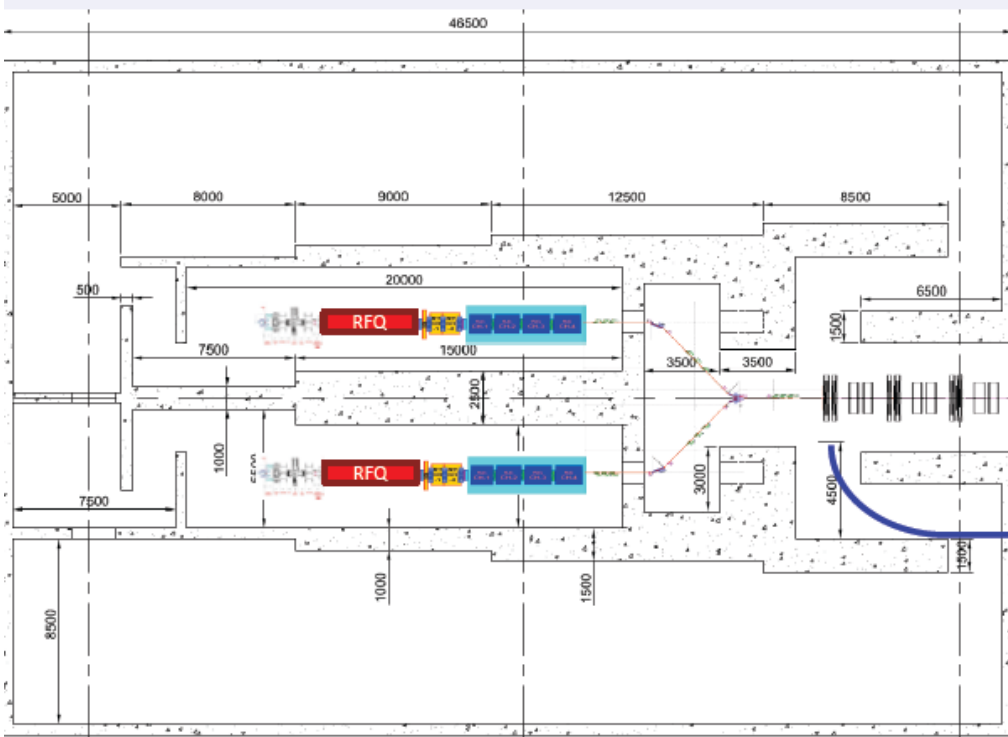

Section #1 (Spoke $\beta \sim 0.35$ @ 352MHz)

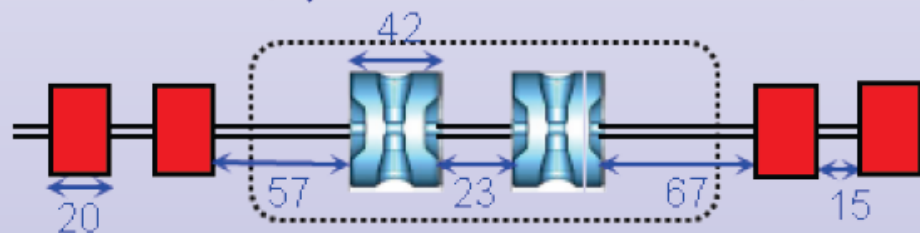

Layout of the MYRRHA linac

INJECTOR BUILDING

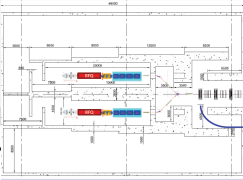

SUPERCONDUCTING LINAC TUNNEL

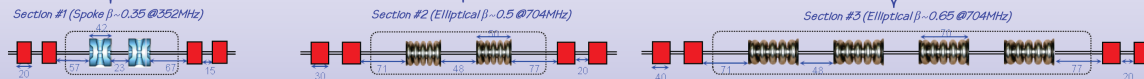

Upper view Side view

REACTOR BUILDING

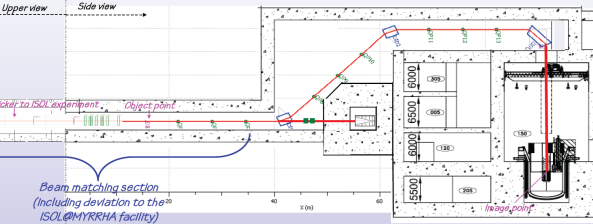

Injector beam reconfiguration (1/4)

➤ Injector 1 in nominal operation mode : beam sent to main linac

- ✓ All elements operating (source, RF, power supplies...) at nominal parameters
- ✓ Chopper: nominal mode (i.e. pseudo CW with short holes)
- ✓ Switching magnet: power supply polarized PLUS

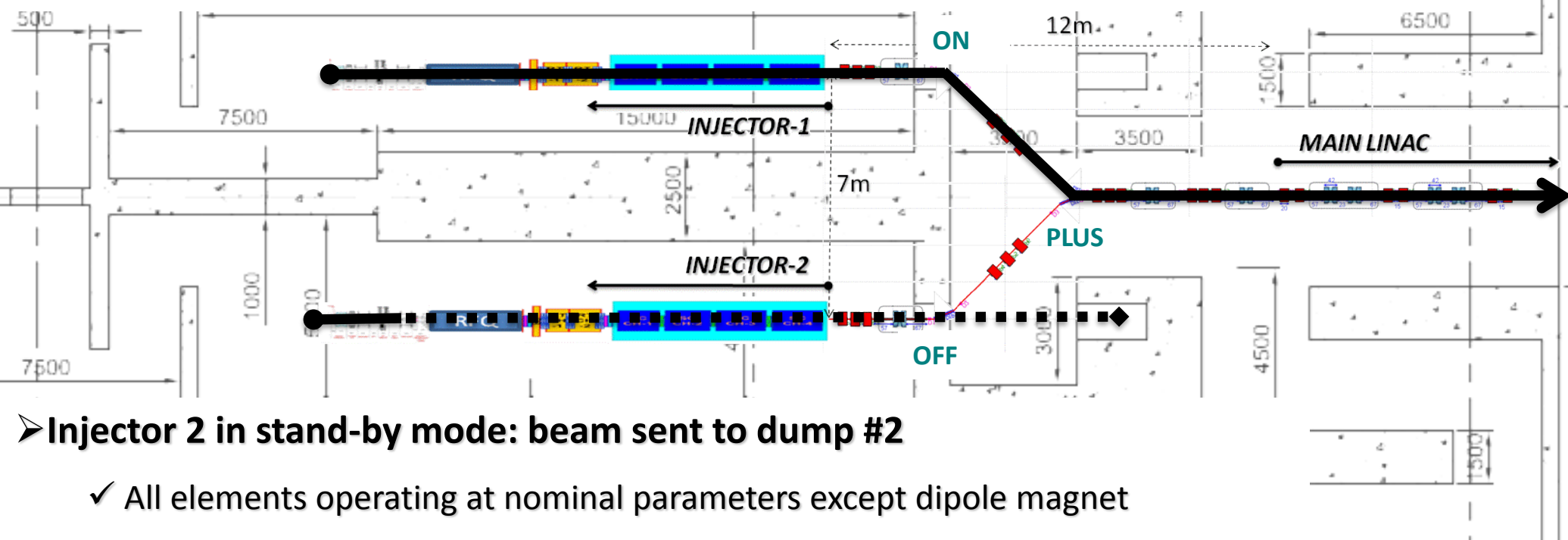

➤ Injector 2 in stand-by mode: beam sent to dump #2

- ✓ All elements operating at nominal parameters except dipole magnet
- ✓ Chopper: tuning mode (i.e. low duty cycle tbd)
- ✓ Survey of output beam properties (TOF energy, current monitor)

Injector beam reconfiguration (2/4)

➤ A failure is detected in Injector #1

- ✓ E.g. anormal beam losses in MEBT (or source voltage breakdown, PS failure, cavity quench...)
- ✓ Fault information is sent to Machine Protection System (MPS) / Control System
- ✓ If failure is serious (i.e. reproducible after 1 or 2 tries), MPS stops the beams

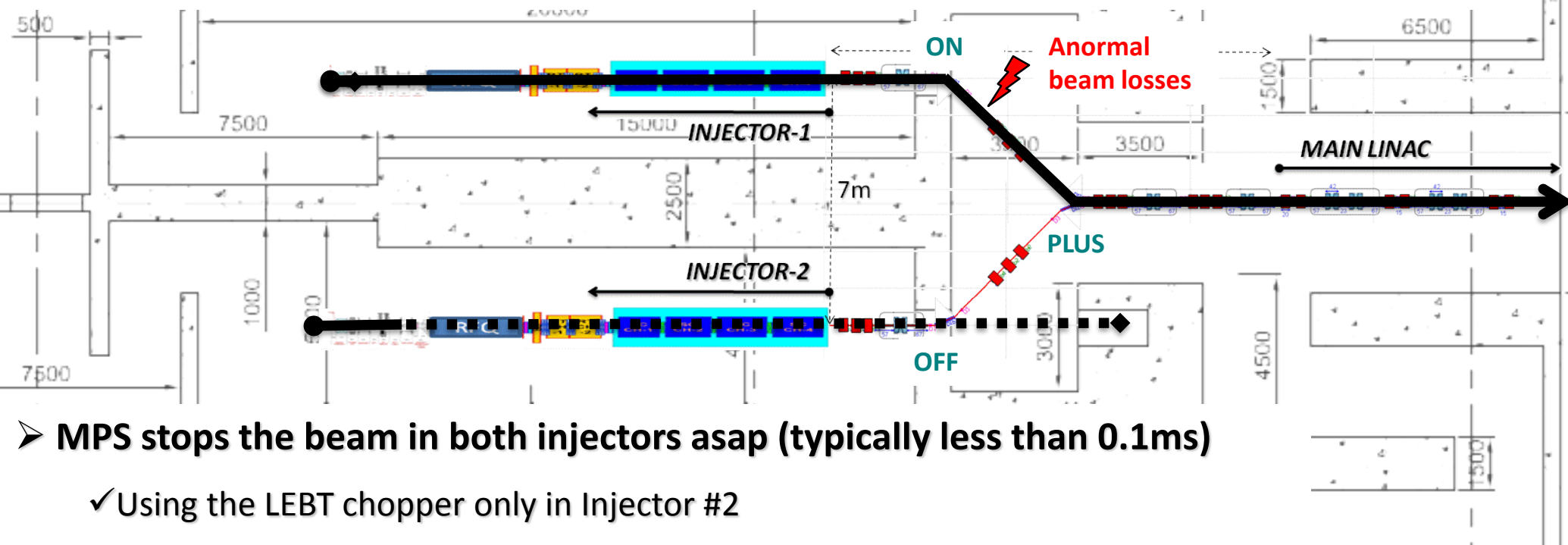

➤ MPS stops the beam in both injectors asap (typically less than 0.1ms)

- ✓ Using the LEBT chopper only in Injector #2
- ✓ Definitively in injector #1 using (TBD) the LEBT chopper as a fast mean and then the LEBT Faraday cup for example as a slow & permanent mean

Injector beam reconfiguration (3/4)

➤ The polarity of dipole magnets is changed (time budget = less than 1sec tbc)

- ✓ Dipole of injector #1 is switched OFF
- ✓ Dipole of injector #2 is switched ON
- ✓ Common dipole polarity is changed to MINUS

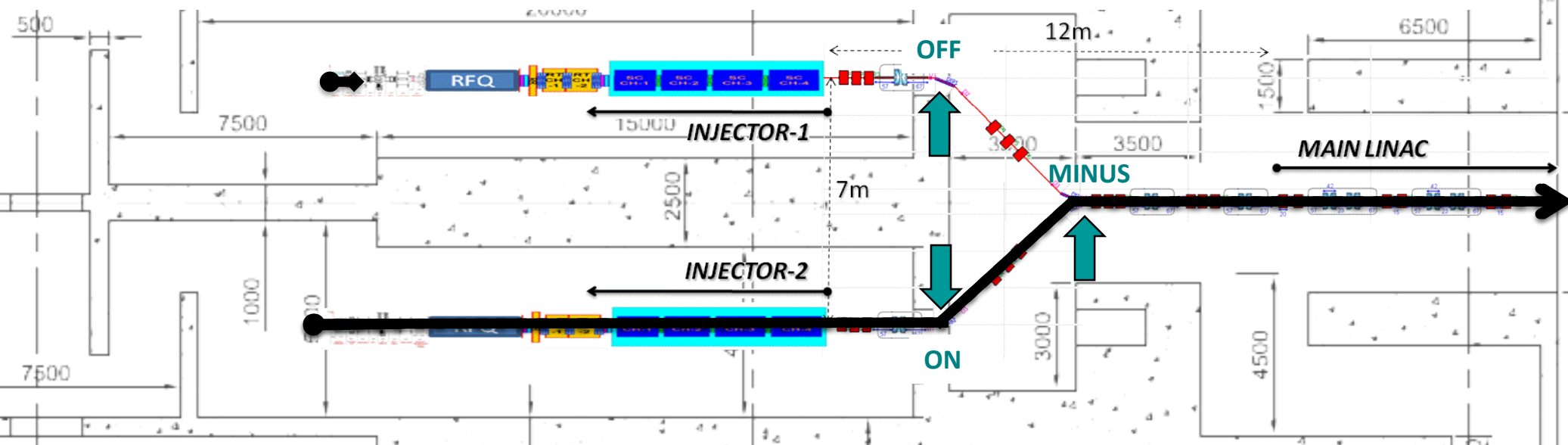

➤ Once steady-state is reached in the PS, beam is resumed in Injector #2

- ✓ First, a few very short pulses are sent to check everything is ok (« fast commissioning mode »)
- ✓ If all is ok, then duty cycle is ramped quickly (within 1 or 2 sec) to recover nominal operation

Injector beam reconfiguration (4/4)

➤ Maintenance is started on Injector #1

- ✓ Injector #1 casemate needs to be accessible during Injector #2 operation
- ✓ Beam might probably need to be completely stopped on Injector #1

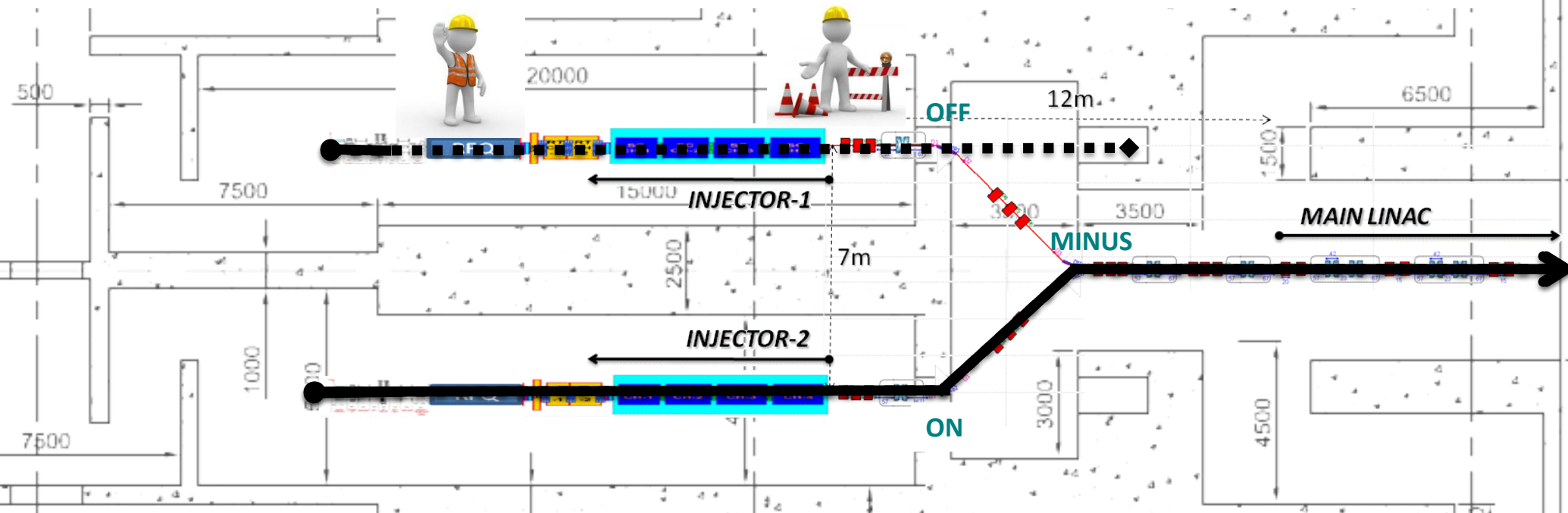

➤ Once failed component is fixed, Injector #1 is put back to operation

- ✓ Injector #1 is re-tuned & commissioned locally
- ✓ Once ok, injector #1 stays in « stand-by mode », low dc beam sent to beam dump #1

Main linac beam reconfiguration (1/6)

INJECTOR BUILDING

SUPERCONDUCTING LINAC TUNNEL

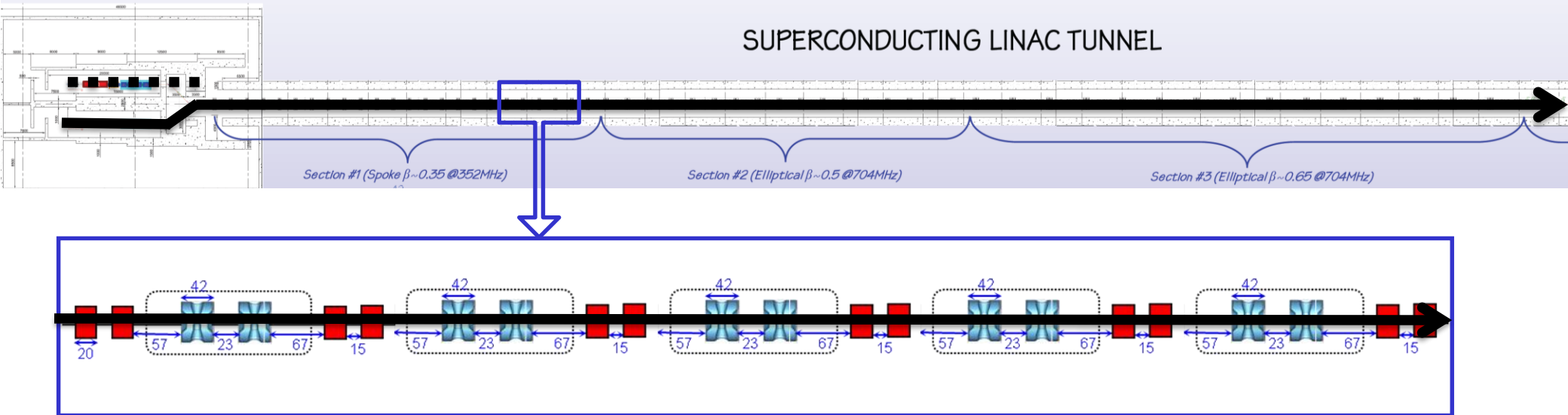

➤ Nominal main linac operation

- ✓ All elements (cavities, RF amps, power supplies...) operating at nominal (derated) parameters
- ✓ Reference scheme: local compensation scheme for RF & magnets faults
about 30% margins available on all cavities, 40% on amplifiers & 10% on magnets PS
- ✓ *Alternative scheme for RF faults (under evaluation): global compensation scheme
no margin on cavities & amp but a few hot spare cryomodules at the linac end at full voltage
but with bunching/debunching synchronous phase*

Main linac beam reconfiguration (2/6)

INJECTOR BUILDING

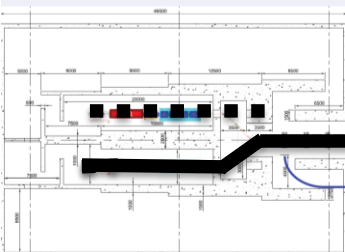

SUPERCELL
Anormal beam losses
AC TUNNEL

Section #1 (Spoke $\beta \sim 0.35$ @ 352MHz)

Section #2 (Elliptical $\beta \sim 0.5$ @ 704MHz)

Section #3 (Elliptical $\beta \sim 0.65$ @ 704MHz)

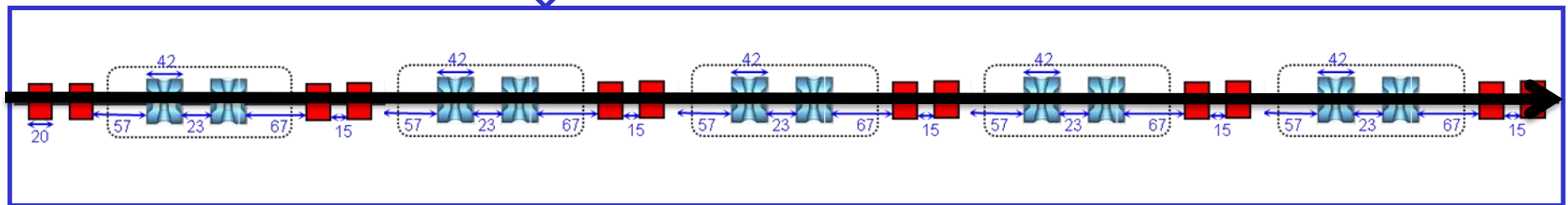

➤ A fault is detected in the main linac

- ✓ E.g. anormal beam losses at high energy (or RF failure, PS failure...)
- ✓ Fault information is sent to Machine Protection System (MPS) / Control System
- ✓ If failure is serious (i.e. reproducible after 1 or 2 tries), MPS stops the beams

➤ MPS stops the beam in the operating injector asap

- ✓ Using the LEBT chopper + possibly an additional redundant mean (tbd)

Main linac beam reconfiguration (3/6)

INJECTOR BUILDING

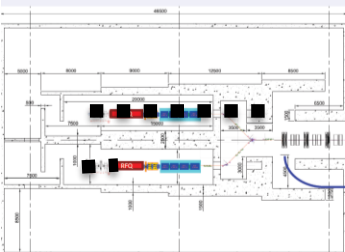

SUPERCONDUCTING LINAC TUNNEL

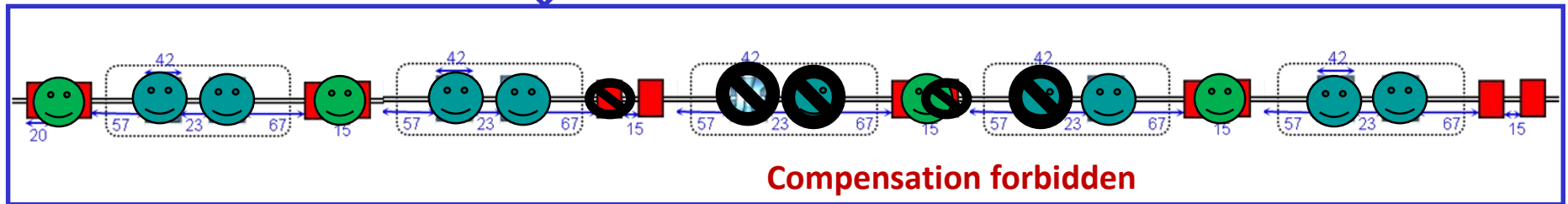
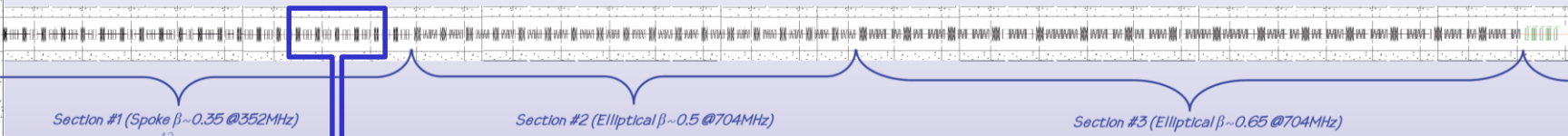

- **The origin of the fault is analysed & fault recovery procedure is launched if possible**
 - ✓ If the origin of the fault is not diagnosed, the beam needs to be stopped permanently
 - ✓ If it is diagnosed AND can be compensated, fault recovery procedure can be started
 - ✓ Conditions to fulfil to make compensation possible (proposed basic preliminary rules):
 - fault implying a cavity: the 4 nearest neighbouring cavities operating derated (i.e. not already used for compensation) are used; max allowed # of consecutive failed cavities = 2 (sections #1&2) or 4 (section #3)
 - fault implying a Qpole: the whole doublet is switched off & the 4 neighbouring doublets are used; max allowed # of consecutive failed doublets = 1

Main linac beam reconfiguration (4/6)

INJECTOR BUILDING

SUPERCONDUCTING LINAC TUNNEL

Section #1 (Spoke $\beta \sim 0.35$ @ 352MHz)

Section #2 (Elliptical $\beta \sim 0.5$ @ 704MHz)

Section #3 (Elliptical $\beta \sim 0.65$ @ 704MHz)

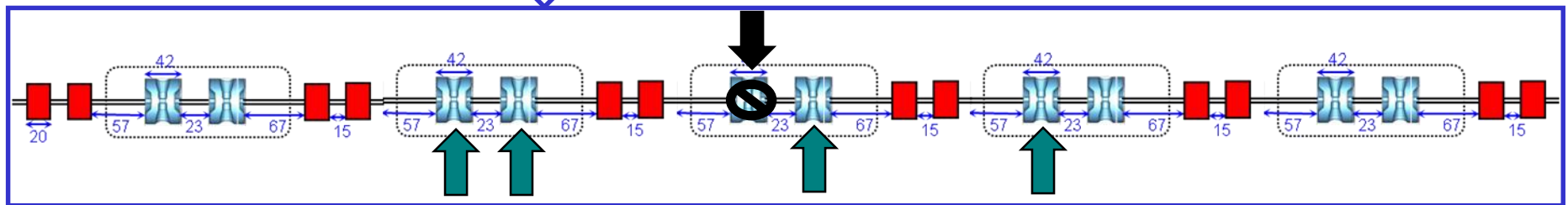

➤ Fast retuning procedure (e.g. case of a RF cavity failure)

- ✓ The failed cavity RF loop is disabled
- ✓ The failed cavity is detuned of more than 100 bandwidth (time budget = less than 2 seconds)
- ✓ New (Voltage / Phase) setpoint values for compensating cavities are picked in the Control System database (from past beam experience or from a predictive calculation)
- ✓ New setpoints are applied in the corresponding LLRF (w/ typically a ramp of about 150ms)
 - The capability of SC cavities to raise reliably its operating voltage has to be checked at each maintenance period !

Main linac beam reconfiguration (5/6)

INJECTOR BUILDING



SUPERCONDUCTING LINAC TUNNEL

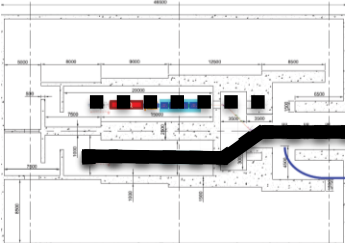

Section #1 (Spoke $\beta \sim 0.35$ @ 352MHz)

Section #2 (Elliptical $\beta \sim 0.5$ @ 704MHz)

Section #3 (Elliptical $\beta \sim 0.65$ @ 704MHz)

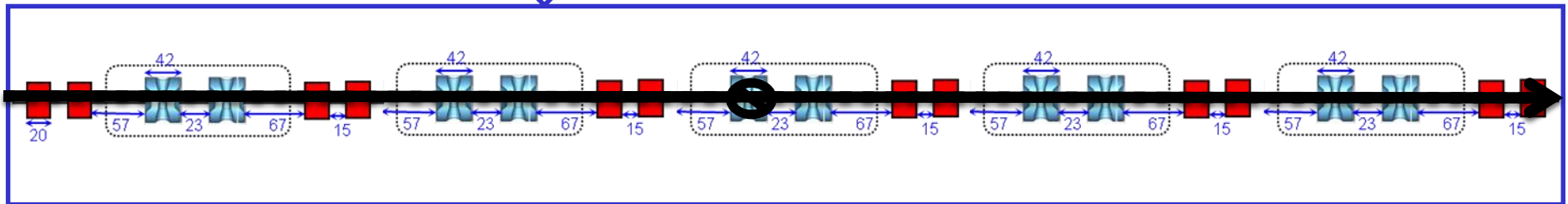

- **Once steady-state is reached on the retuned elements, back to beam operation**
 - ✓ First, a few very short pulses are sent to check everything is ok (« fast commissioning mode »)
 - ✓ If all is ok, then duty cycle is ramped quickly (within 1 or 2 sec) to recover nominal operation
- **Maintenance is done if possible**
 - ✓ If the needed maintenance is inside the tunnel -> wait for next shut-down period
 - ✓ If the needed maintenance is outside the tunnel -> repair during beam operation

Main linac beam reconfiguration (6/6)

INJECTOR BUILDING

SUPERCONDUCTING LINAC TUNNEL

Section #1 (Spoke $\beta \sim 0.35$ @ 352MHz)

Section #2 (Elliptical $\beta \sim 0.5$ @ 704MHz)

Section #3 (Elliptical $\beta \sim 0.65$ @ 704MHz)

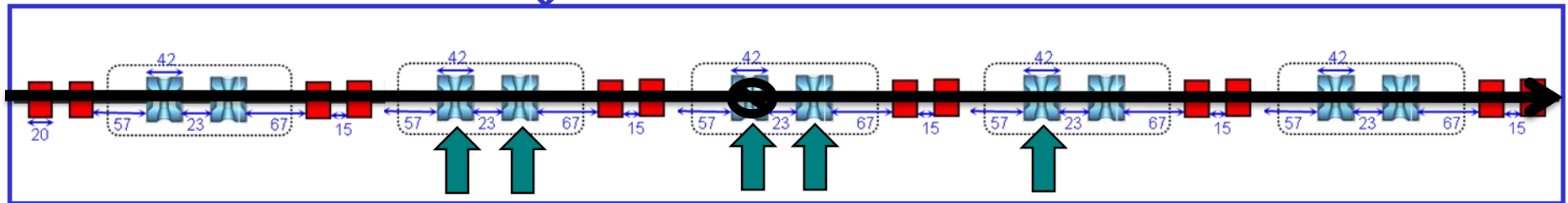

➤ If maintenance is successful, back to nominal operation using opposite procedure (? TBC)

- ✓ Beam is stopped
- ✓ The repaired cavity is retuned (time budget = less than 2 seconds)
- ✓ Initial (Voltage / Phase) setpoint values for repaired & compensating cavities are set back
- ✓ Beam is resumed (short pulse) and duty cycle is ramped up to nominal operation



5. Main R&D achievements

The MAX project (2011-2014)

Goal: deliver a consolidated reference layout of the MYRRHA linac with sufficient detail and adequate level of confidence in order to initiate in 2015 its engineering design and subsequent construction phase

- WP1: Global accelerator design
- WP2: Injector developments
- WP3: Main linac developments
- WP4: System optimisation

11 partners
~ 5 M€ total cost
~ 10 people FTE

<http://ipnweb.in2p3.fr/MAX/>

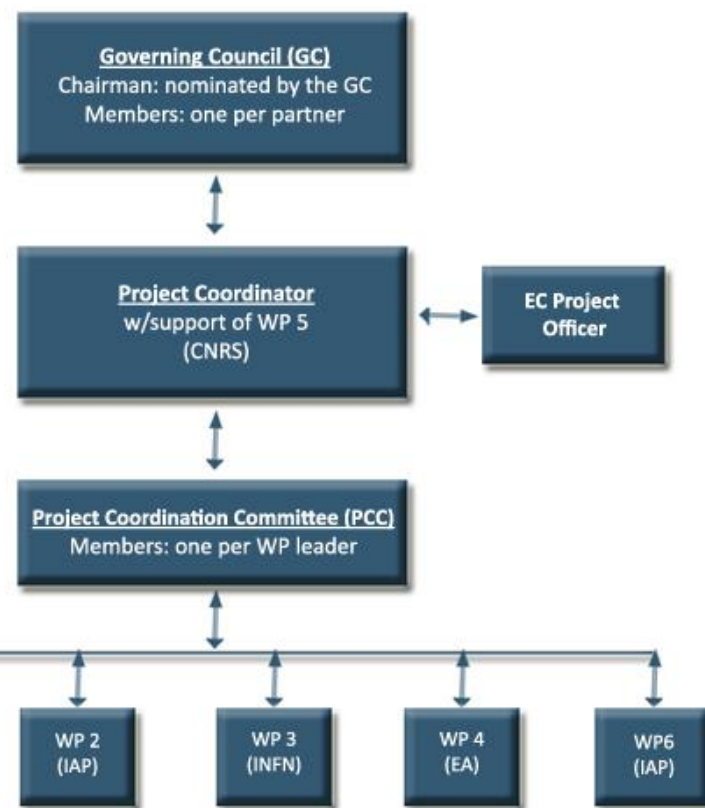

WP1 – Global accelerator design

➤ Production of a reference design for the whole MYRRHA accelerator

- LEBT, together w/ MARISA
(incl. ion source - SCK+LPSC)
- RFQ + CH booster
(several versions studied)
- MEBT
(conceptual design)
- Main SRF linac
(incl. fault-tolerance capabilities)
- HEBT, from CDT inputs
(ISOL deviation + reactor interface)
- Definition of beam time structure & power control strategy

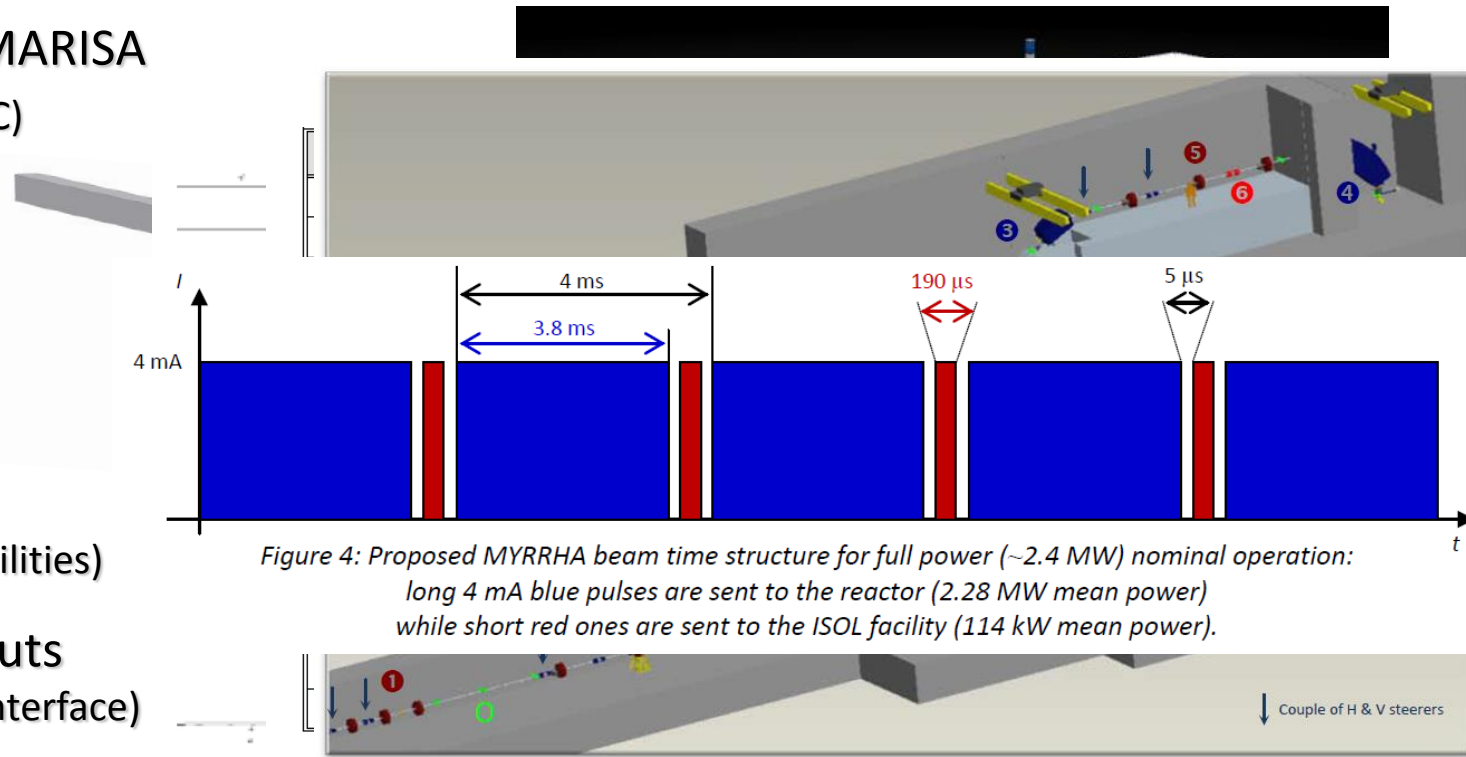

WP1 – Global accelerator design

- MYRRHA linac international design review (Brussels, Nov. 2012)
 - Very encouraging feedback, list of very valuable recommendations

- Consolidation of the reference design

- Beam dynamics benchmarking activities
- Beam simulations from source to target
- Monte Carlo error studies (incl. fault compensation cases)
 - ✓ Longitudinal acceptance is the key point for beam loss control
 - ✓ Compensation schemes should be slightly less aggressive (i.e. involving more cavities)

- Assessments of the MYRRHA buildings layout

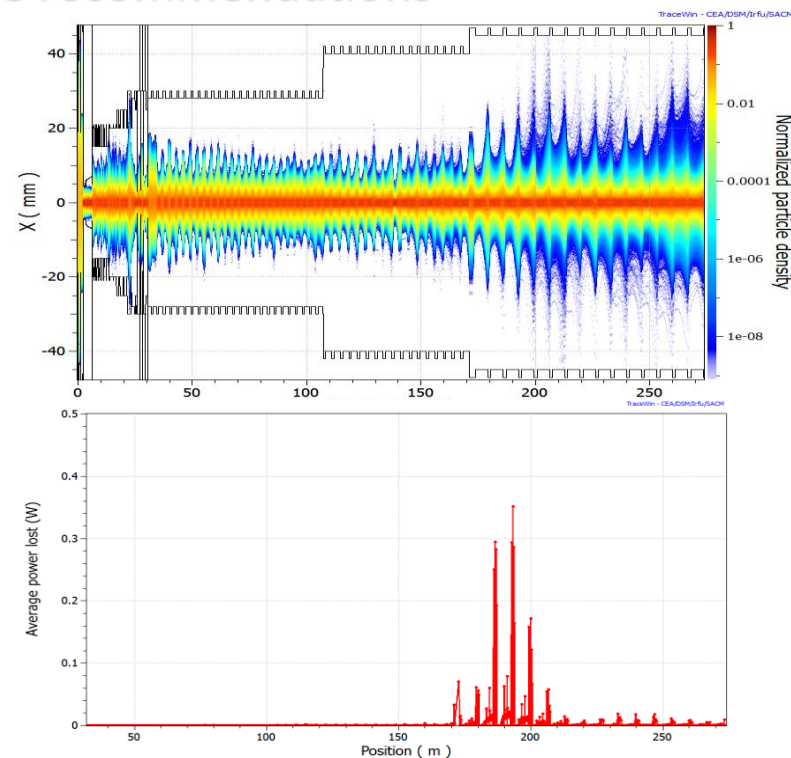

Figure 4: Results from a statistical error study in the case a fault compensation case with several simultaneous faults (1 full cryomodule + 2 single cavities); the reached cumulative statistics is 3.10^9 particles.
(Left) Superposition of all beam horizontal transverse densities.
(Right) Average beam losses in the superconducting part of the linac.

WP2 – Injector developments

➤ R&D on the MYRRHA 176 MHz RFQ

- 4-rod w/ technology choices optimized for reliable CW operation
- Fabrication and successful high-power RF test of a short prototype → **116 kW/m**
- Design of the 4m-long MYRRHA RFQ

➤ R&D on the MYRRHA CH cavities

- NC and SC CH cavity design incl. ancillaries
- Fabrication of a NC 5-gap CH-prototype
- Fabrication and successful tests of a SC 7-gap CH-prototype → **14 MV/m**

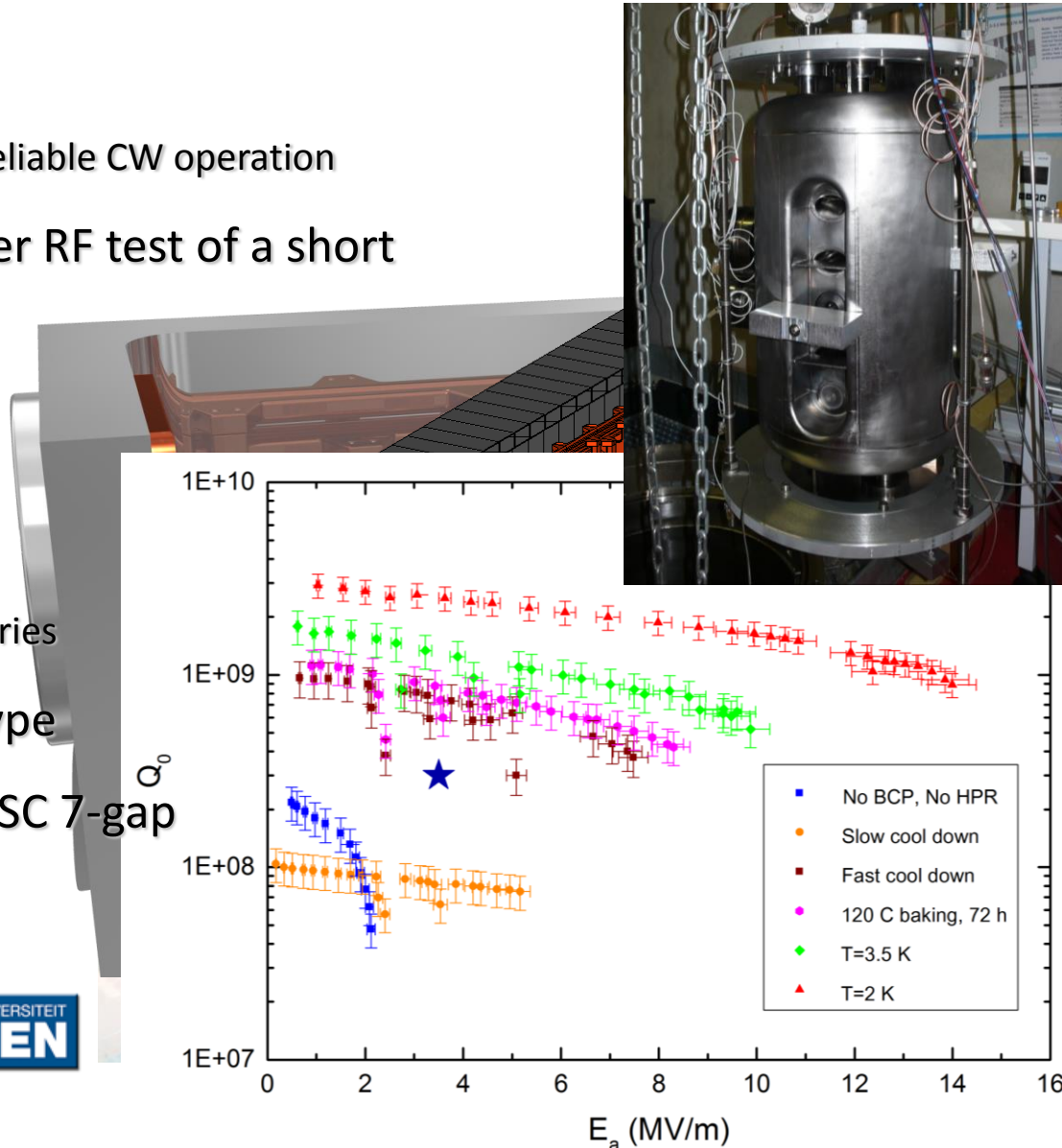

WP3 – Main linac developments

➤ R&D on the MYRRHA 352 MHz Spoke cryomodule

- Design of the MYRRHA spoke 2-gap cavity
 - incl. call for tender for 2 prototypes (presently in fabrication)
- Detailed design of the MYRRHA spoke cryomodule
 - incl. engineering drawings

➤ R&D on 704 MHz elliptical cavities

- High-power commissioning of the test cryomodule
 - w/ $\beta=0.5$ 5-cell cavity, 80kW IOT, @2K
- Development and test of an innovative control system
 - ✓ Main sequences of the fault recovery scenario tested, incl. LLRF + pizo-based CTS + ADEX smart control
 - ✓ Low-beta elliptical cavities are too soft mechanically -> might be replaced by ESS-type spoke cavities
- Assessments on multipacting

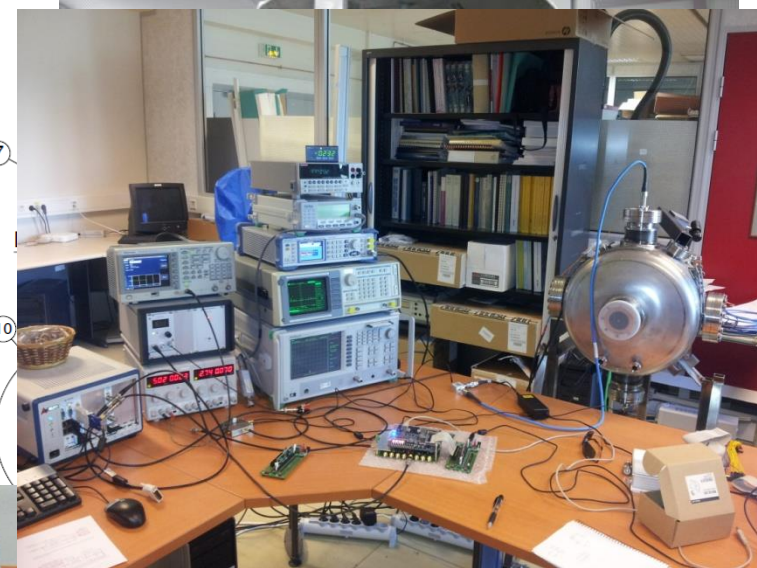

WP4 – System optimisation

➤ Reliability analysis

- Development of a reliability model of the SNS accelerator & benchmark w/ SNS logbook data
- Development of the MYRRHA linac reliability model
 - ✓ Diagnostics and C&C must be designed with increased reliability
 - ✓ We expect 13 compensation events per 3-month cycle -> the 30% margin on RF power could be lowered

➤ R&D on 700 MHz solid-state amplifiers

- Design of a 32kW SSPA for MYRRHA
- Development & test of a 800W elementary module

CAV FAULT DETECTIC
(Diagnostics)

Local Compensation sequence - (basis for COMP Fault Tree)

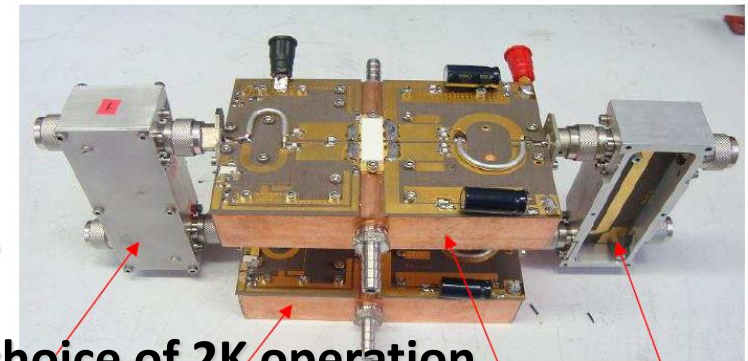

3dB coupler
Input printed

Amplifier N°2

3dB coupler
Output printed

➤ Conceptual design of the MYRRHA cryogenic plant & choice of 2K operation

➤ Main lessons learned from the GUINEVERE ADS operation analysis



MAX final report is available on <http://ipnwww.in2p3.fr/MAX>

The screenshot shows a web browser window with the URL ipnwww.in2p3.fr/MAX/index.php/reportspapers. The page features a header with the European Union flag, the 'MAX' logo, and the text 'MYRRHA ACCELERATOR EXPERIMENT RESEARCH & DEVELOPMENT PROGRAMME'. Below the header is a navigation menu with links for Home, WP1, WP2, WP3, WP4, Reports, Conferences, Seminars/schools, and Contact us.

The main content area is divided into three columns. The left column contains three sections: 'General Information' (with links to 'The MAX Project' and 'Participant Institutes'), 'Scientific Work Programmes' (with links to 'Work Package 1' through 'Other Work Packages'), and 'Structure & Milestones' (with links to 'Structure' and 'Project Milestones'). The middle column is titled 'Public Reports & Papers' and contains a list of reports. The right column is titled 'Member Area' and includes a login form with fields for 'User Name' and 'Password', a 'Remember Me' checkbox, and a 'Log in' button. Below the login form are links for 'Forgot your password?' and 'Forgot your username?'.

The 'Public Reports & Papers' section includes the following list of reports:

- [MAX FP7 project](#)
[Relevant publications & recent conference proceeding](#)
[Newsletters/articles about the MAX project](#)
- Private publications:** Please note that many other publications are available only for members. If you are a member, to get access, please login in the Member Area (on the right).
- MAX FP7 project**
 - MAX Deliverable 1.1: "Analysis of the XT-ADS accelerator design & detailed work programme", April 2011. [Only available for members, private section]
 - MAX Deliverable 1.2: "Design fine-tuning & beam simulation codes benchmarking", August 2013. [Only available for members, private section]
 - MAX Deliverable 1.3: "Preliminary buildings and infrastructures definition", June 2014. [Only available for members, private section]
 - MAX Deliverable 1.4: "Advanced beam dynamics simulations", August 2014. [Only available for members, private section]
 - MAX Deliverable 1.5: "MAX Project Final Report", August 2014. [[Free Download in PDF, without appendix](#)] [complete version, only available for members, private section]
 - MAX Deliverable 2.1: "352 MHz vs. 176 MHz Injector Comparison & Choice", 31st January 2012. [Only available for members, private section]
 - MAX Deliverable 2.2: "RF test of a superconducting CH cavity in a horizontal cryomodule", 30th July 2014. [Only available for members, private section]
 - MAX Deliverable 2.3: "Design of a Room Temperature CH-Cavity for MYRRHA", 30th July 2014.

A black arrow points to the link for the 'MAX Project Final Report' in the list.

The MYRTE project (2015-2019)

MYRTE	
Main Objective	Research in order to demonstrate the feasibility of transmutation of high-level waste at industrial scale through the development of the MYRRHA research facility.
Project type	Research and Innovation Action
Duration	4 years, coordinated by SCK•CEN Start date: April, 1 st 2015 to March, 31 st 2019
Coordinator	SCK•CEN (Peter Baeten)
Consortium	27 partners
Project cost	€ 11,989,922.49 Personnel involvement of 907,50
EU contribution	€ 8,995,962.00

MYRTE overview

Work package No	Work package title	Lead participant No	Lead Participant Short name	Person-months	Start month	End month
1	Project Management	1	SCK•CEN	22	1	48
2	Accelerator R&D for ADS/MYRRHA	6	CNRS	349	1	48
3	Thermal-hydraulics	15	NRG	341,50	1	48
4	Chemistry of volatile radionuclides	16	PSI	74	1	48
5	Experiments in support of the MYRRHA design evolution	1	SCK•CEN	64	1	48
6	Actinide Fuel	13	JRC-ITU	42	1	48
7	Dissimination & Communication	22	VKI	15	1	48
	TOTAL			907,5		

MYRTE WP2 overview

Work package number	2		Start date or starting event				Month 1					
Work package title	Accelerator R&D for ADS/MYRRHA											
Activity Type	RTD											
Participant number	1	2	3	4	6	8	11					
Participant short name	SCK•CEN	ACS	ADEX	CERN	<u>CNRS</u>	EA	IAP					
Person-months per	41	12	17	9	115	18	33					
Participant number	12		18		23		24		26		27	
Participant short name	IBA		U. Darmstadt		COSYLAB		TED		CEA		NTG	
Person-months per	18		6		30		4		41		5	



➤ 13 partners

- 4 research institutes (CNRS, SCK•CEN, CERN, CEA) for a total of 206 pm
- 2 universities (IAP, U. Darmstadt) for a total of 39 pm
- 7 SME & industries (ACS, ADEX, EA, IBA, COSYLAB, TED, NTG) for a total of 104 pm

➤ Overall budget: 5.3 M€

- 349 pm over 4 years (about 8 FTE)
- 1760 k€ for consumables and travels

➤ EC contribution: 4.0 M€

WP2 objectives

- Pursue the research, design and development of the MYRRHA accelerator
- W/ special focus on the first section of the INJECTOR part (building from previous work)

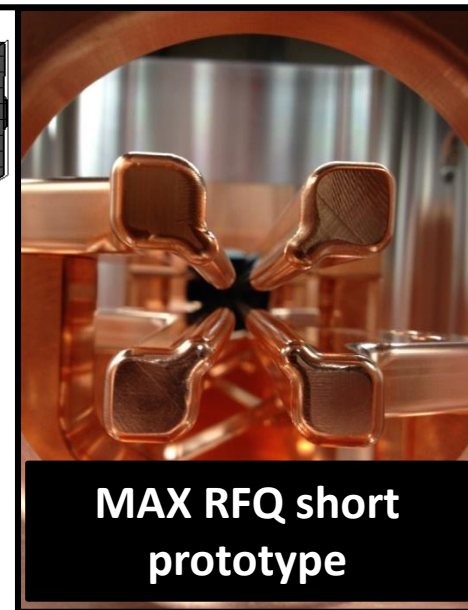
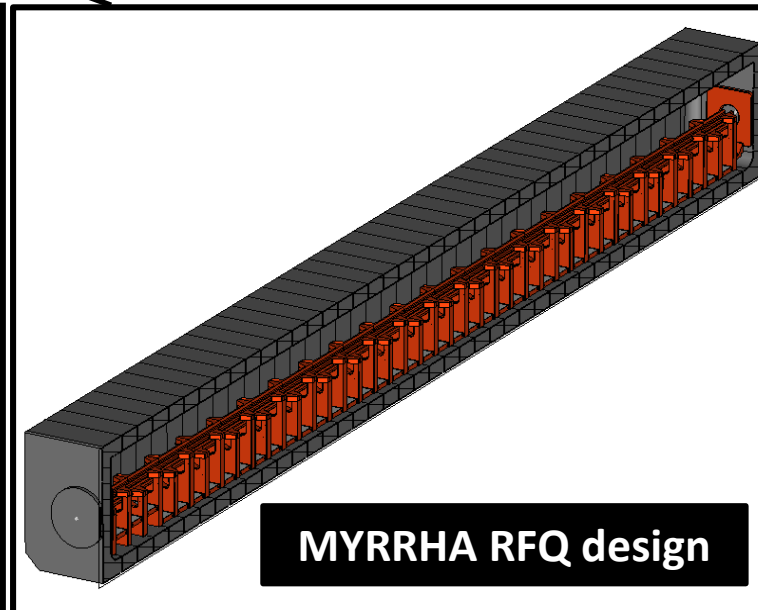
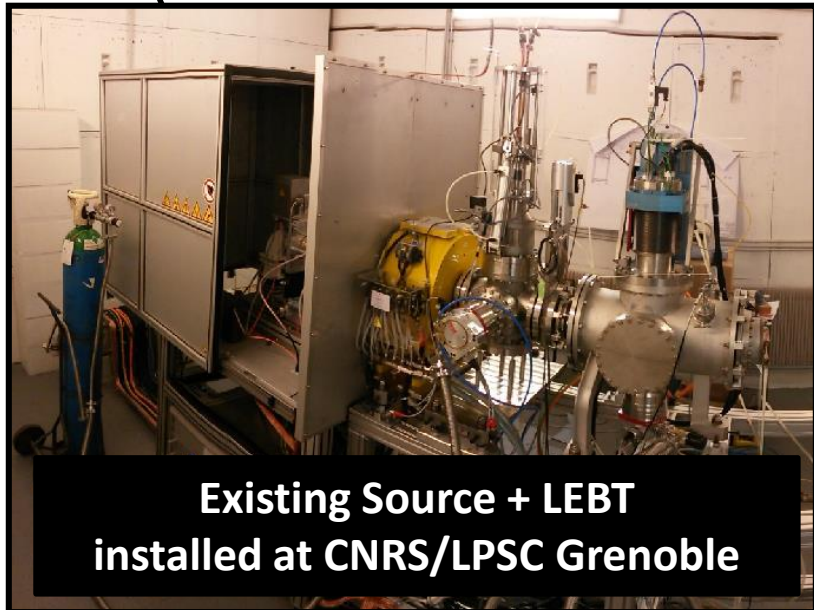
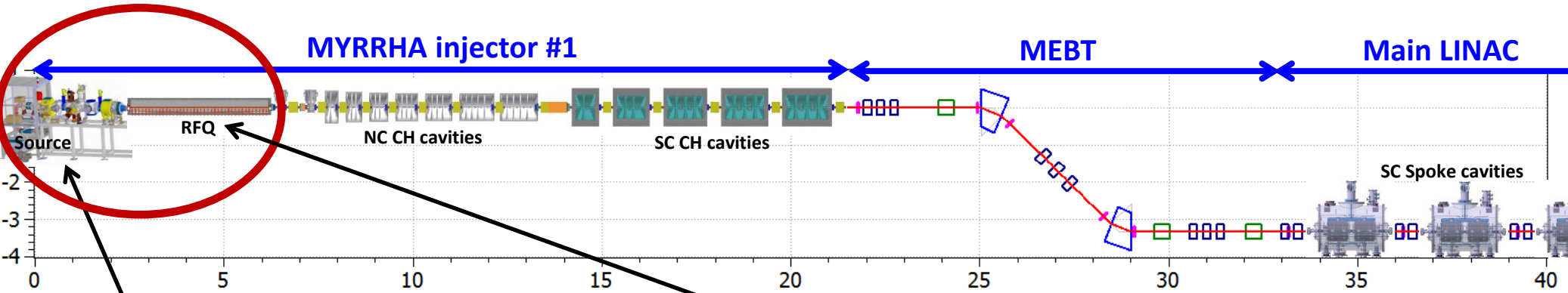

WP2 objectives – Injector demonstration



- Realisation of a full-size MYRRHA-type RFQ demonstrator (Task 2.1)
 - ✓ [IAP](#), NTG, U. Darmstadt, SCK•CEN, CEA, CNRS
 - ✓ April 2015 → Oct. 2017



- Construction of a prototype Solid State RF power amplifier (Task 2.2)
 - ✓ [IBA](#), SCK•CEN, CNRS, Cosylab, IAP
 - ✓ April 2015 → Oct. 2017

- Digital Low Level RF development (Task 2.3)

- ✓ [CNRS](#), SCK•CEN, Cosylab
- ✓ April 2015 → Oct. 2017

- Injector commissioning (Task 2.7)

- ✓ [SCK•CEN](#), CNRS, ADEX, CEA, Cosylab, IAP
- ✓ April 2017 → April 2019



WP2 objectives – Beam characterization & control



- Space-charge experiments (Task 2.8)

- ✓ [CNRS, CEA, IAP, SCK•CEN](#)

- ✓ April 2015 → Oct. 2017

- Beam diagnostics development (Task 2.4)

- ✓ [CEA, CNRS, SCK•CEN, Cosylab](#)

- ✓ April 2015 → April 2019

- Control system in a highly reliable accelerator context (Task 2.5)

- ✓ [Cosylab, SCK•CEN, ADEX, ACS, CEA, CNRS, IAP](#)

- ✓ April 2015 → April 2019

- Beam simulation code development, global coherence (Task 2.6)

- ✓ [CEA, CNRS, SCK•CEN](#)

- ✓ April 2015 → April 2019



WP2 objectives – Others



- LINAC4 reliability analysis (Task 2.9)

- ✓ [CERN](#), EA, SCK•CEN, TED

- ✓ April 2015 → April 2019

- MYRRHA SRF spoke R&D (Task 2.10)

- ✓ [CNRS](#), ACS

- ✓ April 2015 → Oct. 2017

- SRF CH demonstration with beam (Task 2.11)

- ✓ [IAP](#)

- ✓ April 2015 → Oct. 2017

- MYRRHA linac cost estimation (Task 2.12)

- ✓ [SCK•CEN](#), ACS, TED, CNRS, IAP

- ✓ April 2015 → Oct. 2016





MYRRHA Research
and Transmutation
Endeavour

THE FRAMEWORK PROGRAMME FOR RESEARCH AND INNOVATION

HORIZON 2020

6. Conclusion

Summary

- **Nuclear waste management** is a complex (& long-term) issue in a much more complex (& shorter-term) hazard: sustainable energy & global warming
- **MYRRHA** = unique opportunity to demonstrate the ADS technology in a high-power scale
- The **ADS accelerator reference scheme** is based on a 600 MeV, 4 mA cw superconducting proton LINAC
- R&D is focused on the **reliability issue**. This may bring substantial impact for availability optimisation in future accelerator projects featuring high power proton beams.
- Thanks to R&D, the MYRRHA accelerator has reached a sufficient level of design to be able to **envisage the start of a construction phase...**

MYRRHA 100 MeV might start this year!!

**Thank You
for your attention!**

