

CAS – Introduction to Accelerator Physics

Collective effects

Part III: Wake fields and impedances – instabilities



In the last lecture, we discussed **indirect space charge** and showed that this can lead **to both incoherent as well as coherent tune shifts**. We then moved on to a more general treatment of electromagnetic fields in simple structures where we were able to identify **yet another type of induced fields** originating from the **electromagnetic properties** of the surrounding material – **the wall wake**.

We looked at more general examples of induced fields in complex structures and **then introduced the concept of the wake function**.

Next we will look at some different wake fields and study more the **effect of wake fields and impedances** on the machine and on the beam.

- Part 3: Wake fields and impedances – impacts
 - Longitudinal and transverse wake fields and impedances
 - Panofsky-Wenzel theorem
 - Examples of analytically expressible wake functions and impedances
 - Impact of wake fields and impedance on the accelerator environment
 - Description of a coherent beam instability and the instability loop



We have already seen how we can simplify our handling of induced electromagnetic fields within complex structures by means of the **wake function**. The wake function is the **electromagnetic response** of a structure and is an **intrinsic property** of any such structure.

We will now look how we **handle longitudinal and transverse wake fields** in practice and what are some of the fundamental properties. We will also introduce the impedance.

- Part 3: Wake fields and impedances – impacts
 - Longitudinal and transverse wake fields and impedances
 - Panofsky-Wenzel theorem
 - Examples of analytically expressible wake functions and impedances
 - Impact of wake fields and impedance on the accelerator environment
 - Description of a coherent beam instability and the instability loop

Wake function – general definition

How can we treat these phenomena effectively in our models?

- We will use
- The rigid beam approximation
- The forces
- The impulse approximation

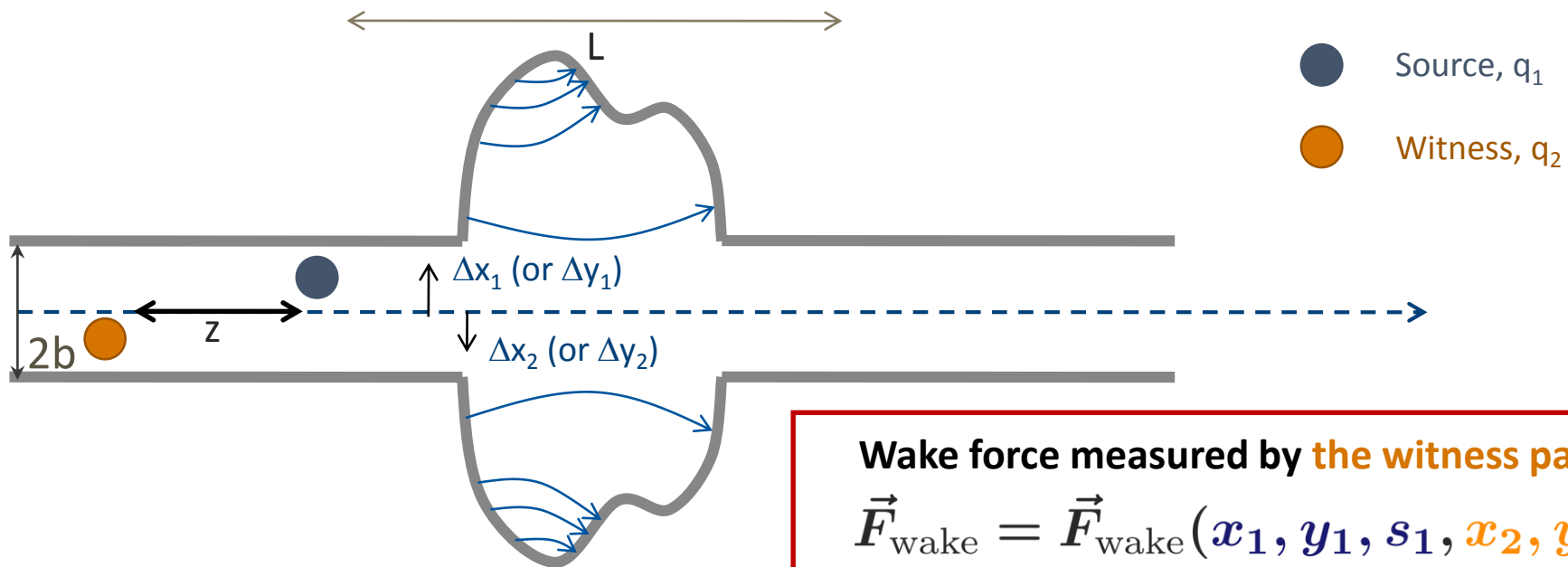

Note that:
$$\vec{F}_{\text{wake}} = q_2 \left(\vec{E}(\mathbf{x}_1, \mathbf{y}_1, s_1, \mathbf{x}_2, \mathbf{y}_2, s_2, t) + v_z \vec{e}_z \times \vec{B}(\mathbf{x}_1, \mathbf{y}_1, s_1, \mathbf{x}_2, \mathbf{y}_2, s_2, t) \right)$$

Wake function – general definition

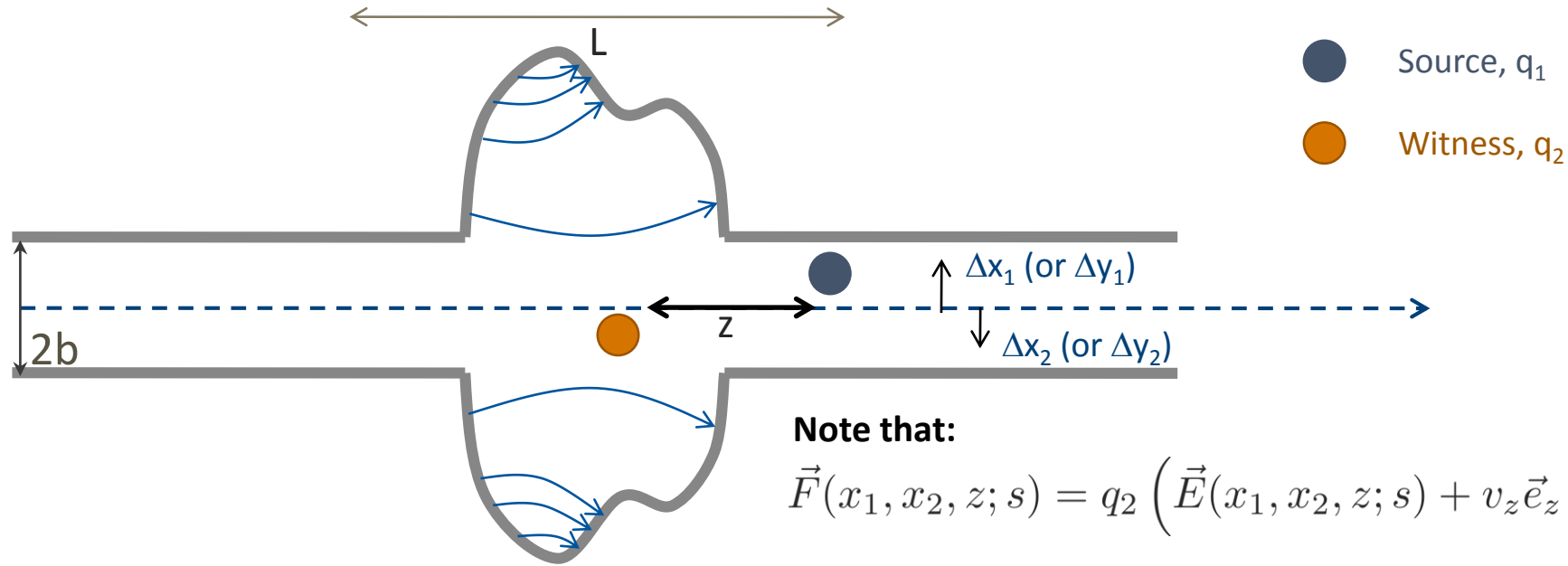

We define the **wake function as the integrated force on the witness particle** (associated to a change in energy):

- Let's focus on the horizontal plane. In general, for two point-like particles, we have

$$\Delta E_2 = \int F(x_1, x_2, z; s) ds = -q_1 q_2 \mathbf{w}(x_1, x_2, z) \quad z \equiv s_2 - s_1, \quad s \equiv s_1$$

Wake potential for a distribution of particles

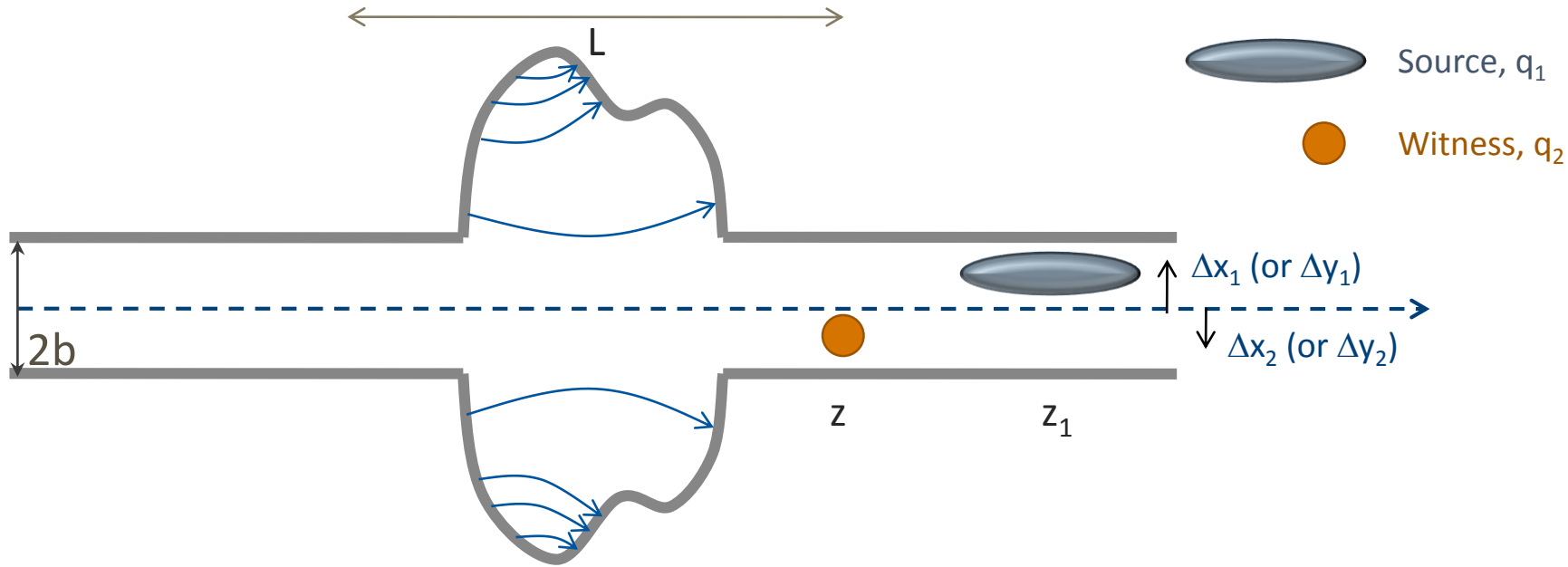

We define the wake function as the **integrated force** on the witness particle (associated to a change in energy):

- For an extended particle distribution this becomes (superposition of all source terms)

$$\Delta E_2(z) \propto \int \boxed{\lambda_1(x_1, z_1)} w(\mathbf{x}_1, \mathbf{x}_2, z - z_1) dx_1 dz_1$$

Forces become dependent on the **particle distribution function**

Longitudinal wake function

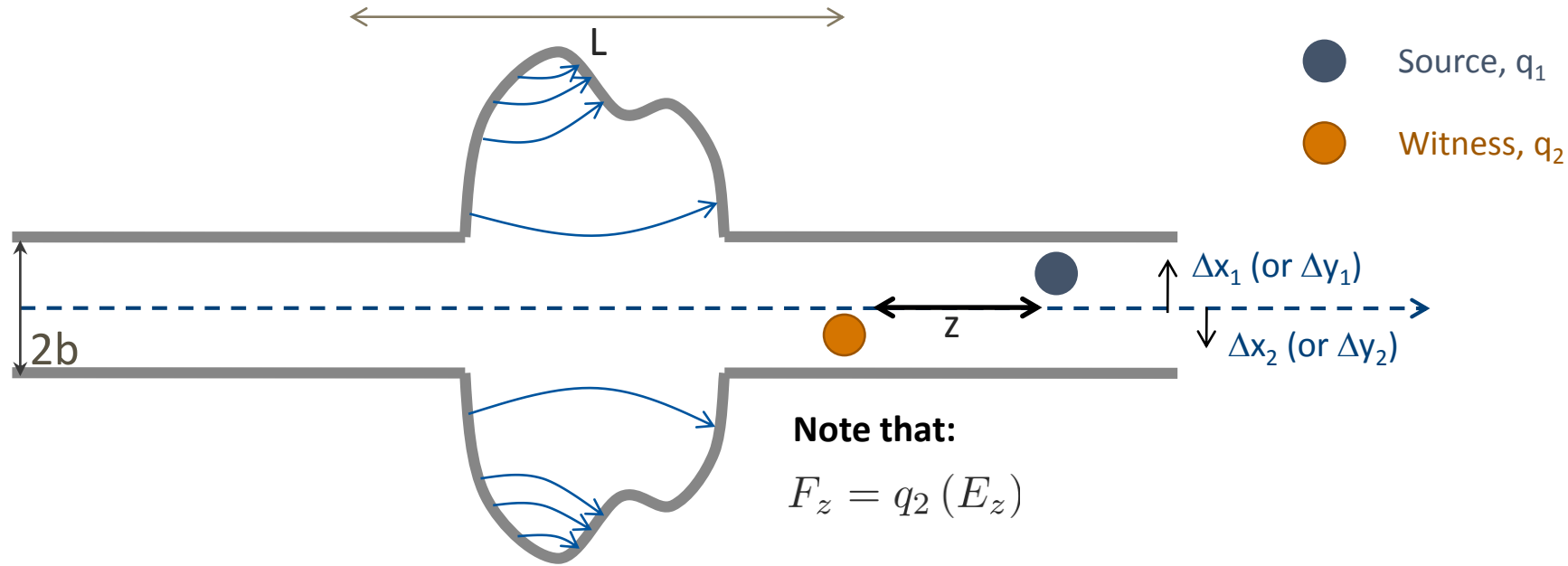

- Longitudinal wake fields

$$\int F_z(\Delta x_1, \Delta x_2, z; s) ds = -q_1 q_2 \left(\boxed{W_{\parallel}(z)} + \boxed{O(\Delta x_1) + O(\Delta x_2)} \right)$$

Zeroth order with source and test centred usually dominant

Higher order terms Usually negligible for small offsets

Longitudinal wake function

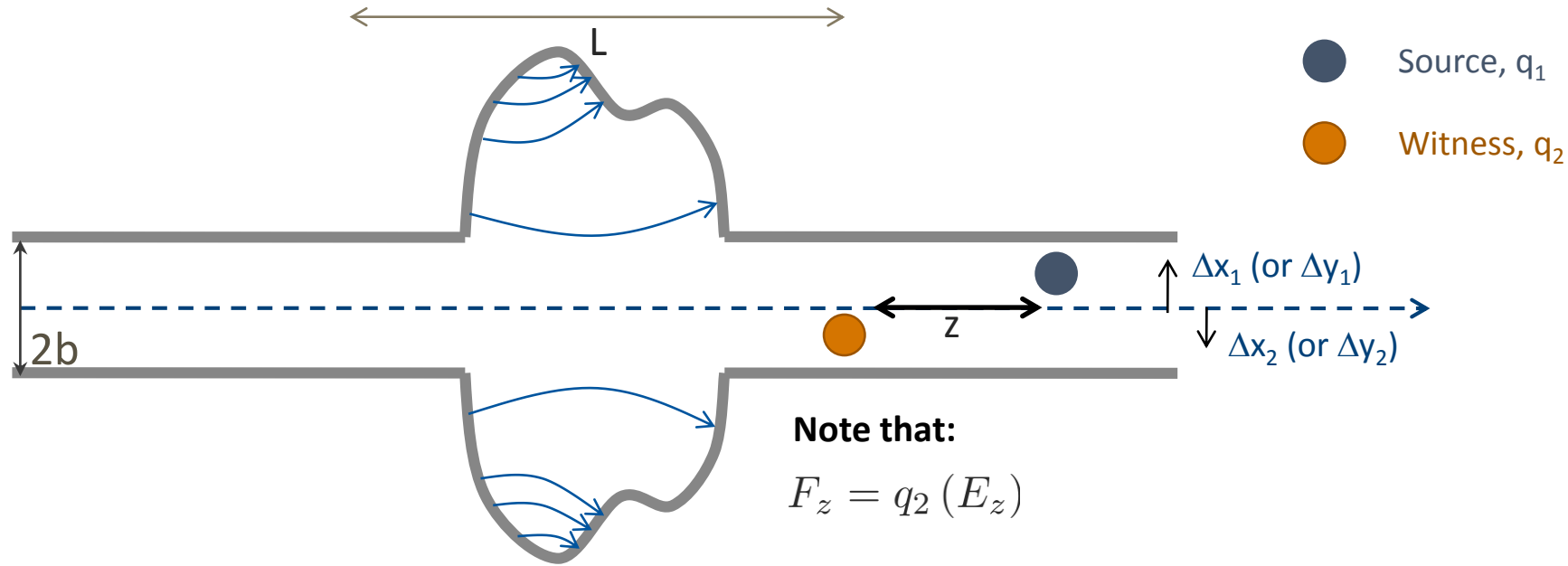

- Longitudinal wake fields

$$\Delta E_2 = \int F_z(z; s) ds = -q_1 q_2 W_{\parallel}(z)$$

$$\rightarrow \frac{\Delta E_2}{E_0} = \left(\frac{\gamma^2 - 1}{\gamma} \right) \frac{\Delta p_2}{p_0}$$

Energy kick of the witness particle from longitudinal wakes

Longitudinal wake function

$$W_{\parallel}(z) = -\frac{\Delta E_2}{q_1 q_2} \xrightarrow[q_2 \rightarrow q_1]{z \rightarrow 0} W_{\parallel}(0) = -\frac{\Delta E_1}{q_1^2}$$

- The value of the wake function in $z=0$ is related to **the energy lost by the source particle** in the creation of the wake

- We can also describe it as a **transfer function in frequency domain**

→ This is the definition of **transverse beam coupling impedance** of the element under study

$$Z_{\parallel}(\omega) = \int_{-\infty}^{\infty} W_{\parallel}(z) \exp\left(-\frac{i\omega z}{c}\right) \frac{dz}{c}$$

\downarrow \downarrow
[Ω] [Ω/s]

→ Very useful for macroparticle models and simulations, because it can be used to describe the driving terms in the single particle equations of motion

Transverse wake functions

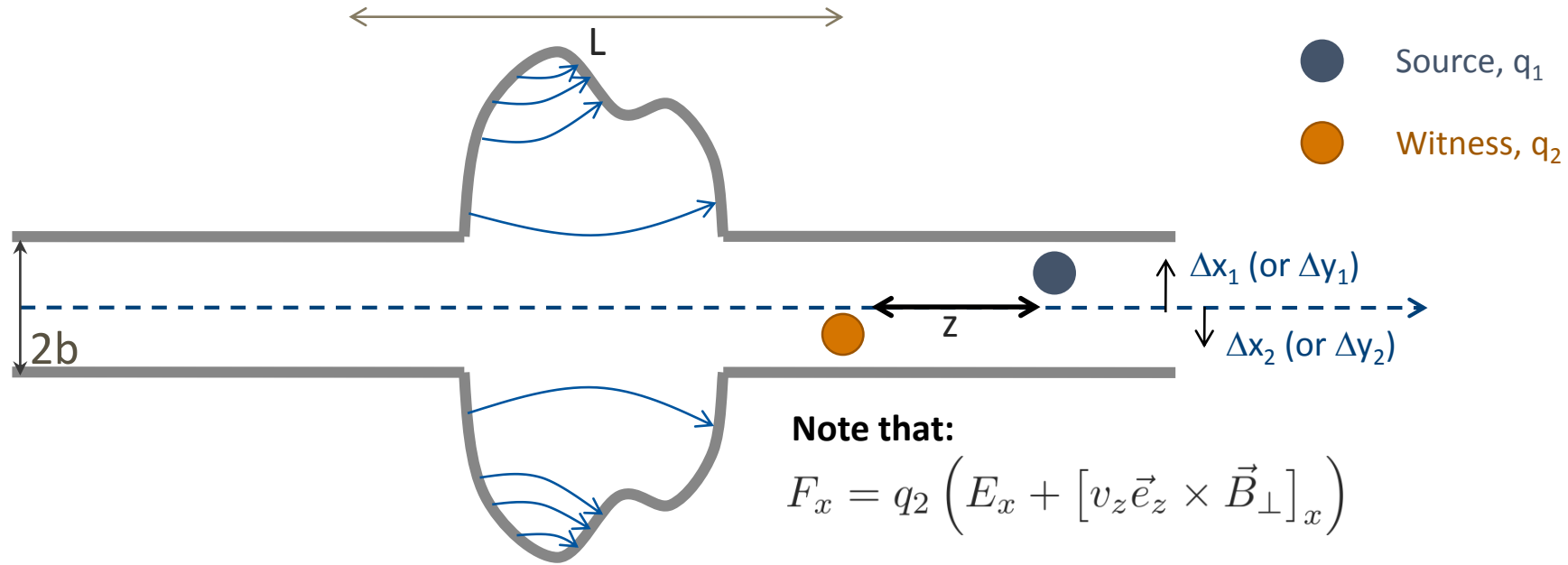

- Transverse wake fields

$$\Delta E_{x2} = \int F_x(\Delta x_1, \Delta x_2, z; s) ds$$

Transverse wake functions

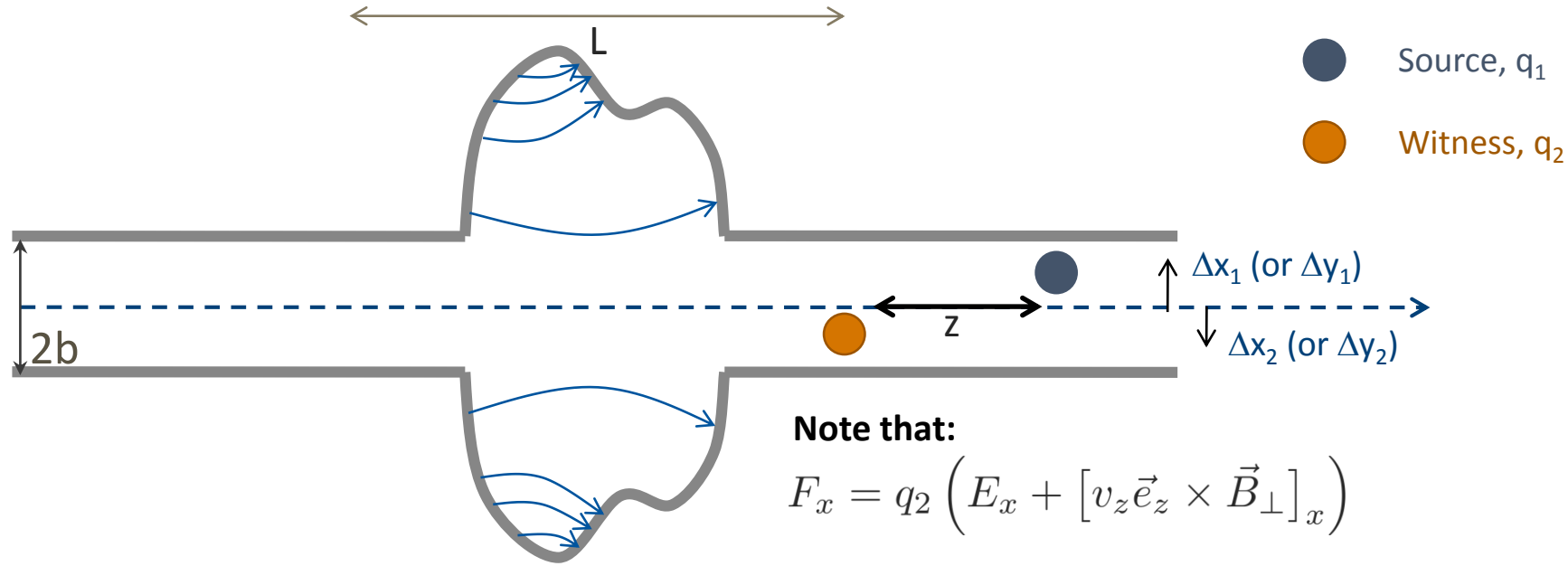

Note that:

$$F_x = q_2 \left(E_x + [v_z \vec{e}_z \times \vec{B}_\perp]_x \right)$$

First order expansion in transverse coordinates of source and witness particles

- Transverse wake fields

$$\Delta E_{x2} = \int F_x(\Delta x_1, \Delta x_2, z; s) ds = -q_1 q_2 \left(W_{C_x}(z) + W_{D_x}(z) \Delta x_1 + W_{Q_x}(z) \Delta x_2 \right)$$

Transverse wake functions

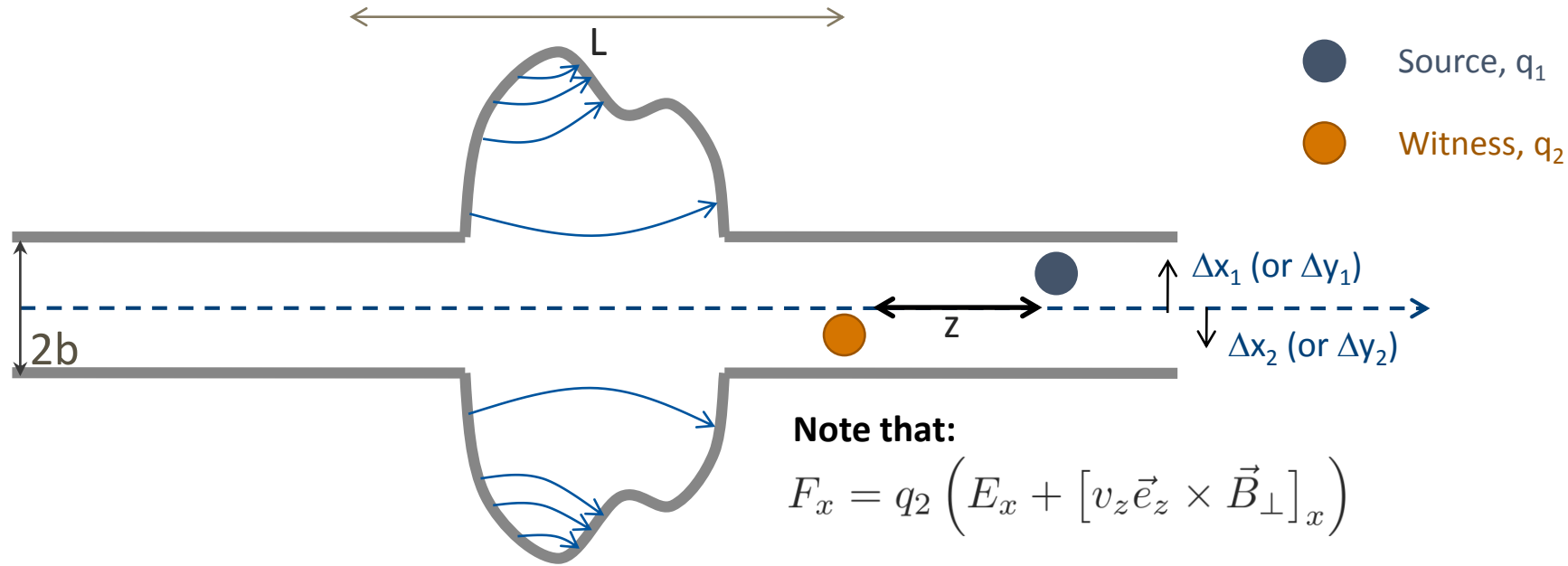

- Transverse wake fields

First order expansion in transverse coordinates of source and witness particles

$$\Delta E_{x2} = \int F_x(\Delta x_1, \Delta x_2, z; s) ds = -q_1 q_2 \left(W_{C_x}(z) + W_{D_x}(z) \Delta x_1 + W_{Q_x}(z) \Delta x_2 \right)$$

$$\longrightarrow \frac{\Delta E_{x2}}{E_0} = x'_2$$

Transverse deflecting kick of the witness particle from transverse wakes

Transverse wake functions

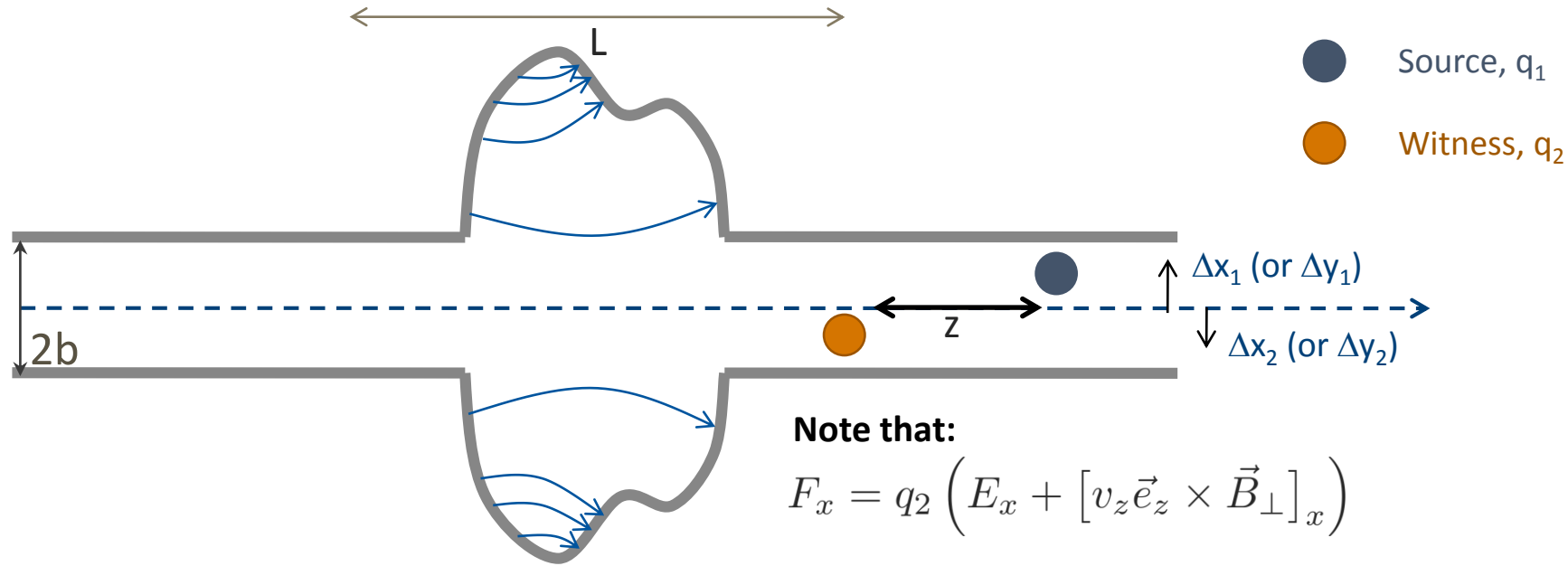

- Transverse wake fields

$$\Delta E_{x2} = \int F_x(\Delta x_1, \Delta x_2, z; s) ds = -q_1 q_2 \left(W_{C_x}(z) + W_{D_x}(z) \Delta x_1 + W_{Q_x}(z) \Delta x_2 \right)$$

Zeroth order for
 asymmetric structures
 → **Orbit offset**

Dipole wakes –
 depends on **source particle**
 → **Orbit offset**

Quadrupole wakes –
 depends on **witness particle**
 → **Detuning**

Transverse wake functions

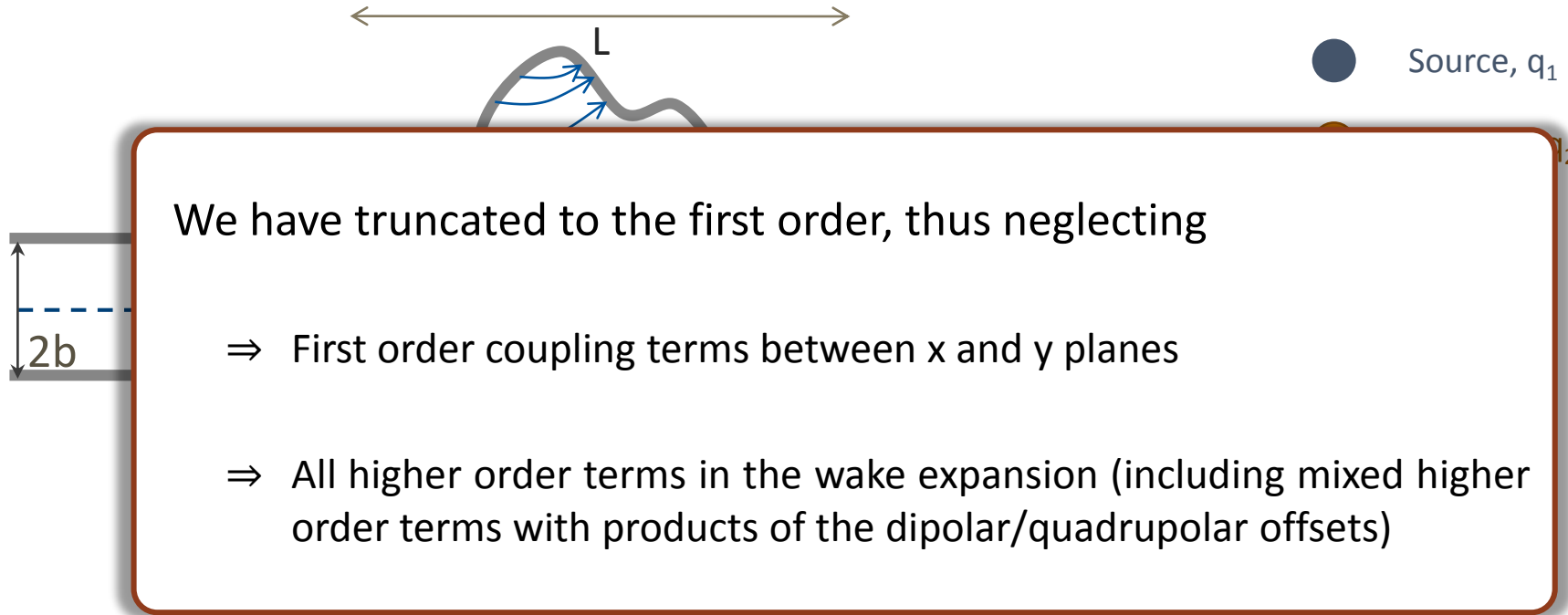

Source, q_1

We have truncated to the first order, thus neglecting

- ⇒ First order coupling terms between x and y planes
- ⇒ All higher order terms in the wake expansion (including mixed higher order terms with products of the dipolar/quadrupolar offsets)

- Transverse wake fields

$$\Delta E_{x_2} = \int F_x(\Delta x_1, \Delta x_2, z; s) ds = -q_1 q_2 (W_{C_x}(z) + W_{D_x}(z) \Delta x_1 + W_{Q_x}(z) \Delta x_2)$$

Zeroth order for asymmetric structures
→ **Orbit offset**

Dipole wakes – depends on **source particle**
→ **Orbit offset**

Quadrupole wakes – depends on **witness particle**
→ **Detuning**

$$W_{D_x}(z) = -\frac{E_0}{q_1 q_2} \frac{\Delta x'_2}{\Delta x_1} \qquad W_{Q_x}(z) = -\frac{E_0}{q_1 q_2} \frac{\Delta x'_2}{\Delta x_2}$$

- The **wake function** of an accelerator component is basically its **Green function in time domain** (i.e., its response to a pulse excitation):

- We can also describe it as a **transfer function in frequency domain**

→ This is the definition of **transverse beam coupling impedance** of the element under study

→ Very useful for macroparticle models and simulations, because it can be used to describe the driving terms in the single particle equations of motion!

Dipolar
Quadrupolar

$$\begin{aligned} Z_{D_x}(\omega) &= i \int_{-\infty}^{\infty} W_{D_x}(z) \exp\left(-\frac{i\omega z}{c}\right) \frac{dz}{c} \\ Z_{Q_x}(\omega) &= i \int_{-\infty}^{\infty} W_{Q_x}(z) \exp\left(-\frac{i\omega z}{c}\right) \frac{dz}{c} \end{aligned}$$

[Ω/m]



We have used the concept of wake fields in **the longitudinal and the transverse planes**, respectively. We have found that we usually do a decomposition of the wake function to obtain only the leading orders, namely, **constant, dipolar and quadrupolar wake fields**. We have also introduced the **impedance of the frequency domain representation** of the wake function.

We will now study some more properties of wake fields and show some typical **examples of wake fields and impedances** for which an analytical expression exists.

- Part 3: Wake fields and impedances – impacts
 - Longitudinal and transverse wake fields and impedances
 - Panofsky-Wenzel theorem
 - Examples of analytically expressible wake functions and impedances
 - Impact of wake fields and impedance on the accelerator environment
 - Description of a coherent beam instability and the instability loop

Panofsky-Wenzel Theorem

- Longitudinal and transverse wake fields and impedances are **tightly related via Maxwell's equations** by means of the **Panofsky-Wenzel theorem**, which states that:

$$\frac{\partial}{\partial z} \int_0^L \vec{F}_\perp ds = \vec{\nabla}_\perp \int_0^L F_s ds$$

- Remembering that:

$$\int F_z(\Delta x_1, \Delta x_2, z, s) ds = -q_1 q_2 \left[W_\parallel(z) + W_\parallel^{(d)} \Delta x_1 + W_\parallel^{(q)} \Delta x_2 + W_\parallel^{(2d)} \Delta x_1^2 + W_\parallel^{(2q)} \Delta x_2^2 + W_\parallel^{(dq)} \Delta x_1 \Delta x_2 + O(\Delta x^3) \right]$$

$$\int F_x(\Delta x_1, \Delta x_2, z, s) ds = -q_1 q_2 \left[W_{C_x}(z) + W_{D_x}(z) \Delta x_1 + W_{Q_x} \Delta x_2 + O(\Delta x^2) \right]$$

Panofsky-Wenzel Theorem

- Longitudinal and transverse wake fields and impedances are **tightly related via Maxwell's equations** by means of the **Panofsky-Wenzel theorem**, which states that:

It follows for the longitudinal and transverse wake fields and impedances that:

- Remembering that:

$$W'_{D_x}(z) = W_{\parallel}^{(dq)}(z) \quad \overset{\mathcal{F}}{\iff} \quad \frac{\omega}{c} Z_{\perp}(\omega) = Z_{\parallel}^{(dq)}(\omega)$$

$$W'_{Q_x}(z) = 2W_{\parallel}^{(2q)}(z) \quad \overset{\mathcal{F}}{\iff} \quad \frac{\omega}{c} Z_{\perp}(\omega) = 2Z_{\parallel}^{(2q)}(\omega)$$

The **longitudinal and transverse wake functions are not independent**, although in general no relation can be established between $W_{\parallel}(z)$ and $W_{D_x, D_y}(z)$, which are the main wakes in the longitudinal and transverse planes, respectively.

Examples: resonator wakes

- Wakefields and/or impedances can be computed by using **Maxwell's equations to compute the impulse response** for a given structure either in time domain or in frequency domain, respectively.
- Some examples of impedances computed in the ultra-relativistic limit are:

- Resonator impedance

$$Z_{\parallel \text{Res}}(\omega) = \frac{R_{s\parallel}}{1 + iQ \left(\frac{\omega_r}{\omega} - \frac{\omega}{\omega_r} \right)}$$

$$Z_{\perp \text{Res}}(\omega) = \frac{\omega_r}{\omega} \frac{R_{s\perp}}{1 + iQ \left(\frac{\omega_r}{\omega} - \frac{\omega}{\omega_r} \right)}$$

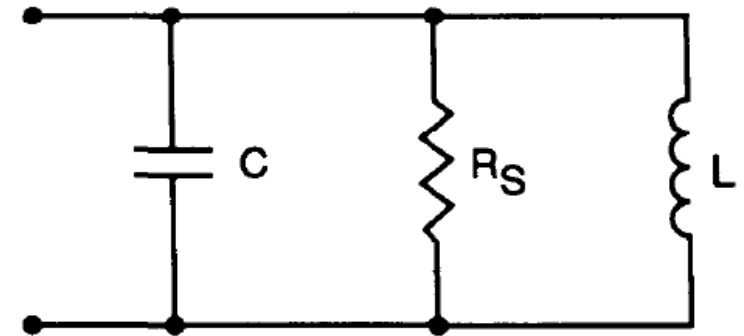

$$\frac{1}{Z_{\parallel \text{Res}}} = \frac{1}{R_s} + \frac{i}{\omega L} - i\omega C$$

$$Q = R_s \sqrt{C/L}, \quad \omega = \sqrt{\frac{1}{LC}}$$

$$\alpha_z = \frac{\omega_r}{2Q}, \quad \bar{\omega} = \sqrt{\omega_r^2 - \alpha_z^2}$$

Examples: broadband resonator

Gaussian bunch profile with $\sigma = 1$ ns

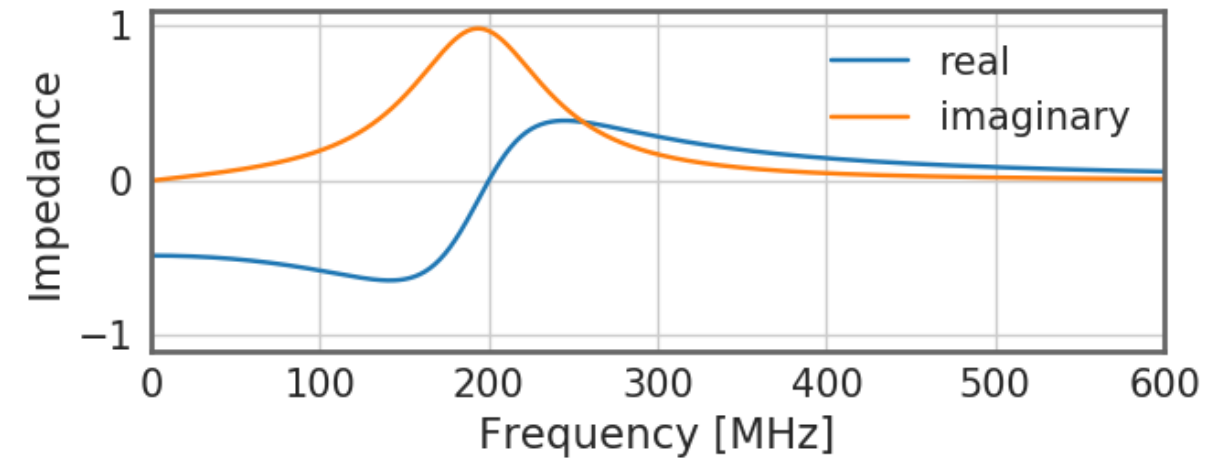
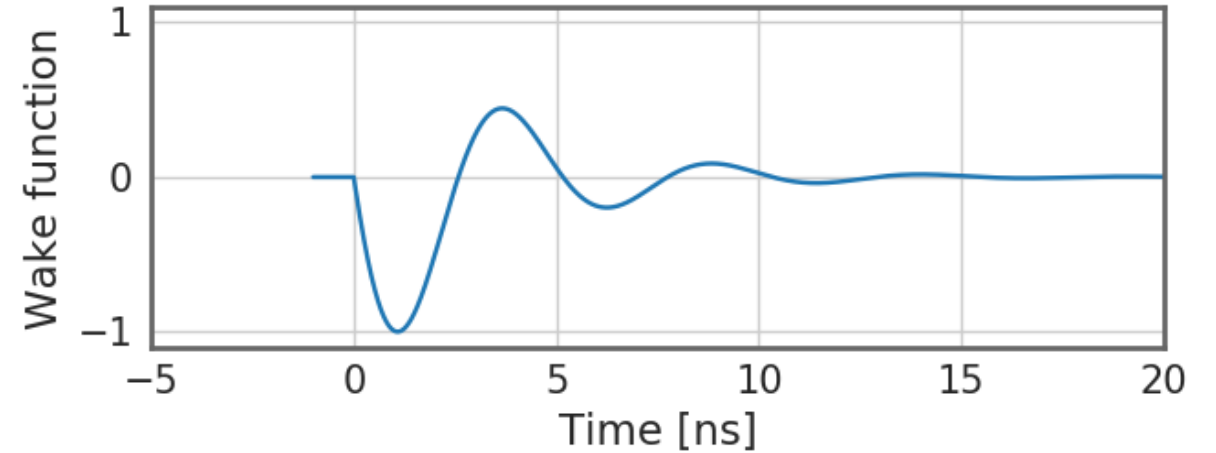

Examples: broadband resonator

Gaussian bunch profile with $\sigma = 1$ ns

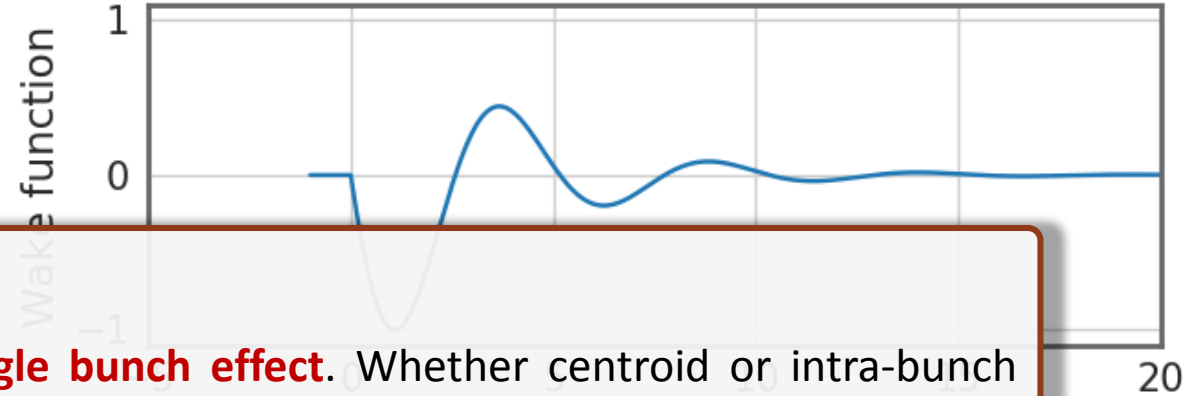
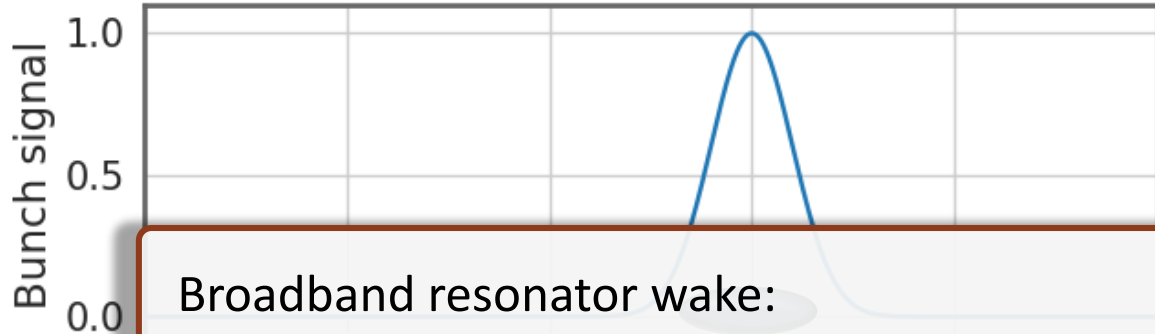

Broadband resonator wake:

⇒ Fast decaying fields – **short range, mostly single bunch effect**. Whether centroid or intra-bunch motion is excited is determined by the resonator frequency and bunch length.

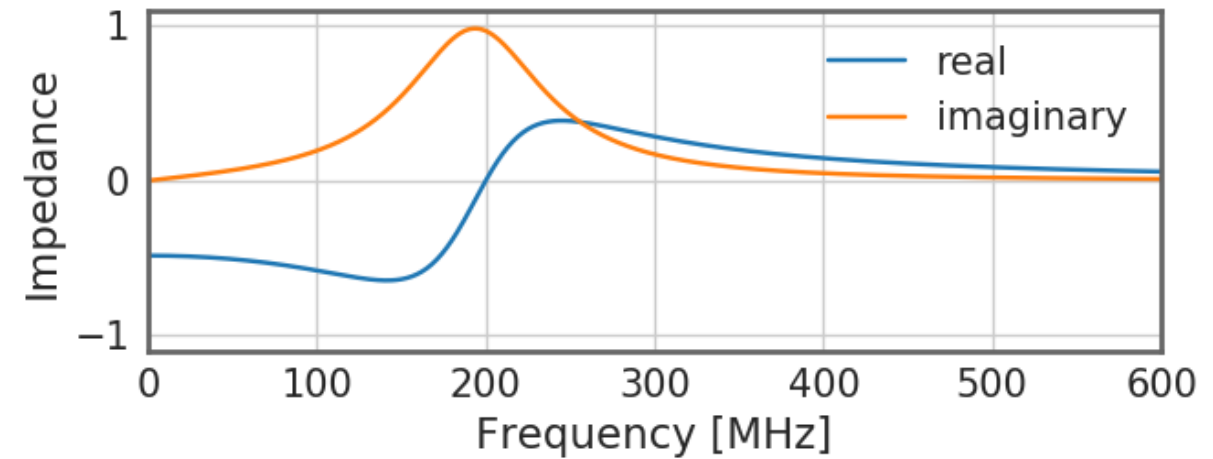
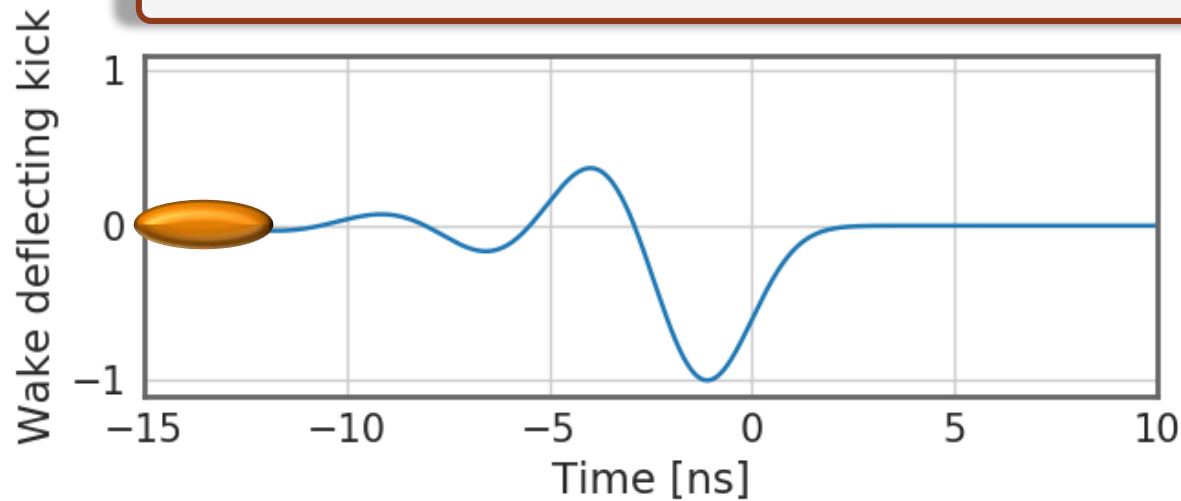

Examples: narrowband resonator

Gaussian bunch profile with $\sigma = 1$ ns

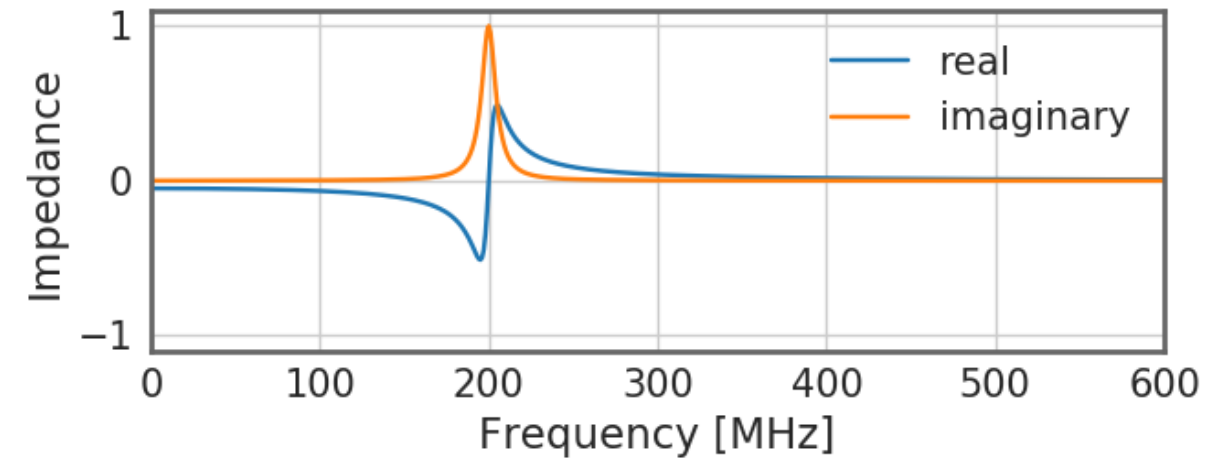
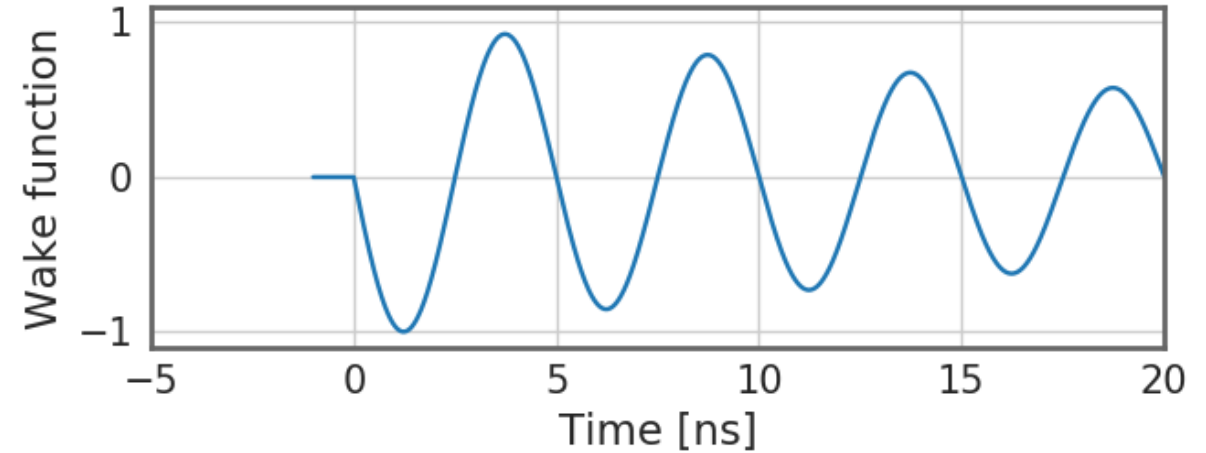

Examples: narrowband resonator

Gaussian bunch profile with $\sigma = 1$ ns

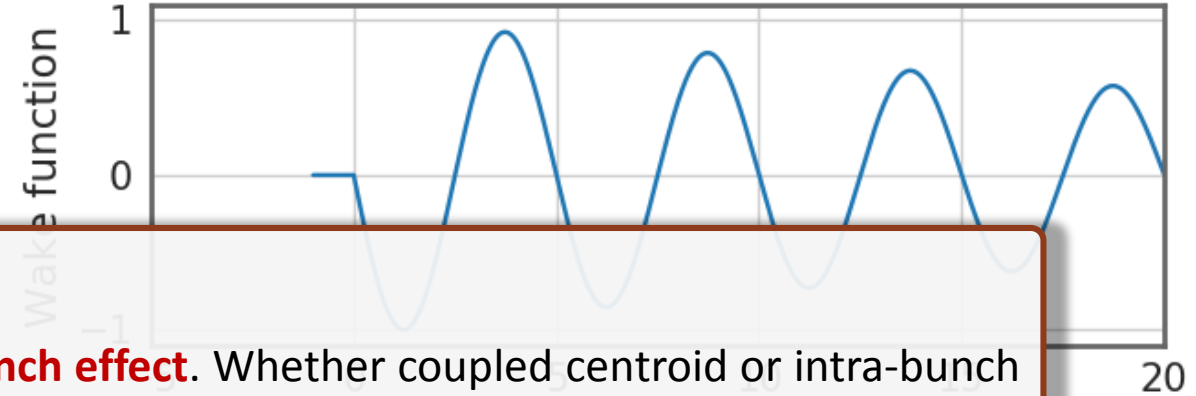
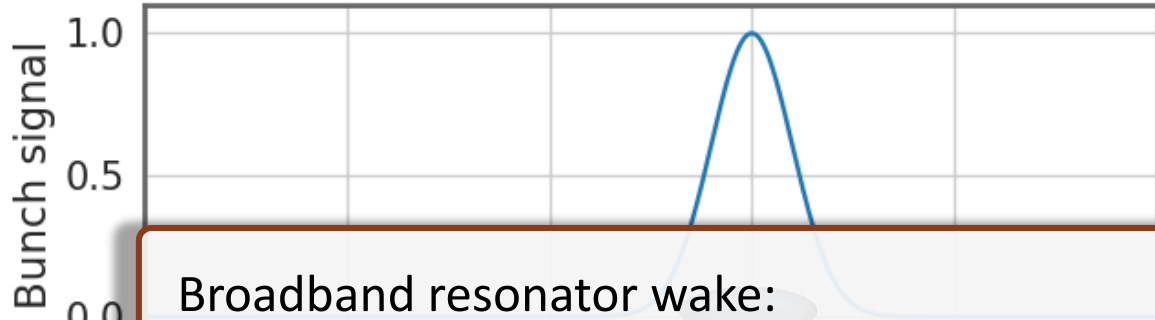

Broadband resonator wake:

⇒ Slowly decaying fields – **long range, coupled bunch effect**. Whether coupled centroid or intra-bunch motion is excited is determined by the resonator frequency, bunch spacing and bunch length.

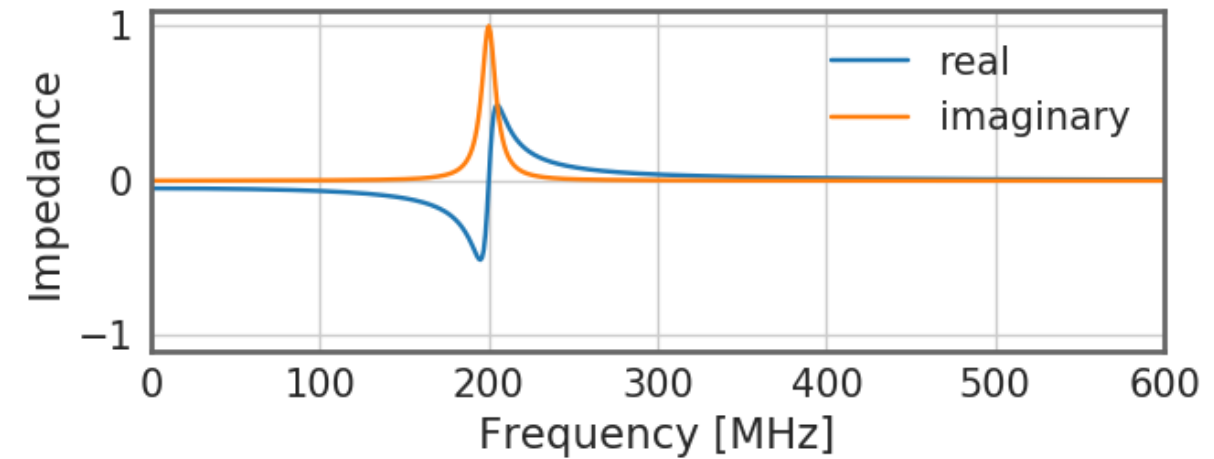
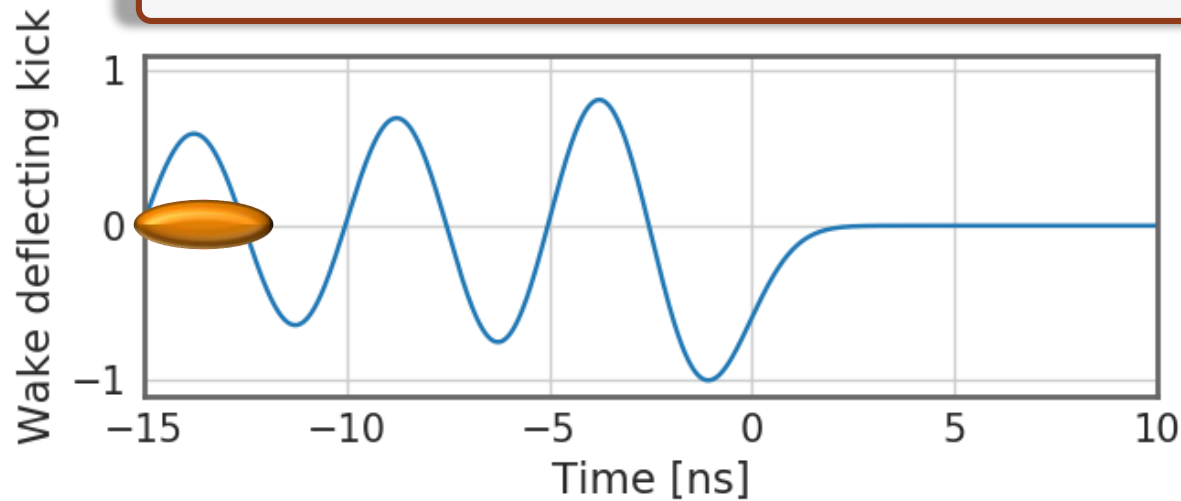



We have briefly discussed **the Panofsky-Wenzel theorem** and looked at analytical expressions **for the resistive wall and resonator impedances**. We have seen the difference between short range and long range wake fields and understood how these can lead to single or coupled bunch instabilities.

Before actually looking at the impact of wake fields and impedances on the beam, we will now first study their **impact on the environment** – in particular, **beam induced heating** which can be dangerous and even destructive for poorly designed machine elements.

- Part 3: Wake fields and impedances – impacts
 - Longitudinal and transverse wake fields and impedances
 - Panofsky-Wenzel theorem
 - Examples of analytically expressible wake functions and impedances
 - Impact of wake fields and impedance on the accelerator environment
 - Description of a coherent beam instability and the instability loop

The energy balance

$$W_{\parallel}(0) = \frac{1}{\pi} \int_0^{\infty} \operatorname{Re} (Z_{\parallel}(\omega)) d\omega = -\frac{\Delta E_1}{q_1^2}$$

What happens to the energy lost by the source?

- In the global energy balance, the energy lost by the source splits into:
 - Electromagnetic energy of the **modes that remain trapped** in the object
 - Partly dissipated on **lossy walls** or into purposely designed inserts or HOM absorbers
 - Partly transferred to **following particles** (or the same particle over successive turns), possibly feeding into an instability!
 - Electromagnetic energy of **modes that propagate** down the beam chamber (above cut-off), eventually lost on surrounding lossy materials

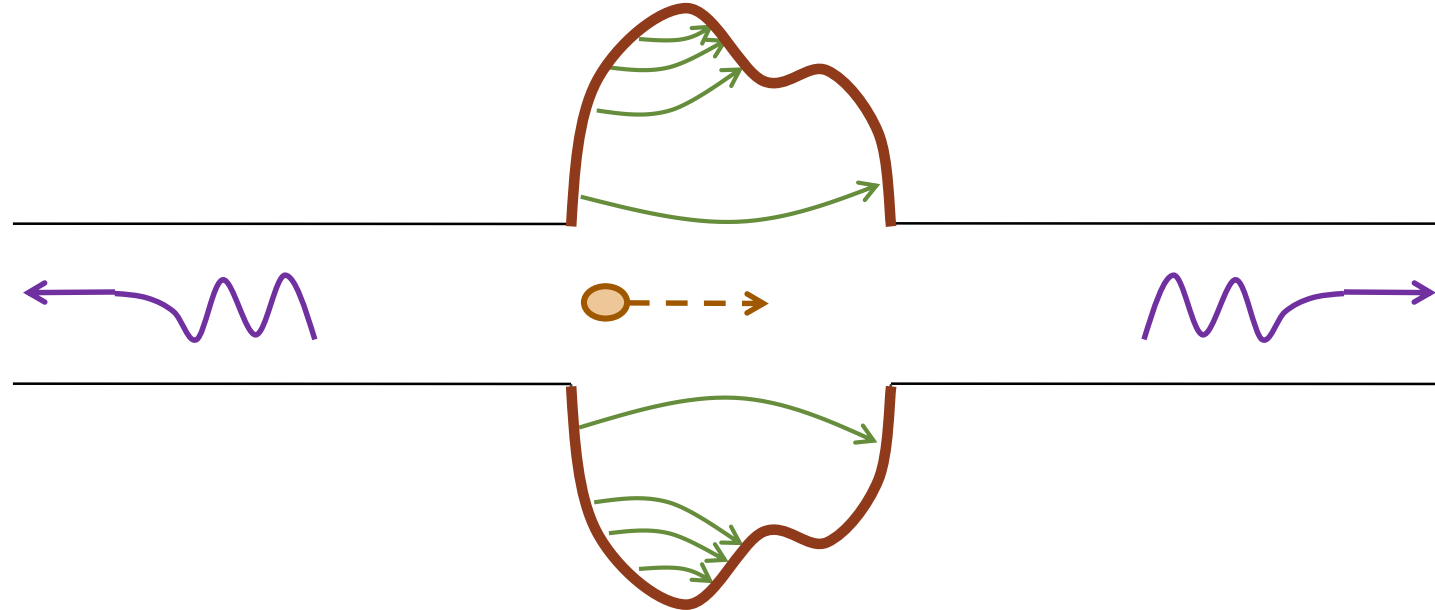

The energy balance

$$W_{\parallel}(0) = \frac{1}{\pi} \int_0^{\infty} \text{Re} (Z_{\parallel}(\omega)) d\omega = -\frac{\Delta E_1}{q_1^2}$$

What happens to the energy lost by the source?

- In the global energy balance
 - Electromagnetic radiation
 - Partly dissipated
 - Partly trapped
 - Electromagnetic fields surrounding the bunch

The energy loss of a particle bunch

- ⇒ causes **beam induced heating** of the machine elements (damage, outgassing)
- ⇒ feeds into both **longitudinal and transverse instabilities** through the associated EM fields
- ⇒ is compensated by the RF system determining a **stable phase shift**

into an instability!
, eventually lost on

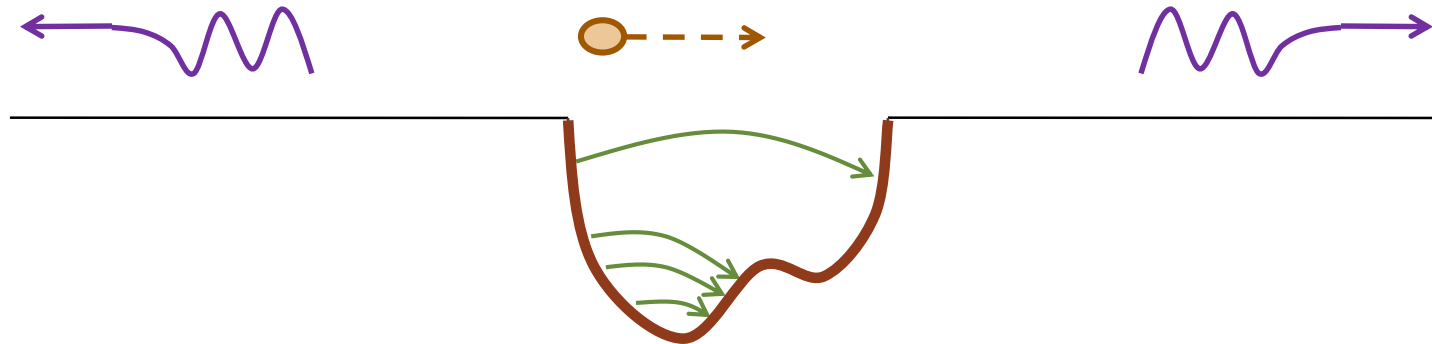

Examples: SPS kickers

Two types of SPS extraction kickers (MKE):

1. Original design: several modules separated by conductor stripes (segmentation) with **bare ferrite blocks**, fed by an inner and an outer conductor
2. New design: like original, but modules have **'serigraphed' ferrite blocks** (i.e. with patterns of silver paste screen printed on the ferrite surface exposed to the beam)

Original kicker

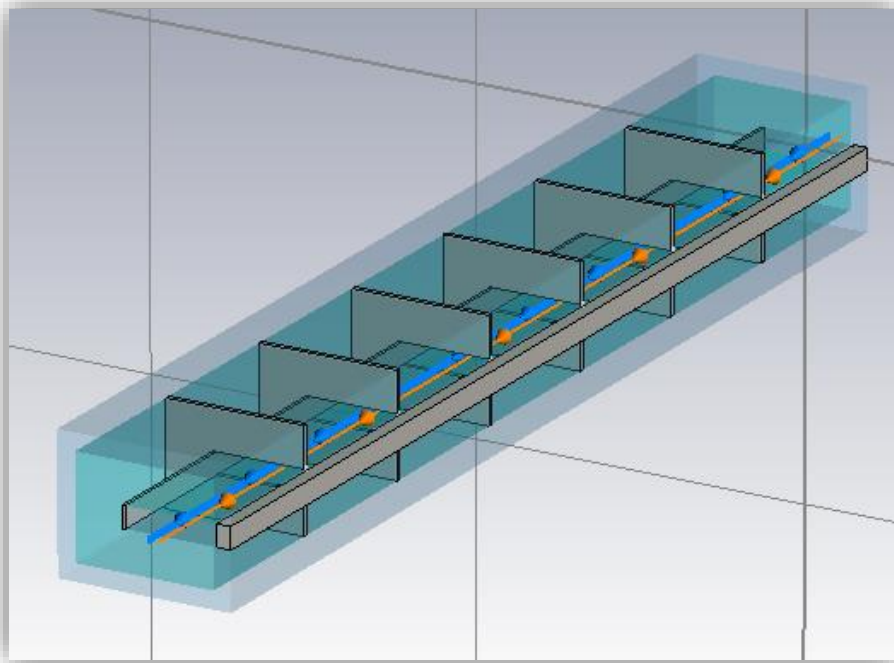

Serigraphed kicker

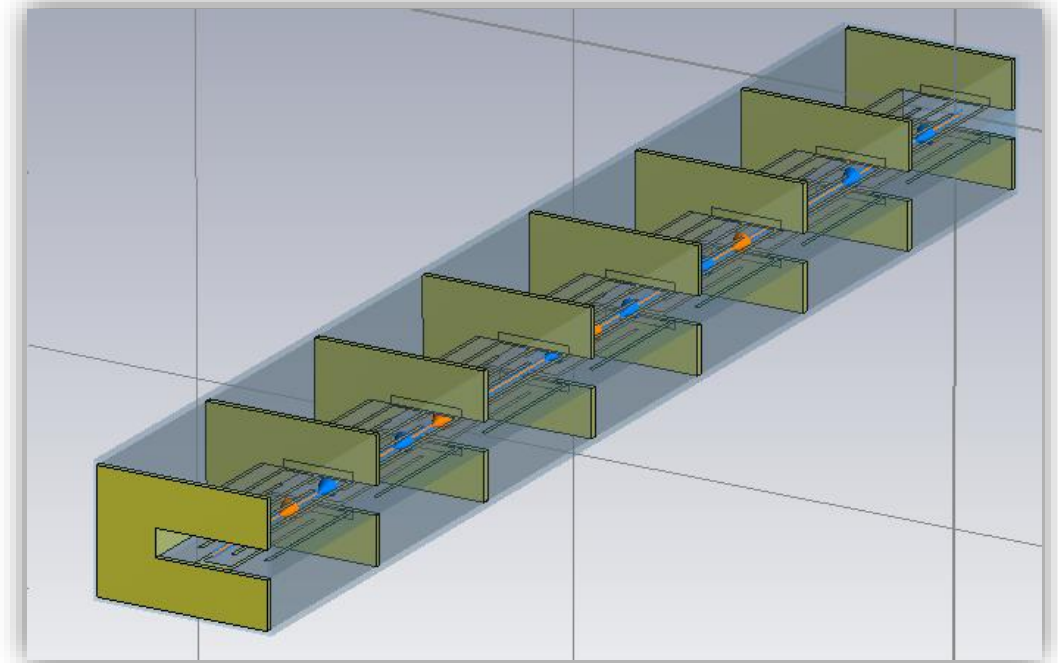

Examples: ferrite kicker – simple model

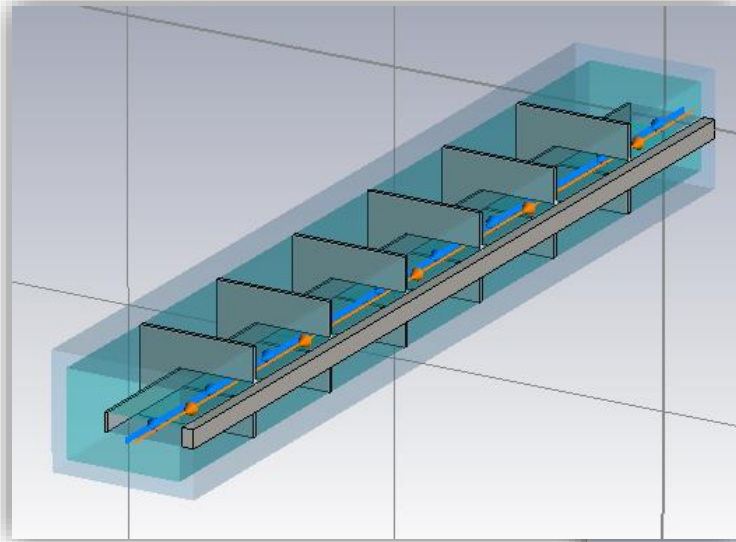

Original kicker **without serigraphy, typical broad-band behaviour**, here some ringing is due to the longitudinal segmentation

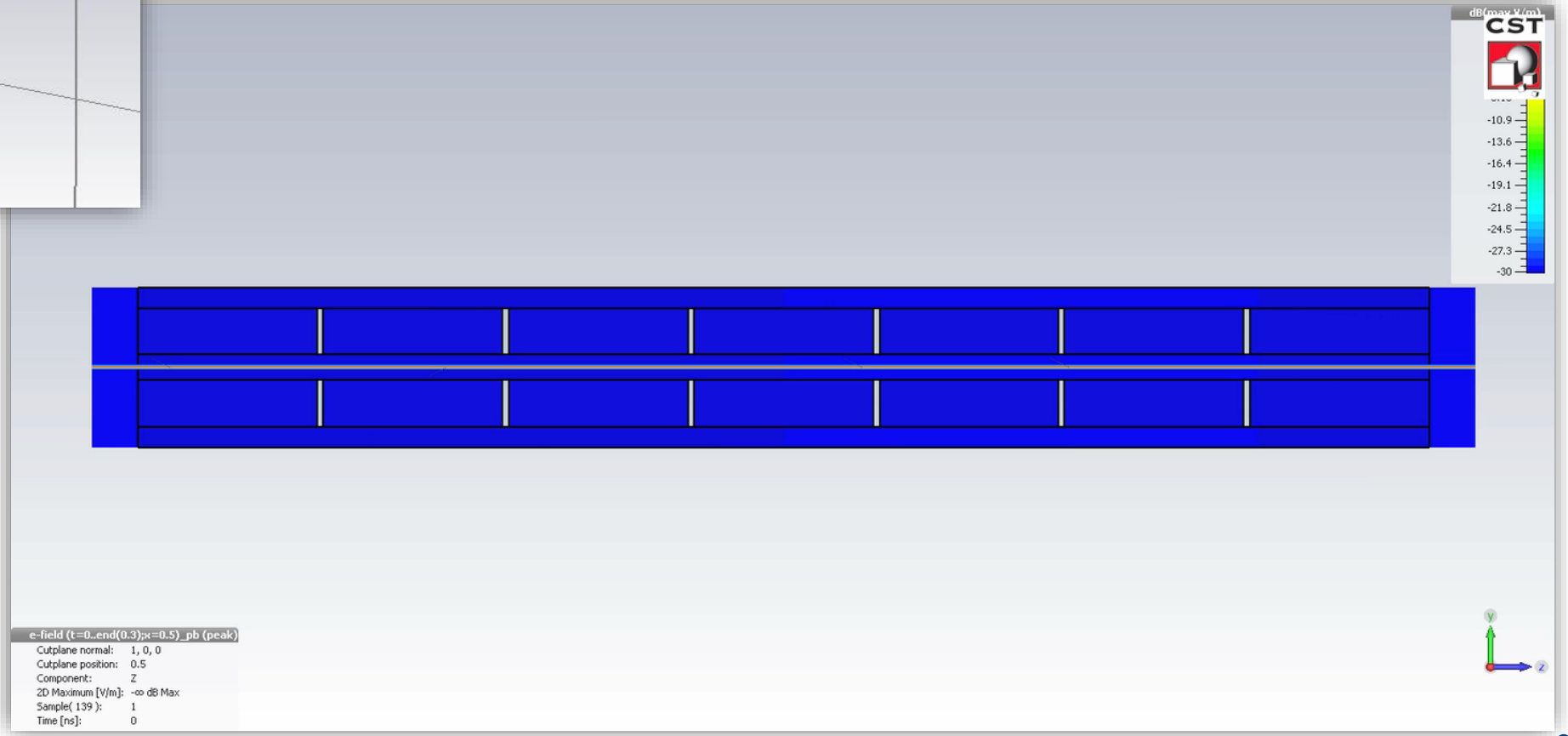

Examples: serigraphed kicker – simple model

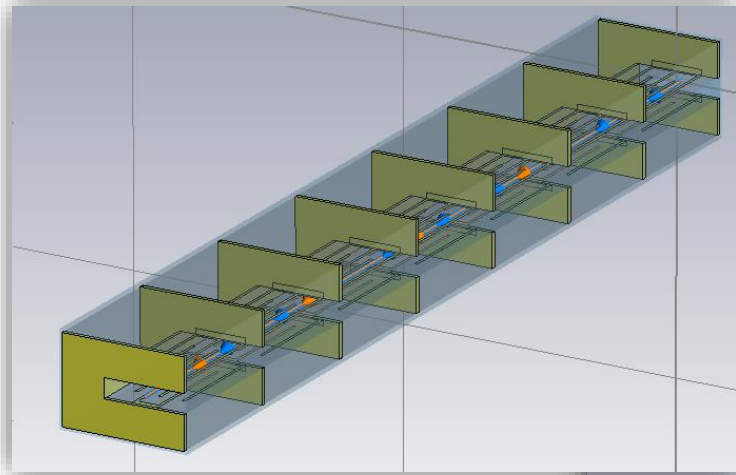

Serigraphed kicker **exhibits strong ringing** due to the EM trapping along the serigraphy fingers

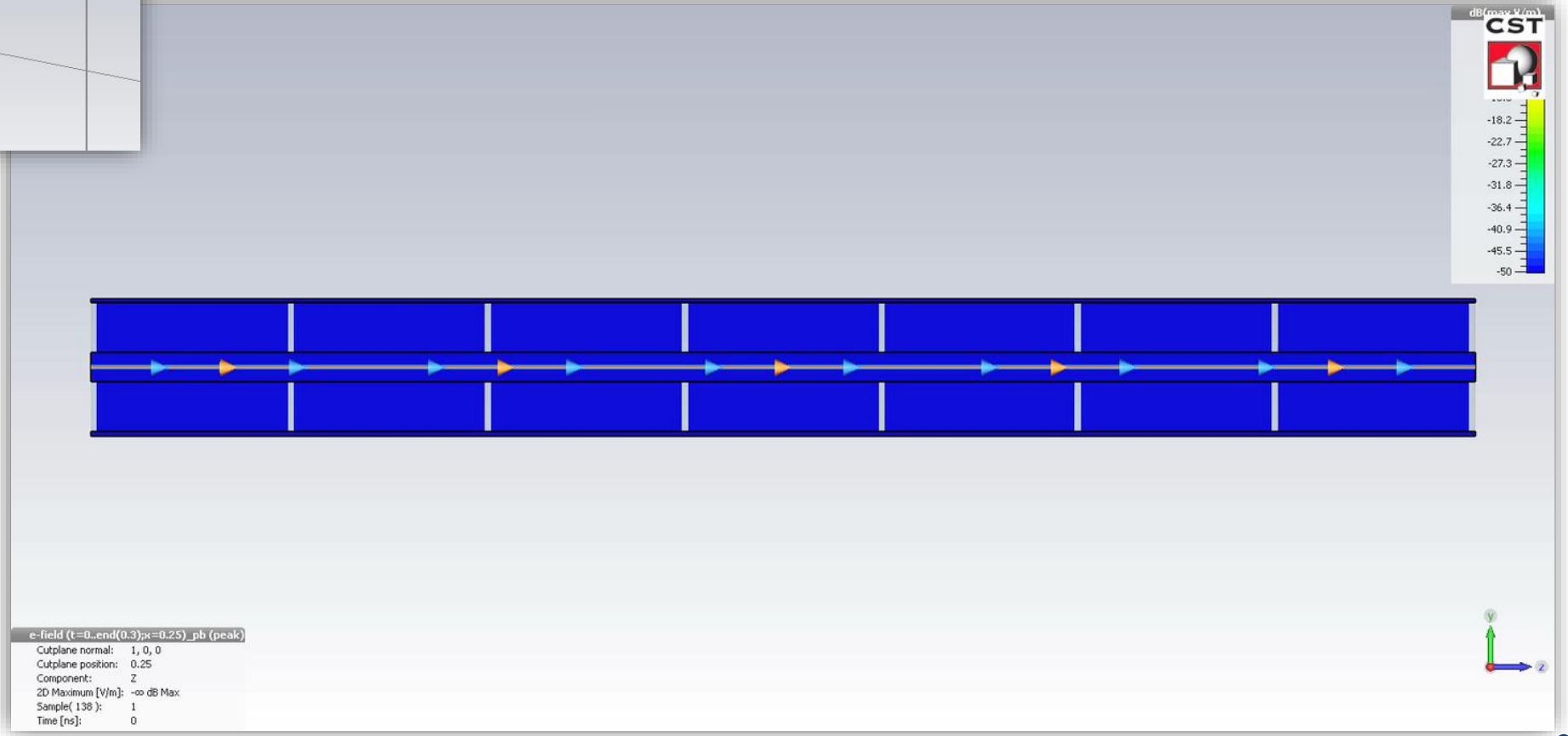

Examples: Serigraphy impact

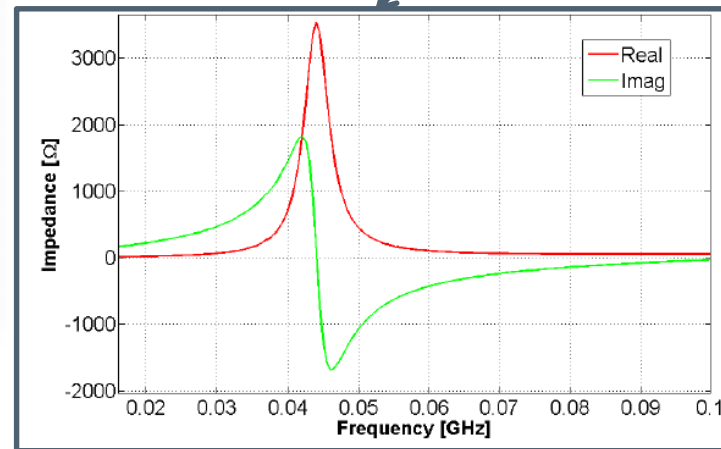
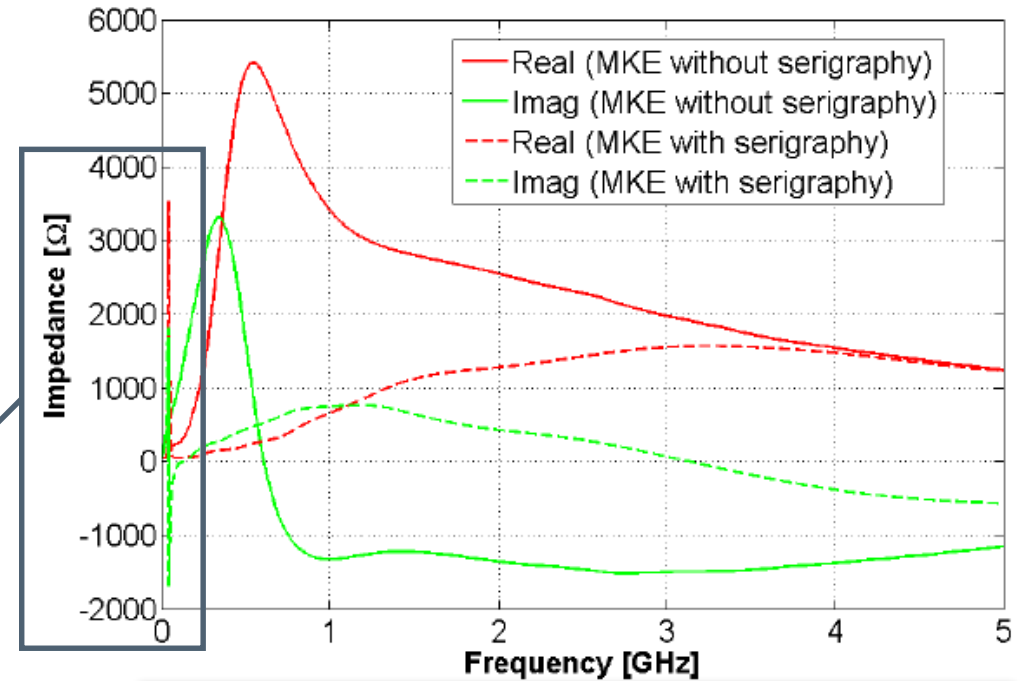
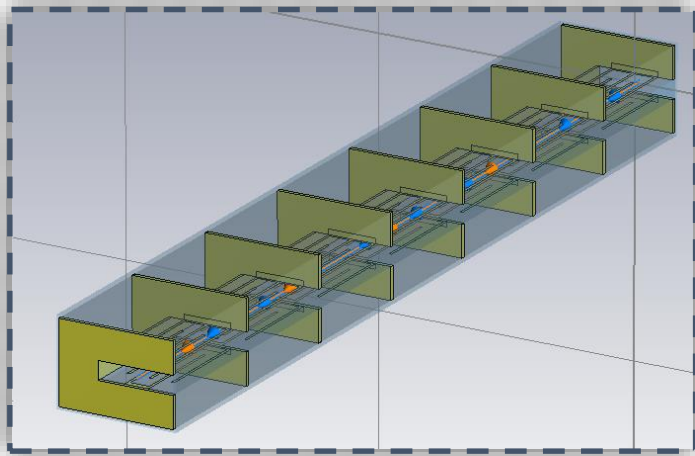
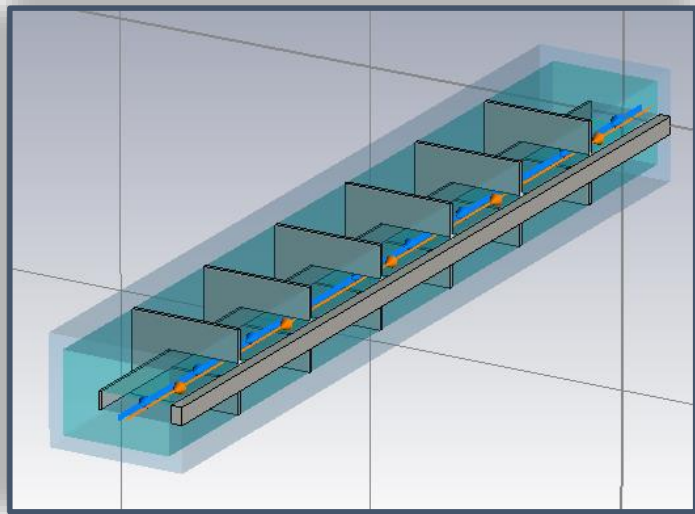

Solid lines – no serigraphy /
Dashed lines – serigraphy

Serigraphy:

1. Reduces the broad-band contribution
2. Introduces resonance peak around 44 MHz
3. **Less overall heating of device**

Examples: Serigraphy impact

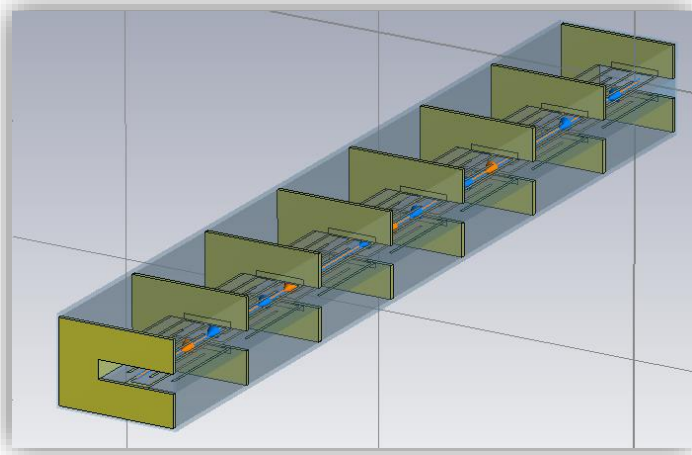
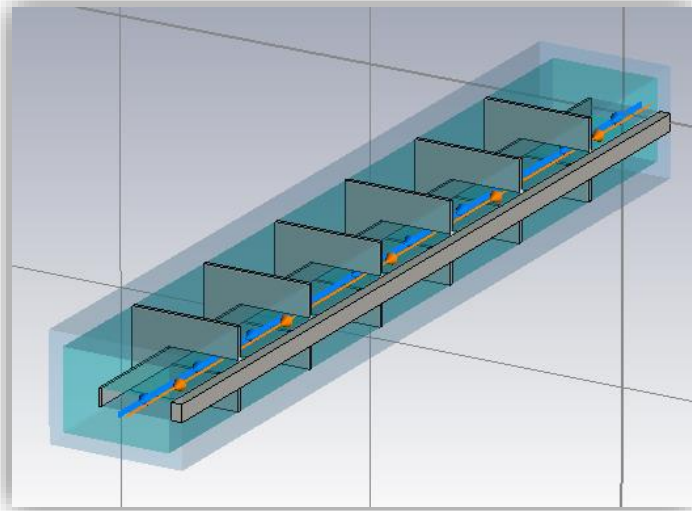

~ 17h run with 25 ns beams at
26 GeV after technical stop



Timeseries Chart between 2012-04-25 12:48:00.000 and 2012-04-26 12:48:00.000 (LOCAL_TIME)

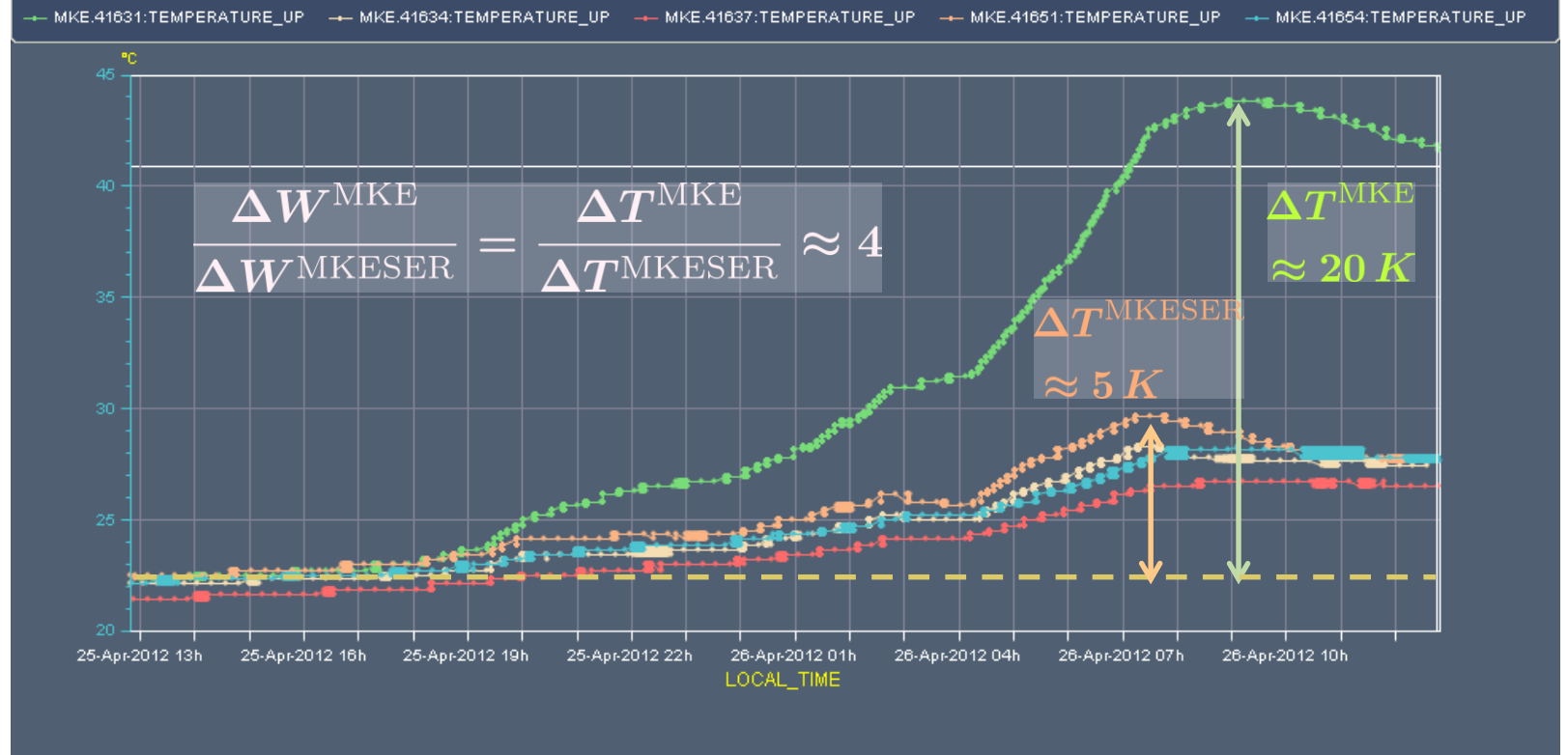

How are wakes and impedances computed?

- **Analytical or semi-analytical** approach, when geometry is simple (or simplified)
 - Solve Maxwell's equations with the correct source terms, geometries and boundary conditions up to an advanced stage (e.g. resistive wall for axisymmetric chambers)
 - Find closed expressions or execute the last steps numerically to derive wakes and impedances
- **Numerical approach**
 - Different codes have been developed over the years to solve numerically Maxwell's equations in arbitrarily complicated structures
 - Examples are CST Studio Suite (Particle Studio, Microwave Studio), ABCI, GdFidL, HFSS, ECHO2(3)D. Exhaustive list can be found from the program of the [ICFA mini-Workshop on "Electromagnetic wake fields and impedances in particle accelerators"](#), Erice, Sicily, 23-28 April, 2014
- **Bench measurements** based on transmission/reflection measurements with stretched wires
 - Seldom used independently to assess impedances, usefulness mainly lies in that they can be used for validating 3D EM models for simulations



We have seen how the impedance of a device can have an **impact on the machine environment** and cause, for example, **beam induced heating**. This can lead to outgassing or damage of a device. Therefore, devices need to be carefully designed in order to minimize their impedance.

Impedances also have a **direct impact on a passing beam**. This can lead to impedance induced **beam instabilities**. We will now first understand the basic concept and mechanism of beam instabilities.

- Part 3: Wake fields and impedances – impacts
 - Longitudinal and transverse wake fields and impedances
 - Panofsky-Wenzel theorem
 - Examples of analytically expressible wake functions and impedances
 - Impact of wake fields and impedance on the accelerator environment
 - Description of a coherent beam instability and the instability loop

Why worry about beam instabilities?

- Why study beam instabilities?
 - The onset of a beam instability usually determines the maximum beam intensity that a machine can store/accelerate (performance limitation)
 - Understanding the type of instability limiting the performance, and its underlying mechanism, is essential because it:
 - Allows identifying the source and possible measures to mitigate/suppress the effect
 - Allows dimensioning an active feedback system to prevent the instability

What is a beam instability?

- A beam becomes unstable when a **moment of its distribution** exhibits an **exponential growth** (e.g. mean positions, standard deviations, etc.), resulting into beam loss or emittance growth!

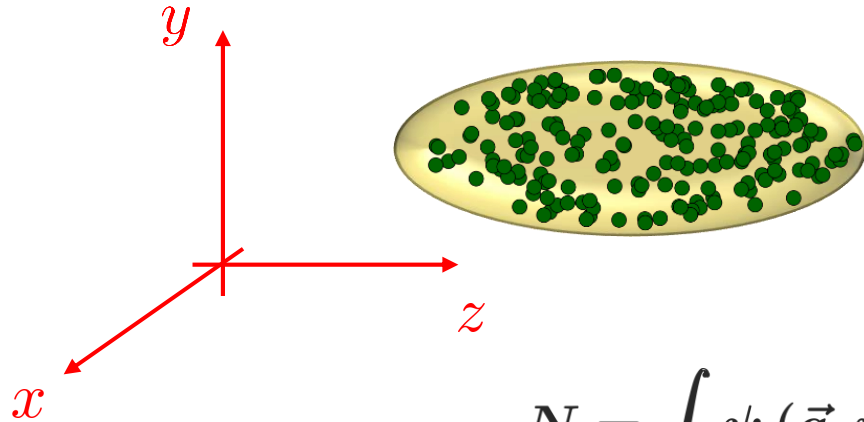

Single particle probability density function: $\psi(\vec{q}, \vec{p}, t)$

The probability P (at any time t) to find a given particle at state (\vec{q}, \vec{p}) :

$$P|_{(\vec{q}, \vec{p}); t} = \frac{1}{N} \psi(\vec{q}, \vec{p}, t)$$

Normalization: $1 = \frac{1}{N} \int \psi(\vec{q}, \vec{p}, t) d\vec{q}d\vec{p}$

$$N = \int \psi(\vec{q}, \vec{p}) d\vec{q}d\vec{p}$$

$$\langle x \rangle = \frac{1}{N} \int x \cdot \psi(\vec{q}, \vec{p}) d\vec{q}d\vec{p}$$

$$\sigma_x^2 = \frac{1}{N} \int (x - \langle x \rangle)^2 \cdot \psi(\vec{q}, \vec{p}) d\vec{q}d\vec{p}$$

and similar definitions for $\langle y \rangle, \sigma_y, \langle z \rangle, \sigma_z$

Examples: broadband resonator

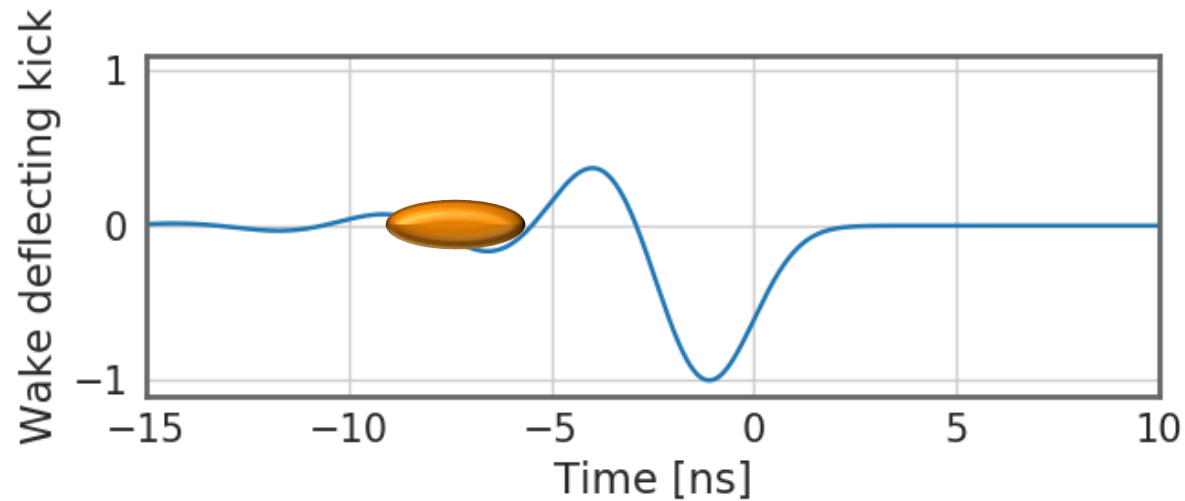
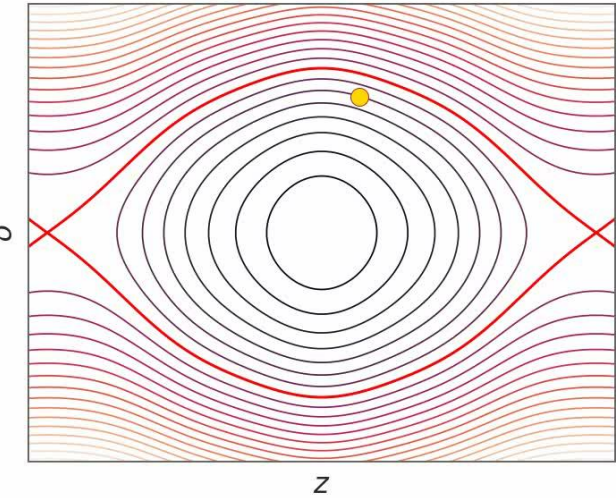
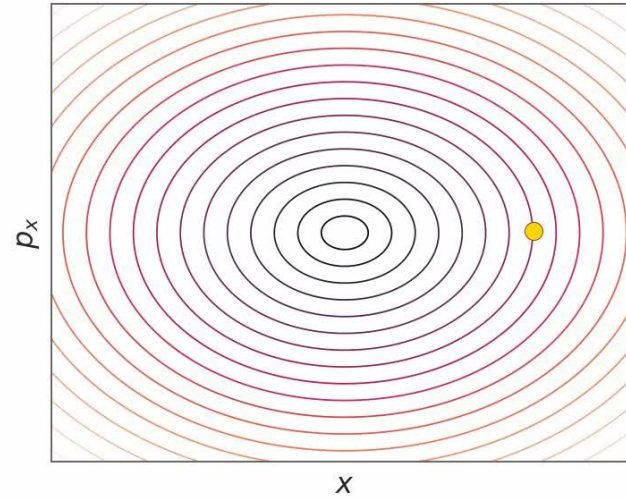
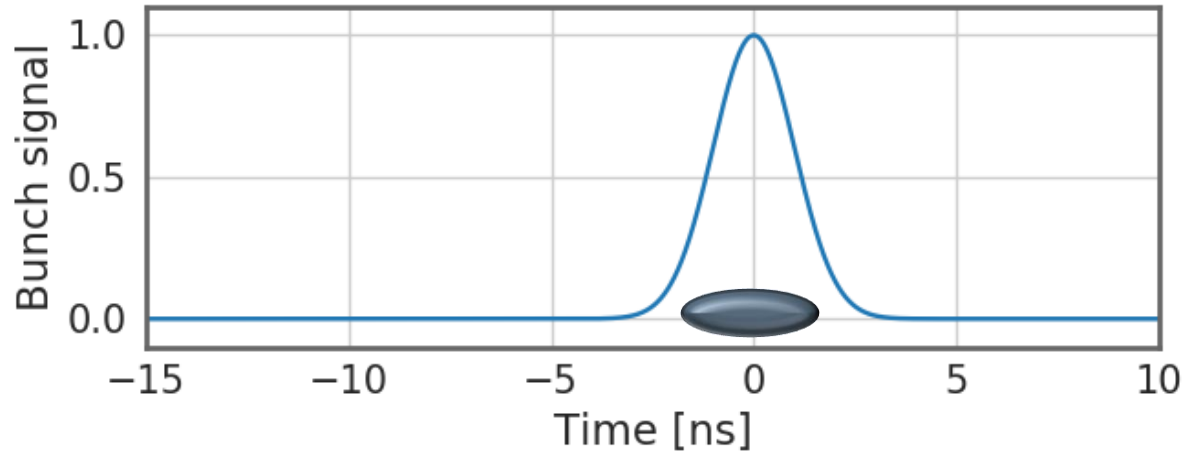

If betatron and synchrotron motion and wakefields **manage to synchronize** such that they get into resonance, a distinct bunch oscillation pattern will be excited – a so called **bunch mode**. The coherent bunch/beam signal will **grow exponentially**. This can be either a **single bunch mode**...

Examples: narrowband resonator

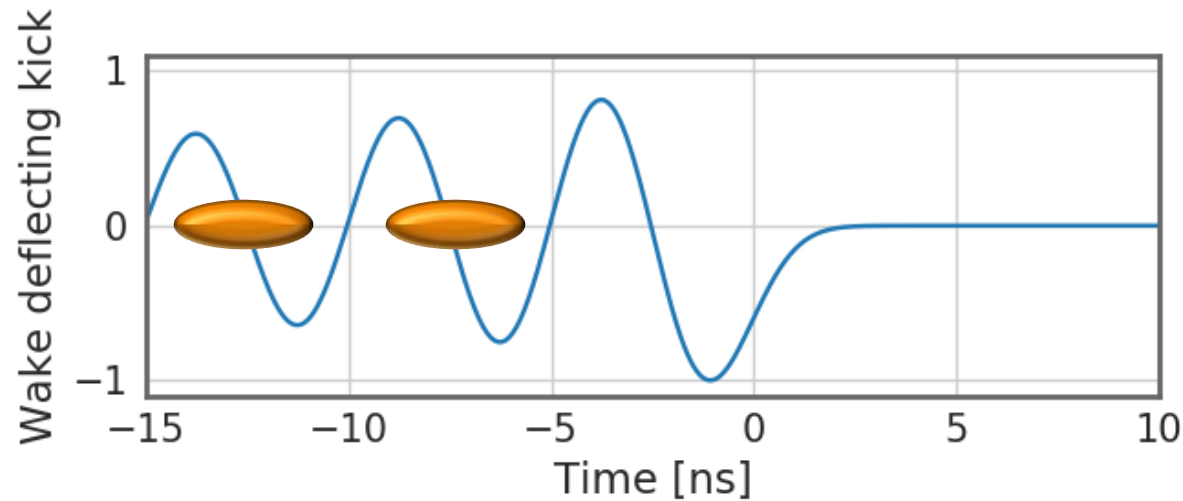
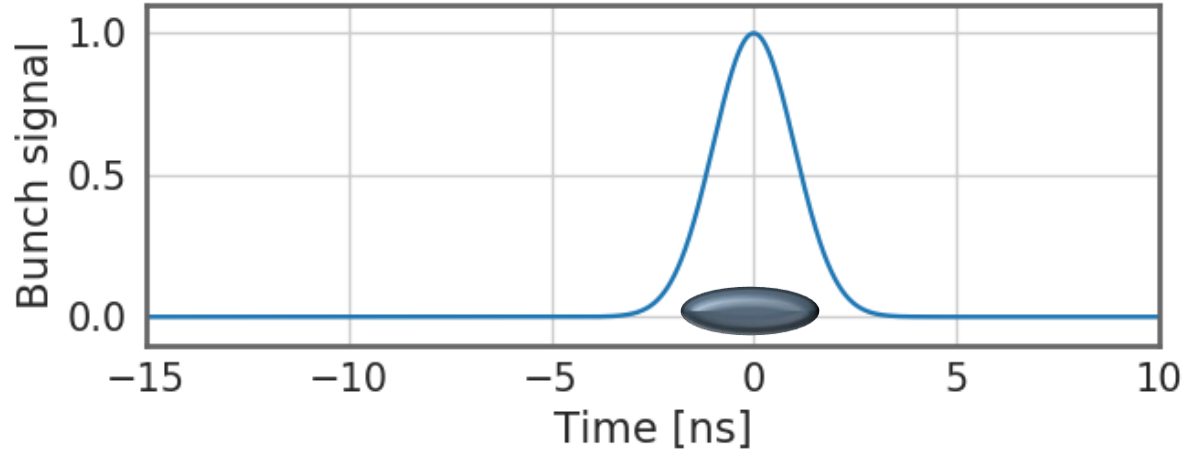

If betatron and synchrotron motion and wakefields **manage to synchronize** such that they get into resonance, a distinct bunch oscillation pattern will be excited – a so called **bunch mode**. The coherent bunch/beam signal will **grow exponentially**.

This can be either a **single bunch mode**...

... or a **coupled bunch mode**

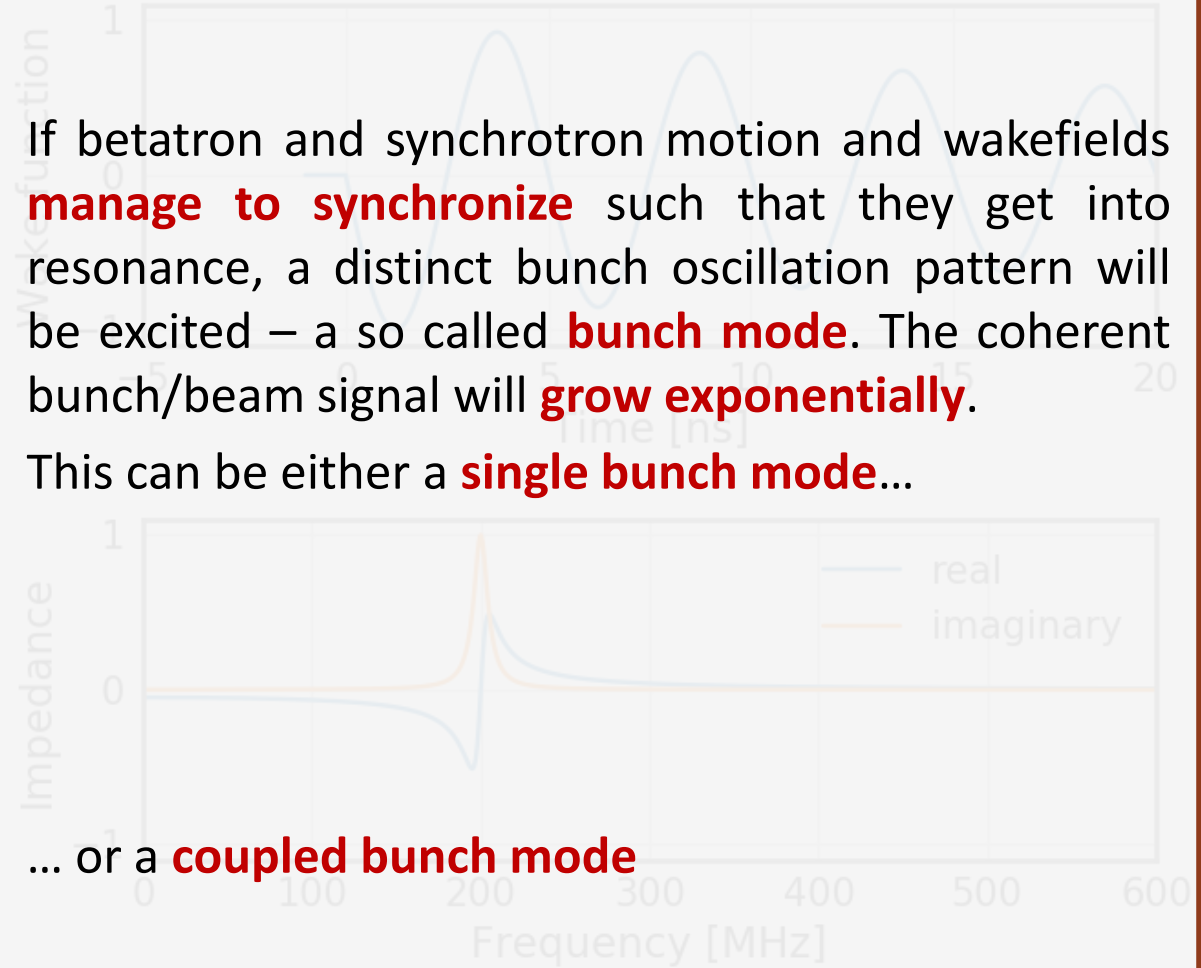

Examples: narrowband resonator

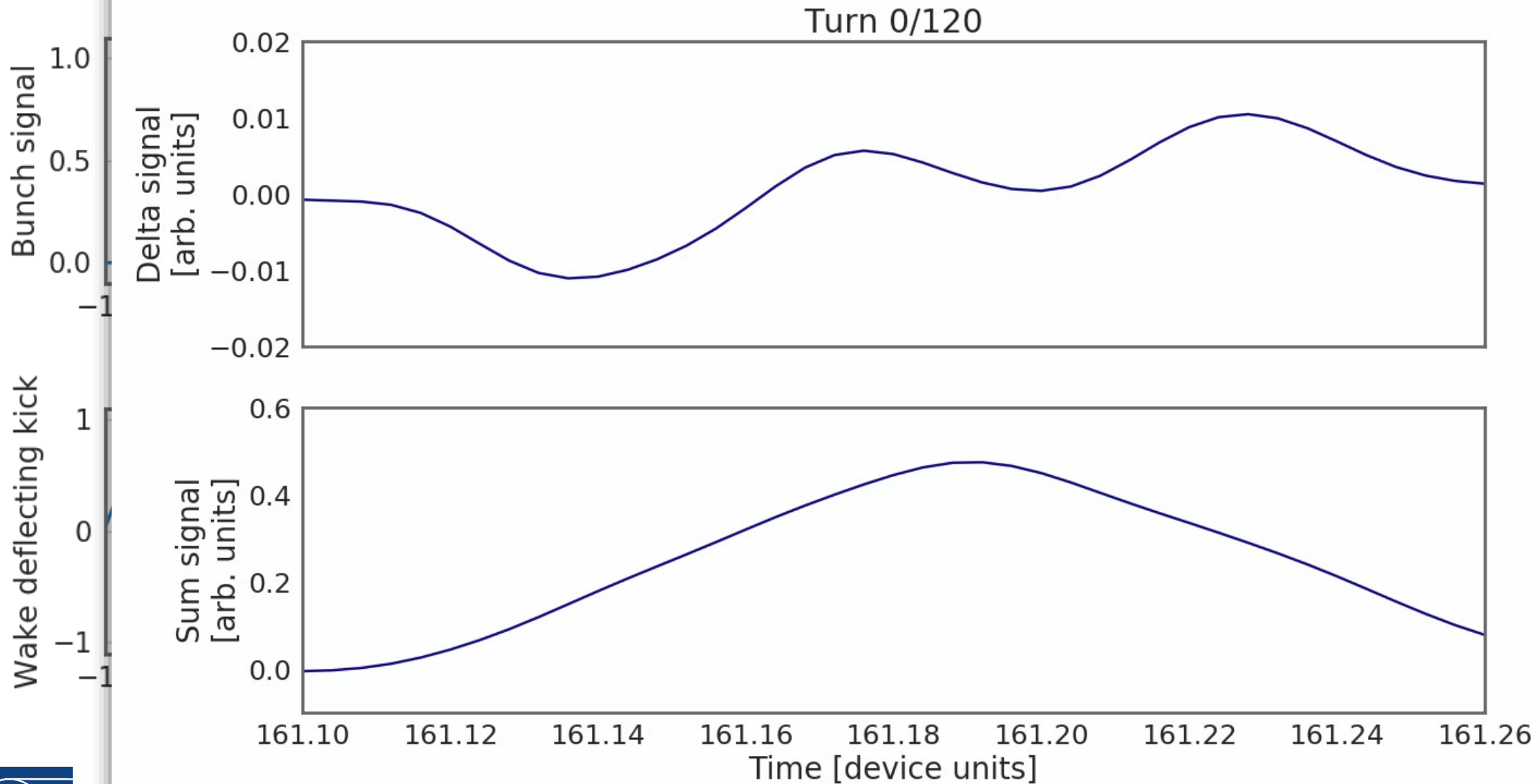

Wakefields
get into
resonance
then will
be coherent

20

Binary

600

What is a beam instability?

- A beam becomes unstable when a **moment of its distribution** exhibits an **exponential growth** (e.g. mean positions, standard deviations, etc.), resulting into beam loss or emittance growth!

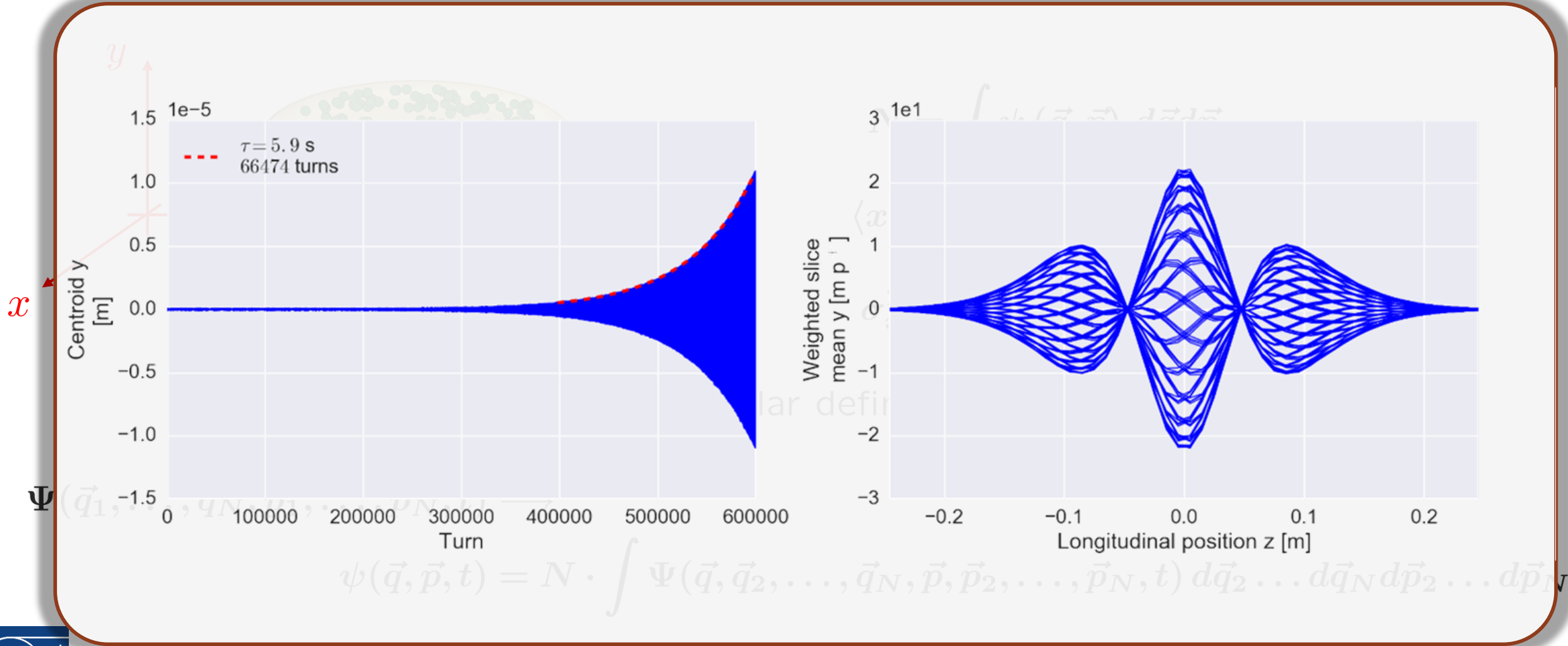

$$\psi(\vec{q}, \vec{p}, t) = N \cdot \int \Psi(\vec{q}, \vec{q}_2, \dots, \vec{q}_N, \vec{p}, \vec{p}_2, \dots, \vec{p}_N, t) d\vec{q}_2 \dots d\vec{q}_N d\vec{p}_2 \dots d\vec{p}_N$$

What is a beam instability?

- A beam becomes unstable when a **moment of its distribution** exhibits an **exponential growth** (e.g. mean positions, standard deviations, etc.), resulting into beam loss or emittance growth!

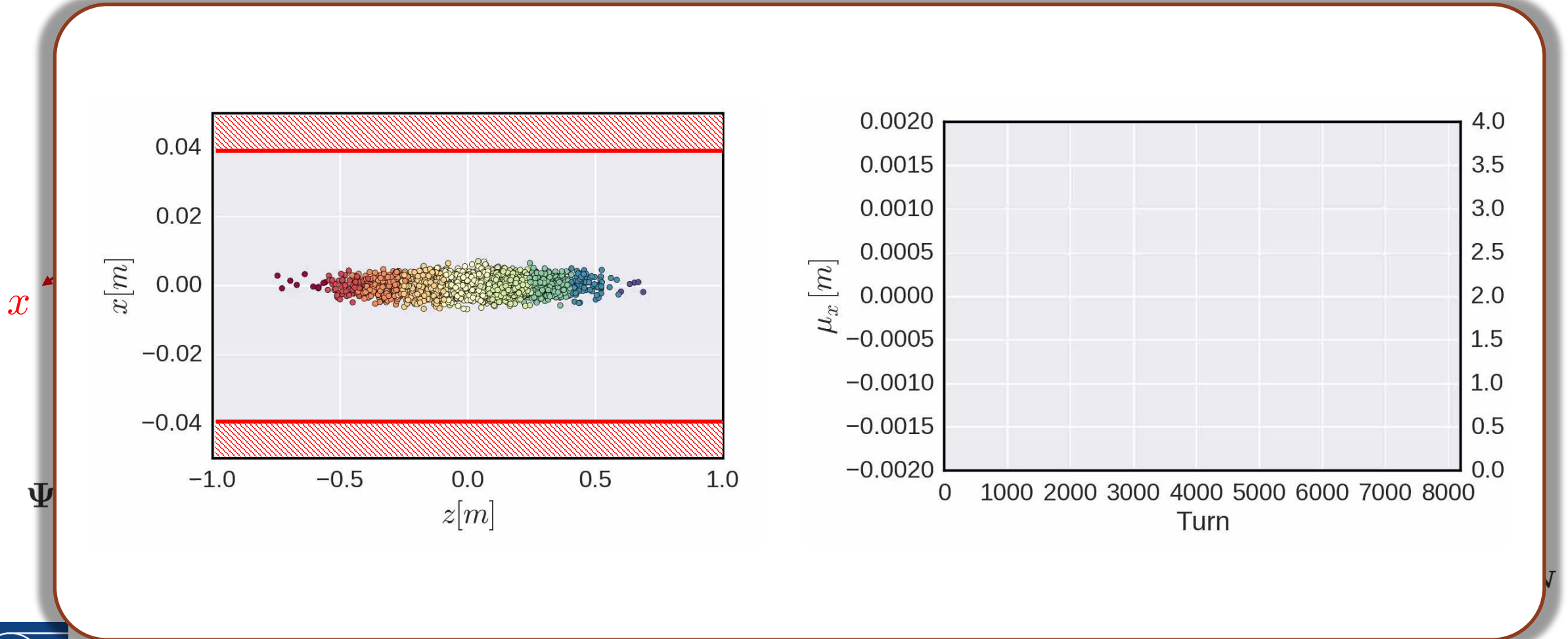

The instability loop

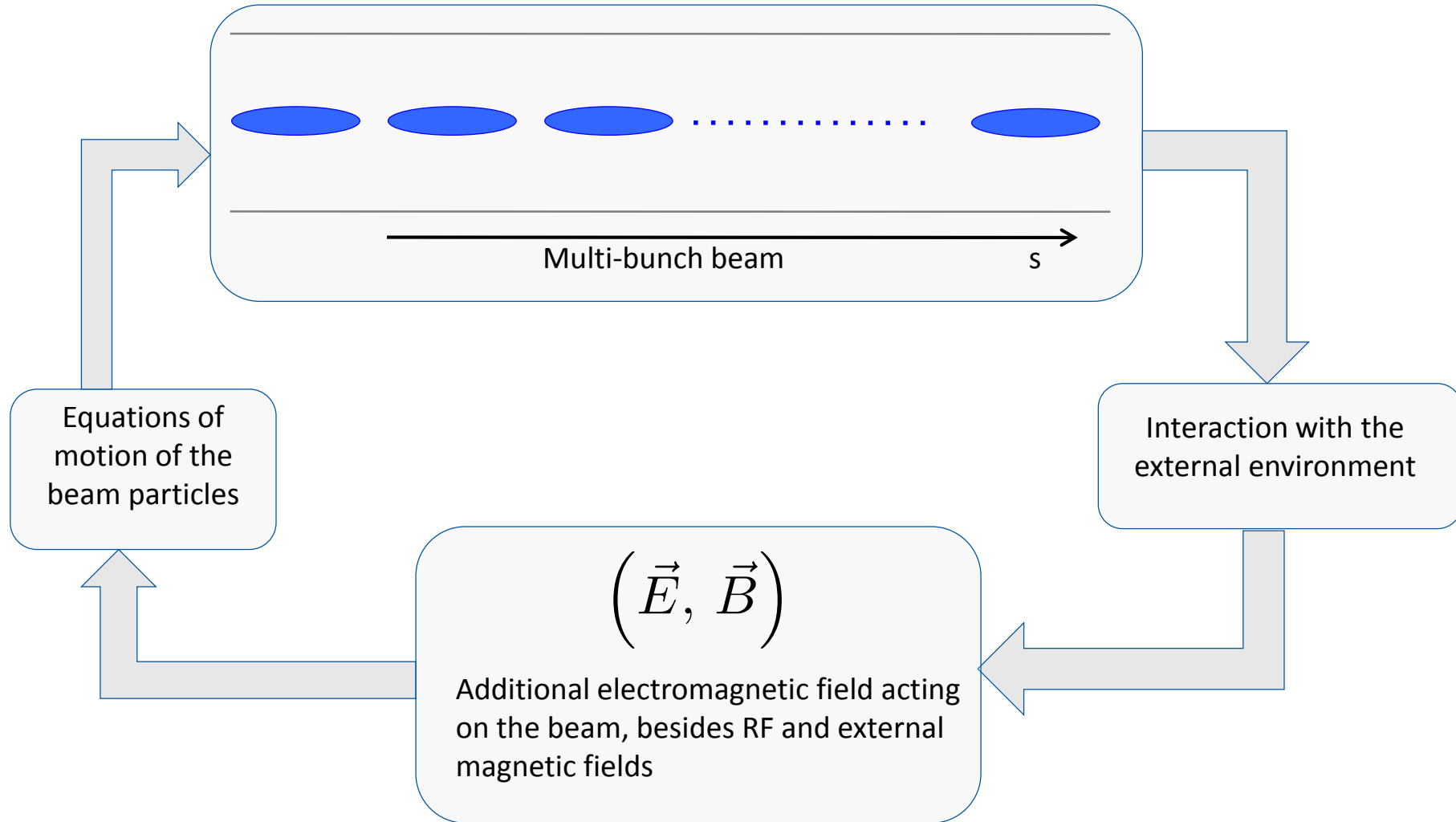

The instability loop

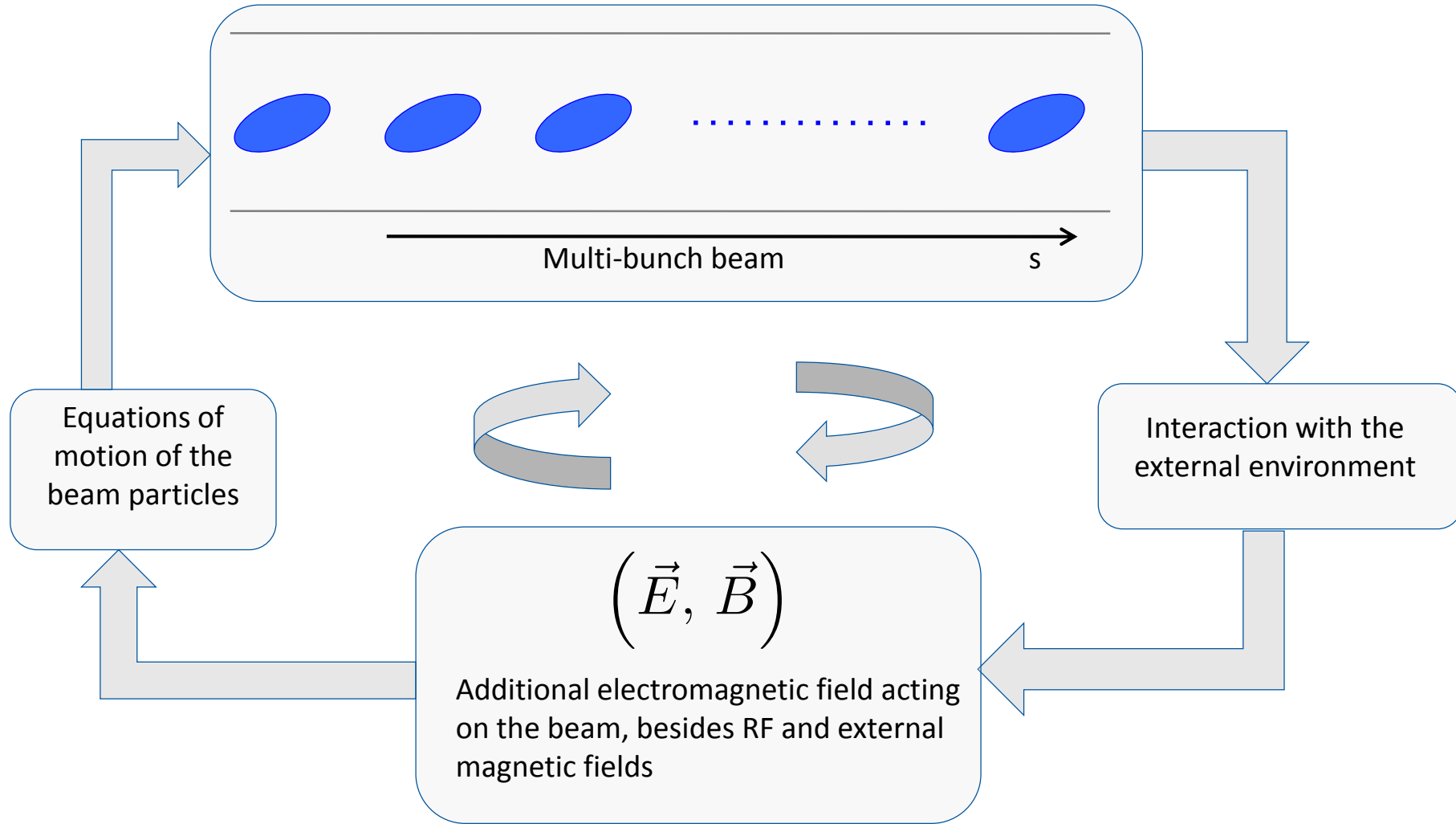

When the loop closes, either the beam will find a new stable equilibrium configuration ...

The instability loop

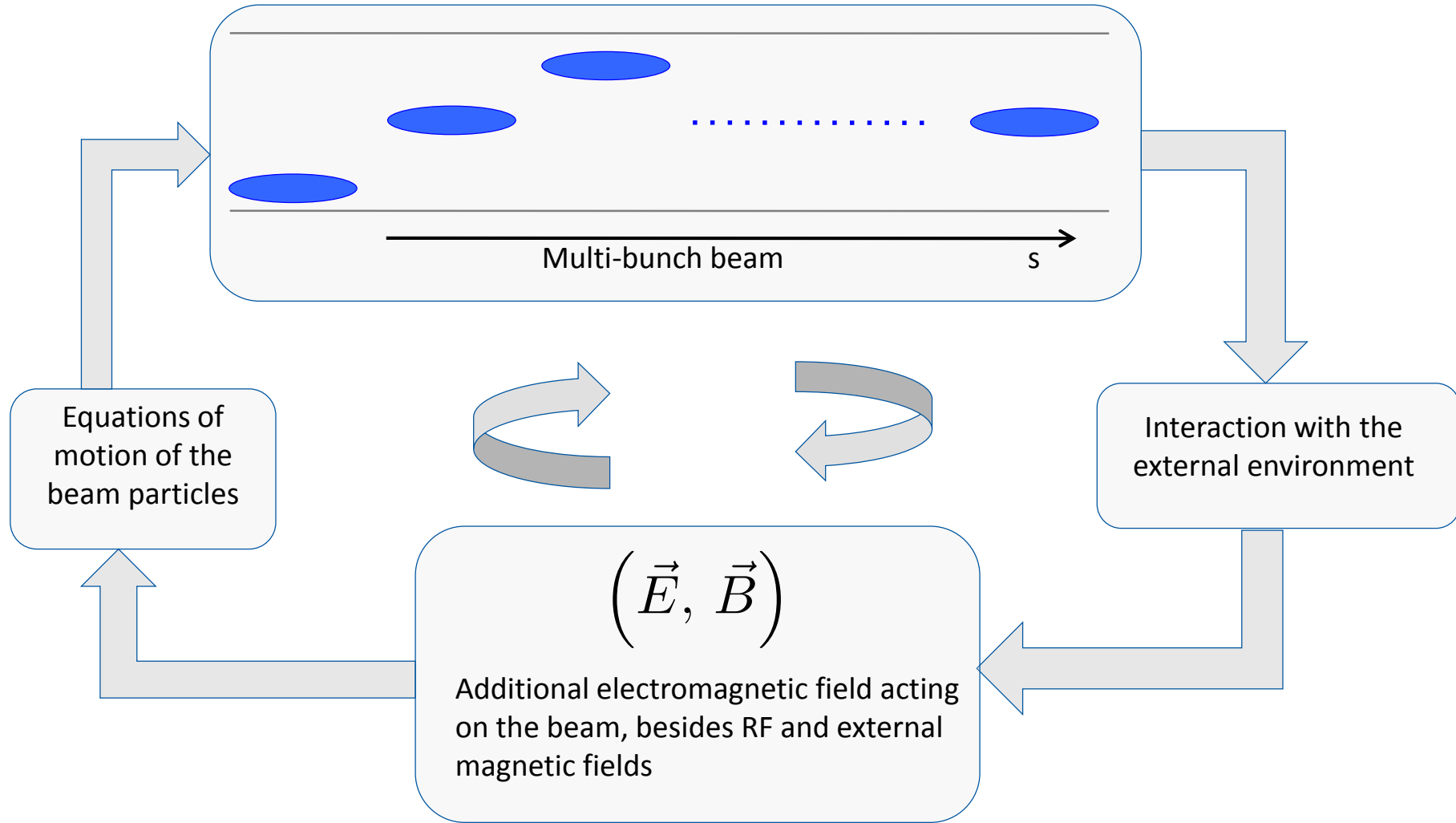

... or it might develop an instability along the bunch train ...

The instability loop

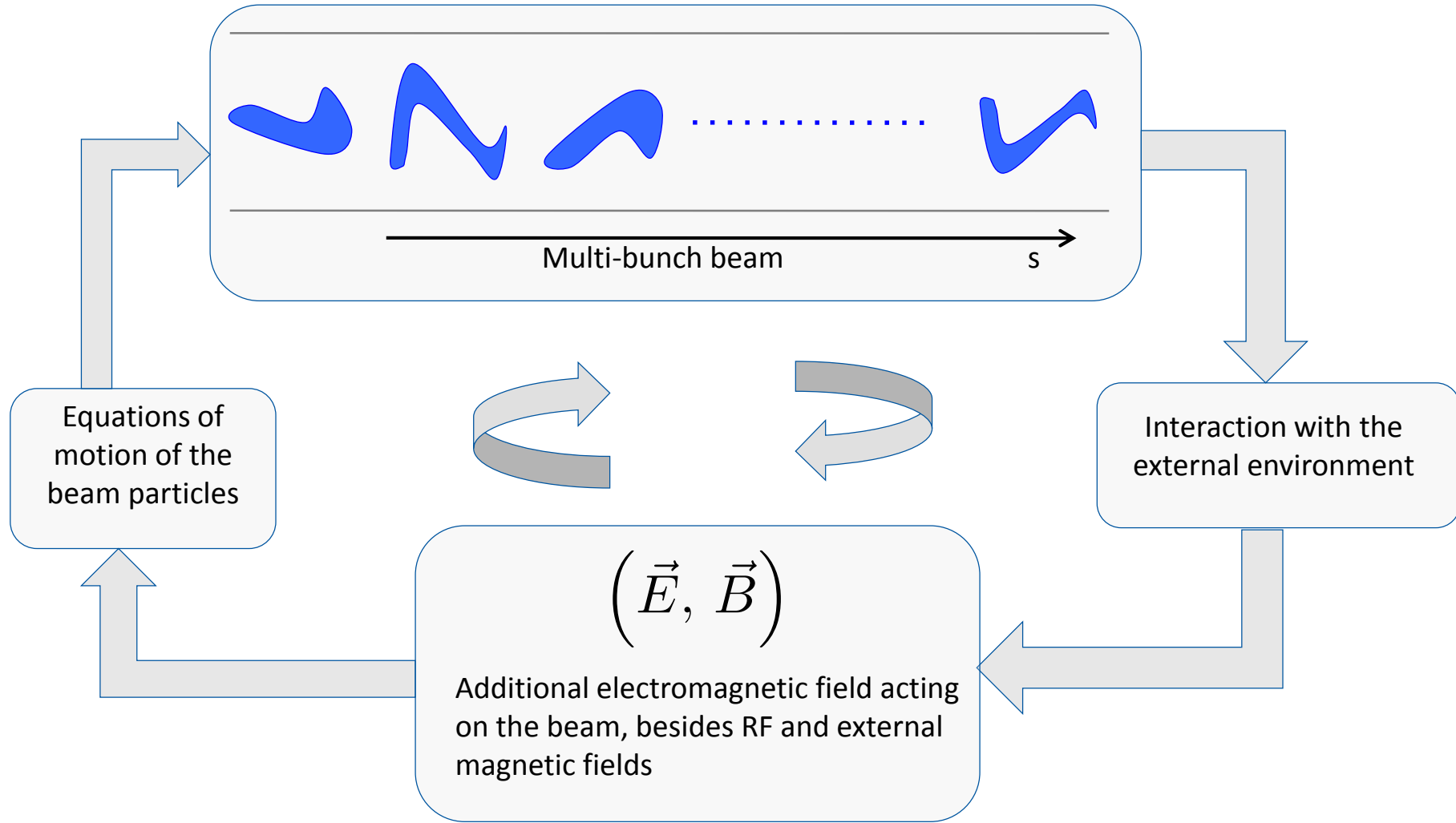

... or also an instability affecting different bunches independently of each other

The instability loop – knobs to preserve beam stability...

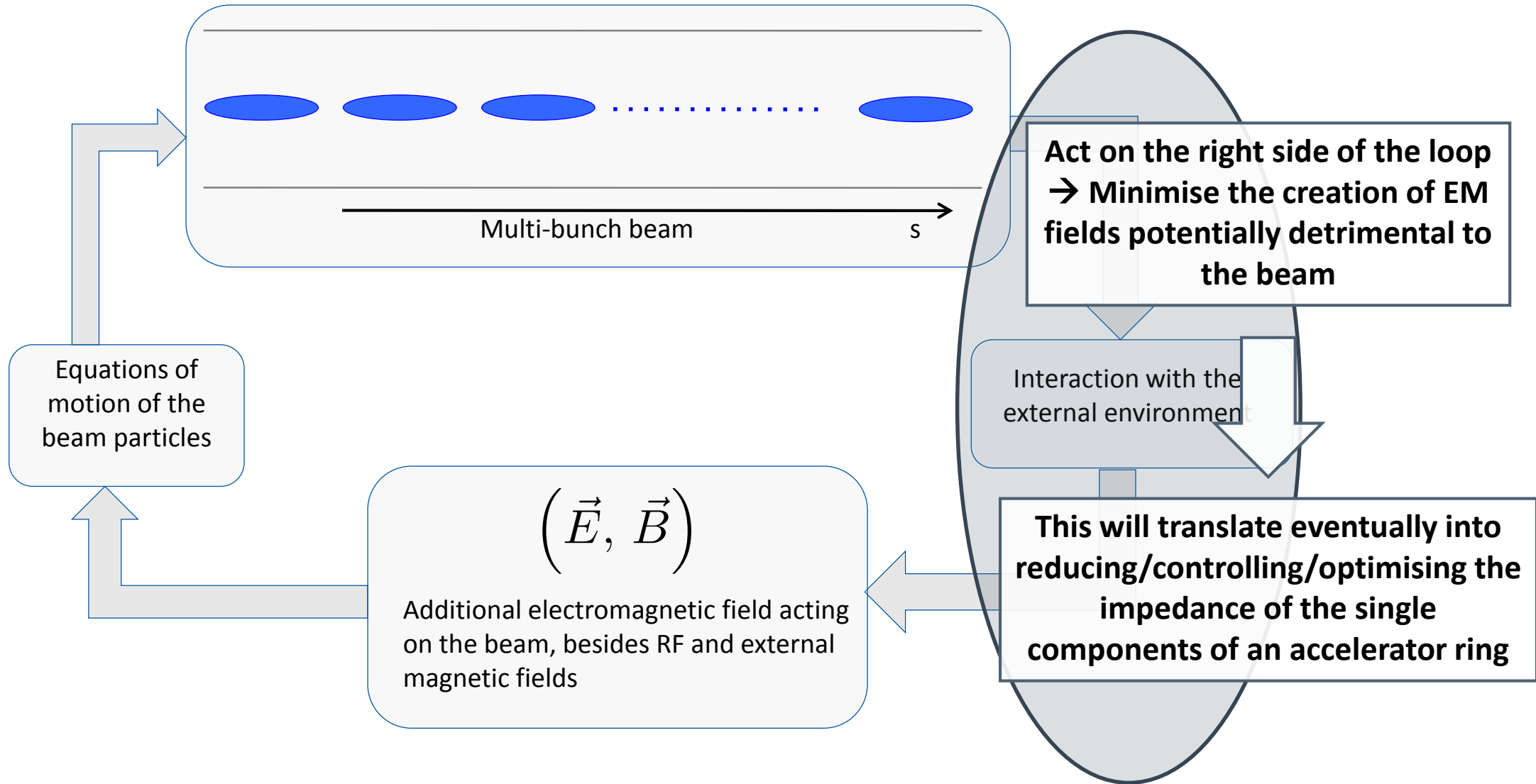

The instability loop – knobs to preserve beam stability...

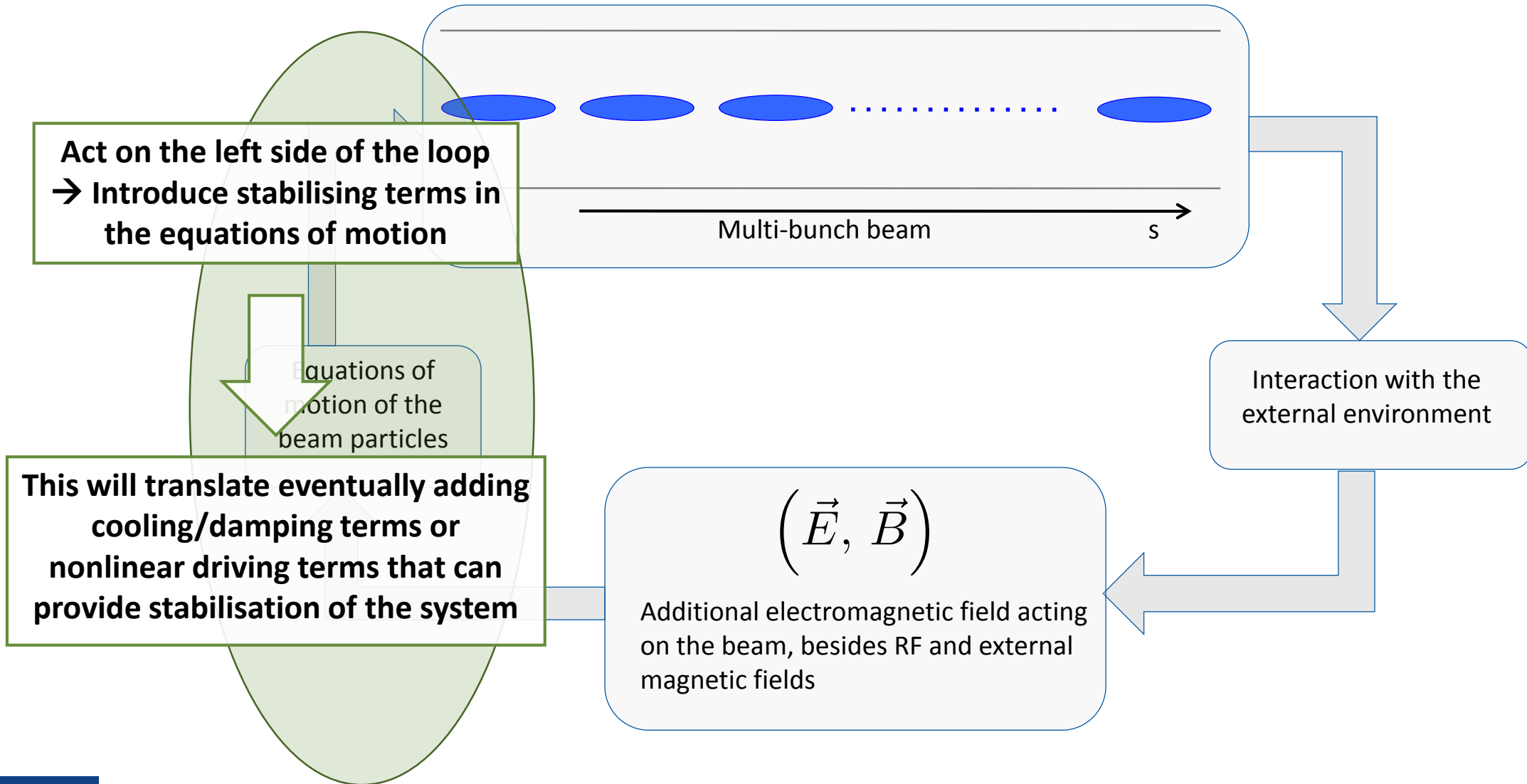

The instability loop – knobs to preserve beam stability...

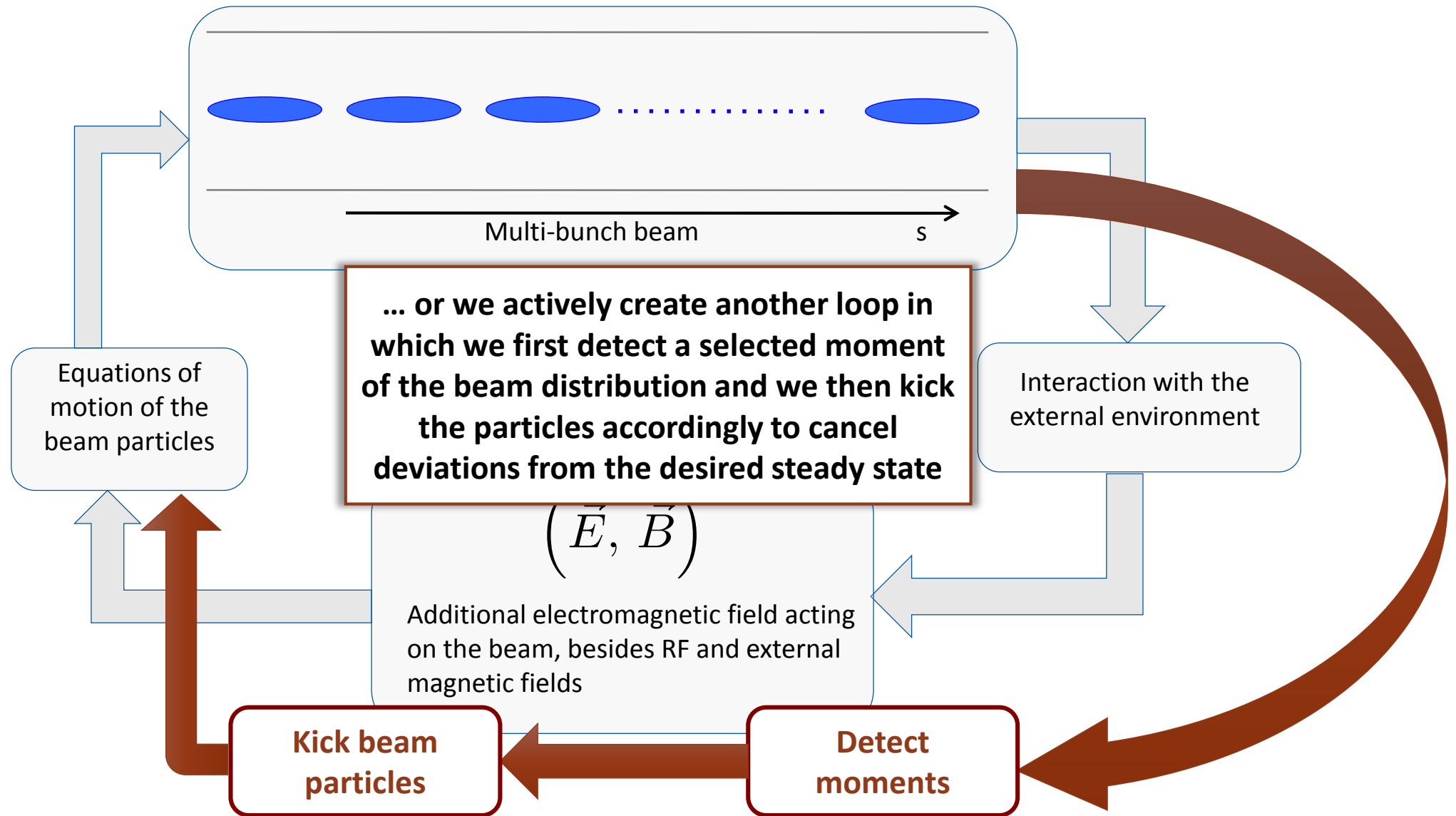



We have seen some examples of analytically expressible wake fields and impedances, namely **resonator and resistive wall wakes**. We have learned that impedances can have a **detrimental impact** on both the **machine environment** as well as **the beam itself**. In the first case, impedances can lead to **beam induced heating**, in the latter to **coherent beam instabilities**.

A careful design of machine elements to **minimize the impedance** is therefore necessary.

After having introduced the instability loop, in the next lecture we will be looking more in detail **at examples of different types of instabilities**.

- Part 3: Wake fields and impedances – impacts
 - Longitudinal and transverse wake fields and impedances
 - Panofsky-Wenzel theorem
 - Examples of analytically expressible wake functions and impedances
 - Impact of wake fields and impedance on the accelerator environment
 - Description of a coherent beam instability and the instability loop

End part 3





www.cern.ch

Backup slides

Longitudinal wake function

$$W_{\parallel}(z) = -\frac{\Delta E_2}{q_1 q_2} \xrightarrow[q_2 \rightarrow q_1]{z \rightarrow 0} W_{\parallel}(0) = -\frac{\Delta E_1}{q_1^2}$$

- The value of the wake function in $z=0$ is related to the **energy lost by the source particle** in the creation of the wake
- $W_{\parallel}(0) > 0$ since $\Delta E_1 < 0$
- $W_{\parallel}(z)$ is discontinuous in $z=0$ and it vanishes for all $z > 0$ because of the ultra-relativistic approximation

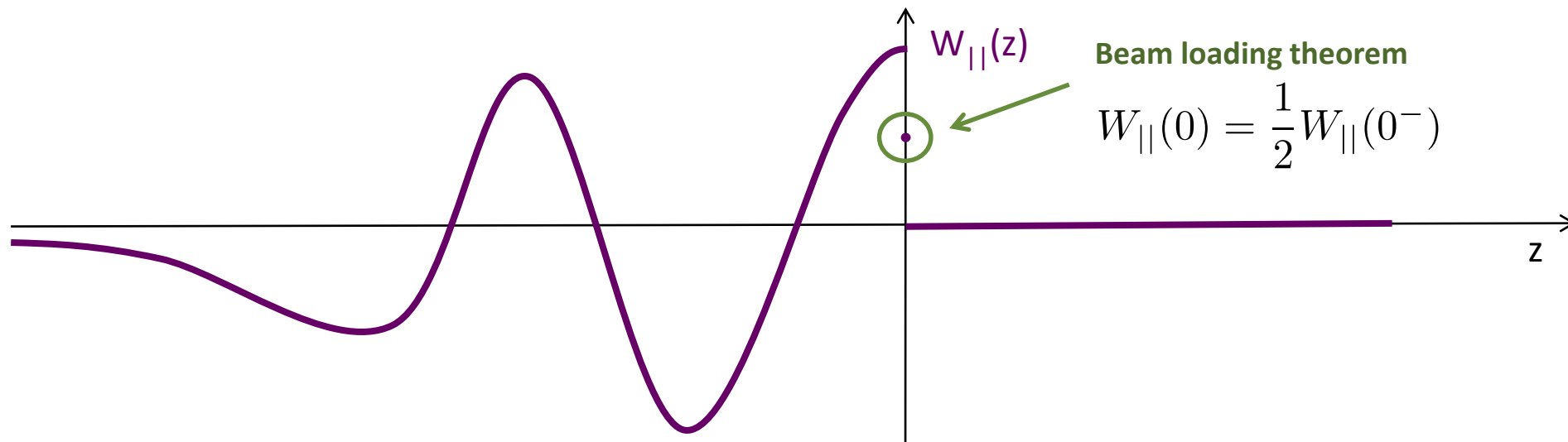

Examples: resistive wall wakes

- Wakefields and/or impedances can be computed by using **Maxwell's equations to compute the impulse response** for a given structure either in time domain or in frequency domain, respectively.
- Some examples of impedances computed in the ultra-relativistic limit are:
 - Resistive wall impedance

$$\frac{Z_{\parallel\text{RW}}(\omega)}{L} = \frac{1}{4\pi b} \sqrt{\frac{2Z_0|\omega|}{\sigma c}} [1 + \text{sgn}(\omega) \cdot i]$$

$$\frac{W_{\parallel\text{RW}}(z)}{L} = -\frac{c}{4\pi b} \sqrt{\frac{Z_0}{\pi\sigma|z|^3}}$$

$$\frac{Z_{\perp\text{RW}}(\omega)}{L} = \frac{1}{4\pi b^3} \sqrt{\frac{2Z_0 c}{\sigma|\omega|}} [1 + \text{sgn}(\omega) \cdot i]$$

$$\frac{W_{\perp\text{RW}}(z)}{L} = -\frac{c}{4\pi b^3} \sqrt{\frac{Z_0}{\pi\sigma|z|}}$$

$$b\chi^{1/3} \ll |z| \ll \frac{b}{\chi}, \text{ with } \chi = \frac{1}{Z_0\sigma b}$$

Examples: resistive wall wakes

Gaussian bunch profile with $\sigma = 1$ ns

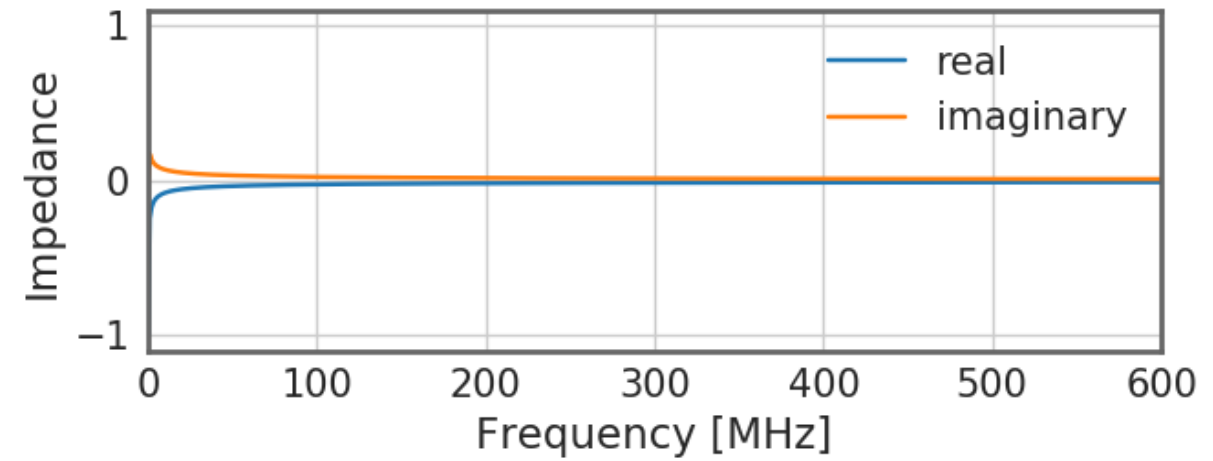
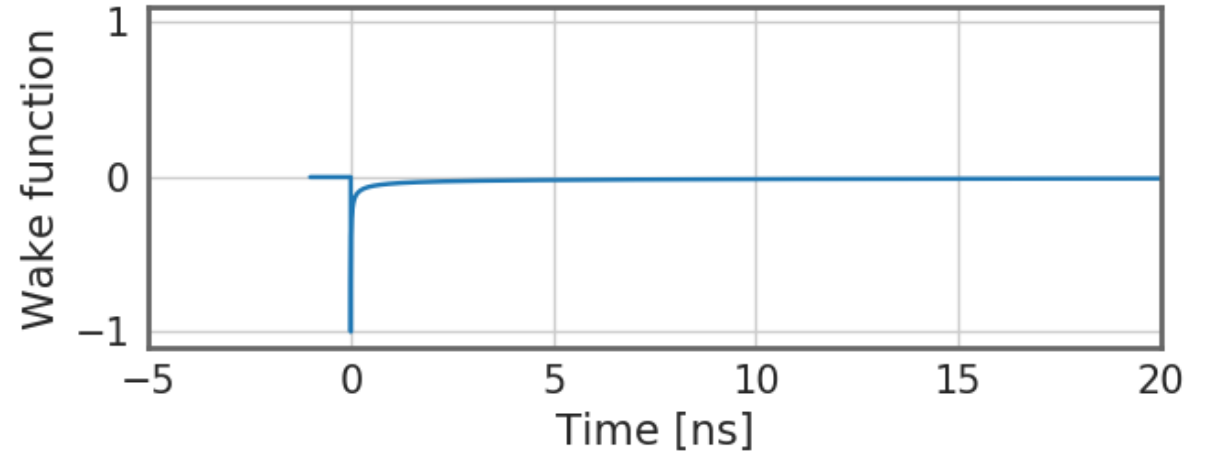

Examples: resistive wall wakes

Gaussian bunch profile with $\sigma = 1$ ns

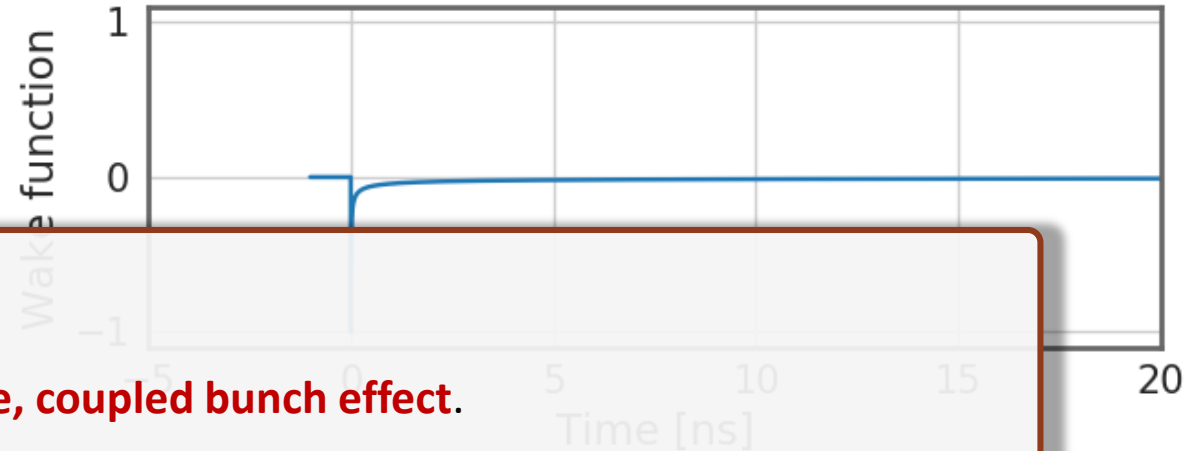
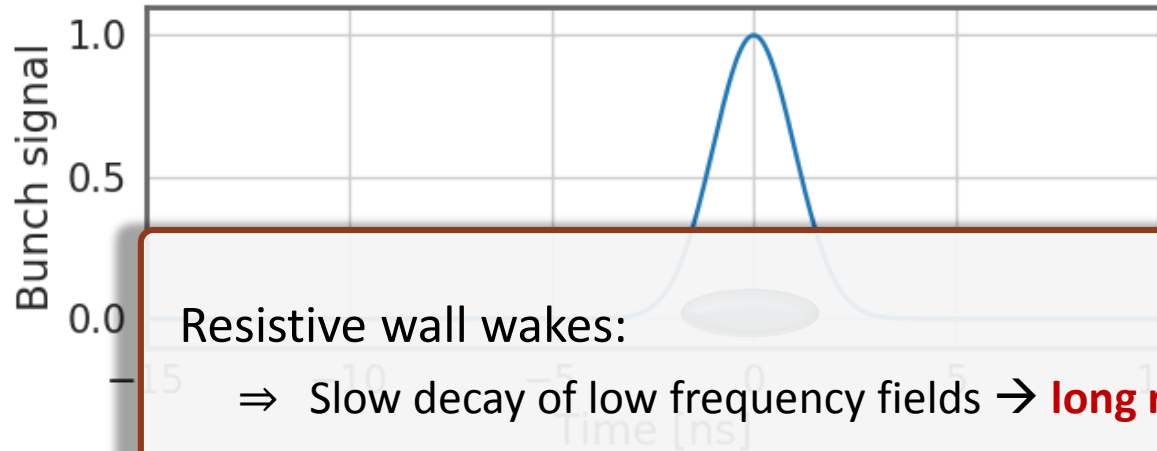

Resistive wall wakes:

⇒ Slow decay of low frequency fields → **long range, coupled bunch effect.**

