

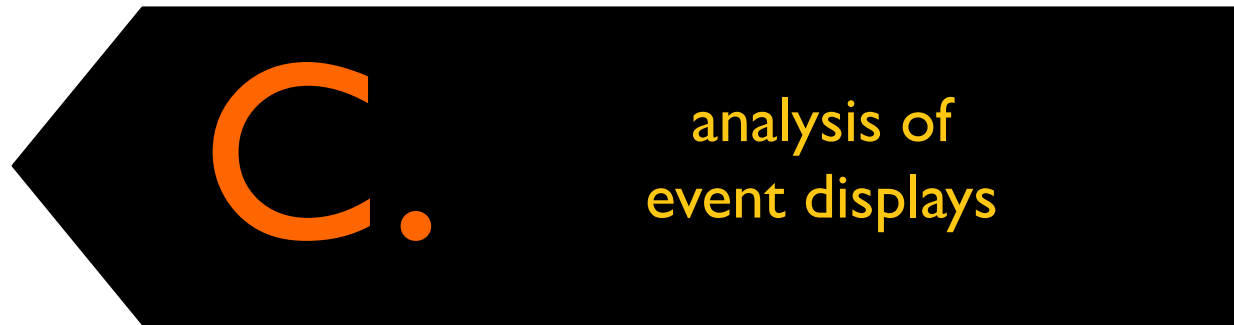

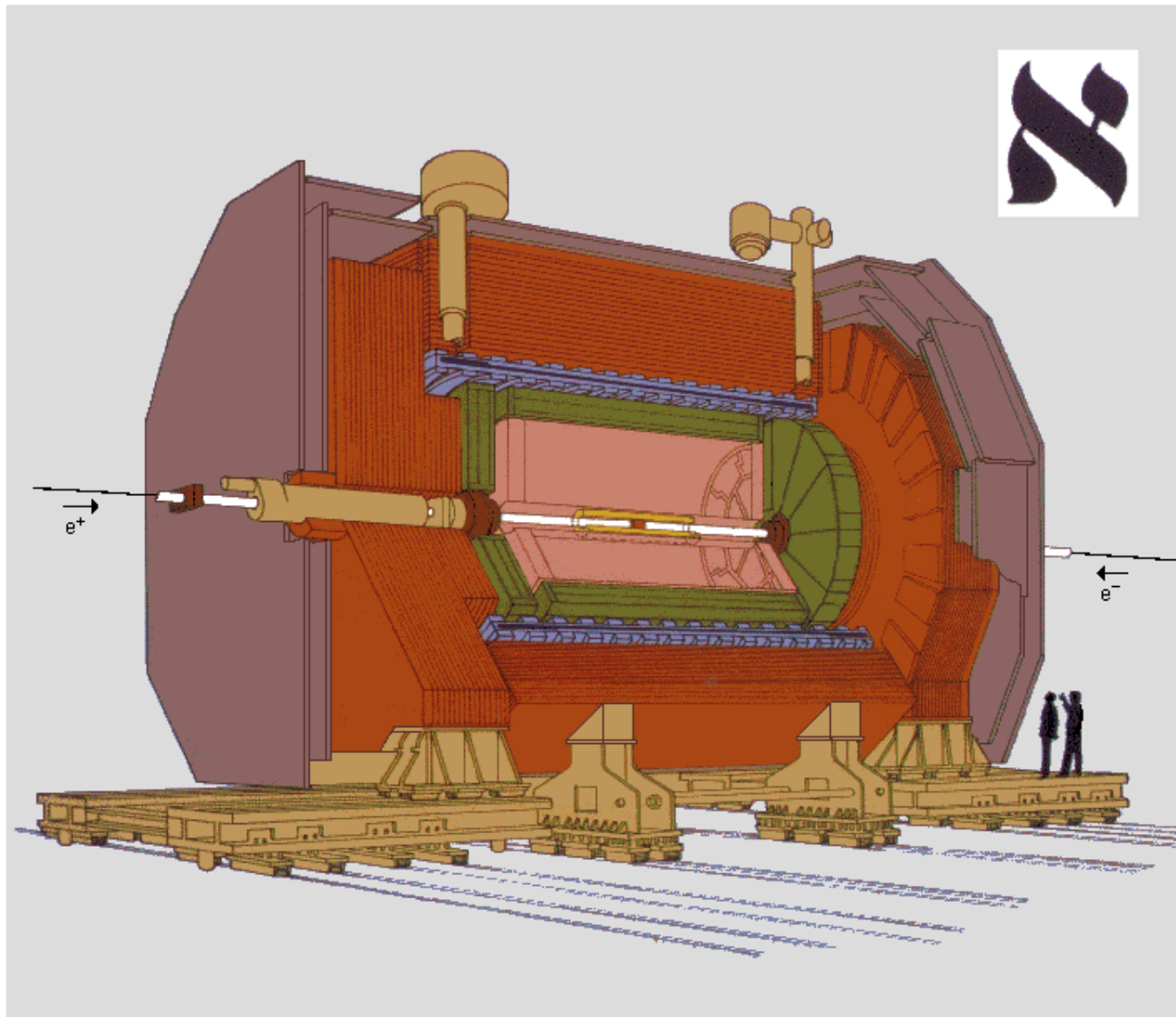





Experimental particle. physics

esipap...
European School of Instrumentation
in Particle & Astroparticle Physics





-  Vertex Detector
-  Inner Tracking Chamber
-  Time Projection Chamber
-  Electromagnetic Calorimeter
-  Superconducting Magnet Coil
-  Hadron Calorimeter
-  Muon Chambers
-  Luminosity Monitors

The ALEPH Detector

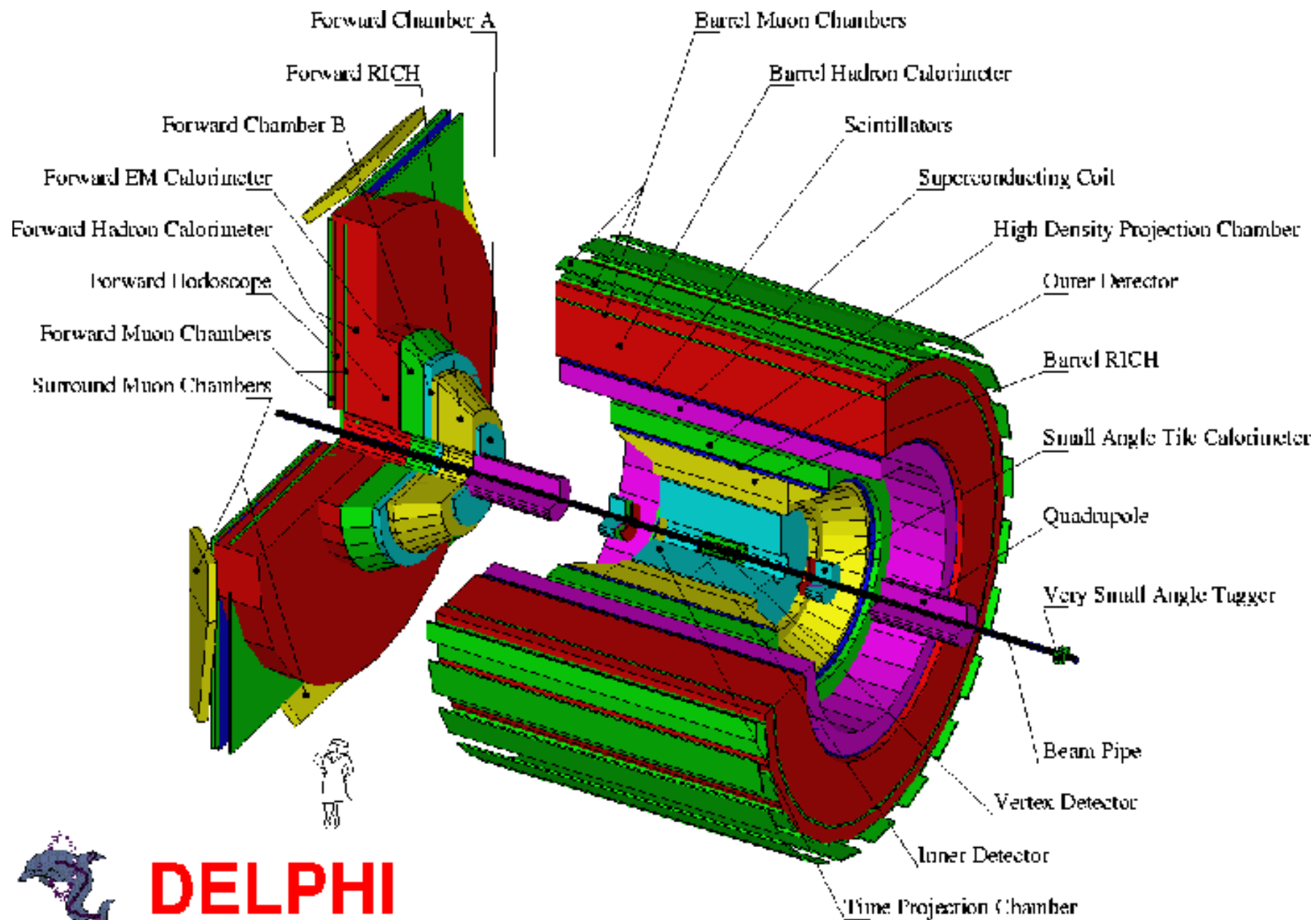

DELPHI

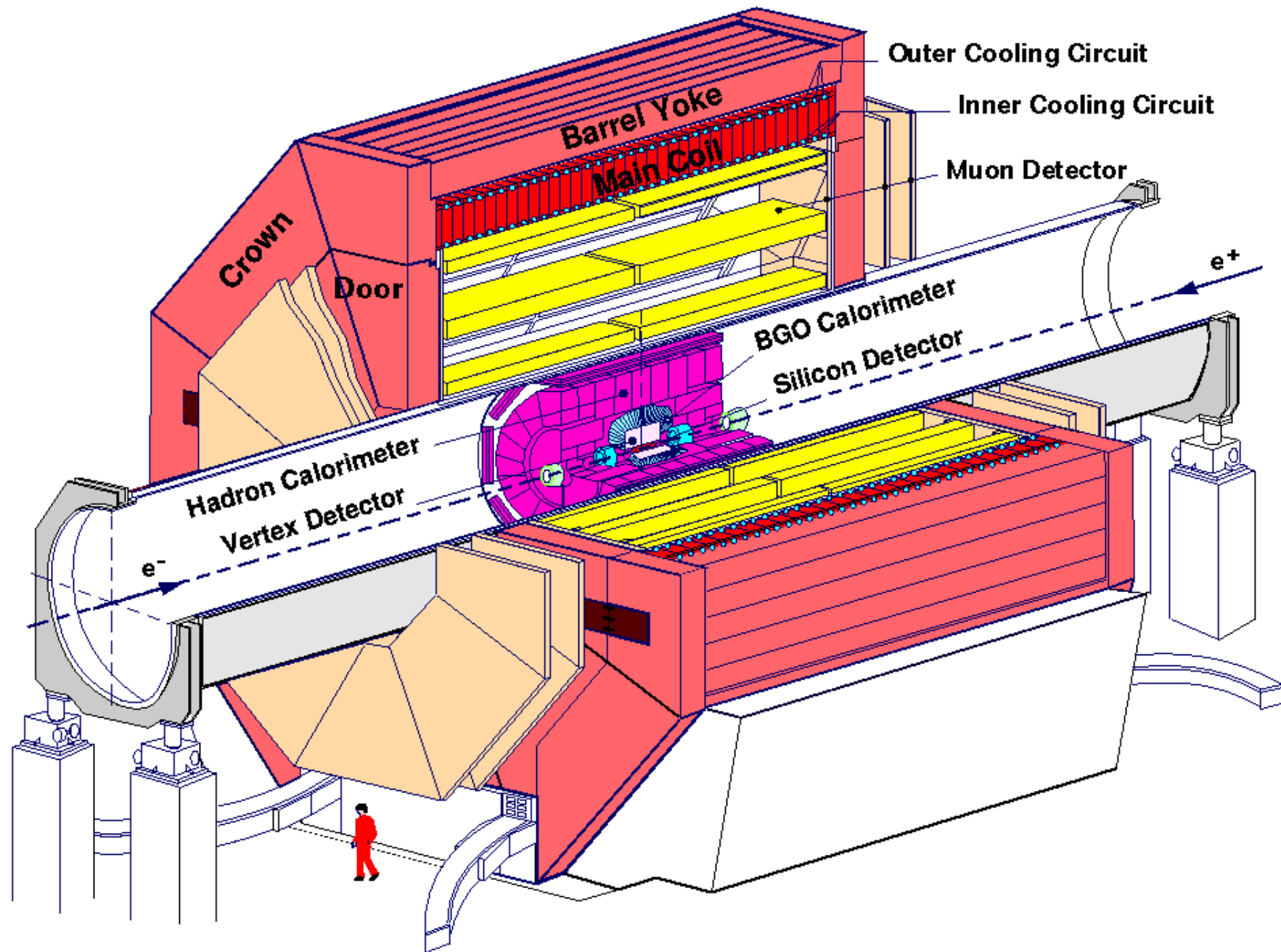

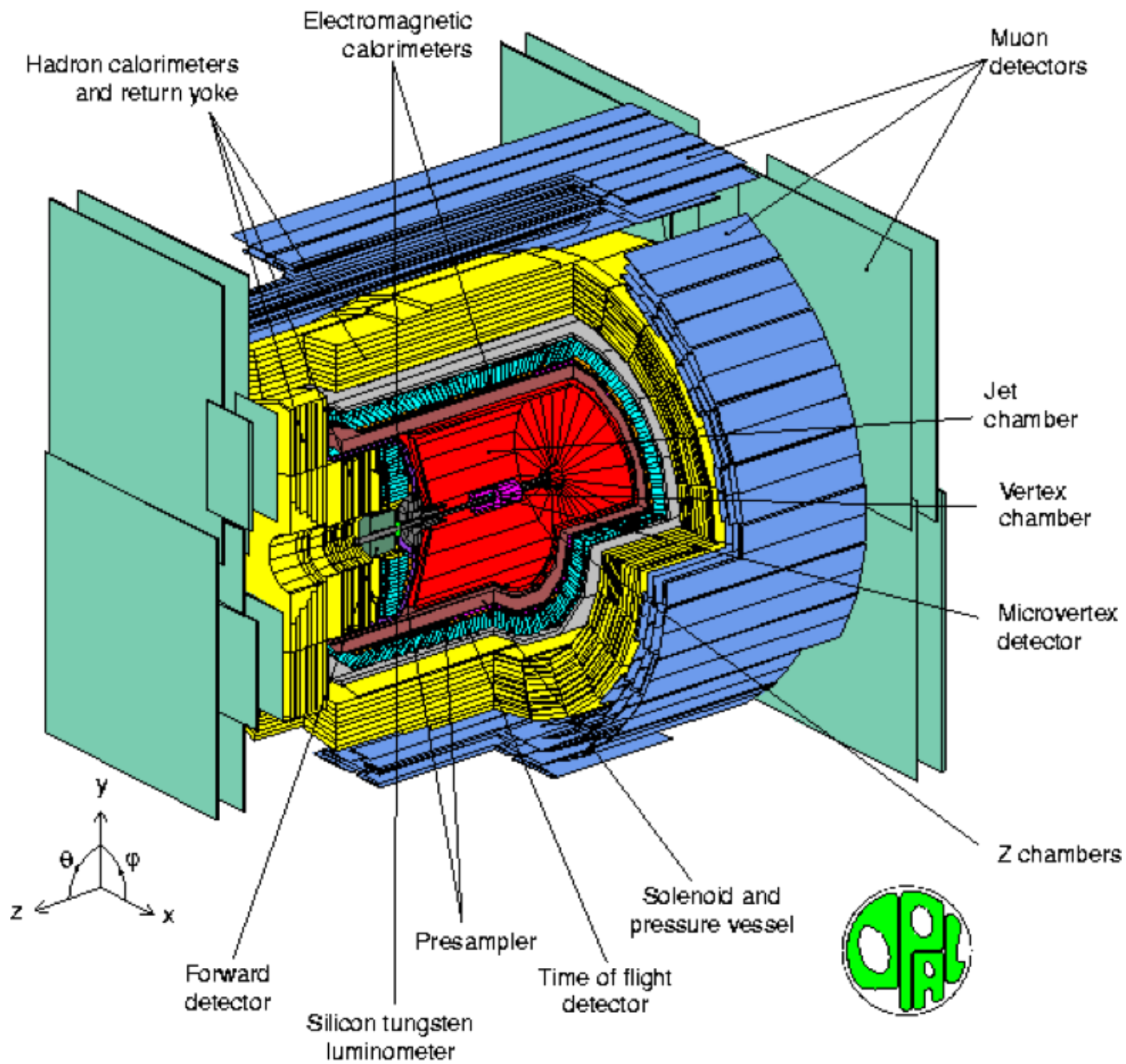

Event display game

A	$Z \rightarrow e^+e^-$
B	$Z \rightarrow \mu^+\mu^-$
C	$Z \rightarrow \tau^+\tau^-$
D	$Z \rightarrow q\bar{q}$
E	$Z \rightarrow q\bar{q}g$
F	$ZZ \rightarrow e^+e^-\mu^+\mu^-$
G	$ZZ \rightarrow e^+e^-q\bar{q}$
H	$ZZ \rightarrow \mu^+\mu^-q\bar{q}$

I	$WW \rightarrow e\nu\mu\nu$
L	$WW \rightarrow \mu\nu\mu\nu$
M	$WW \rightarrow \tau\nu\tau\nu$
N	$WW \rightarrow \tau\nu\mu\nu$
O	$WW \rightarrow e\nu q\bar{q}$
P	$WW \rightarrow \mu\nu q\bar{q}$
Q	$WW \rightarrow \tau\nu q\bar{q}$
R	$WW \rightarrow q\bar{q}q\bar{q}$

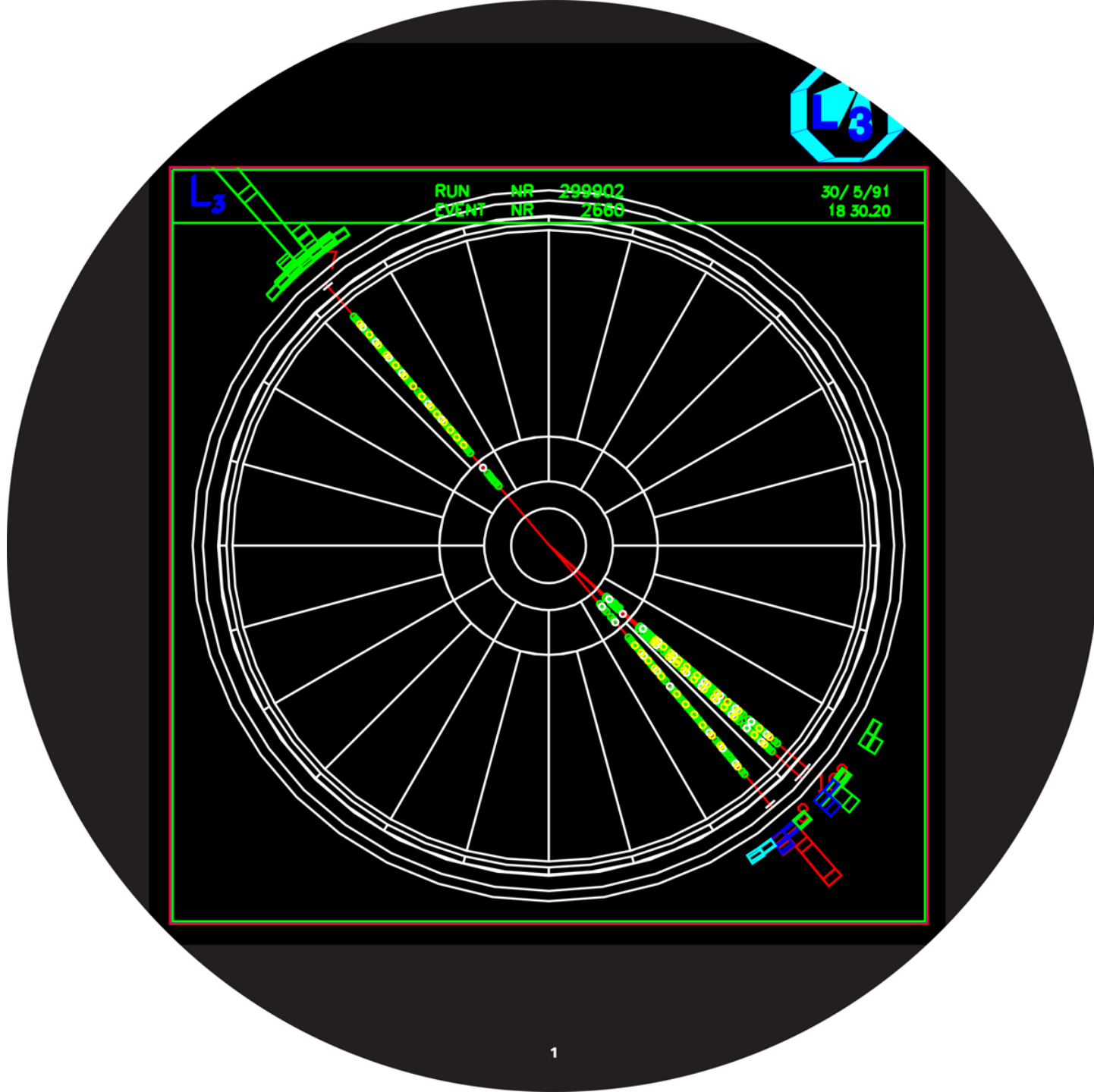

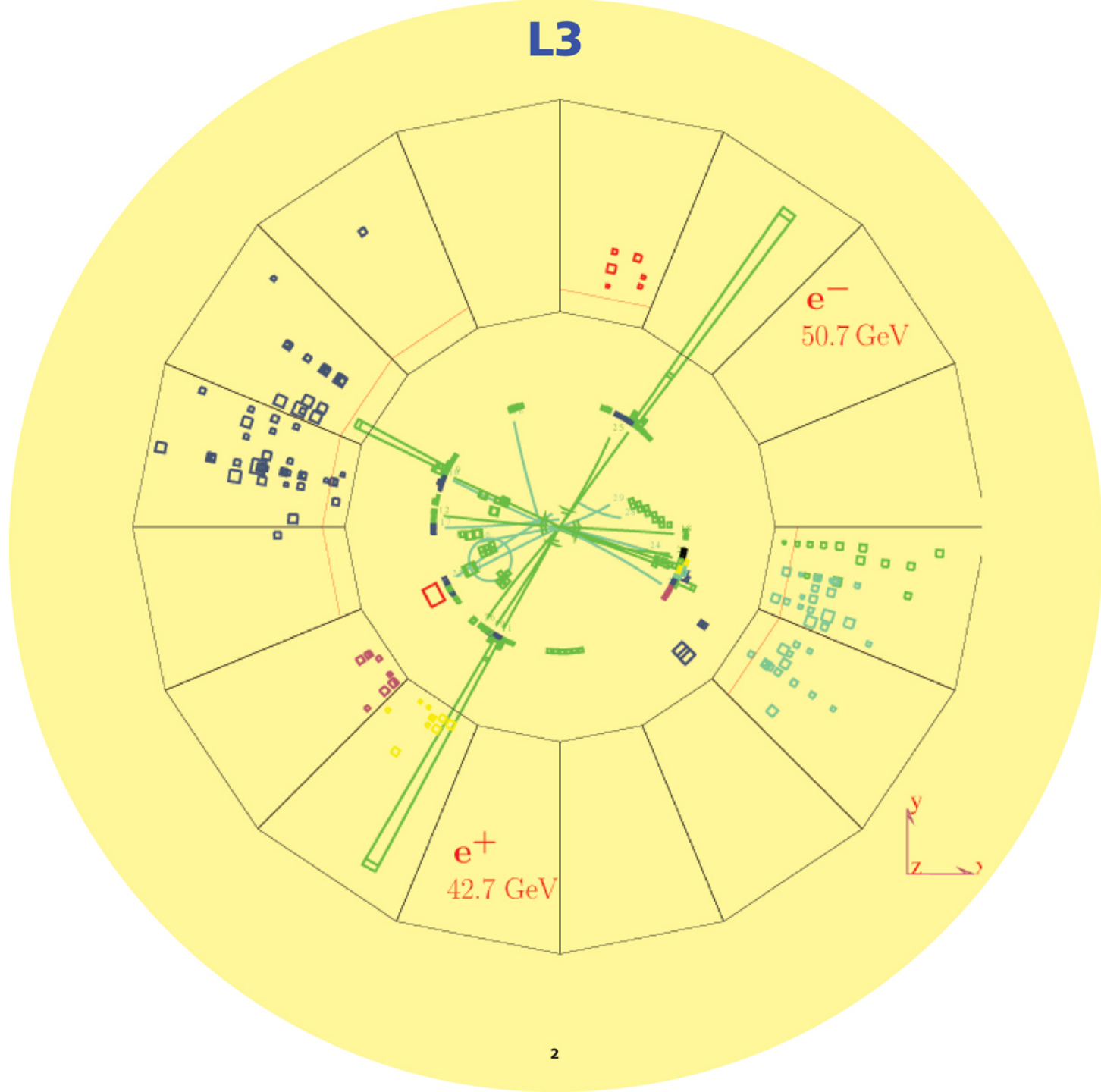

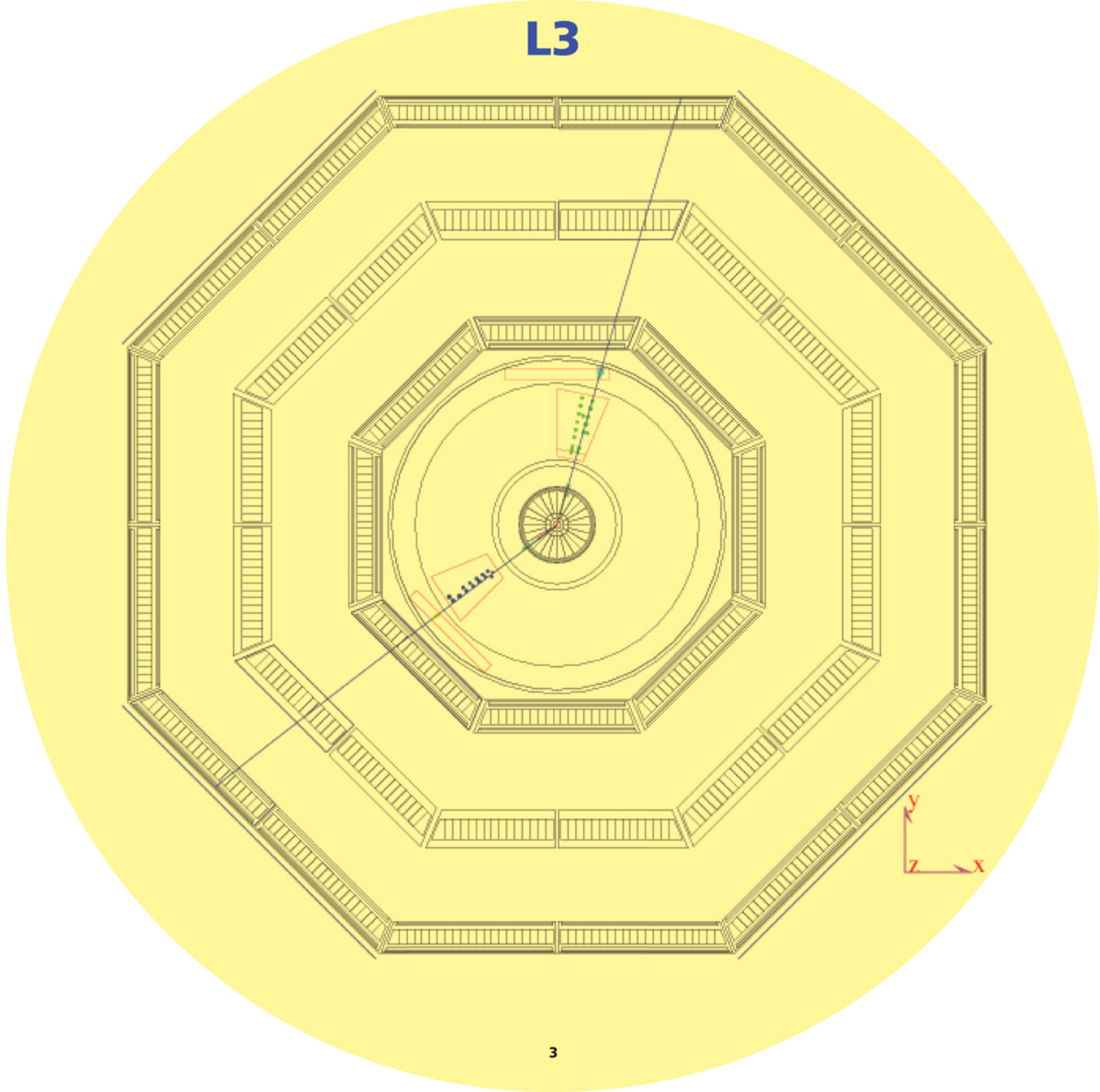

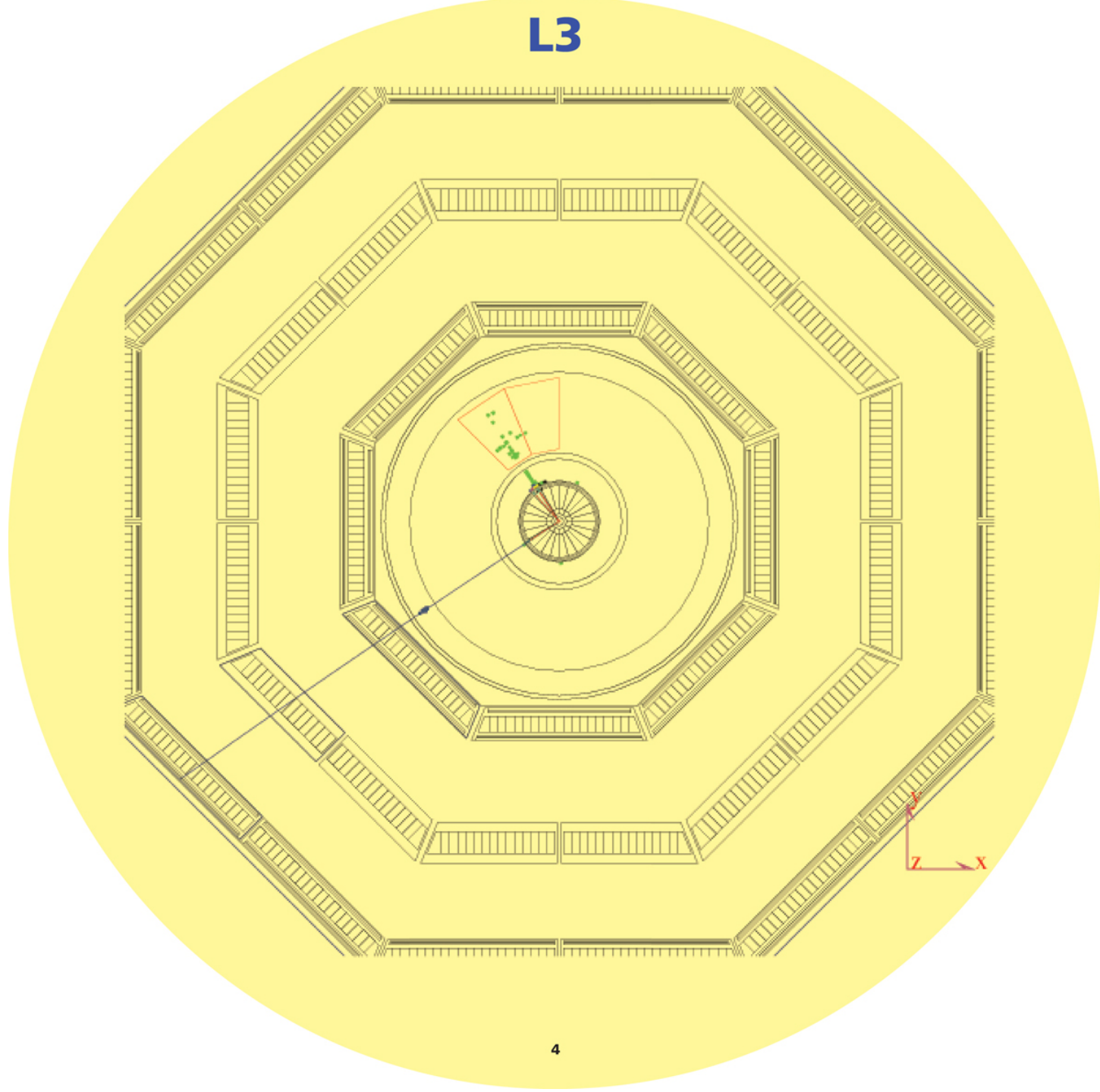

ALEPH

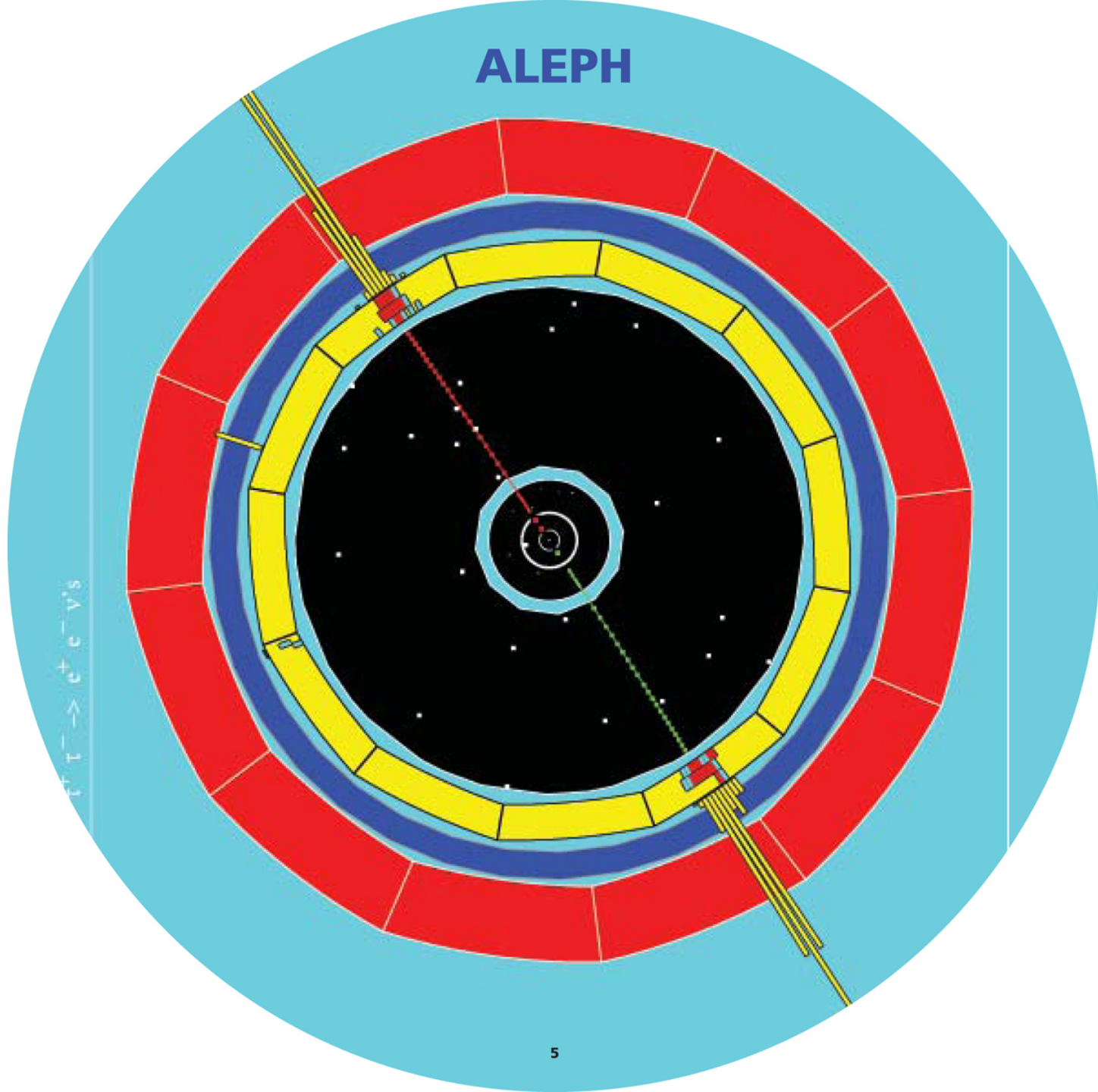

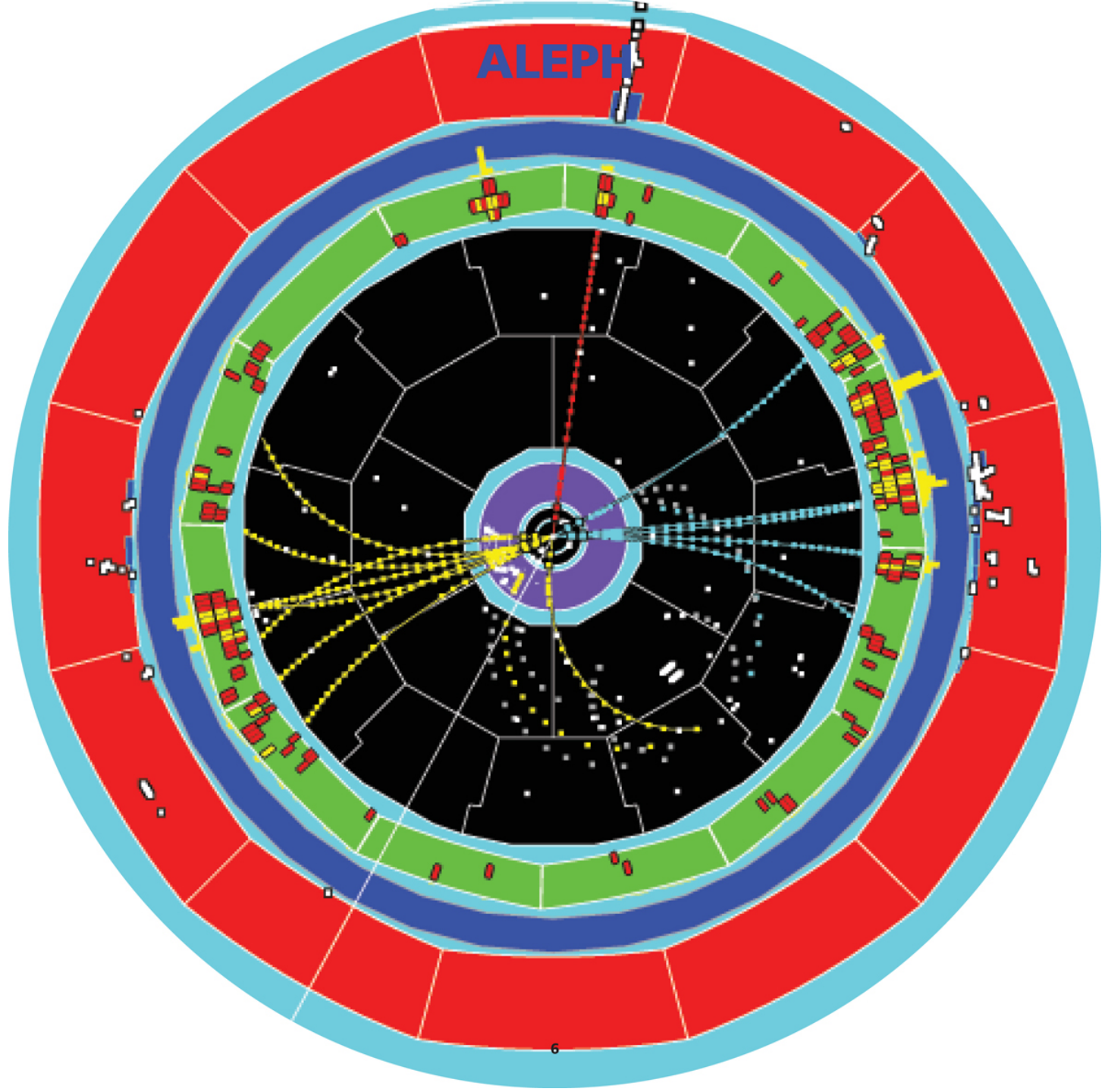

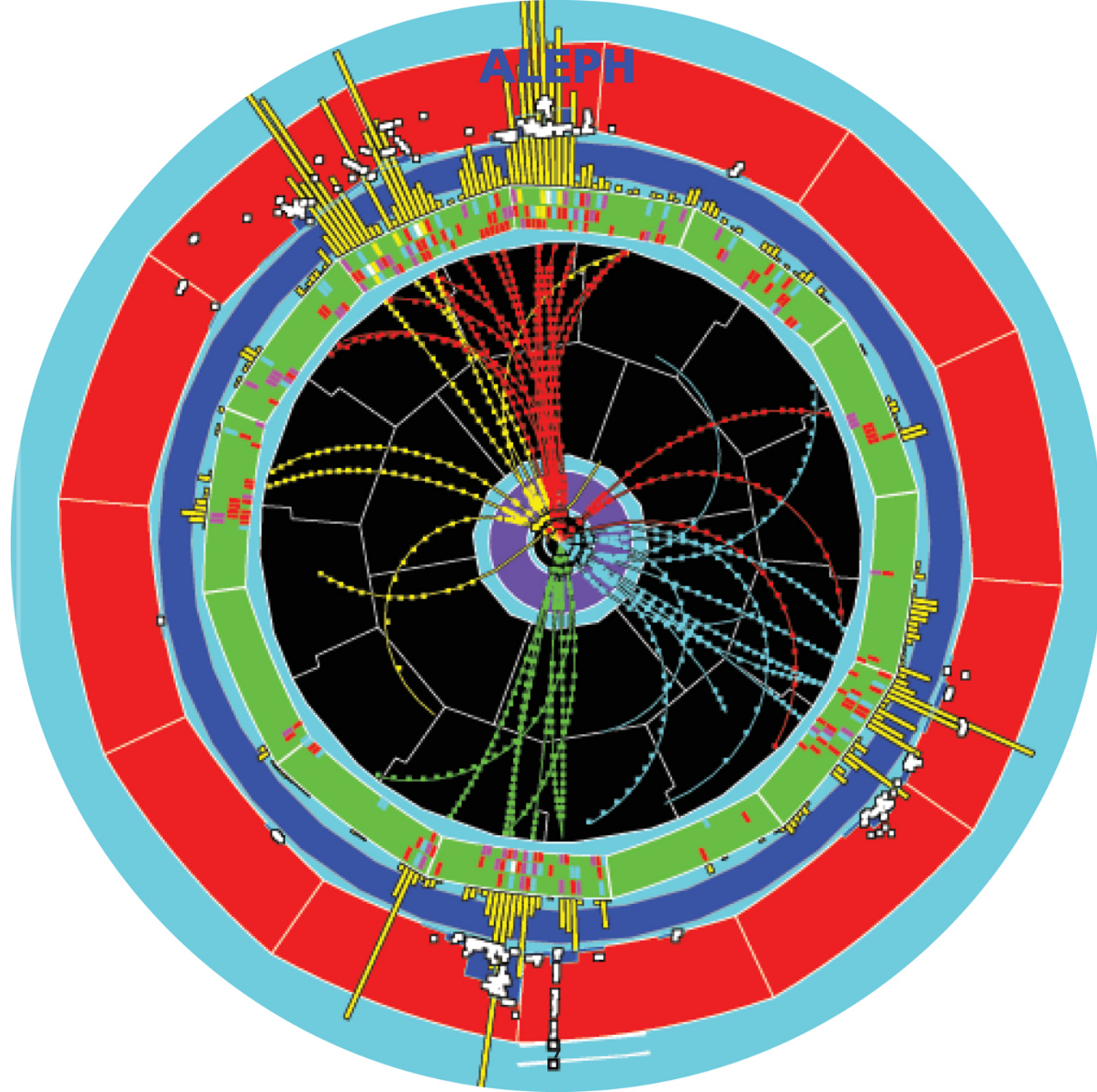

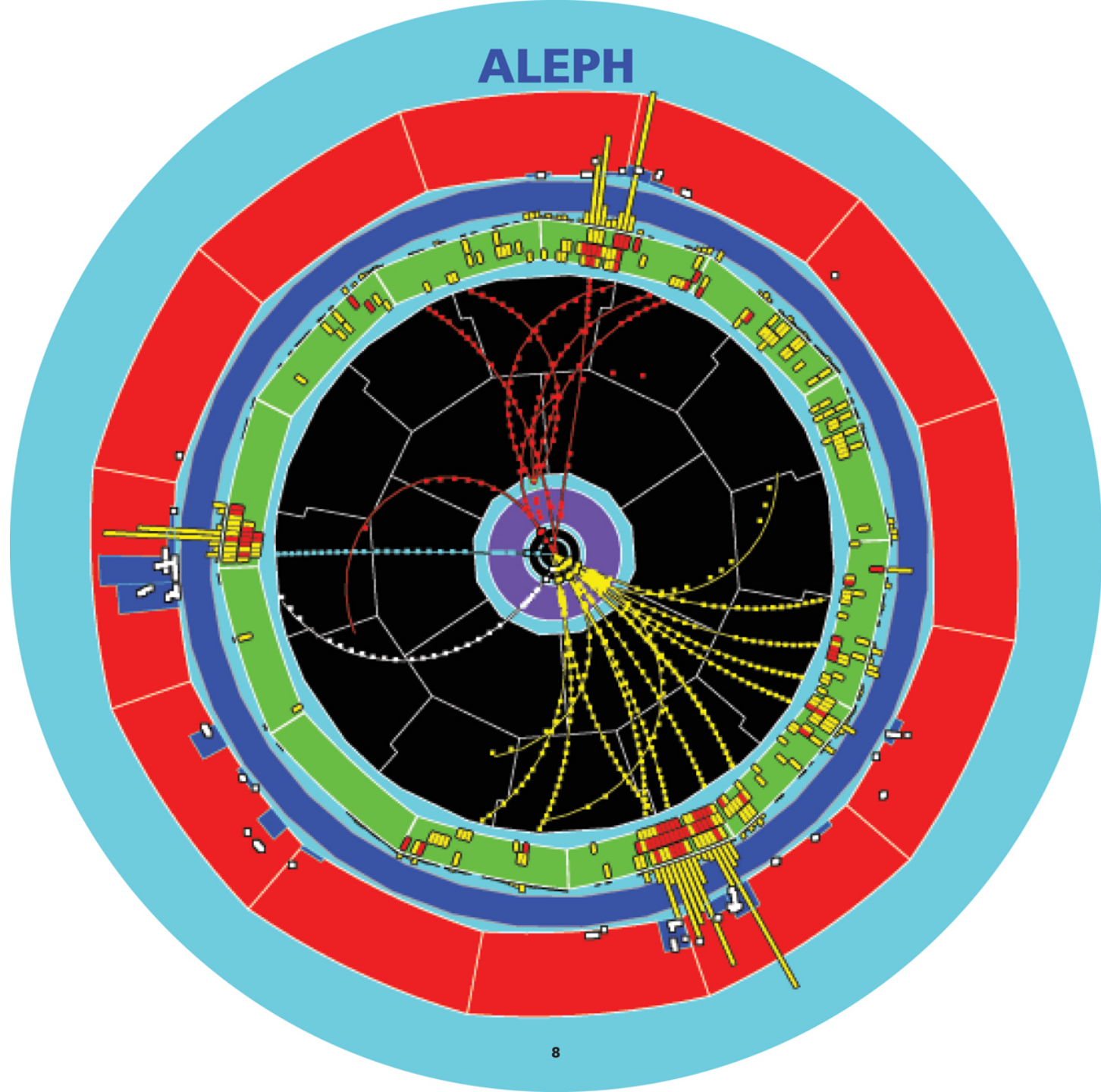

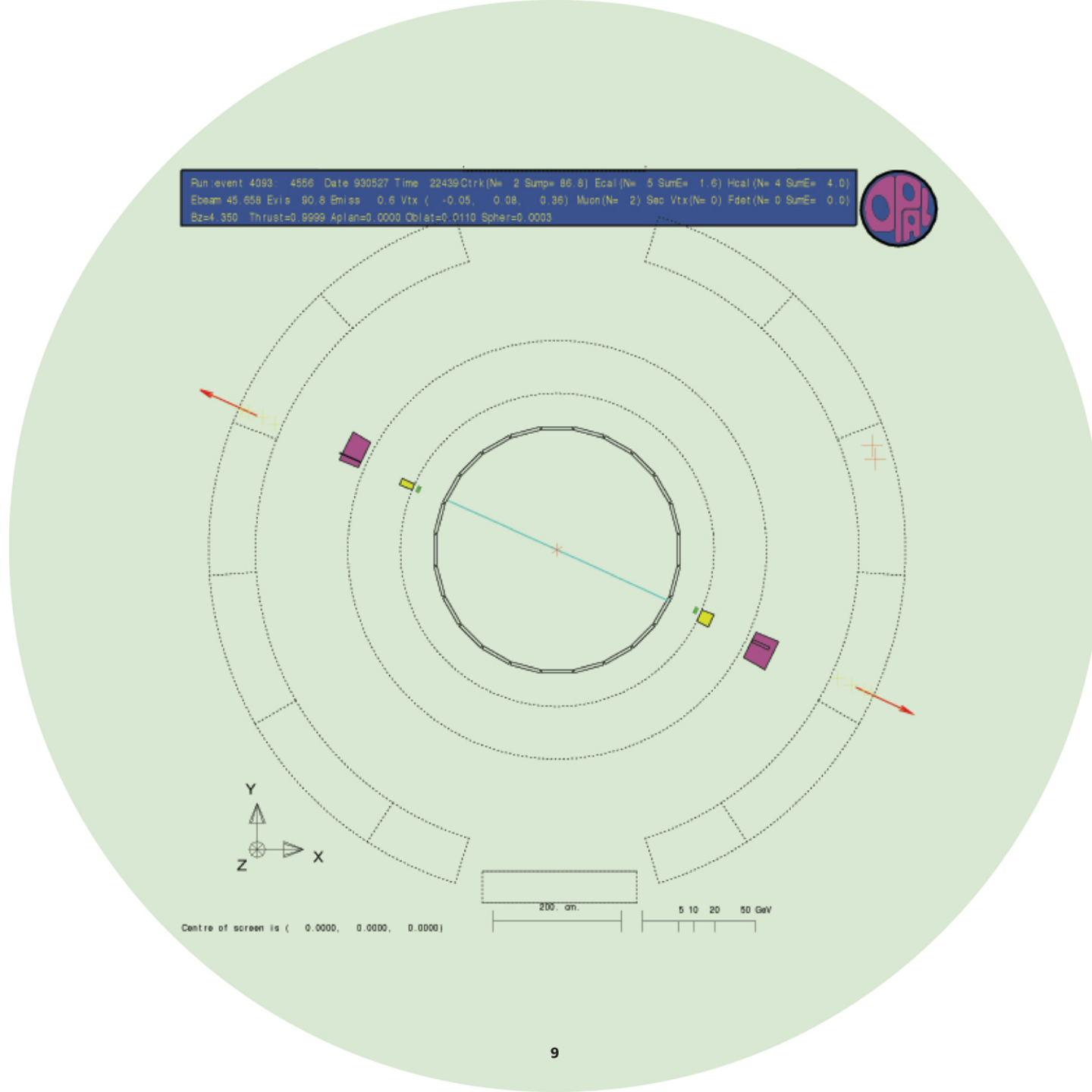

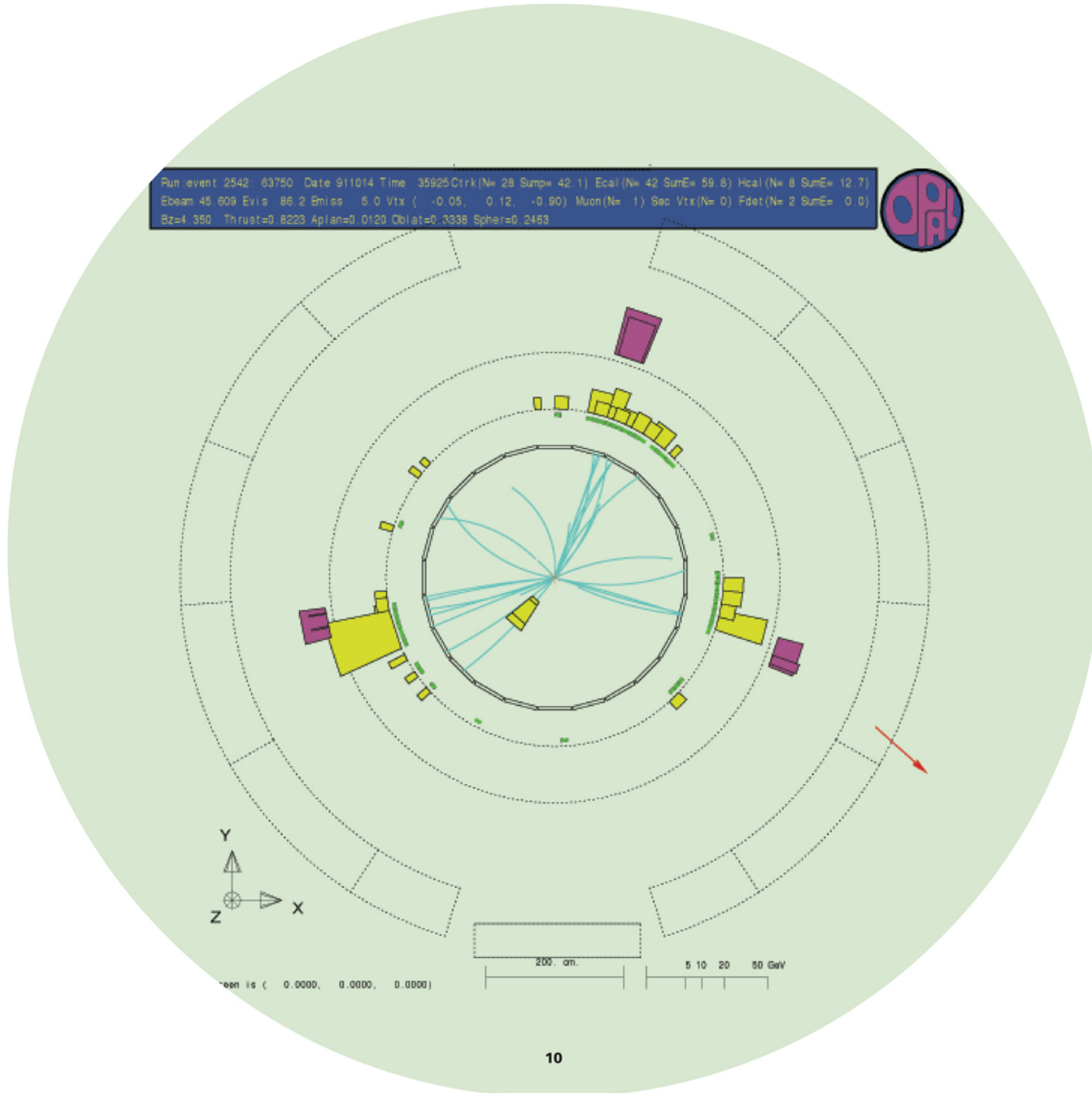

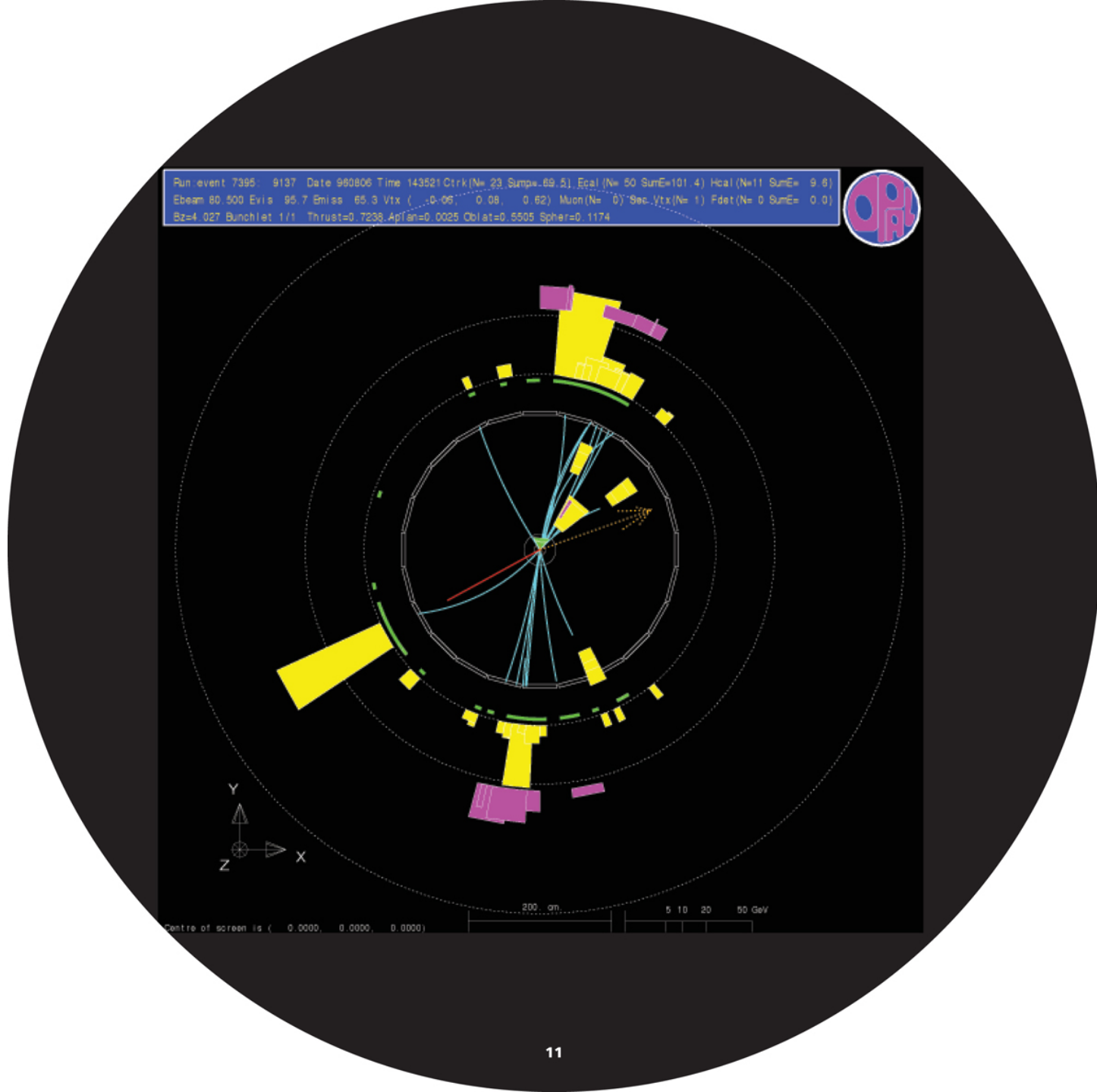

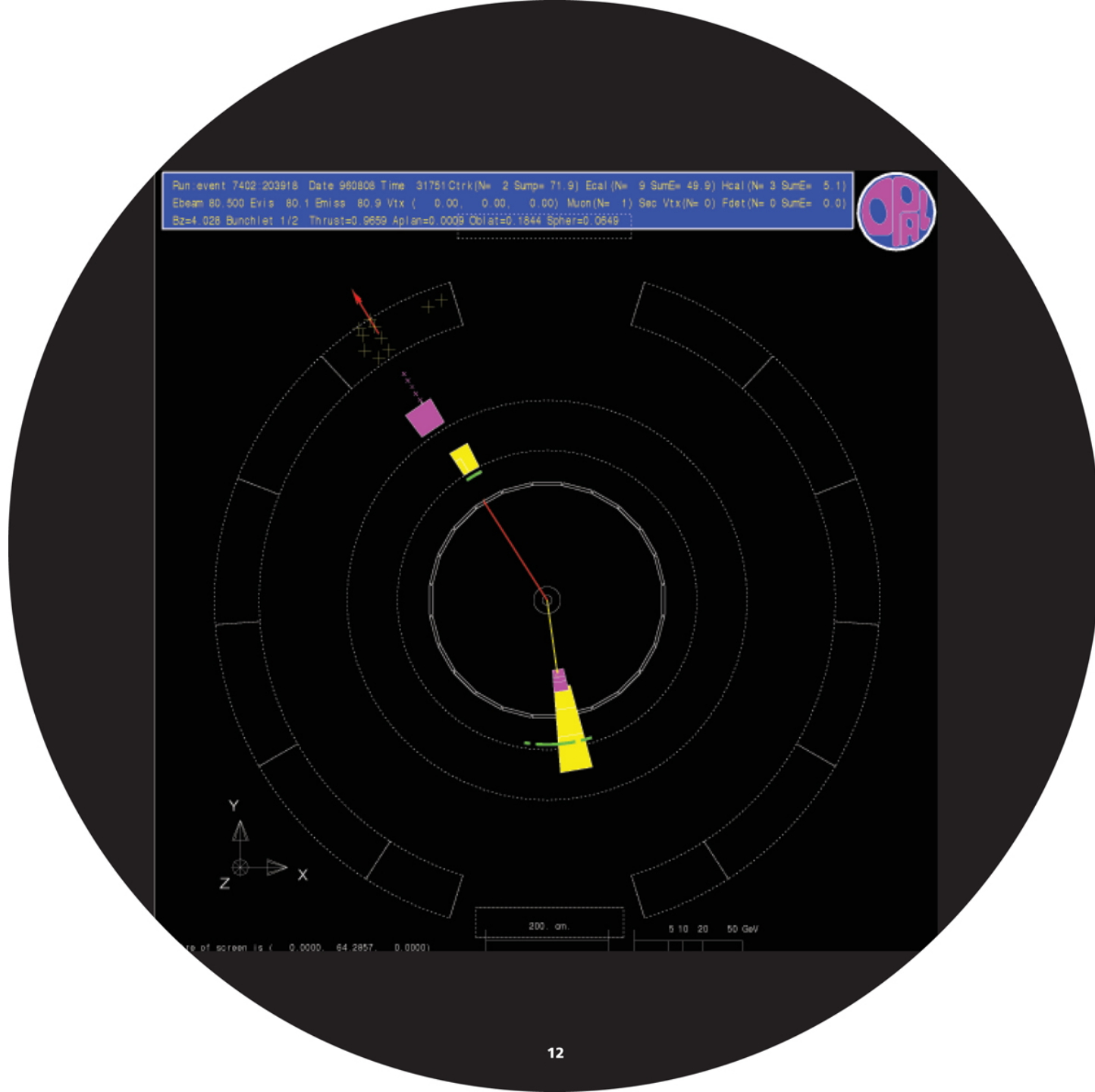

DELPHI

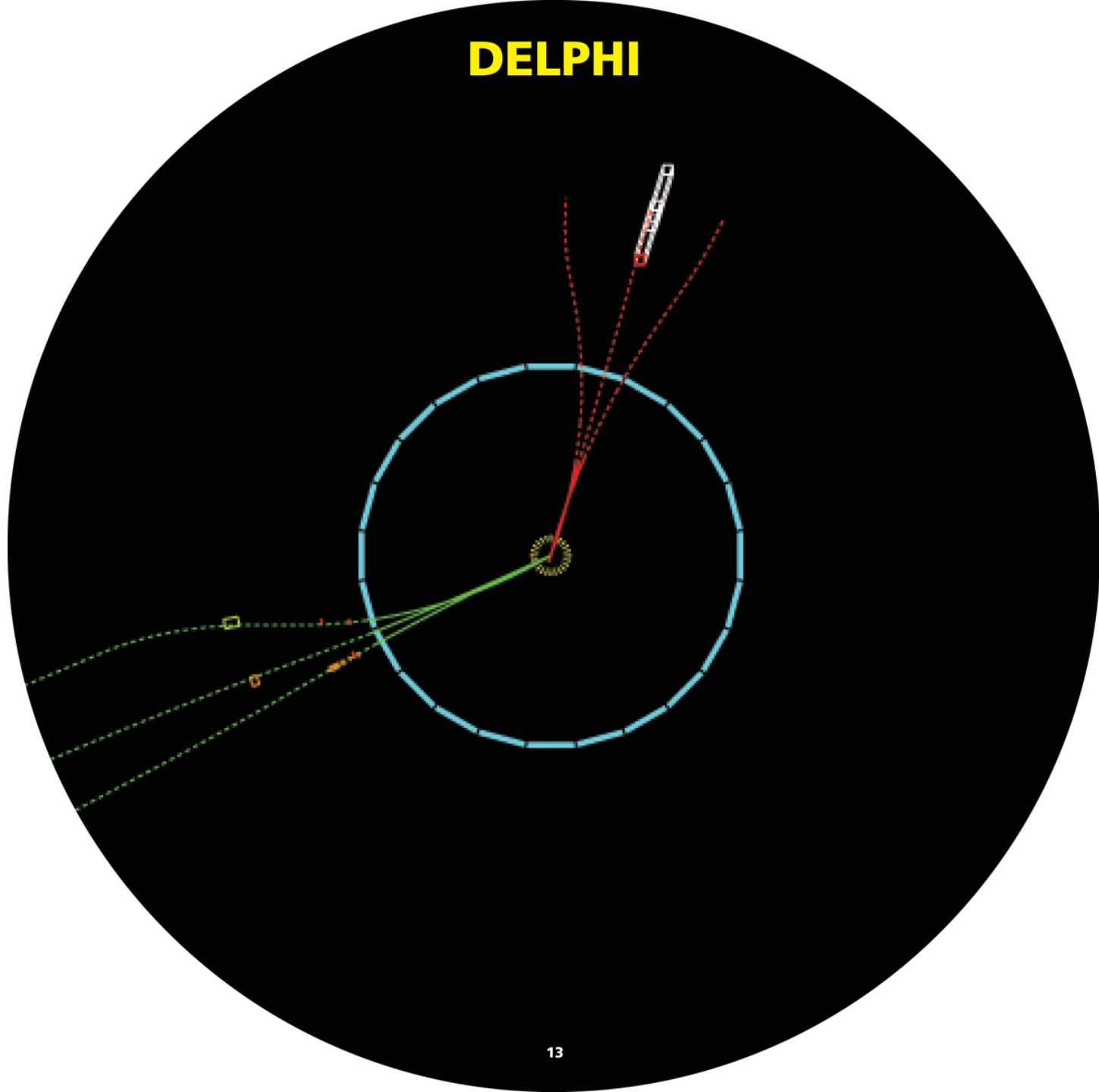

DELPHI

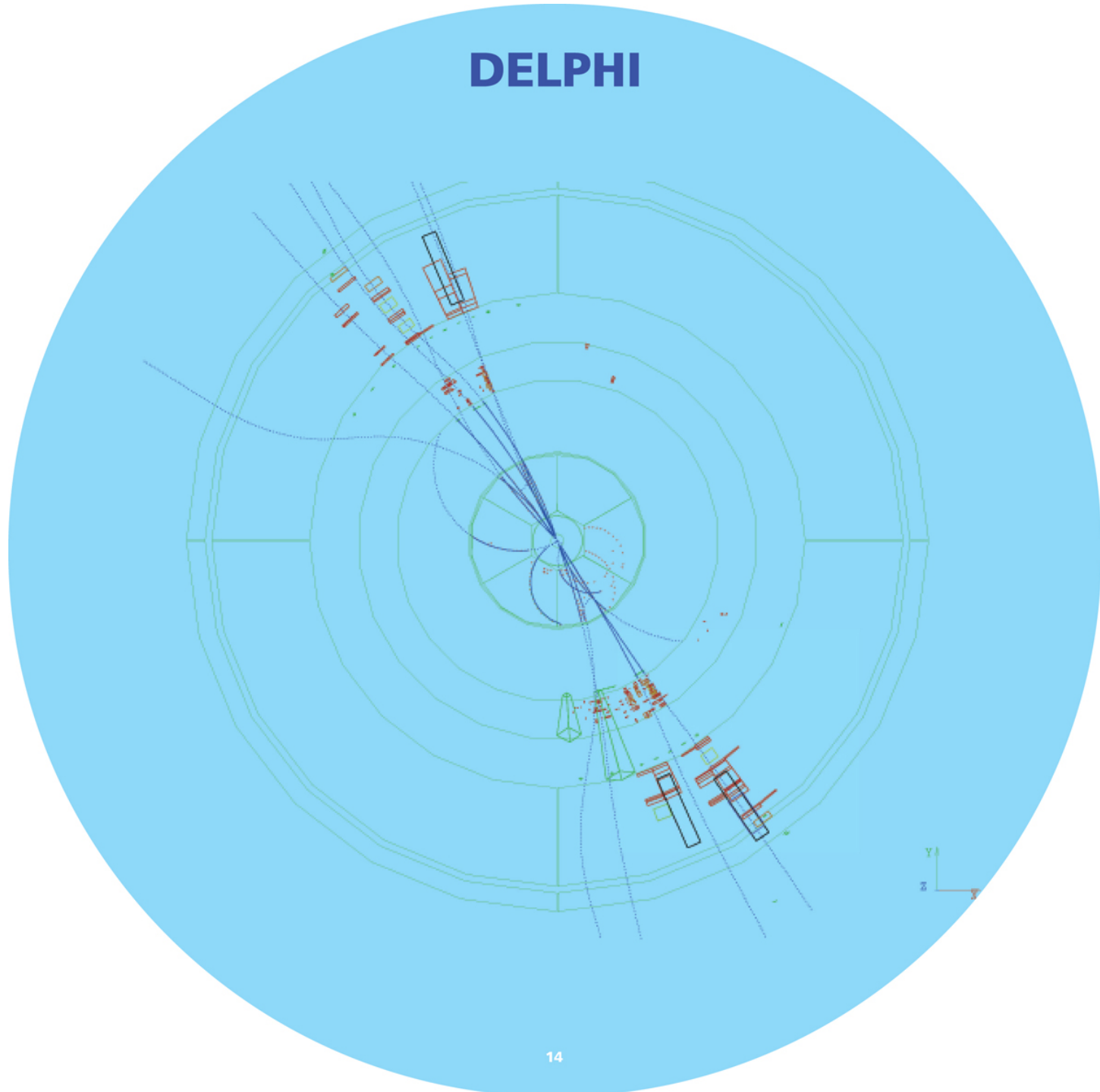

DELPHI

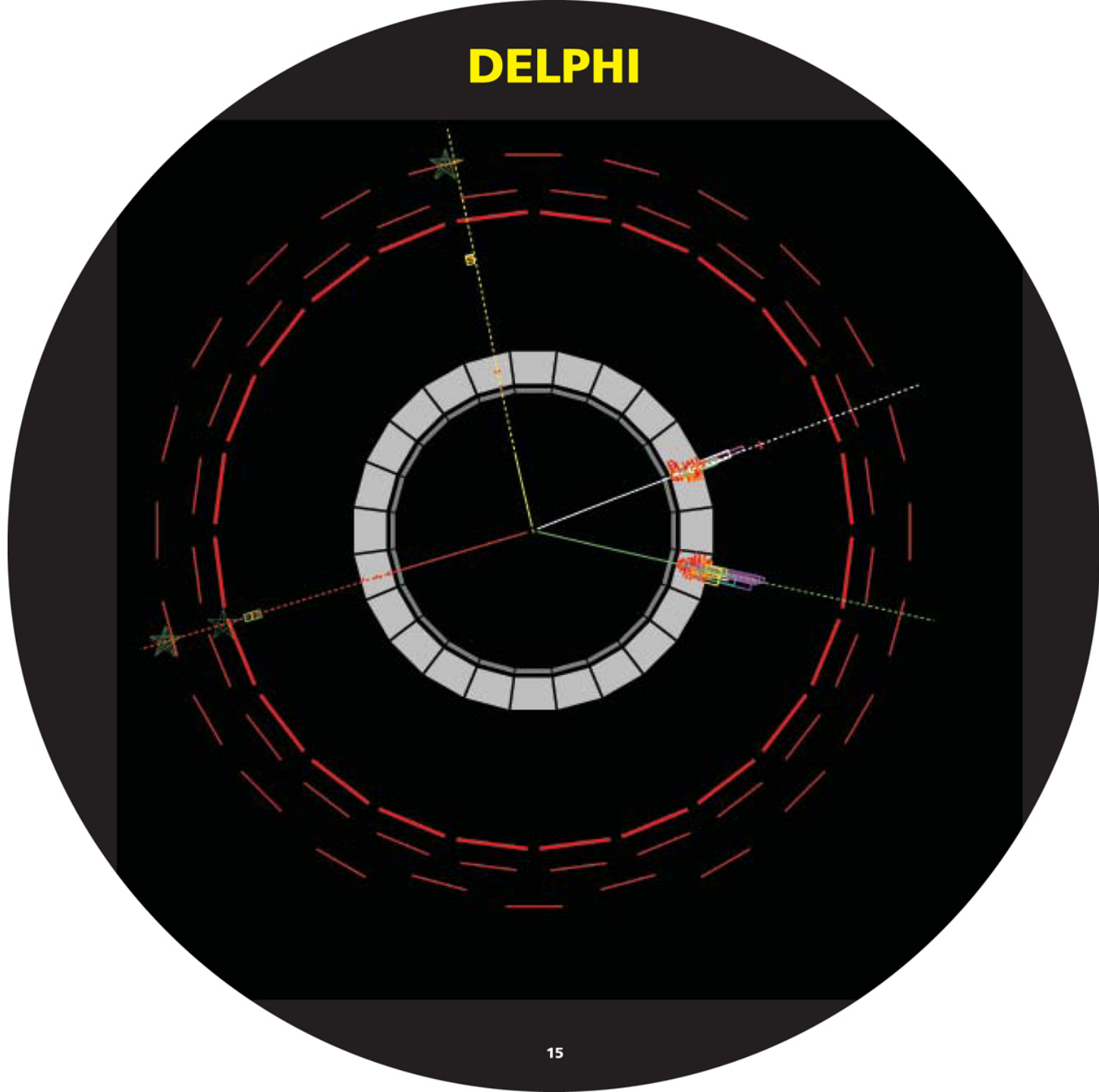

DELPHI

