

Imaging using ionizing radiations

Ziad El Bitar

ziad.elbitar@iphc.cnrs.fr

Institut Pluridisciplinaire Hubert Curien, Strasbourg

Curious to know how we are made inside ?

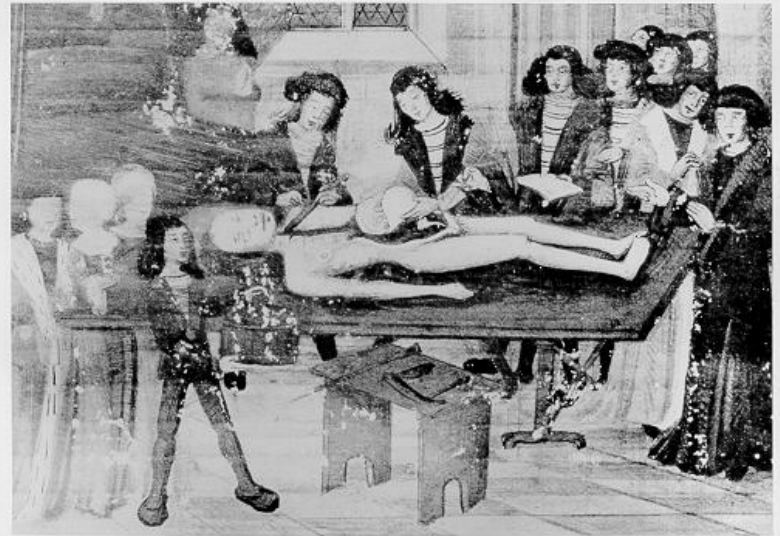

...however, without being sacrificed !



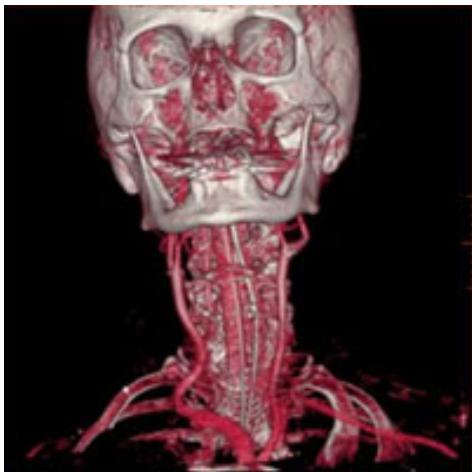
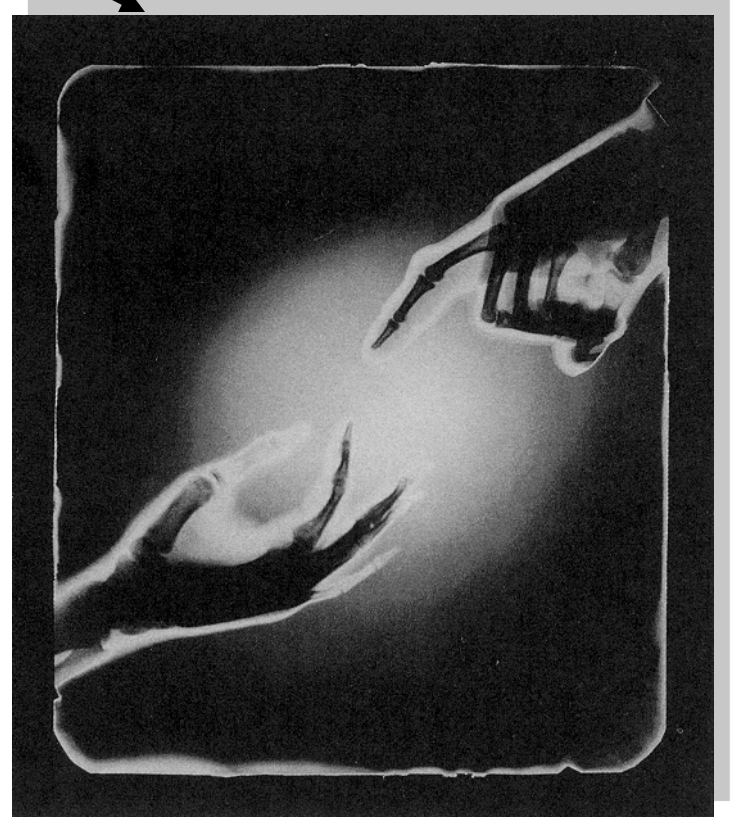

David Teplica, Birth of man with homage to Michelangelo (1987)

We are also curious to know
how ...

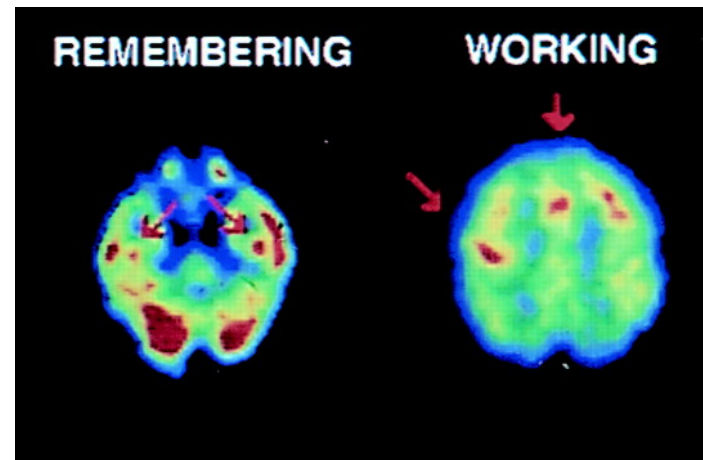
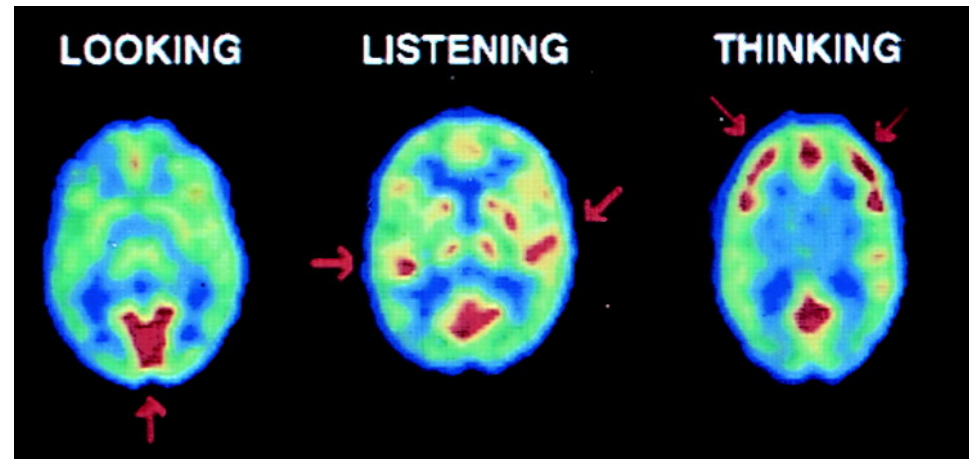
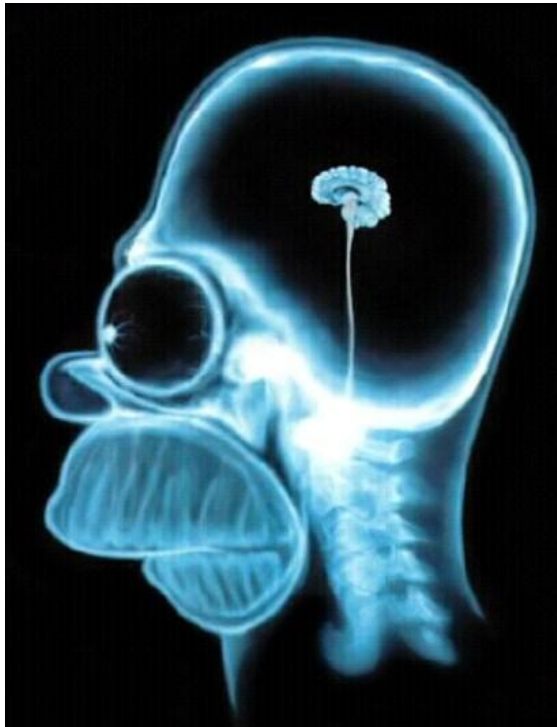

...do our organs function?

Modality using X Rays or gamma rays

- Radiology (X rays)
 - *Standard radiology, mammography*
 - *Angiography*
 - *Computer Tomography (CT scanner)*
- Nuclear medicine
 - *Scintigraphy*
 - *Emission tomography*
 - *Simple photons*
 - *Positons*
- Radiotherapy

Morphology vs Functional

Emission vs Transmission

Real time vs Integration

Anatomical imaging

Visualisation of organs and tissues structures

- Surface
- Volume
- Distance



A broken tibia

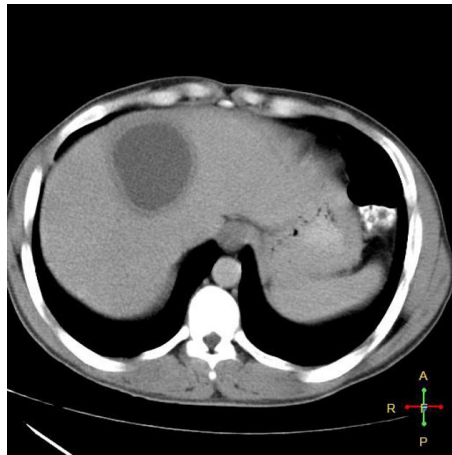

Liver tumor

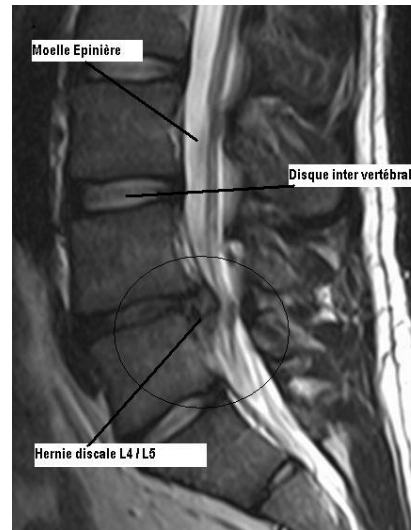

Discale Hernia



Knee Arthrosis

Functional Imaging

Study and evaluate the functioning of organs, metabolism, ...

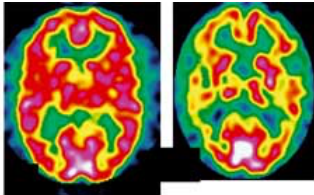

Exemple de scintigraphie de perfusion normale (à gauche) et pathologique (à droite) chez un patient présentant une maladie d'Alzheimer.

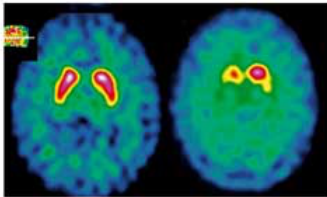

Scintigraphie des transporteurs de la dopamine : examen normal (à gauche) et chez un patient parkinsonien (à droite).

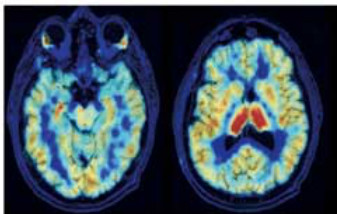

Exemple de radiotracer utilisé en recherche : il s'agit ici d'un ligand des récepteurs cholinergiques de la nicotine, dont l'image scintigraphique a été fusionnée avec une IRM anatomique.

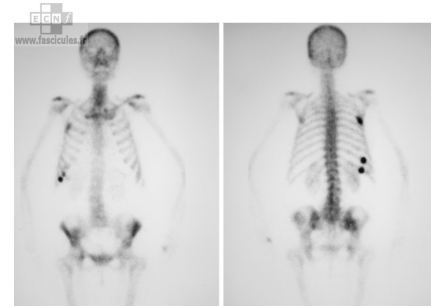

Bone Scintigraphy

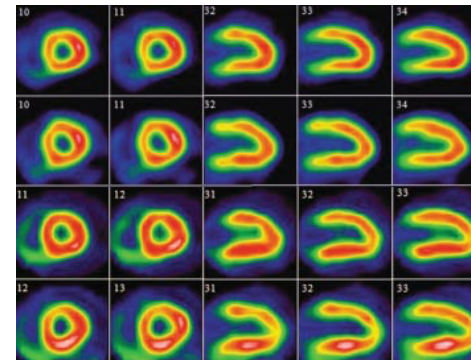

Cardiac perfusion

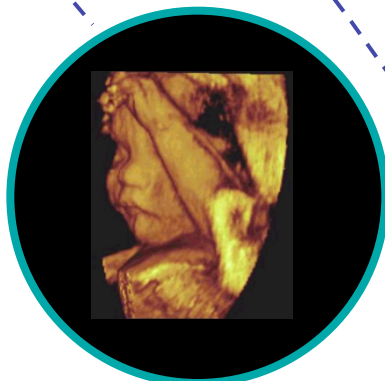
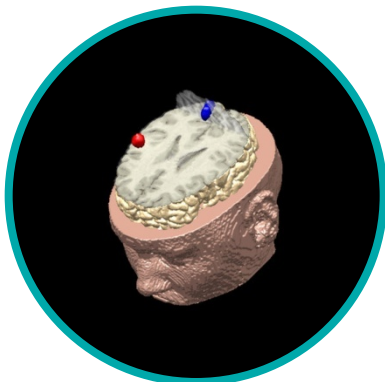
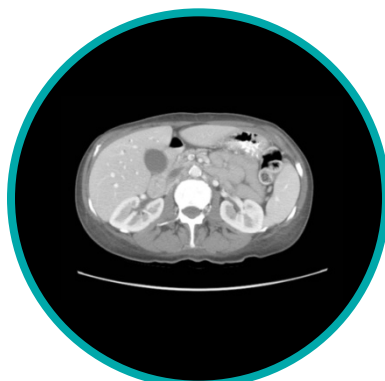
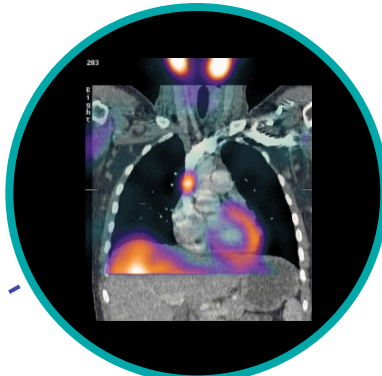
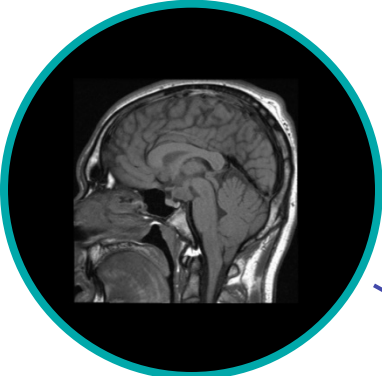

Ionising and non-ionizing radiations

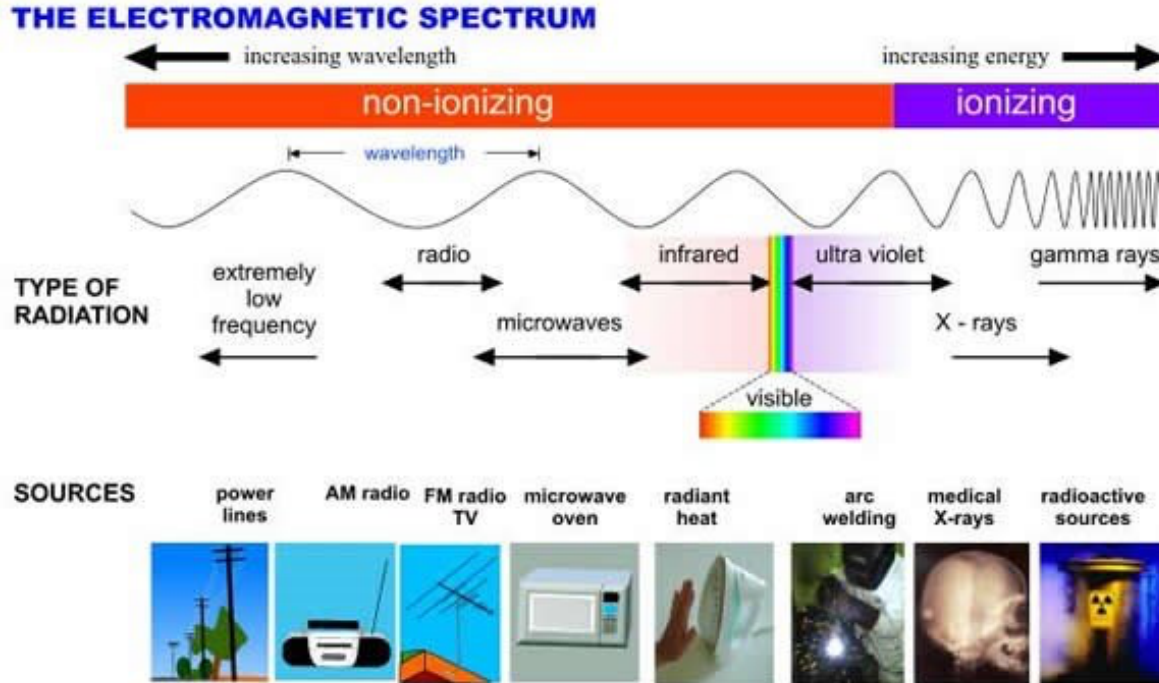

Ecography (Ultra Sound: 1-10 MHz)

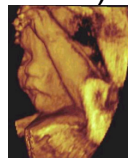

Magnetic resonance Imaging

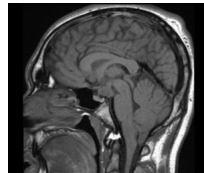

Radiography



X-ray scanner

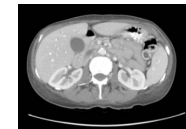

Single Photon Scintigraphy



Single Photon Emission Computed Tomography

Position Emission Tomography

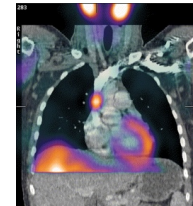

History

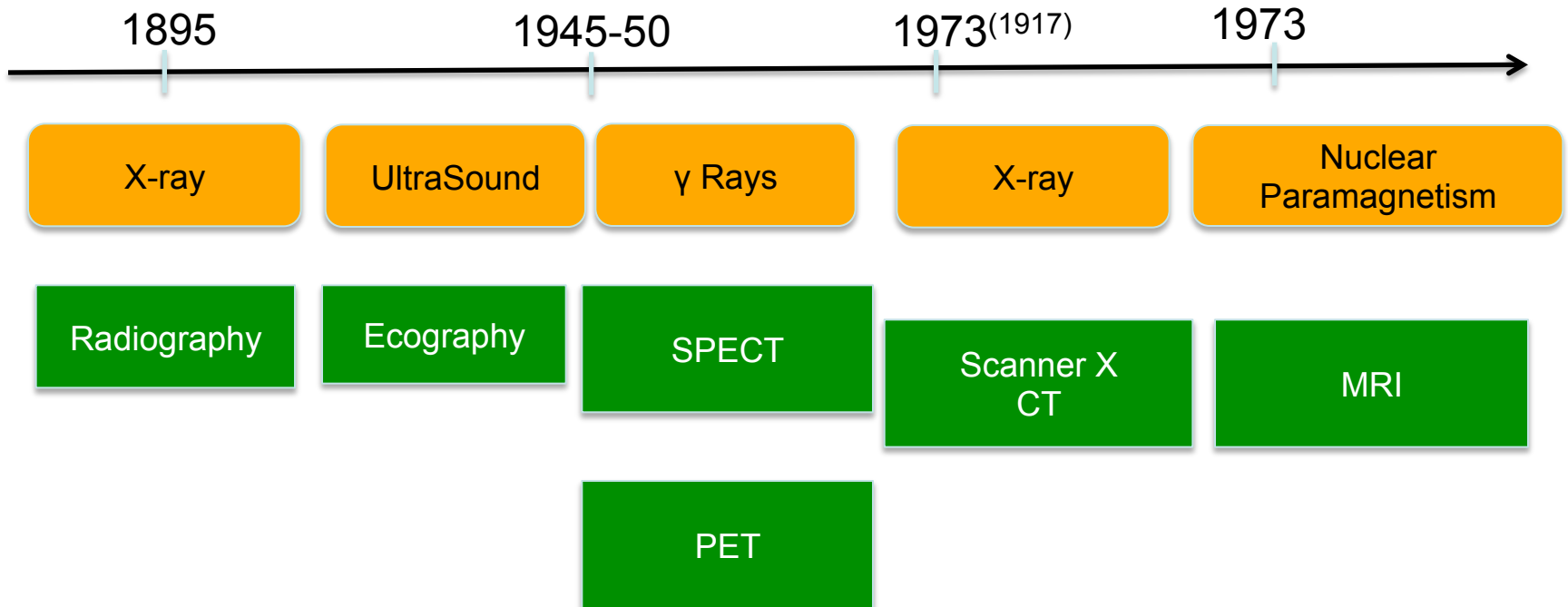

X-ray Imaging

X-ray discovery (1895)

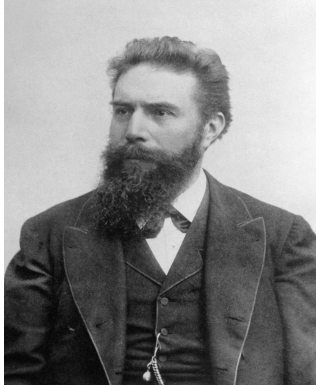

de Wilhelm Conrad Röntgen
(1845–1923)

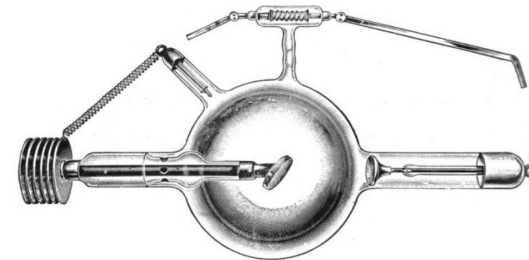
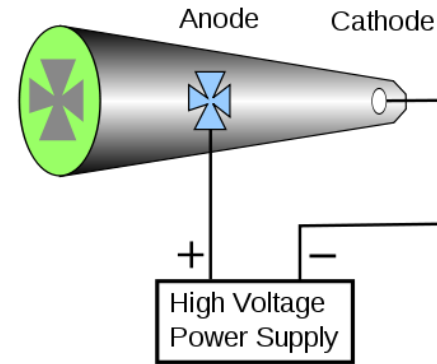

Crookes tube
(~1910)

https://fr.wikipedia.org/wiki/Tube_de_Crookes

X-ray production

Généralités

Electromagnetic radiations

Two ways of production:

- Synchrotron
- X-ray tube

Electrons generation:

- Tungsten filament
- Thermo-ionic Effect

Electrons Acceleration

Metallic target (anode)

- Static or rotating plate

Interaction electron/matter

Heating

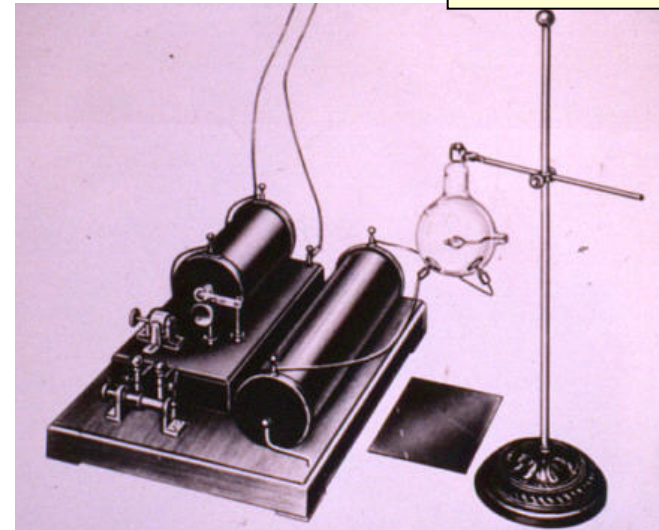

enceinte plombée,

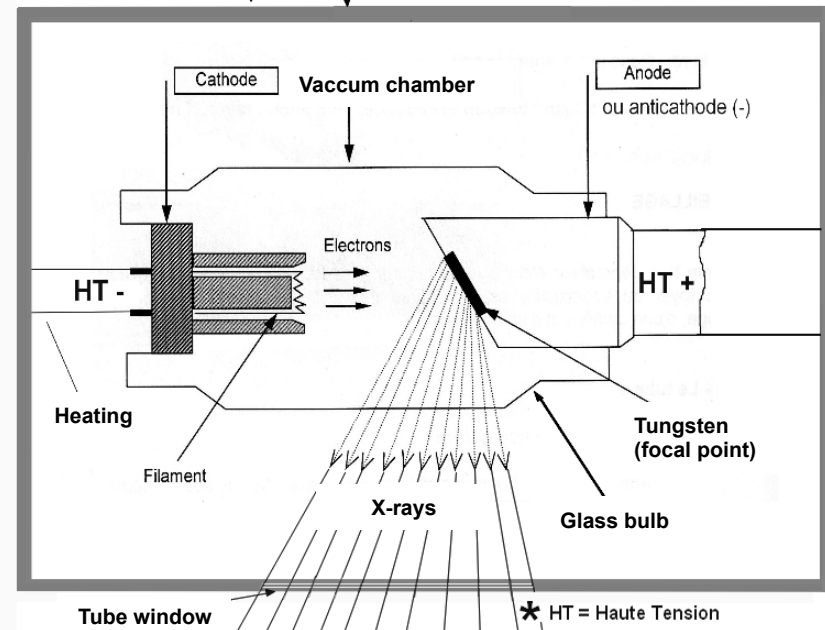

X-ray production

Electrons generation

Energy supply

Heat a filament
Joule Effect: $W=RI^2t$

Electronic cloud

=

Thermo-ionic effect
Or
EDISON effect

$$\vartheta_1 < \vartheta_2 < \vartheta_3$$

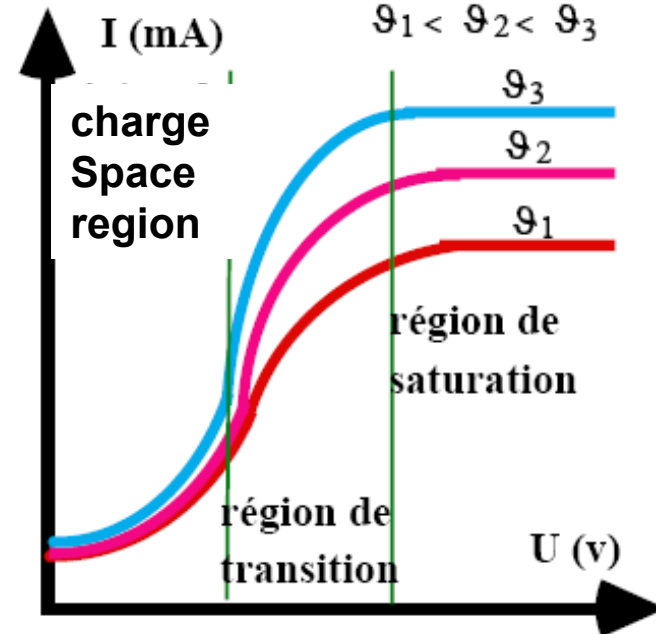
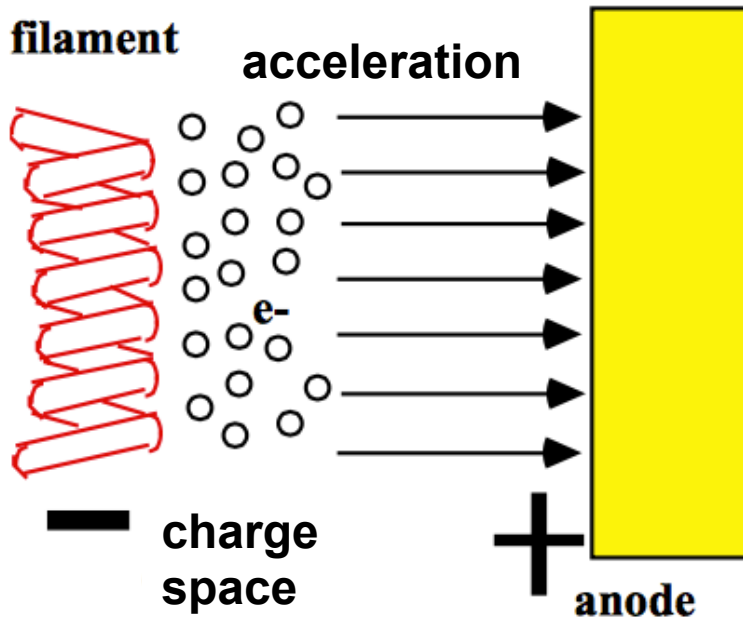

In the saturation region, the current intensity depends only on the filament temperature.

X-ray production

Electrons beam

Potential difference between anode et cathode



Electrons acceleration

Electrons energy:

$$T_0 = eU = \frac{1}{2}mv^2$$

e: electron charge

U: Potential difference in *V*

m: electron mass

v: electron velocity

Consider that :

- All the electrons have the same energy
- If $U = 120 \text{ kV}$, $T_0 = 120 \text{ keV}$

X-rays production

Electron/matter interaction

Two types of interaction:

Energy supply

- Passing at the proximity of the nucleus
- Attraction by the positive nuclear charge
- Centripetal acceleration interaction
- Energy emission by means of photons
- Electron slowing down
- **Bremsstrahlung radiation**

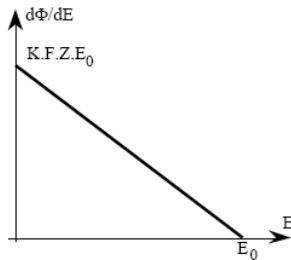

K is a constant depending on geometry
 F is the electrons fluence
 Z is the target atomic number
 E₀ is the electron maximum energy

→ **Characteristics rays**

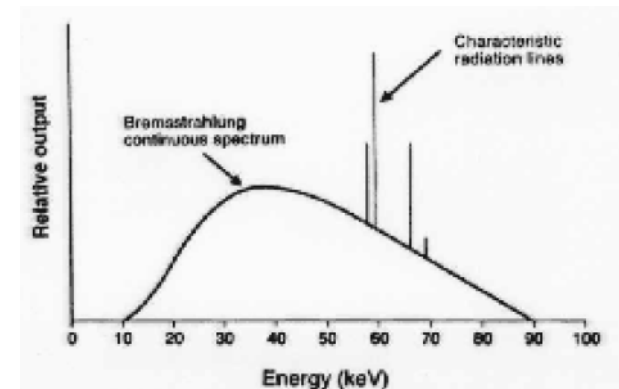
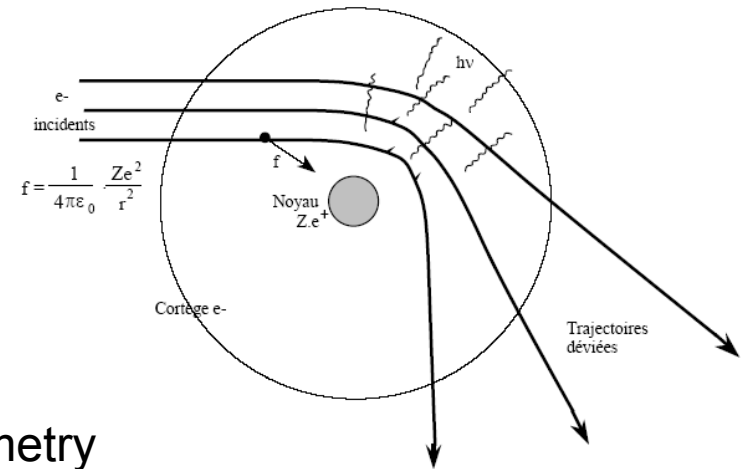

←—————→ r

X-ray production

Spectra shape

Filament current intensity role

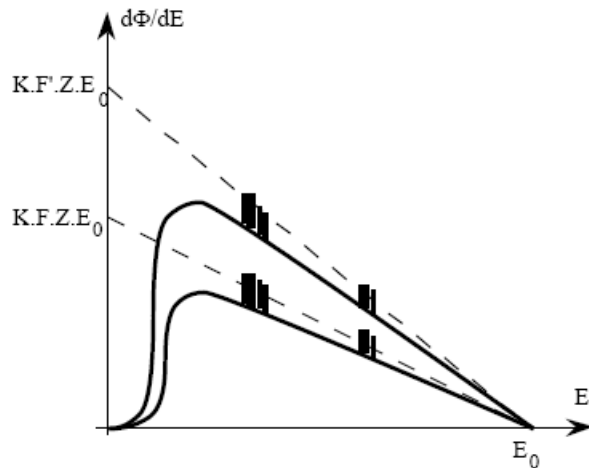

Acceleration voltage role

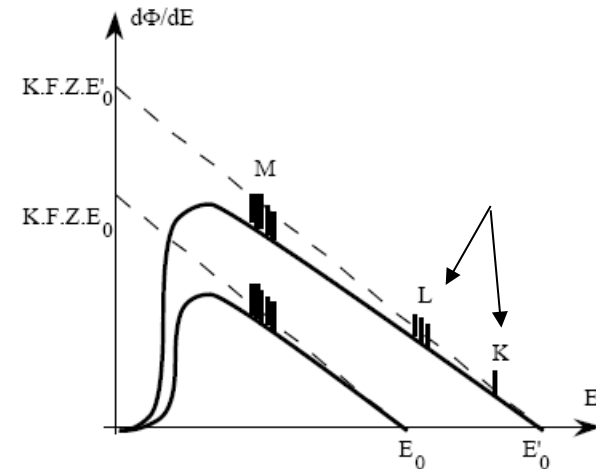

Global energetic fluence

$$\Phi = \frac{1}{2} K \cdot F \cdot Z \cdot E_0^2$$

Bremsstrahlung radiation theoretical yield:

$$\rho = \frac{\Phi}{F \cdot E_0} = \frac{K \cdot F \cdot Z \cdot E_0^2}{2F \cdot E_0} = k \cdot Z \cdot U$$

Is is function:

- of the target (Z),
- of the acceleration voltage (U),
- Geometrical factor (k).

Example of a tungsten anode:

$$Z = 74, U = 100 \text{ kV}, \rho = 1,2 \%$$

The rest is dissipated in form of heat

X-ray production

Tubes

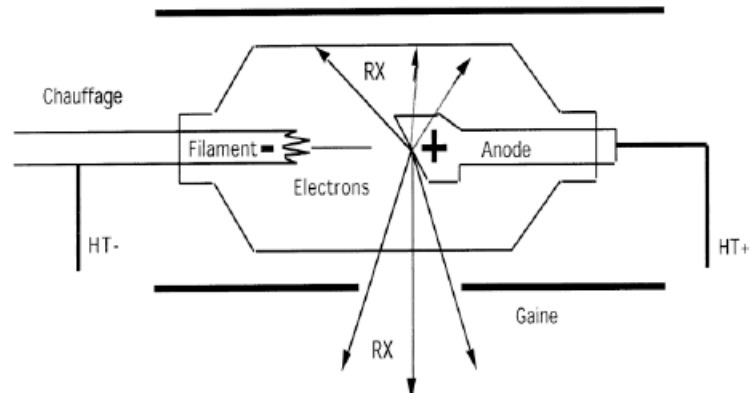

Two major problems :

- Yield
- Heat

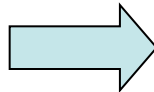

Anode capacity overtaking and destruction.
Glass and filament aging and bulb destruction

Cooling circuit based on mineral oil.
Rotating anode instead of fixed one.

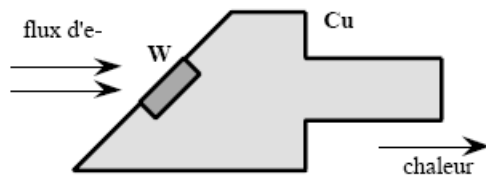

Heat dissipation by copper

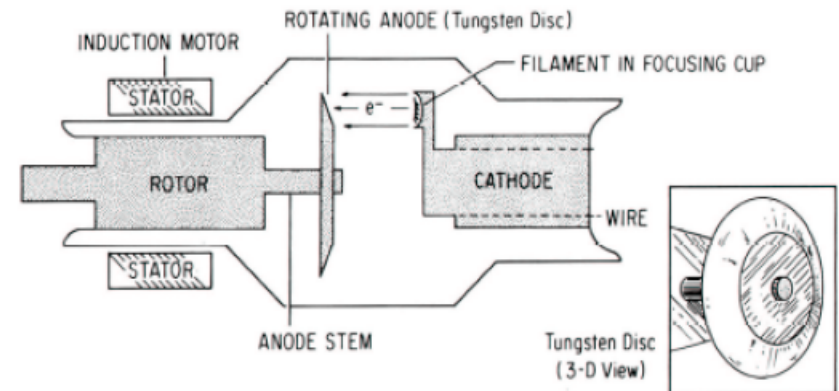

X-rays production

Rotating anode

Rotating anode advantages are:

- Heat spreading on a larger surface (1000-1500°C).
- Increasing the X-rays yield which means the increasing of the generator power (15-20 kW)
- Reducing the focal point size which improves the image quality in terms of spatial resolution.



Photon/matter interaction

$$\mu = \tau + \sigma + \pi$$

$$N(x) = N_0 e^{-\mu x}$$

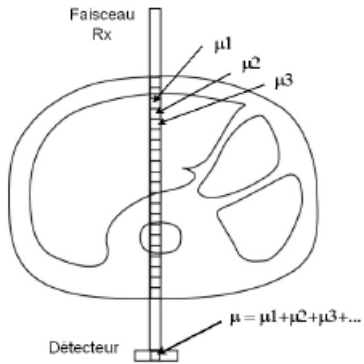
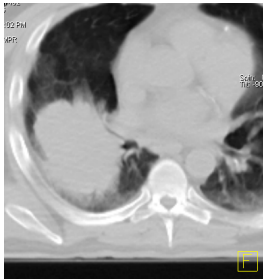
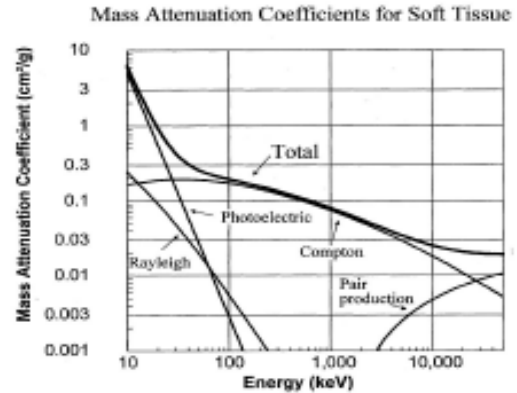

$$I = I_0 e^{-\int_L \mu_E(x,y,z) dL}$$

Hypothèse: E constante

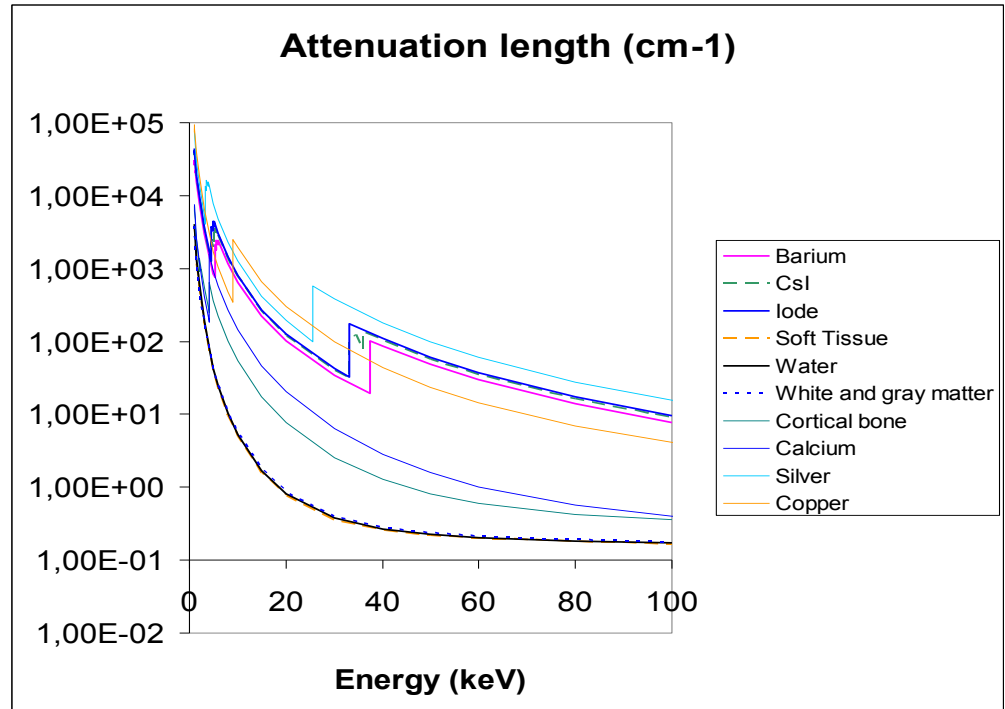

Photon/matter interaction

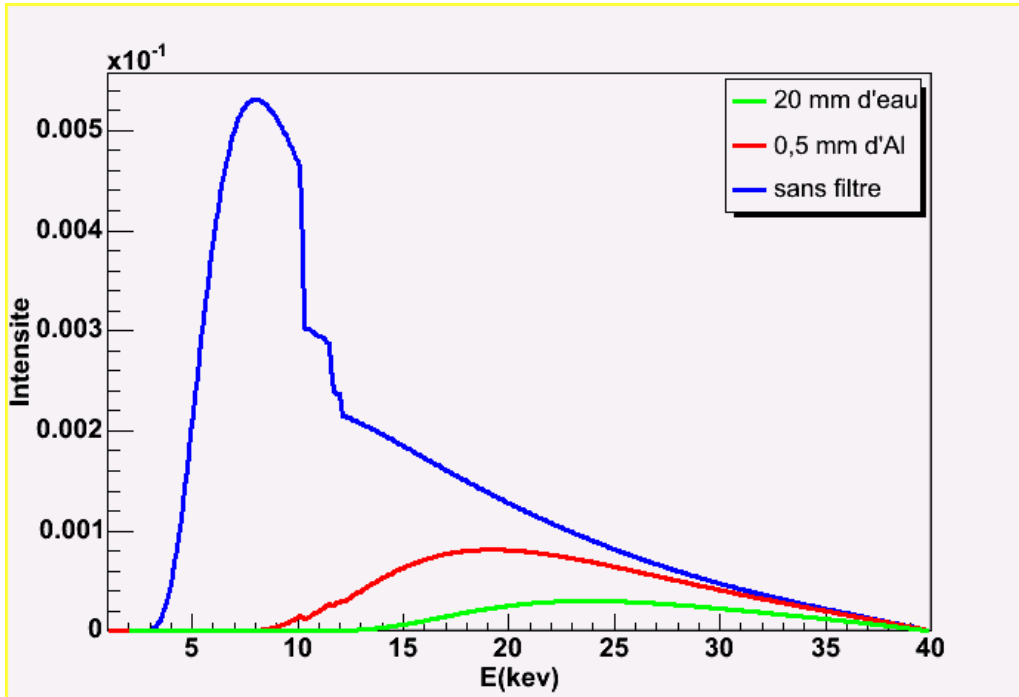

➔ Beam hardening

Mean fluence:

$$F_m = \frac{K \cdot I \cdot t \cdot Z \cdot U^5}{d^2}$$

Distance to anode

Photon/matter interaction

Image contrast

Contrast between two regions can be expressed as follows:

$$C = \frac{I_2 - I_1}{I_2 + I_1}$$

It depends on many factors:

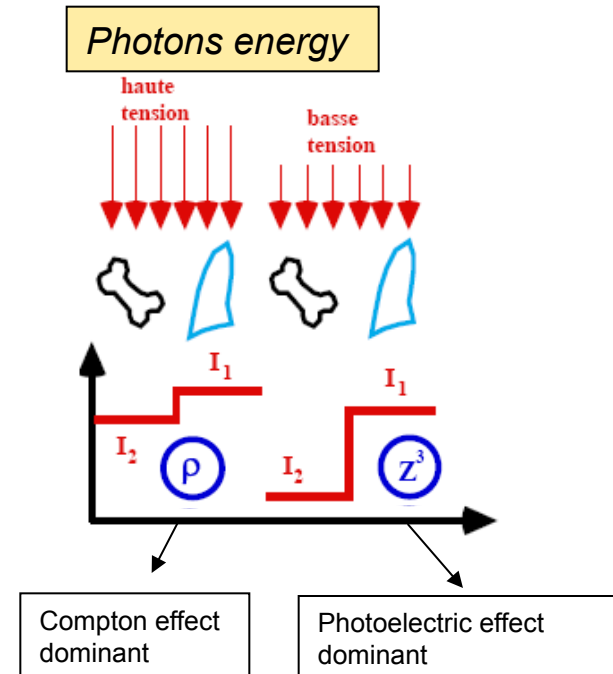
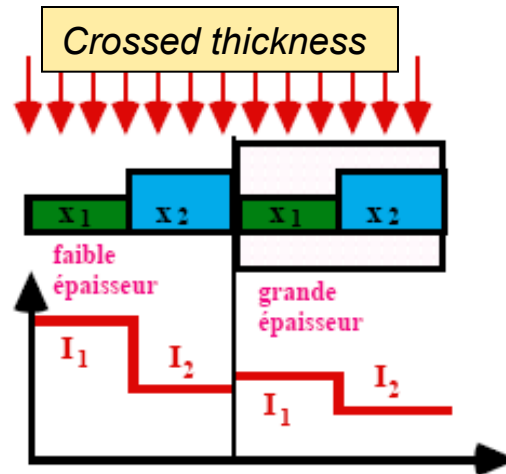
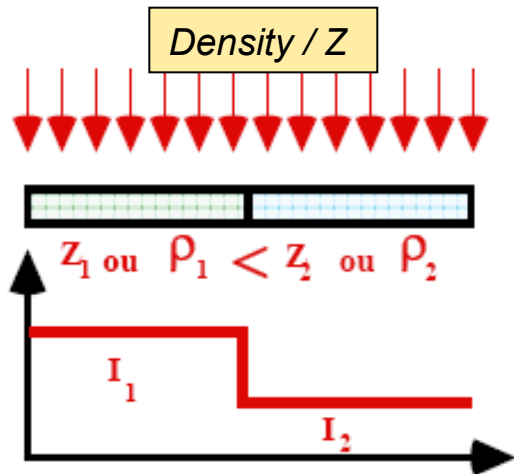
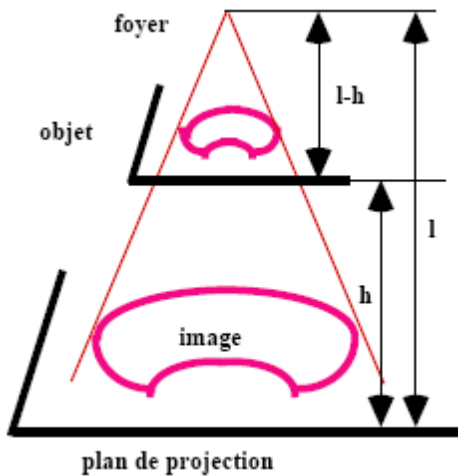
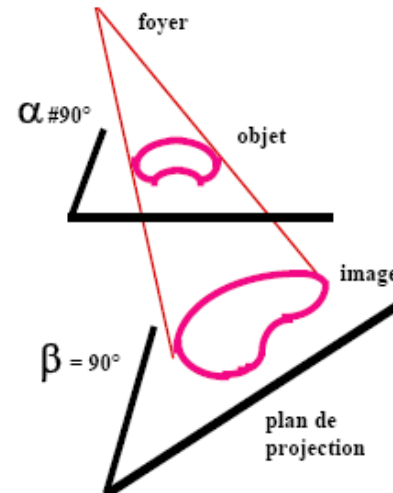

Image formation

Conical projections law:



$$M = \frac{l}{l-h}$$



Deformation if incidence angle is different from projection angle

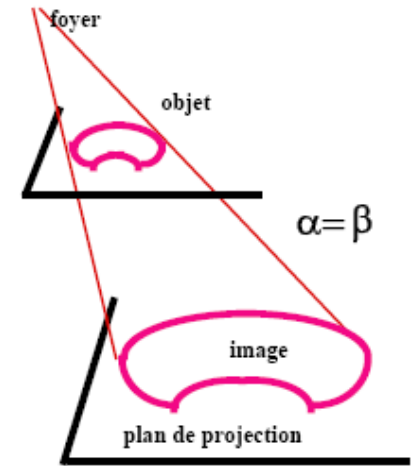

No deformation if incidence angle and projection angle are the same

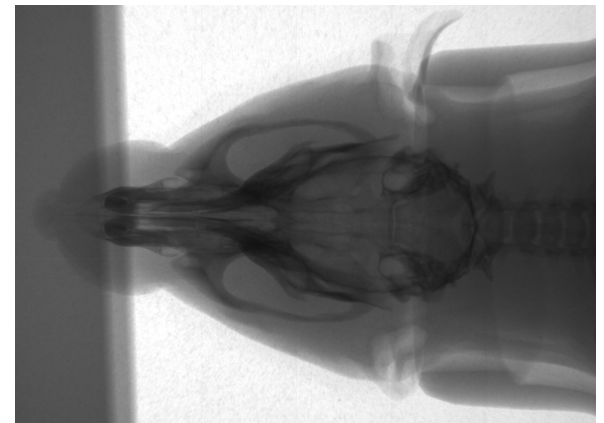
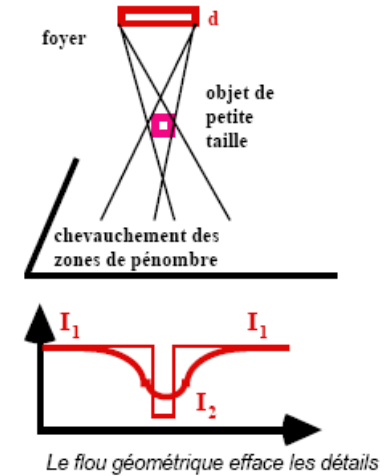
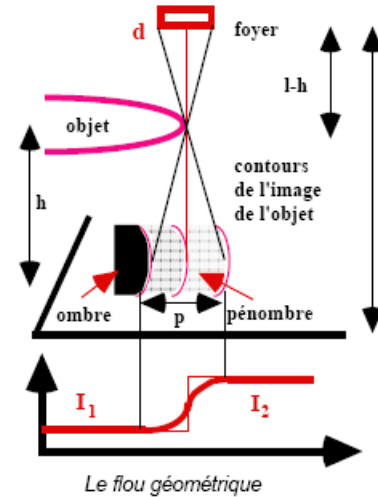

Image formation

Blurr

- geometrical: focal point size



- Kinetic: Organs movement /
Pause time

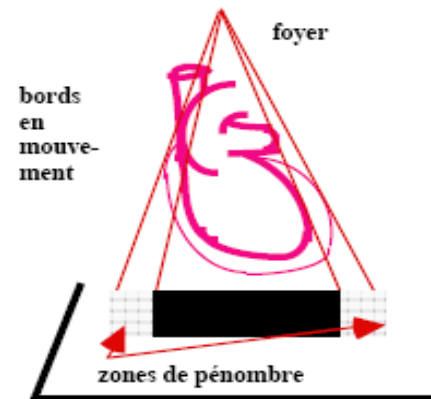

Formation de l' image

Incident beam filtration:

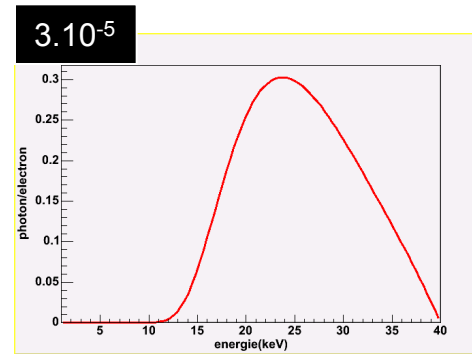
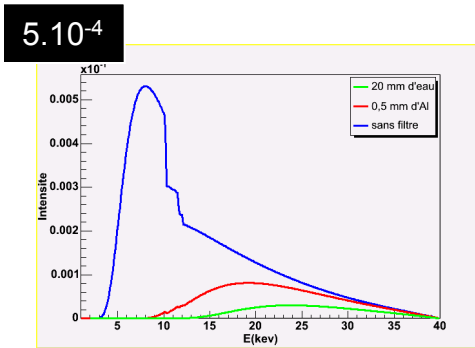

25mm d'eau

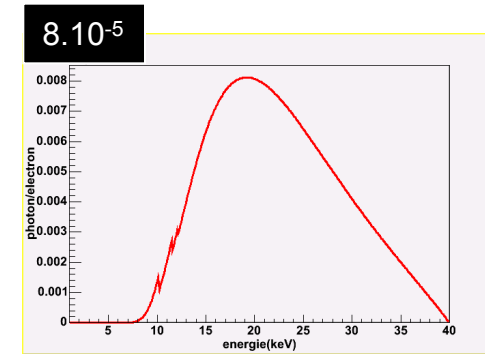

0,5mm d'Al

$$F_m = \frac{K \cdot I \cdot t \cdot Z \cdot U^5}{d^2}$$

Change the voltage of the mAs



From analogical to numerical

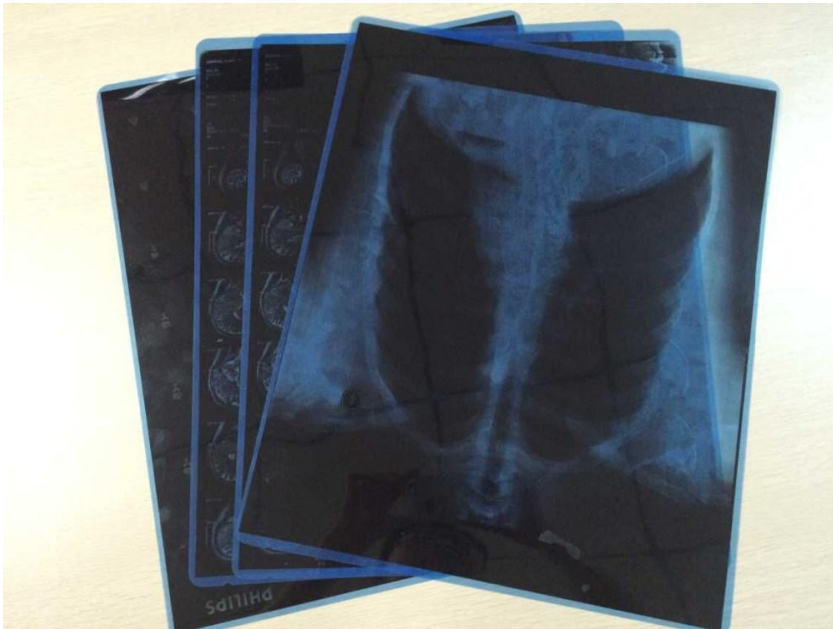

Numerical detection system

Numerical image

Analogical signal

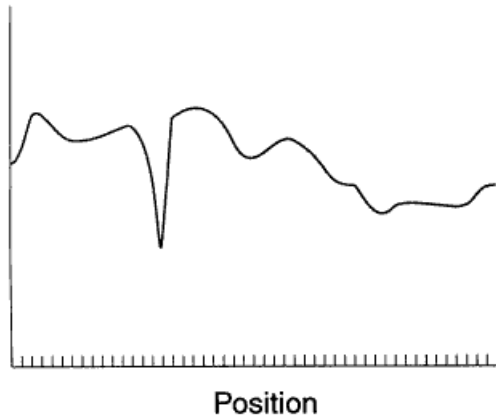

Numerical signal

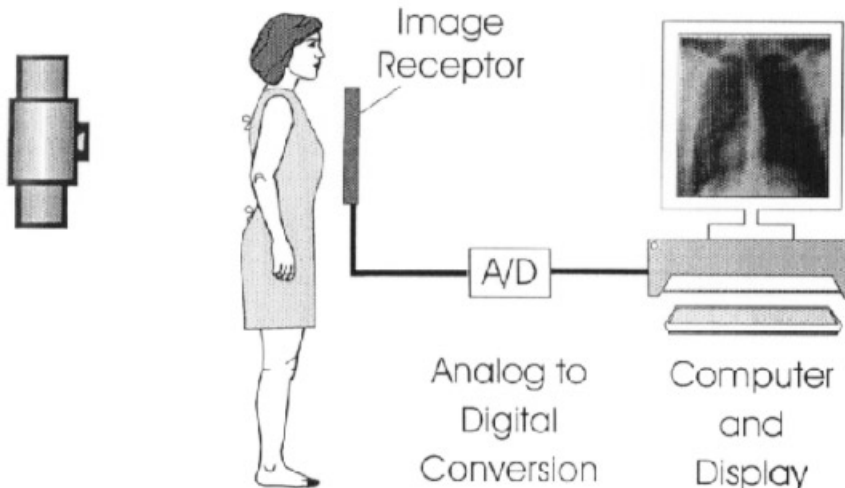
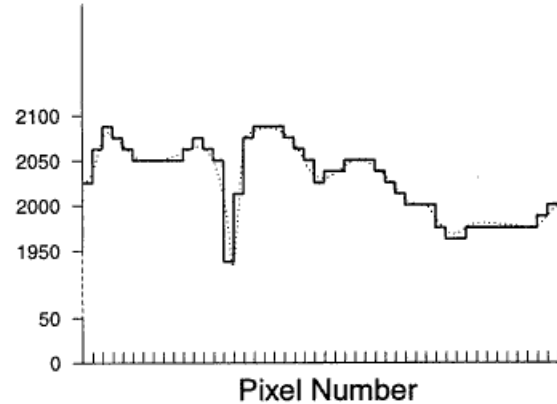

Two parameters:
- Pixel size
- Signal depth

Numerical detection system

Detector properties

Field of view

The field of view should be adapted to the region of interest:

Thorax radiography: 35cm x 43cm

Mammography: 18cm x 24cm ou 24cm x 30cm

Geometrical characteristics

Filling ratio: ratio between active zone and dead zone

Distorsion: for scale adaptation

Numerical detection system

Detector properties

Detection efficiency

$$\eta = 1 - e^{-\mu(E)x}$$

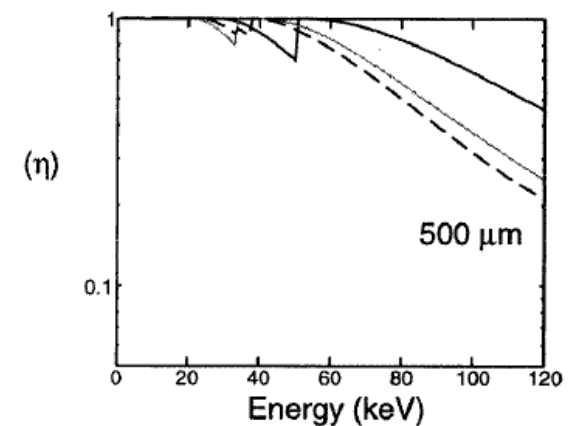
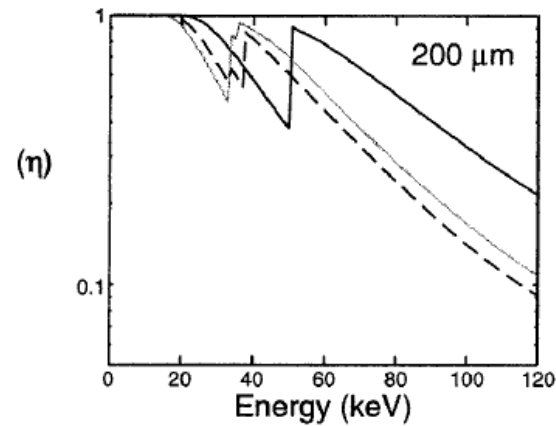
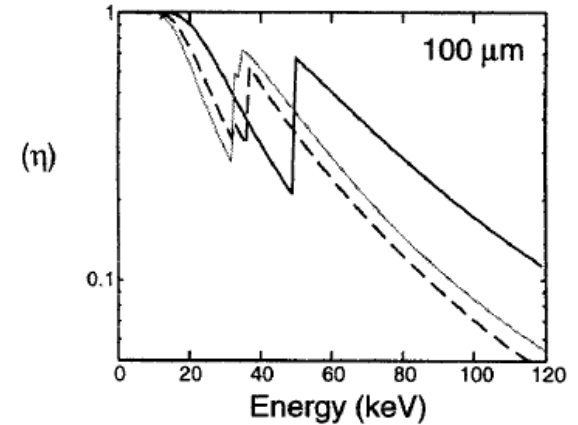
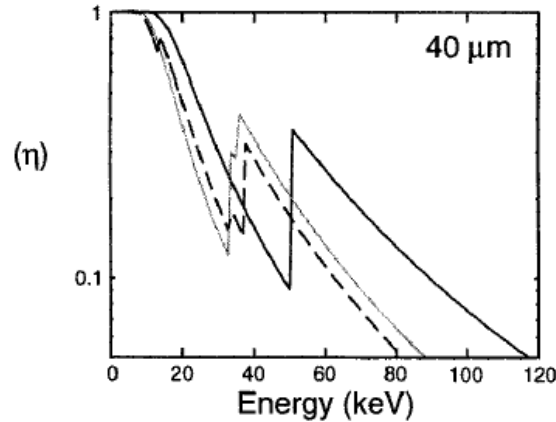

..... CsI:Tl

———— Gd₂O₂S:Tb

---- BaFBr_{.05}I_{.15}:Eu

Numerical detection system

Detector properties

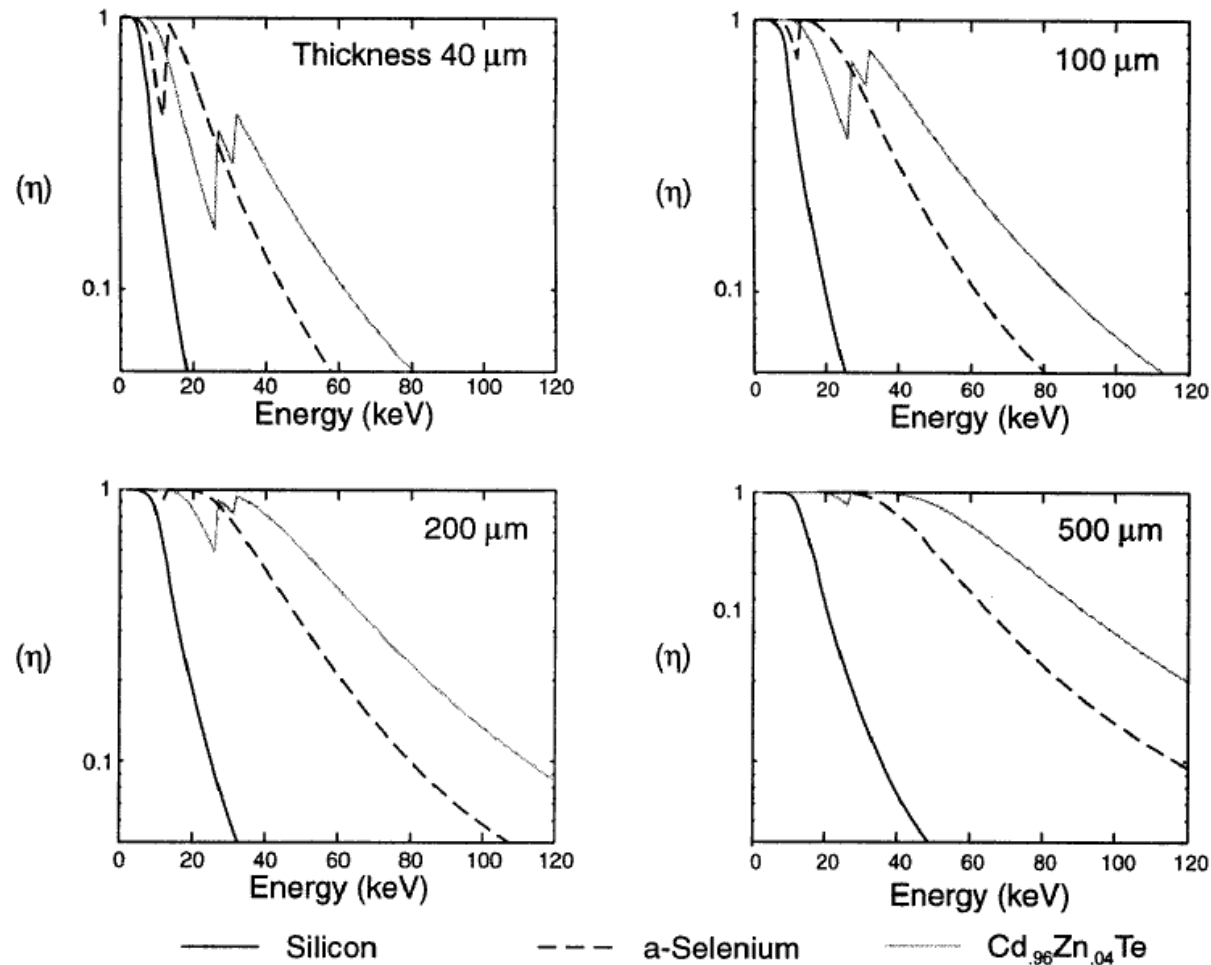

Numerical detection system

Detector properties

Spatial resolution: the smallest distance between two distinguishable points

Detector related factors:

Size of a detection element (pixel),
Distance between two pixels,
Scatter (physics, read-out etc)

Exterior factors:

Focal point,
Magnification factor,
Movement,
etc...

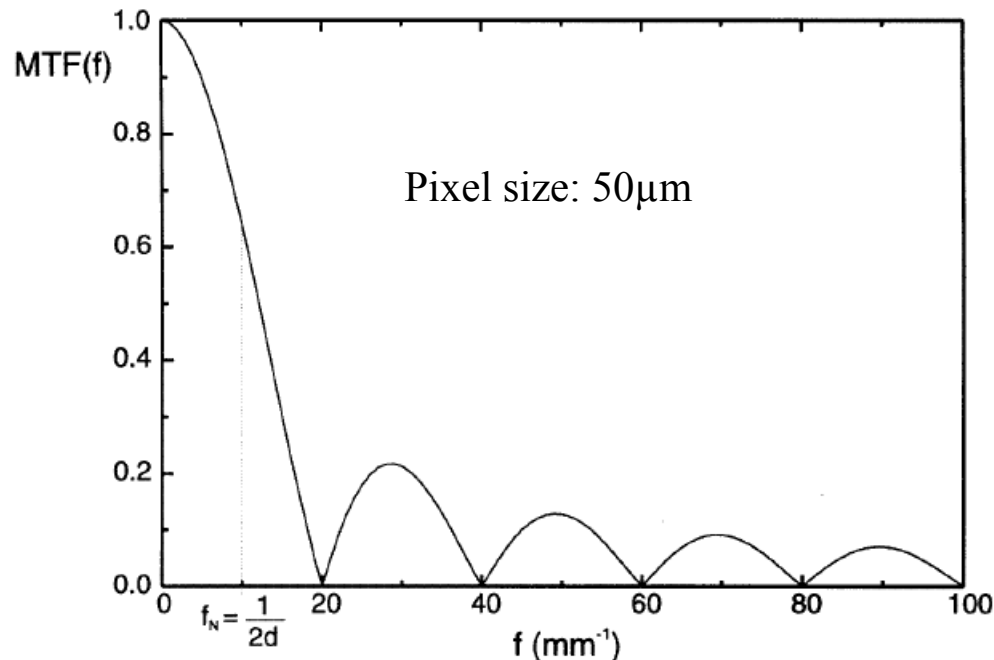

Nmerical image (pixellisation)



48	49	46	42	44
110	79	54	47	48
190	192	190	153	99
150	166	189	203	183
131	140	145	161	165

Pixel value : 0 – 255 (256 values)



One line/column over 2



One line/column over 4

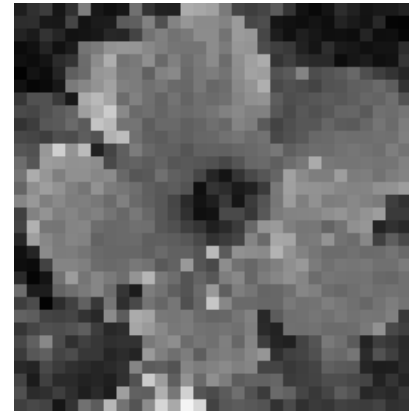

One line/column over 8

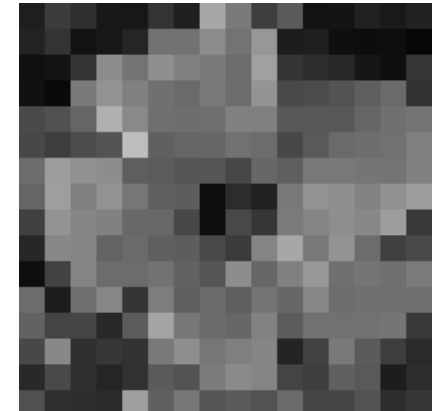

One line/column over 16

Numerical detection system

Detector properties

Noise

$$\sigma = \sqrt{N}$$

Emission X: Poisson law

$$\sigma = \sqrt{\eta N}$$

After interaction: Statistic according to Poisson law

After magnification:

$$q = \eta N \bar{g}$$

Mean gain

$$\text{Variance: } \sigma_q^2 = N\eta(\bar{g}^2 + \sigma_g^2)$$

« Detective quantum efficiency » $DQE(f)$
Ideally, $DQE(f) = \eta$ for all frequencies

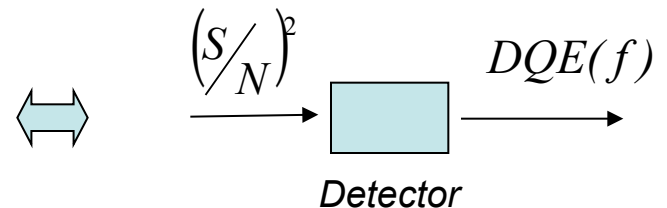

Numerical detection system

Detector properties

Yield

1 photon X \rightarrow ? ϵ lectrons

Required energy to create:
 An optical photon (cristal) or
 An electron-hole pair (semi-conducteur)

Material	Z	E_K (keV)	w (eV)	ω_K (approx.) ^a
CdTe	48/52	26.7/31.8	4.4	0.85–0.88
High-purity Si	14	1.8	3.6	< 0.05
Amorphous selenium	34	12.7	50 (at 10 V μm^{-1}) ^b	0.6
CsI(Tl)	55/53	36.0/33.2	19	0.87
Gd ₂ O ₂ S	64	50.2	13	0.92
BaFBr (as photostim. phosphor)	56/35	37.4/13.5	50–100 ^c	0.86

Probability to have a Characteristic ray

a) Semiconductor, Photoconductor, Intrinsic Phosphor

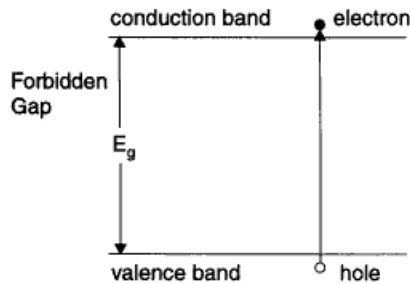

b) Activated Phosphor

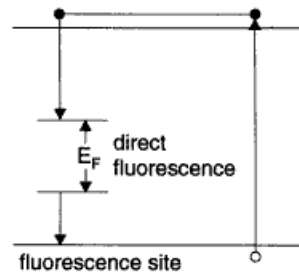

c) Photostimulable Phosphor

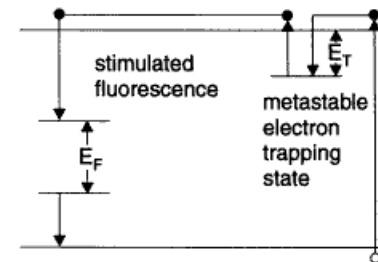

Numerical detection system

Detector properties

Signal dynamic

$$\text{Dynamic} = \frac{X_{\max}}{X_{\text{bruit}}}$$

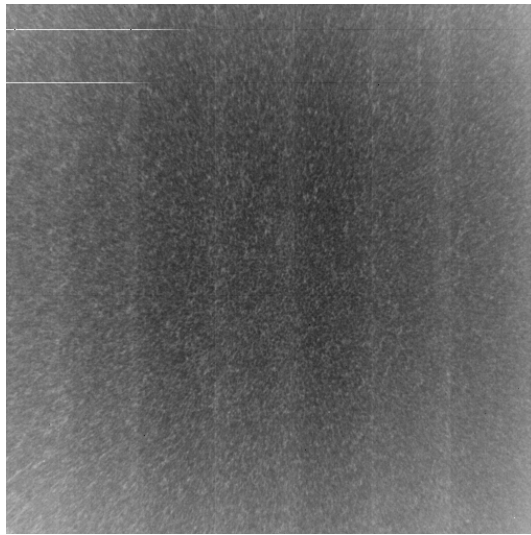
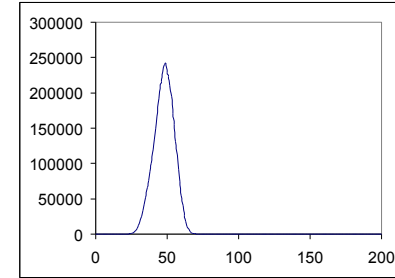
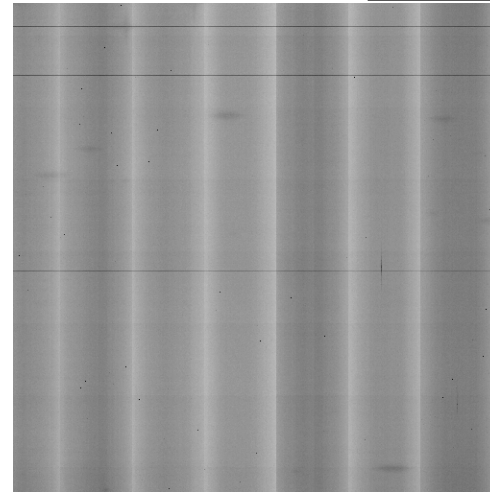

Electronic noise

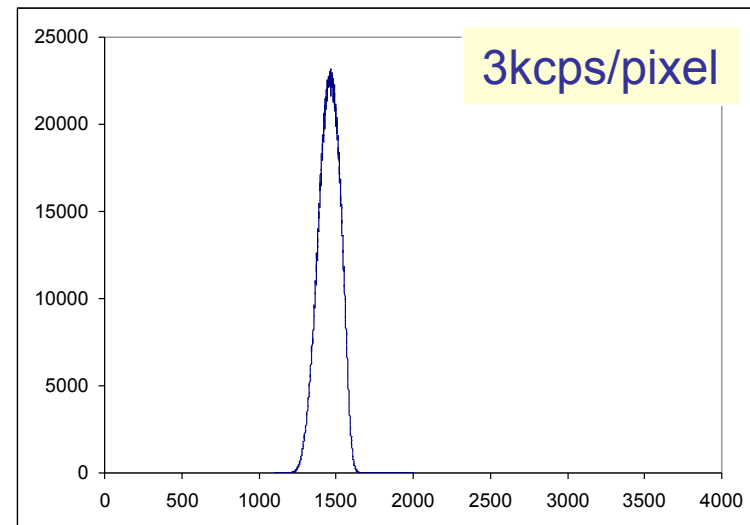

Full fluence (40kV, 250μA, 0,5mm Al, 470ms)



Numerical detection system

Detector properties

Uniformity

Read-out band

Defectuous point

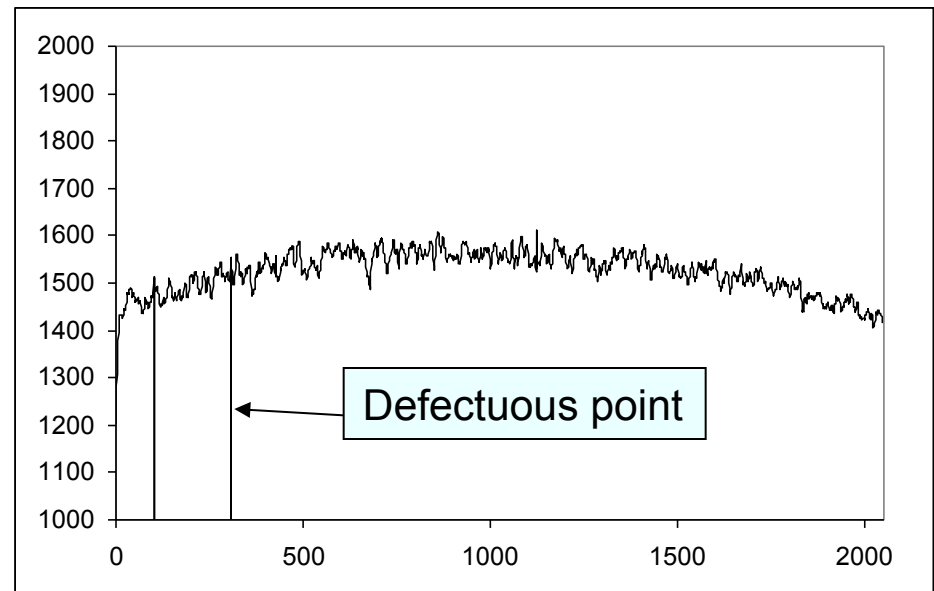
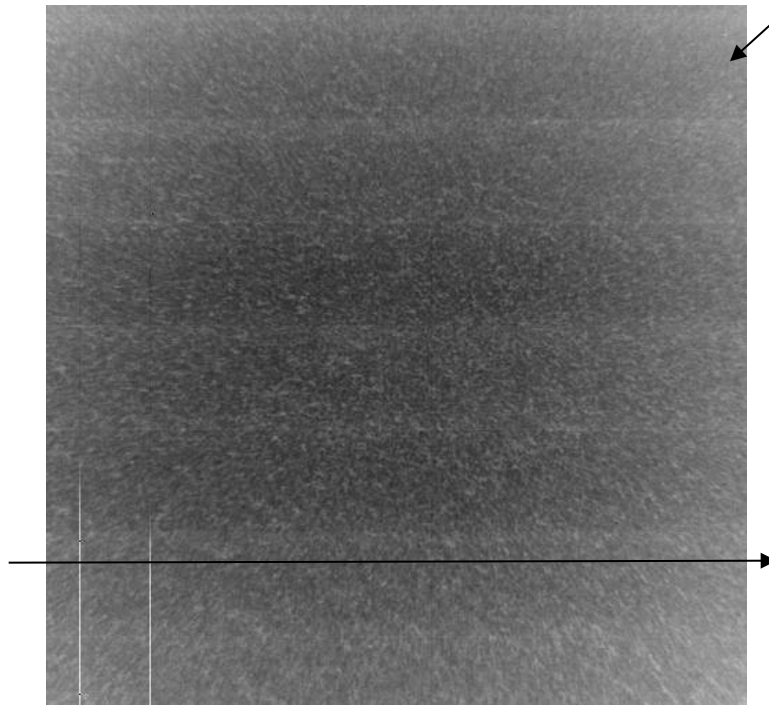

Numerical detection system

Conversion of the radiant image can be **direct** or **indirect**

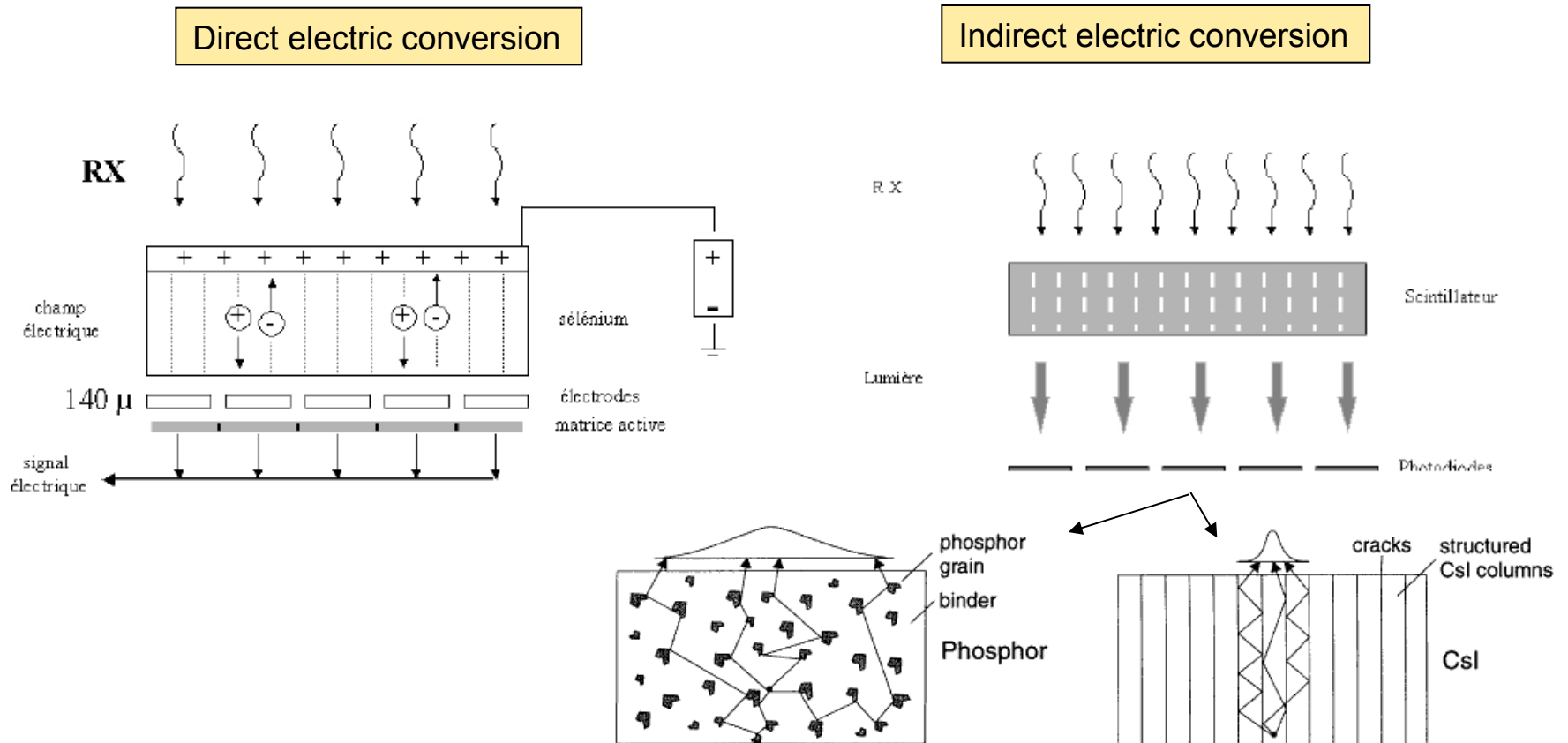

Numerical detection system

Indirect method

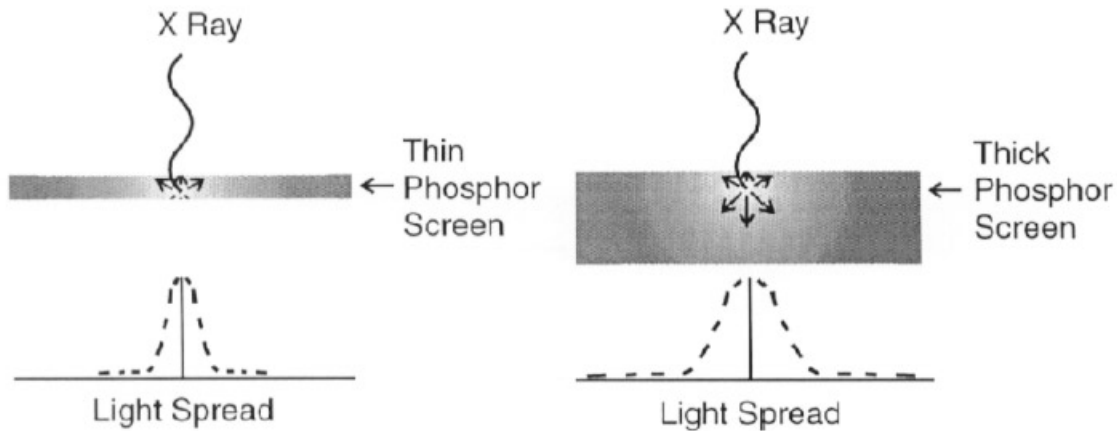

Coupling with a photodetector

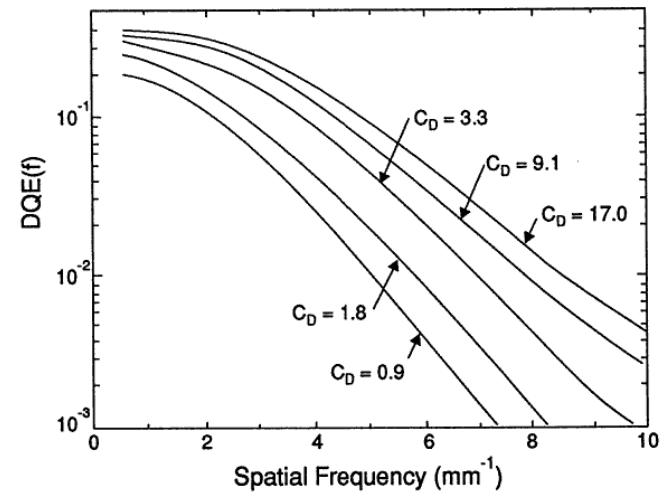

Figure 11. Effect of optical coupling efficiency on $DQE(f)$ of a phosphor-fibre optic-CCD detector. C_D is the number of electrons produced in the CCD per x-ray interacting in the phosphor. (From Maidmont and Yaffe 1994.)

X-ray scanner

Historical overview

1971 : First brain scanner exam

1974 : First full-body apparatus

1979 : Nobel price in medicine attributed to Allan MacLeod and Godfrey N. Hounsfield for the first scanner set-up

1989 : Helicoïdal acquisition

1992 : Simultaneous acquisition of two slices by rotation

1998 : Multi-slices acquisition

In summary, during these 30 years, progress allowed to :

- Gain a factor of 1000 in acquisition speed and reconstruction
- Gain a factor of 30 in terms of spatial resolution and to improve considerably the contrast
- Improve the patient comfort by reducing the exam duration

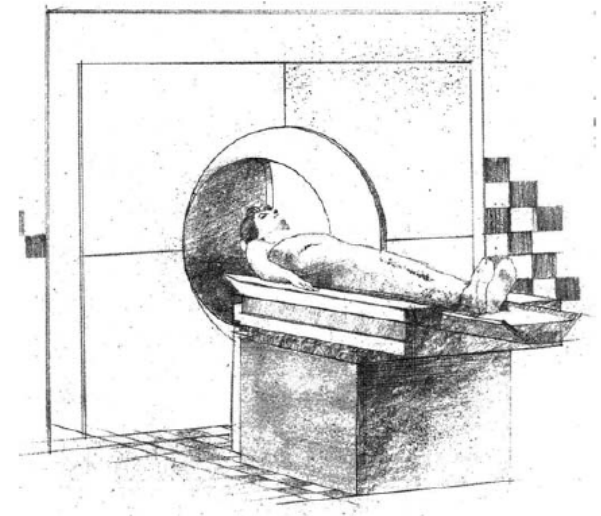

X-ray scanner

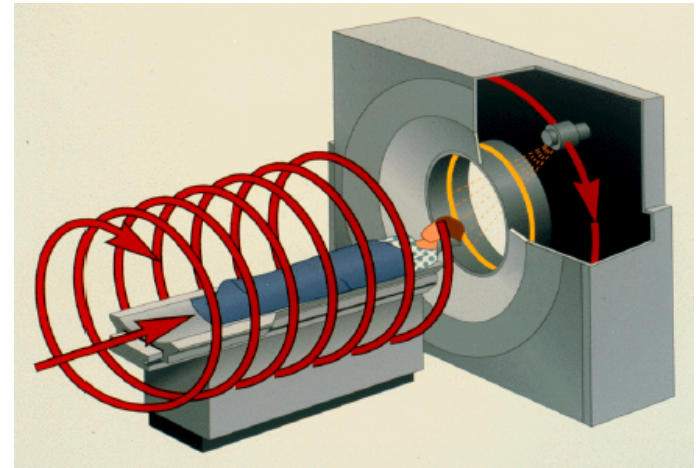
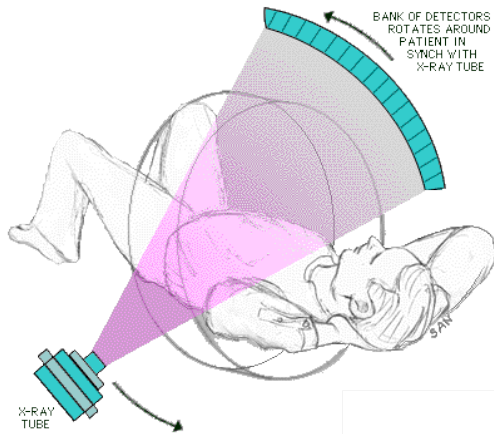
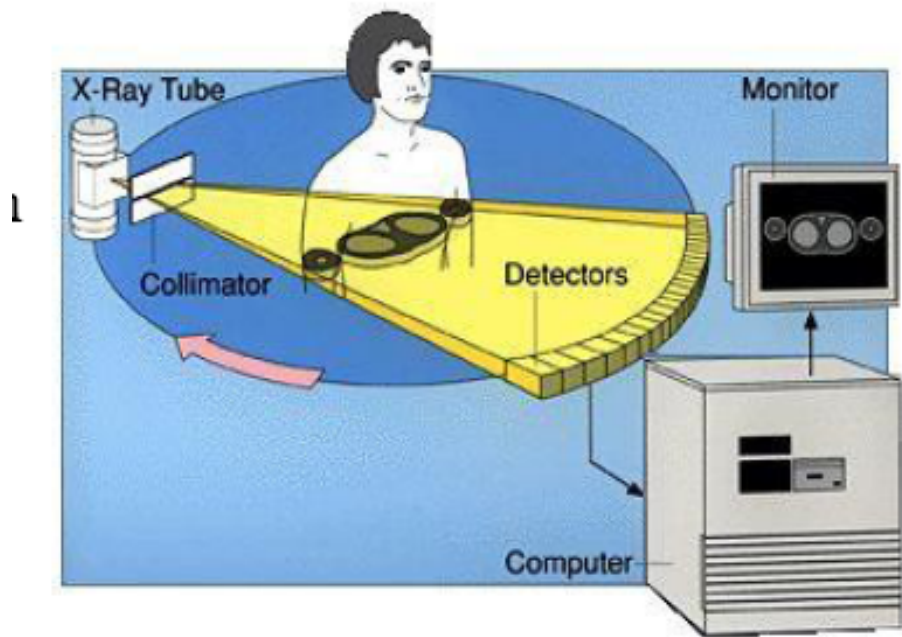

X-ray scanner

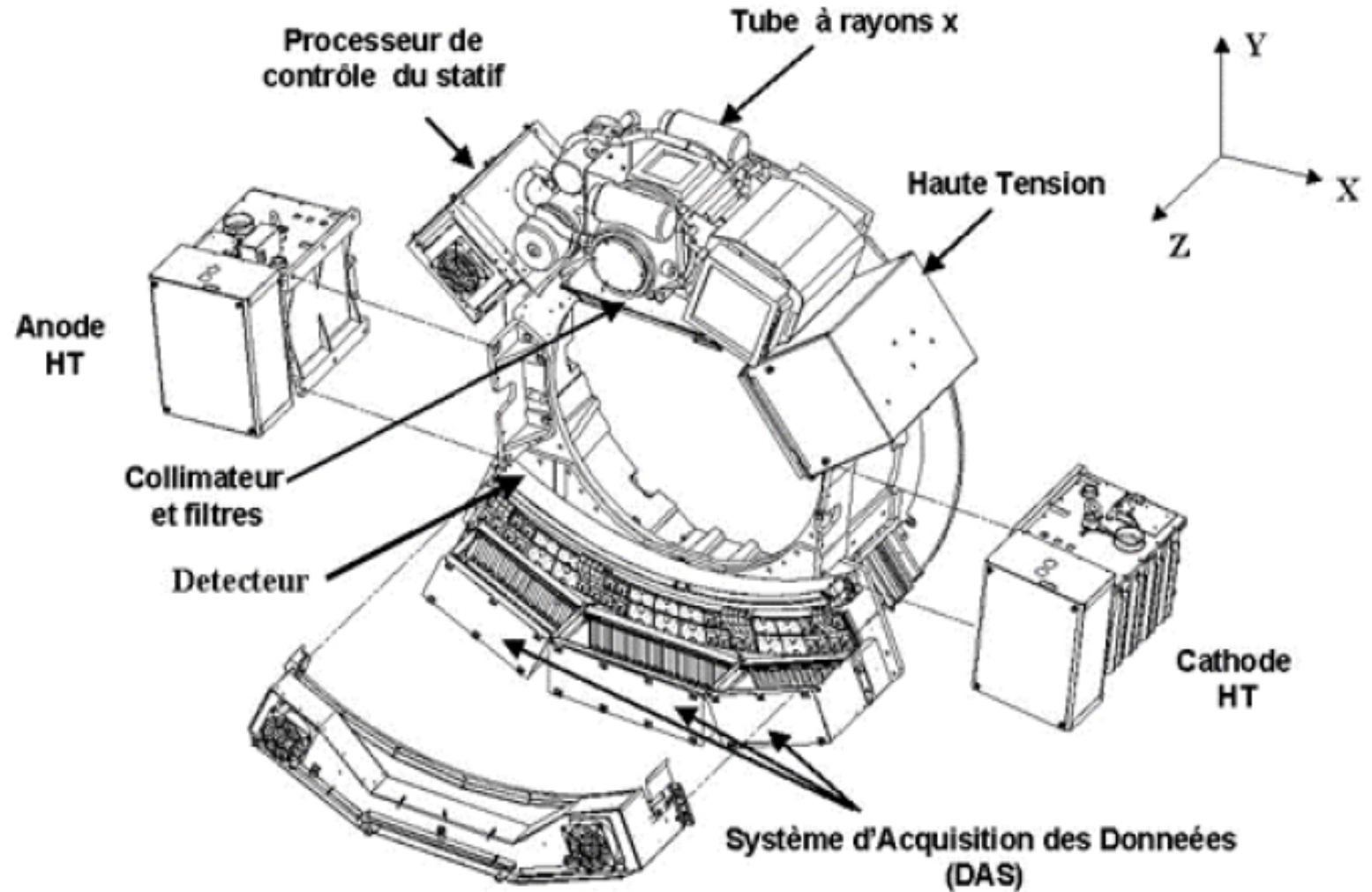

X-ray scanner

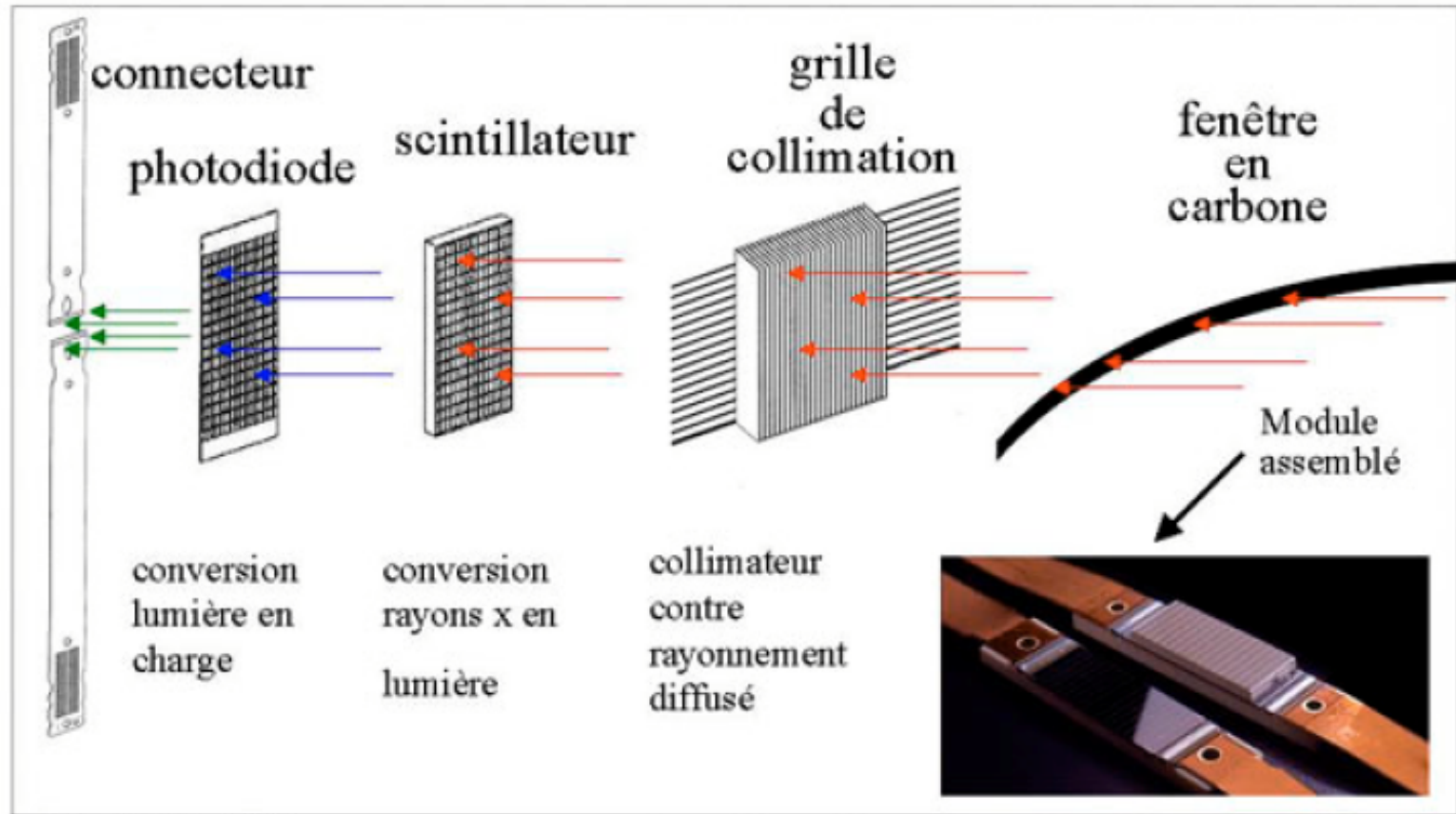

X-ray scanner

Spiral acquisition

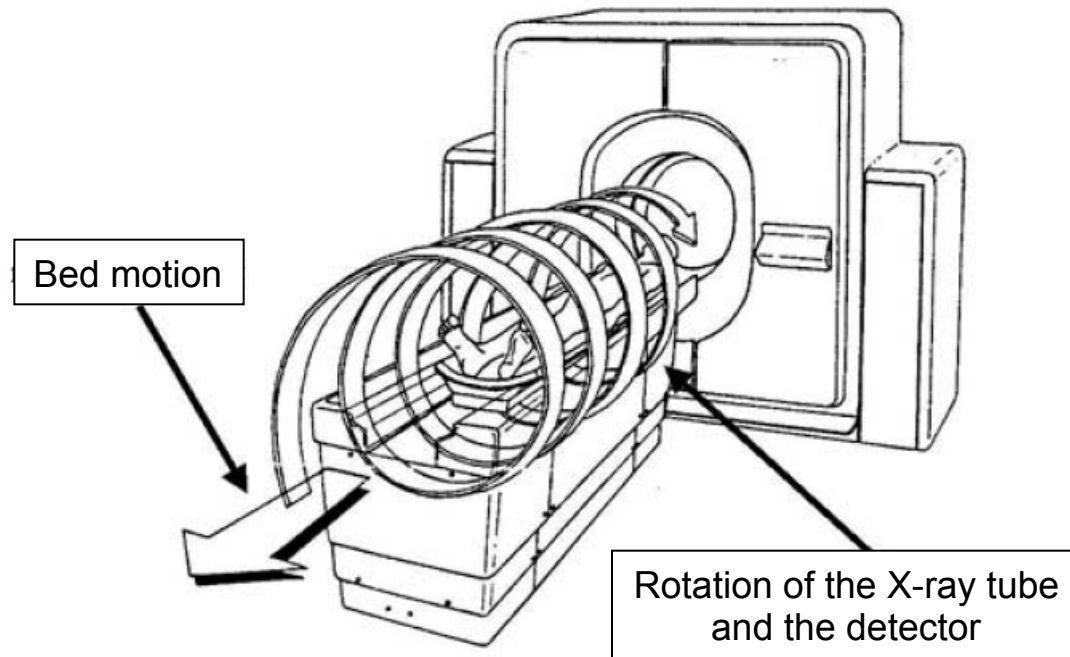

Collimation opening window width : It is the physical width of the collimation in the center of the acquisition.

Table displacement velocity during acquisition (in mm/sec),

The pitch : It is the ratio between the distance crossed by the table during a 360° rotation and the collimator width (ex : during an acquisition of a pitch 1, the exam table would move by a distance equal to the collimator opening window width).

Effective slice thickness: It is the Full Width Half Measurement (FWHM) of a slice profile.

X-ray scanner

Spiral Acquisition

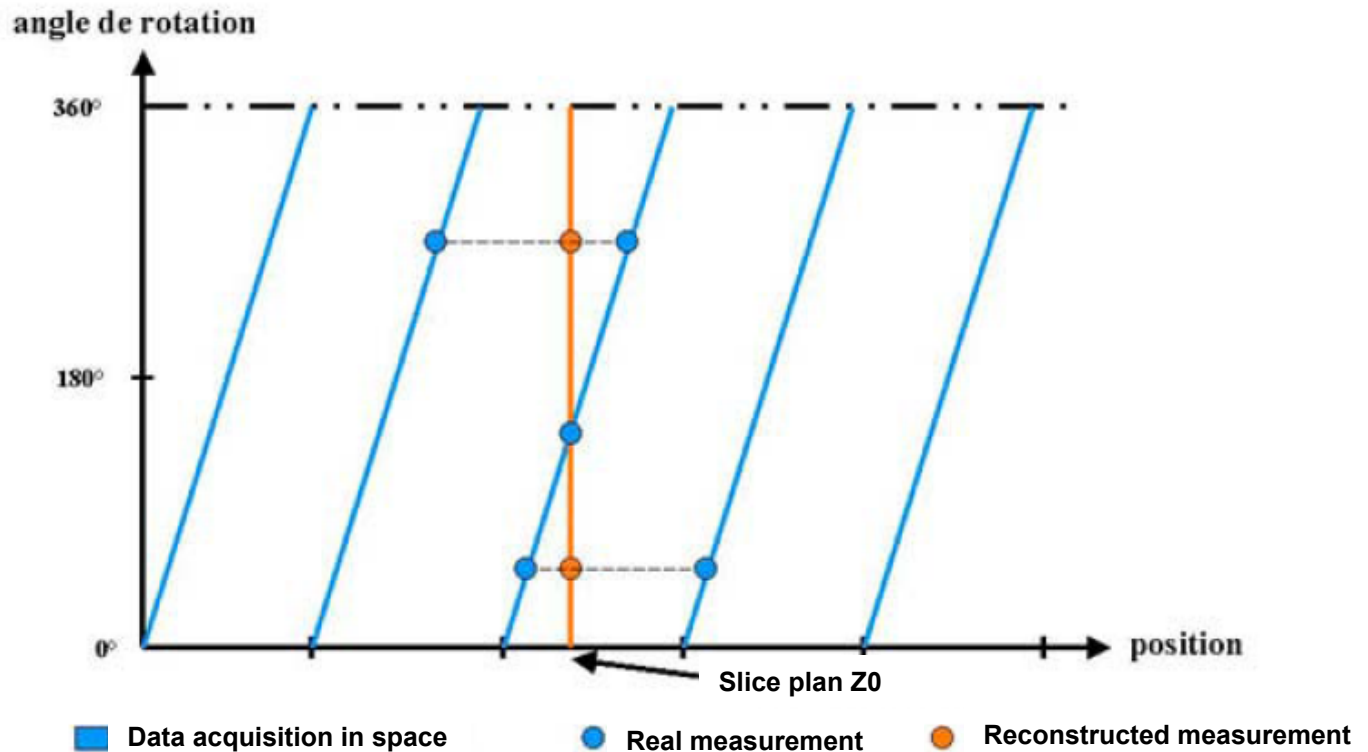

X-ray scanner

Spiral acquisition, multi barrettes

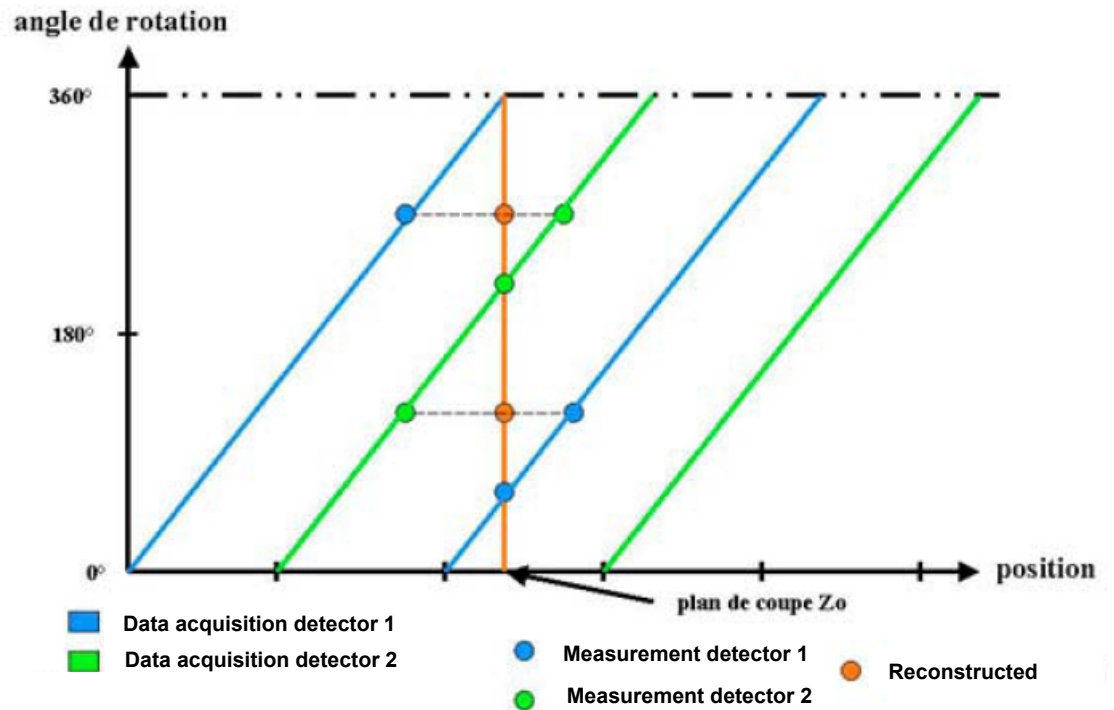
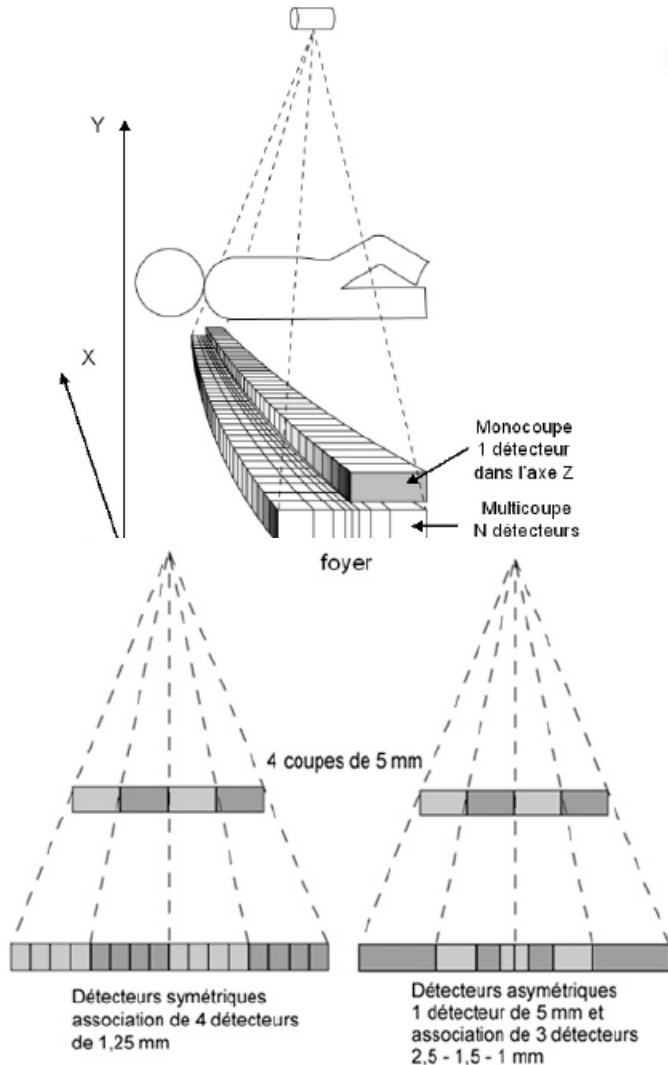

X-ray scanner

$$H = \frac{\mu - \mu_{eau}}{\mu_{eau}} \cdot 1000$$

Hounsfield units / CT Numbers

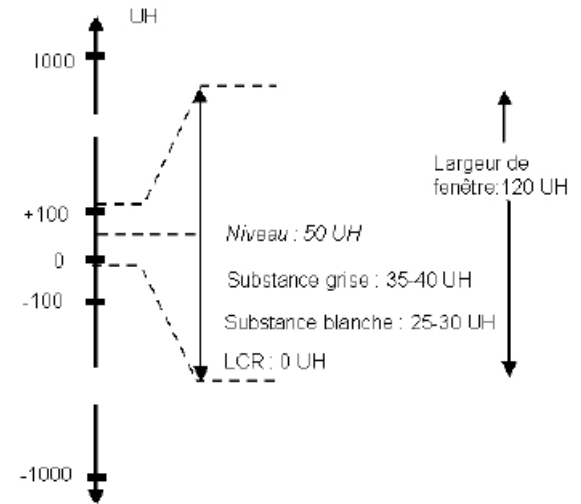
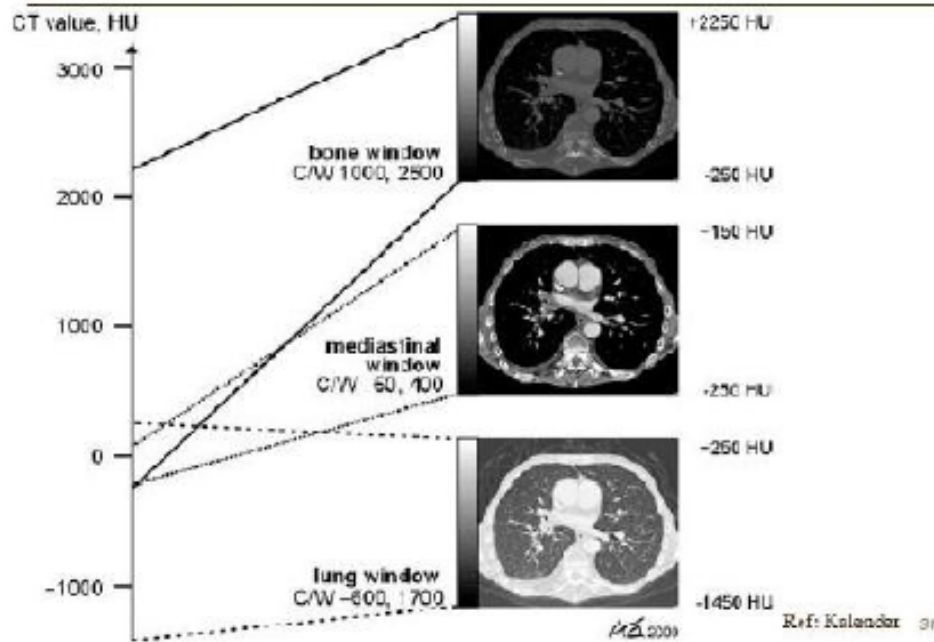

Exemple de niveau et de largeur de fenêtre pour l'étude du parenchyme cérébral

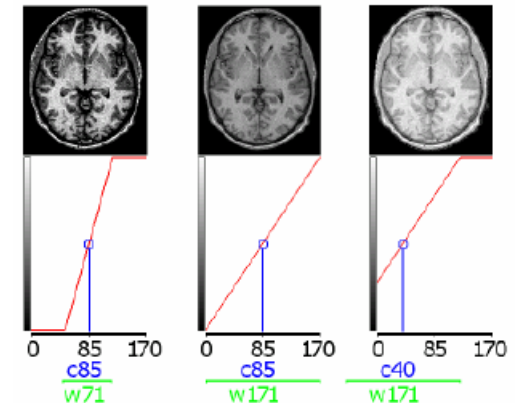

Exemple: Projection vs Tomography

Projection



Pulmonar radiology

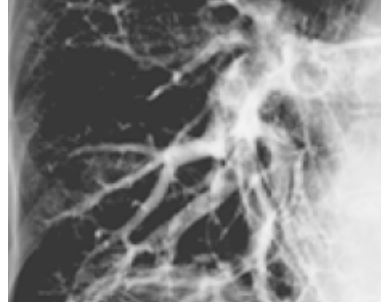

Angiography

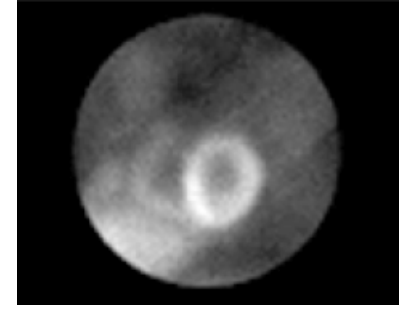

Cardiac Scintigraphy

Tomography

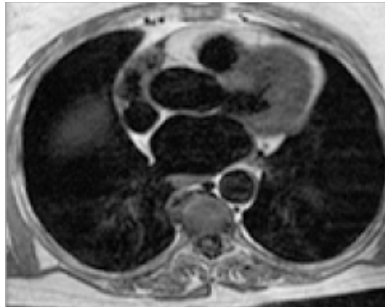

IRM

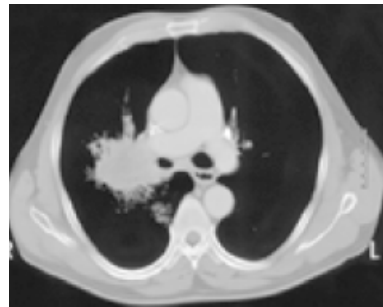

Scanner

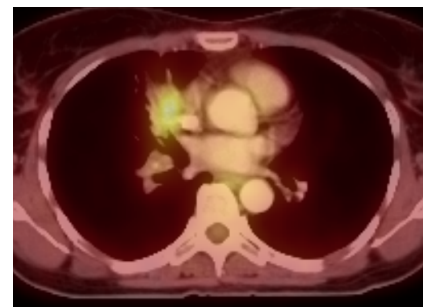

Pet/Scanner

X-ray scanner

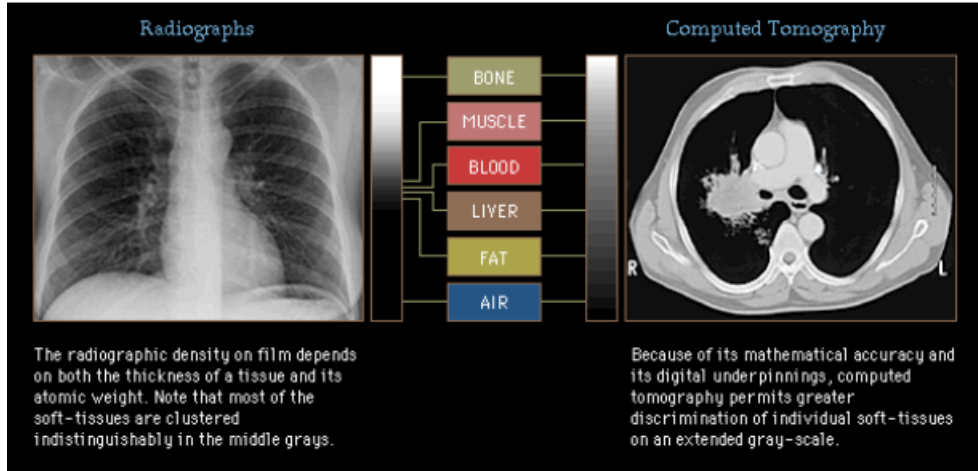

ischémie



angiography



Cardiac exam

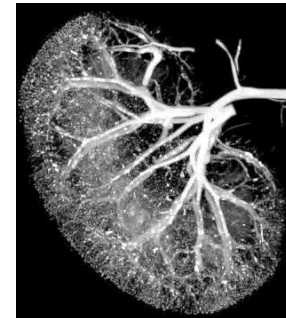

Kidney (rat)

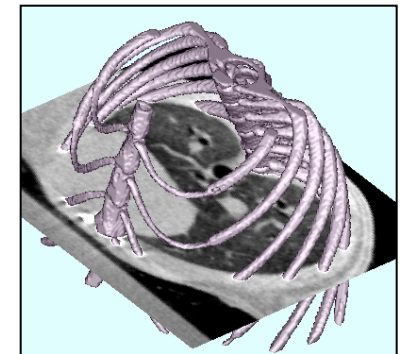

Rib cage (mouse)

X-ray scanner

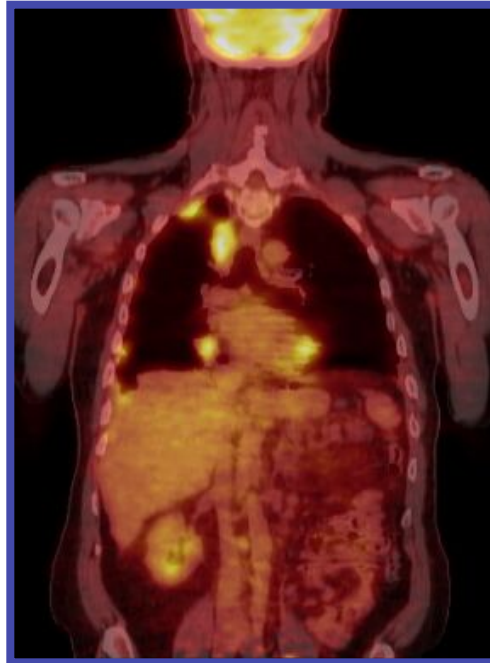
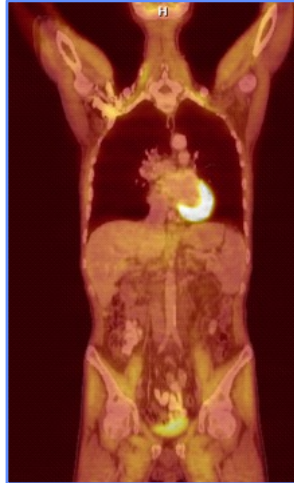

PET/CT fusion

Anatomy reference system

