

The Compact Muon Solenoid Detector

Piotr Traczyk
NCBJ Warsaw/CERN

CMS detector overview

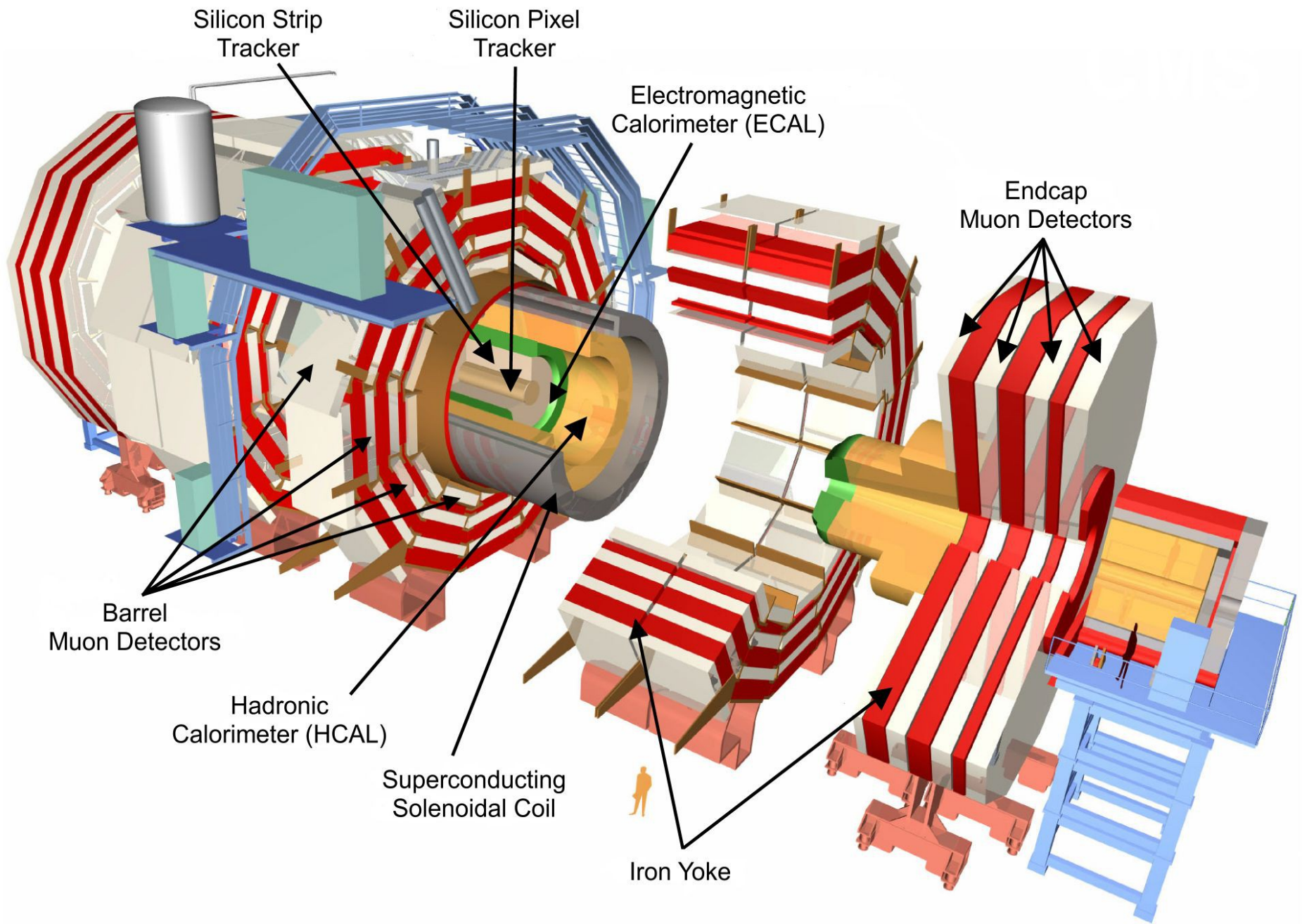

The CMS Solenoid

- CMS is built around a superconducting solenoid generating a magnetic field of 4 Tesla
- The current necessary for this - 20 kA...
- Superconducting NbTi wire cooled to $\sim 4\text{K}$
- 13m length, 6m inner diameter - enough to fit the tracker and calorimeters inside
- (cost ~ 80 MCHF)

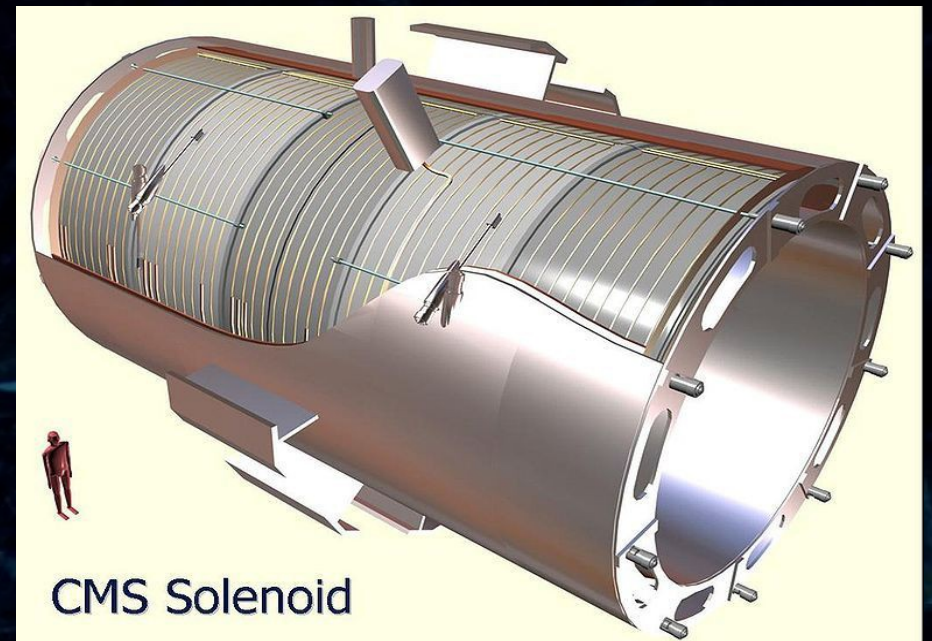

Magnets in particle detectors

ATLAS A Toroidal LHC Apparatus

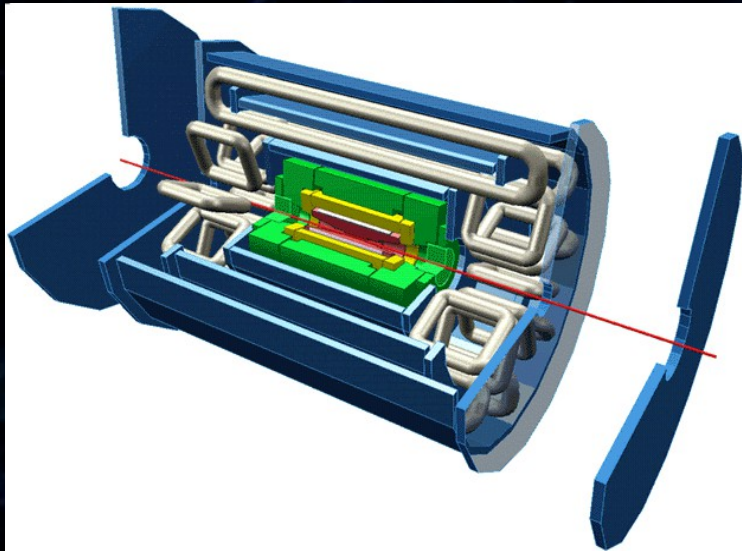

CMS Compact Muon Solenoid

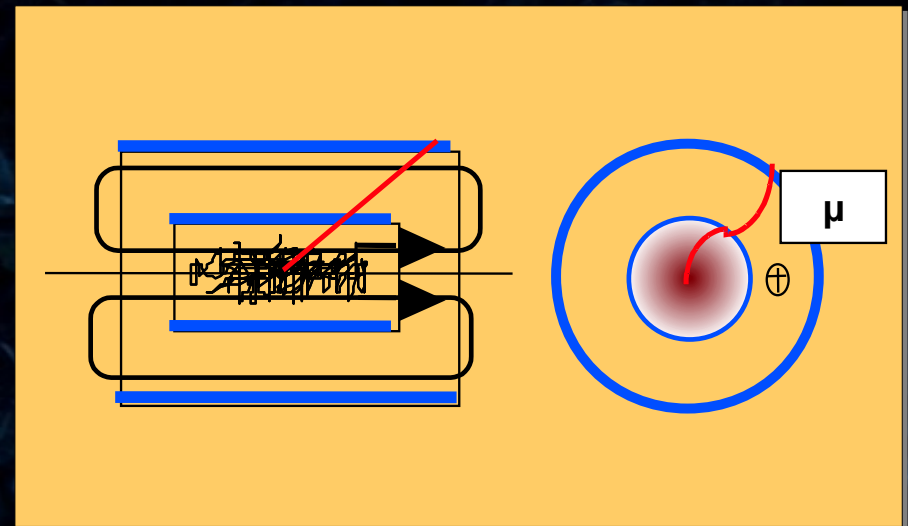
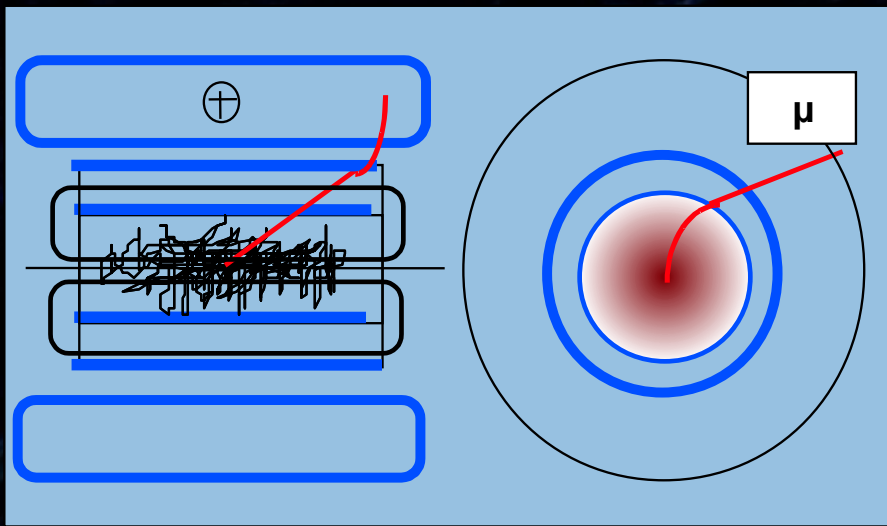
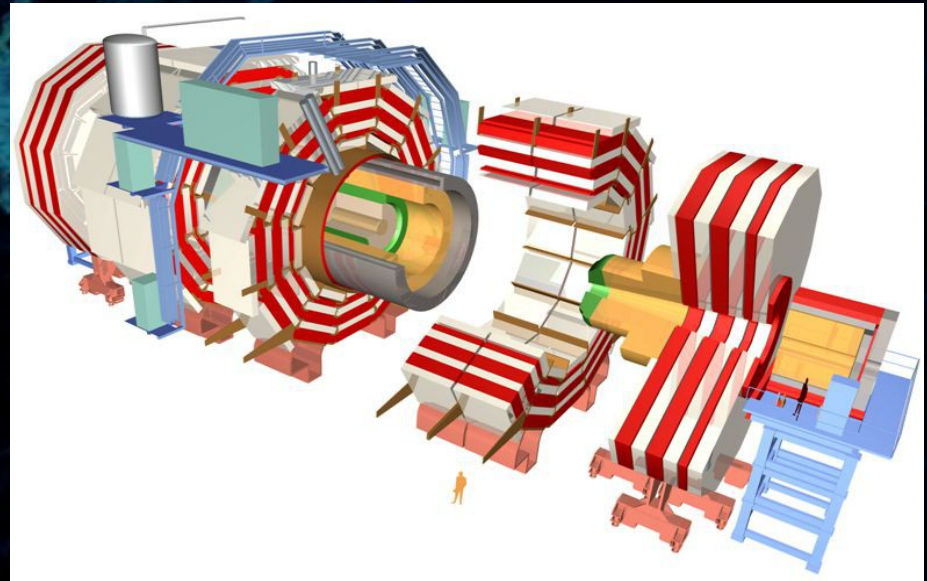

Two ways to detect a particle

(in CMS)

Two ways to detect a particle

(in CMS)

See the track



Or

Catch



Two ways to detect a particle

(in CMS)

Tracking detector



Or

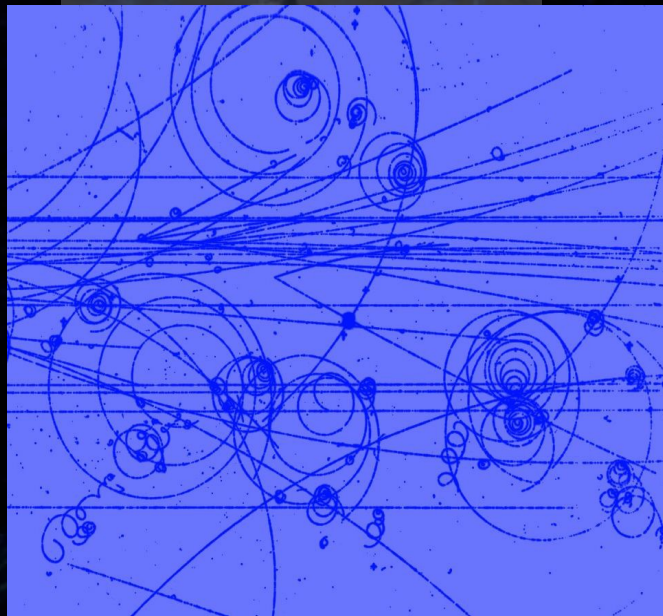
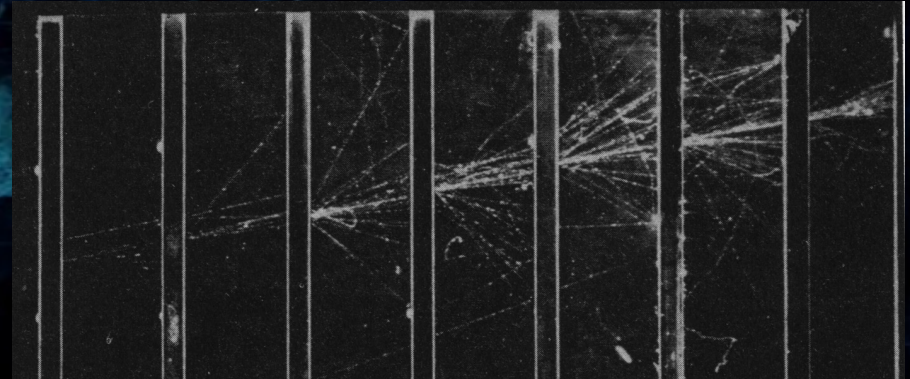

Calorimeter



Particle identification in CMS

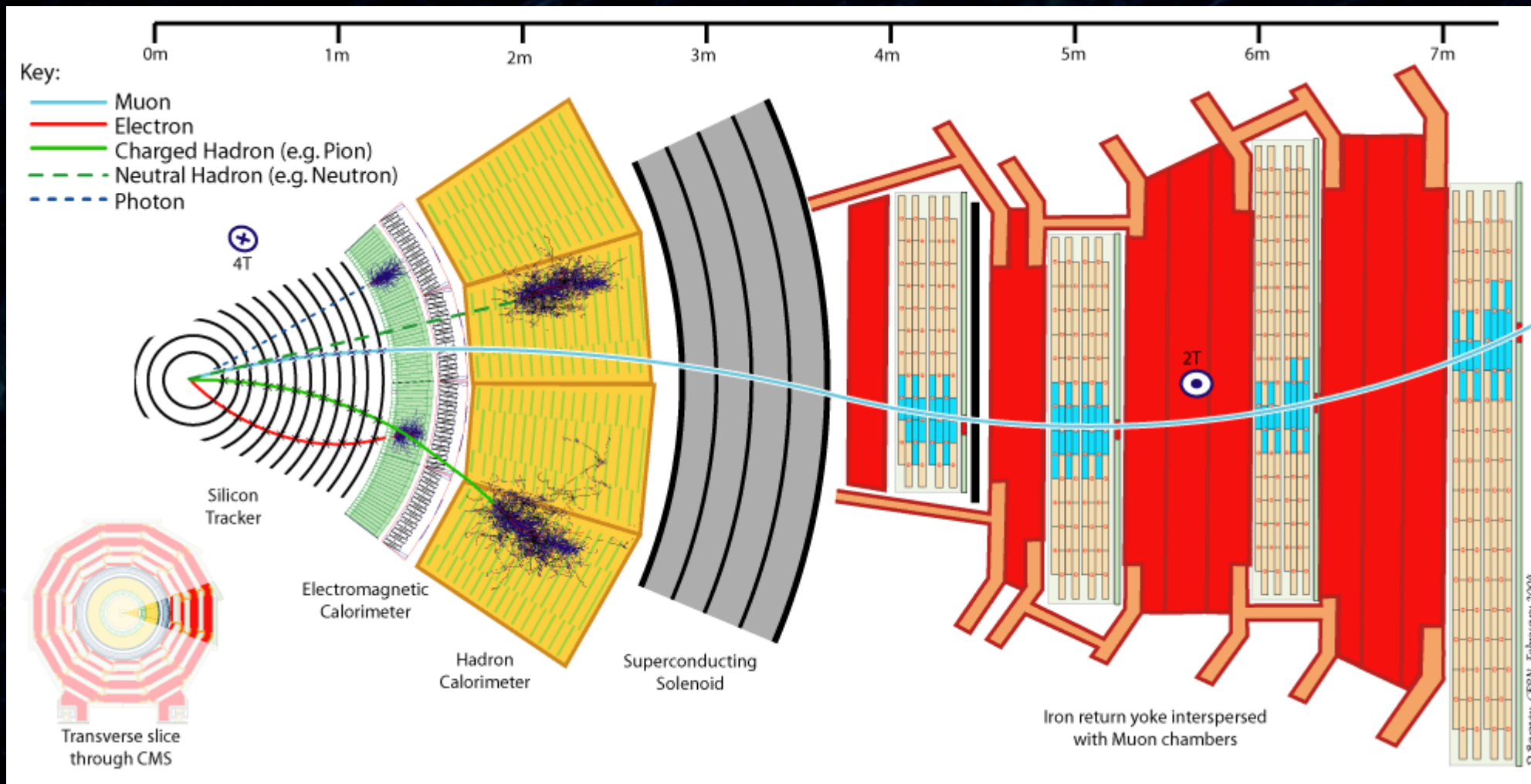

The Inner Tracker

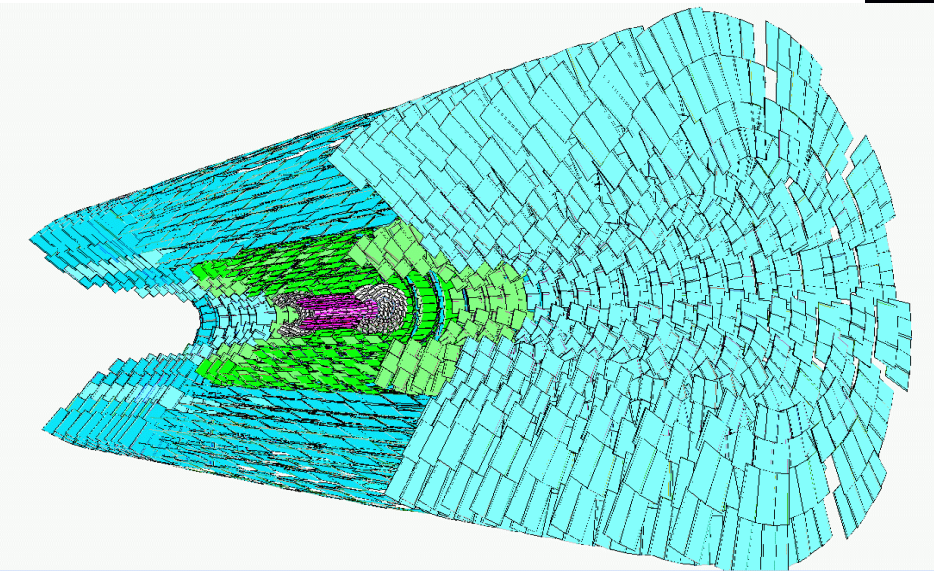
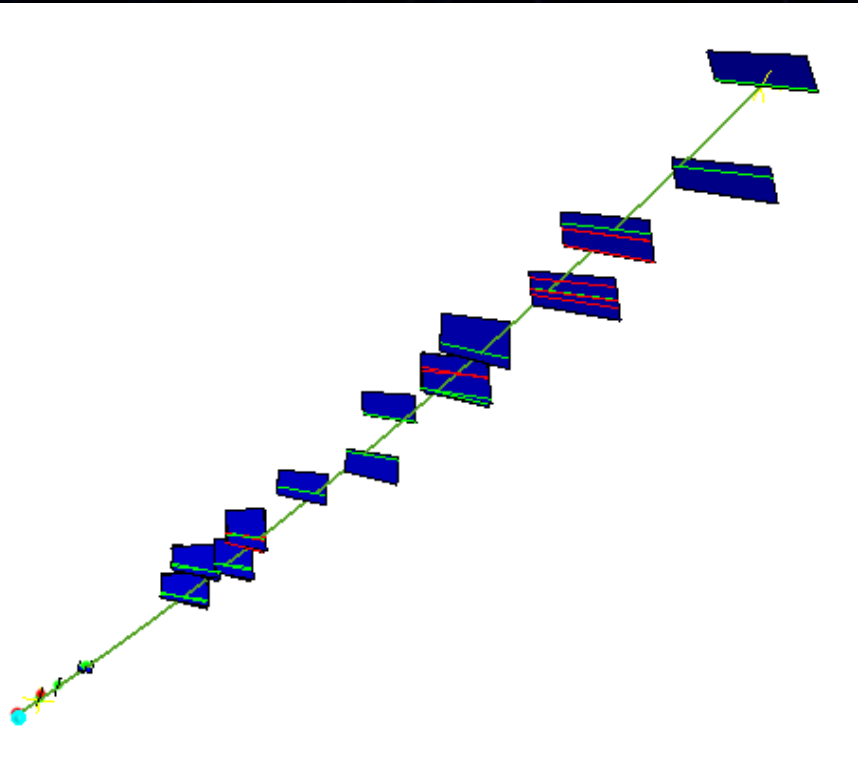

- Measures the trajectories of charged particles
momentum = 1/curvature
- The biggest silicon detector in history, over 220m² of silicon
- Inner part - 3 layers of pixel detectors, outer part 10-11 layers of silicon microstrips
- ~~75~~ 141 millions of read-out channels

Event „pile-up“

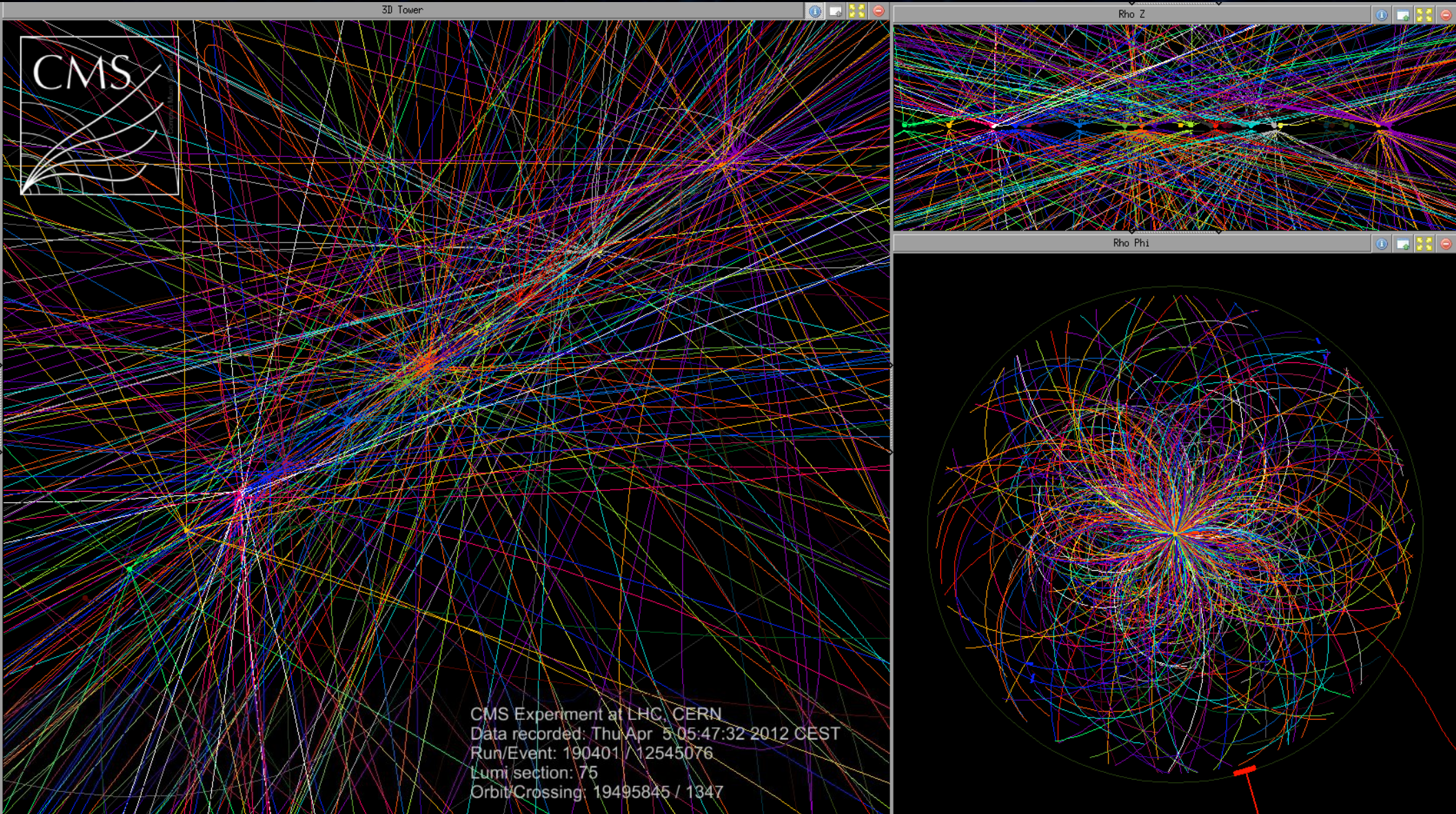

In the LHC, several proton-proton collisions can occur in a single bunch crossing (The image shows an event with 29 reconstructed vertices)

Electromagnetic Calorimeter

- Electron and photon energy measurement
- $\sim 75\,000$ PbWO_4 crystals
- Homogeneous detector - crystals act as both the absorber and the scintillator
- Very good energy resolution

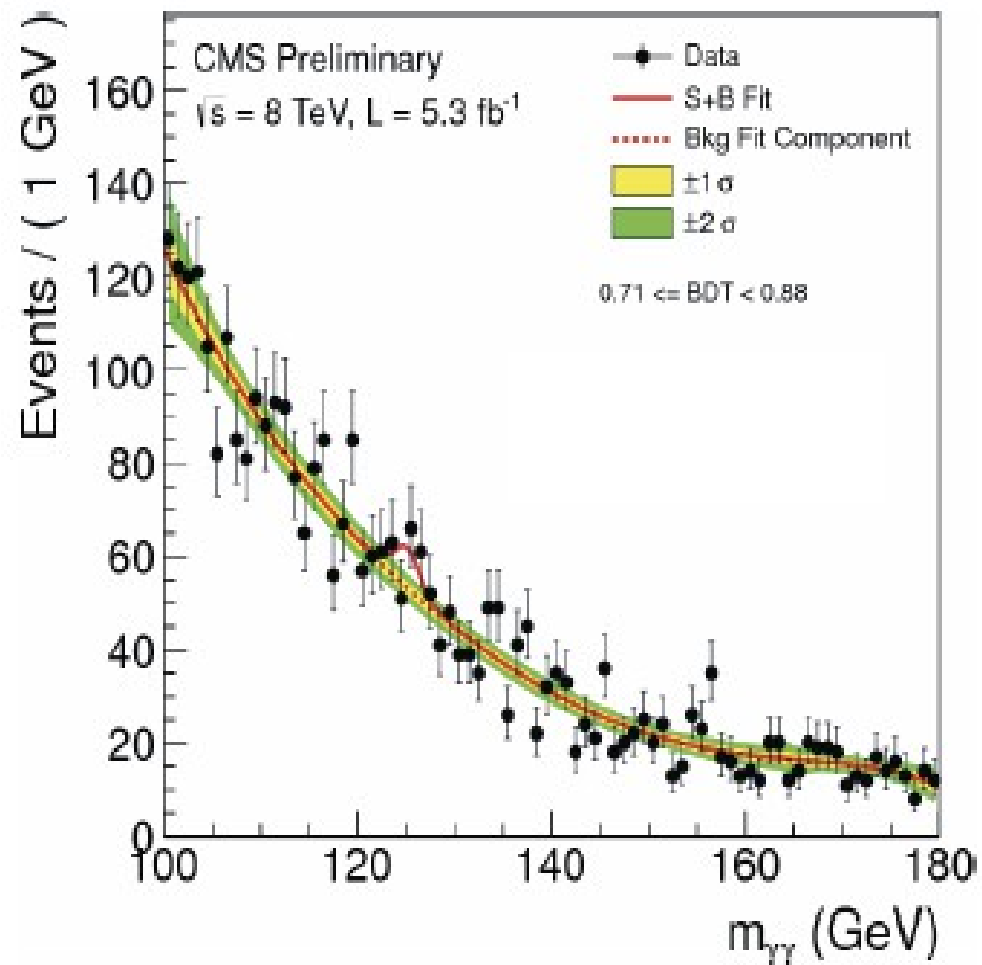
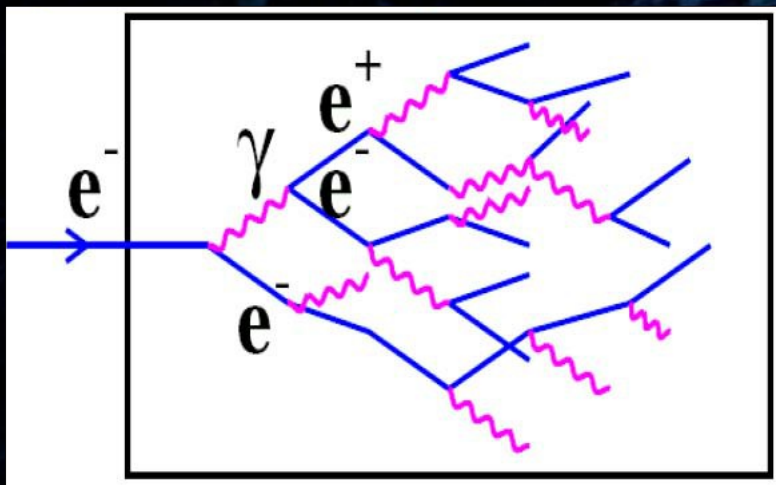

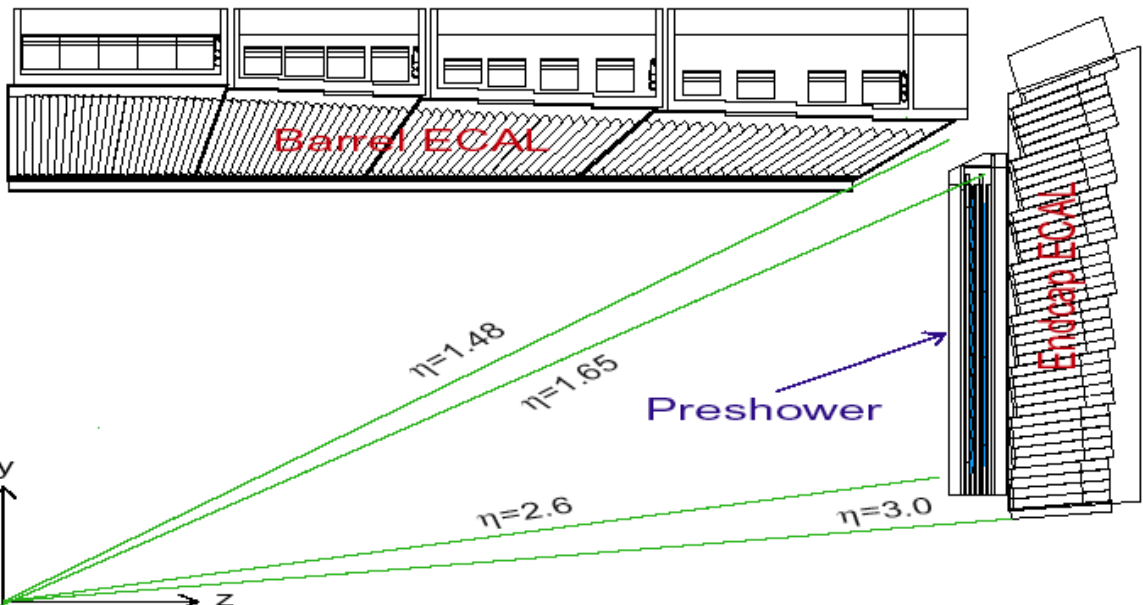

Figure 2: A section through one quadrant of the ECAL.



CMS Lab 27
PH.CMA
CERN

Hadron Calorimeter

- Jet energy measurement
- Brass absorber interleaved with scintillator layers
- Steel blocks with embedded quartz fibers in the „forward“ part

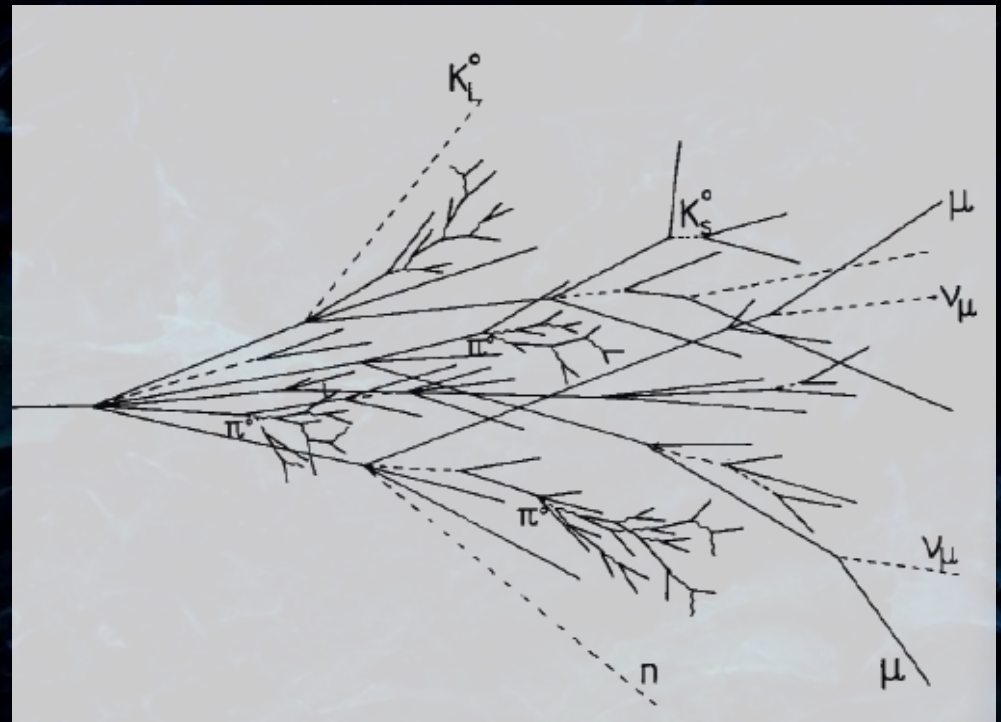
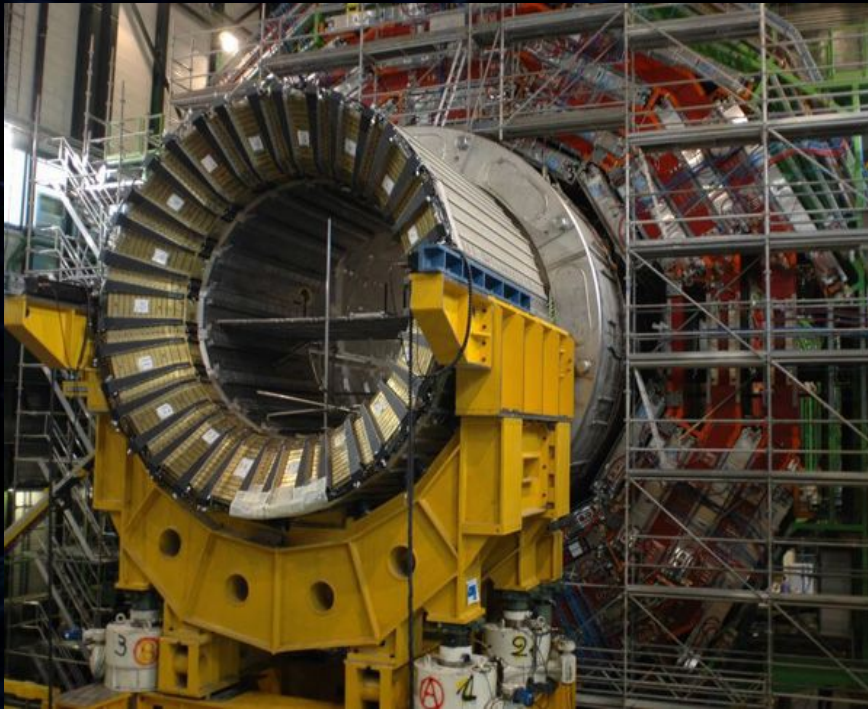
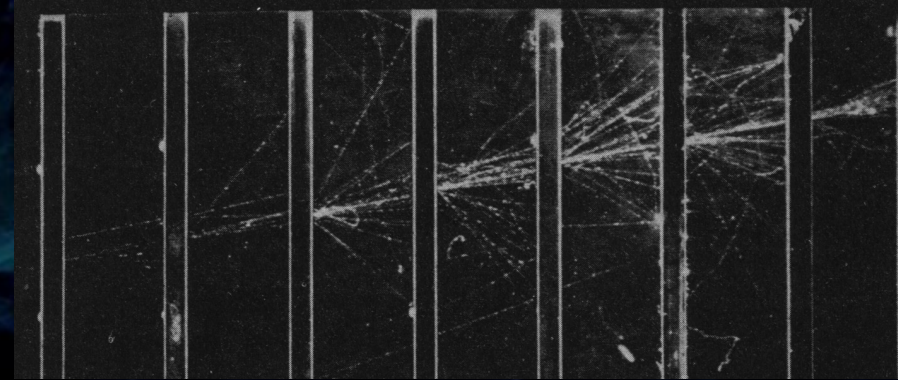

The Muon System - Drift Tubes

- Muon trajectory measurement (barrel)
- Measured quantity - drift time of electrons produced by the passing muon
- Known drift velocity \rightarrow distance measurement ($\sim 50\text{-}200\mu\text{m}$ precision)
- Alignment very important

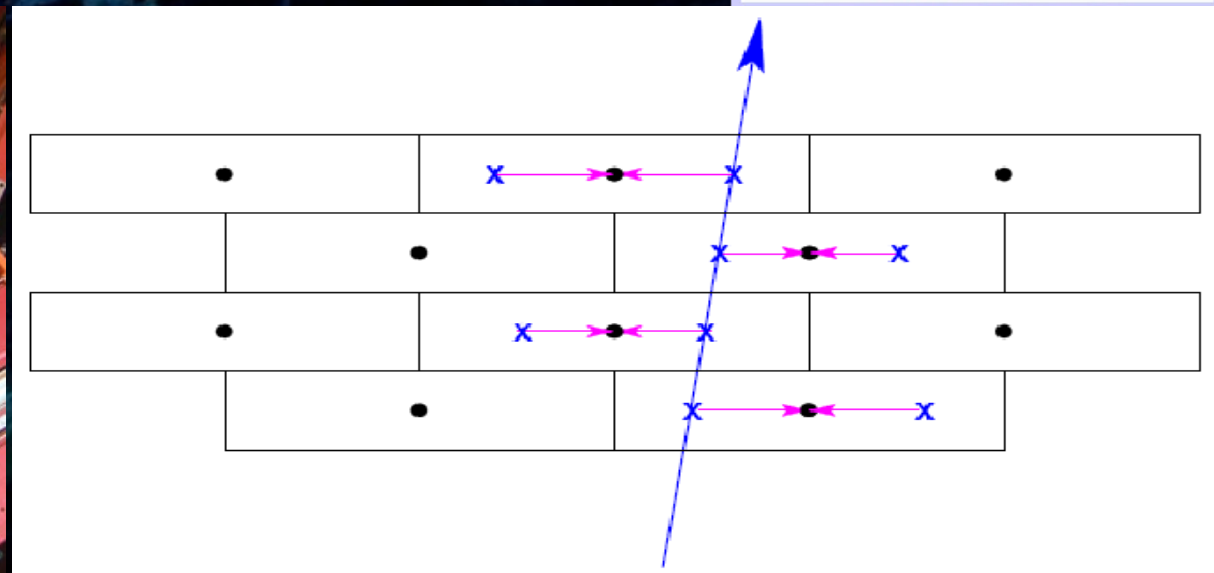
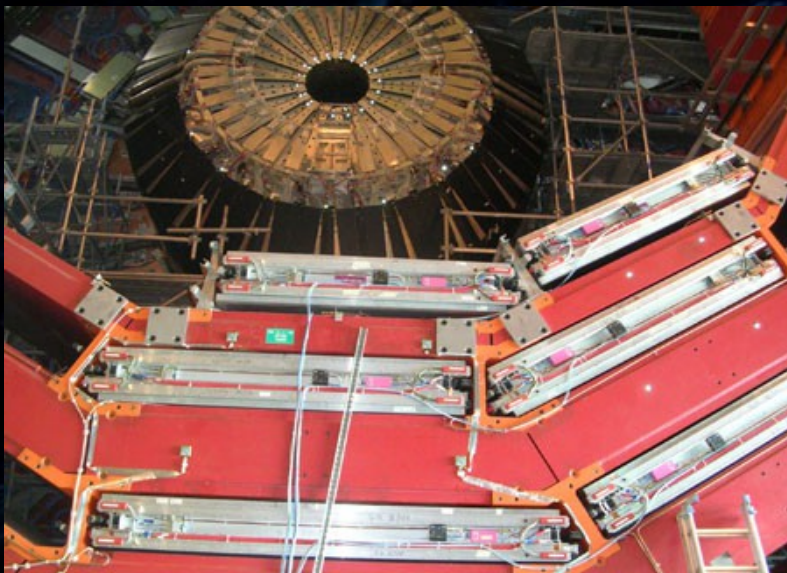
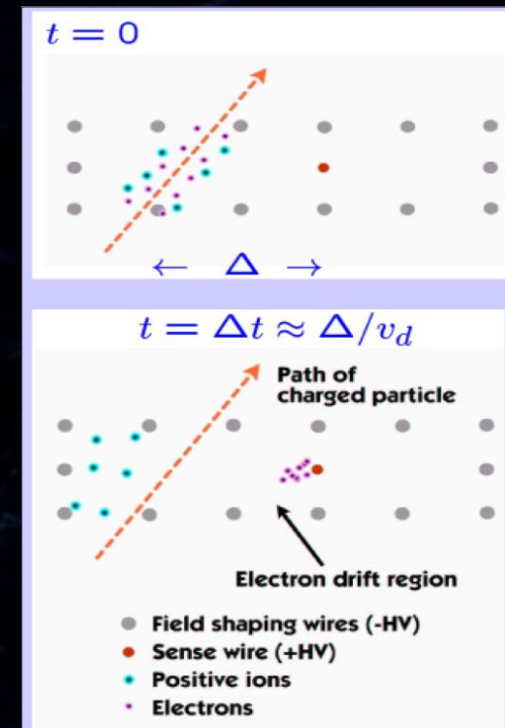

Trigger

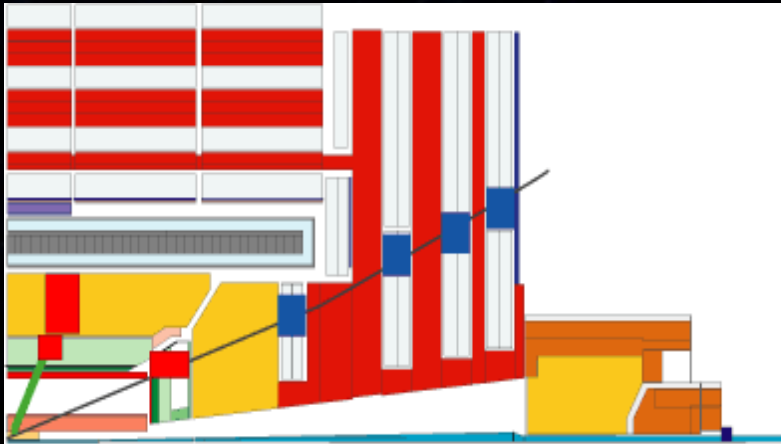

Level-1 trigger. 40 MHz input :

- Specialized processors (25 ns pipelined, latency < 1 μ s)
- Local pattern recognition and energy evaluation on prompt macro-granular information from calorimeter and muon detectors
- Particle identification: high p_T electron, photon, muon, jets, missing E_T

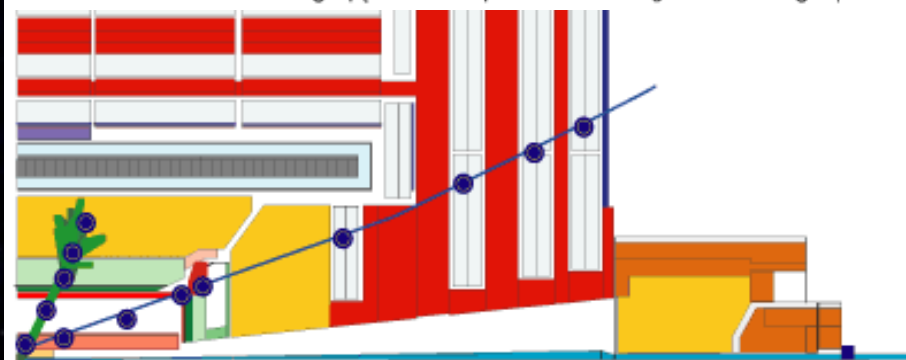

High trigger levels (>1). 100 kHz input :

- Large network of processor farms
- Clean particle signature. All detector data
- Finer granularity precise measurement
- Effective mass cuts and event topology
- Track reconstruction and detector matching
- Event reconstruction and analysis

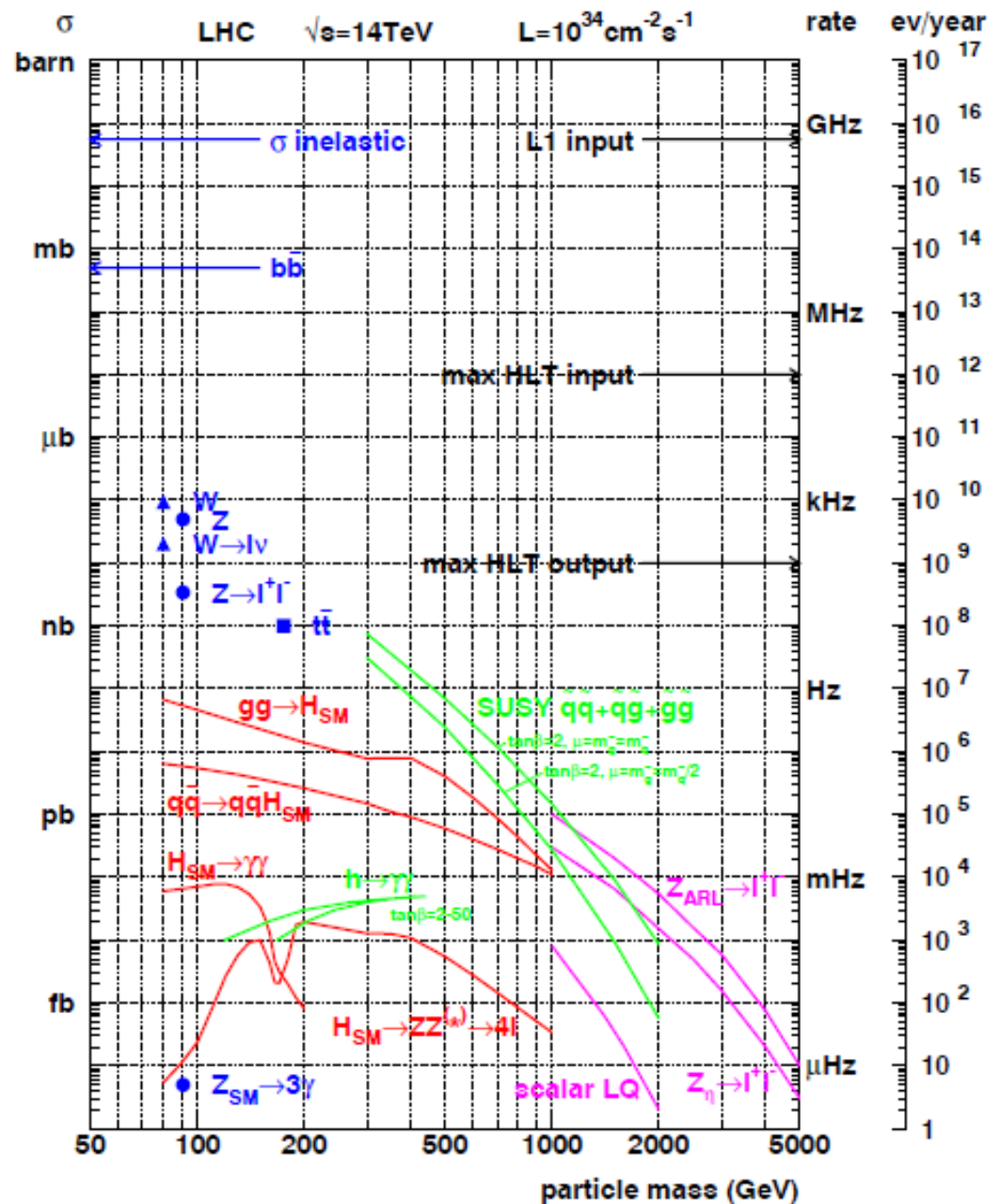

The $H \rightarrow \gamma\gamma$ channel

$L=0.00 \text{ fb}^{-1}$

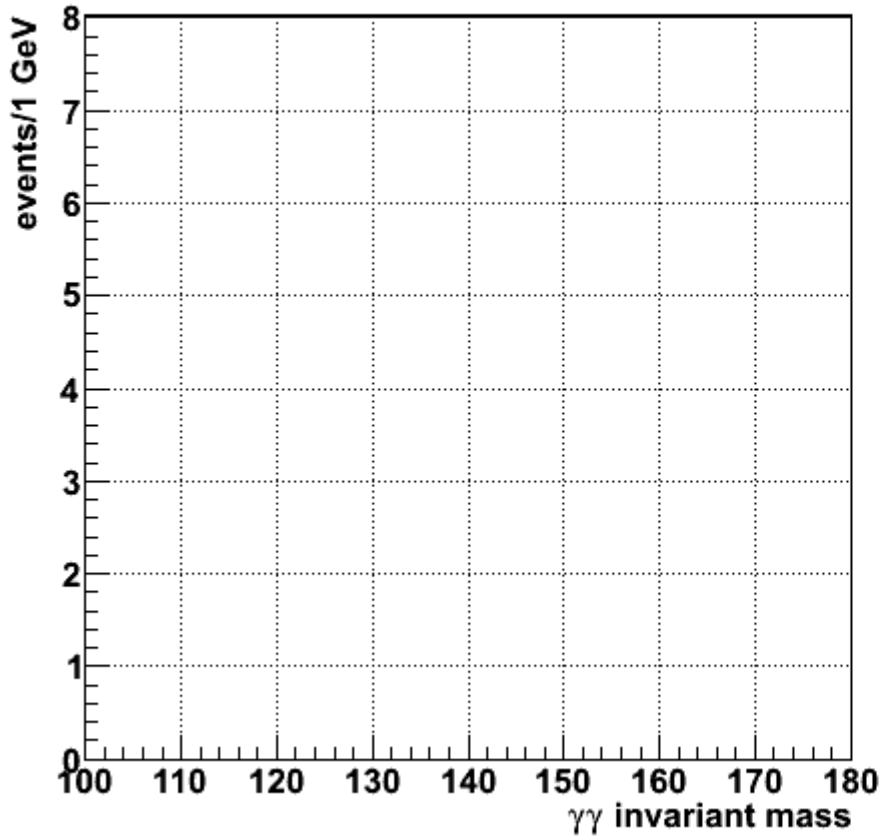

$L=0.00 \text{ fb}^{-1}$

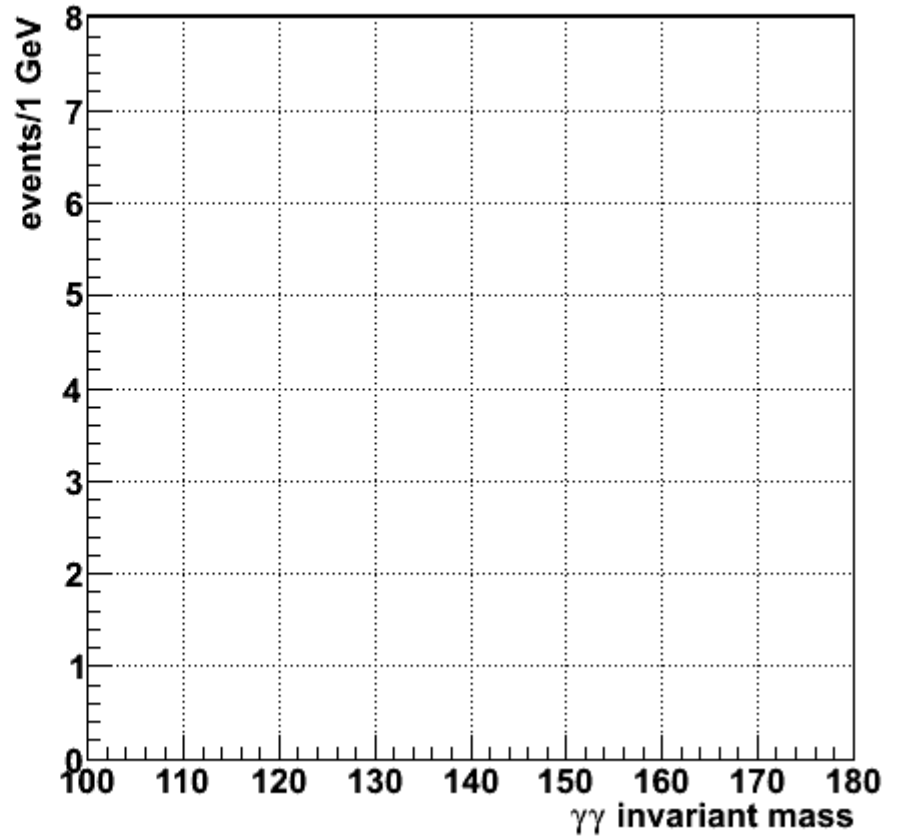

One of these plots contains the (simulated) Higgs boson signal.

Can you spot it?

The $H \rightarrow \gamma\gamma$ channel

$L=1.00 \text{ fb}^{-1}$

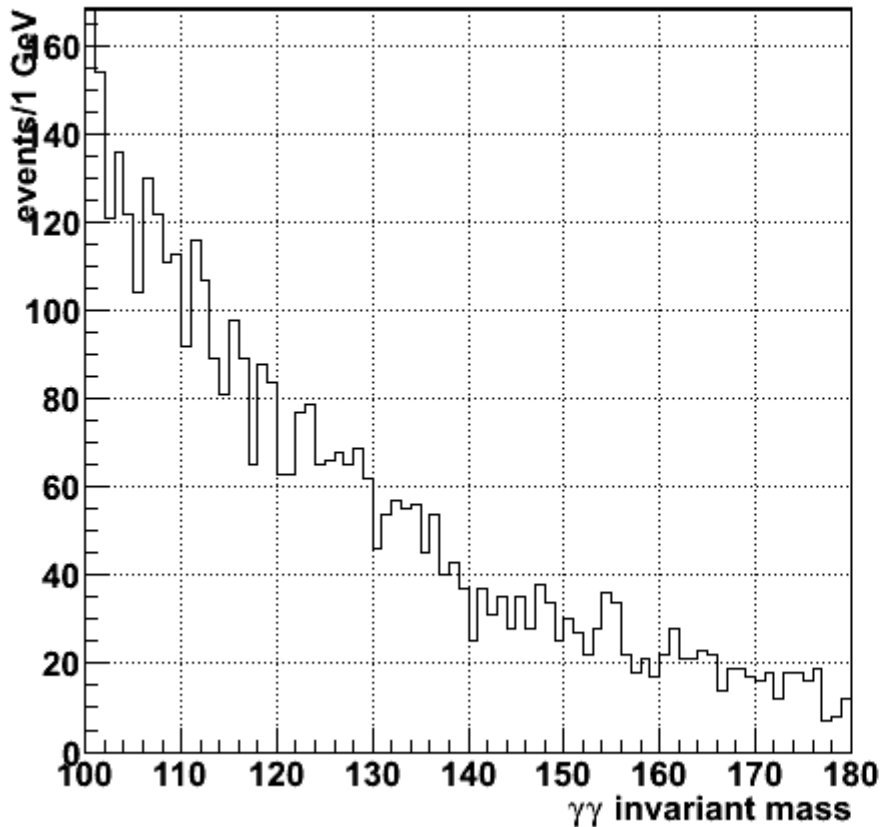

$L=1.00 \text{ fb}^{-1}$

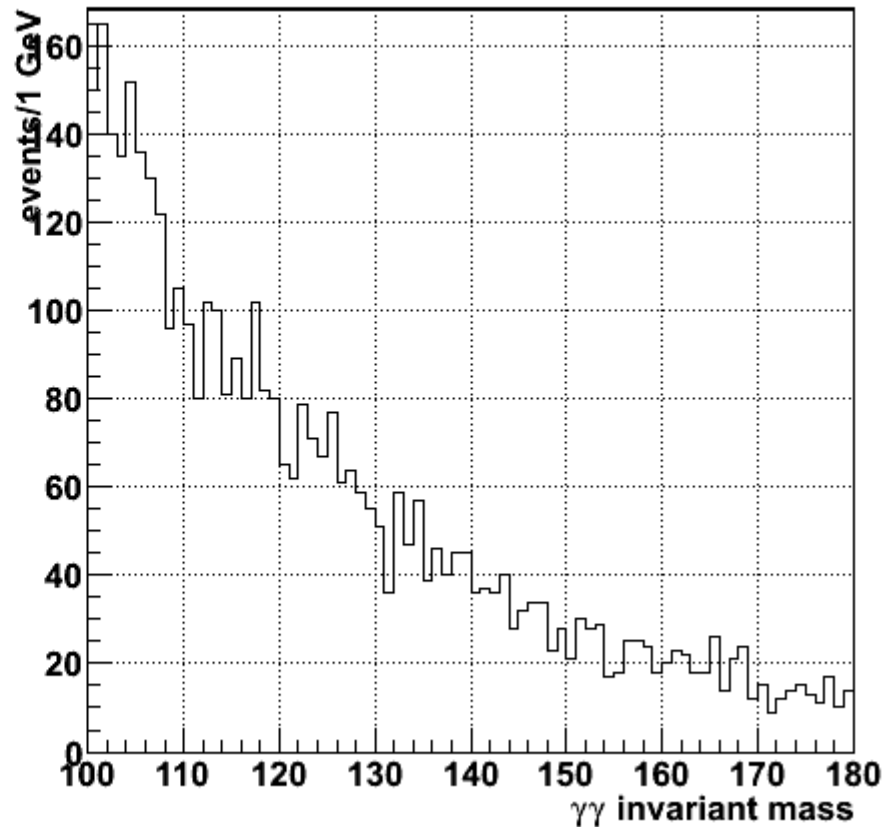

One of these plots contains the (simulated) Higgs boson signal.

Can you spot it?

The $H \rightarrow \gamma\gamma$ channel

$L=2.00 \text{ fb}^{-1}$

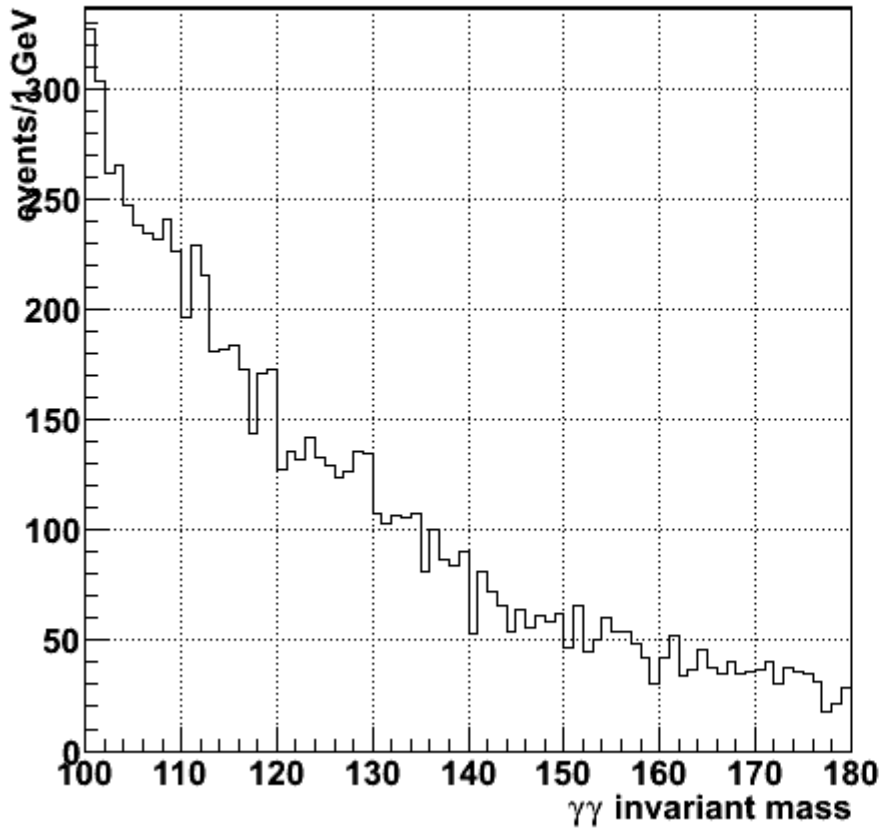

$L=2.00 \text{ fb}^{-1}$

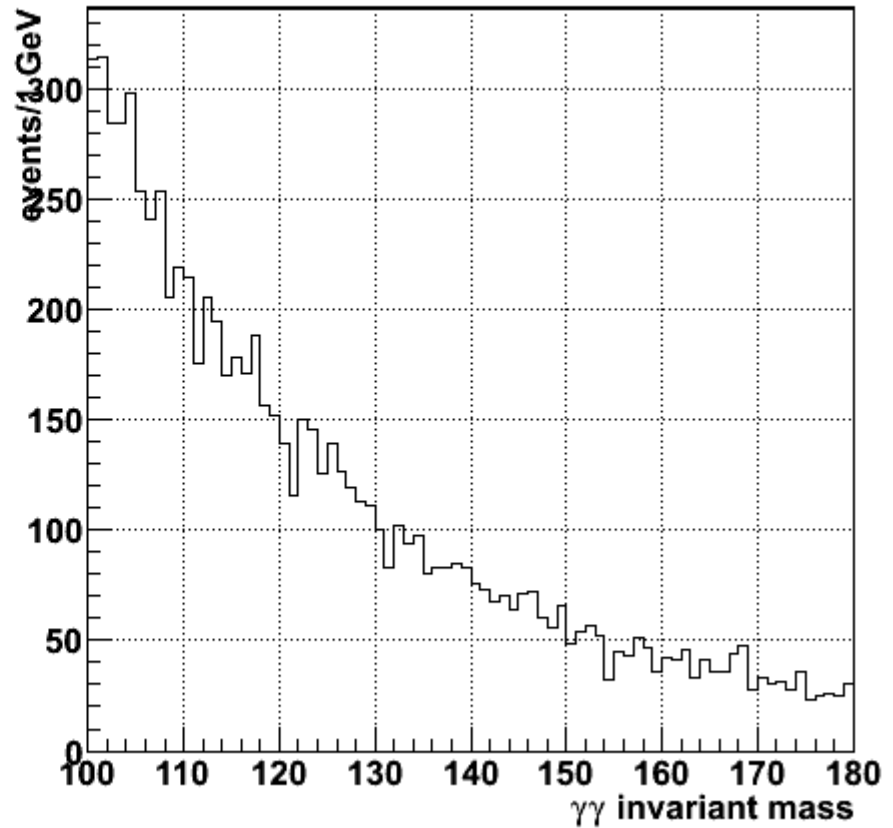

One of these plots contains the (simulated) Higgs boson signal.

Can you spot it?

The $H \rightarrow \gamma\gamma$ channel

$L=4.00 \text{ fb}^{-1}$

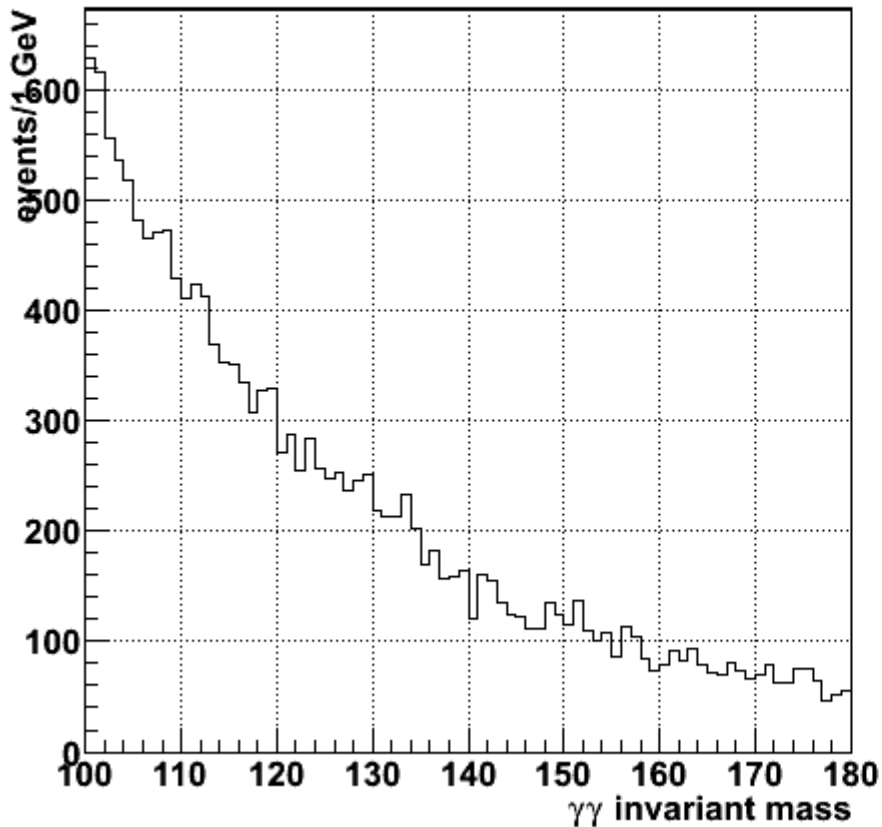

$L=4.00 \text{ fb}^{-1}$

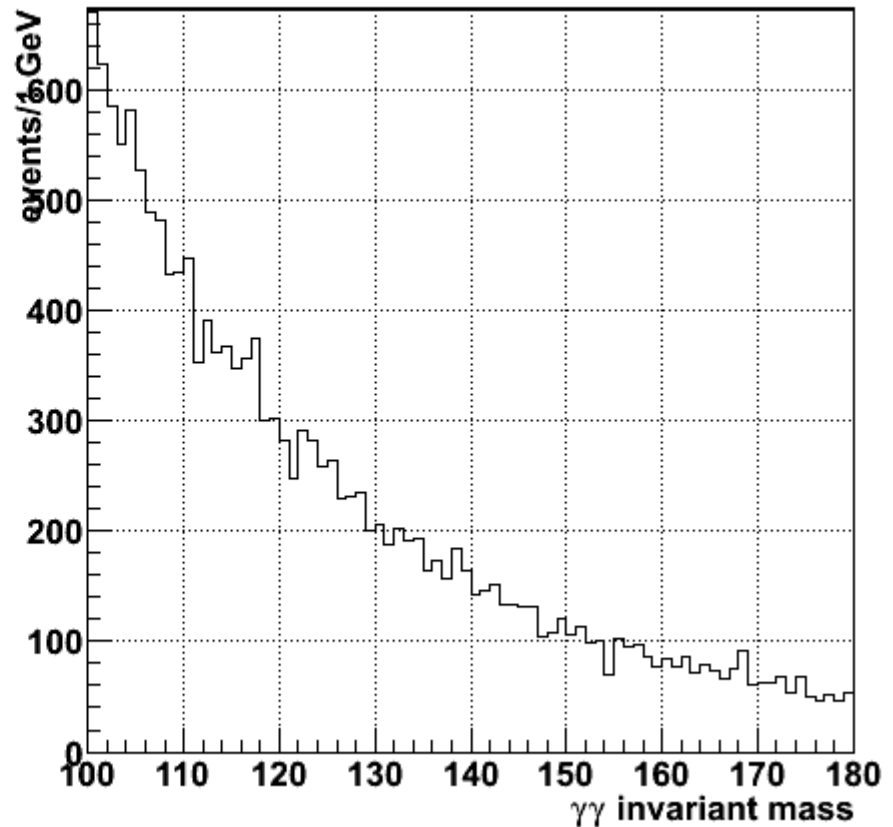

One of these plots contains the (simulated) Higgs boson signal.

Can you spot it?

The $H \rightarrow \gamma\gamma$ channel

$L=8.00 \text{ fb}^{-1}$

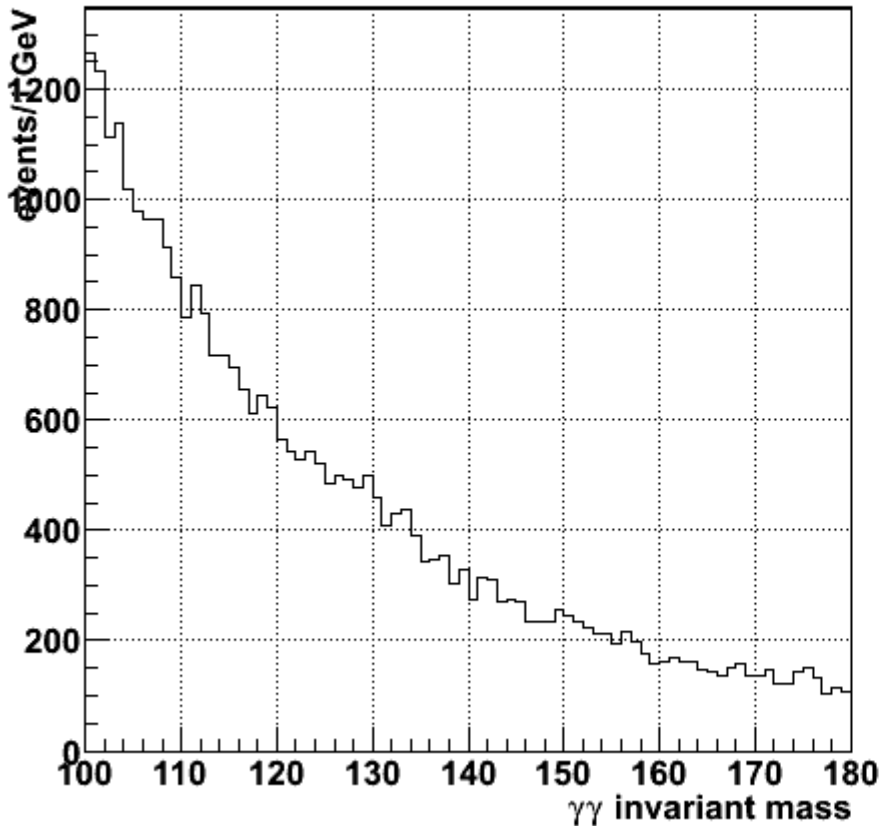

$L=8.00 \text{ fb}^{-1}$

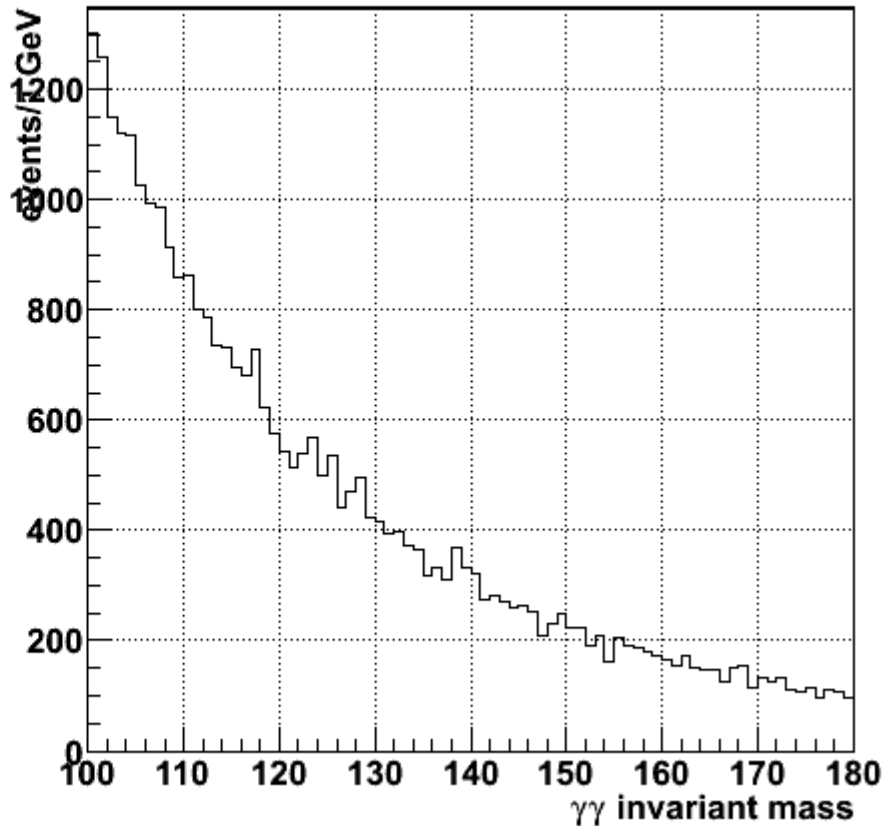

One of these plots contains the (simulated) Higgs boson signal.

Can you spot it?

The $H \rightarrow \gamma\gamma$ channel

$L=16.00 \text{ fb}^{-1}$

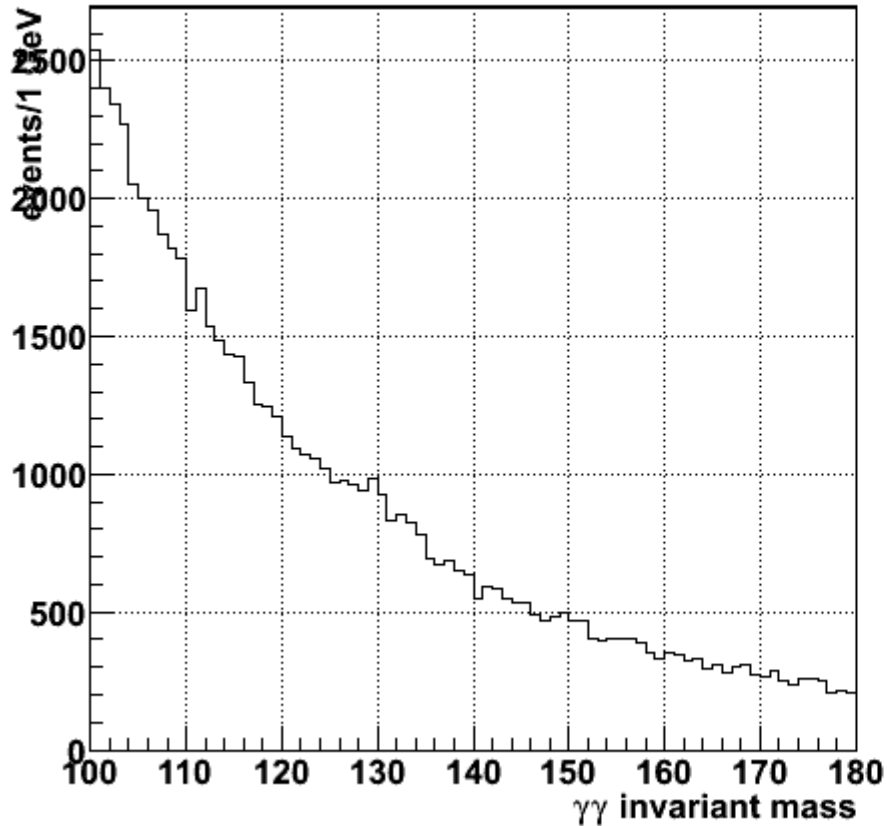

$L=16.00 \text{ fb}^{-1}$

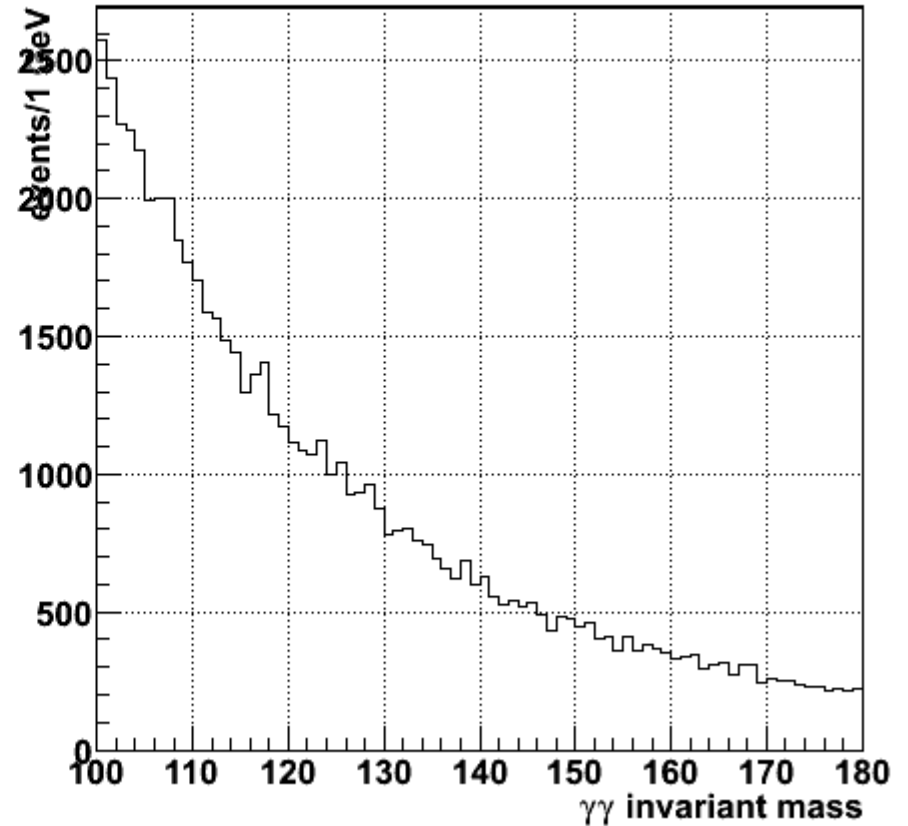

One of these plots contains the (simulated) Higgs boson signal.

Can you spot it?

The $H \rightarrow \gamma\gamma$ channel

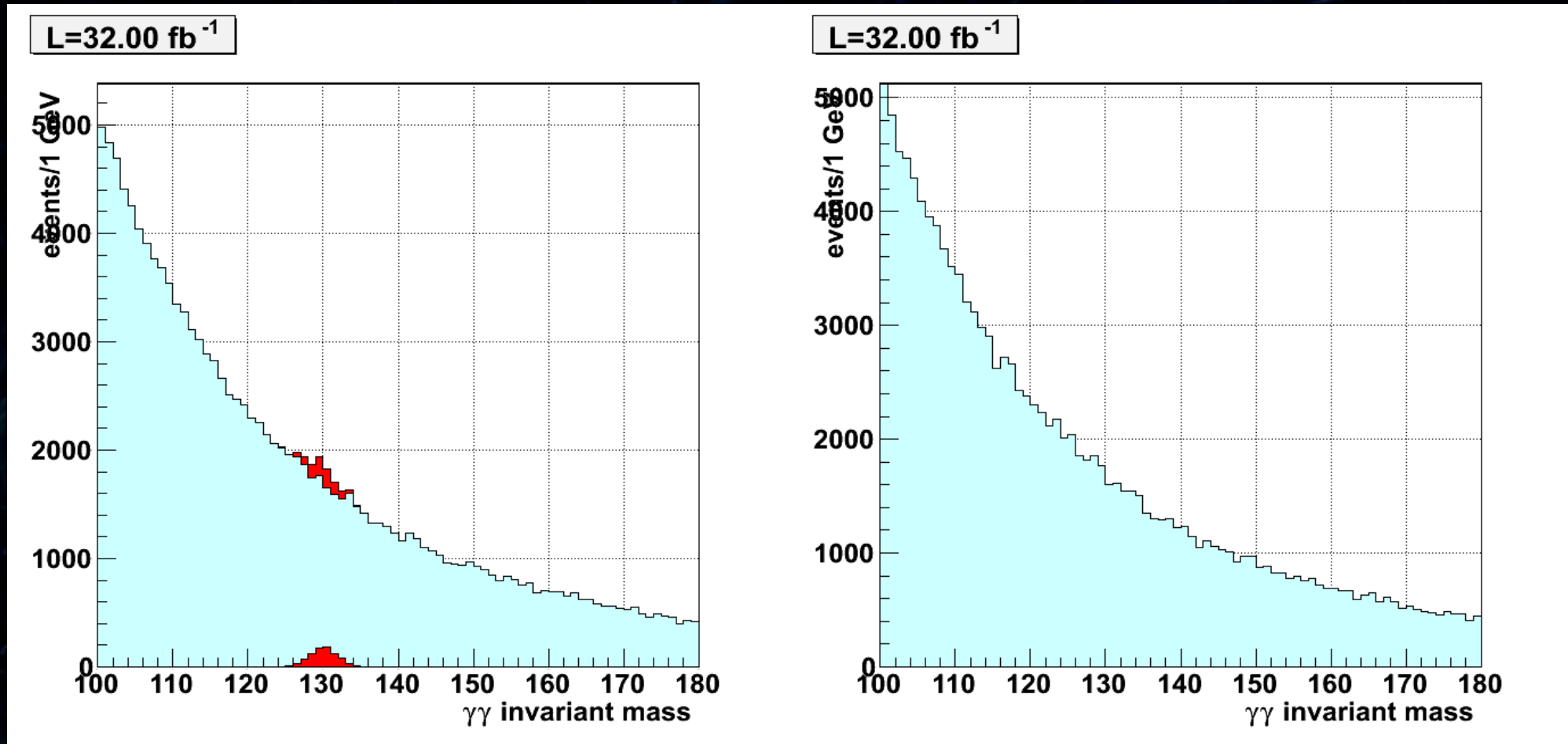

One of these plots contains the (simulated) Higgs boson signal.

Can you spot it?

Once more:

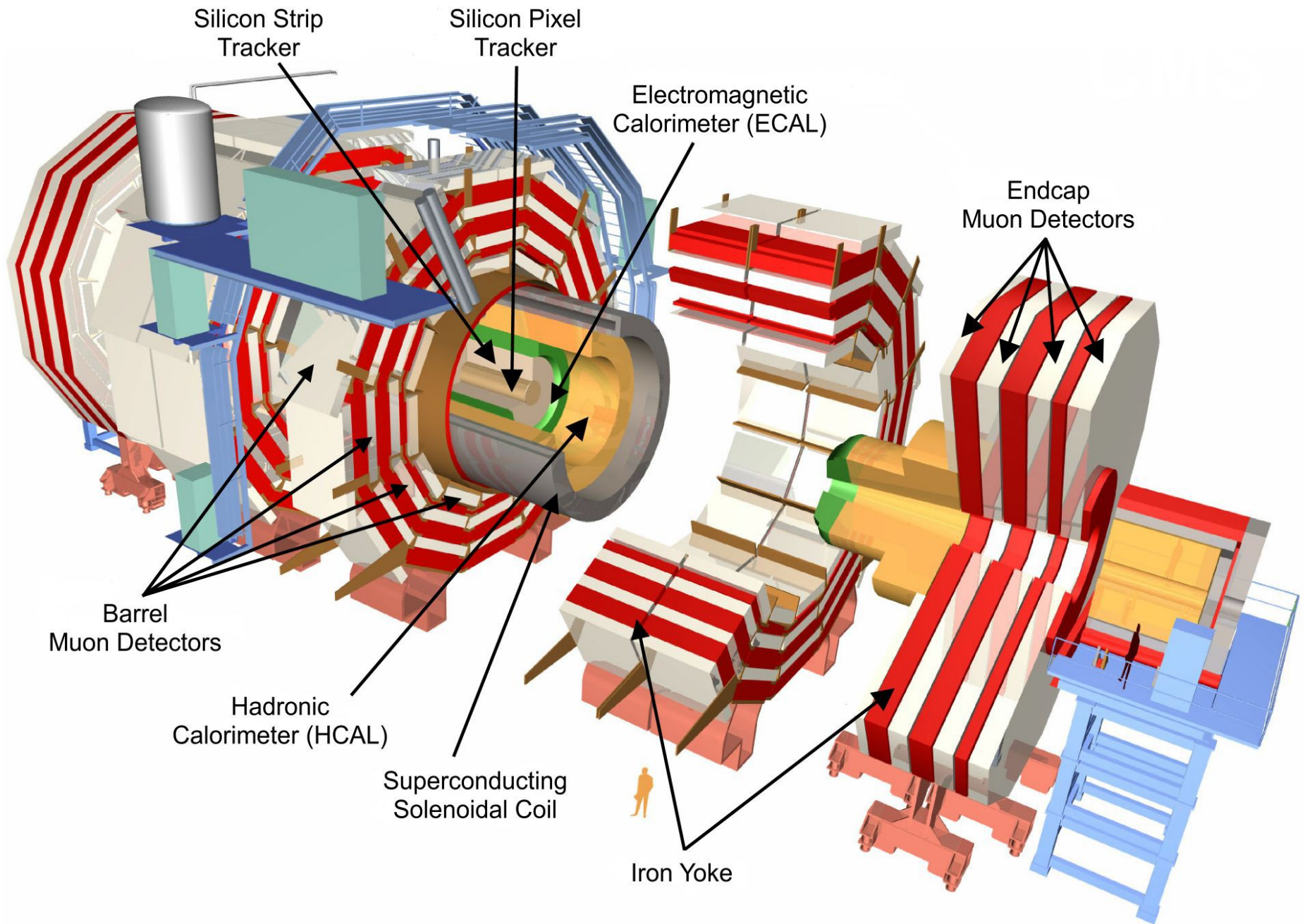

A proton-proton collision as seen by CMS



CMS Experiment at the LHC, CERN

Data recorded: 2012-May-27 23:35:47.271030 GMT

Run/Event: 195099 / 137440354

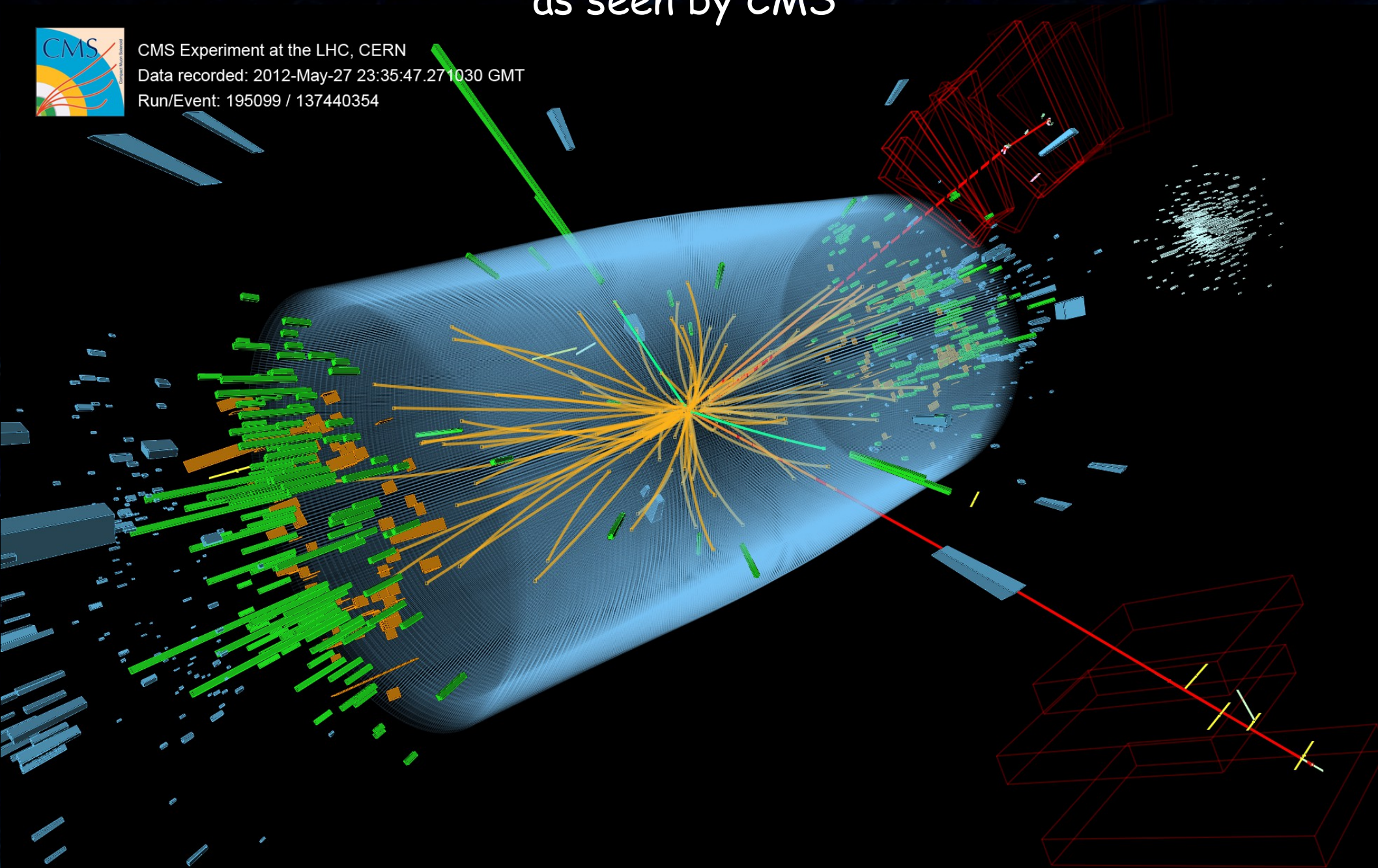

The End

