

An ultra-light Drift Chamber with Particle Identification capabilities for IDEA at FCC-ee

F. Grancagnolo

INFN – Lecce, ITALY



12th FCC-ee Detector Design Group Meeting

CERN, Jan. 30, 2018

Road to IDEA D.C. proposal

- Ancestor chamber: **KLOE** at **INFN LNF Daφne φ factory** (commissioned in 1998 and currently operating)
- **CluCou** Chamber proposed for the **4th-Concept** at **ILC** (2009)
- **I-tracker** chamber proposed for the **Mu2e experiment** at **Fermilab** (2012)
- **DCH** for the **MEG2 upgrade** at **PSI** (under construction at INFN and to be commissioned beginning of 2018)

IDEA D.C. "Innovations"

- **Gas containment** – **wire support** functions separation
 - allows to reduce material to $\approx 10^{-3} X_0$ for the inner cylinder and to a few $\times 10^{-2} X_0$ for the end-plates, including FEE, HV supply and signal cables (Mu2e proposal design: $1.5 \times 10^{-3} X_0$ and $8 \times 10^{-3} X_0$, respectively).
- **Feed-through-less wiring**
 - allows to increase chamber granularity and field/sense wire ratio to reduce multiple scattering and total tension on end plates due to wires.
 - allows to use very fast wiring techniques (implemented in MEG2 dr. ch.)
- **Cluster timing**
 - allows to reach spatial resolution $< 100 \mu\text{m}$ for 8 mm drift cells in He based gas mixtures (such a technique is going to be implemented in the just wired MEG2 drift chamber)
- **Cluster counting**
 - allows to reach dN_c/dx resolution $< 3\%$ for particle identification (a factor 2 better than dE/dx as measured in a beam test)

IDEA D.C. Angular coverage

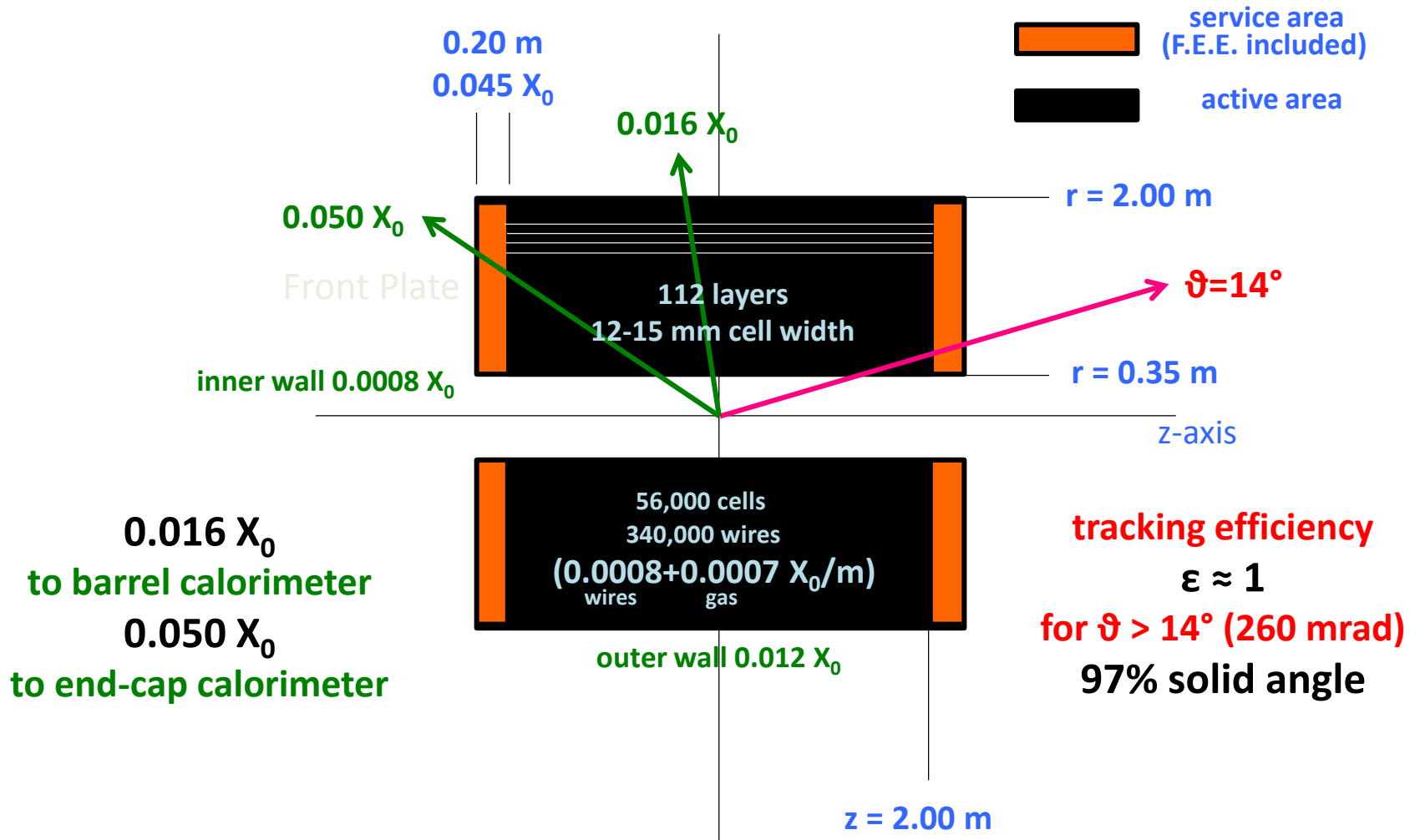

IDEA D.C. Layout

- 12÷15 mm wide square cells 5 : 1 field to sense wires ratio 56,448 cells

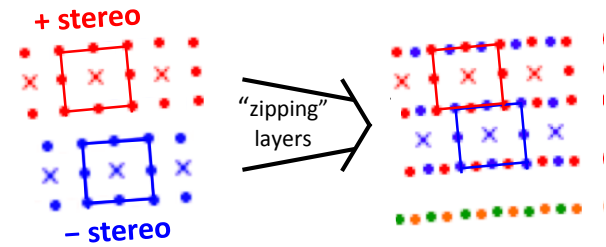

- 14 co-axial super-layers, 8 layers each (112 total) in 24 equal azimuthal (15°) sectors ($N_i = 192 + (i - 1) \times 48$)

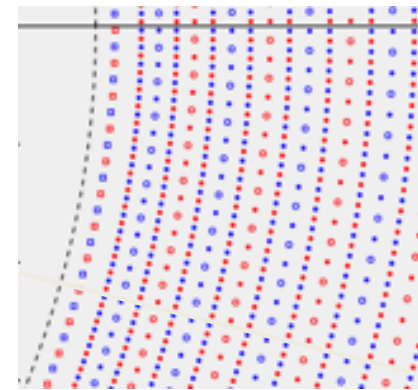

- alternating sign stereo angles ranging from 50 to 150 mrad

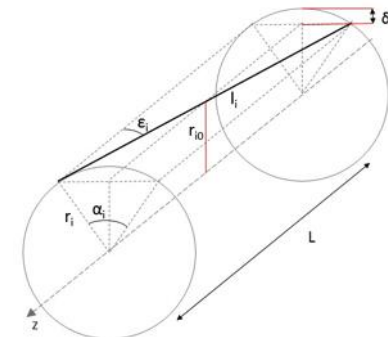

IDEA D.C. Expected resolution

Transverse Momentum Resolution

$$\frac{Dp_t}{p_t} = \frac{8\sqrt{5}S_{xy}}{.3BR_{out}\sqrt{N}} p_t \oplus \frac{0.0523 [GeV/c]}{bBL} \sin q \sqrt{\frac{L}{X_0}}$$

Angular Resolutions

$$Dj_0 = \frac{4\sqrt{3}S_{xy}}{R_{out}\sqrt{N}} \oplus \frac{0.0136 [GeV/c]}{bp} \sqrt{\frac{L}{X_0}}$$

$$Dq = \frac{\sqrt{12}S_z}{R_{out}\sqrt{N}} \frac{1 + \tan^2 q}{\tan^2 q} \oplus \frac{0.0136 [GeV/c]}{bp} \sqrt{\frac{L}{X_0}}$$

Momentum Resolution

$$\frac{Dp}{p} = \frac{Dp_t}{p_t} \oplus \frac{Dq}{\tan q}$$

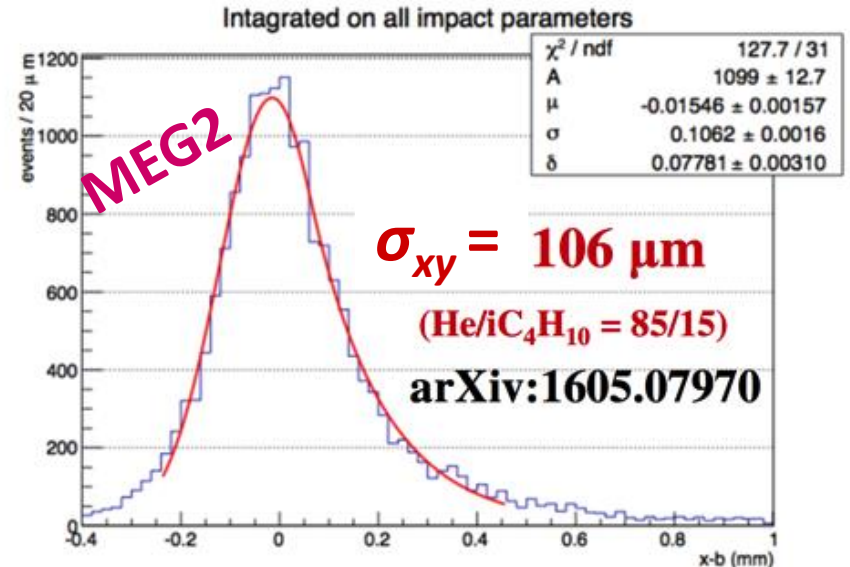

no cluster timing, 7x7 mm²

12x12 mm² ≤ 100 μm

cluster timing → -20%

IDEA expected $\sigma_{xy} \approx 80 \mu\text{m}$

IDEA D.C. Expected resolution

$$\sigma_{xy}=100\mu\text{m}, \sigma_z=1.0\text{mm}, N=112, B=2\text{T}, R_{out}=2\text{m}, L/X_0=2.5\times 10^{-3}$$

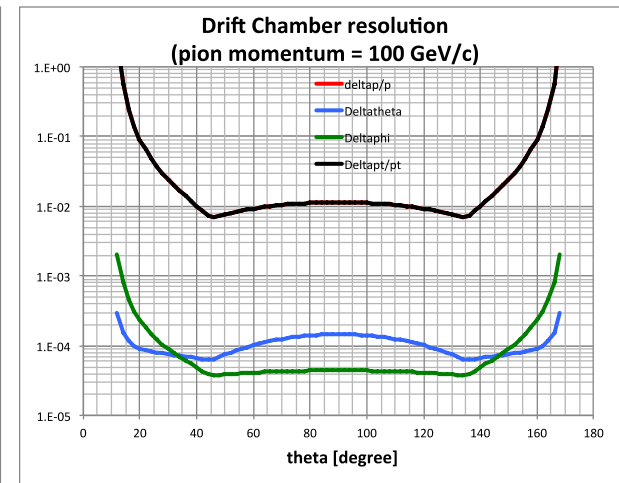
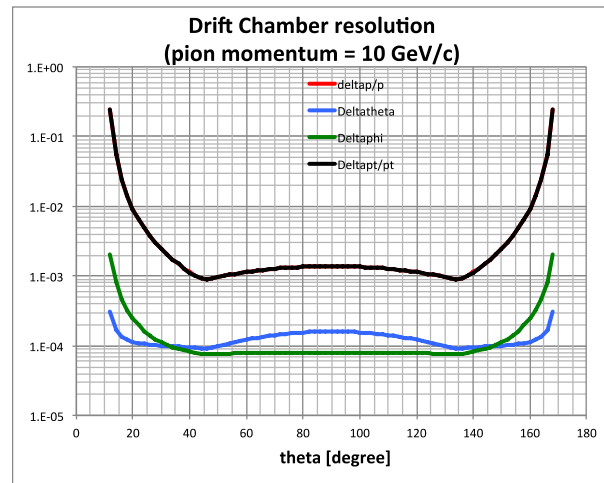
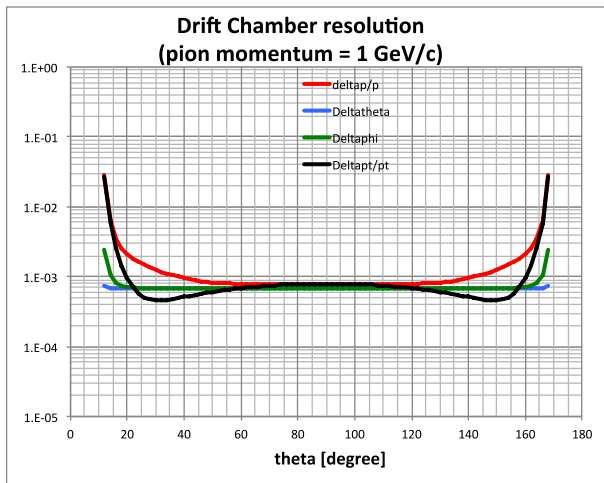
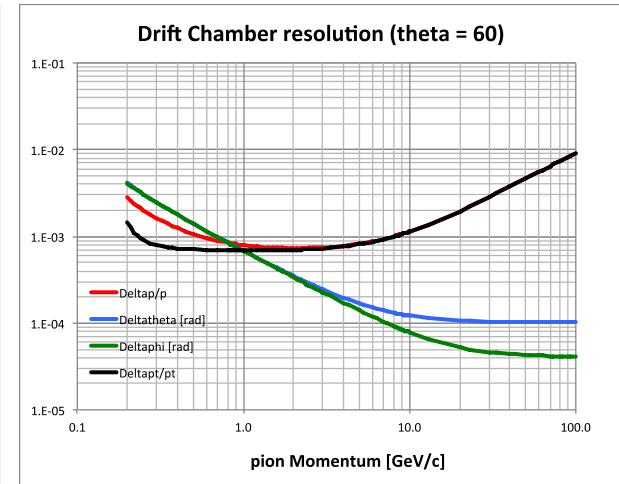
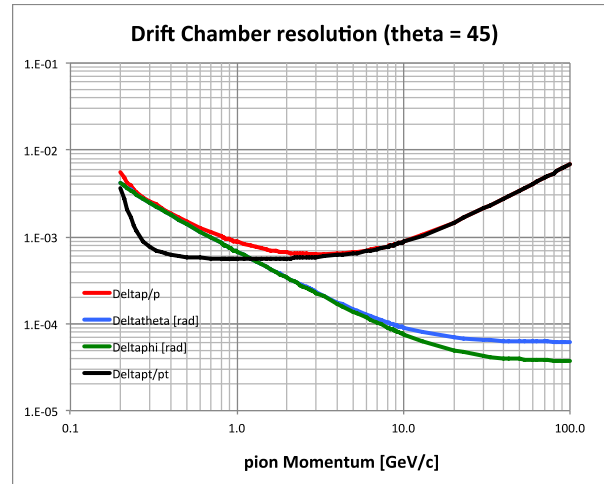
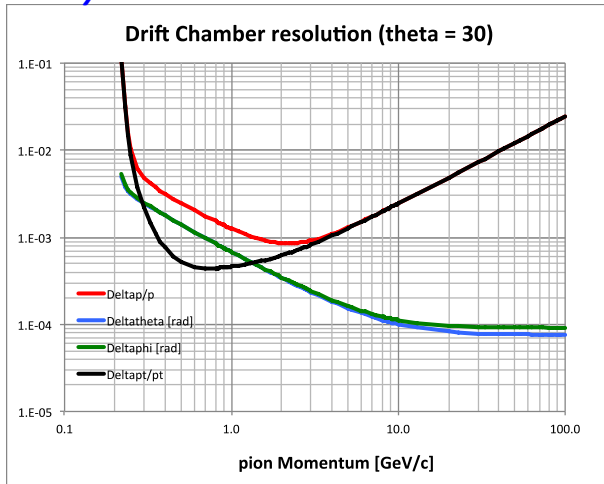

IDEA D.C. expected Particle Id.

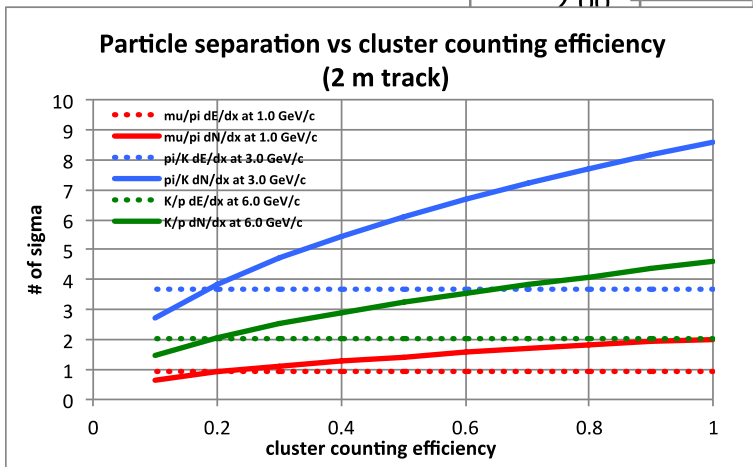
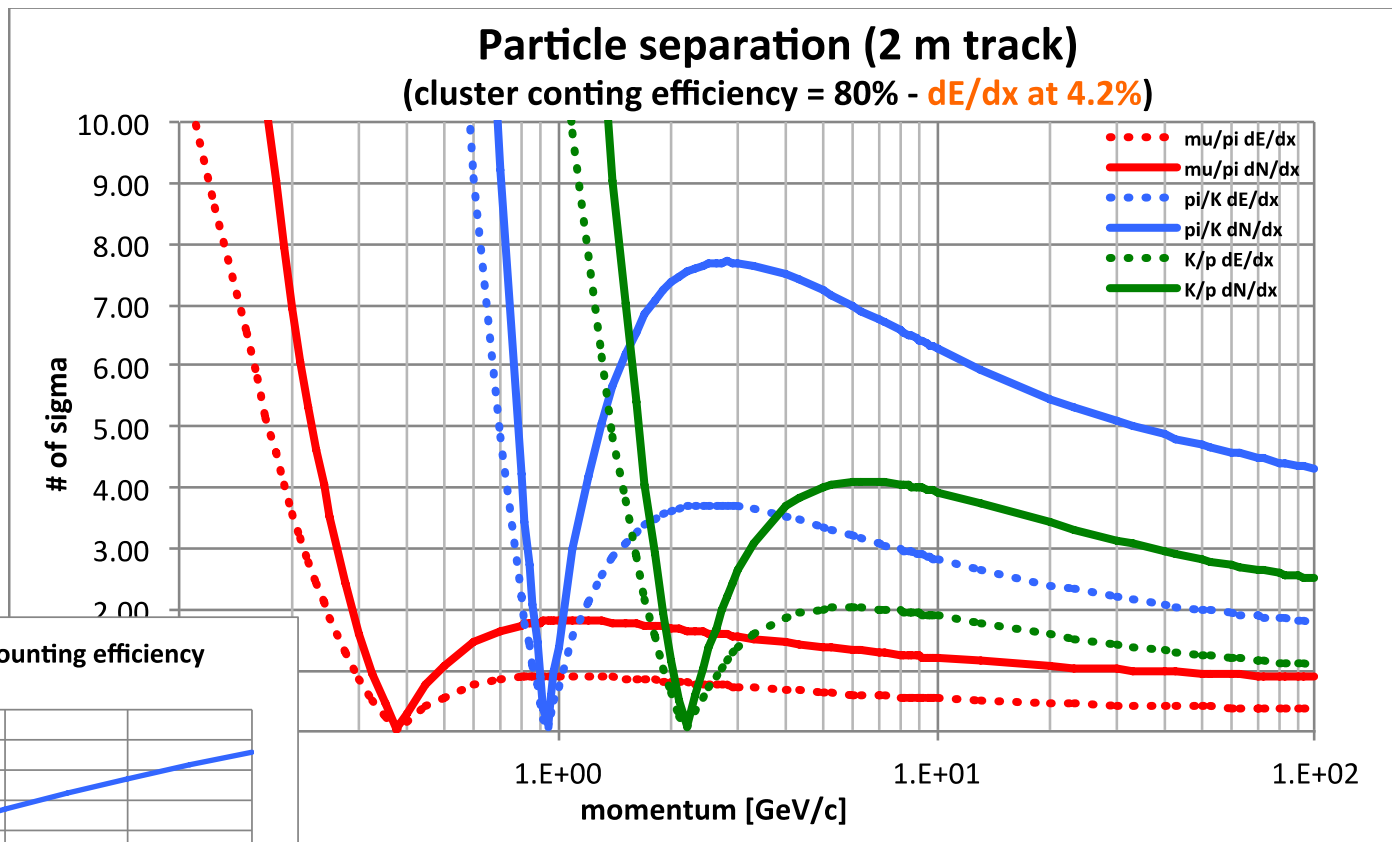

IDEA integrated track simulation

Geometry description (baseline):

- Beam pipe: **15.6 mm** radius, **0.0 X_0 – 0.24% X_0 – 0.48% X_0** thick (**0 - 0.8 - 1.6 mm Be**)
- Vertex detector: **17 – 23 – 31 – 180 – 200 – 330 – 340 mm** radii (20 μm pixels)
0.3 – 0.3 – 0.3 – 1.0 – 1.0 – 1.0 – 1.0 % X_0 thick (incl. cooling)
250 – 800 – 1500 mm long
No forward disks!
- Tracker: **IDEA D.C.**
- Pre-shower: **2004 – 2014 mm** radii Pb radiators, **1.0 – 2.0% X_0** thick, **4800 mm** long
2010 – 2027 mm radii pixel planes (70 μm), **1.0 – 1.0% X_0** thick, **4800 mm** l.
No end-plate coverage!

Configurations comparisons:

baseline vertex detector versus vertex detector without mid-stations

baseline vertex detector versus vertex detector without outer-stations

vertex detector without outer-stations **versus** thinner beam pipe

vertex detector without outer-stations **versus** no beam pipe

IDEA integrated track simulation

μ at $\vartheta = 65^\circ$

Momentum Resolution

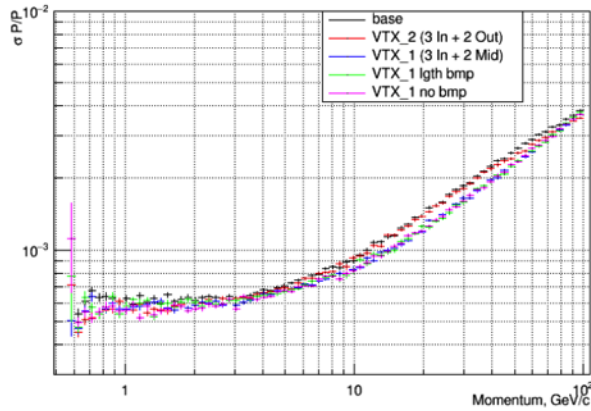

Phi Resolution

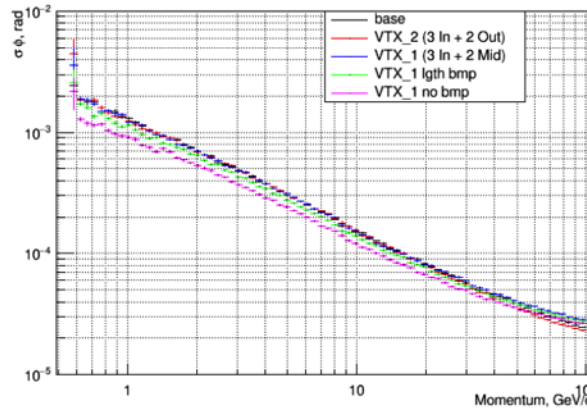

Z vtx Resolution

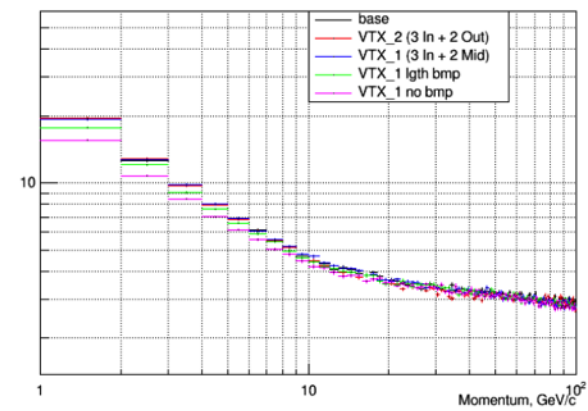

Transverse Momentum Resolution

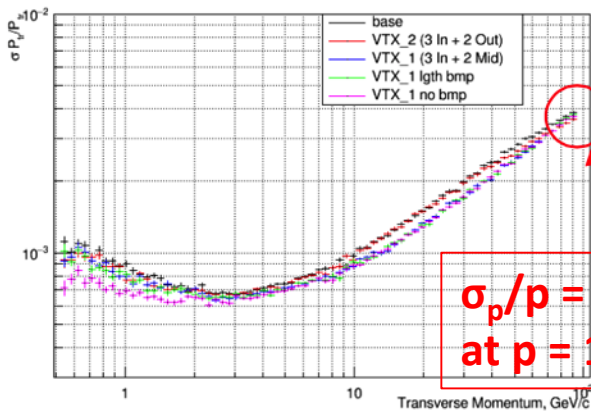

$\sigma_p/p = 4 \times 10^{-5}$
at $p = 100$ Gev

Theta resolution

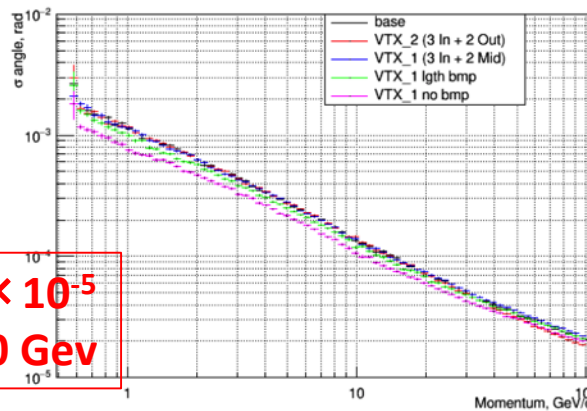

R-phi vtx Resolution

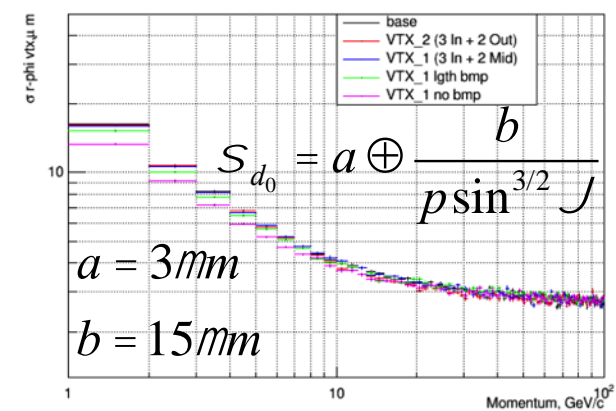

IDEA integrated track simulation

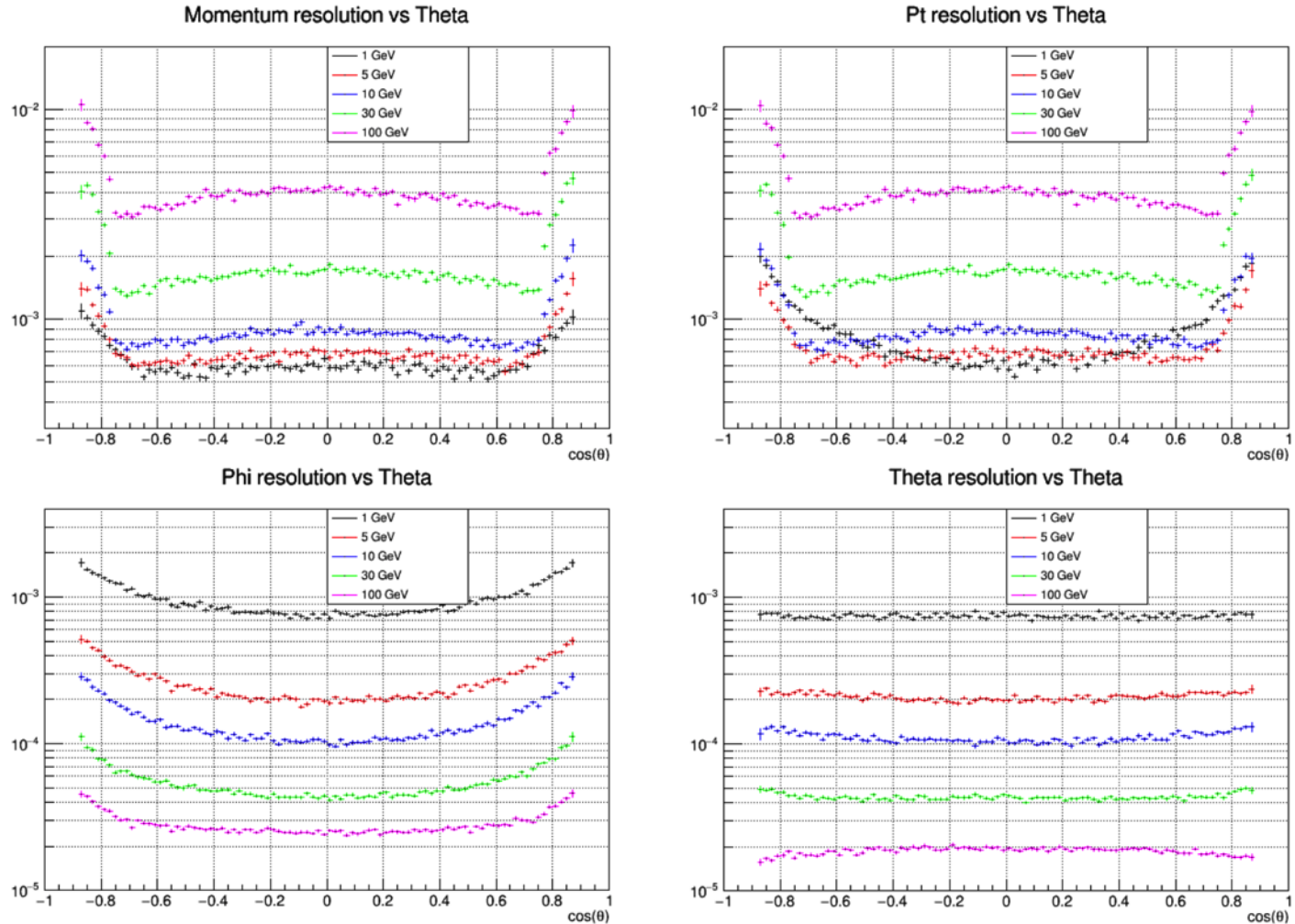

IDEA integrated track simulation

A lot to be done yet:

- Realistic geometries for vertex detector (forward disks) and pre-shower counters (endplate regions)
- **ZH --> $\mu\mu X$ simulation**
- Geometry optimization once background simulation completed
- Detailed hit creation and ionization clusters formation
- Time-to-distance relations in 2T B-field
- Signal waveform generation
- More efficient waveform analysis for timing and counting clusters
- More efficient track finding algorithms

Back up slides

KLOE Drift Chamber

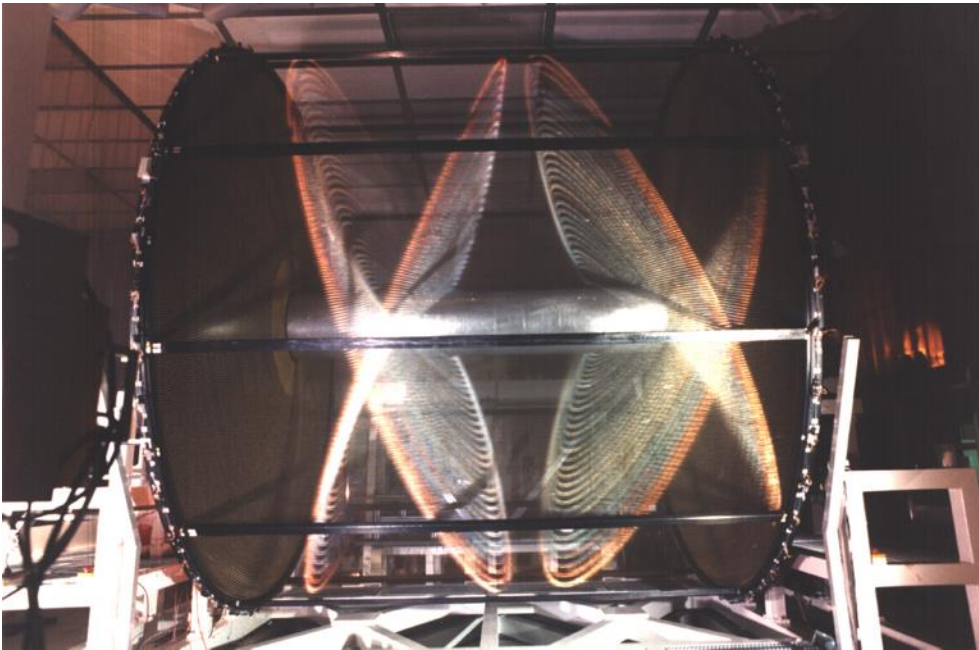

fully stereo
4 m diameter
3.3 m length
C-fiber structure
90% He – 10% iC_4H_{10}
12,000 sense wires
52,000 total wires
80 μm Al field wires
2x2 and 3x3 cm^2 cells

MEG2 Drift Chamber

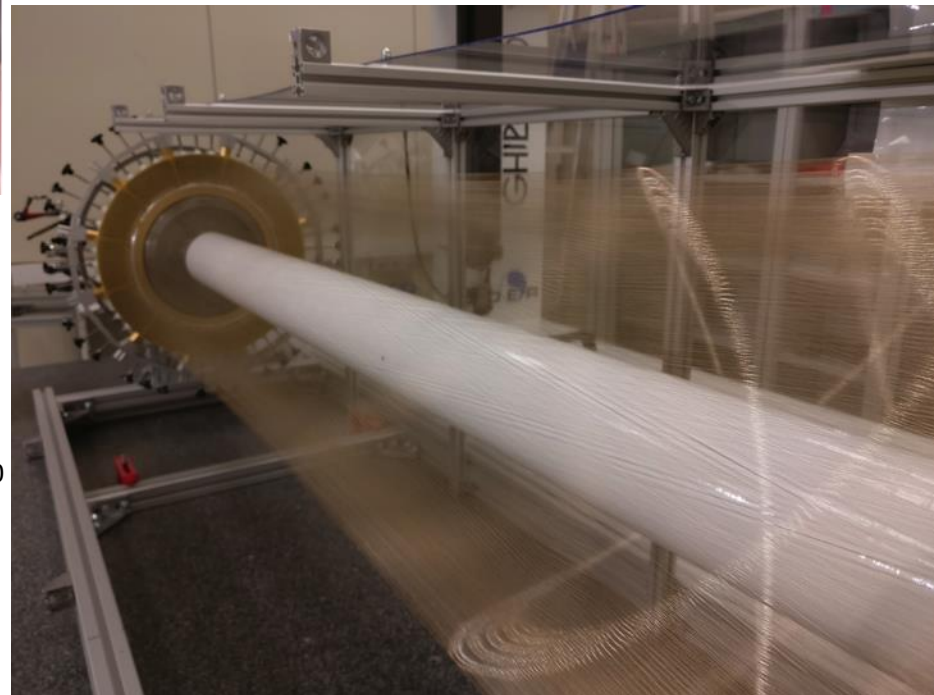

fully stereo
0.6 m diameter
2.0 m length
C-fiber structure
85% He – 15% iC_4H_{10}
2,000 sense wires
12,000 total wires
40 μm Al field wires
0.7x0.7 cm^2 cells
cluster tim/cou

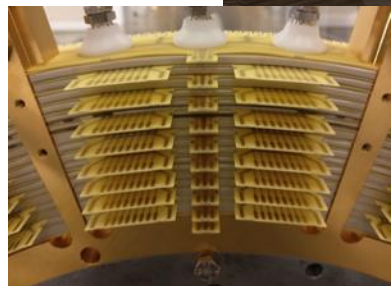

IDEA D.C. Material budget

Conservative estimates:

- Inner wall (from CMD3 drift chamber) **$8.4 \ll 10^{-4} X_0$**
200 μm Carbon fiber
- Gas (from KLOE drift chamber) **$7.1 \ll 10^{-4} X_0/\text{m}$**
90% He – 10% $i\text{C}_4\text{H}_{10}$
- Wires (from MEG2 drift chamber) **$8.0 \ll 10^{-4} X_0/\text{m}$**
20 μm W sense wires $2.9 \ll 10^{-4} X_0/\text{m}$
40 μm Al field wires $3.9 \ll 10^{-4} X_0/\text{m}$
50 μm Al guard wires $1.2 \ll 10^{-4} X_0/\text{m}$
- Outer wall (from Mu2e I-tracker studies) **$1.2 \ll 10^{-2} X_0$**
2 cm composite sandwich (7.7 Tons)
- End-plates (from Mu2e I-tracker studies) **$4.5 \ll 10^{-2} X_0$**
wire cage + gas envelope
incl. services (electronics, cables, ...)

IDEA D.C. Electrostatic Stability

sagitta due to electrostatic forces on sense wire displaced by Δ from central symmetry position

$$d_{e.s.} = \frac{C^2 V_0^2 L^2}{4peT w^2} D$$

C = wire capacitance per unit length $C = \frac{2pe}{\ln\left\{\frac{2}{r}\right\}}$
 V_0 = wire voltage
 L = wire length
 T = wire mechanical tension
 $w/2$ = wire distance from ground plane
 r = sense wire radius

stability condition

$$T \geq \frac{peV_0^2 L^2}{w^2 \ln\left\{\frac{2}{r}\right\}}$$

For IDEA D.C.:

$V_0 = 1500 \text{ V}$, $L = 4 \text{ m}$,
 $w = 12 \text{ mm}$, $r = 20 \mu\text{m}$:

$$T \geq 0.16 \text{ N}$$

or, for $T = 0.25 \text{ N}$
 $(\delta_{grav.} = 400 \mu\text{m})$:

$$L \leq 4.9 \text{ m}$$

Smaller cell size (to mitigate higher occupancy at inner radius), e. g. $w = 7 \text{ mm}$, would require higher tension: $T \geq 0.48 \text{ N}$, which is above the elastic limit for $20 \mu\text{m}$ diameter tungsten sense wire ($YS = 1500 \text{ MPa}$):

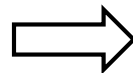
 shorten the wires (and loose angular coverage) and/or increase the wire diameter (and mult. scatt. and $\delta_{grav.}$) or **introduce new types of wires** (C wire?) with further improvement of drift chamber transparency

Cluster Timing/Counting

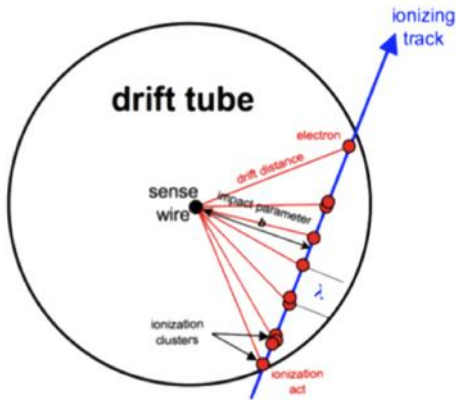

From the **ordered sequence of the electrons arrival times**, considering the average time separation between clusters and their time spread due to diffusion, **reconstruct the most probable sequence of clusters drift times**: $\{t_i^{cl}\} \quad i = 1, N_{cl}$

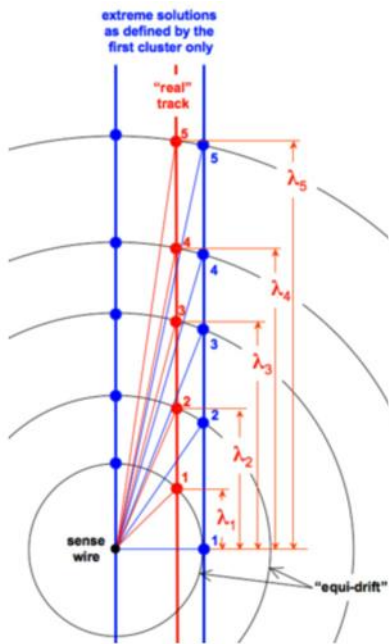
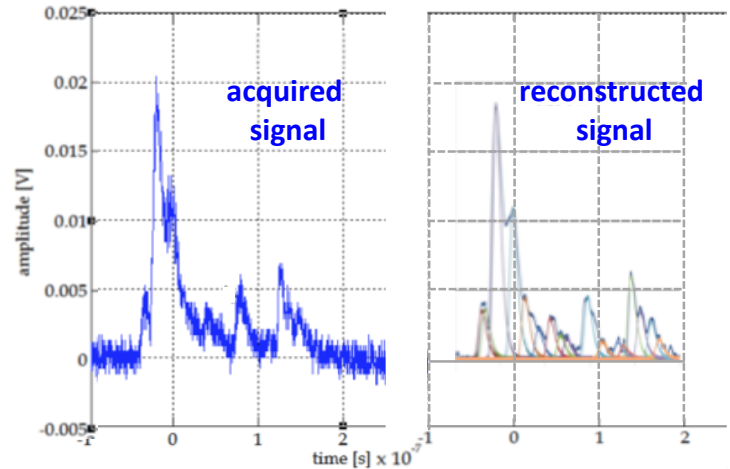

For any given first cluster (FC) drift time, the **cluster timing technique** exploits the drift time distribution of all successive clusters $\{t_i^{cl}\}$ to determine the most probable impact parameter, thus reducing the **bias** and the average **drift distance resolution** with respect to those obtained from with the FC method alone.

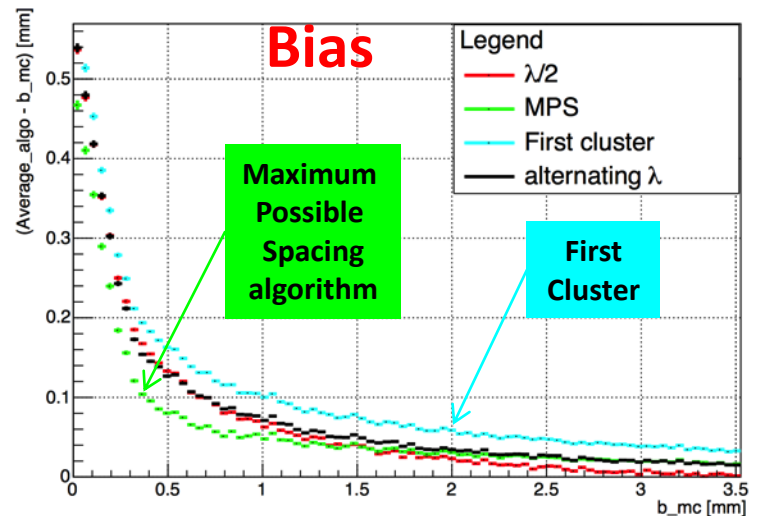

Particle Identification (in theory)

$$\frac{S_{dE/dx}}{(dE/dx)} = 0.41 \times n^{-0.43} \times (L_{track} [m] \times P [atm])^{-0.32}$$

from *Walenta parameterization (1980)*

dE/dx

truncated mean cut (70-80%) reduces the amount of collected information

$n = 112$ and a **2m track** at **1 atm** give

$\sigma \approx 4.3\%$

Increasing **P** to 2 atm improves resolution by 20% ($\sigma \approx 3.4\%$) but at a **considerable** cost of multiple scattering contribution to momentum and angular resolutions.

versus

$$\frac{S_{dN_{cl}/dx}}{(dN_{cl}/dx)} = (d_{cl} \times L_{track})^{-1/2}$$

from *Poisson distribution*

dN_{cl}/dx

$\delta_{cl} = 12.5/\text{cm}$ for He/iC₄H₁₀=90/10 and a **2m track** give

$\sigma \approx 2.0\%$

A small increment of iC₄H₁₀ from 10% to 20% ($\delta_{cl} = 20/\text{cm}$) improves resolution by 20% ($\sigma \approx 1.6\%$) at only a **reasonable** cost of multiple scattering contribution to momentum and angular resolutions.

μ/π separation at 200 MeV/c (exp.)

The data shown refer to a beam of μ and π at 200 MeV/c, taken with a gas mixture $\text{He}/i\text{C}_4\text{H}_{10}=95/5$, $\delta_{cl} = 9/\text{cm}$, 100 samples, 2.6 cm each at 45° (for a total track length of 3.7 m, corresponding to $N_{cl} = 3340$, $1/\sqrt{N_{cl}} = 1.7\%$).

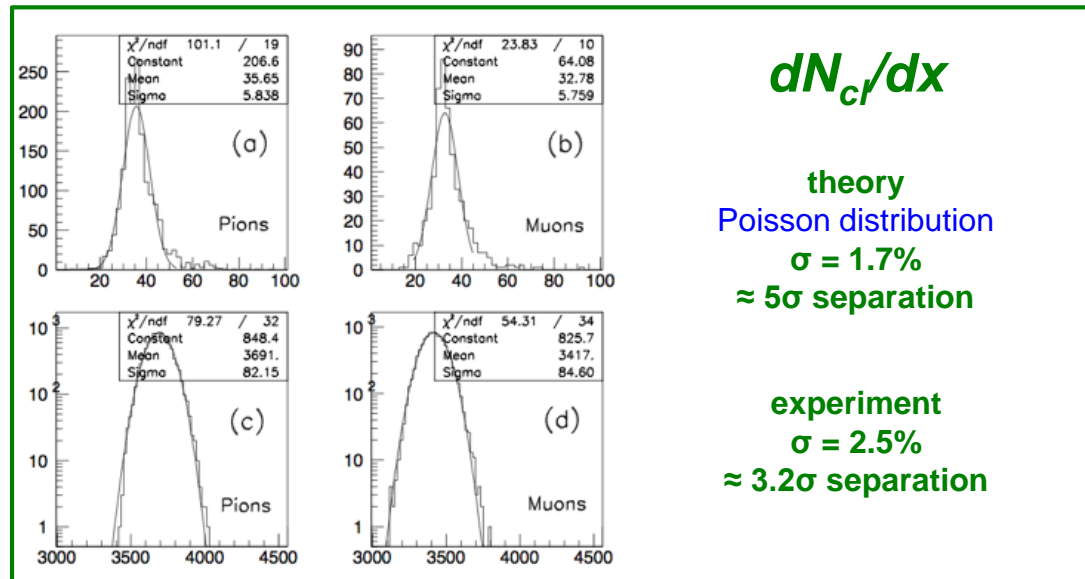
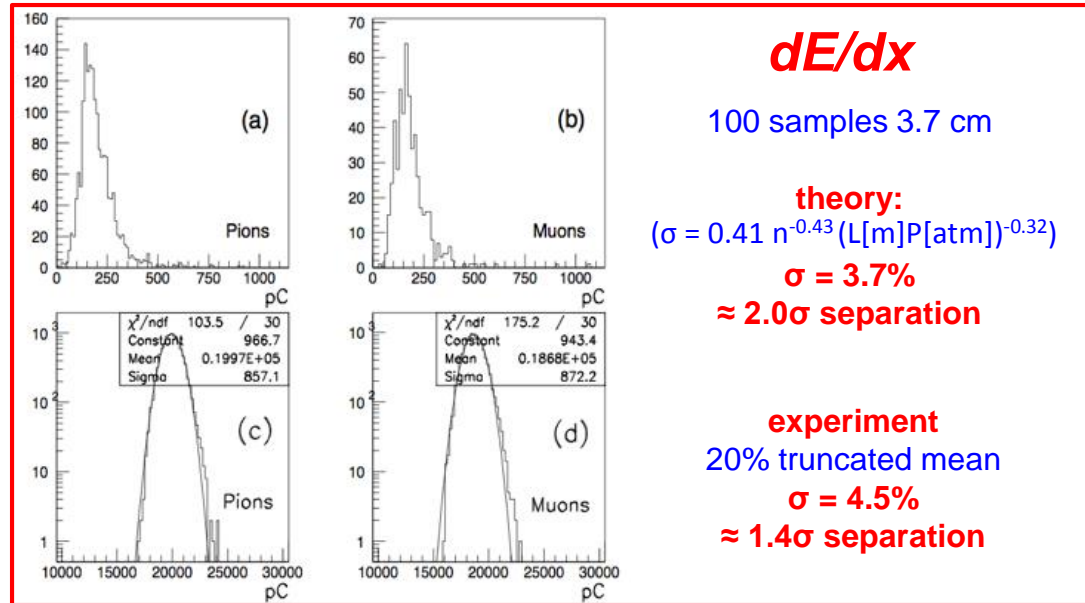

Setup:

25 μm sense wire
 (gas gain 2×10^5),
 through a high BW preamplifier
 (1.7 GHz, gain 10),
 digitized at
 2 GSa/s, 1.1 GHz, 8 bits

(*NIM A386 (1997) 458-469* and references therein)

Cluster Timing/Counting Read Out

Recipe for cluster timing/counting in He based gas mixtures:

FEE: 1 GHz BW, x10 gain (S/N ratio ≈ 8)

digitizer: 2 GSa/s sampling rate, >8 bits

However:

suppose a trigger rate of 10 kHz, an average occupancy of 20% over the 56,000 drift cells, a maximum drift time of 250 ns readout at 2 GSa/s =>

500 GB/s ! (unsustainable!)

Solution:

analyze in real time the signal waveform: find the ionization peaks; register and transfer only the time and amplitude of each peak with a short relative delay with respect to the trigger. This represents a data reduction of about 50, equivalent to a data transfer of

10 GB/s (manageable!)

Cluster Timing/Counting Read Out

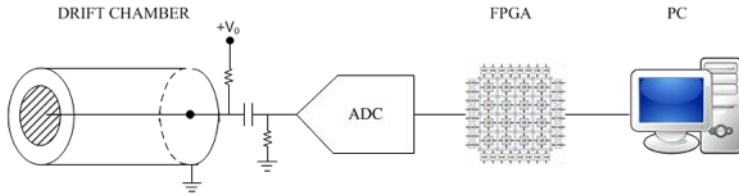

ANALOG DEVICES
AD9625-2.0EBZ

XILINX
UG534 ML605

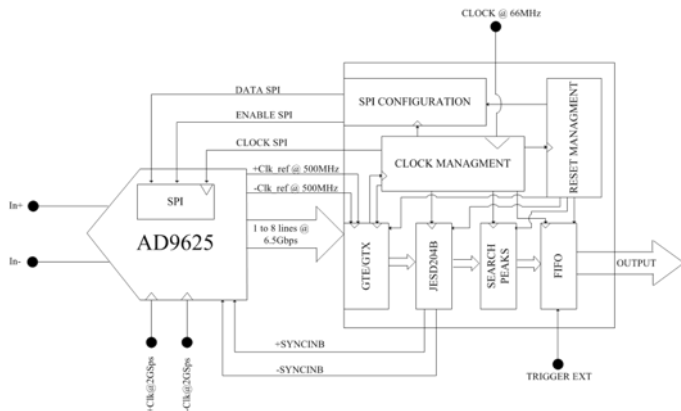
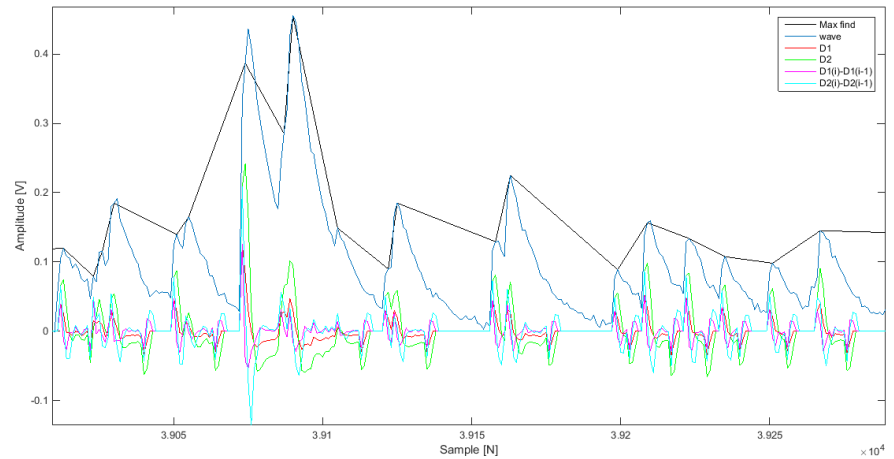
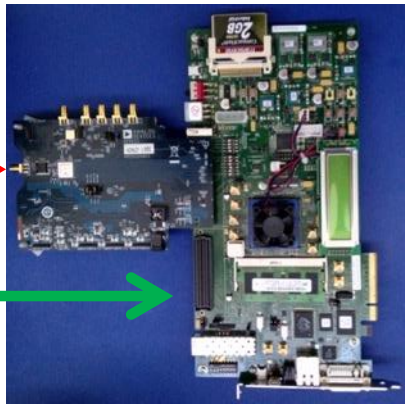

Peak Fake, Efficiency vs Threshold

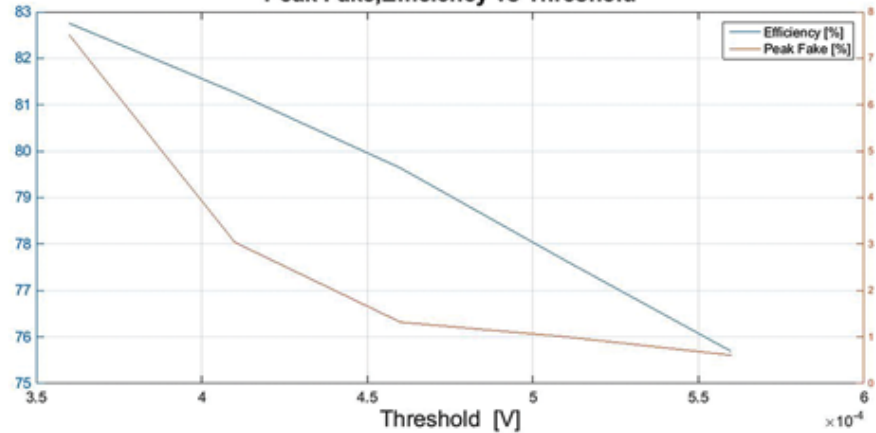

IDEA D.C. full simulation

- Detailed **geometry** description (Geant4 stand alone **and** Mokka (Yin Xu – CEPC note))
- Amount of **materials** accurately accounted for
- Simple model of **hit generation**, no time-to-d, gaussian resol.(detailed model in progress)
- **Cluster timing/counting** to be simulated (no particle id. yet)
- **Track finding** algorithms at preliminary stages
- **Track fitting** (Genfit2 Kalman filter)

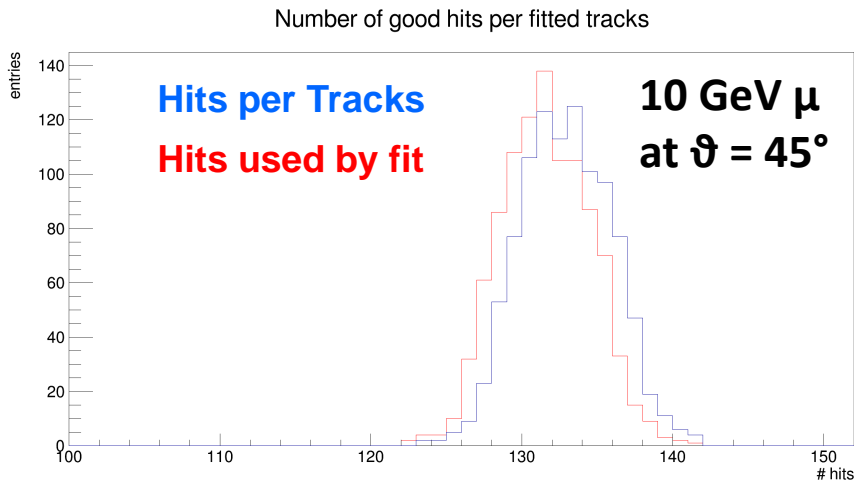
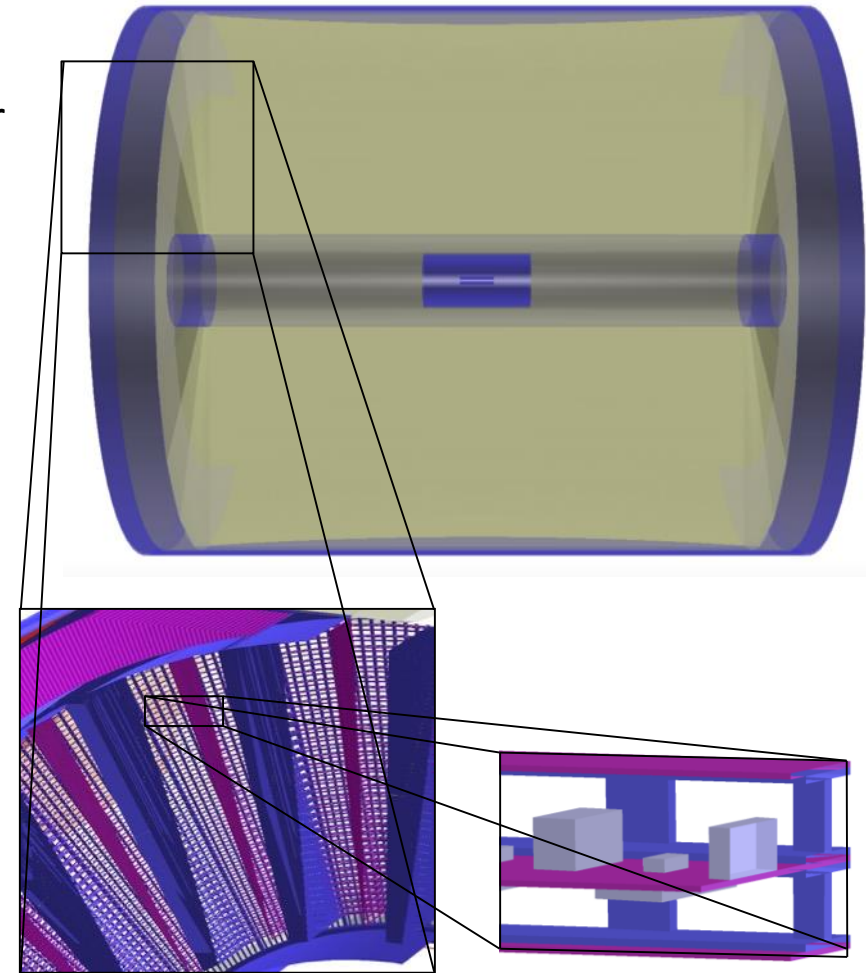

IDEA integrated track simulation

N. good Hits DCH resolution vs Theta

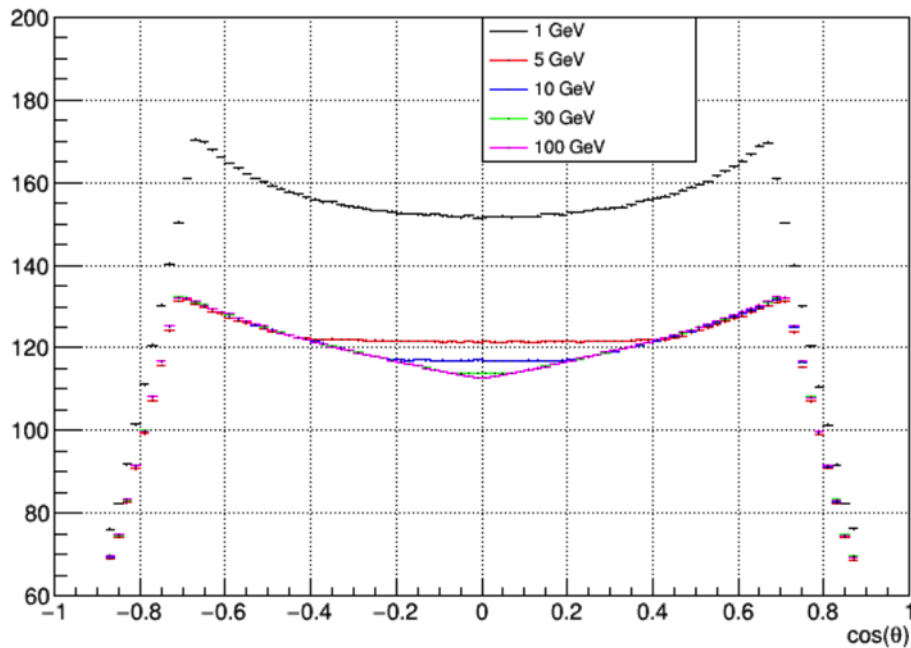

N. good Hits SVX resolution vs Theta

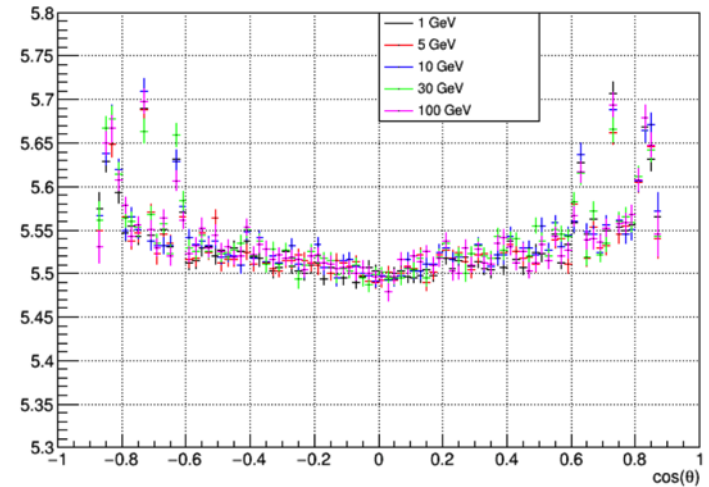

N. good Hits PSHW resolution vs Theta

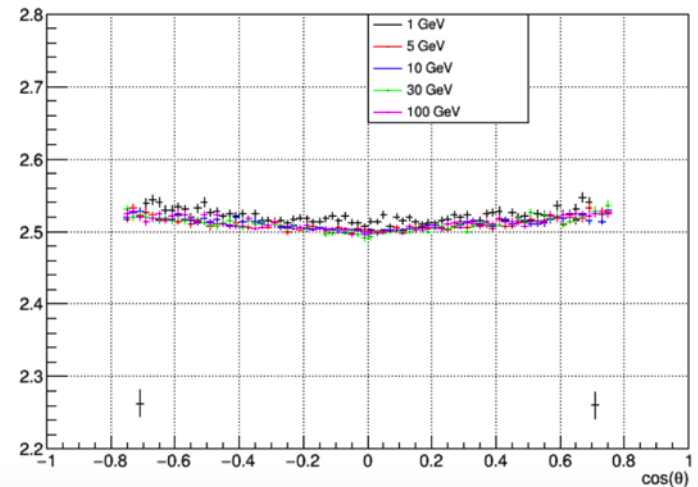

IDEA expected vs simulation

drift chamber alone

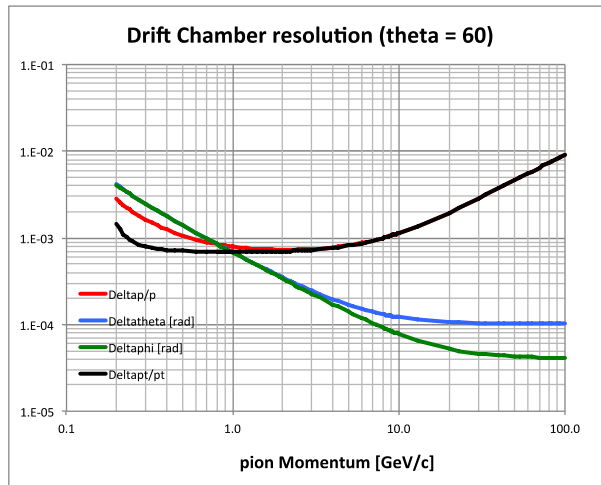

drift chamber w/ vertex + pre-sh.

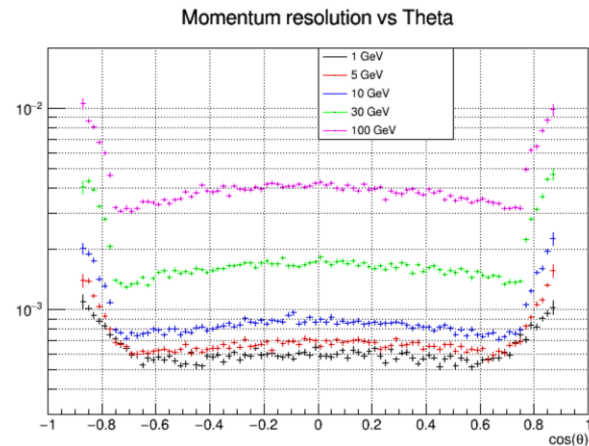
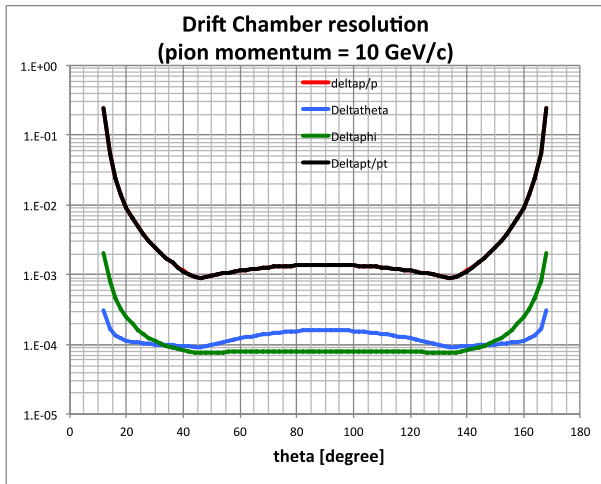
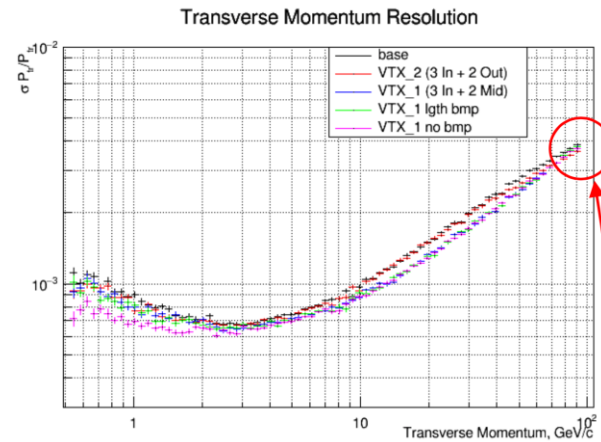

60 cm, 144 cells prototype

Cosmic rays test stand

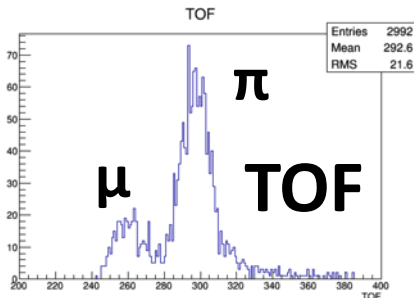
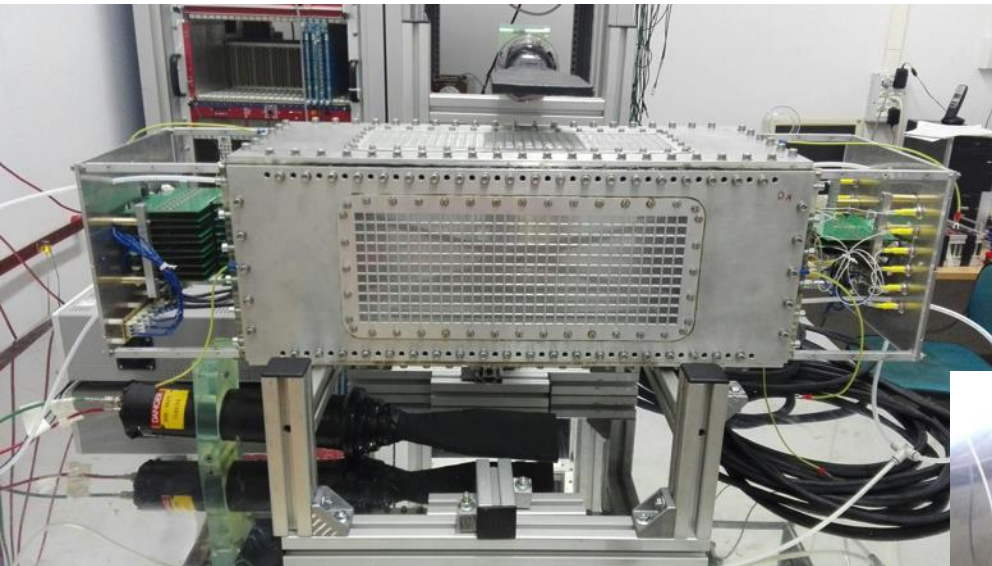

Beam test at PSI
last September

Conclusions

- We have presented an innovative tracking system based on a **"ultra-light drift chamber with peculiar particle identification capabilities"** using cluster timing/counting techniques for the CEPC facility.
- It consists of a full stereo, single sense wire, square cells drift chamber:
 - $R_{in} = 35 \text{ cm}$; $R_{out} = 200 \text{ cm}$; $L = 400 \text{ cm}$; **112 layers**; **56,000 cells (12 to 15 mm)**; stereo angles ranging from **50 mrad to 150 mrad**; fully efficient down to **$\cos\vartheta = 0.97$** ;
 - **2% X_0 in the barrel region**
 - **5% X_0 (including services) to the end cap region**
- Expected spatial resolutions: **$\sigma_{r\phi} < 100 \mu\text{m}$, $\sigma_z < 1 \text{ mm}$**
- Expected momentum resolutions: **$\Delta p/p^2 = 4 \times 10^{-5} (\text{GeV}/c)^{-1}$** , angular resolutions: **$\Delta\vartheta = 2.0 \times 10^{-5} \text{ rad}$** and **$\Delta\phi = 3.0 \times 10^{-5} \text{ rad}$** at **$p=100 \text{ GeV}/c$** (with vertex detector and pre-shower)
- Expected π/κ separation **$> 3\sigma$ for $p < 850 \text{ MeV}/c$ and $p > 1050 \text{ MeV}/c$**