

*Dual-Readout Calorimetry
@ FCCee*

Roberto Ferrari
INFN RD_FA collaboration

CERN, January 30th, 2018

Dual-Readout Calorimetry

What:

correct hadronic energy measurements for f_{em} fluctuations

How:

use two independent sampling processes, with different sensitivity to em and non-em shower components, to reconstruct f_{em} event-by-event

(see backup slides)

The Math

$$S = E \times [f_{em} + (h/e)_S \times (1 - f_{em})]$$

$$C = E \times [f_{em} + (h/e)_C \times (1 - f_{em})]$$

with $(h/e)_S$ and $(h/e)_C$ detector specific constants.

Solving the system, both E and f_{em} can be reconstructed:

$$E = (S - \chi C) / (1 - \chi)$$

where:

$$\begin{aligned} \chi &= (1 - (h/e)_S) / (1 - (h/e)_C) \\ &= (E - S) / (E - C) \end{aligned}$$

→ χ can be extracted from testbeam data

from PMT to SiPM Readout

SiPM + :

- *compact readout (no fibres sticking out)*
- *longitudinal segmentation possible*
- *operation in magnetic field*
- *larger light yield (main limitation to Čerenkov signal)*
- *high readout granularity → particle flow “friendly”*
- *photon counting (calibration)*

SiPM - :

- *signal saturation (digital light detector)*
- *cross talk between Čerenkov and scintillation signals*
- *dynamic range*
- *instrumental effects (stability, afterpulsing, ...)*

2017 RD52 Testbeam Layout

Brass module, dimensions: ~ 112 cm long, 12×12 mm²

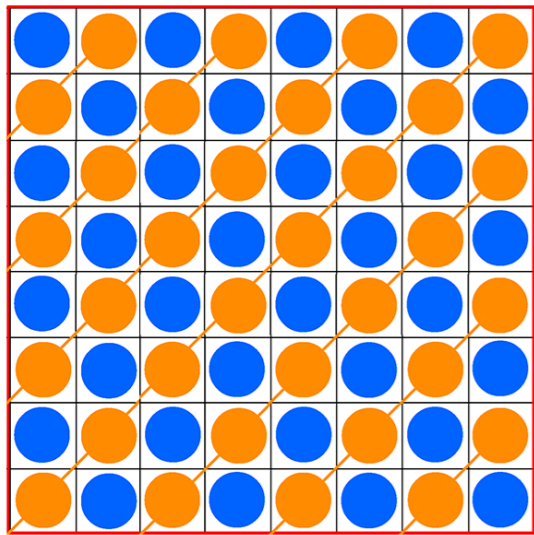

● Č
● S

↓
↑
 1.4 mm

32 (S) + 32 (Č) fibres

$X_0 \sim 29$ mm

$R_M \sim 31$ mm

$\sim (0.4 R_M)^2 \times 39 X_0$

shower cont. $\sim 45\%$

$f_{\text{sampl}} \sim 5-6\%$

Light sensors (SiPM)

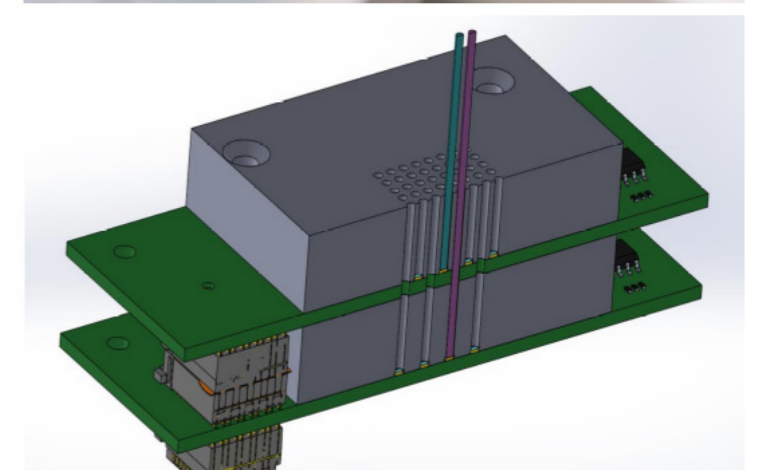
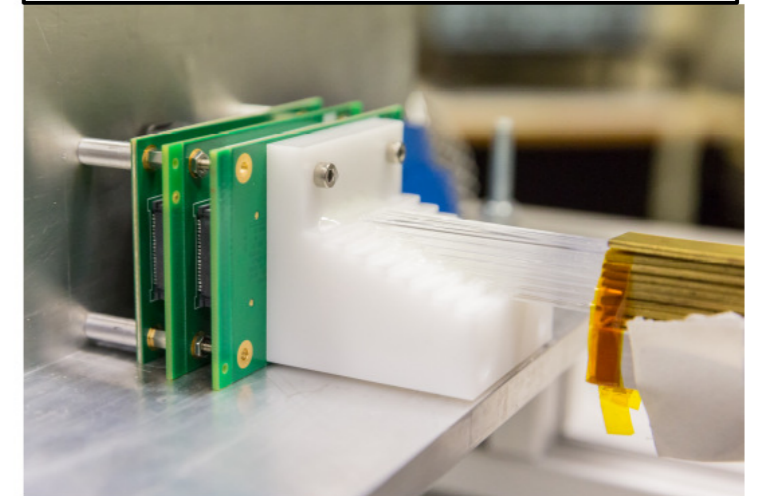

Experimental setup

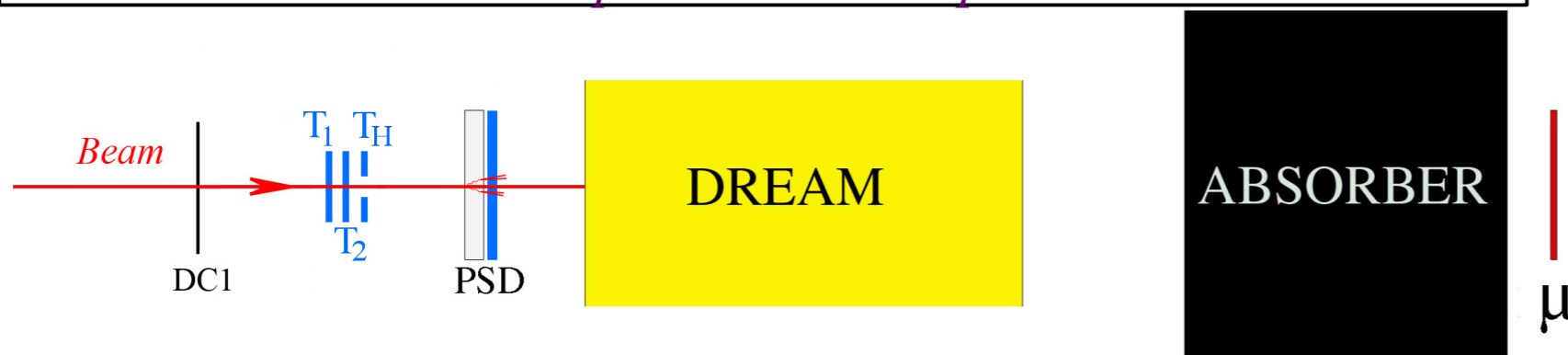

Trigger : $(T_1 \cdot T_2 \cdot \overline{T_H})$

em performance: light yields

S signal/GeV vs. E(GeV)
(ultra low PDE, corrected)

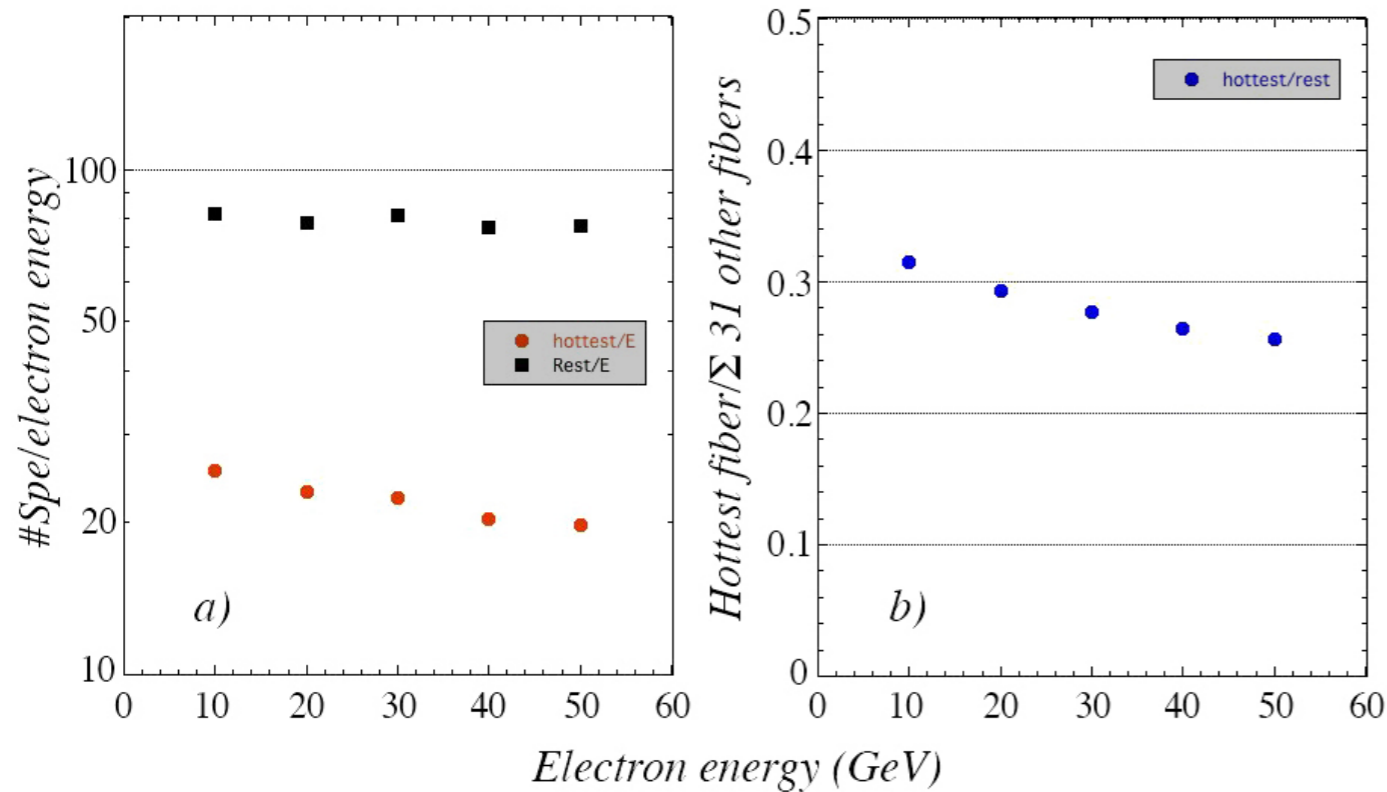

Č signal/GeV vs. E(GeV)
(intermediate PDE)

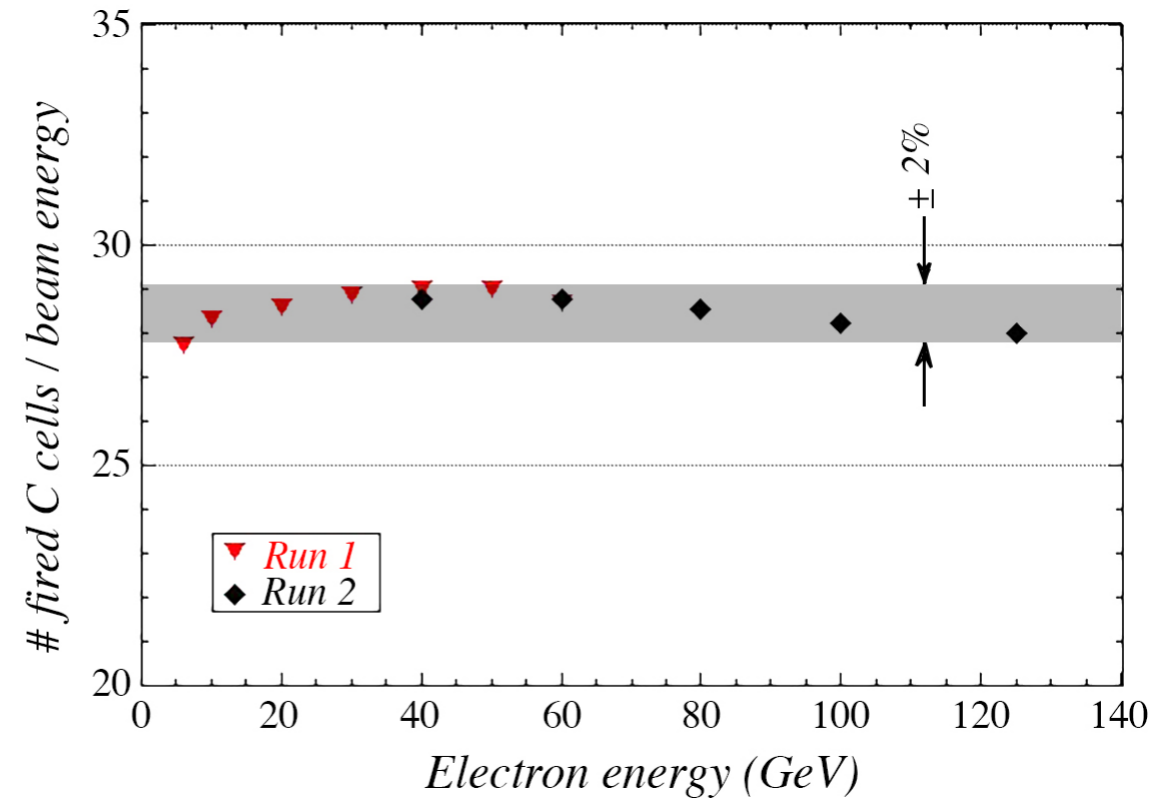

~28.4 fired cells / GeV
⇒
~60 p.e. / GeV @ full containment

a) Č : linear response (independent of energy)

b) S : non linearity even at ultra low PDE

→ go to $10 \times 10 \mu\text{m}^2$, 10000 cells in scintillating fibres

Lateral shower profile

10 / 40 GeV e^-
 $\theta, \Phi = 0^\circ$

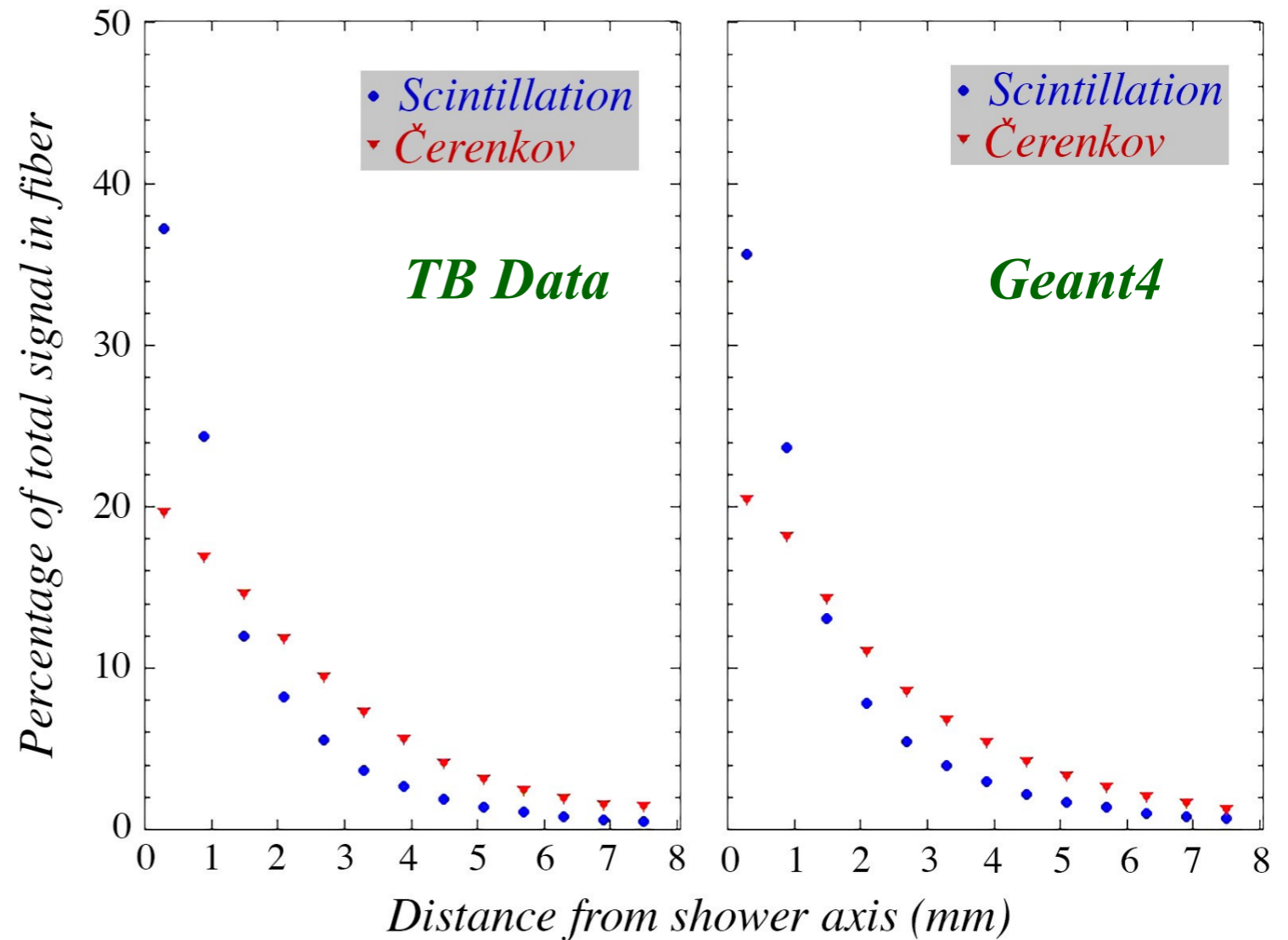

em shower are very narrow:

$\sim 10\%$ ($\sim 50\%$) within ~ 1 (~ 10) mm from shower axis
→ fibre readout can easily provide (powerful) input to PFA

Geant4 – e.m. resolution(s)

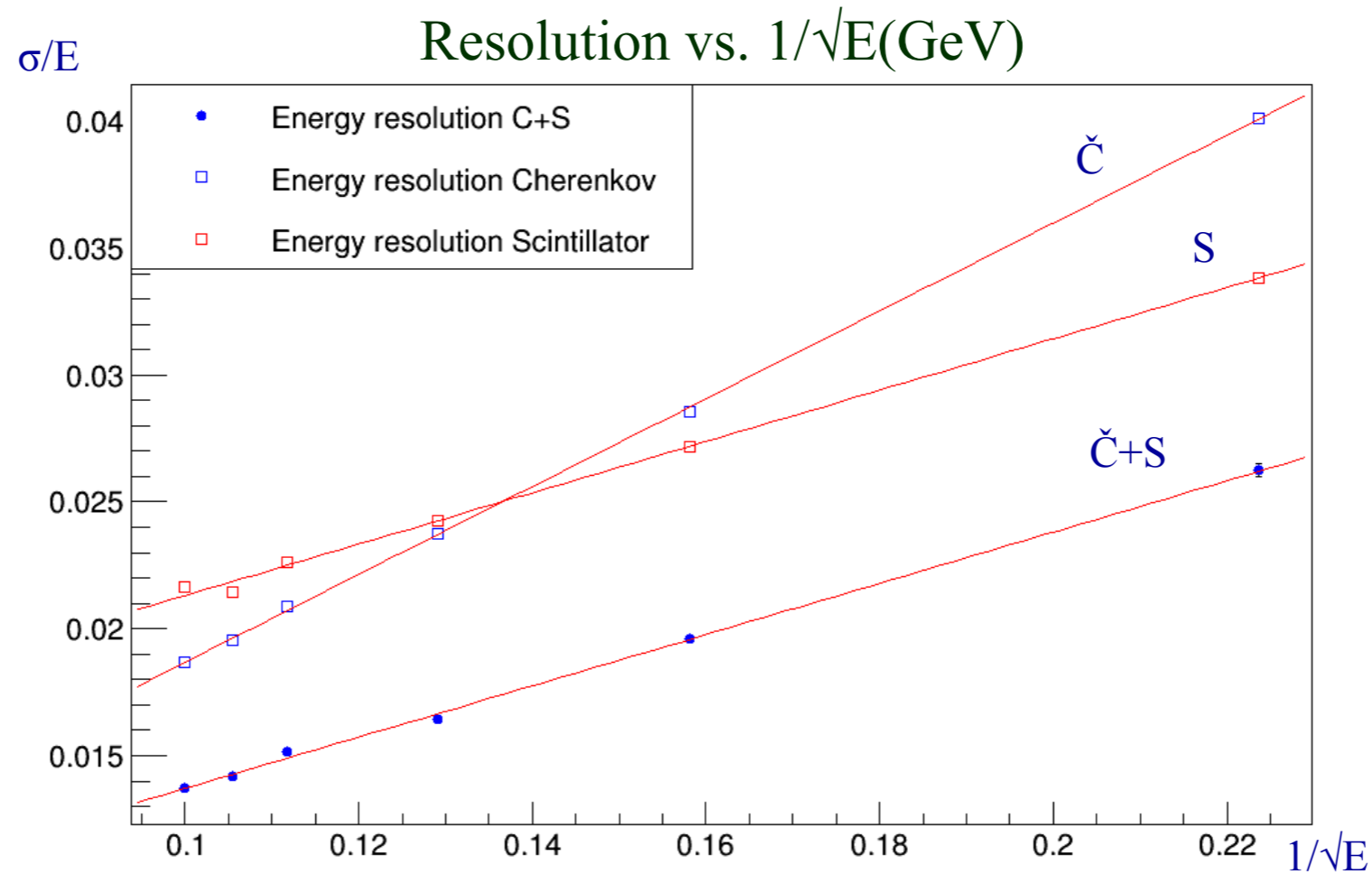

S-only: $10.5/\sqrt{E}+1.1$ (%)

Č-only: $17.9/\sqrt{E}$ (%)

(unweighted) average: $10.3/\sqrt{E}+0.3$ (%)

Geant4 – Cu hadronic performance (preliminary)

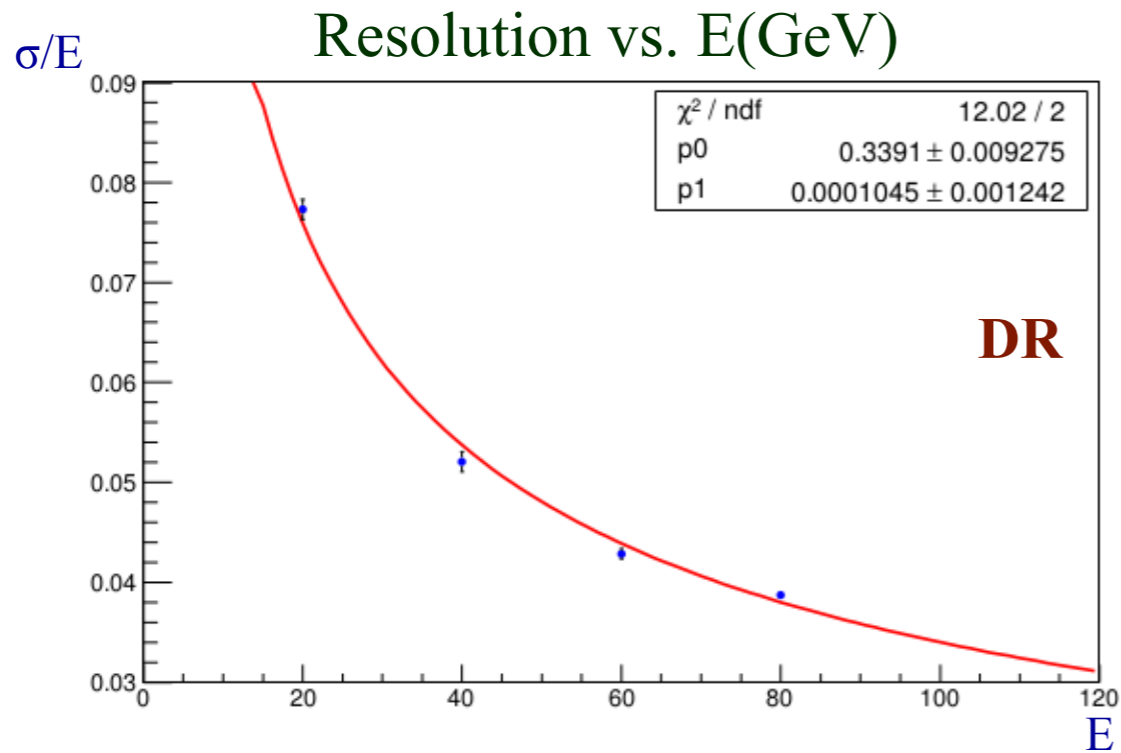

$$\check{C}: \sim 73/\sqrt{E} + 6.6 (\%)$$

$$S: \sim 30/\sqrt{E} + 2.4 (\%)$$

$$DR: \sim 34/\sqrt{E} (\%)$$

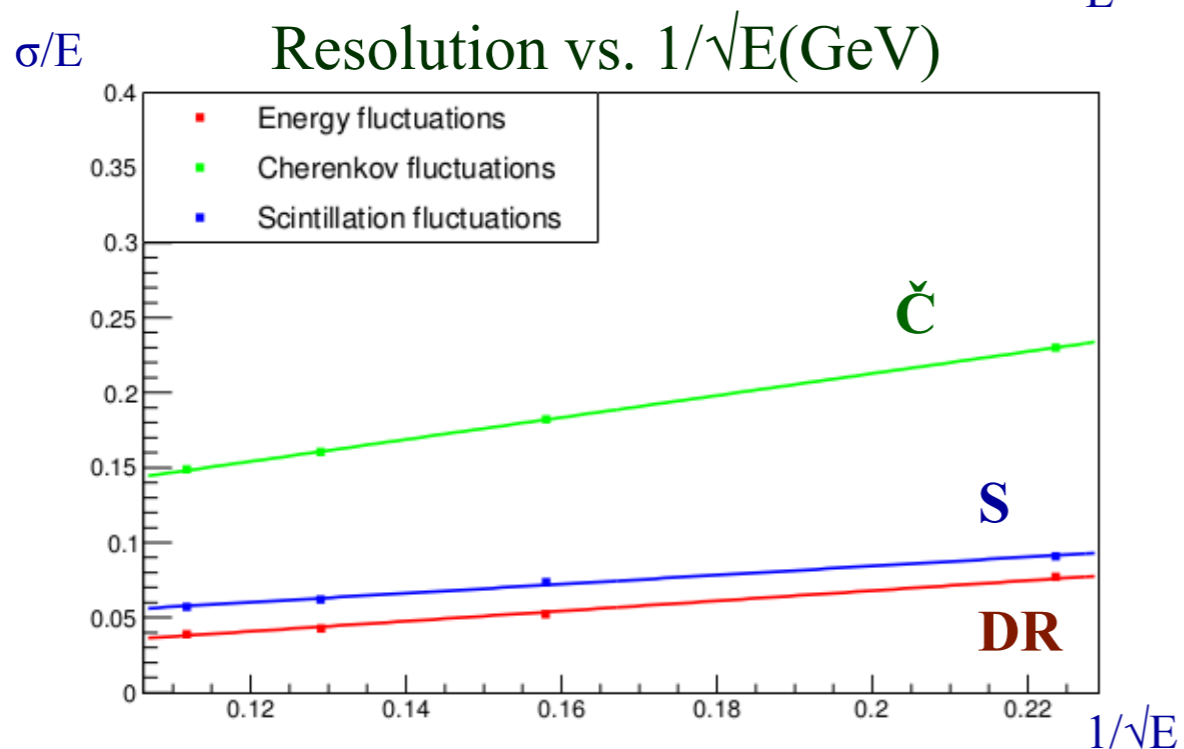

High-energy single- π resolutions:

$$\sigma/E(100 \text{ GeV}) \sim 3.5\%$$

$$\sigma/E(300 \text{ GeV}) \sim 2.3\%$$

$$\sigma/E(1000 \text{ GeV}) \sim 1.7\%$$

Invisible Energy (50 GeV π^-) - correlations

Copper

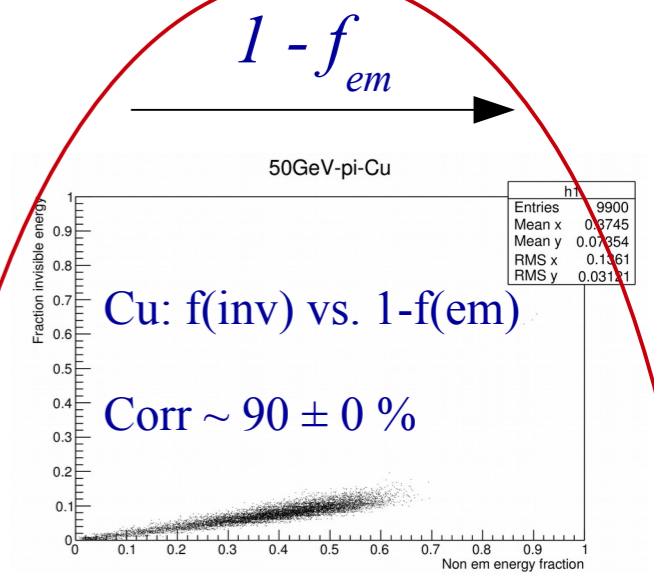
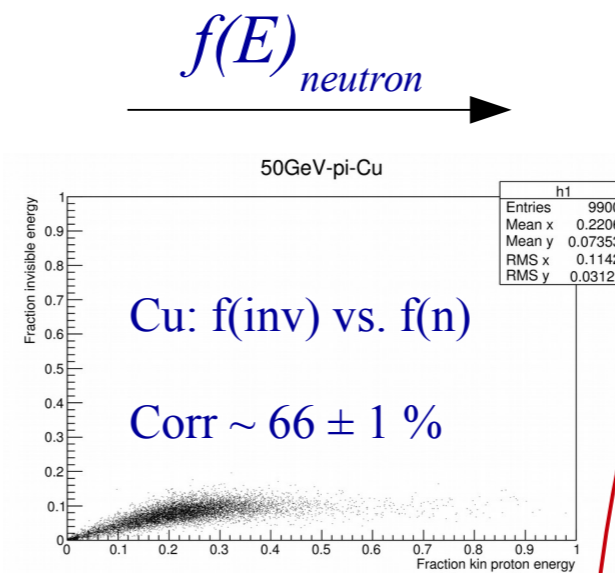
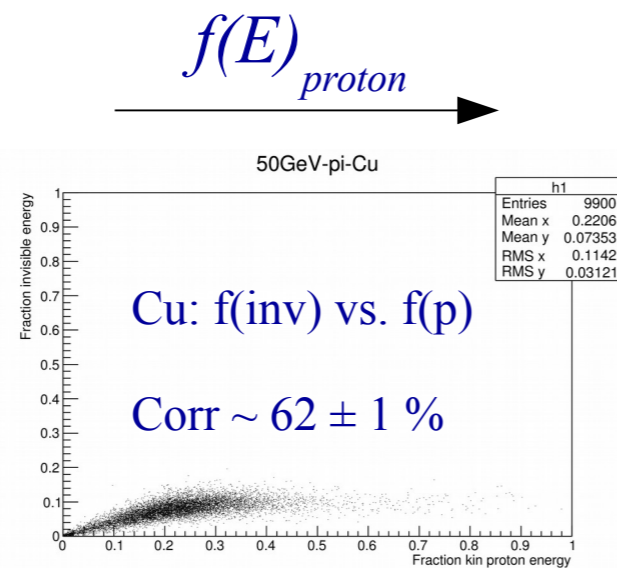

Iron

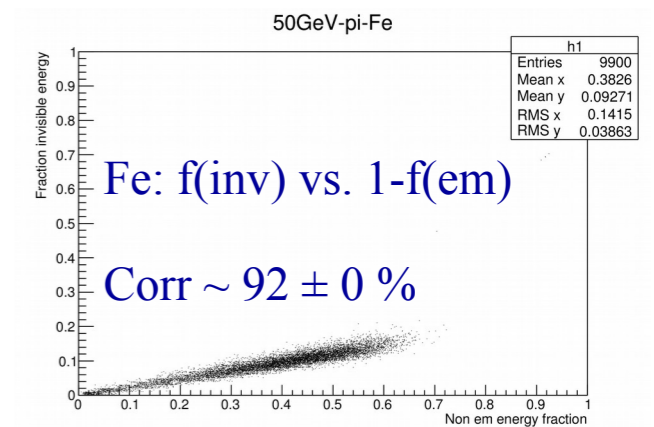
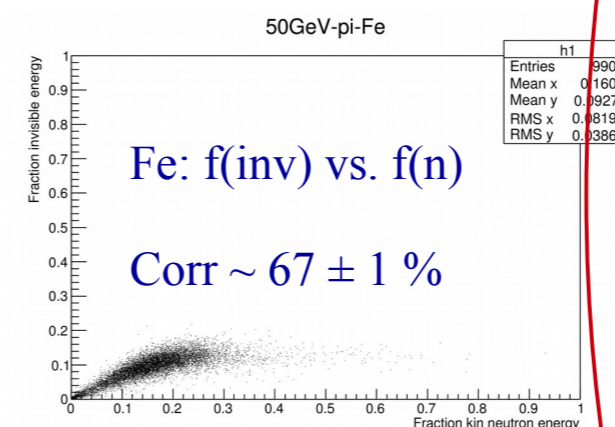
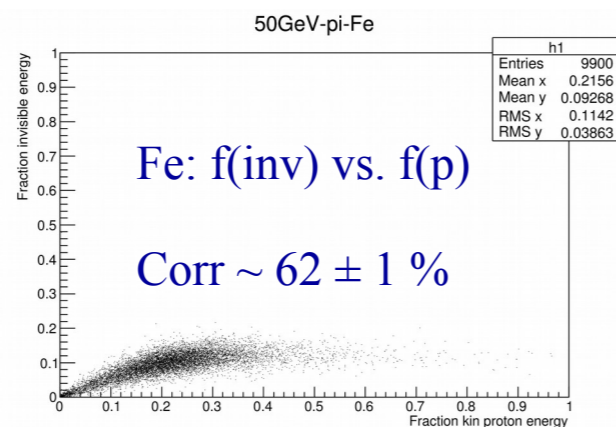

Lead

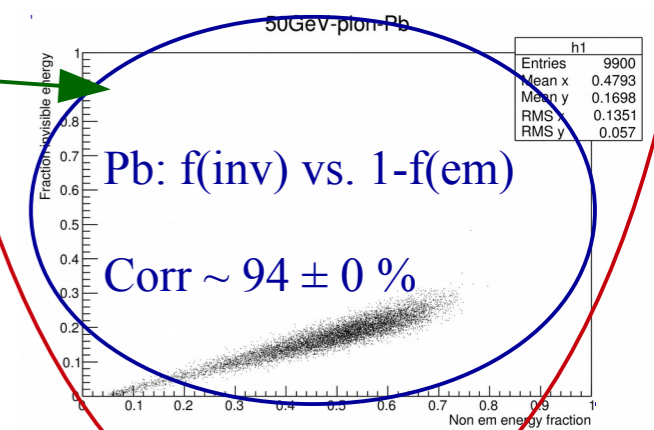
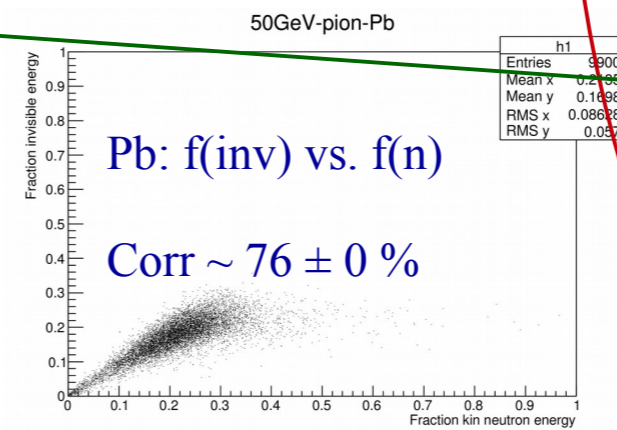
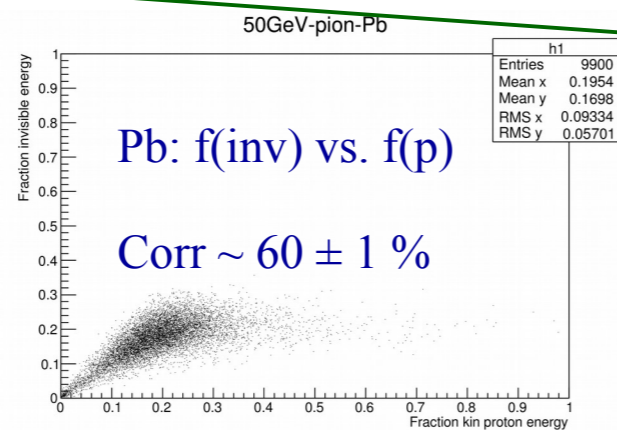

Particle Id & W/Z - Copper vs. Lead

C/S ratio for 80 GeV e^- and p

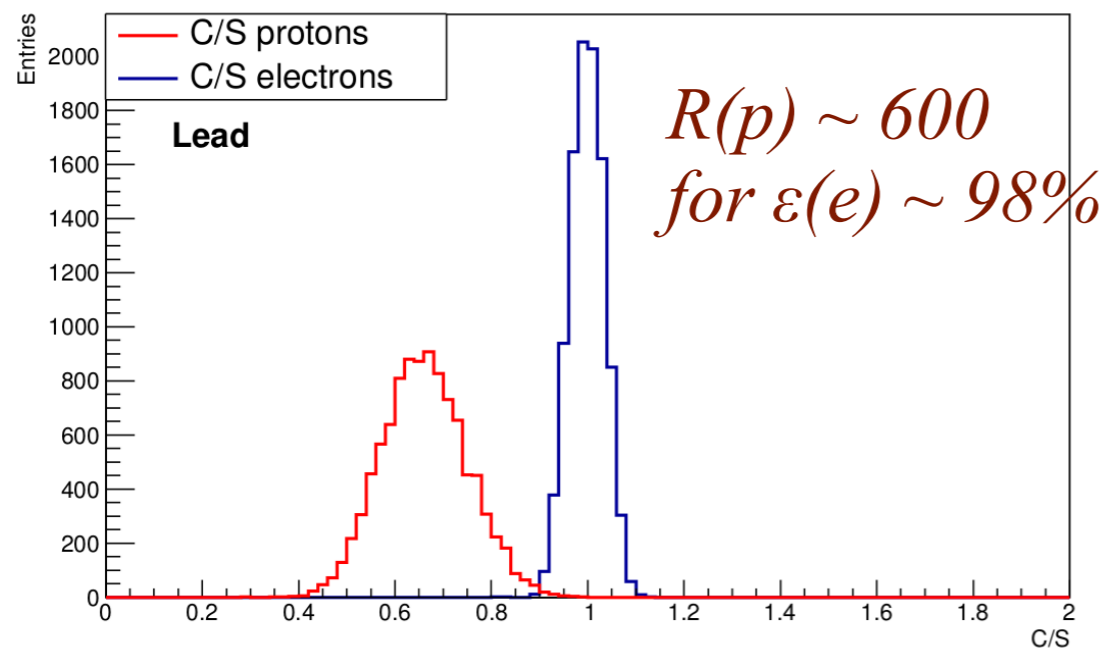
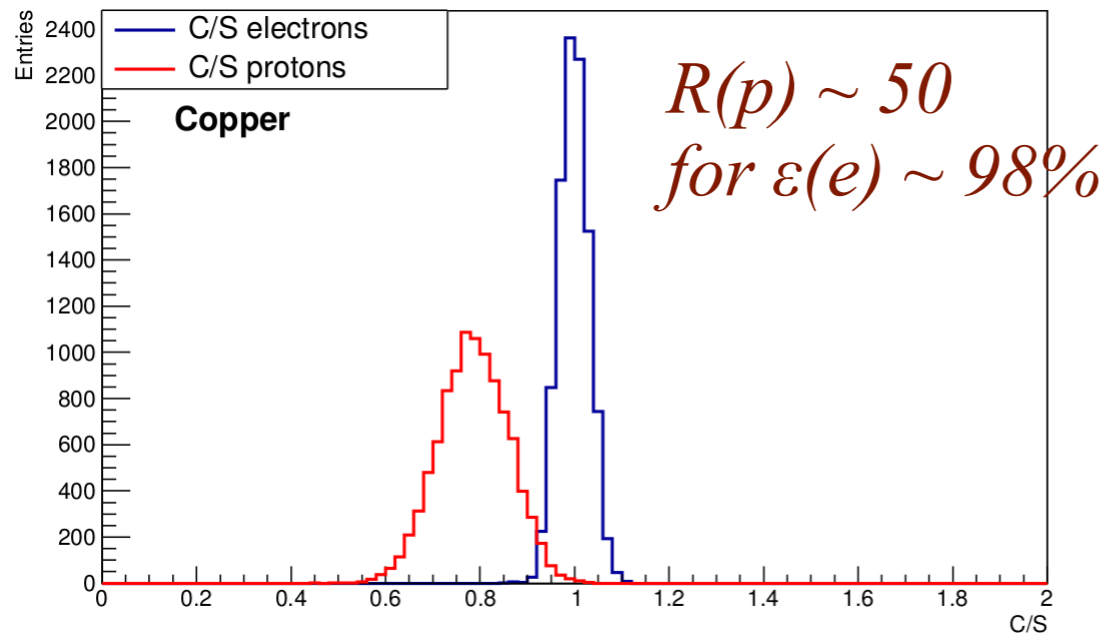

Multiple hadrons, 81 & 91 GeV

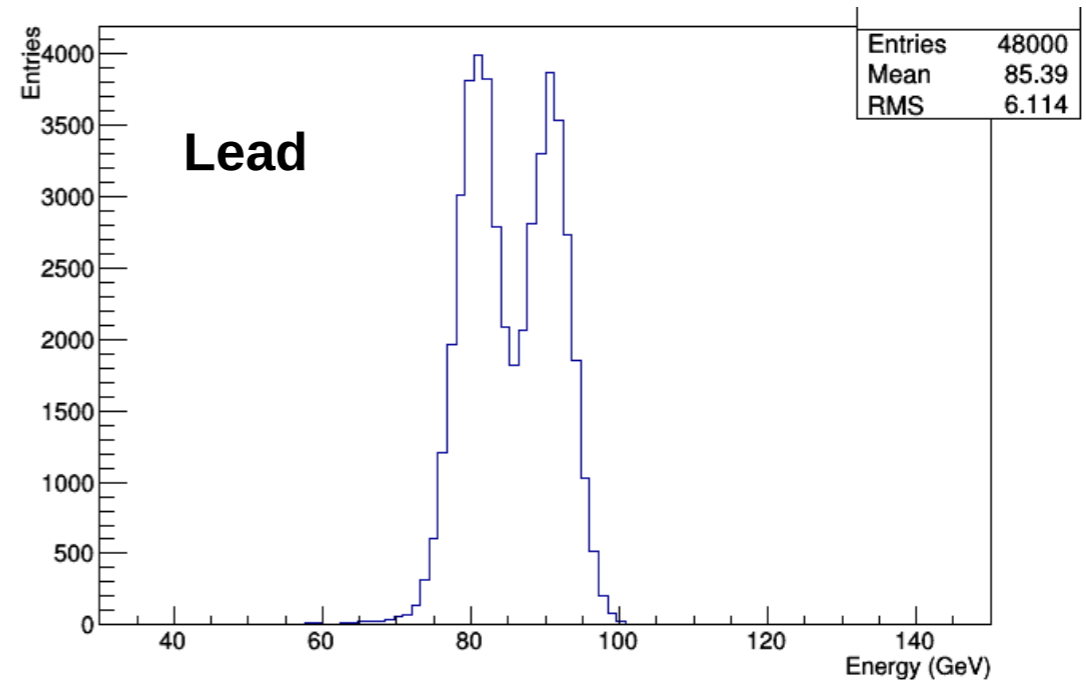
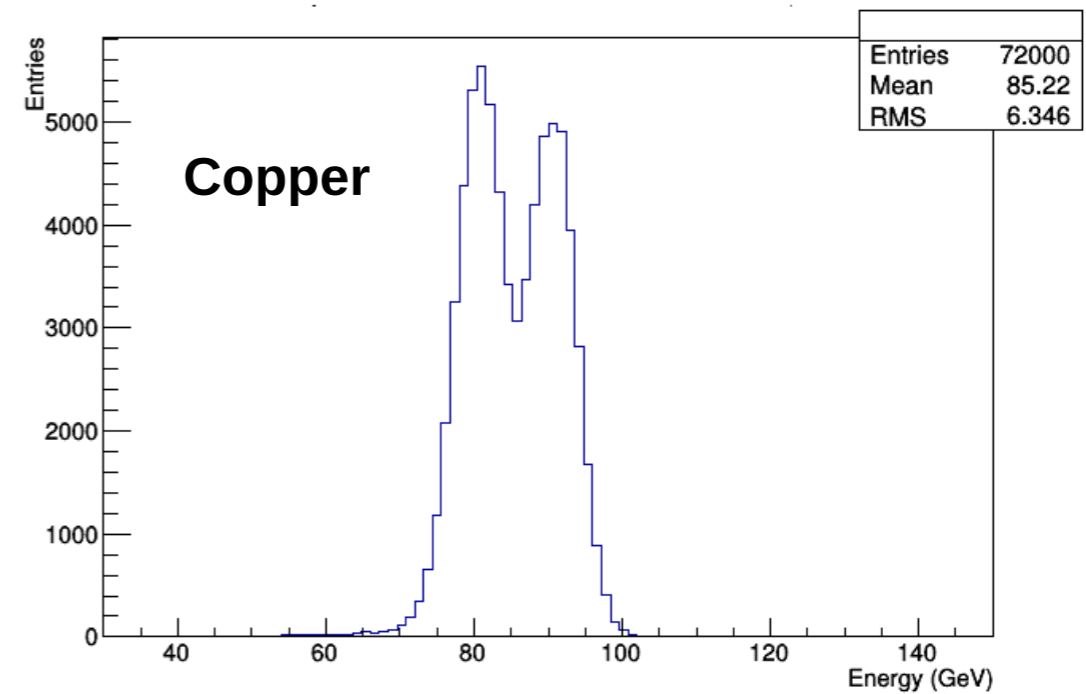

Particle ID (electron/hadron separation)

Methods to distinguish e/π in longitudinally unsegmented calorimeter

RD52 lead calorimeter

(60 GeV) e^- vs. π^-

$\epsilon(e^-) > 99\%$

$R(\pi^-) \sim 500$

Lateral shower profile

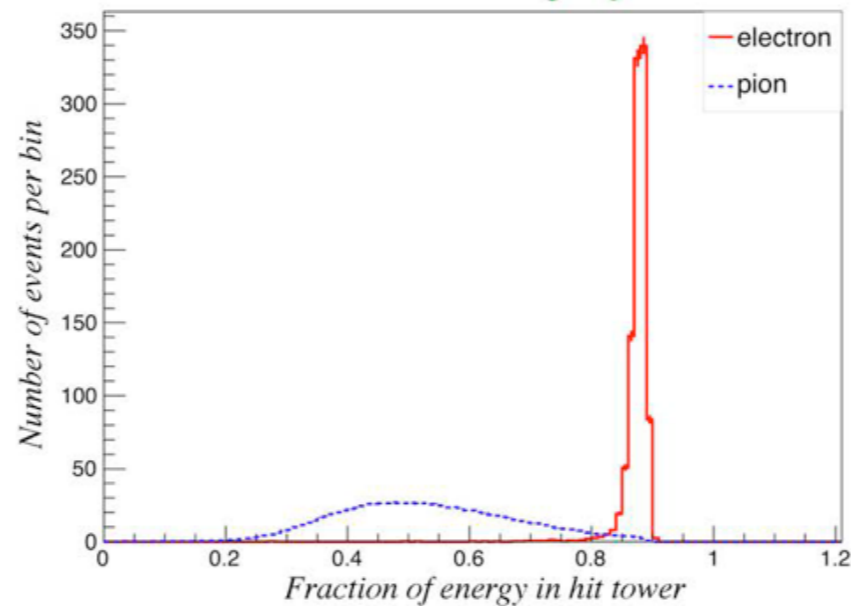

Difference C/S signals

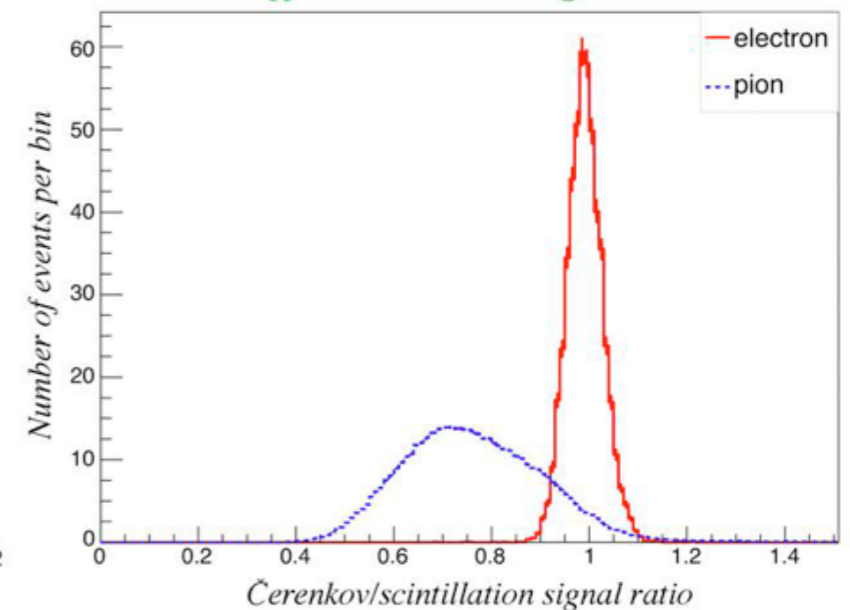

Starting time PMT signal

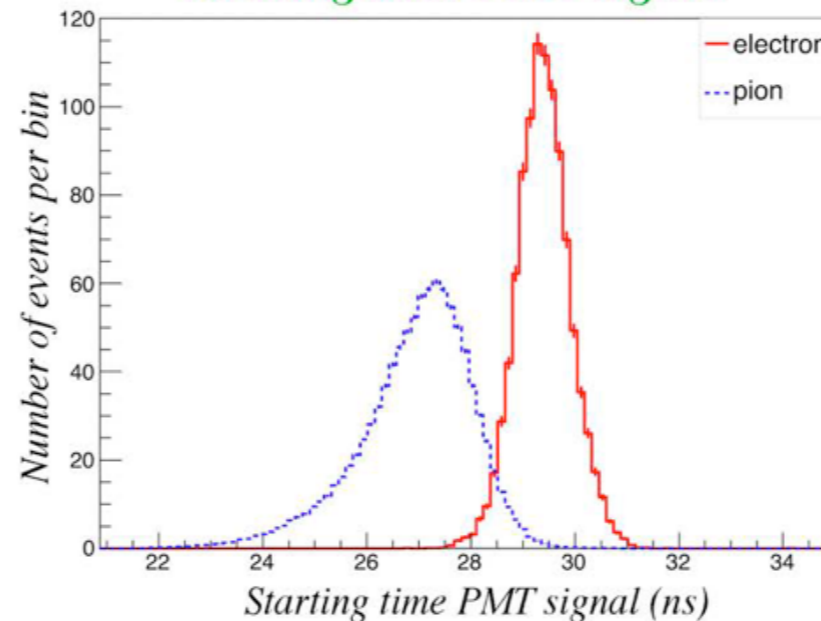

Signal charge/amplitude ratio

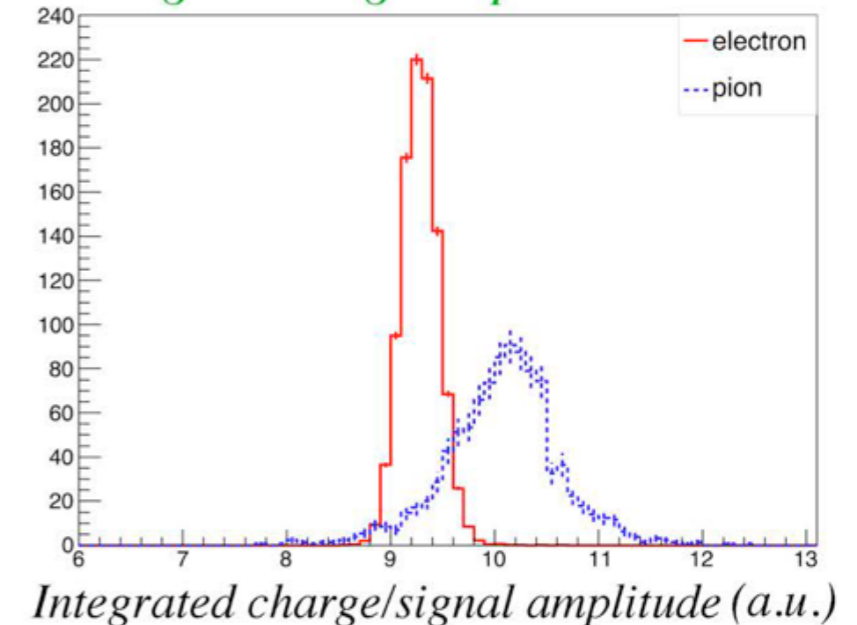

NIM A 735 (2014) 120

4 π Simulations

Dual-readout calorimeter description for CepC/FCCee simulation sw:

Hyunsuk Jo¹, Taeun Kwon², Kyeongpil Lee², Sehwook Lee¹, Hwidong Yoo²

¹Kyungpook National University, ²Seoul National University

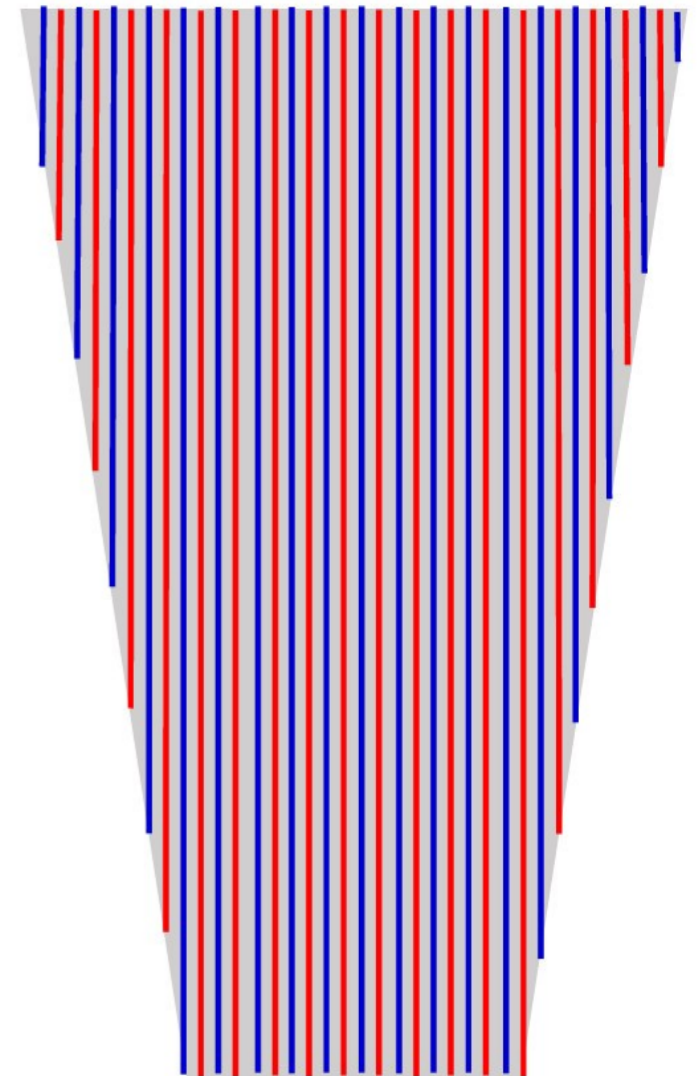
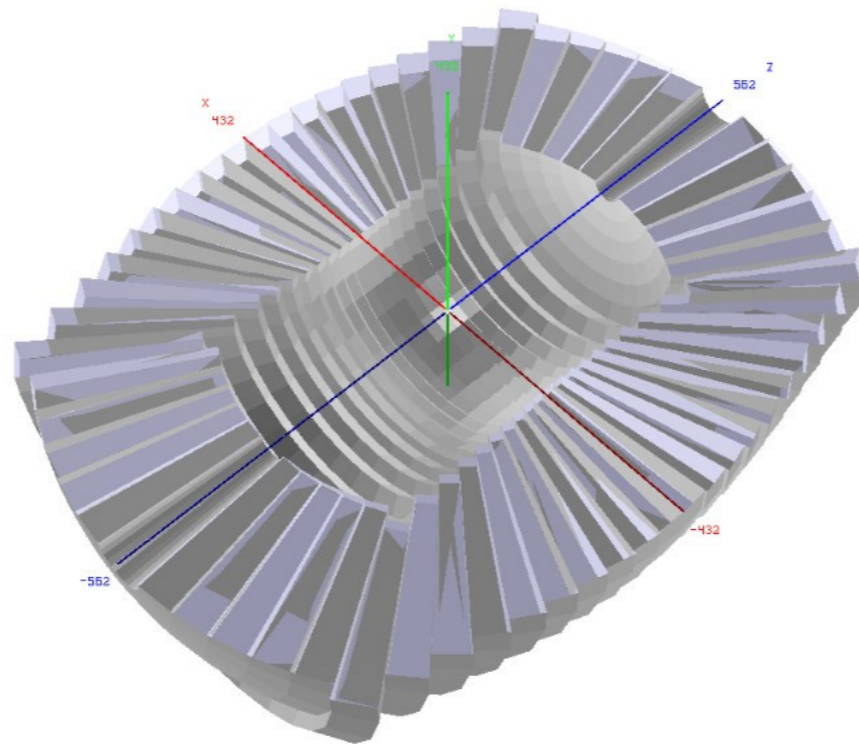
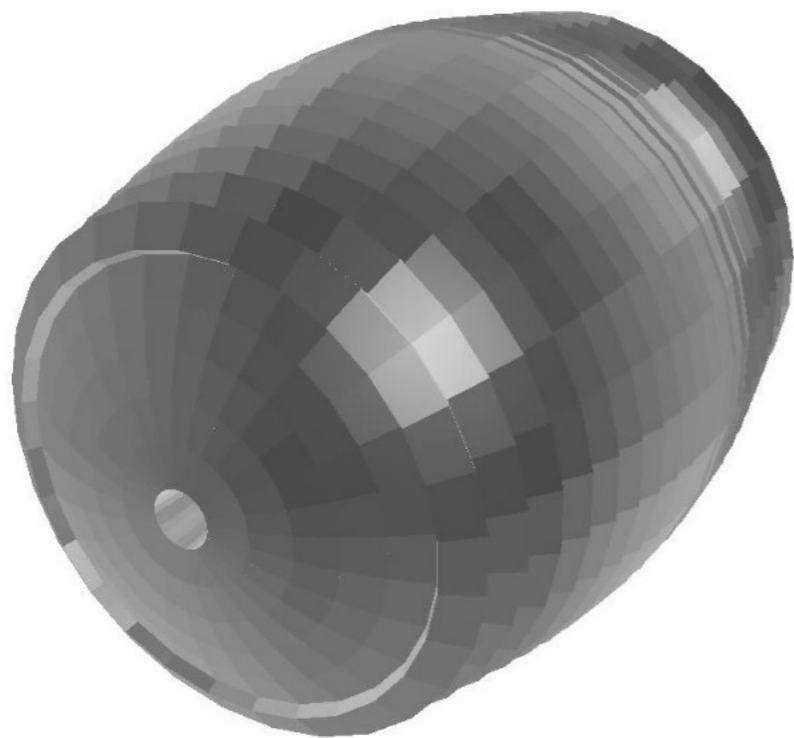

a) full coverage
b) projective geometry

Wedge Geometry

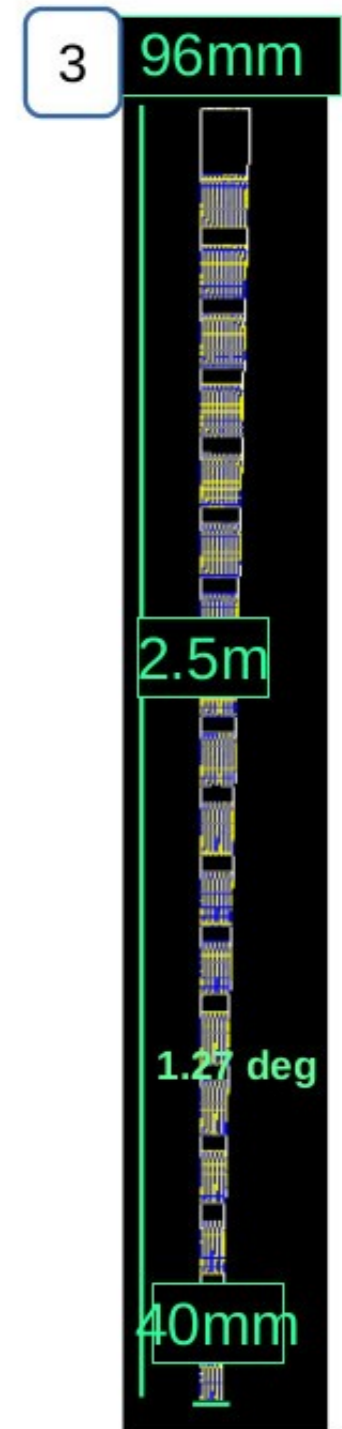
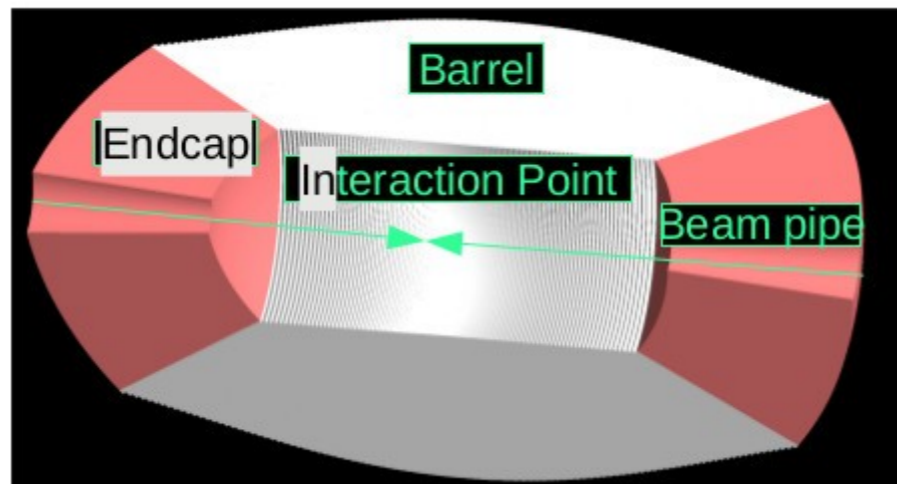
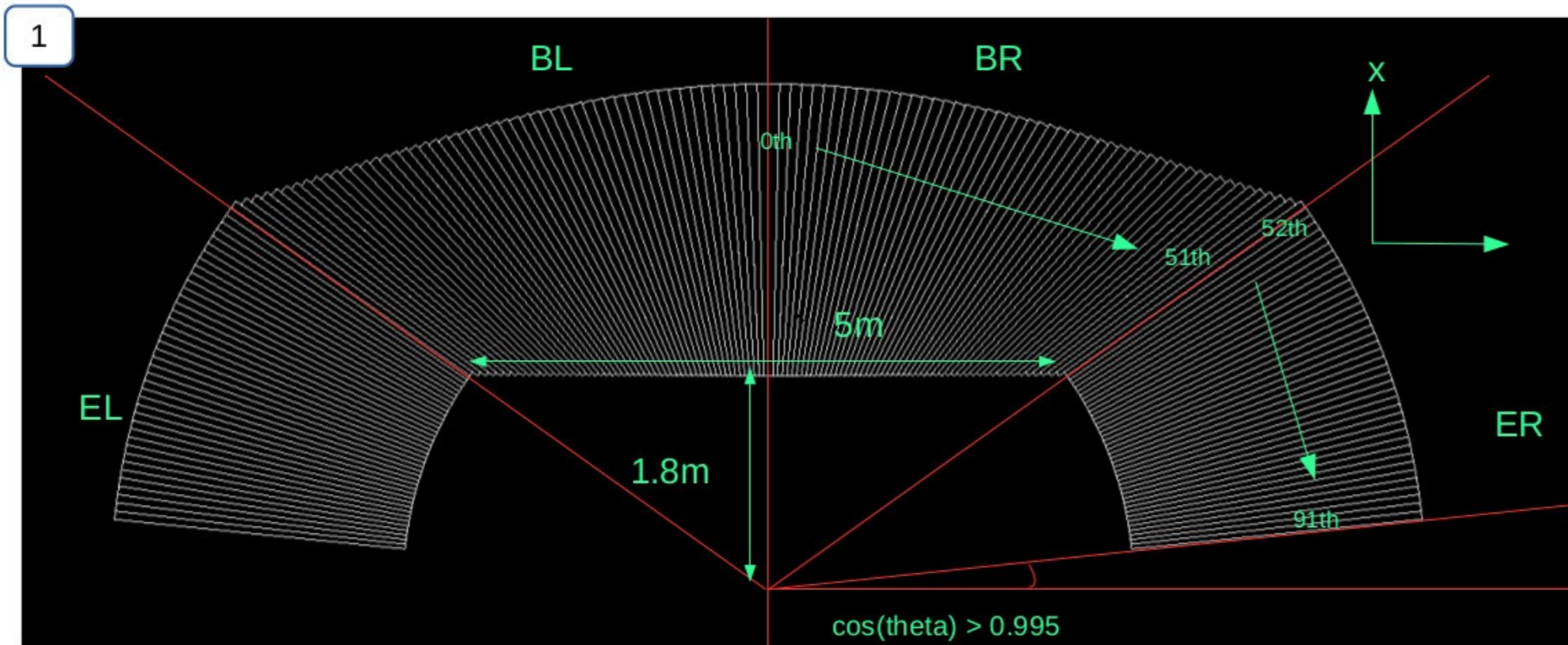

*Čerenkov light yield set to 30 p.e./GeV
 Calibrated w/ 20 GeV e^- beam @ $[1^\circ, 1.5^\circ]$*

em Performance

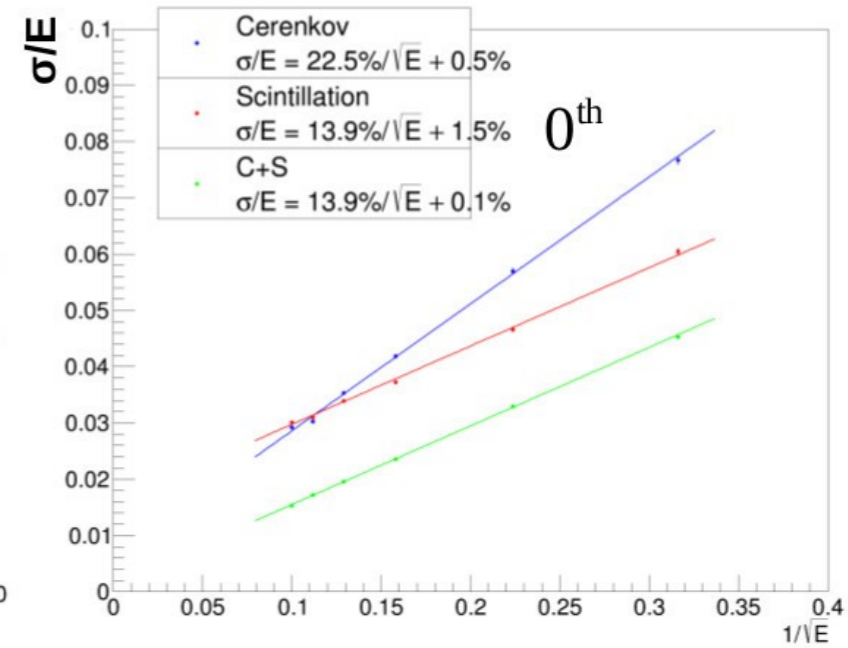
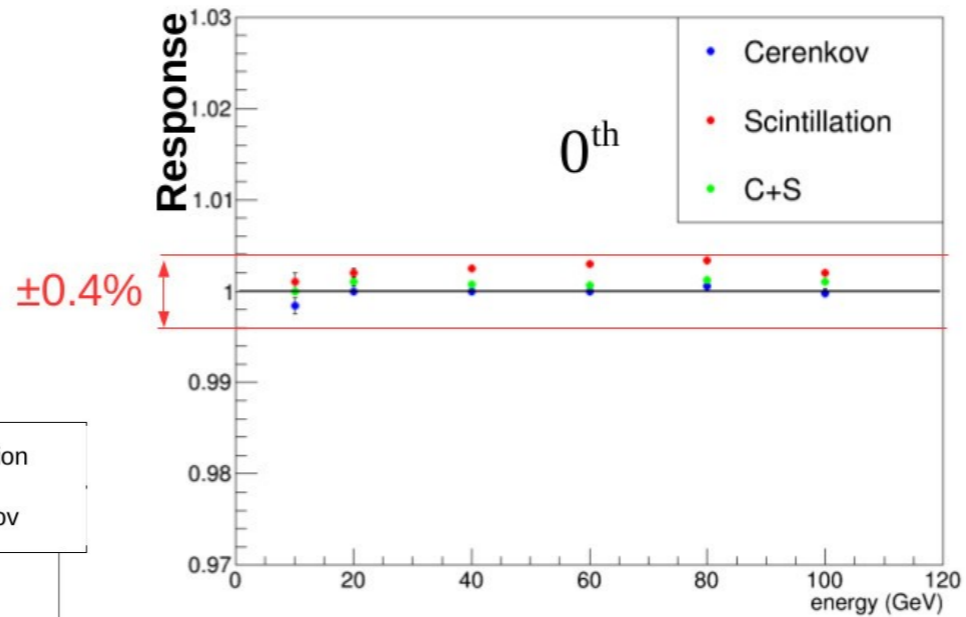
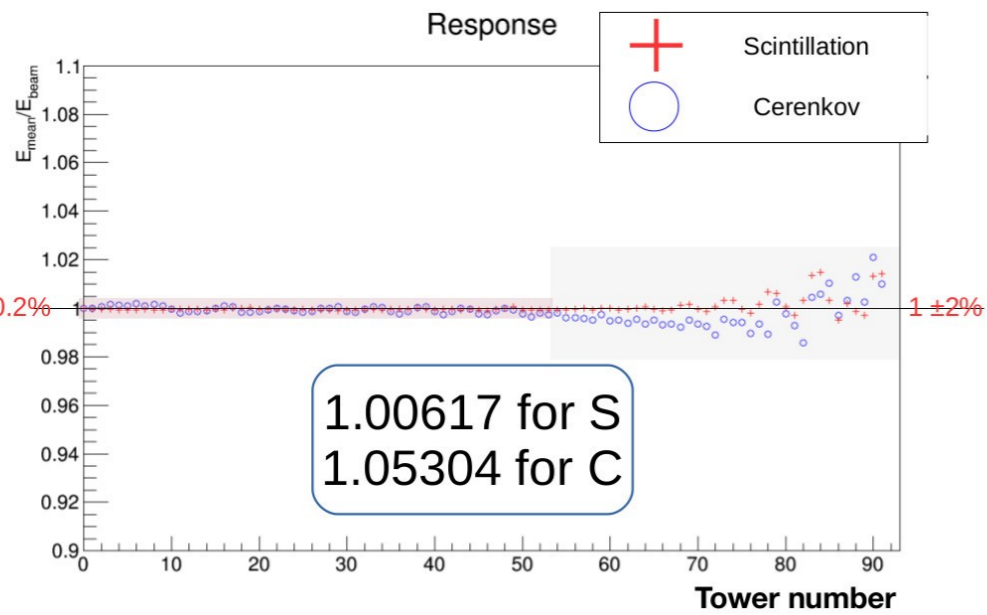

$\sigma/E \sim 14.0\% / \sqrt{E} + 0.1\%$

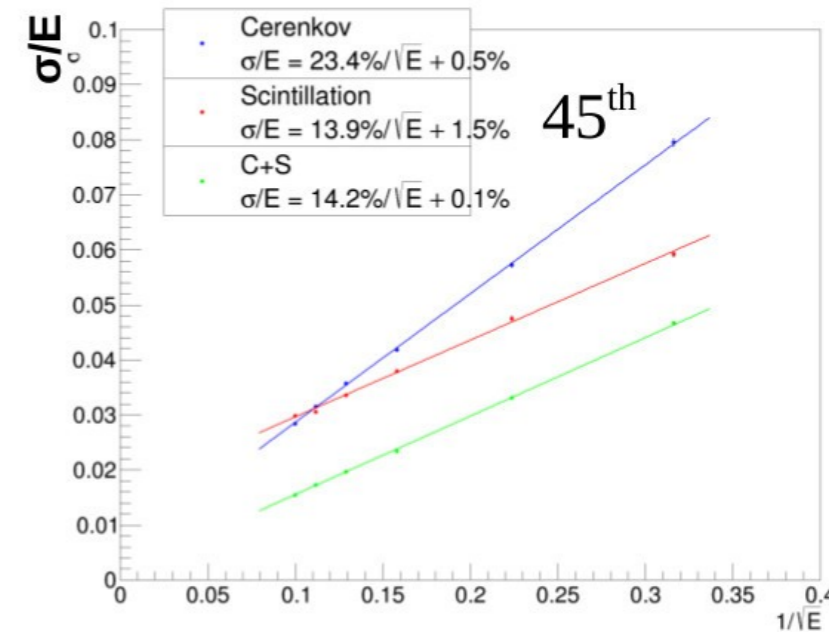
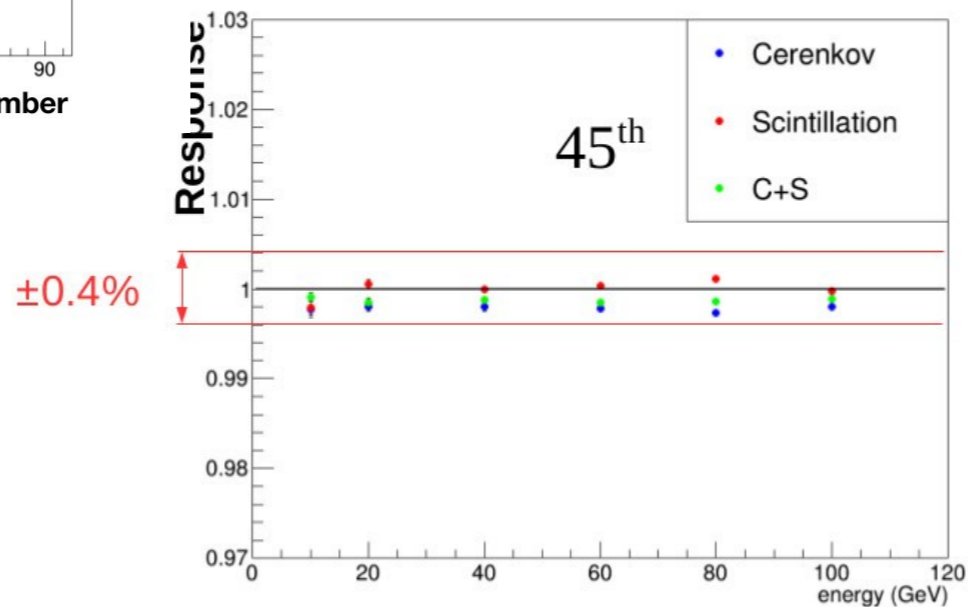

had Performance

$$E = \frac{S - \chi C}{1 - \chi}$$

with $\chi = 0.29$

$E(\text{rec})/E(\text{beam}) \sim 92\% \pm 1\%$

$\sigma/E \sim 26\% / \sqrt{E} + 1\%$

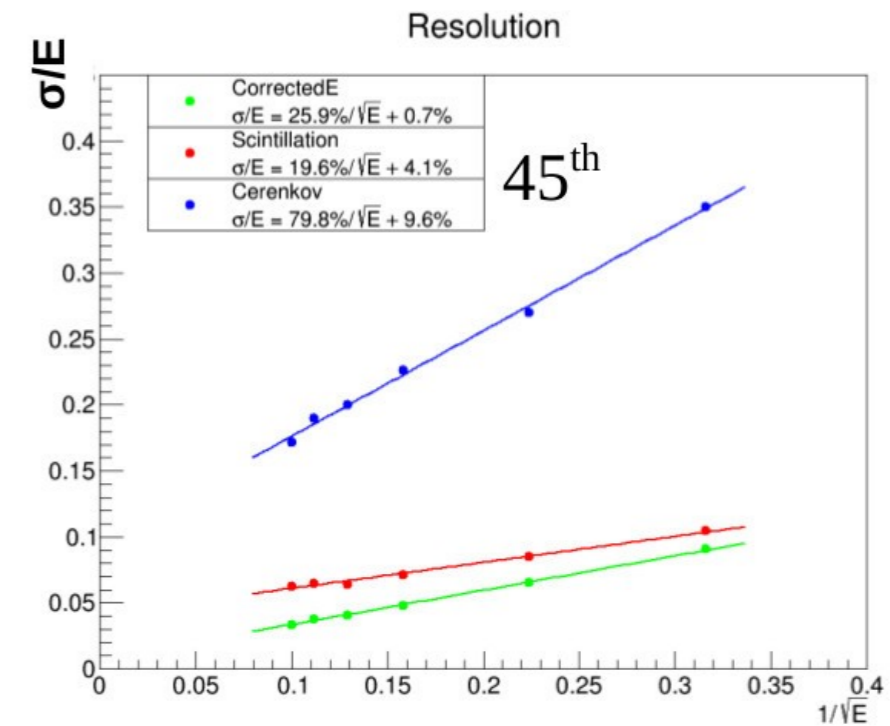
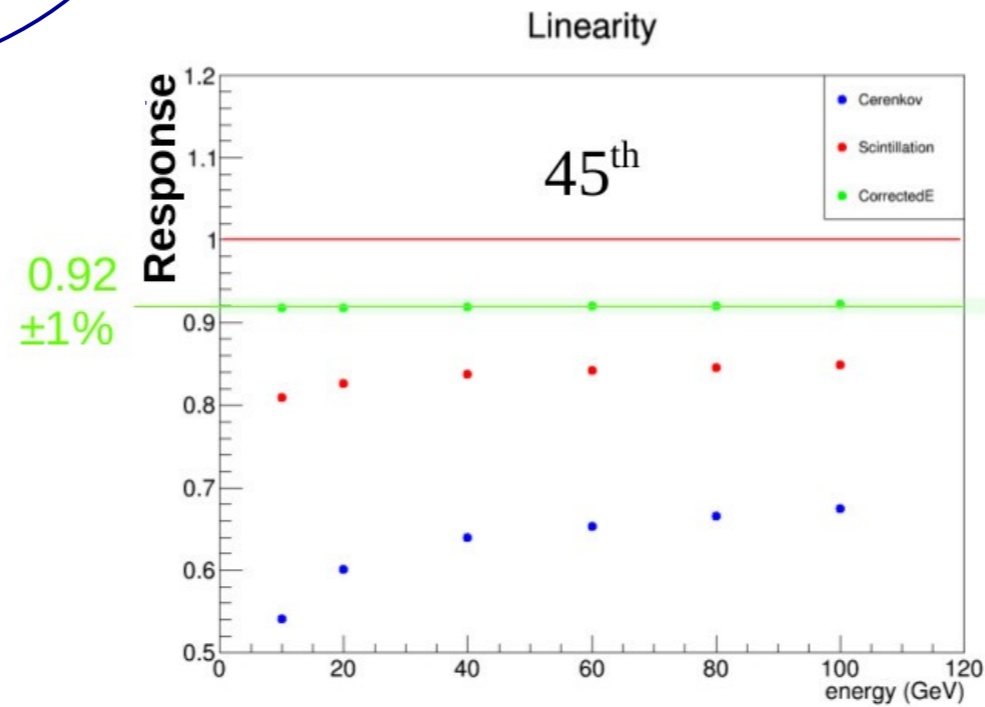
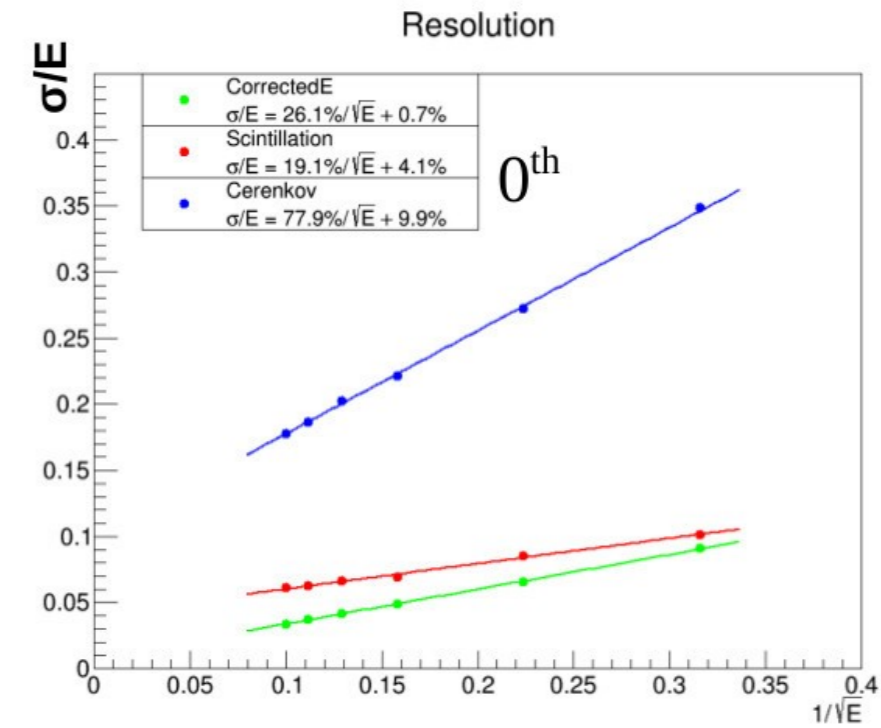
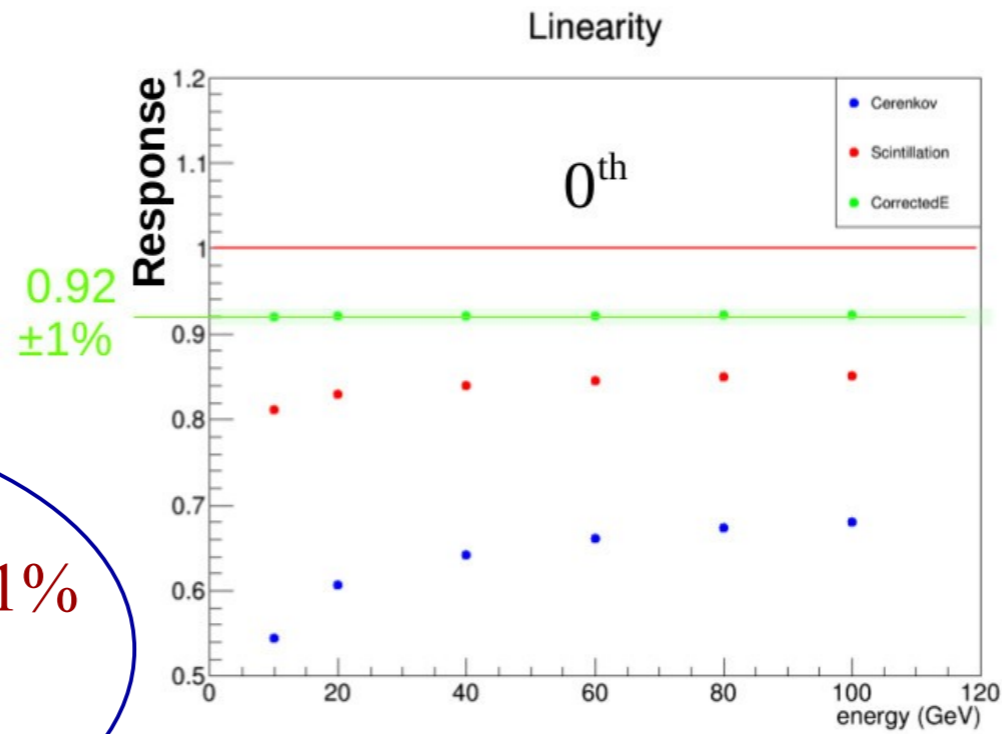

Longitudinal Segmentation & PFA

Last but not least:

addressing the issue of overlapping hadronic and em showers

→ Patrick Janot proposes longitudinal segmentation (and PF w/ DR)

□ **Without longitudinal segmentation, double readout calorimetry**

- ◆ **The (η, ϕ) views with EM and HAD energies are all mixed up**

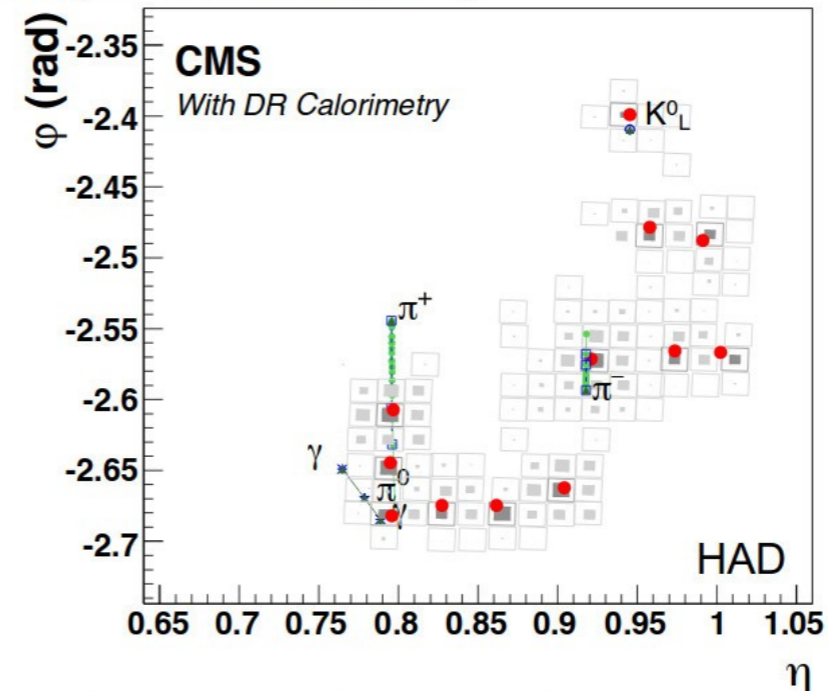
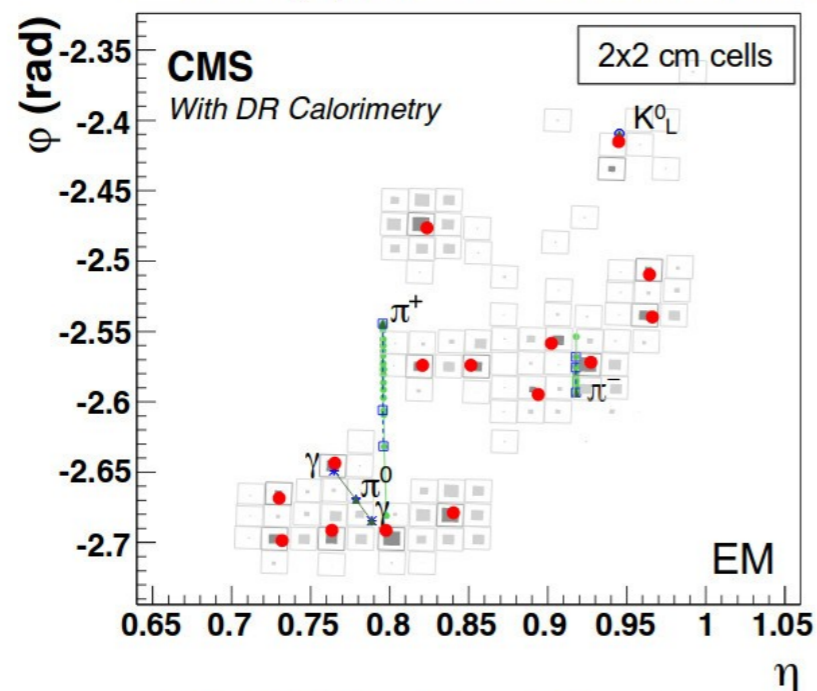

- ◆ **The EM fraction of the π^+ merges with the photons from the π^0**
 - **The HAD fraction of the π^+ prevents photons to be safely identified**
- ◆ **The EM fractions of the π^+ and π^- give rise to many EM clusters / HAD clusters**
 - **Particle-Flow picture is confused / confusing**

Put more (different length) fibres ?

- Requirement: keep the one-compartment design
 - ◆ But multiply the number of fibres by two, but the new ones are shorter by $1\lambda_1$

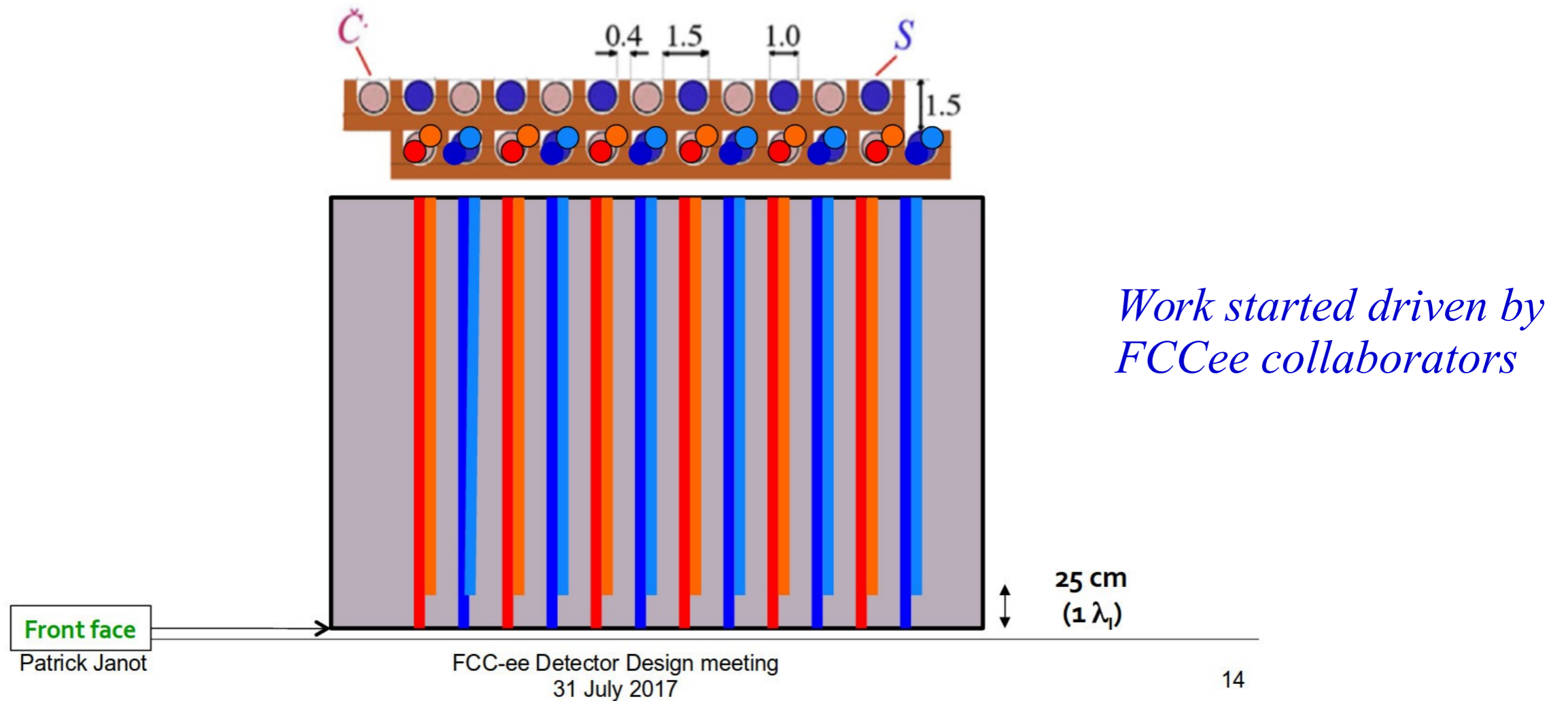

*Alternative approaches ? Measure time properties (ToT, PkT, Ti, Tf) ?
→ A real-time (feature-extraction) processor ?*

To be done ...

Preliminary results look interesting ... nevertheless many issues are still open/pending

a) G4 Simulations ... long list:

terminate Cu & Pb characterisation

impact of finite attenuation length

need/impact of longitudinal segmentation

jet ($\tau \rightarrow \text{had}$) em/had component separation

more realistic integrated 4π detector

physics performance (W, Z, H, ...)!

particle flow algorithms

+ (some) VALIDATION w/ RD52 lead prototype

b) 3-year R&D plan on mechanics, frontend electronics, readout:

develop a scalable solution made of $\sim 10 \times 10 \text{ cm}^2$ modules w/ 5000-10000 fibres, individually coupled to photo-detectors w/ data compression/reduction, feature-extraction processor (?), ...

Backup

Hadron Showers Development

Hadronic showers consist of two components:

- **Electromagnetic component**

- electrons, photons
- neutral pions $\rightarrow 2 \gamma$

- **Hadronic (non-em) component**

- charged hadrons π^\pm, K^\pm (20%)
- nuclear fragments, p (25%)
- neutrons, soft γ 's (15%)
- break-up of nuclei ("invisible") (40%)

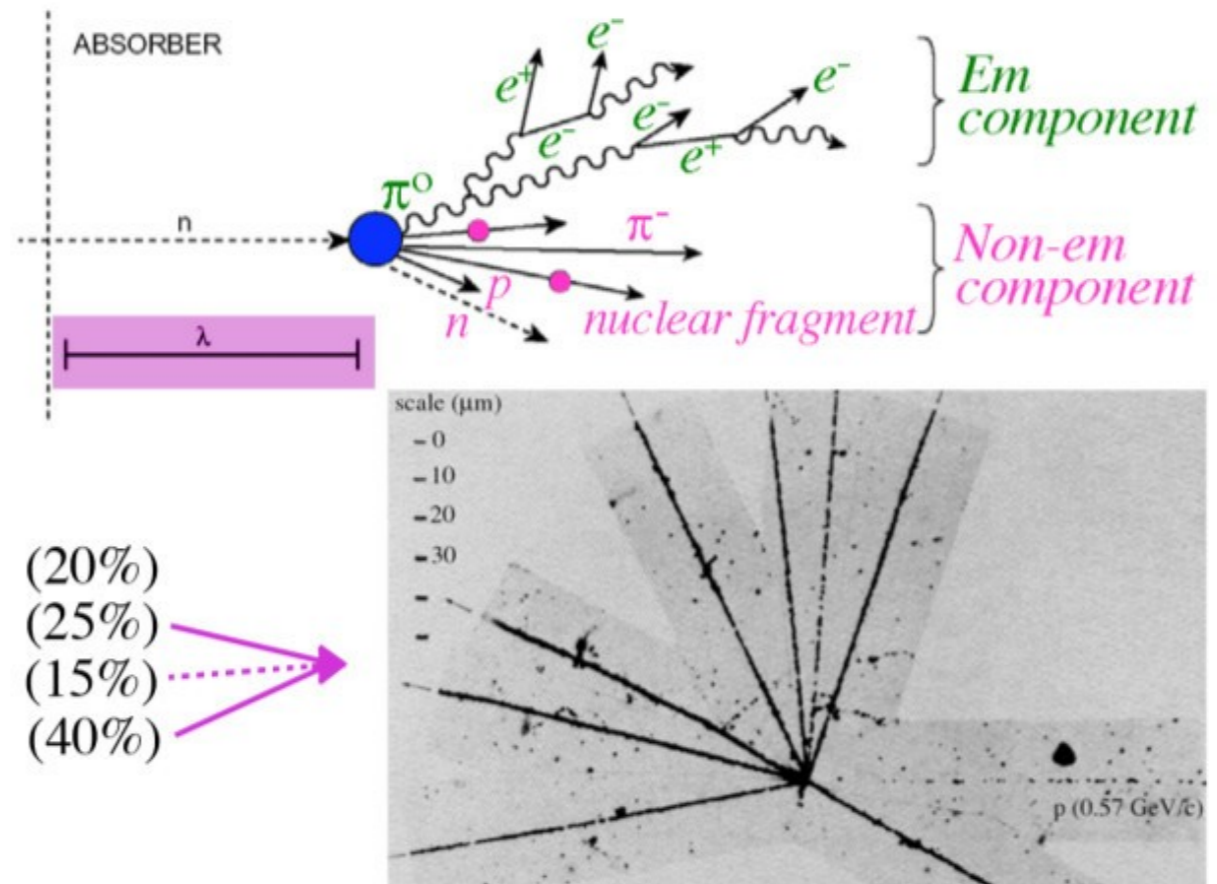

To be faced in hadronic energy measurements:

1. Large non-gaussian fluctuations in energy sharing em/non-em
2. Increase of em component with energy
3. Large, non-gaussian fluctuations in "invisible" energy losses

(Fluctuations in) the electromagnetic shower fraction, f_{em}

i.e. the fraction of the shower energy deposited by π^0 s

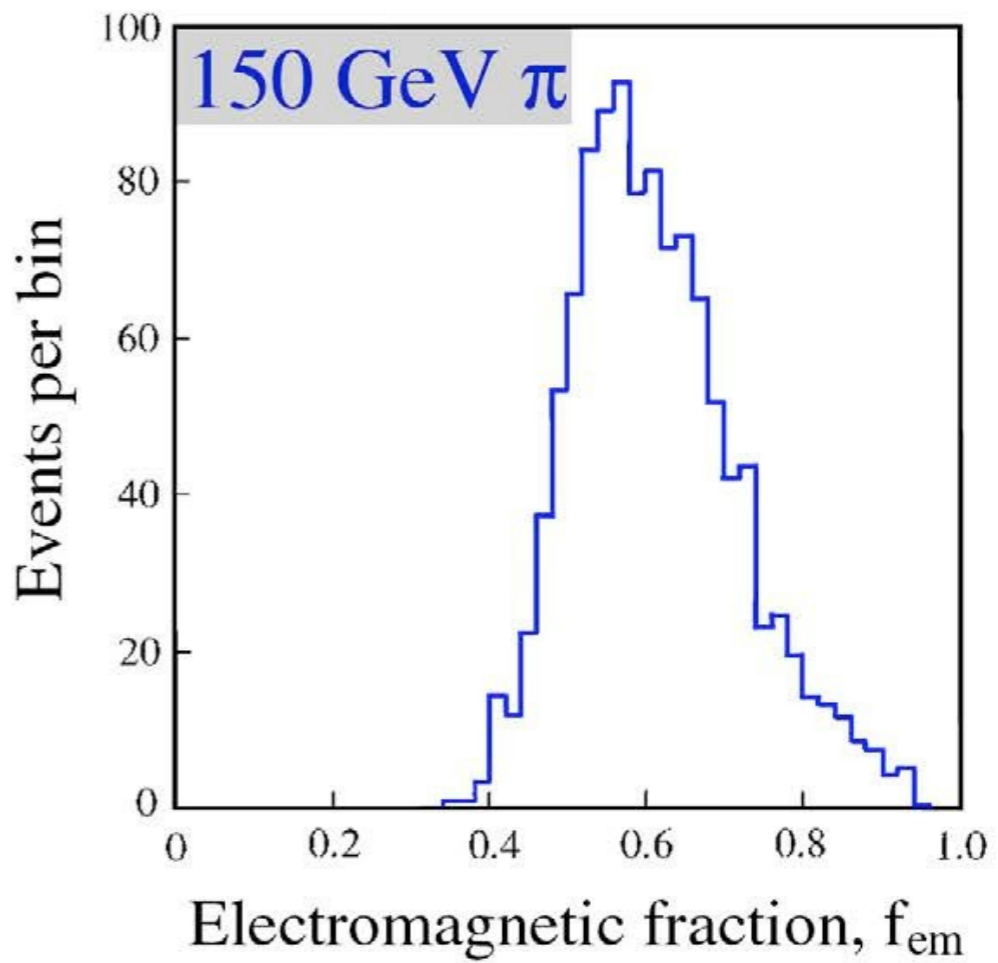
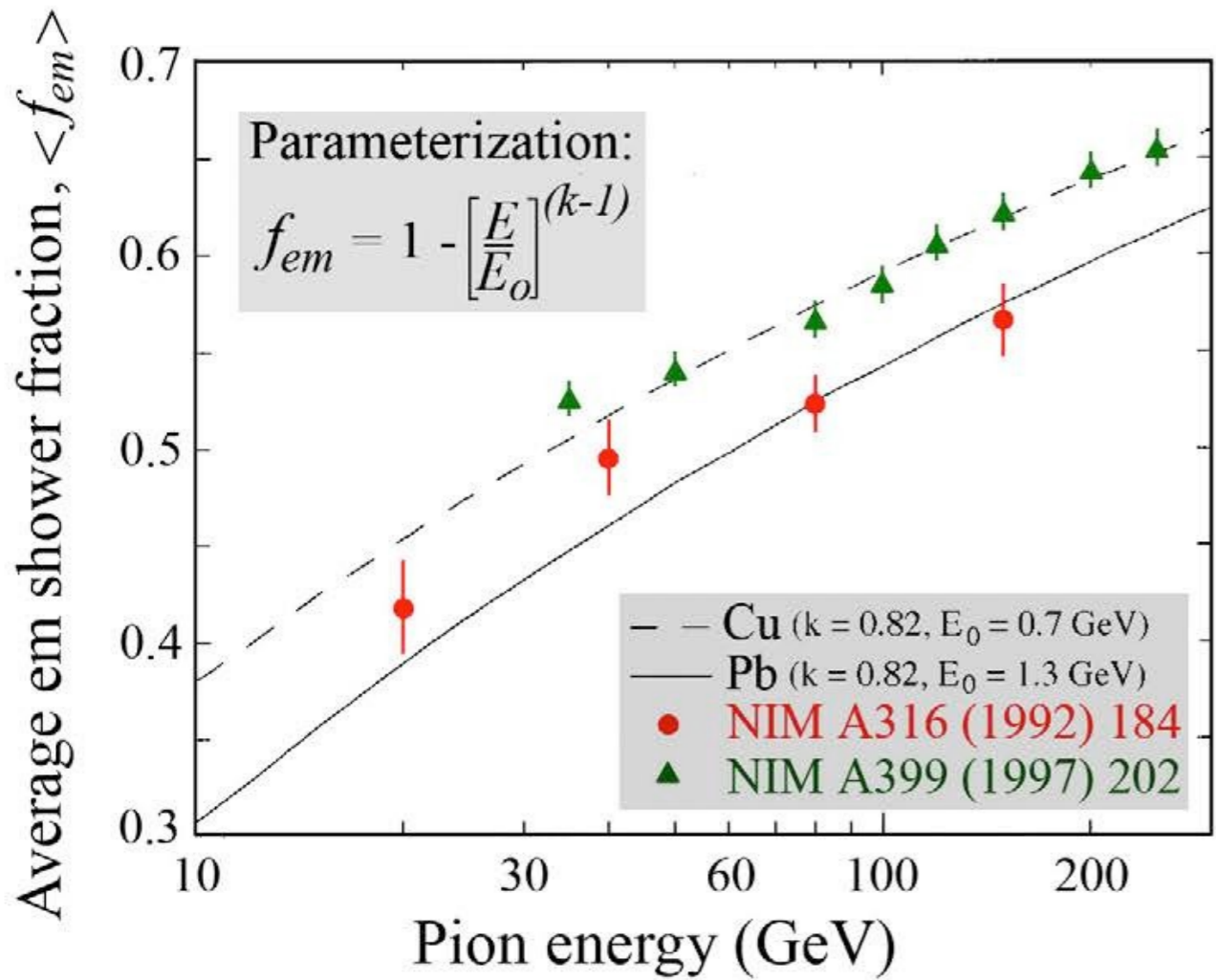

The em fraction is, on average, large and energy dependent

Fluctuations in f_{em} are large and non-Poissonian

Calorimeter Response to Hadron Showers

The detector response to the two components is **NOT** the same

This effect is quantified by the e/h ratio

In this example, only $1/1.8 \approx 56\%$ of non- π^0 energy is accounted in the signal

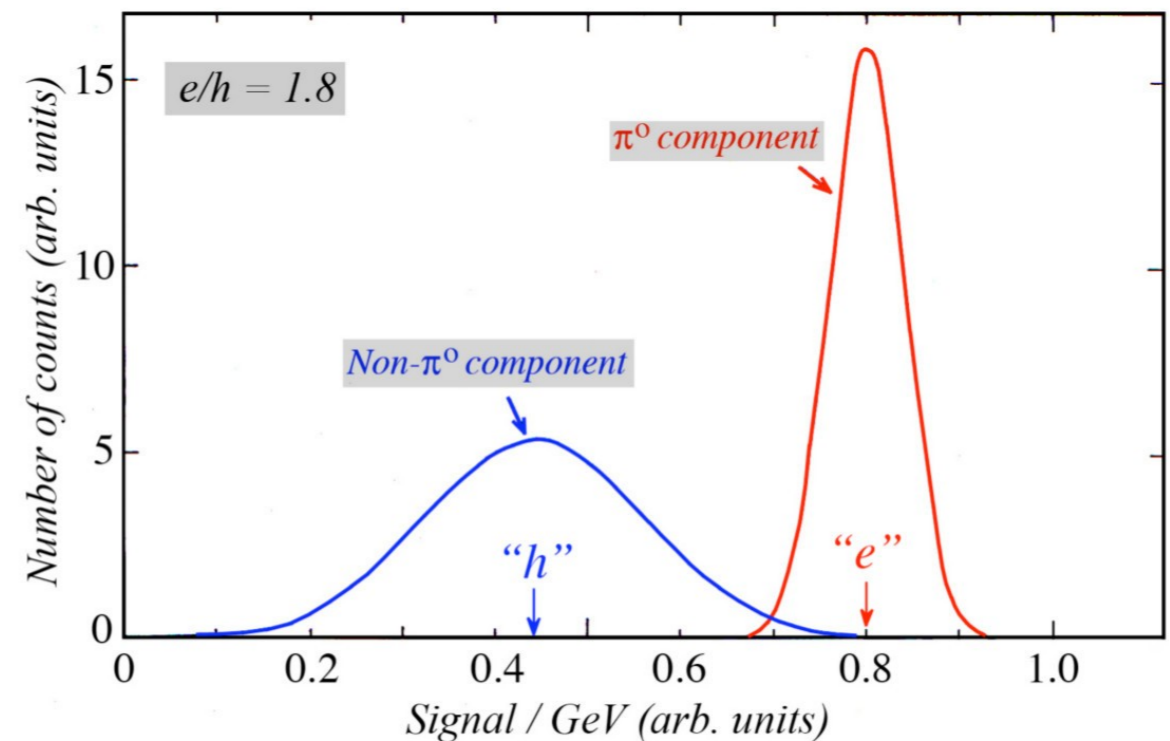

Take care:

The e/h ratio is a detector characteristic (typically, for crystals is ~ 2 , for sampling calorimeters is in range 1-1.8), nevertheless:

- 1) e/π depends on energy (f_{em} depends on E and shower "age")
- 2) f_{em} different for π , K , $p \rightarrow$ response depends of particle type

Dual-Readout Sampling Calorimetry

Don't spoil em resolution to get $e/h = 1$ (i.e. keep $e/h > 1$) *BUT* measure f_{em}
event-by-event

\Rightarrow *eliminate effects of fluctuations in f_{em} on calorimeter performance*

Exploit the fact that (e/h) values for a sampling calorimeter based on
scintillation light or Čerenkov light are (very) different
(*e.g. protons contribute to S but not to Č signals*)

DREAM: How to Determine f_{em} ?

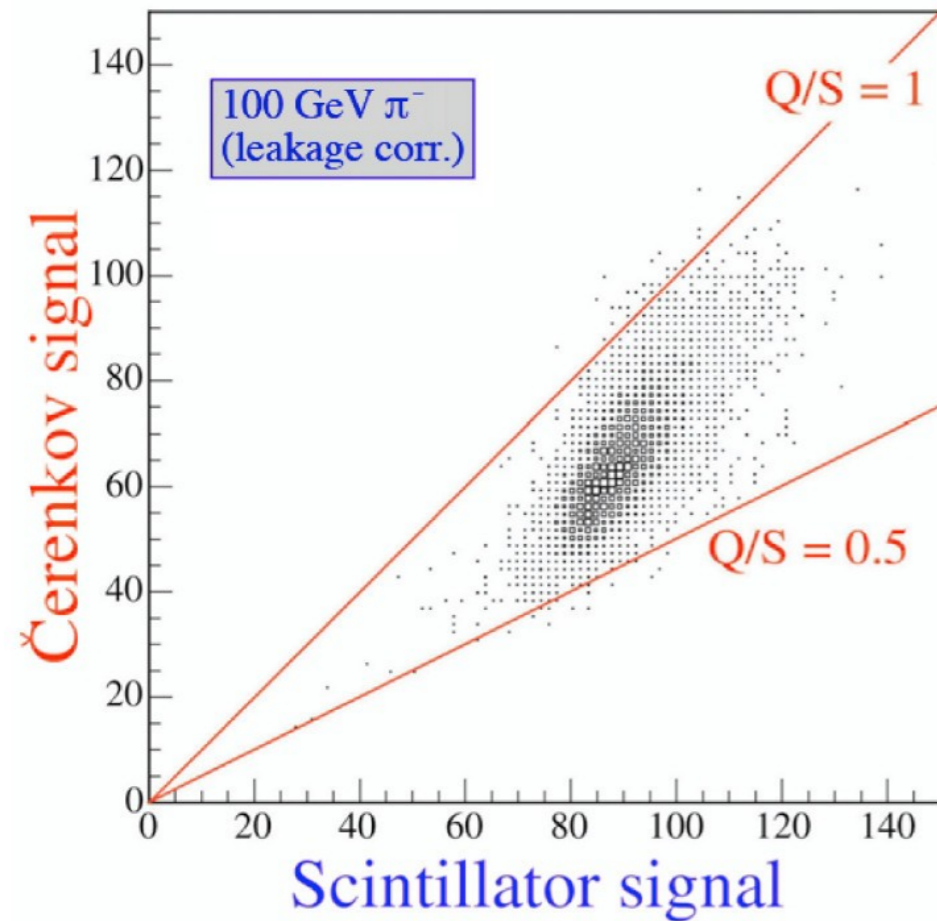

- $S = E \times [f_{em} + (h/e)_s \times (1 - f_{em})]$
- $C = E \times [f_{em} + (h/e)_c \times (1 - f_{em})]$
- e.g. if: $(e/h) = 1.3(S)$.vs. $4.7(C)$
- $\rightarrow S/C = (0.21 + 0.79 \times f_{em}) / (0.77 + 0.23 \times f_{em})$

- $S/E = (h/e)_s + f_{em} \times [1 - (h/e)_s]$
- $C/E = (h/e)_c + f_{em} \times [1 - (h/e)_c]$

Hadronic data points (S, C) are located on a straight (red) line

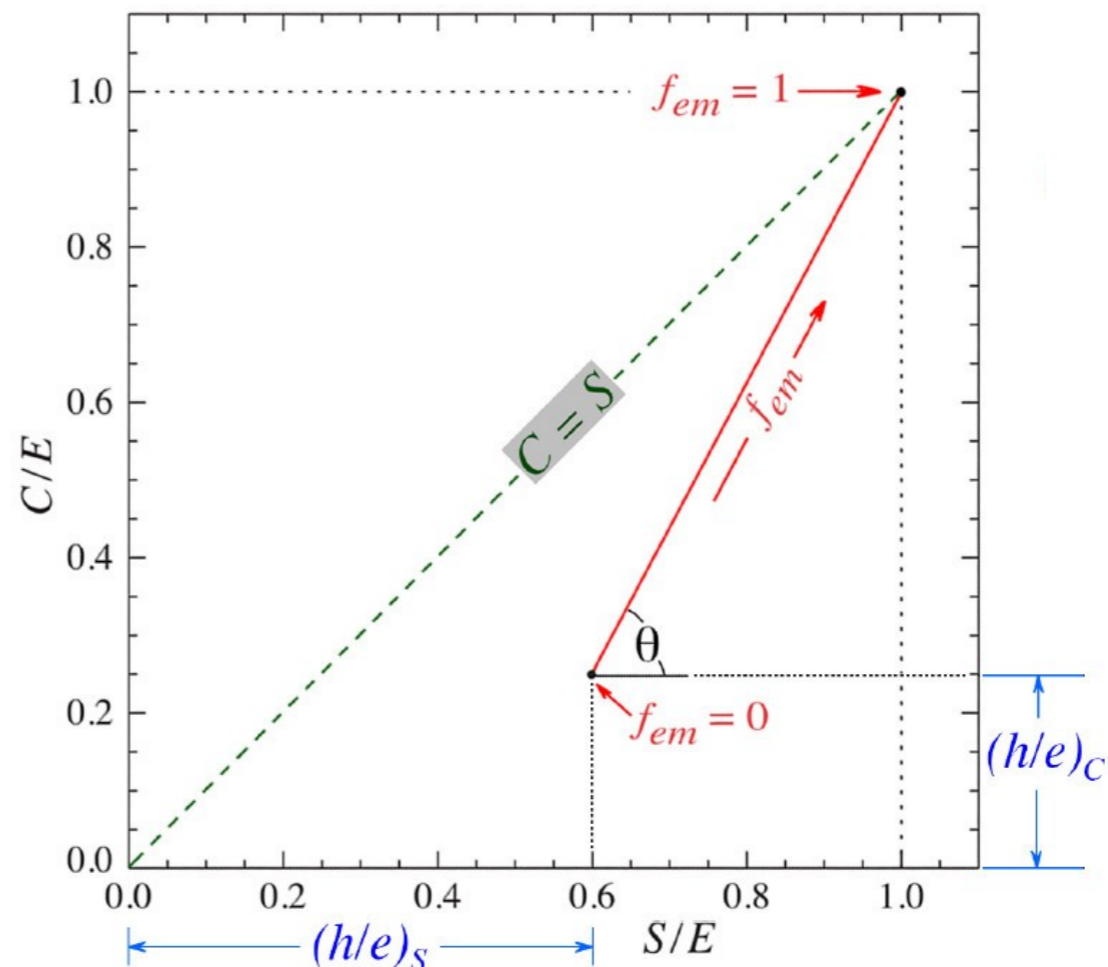

The Alchemy

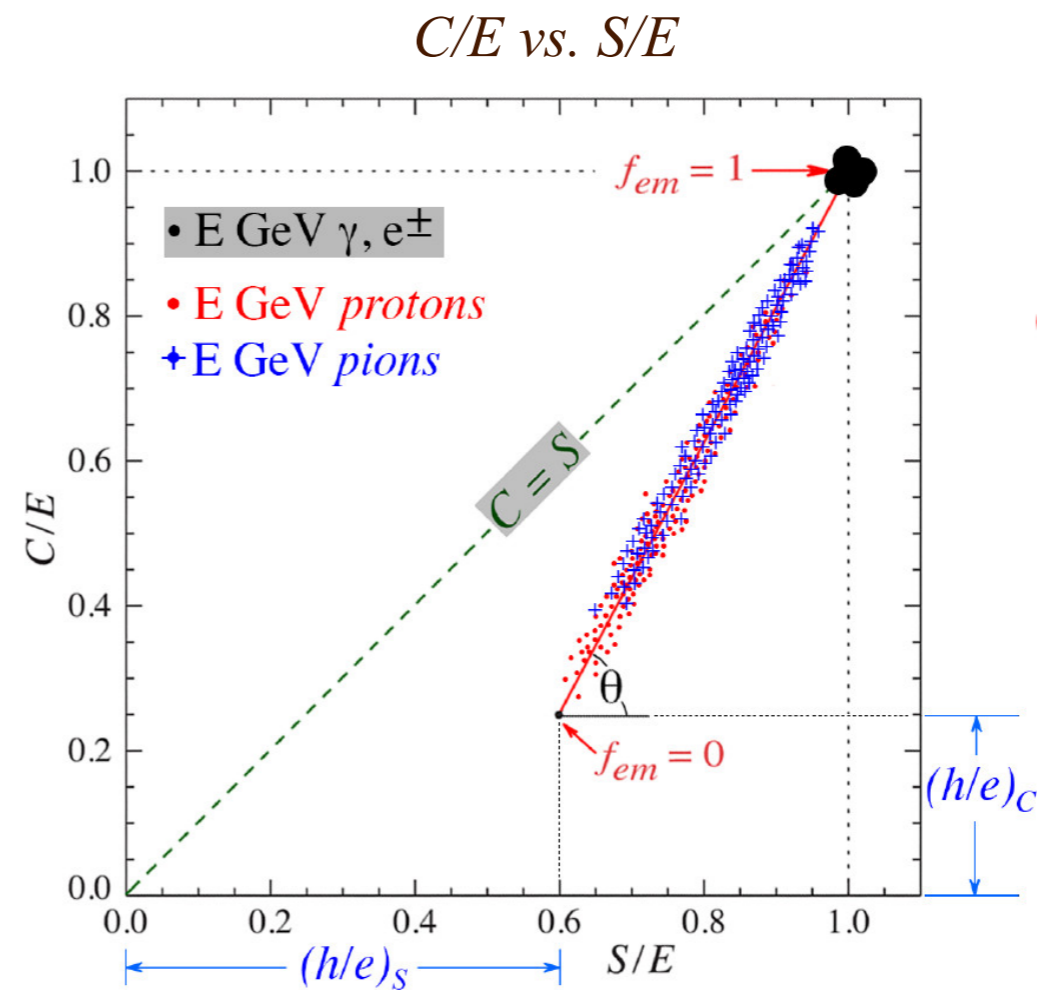
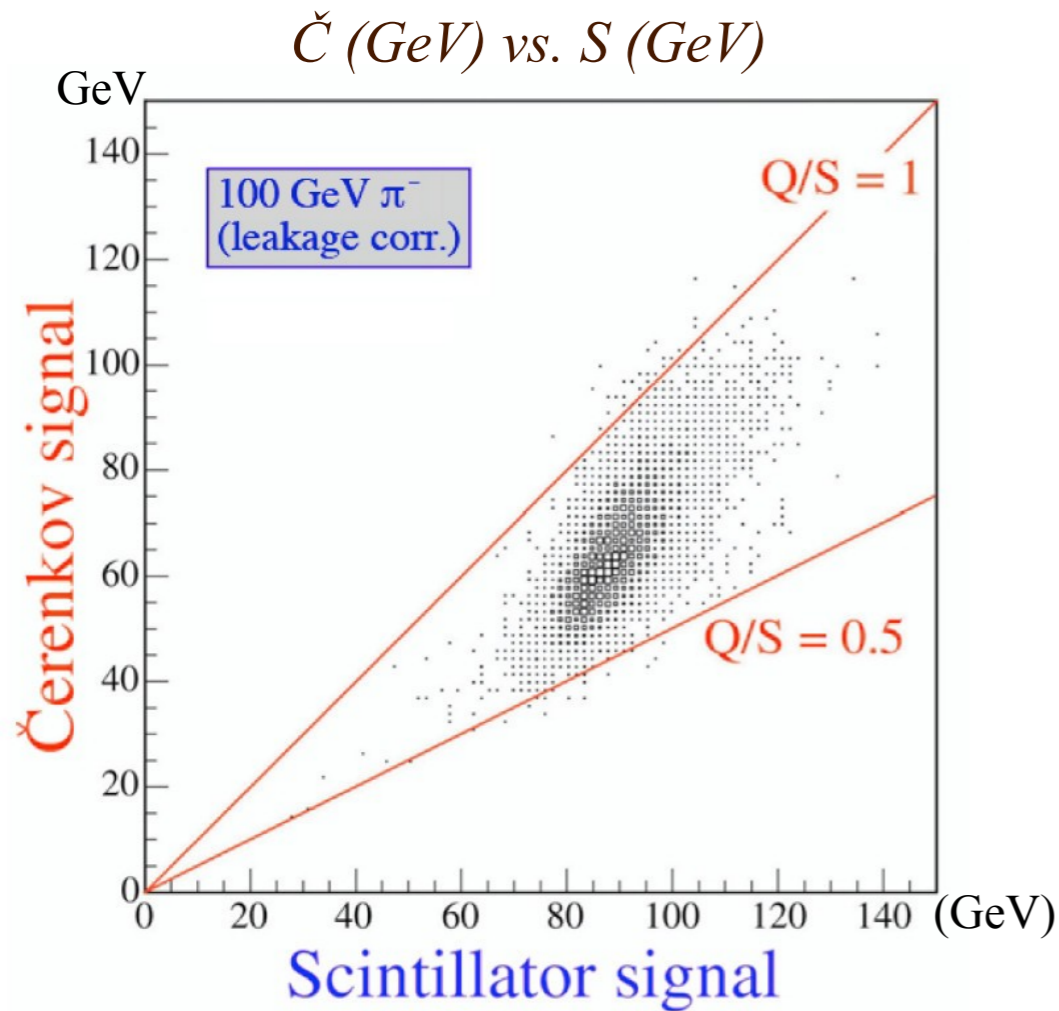

Hadronic data points (S, C) located around straight lines

$$E = \frac{S - \chi C}{1 - \chi}$$

is universally valid

$$\cotg \theta = \frac{1 - (h/e)_s}{1 - (h/e)_c} = \chi$$

θ, χ independent of both:

i) energy (!)

ii) type of hadron (!!)

Dual Readout at Work (1)

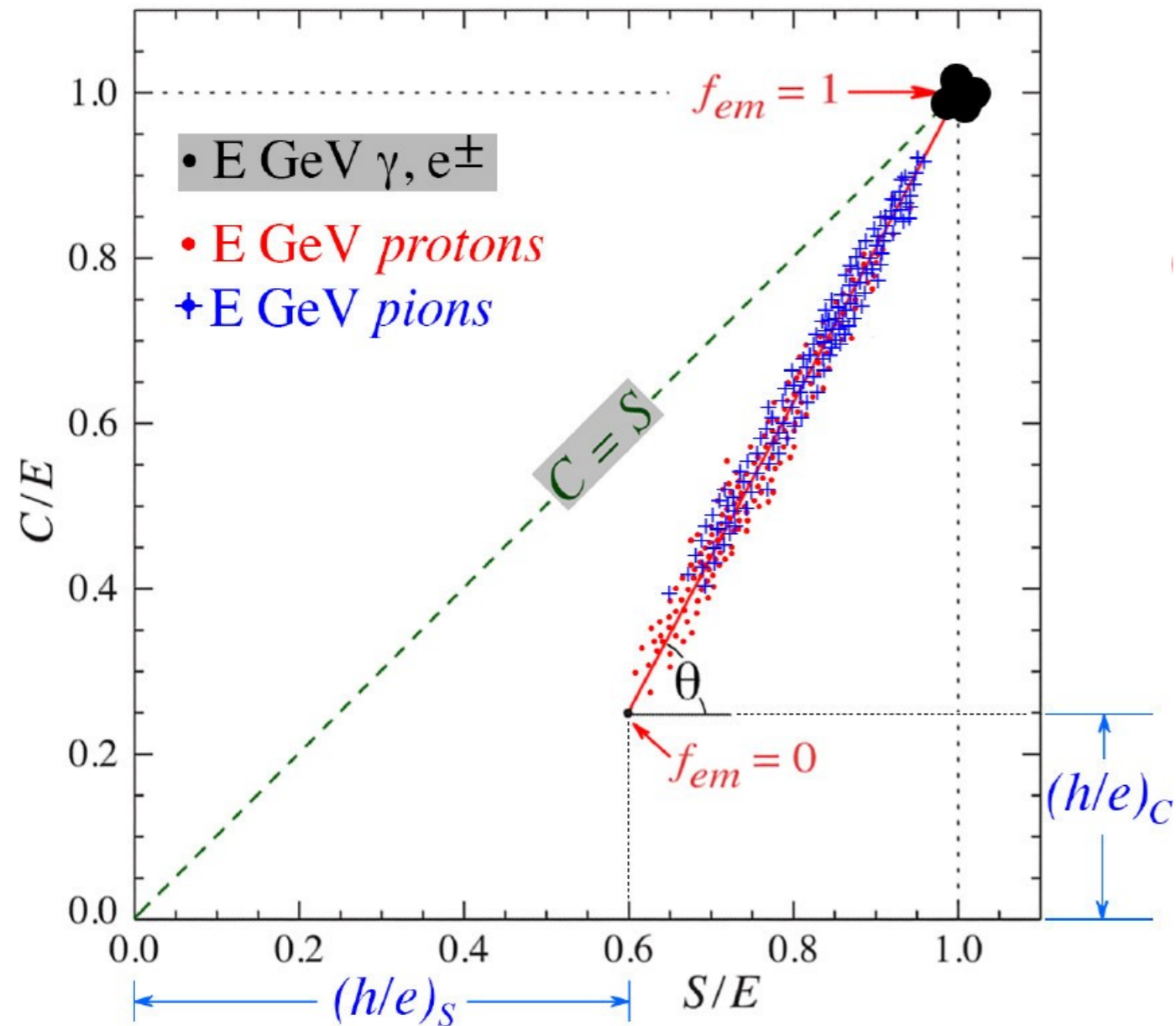

$$\cotg \theta = \frac{1 - (h/e)_s}{1 - (h/e)_c} = \chi$$

- Θ, χ independent of both:
 - *i) energy (!)*
 - *ii) type of hadron (!!)*

$$E = \frac{S - \chi C}{1 - \chi}$$

is universally valid

Dual Readout at Work (2)

Effects of the dual-readout method

Signal linearity

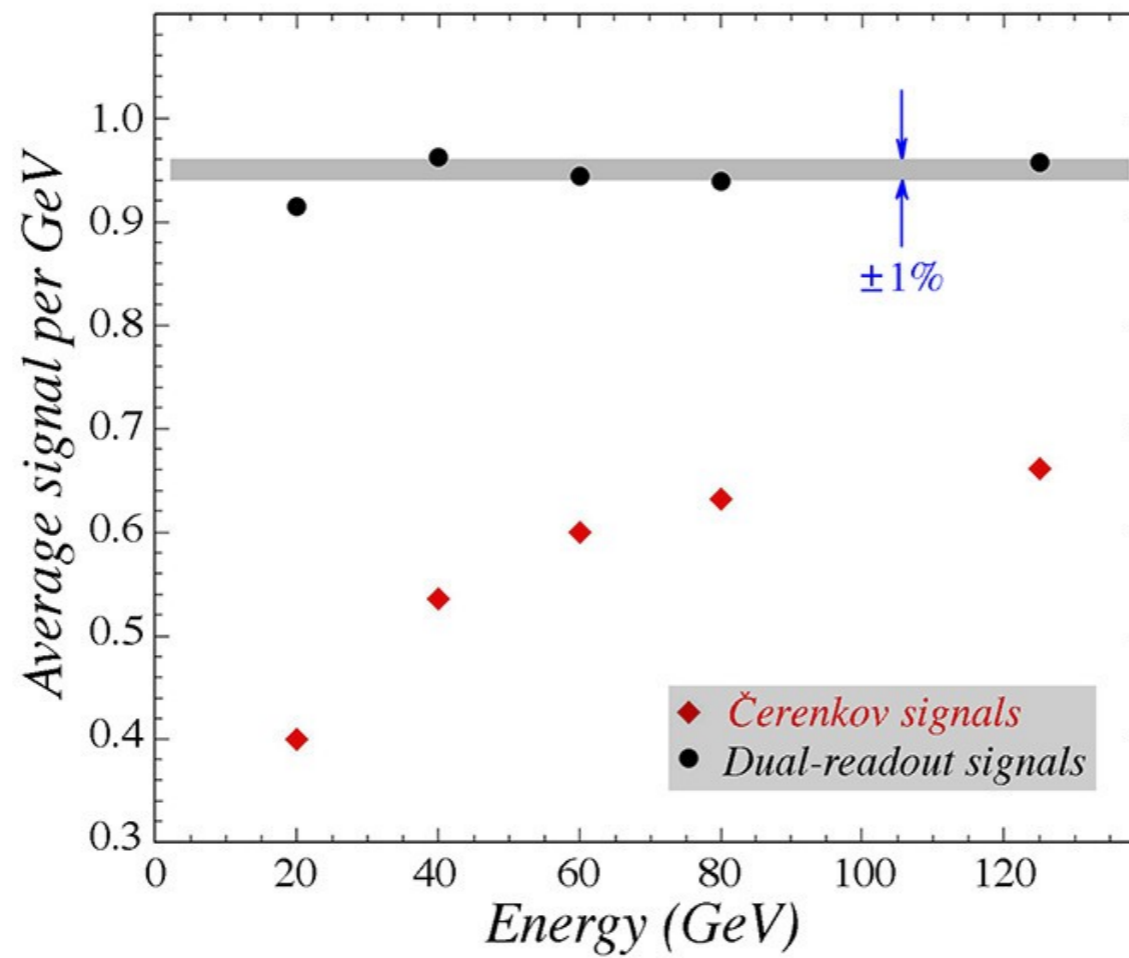

Dual Readout at Work (3)

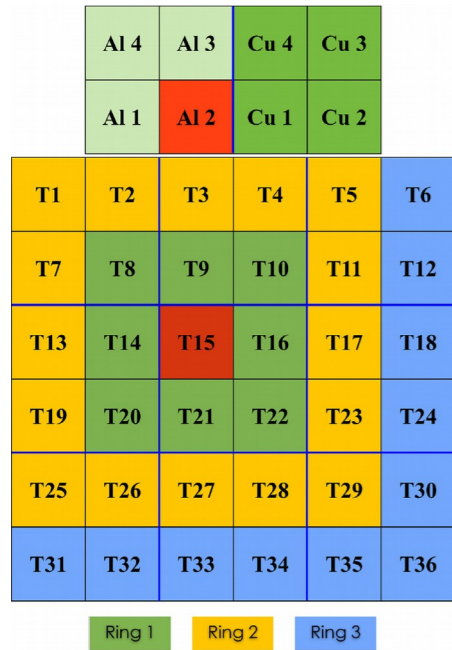

NIM A 866 (2017) 76

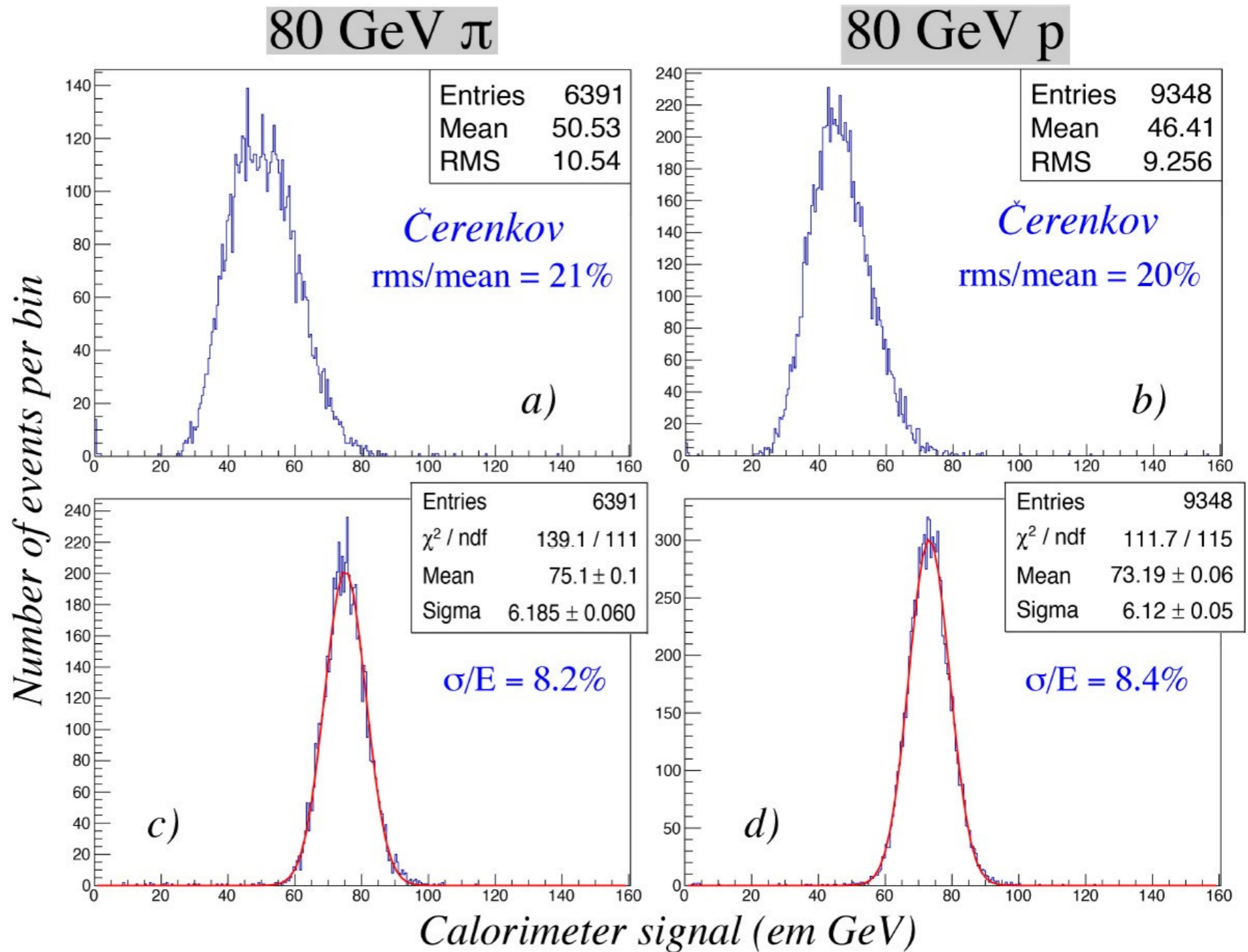

RD52 DR Fibre Calorimeters

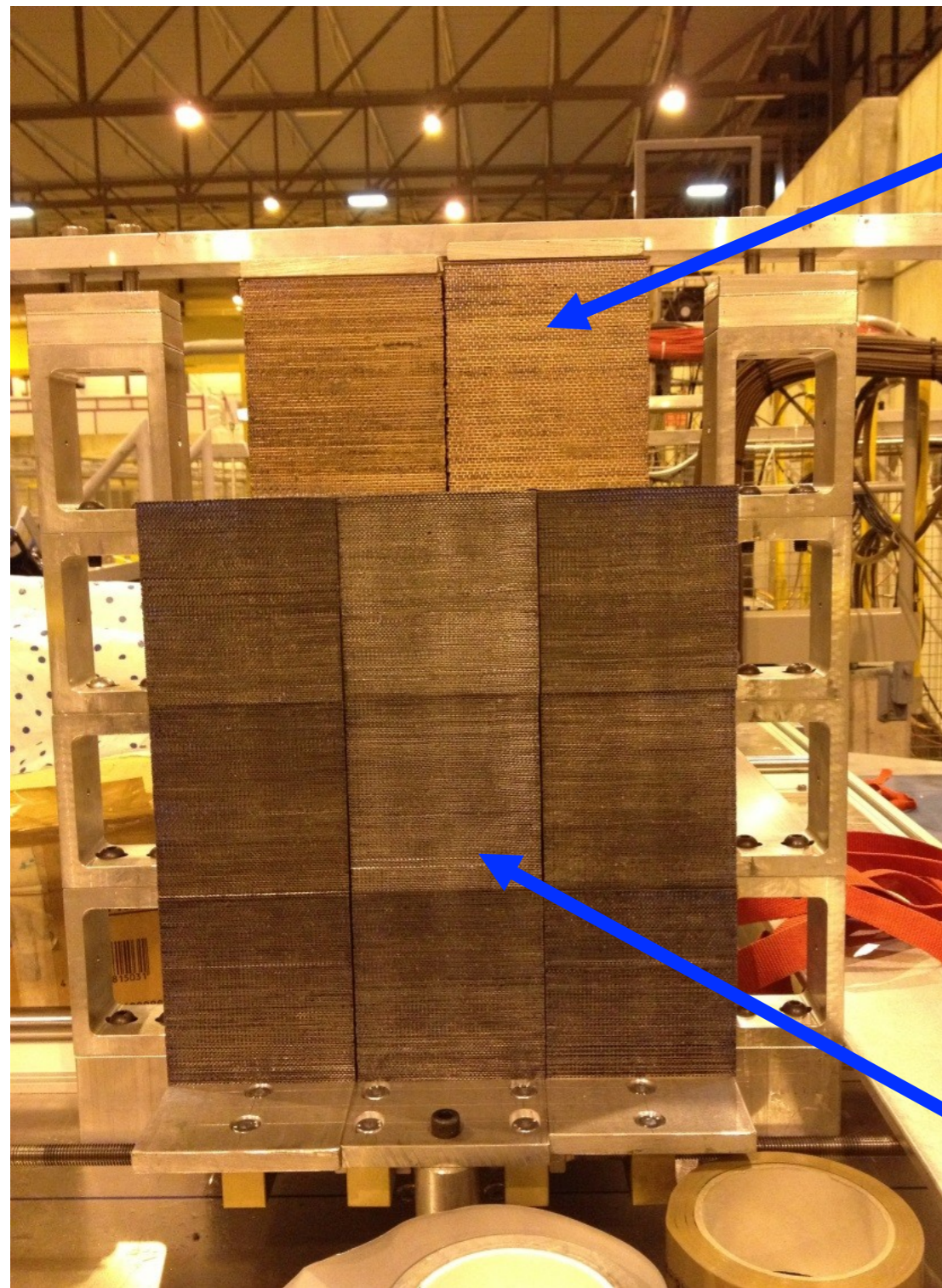

2 Cu modules



Pb 3*3 matrix

Dual Readout w/ Fibre Sampling Calorimeters

2003
DREAM

Cu: 19 towers, 2 PMT each
2m long, 16.2 cm wide
Sampling fraction: 2%

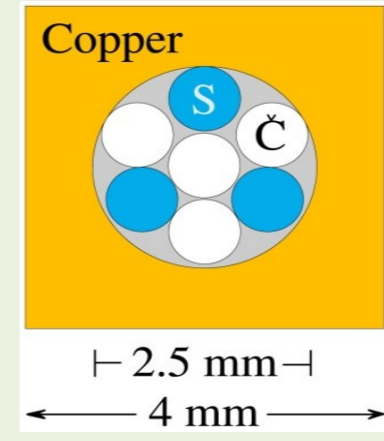

2012
RD52

Cu, 2 modules
Each module: $9.2 \times 9.2 \times 250 \text{ cm}^3$
Fibers: 1024 S + 1024 C, 8 PMT
Sampling fraction: ~4.6%
Depth: $\sim 10 \lambda_{\text{int}}$

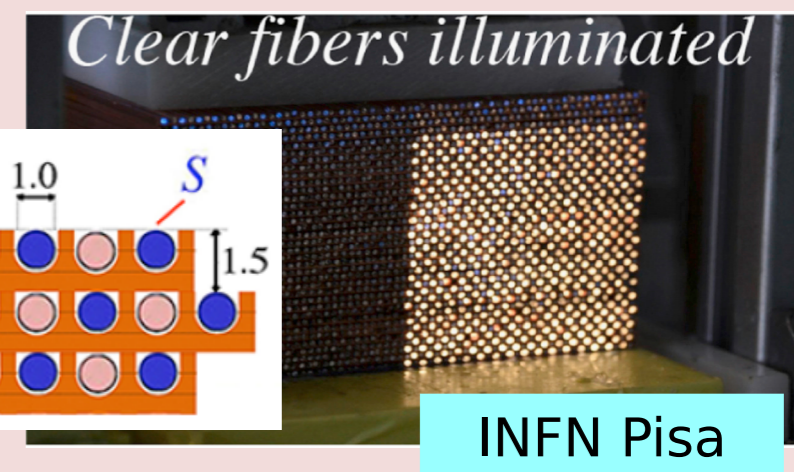
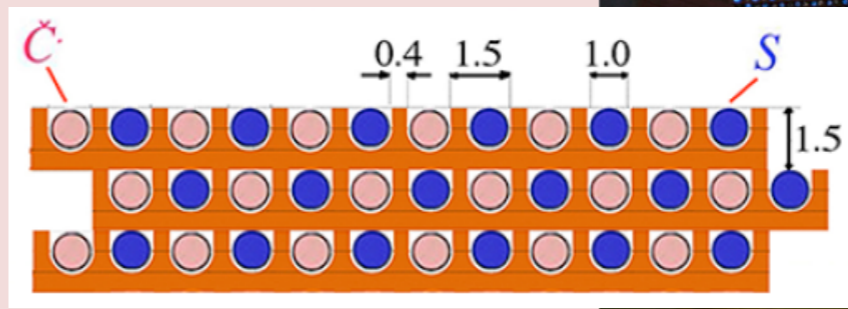

2012
RD52

Pb, 9 modules
Each module: $9.2 \times 9.2 \times 250 \text{ cm}^3$
Fibers: 1024 S + 1024 C, 8 PMT
Sampling fraction: ~5.3%
Depth: $\sim 10 \lambda_{\text{int}}$

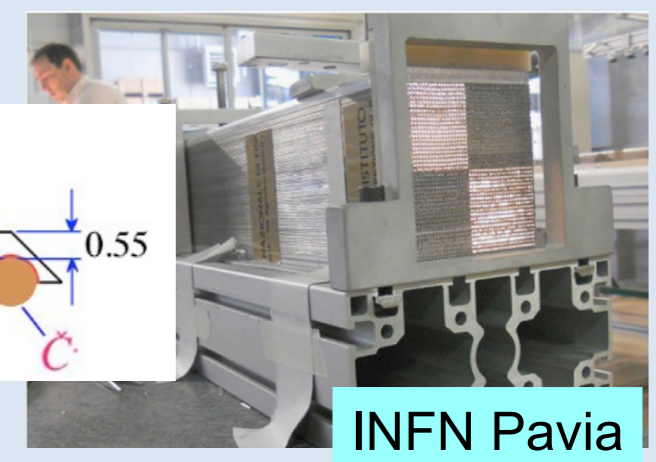
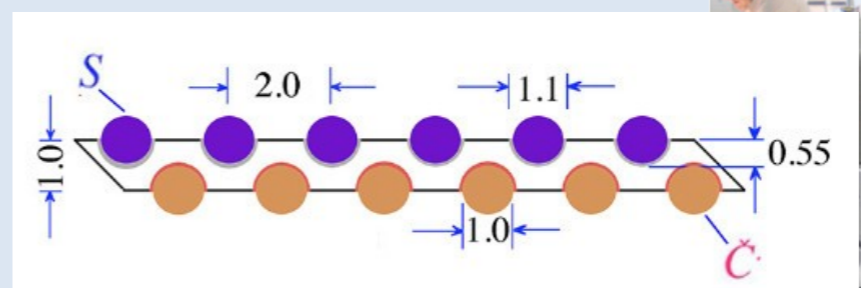

Lateral shower profile

RD52 lead calorimeter

100 GeV e^-

$\theta, \Phi = 0^\circ$

NIM A 735 (2014) 130

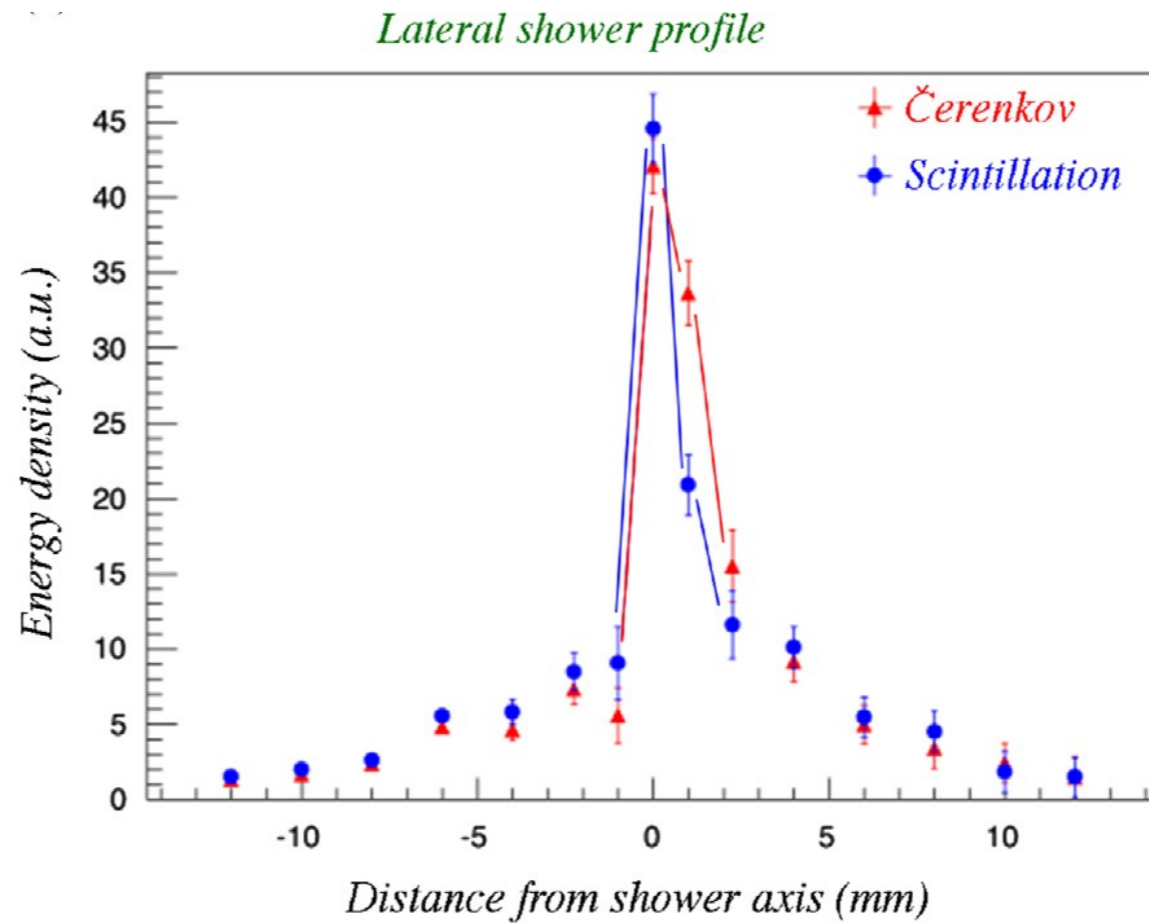

em shower are very narrow

→ fibre readout can easily provide (powerful) input to PFA

RD52 SiPM Readout

The very first SiPM test of a DR calorimeter (10/2016)

8 x 8 array of 1 mm² Hamamatsu SiPMs, 50 μm pixels (400/SiPM)

1 fiber per SiPM

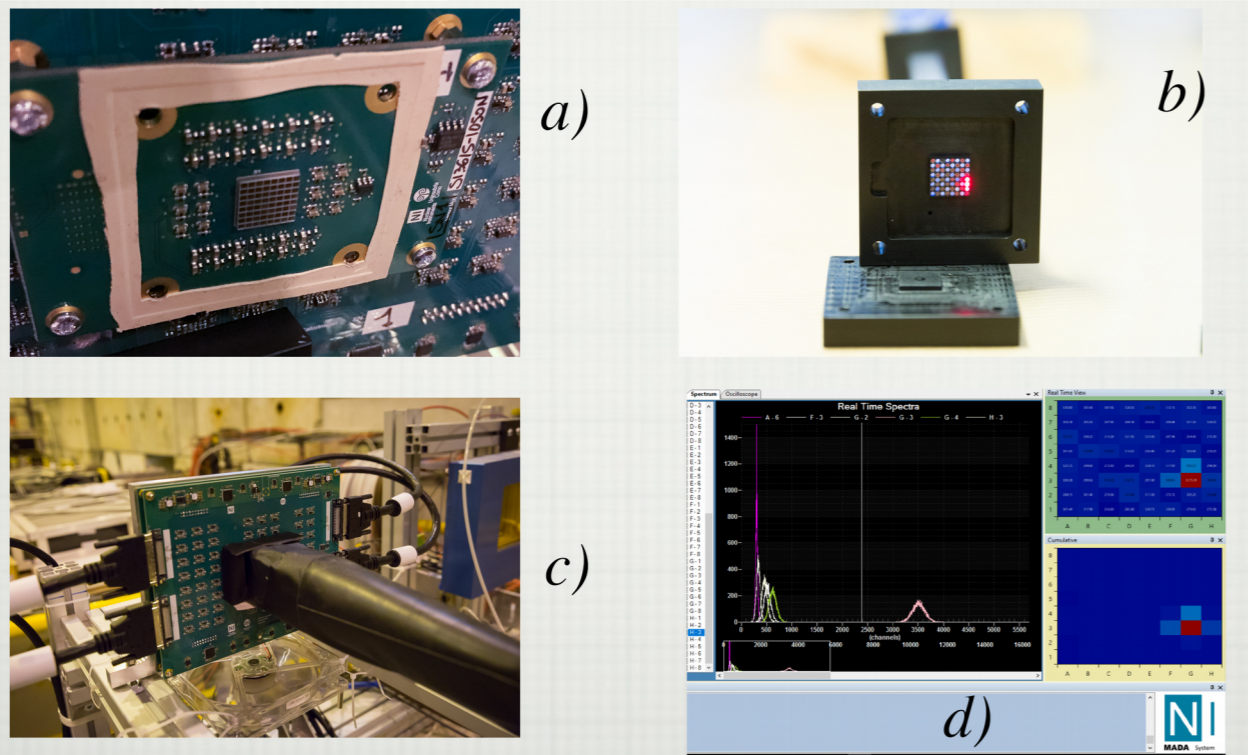

MODULE 1: All channels equipped (32 scintillating + 32 Čerenkov fibers)

MODULE 2: Only Čerenkov fibers connected (32)

2016

a) 400 cells

b) 40% PDE

limitations:

- dynamic range saturation

- cross-talk (light leakage)

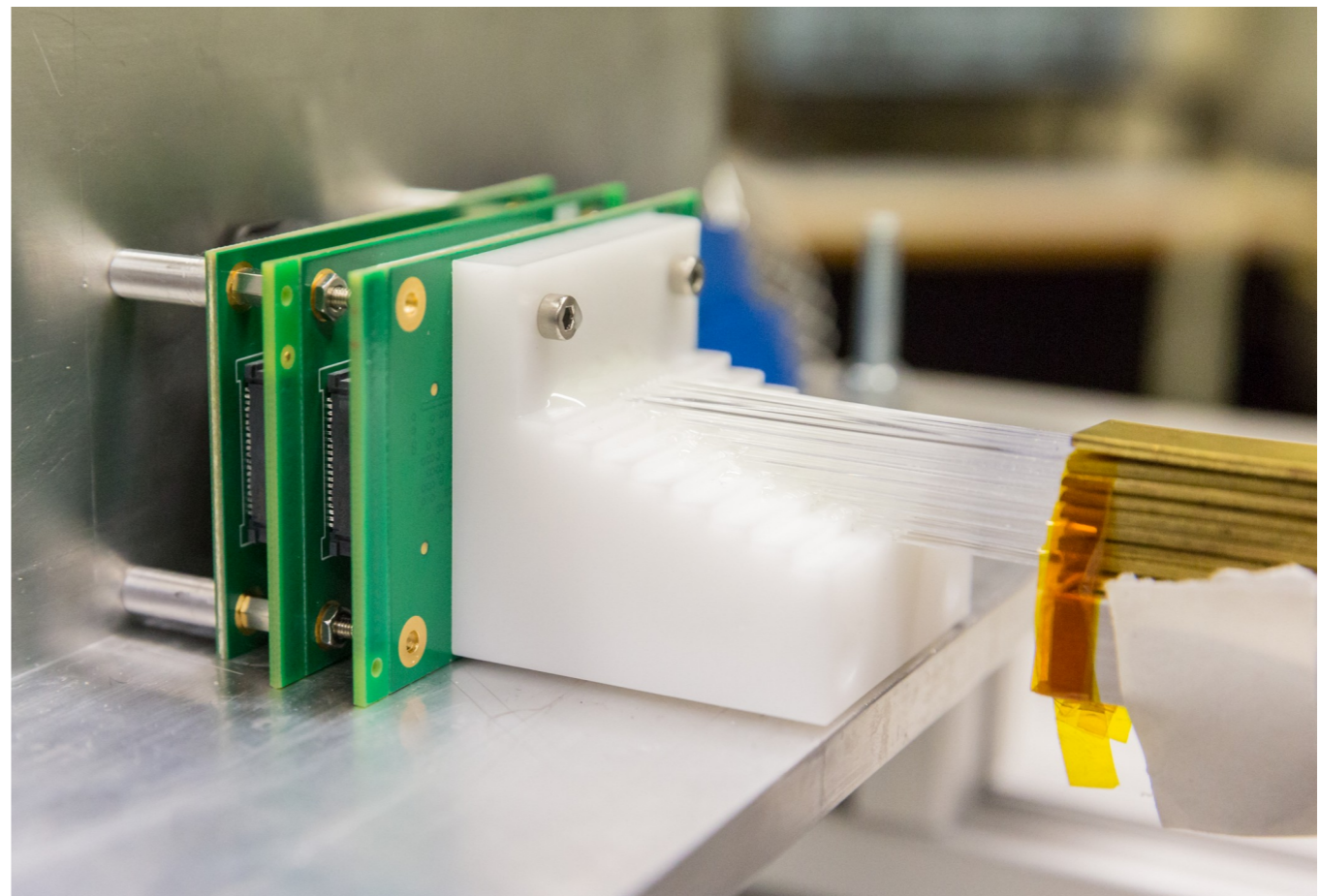

2017

a) 4 x dynamic range (1600 cells)

b) 25% PDE

c) photo-detection at 2 different levels

Testbeam - data selection and tagging

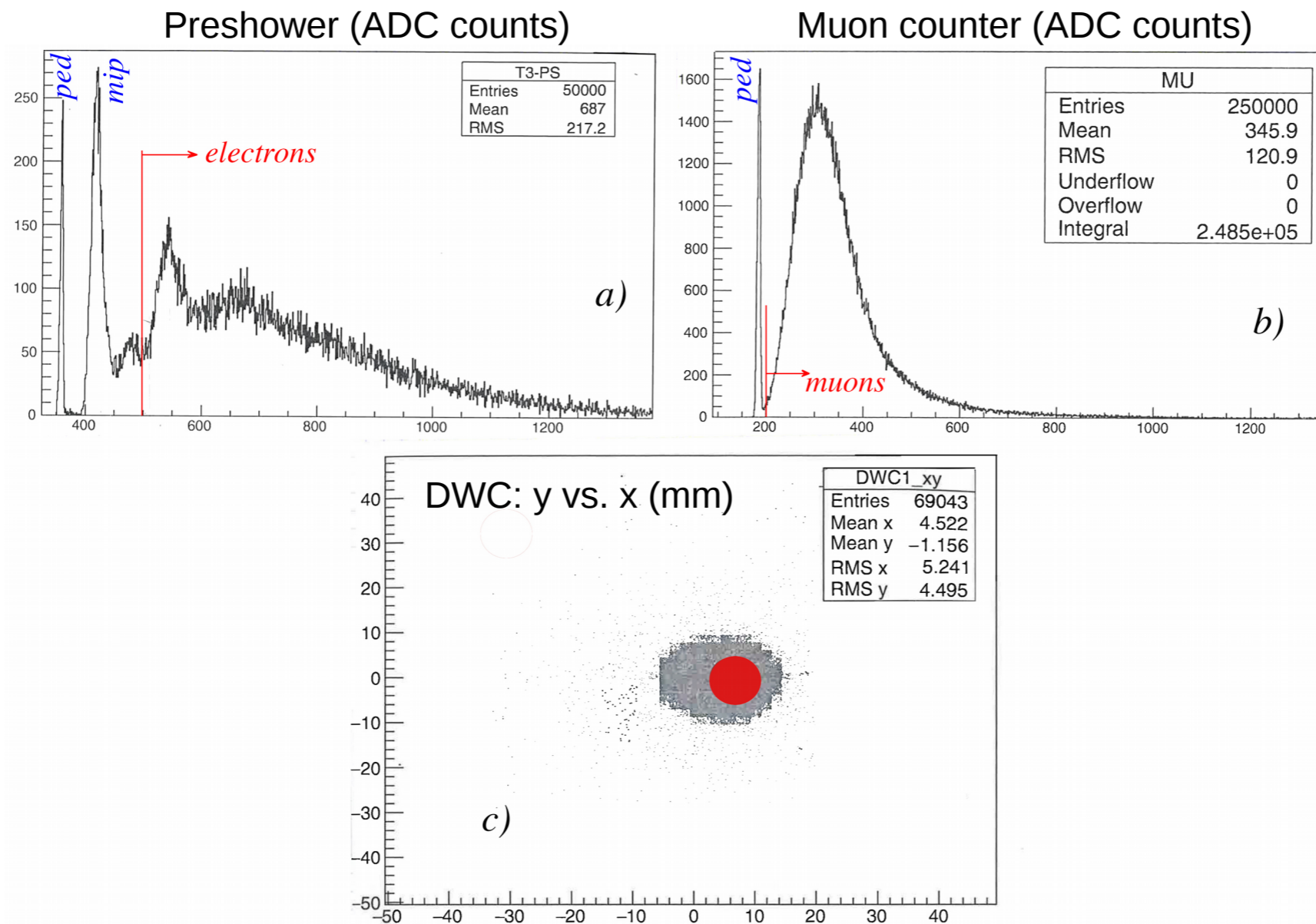

Preshower detector and muon counter: select electrons or muons

Delay Wire Chamber: select events in central region

RD52 Preliminary Results (2017)

64 Hamamatsu SiPM
1x1 mm²
25x25 μm² cell
1600 cells
nominal detection efficiency 25%

50 GeV electron beam

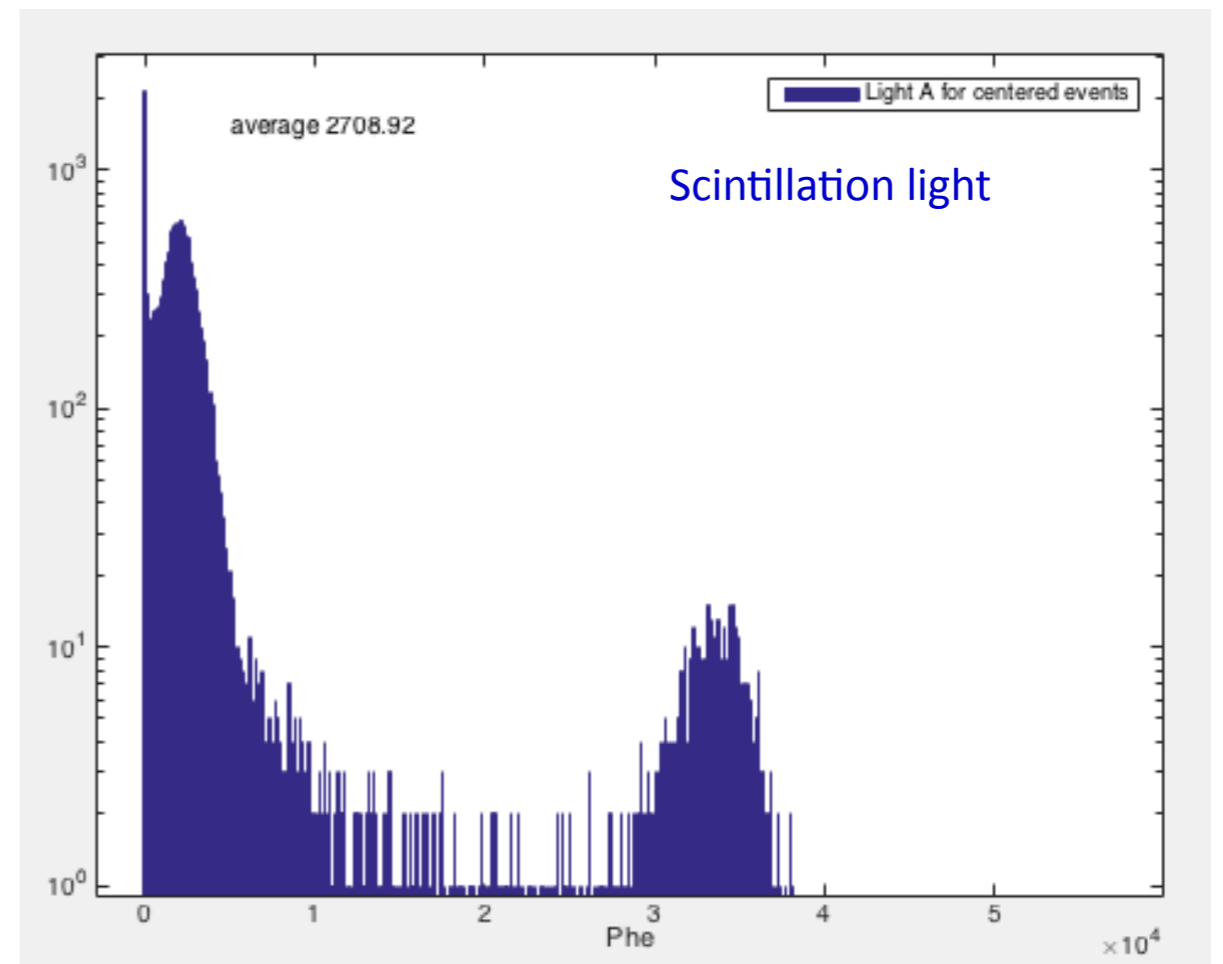
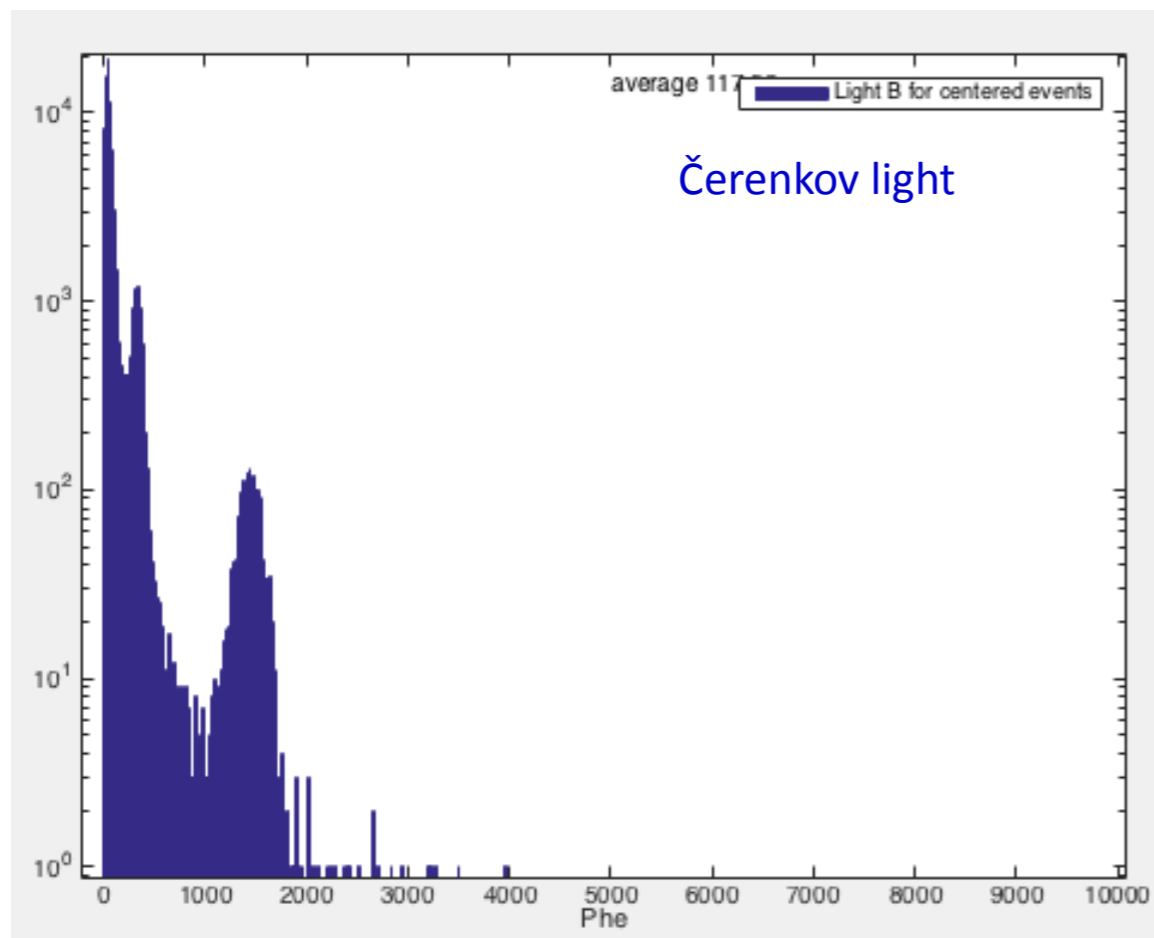

Preliminary Results (2017) – Scintillation Signals

*Number of p.e. / GeV in all
fibres but hottest*

*Number of p.e. / GeV in
hottest*

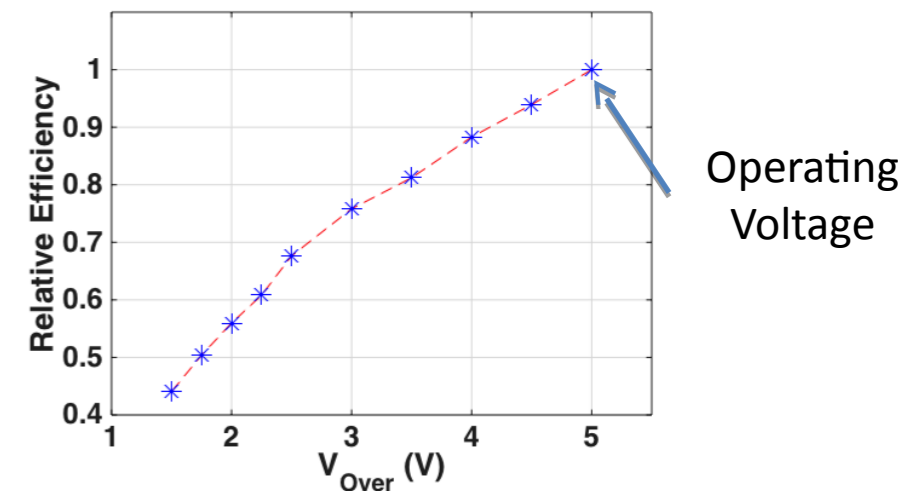
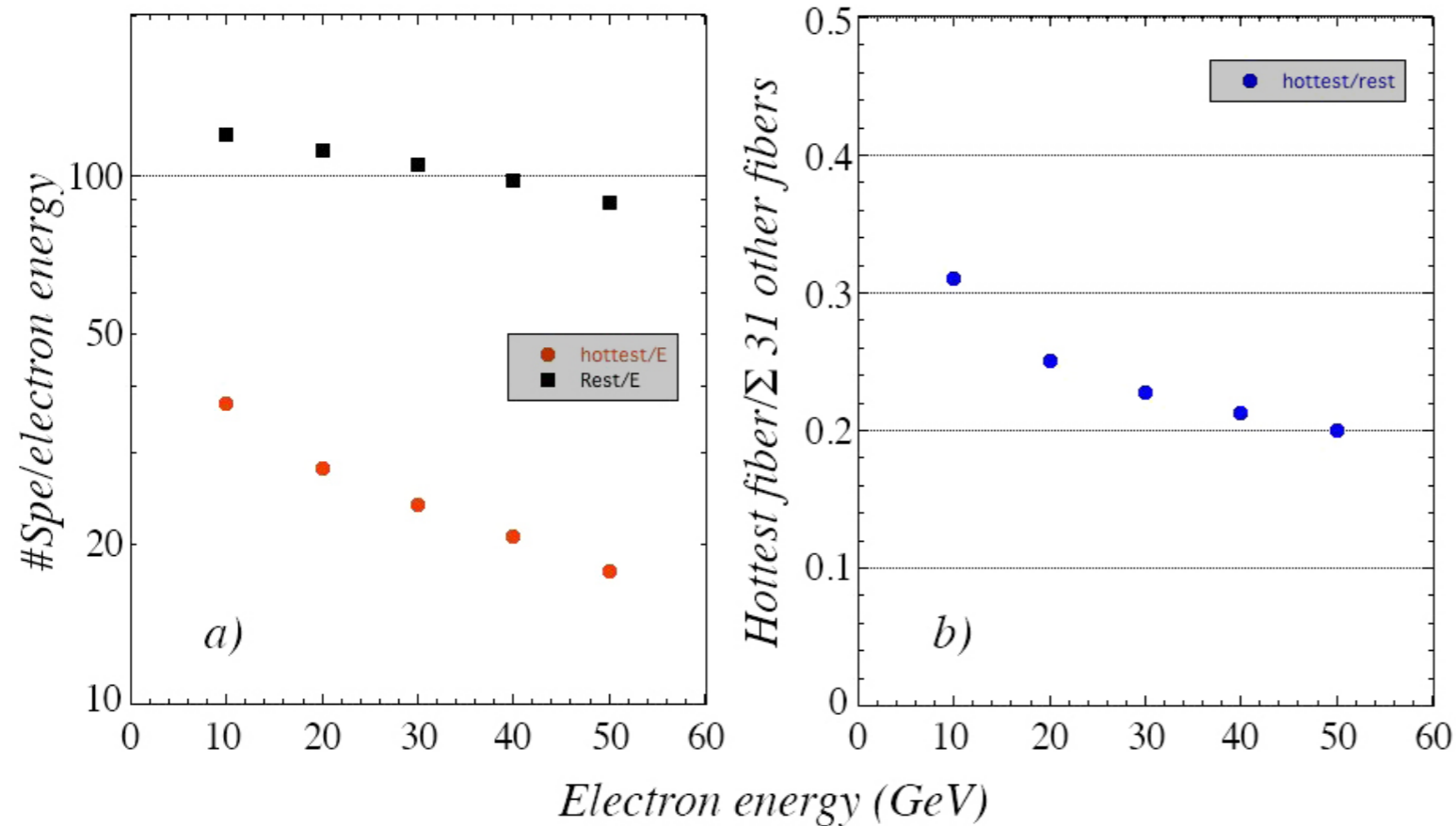

***** Take care: bias voltage lowered by 5 V \rightarrow PDE very low! *****

Preliminary Results (2017) – Čerenkov Signals

p.e. per GeV .vs. Beam Energy

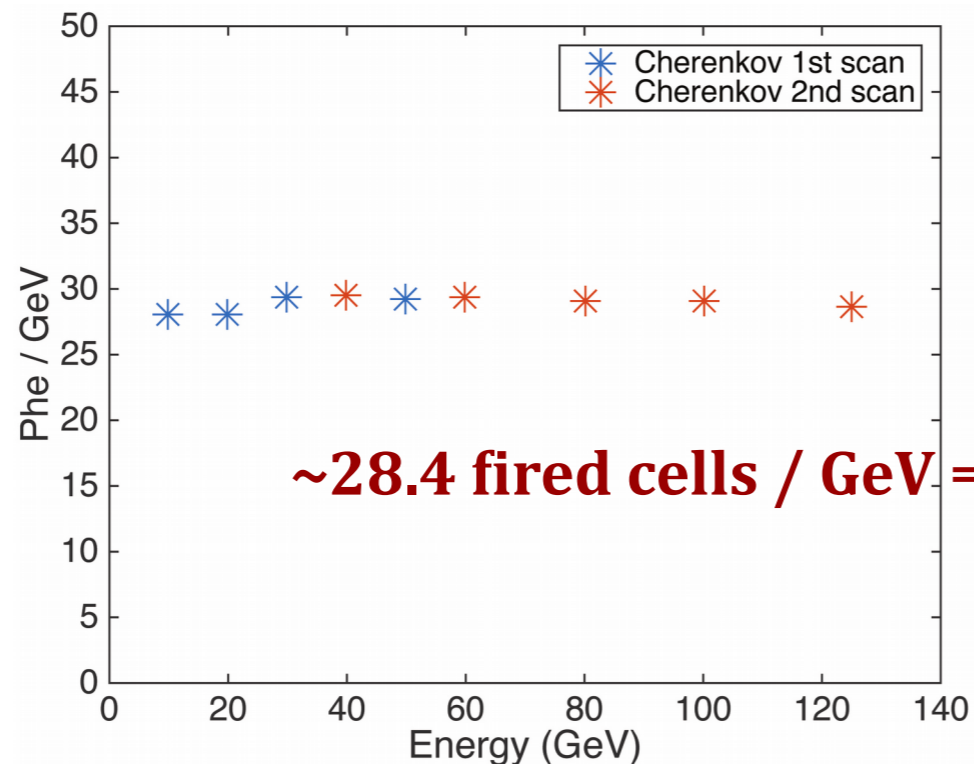

~28.4 fired cells / GeV \Rightarrow ~70 p.e. / GeV (full containment)

→ no saturation in Čerenkov signals

→ average shower containment independent of energy

RD52 preliminary results (2017)

125 GeV Muon signals

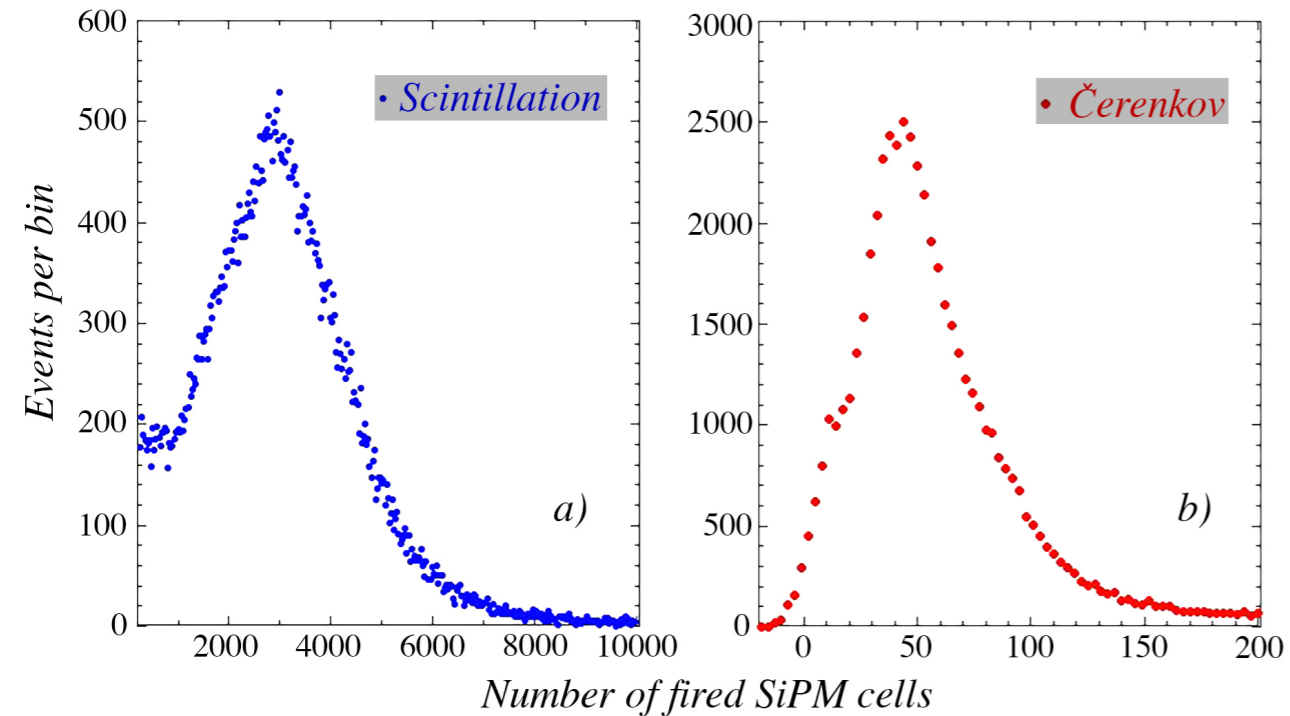

Č contamination $\sim 20 \pm 10 \%$
 Corrections for (S) non-linearity:

$$N_{\text{fired}} = N_{\text{cells}} \times \left[1 - \exp\left[-\frac{N_{\text{photons}} \times \text{PDE}}{N_{\text{cells}}}\right] \right]$$

Signal ratio: $S/C \sim 50-60$

→ S: ultra low gain (PDE $\sim 2\%$)

→ Č: intermediate gain (PDE $\sim 25\%$)

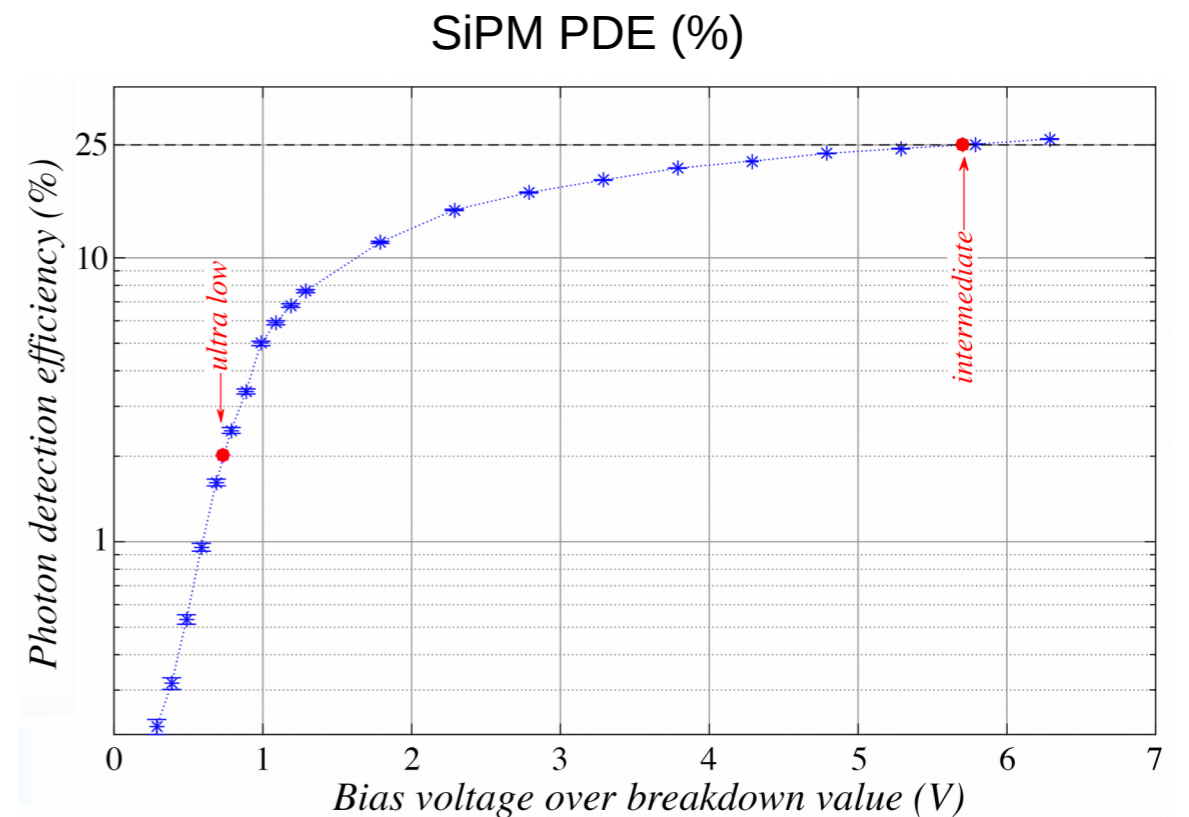

Geant4 – e.m. energy reconstruction (Cu)

e.m. calorimeter: 31.4 x 31.4 x 112.30 cm³

containment >~99%

Č only

S only

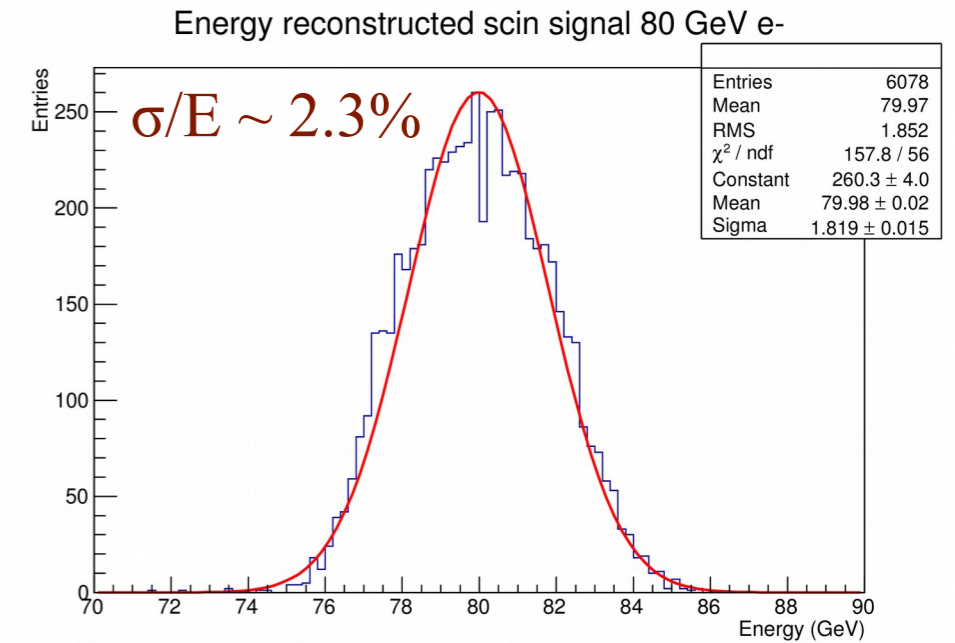
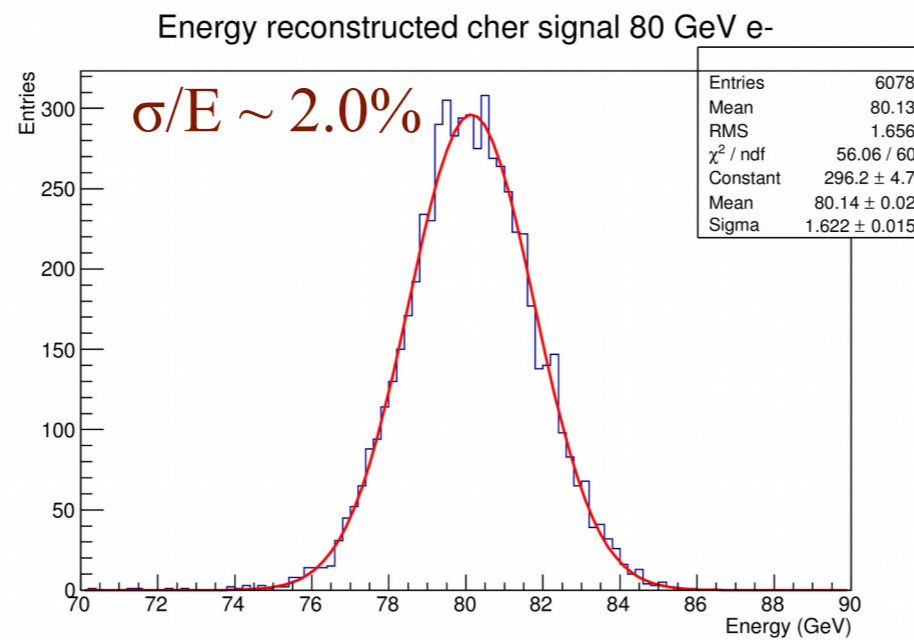

*energy reconstructed
80 GeV electrons*

S+Č

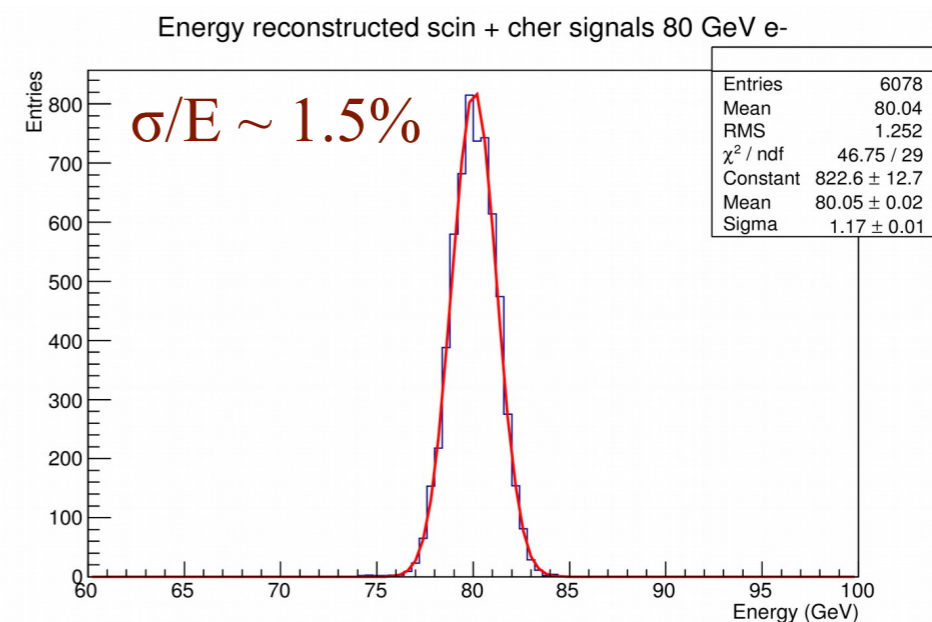

Geant4: sampling fraction (Cu)

e.m. calorimeter: 31.4 x 31.4 x 112.30 cm³
containment >~99%

E(MeV) S fibres: ~5.5%

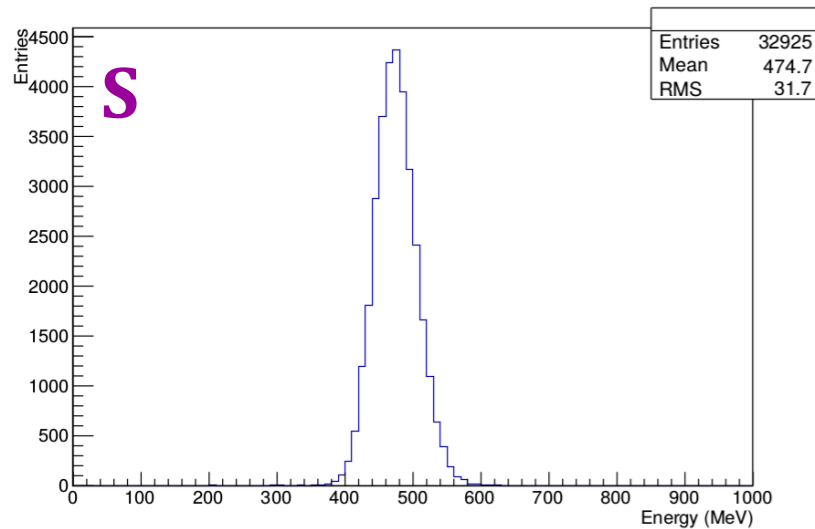

E (MeV) in hottest fibre

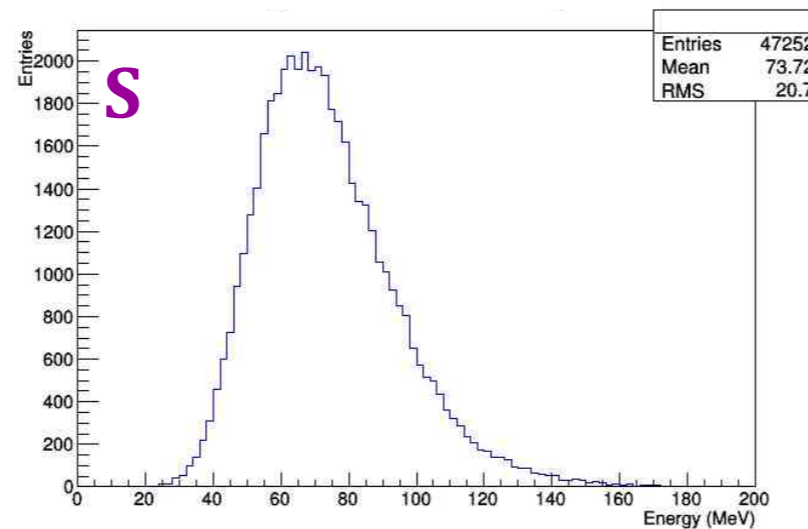

E(MeV) in fibres: ~6.2%

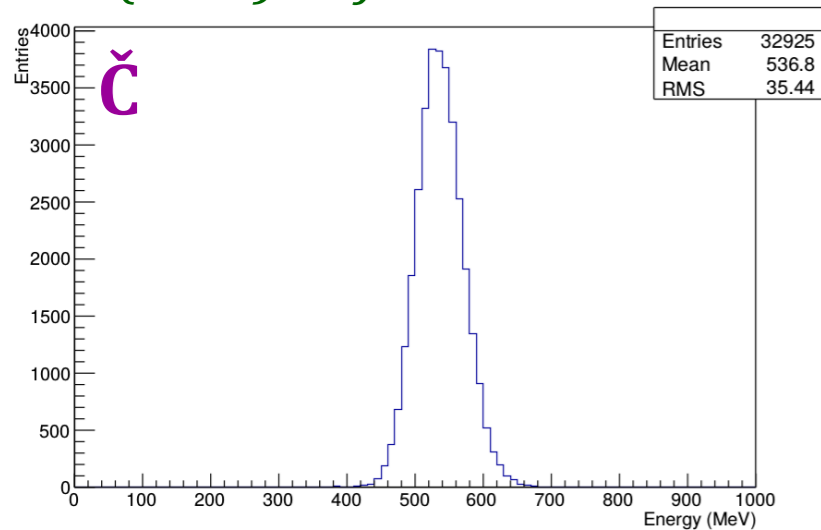

E (MeV) in hottest fibre

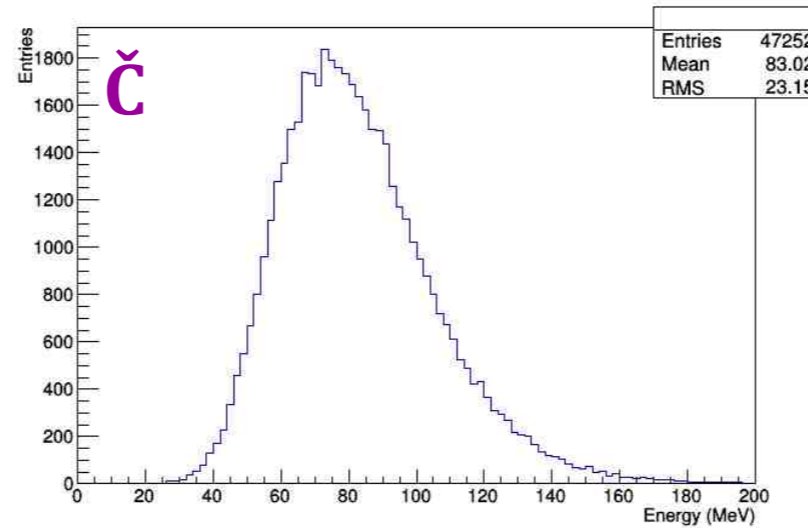

C vs. S

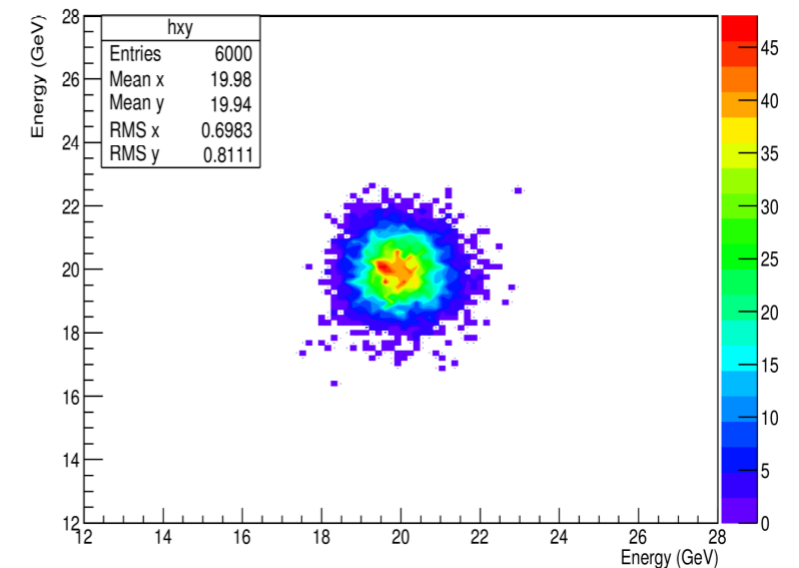

Geant4 – e.m. performance (Cu)

e.m. calorimeter: 31.4 x 31.4 x 112.30 cm³

containment >~99%

of Čerenkov p.e. @ 60 GeV

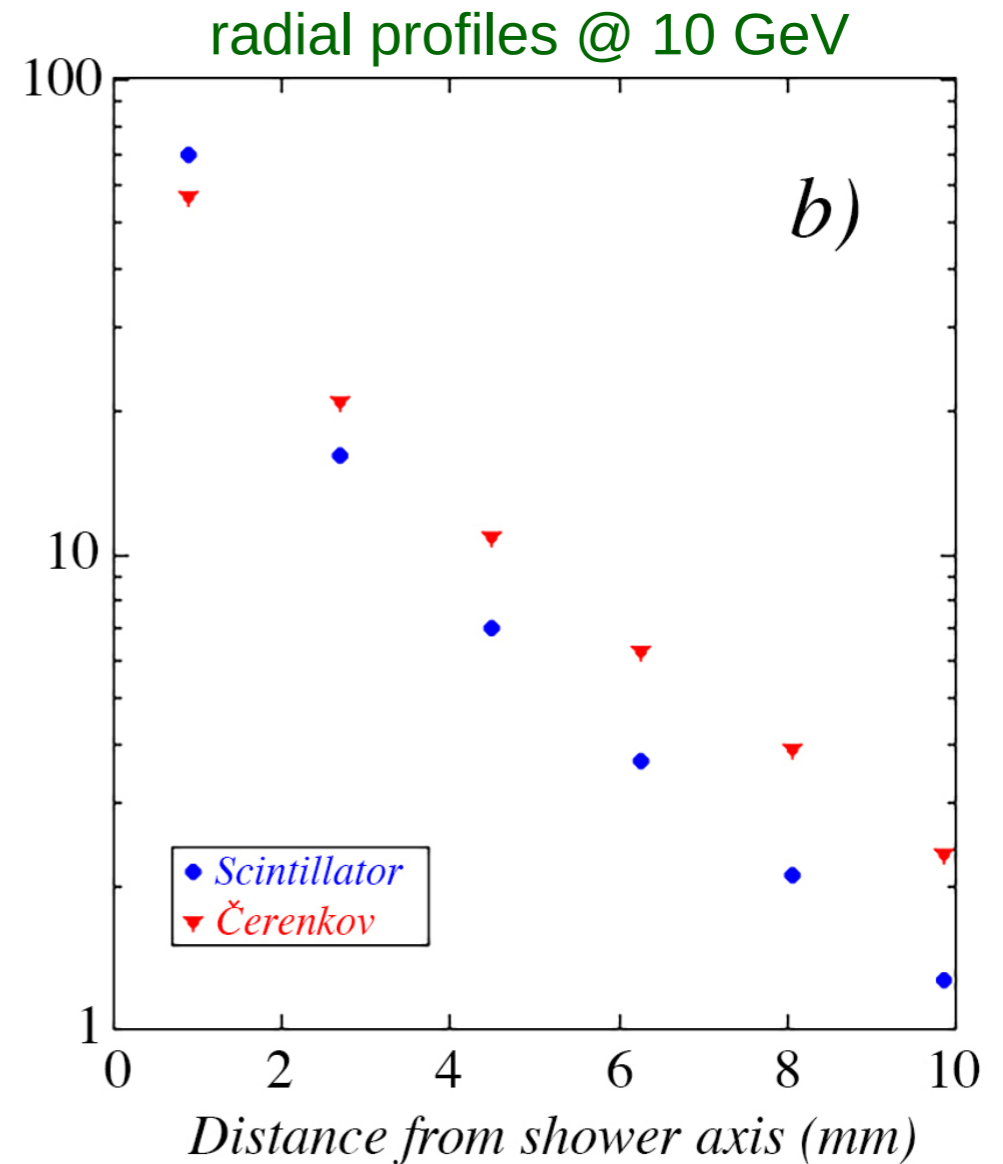
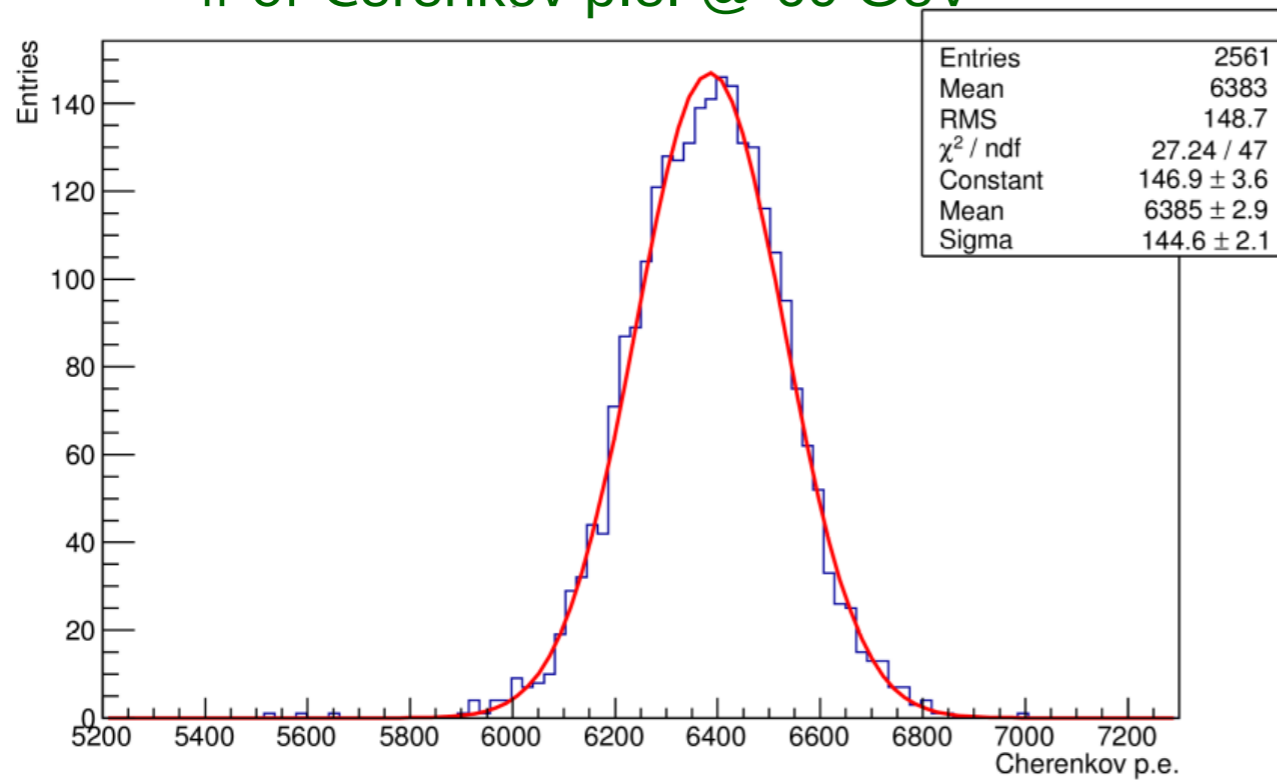

Geant4 – signal fluctuations

Energy deposition and p.e. number fluctuations

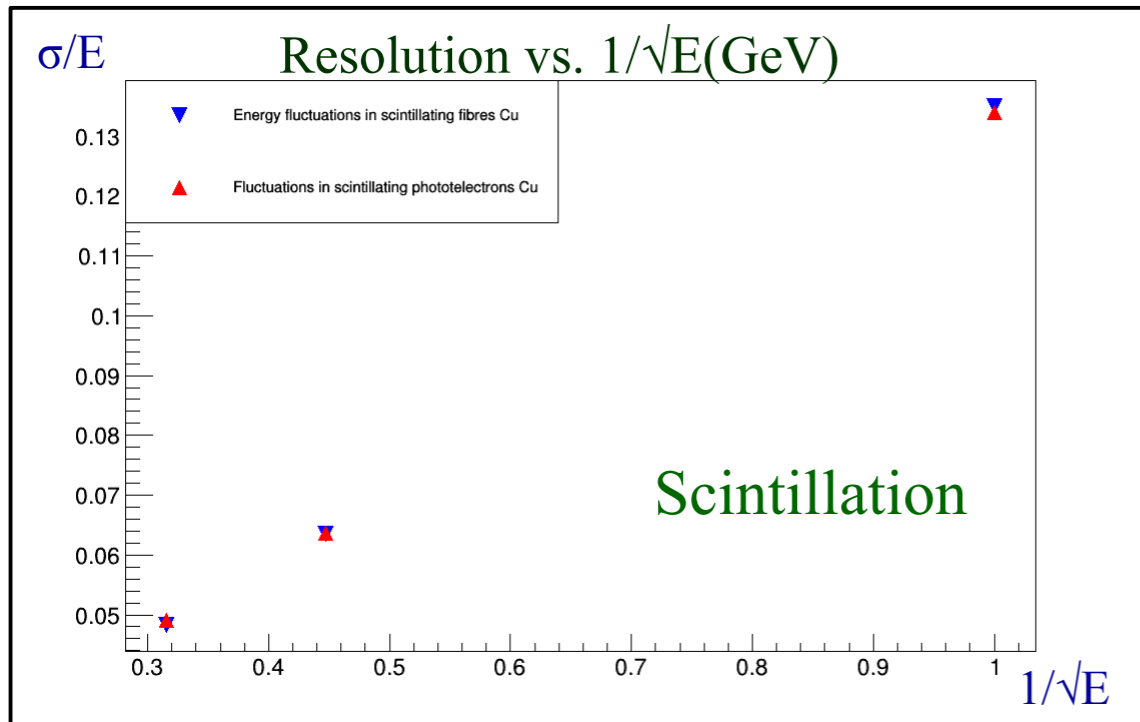

S: ~ 5500 p.e. / GeV

→ σ/E driven by fluctuations in en. depositions

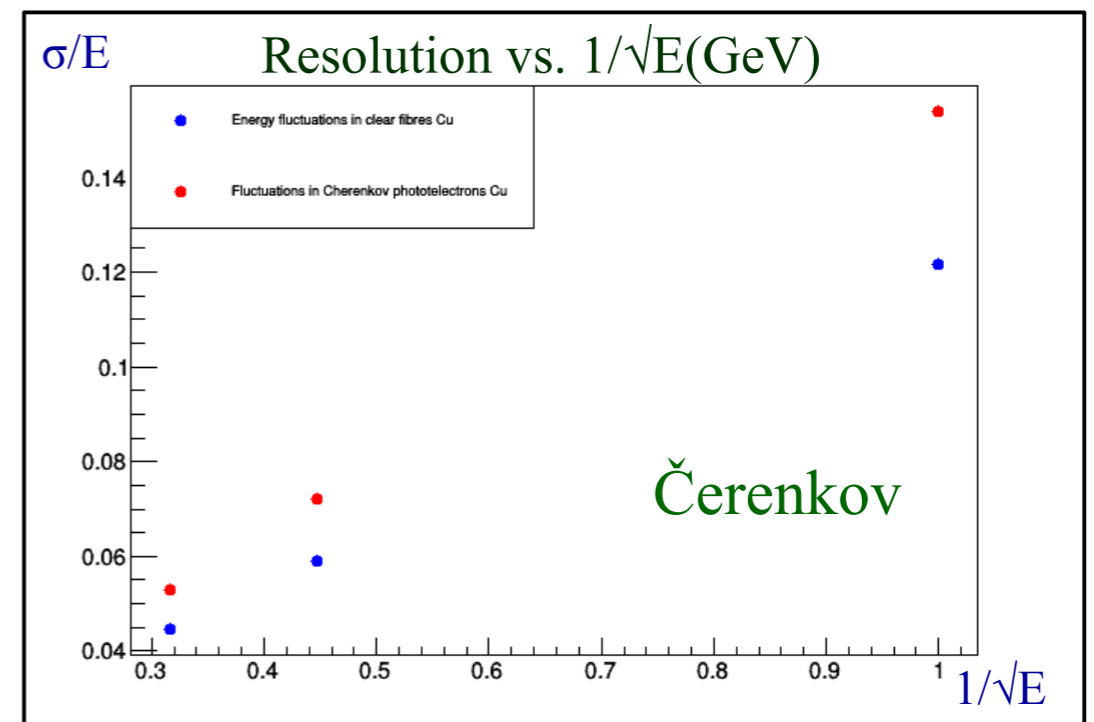

Č: ~ 110 p.e. / GeV

→ σ/E driven by fluctuations in p.e. number

Sampling fluctuations contribution to resolution:

$$\frac{\sigma}{E} = 2.7\% \times \frac{\sqrt{1/0.113}}{\sqrt{E}} = \frac{8.0\%}{\sqrt{E}}$$

Geant4 – h/e and χ factors

f_{em} = MC truth (total energy deposited by e^+ and e^-)

E = average contained energy

C, S = signals

either:

$$f_{em} \rightarrow 0 : C/E, S/E \rightarrow (h/e)$$

or:

$$(h/e)_{\check{C}} = (C/E - f_{em}) / (1 - f_{em})$$

$$(h/e)_S = (S/E - f_{em}) / (1 - f_{em})$$

while:

$$\chi = (1 - (h/e)_S) / (1 - (h/e)_{\check{C}}) = (E - S) / (E - C)$$

Geant4 - hadronic performance (preliminary)

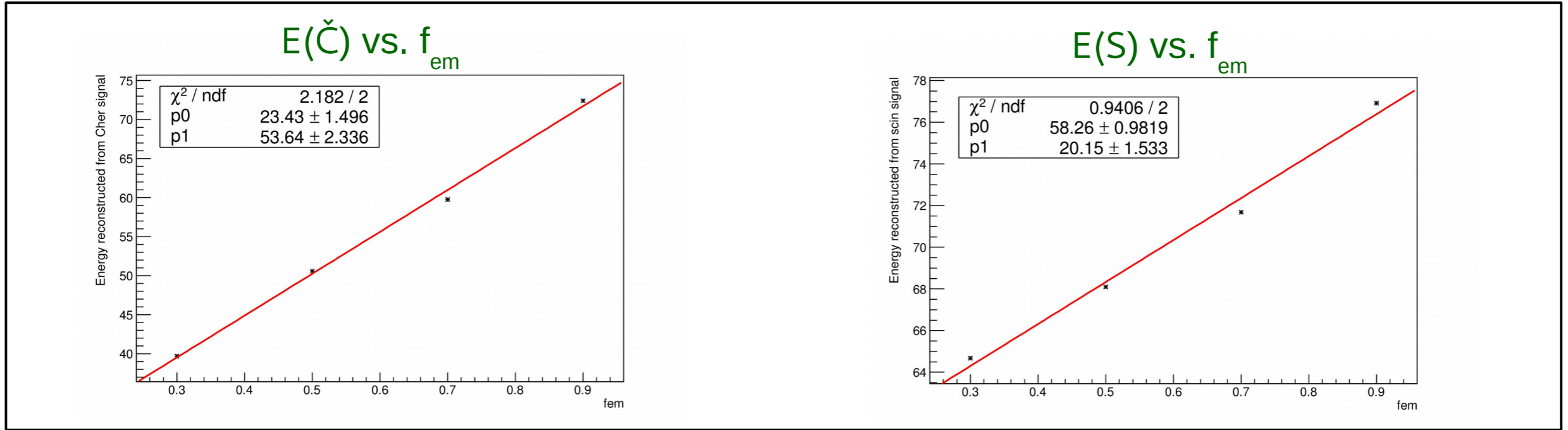

Copper

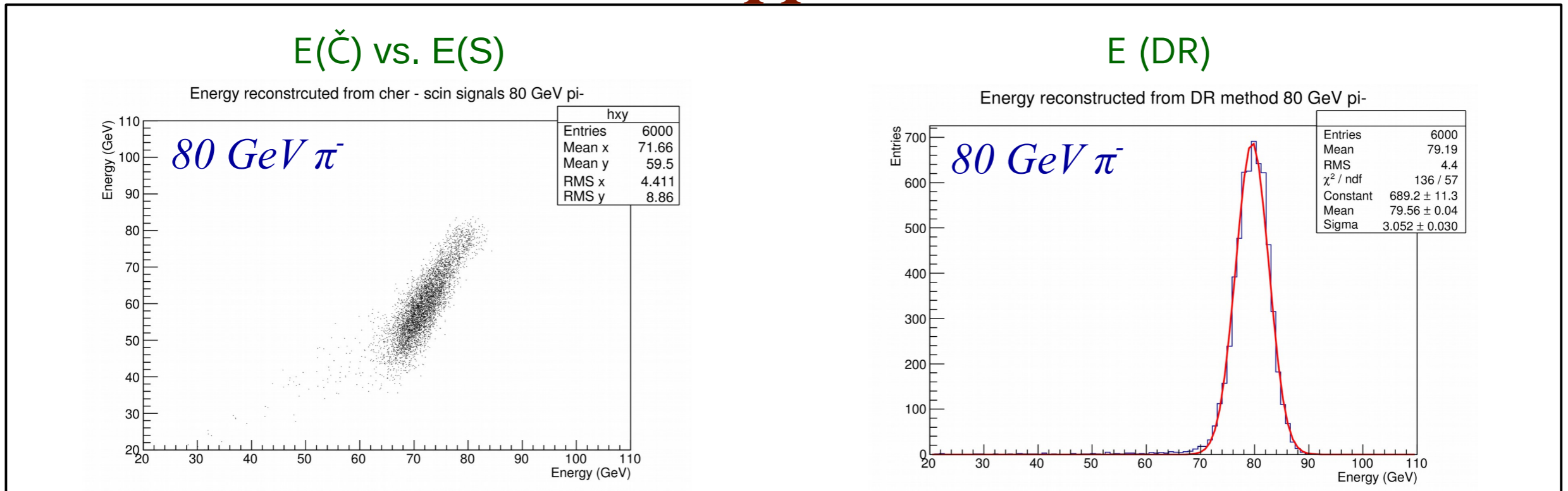

Geant4 – h/e factors for Copper

Copper

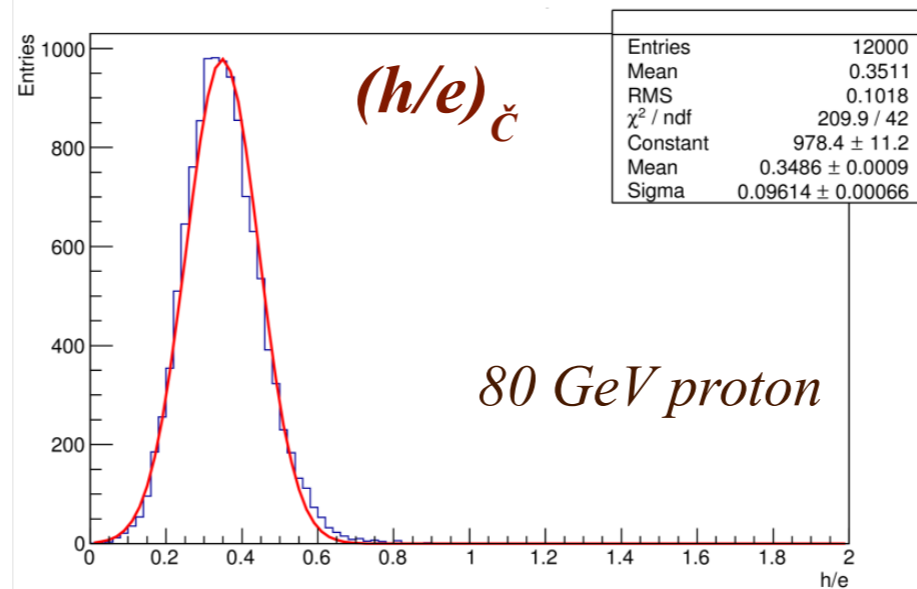
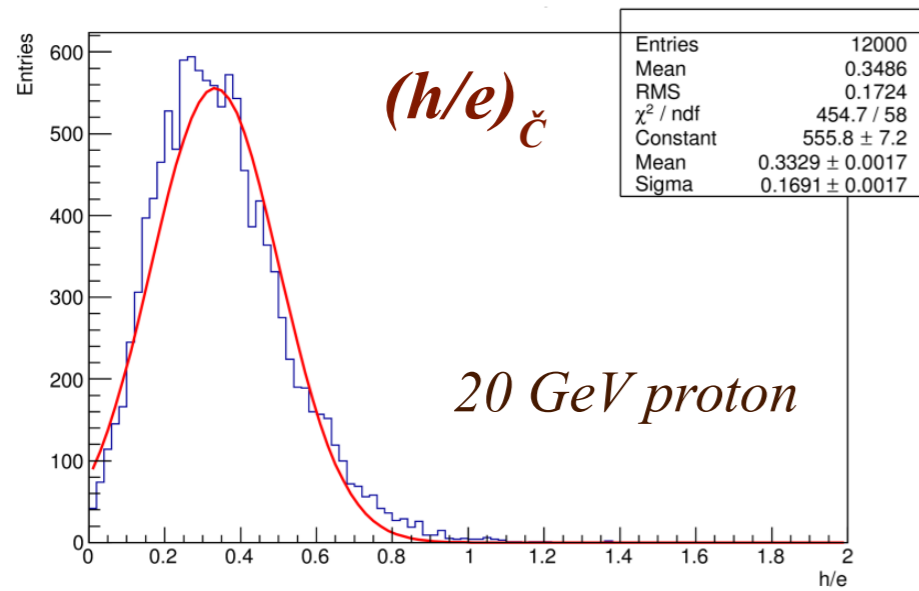

$$(h/e)_c \approx 0.35$$

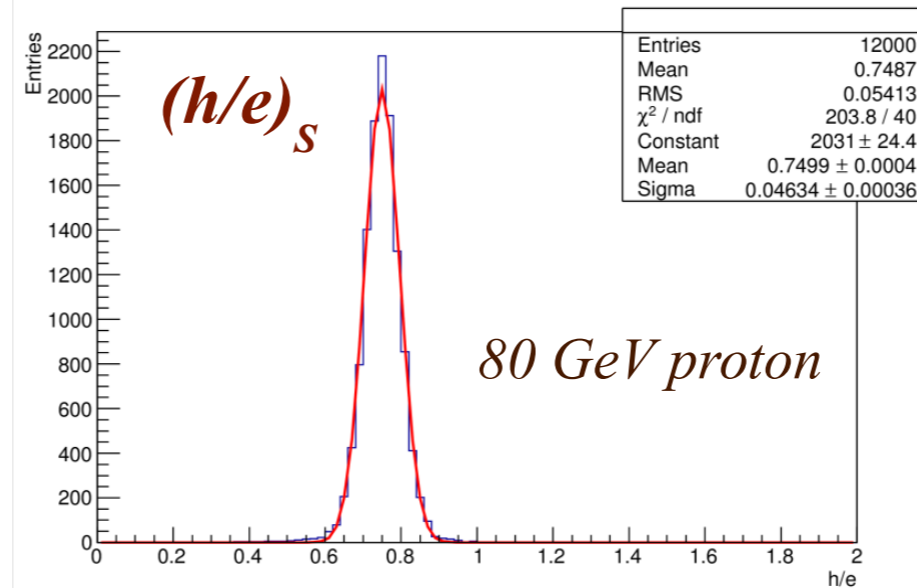
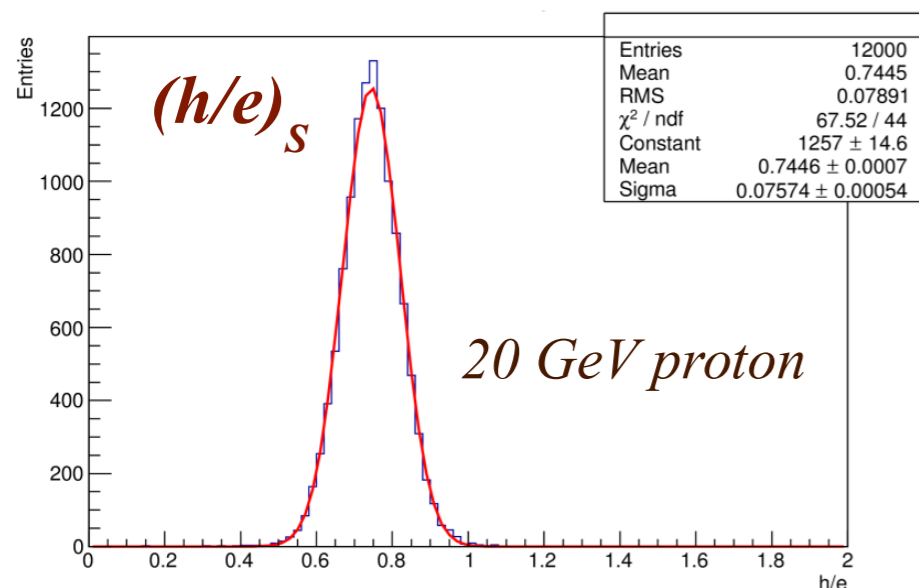

$$(h/e)_s \approx 0.75$$

Geant4 – h/e factors for Lead

Lead

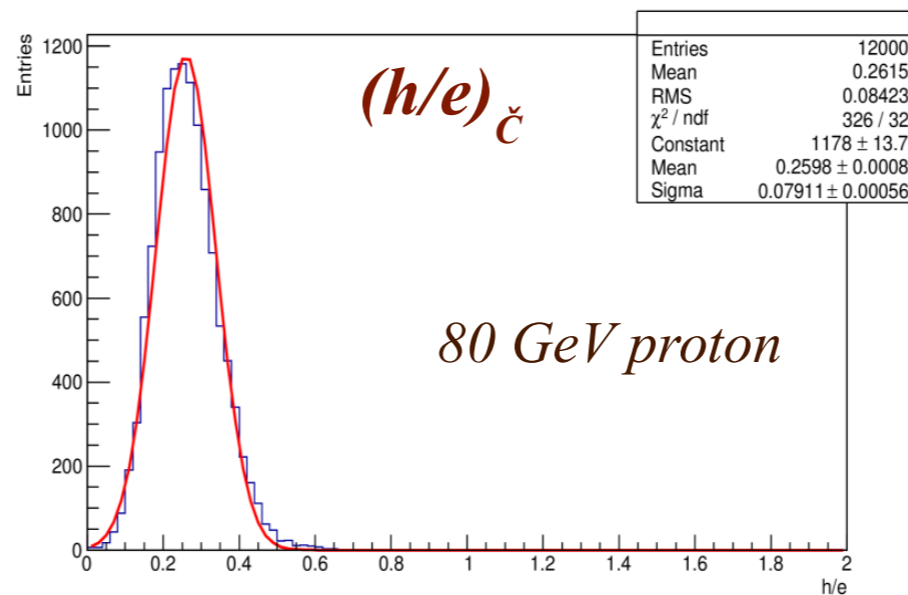
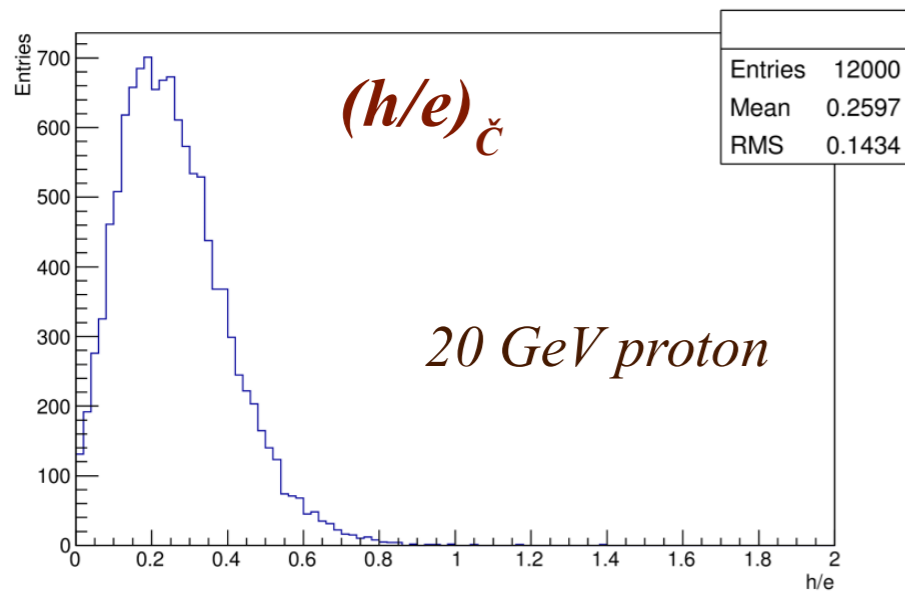

$$(h/e)_c \approx 0.26$$

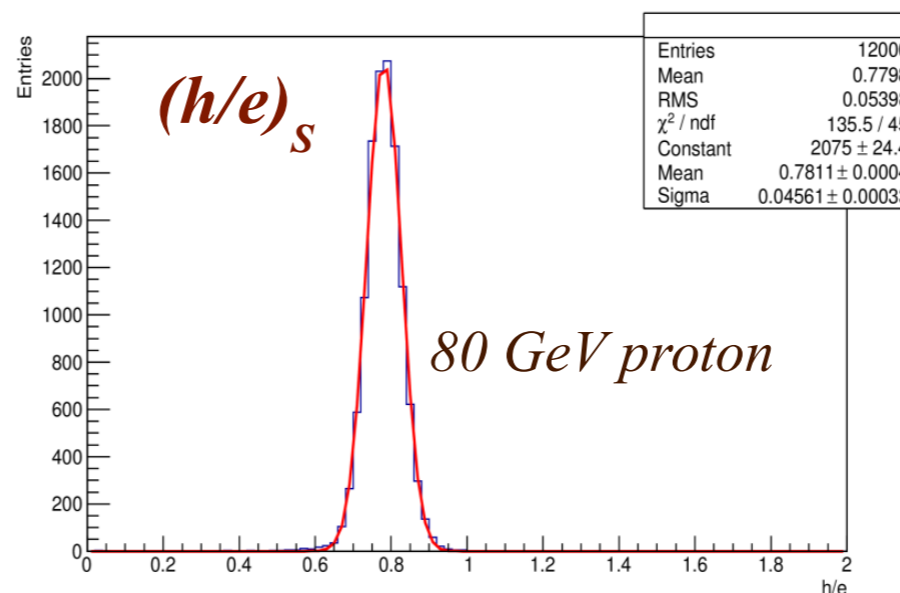
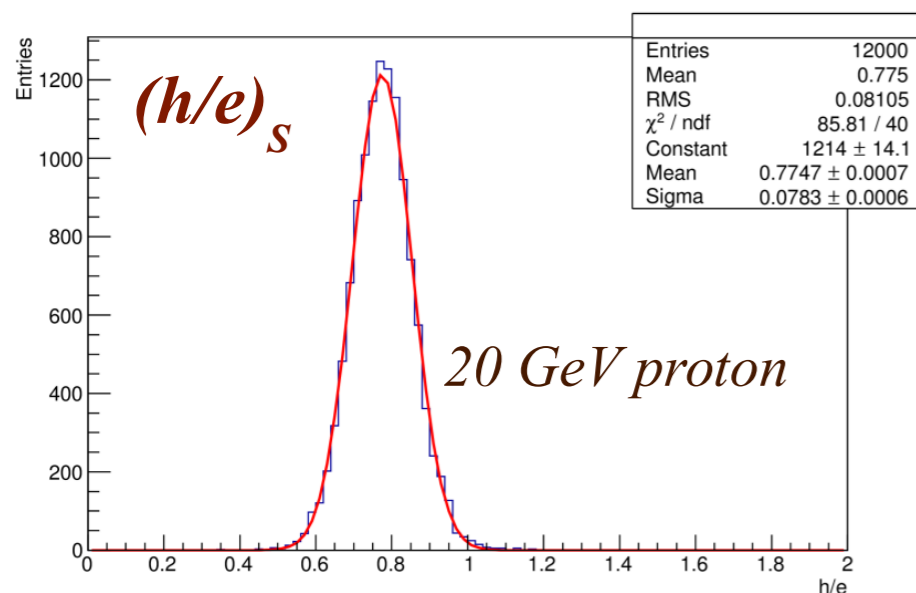

$$(h/e)_s \approx 0.78$$

Geant4 – χ factors for Copper and Lead

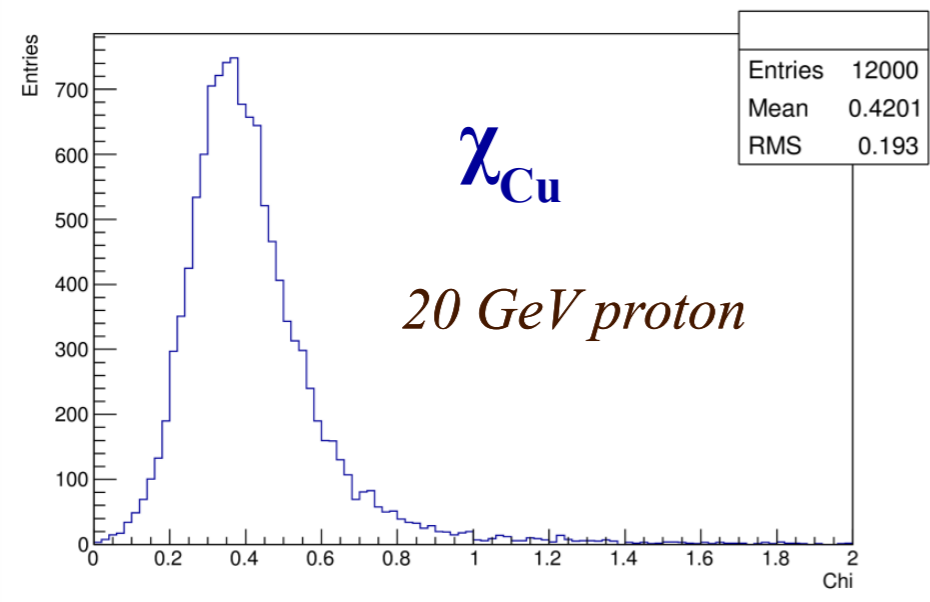

Copper

$$\chi_{\text{Cu}} \approx 0.39$$

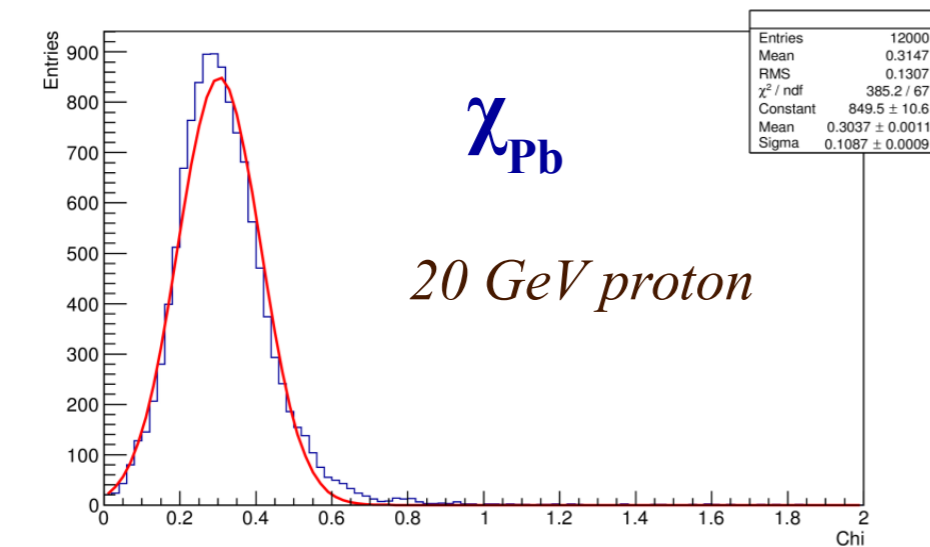
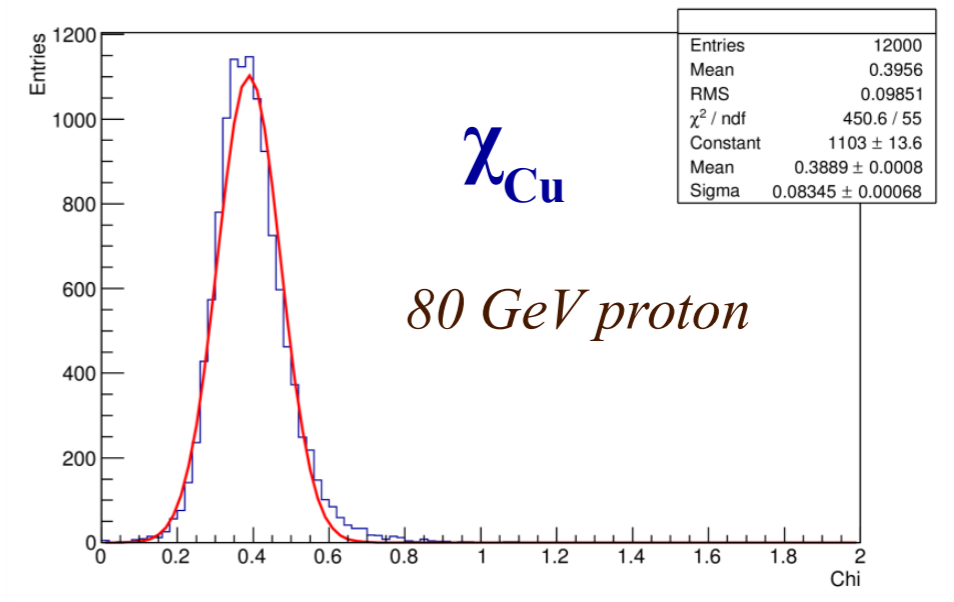

Lead

$$\chi_{\text{Pb}} \approx 0.30$$

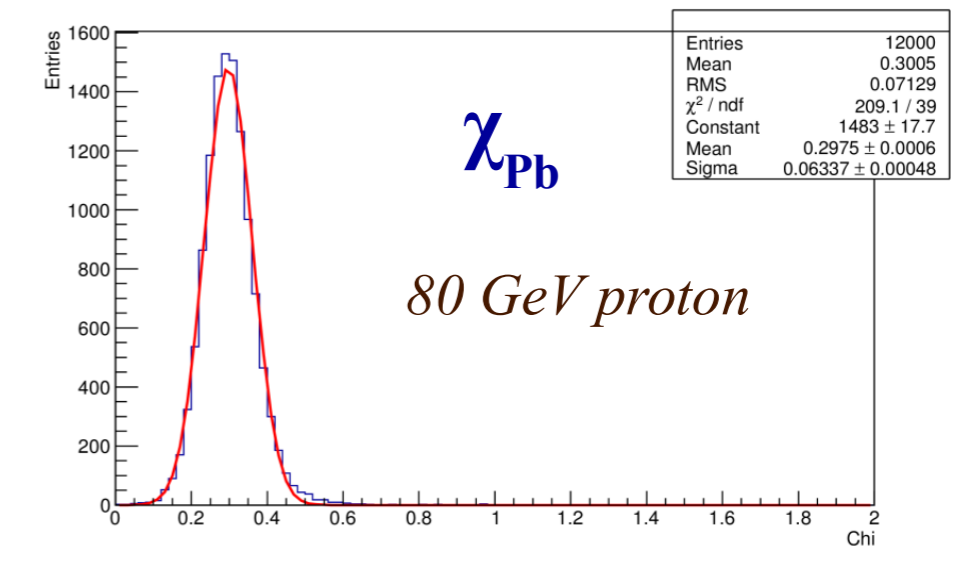

Low-energy performance - Copper vs. Lead

Energy deposited in scintillating fibres

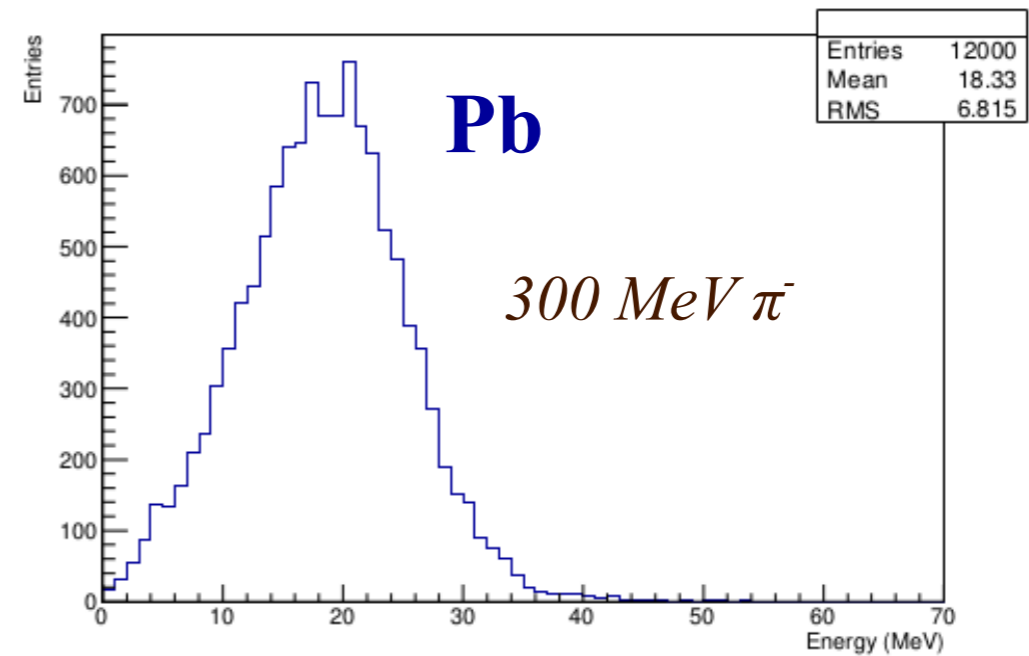
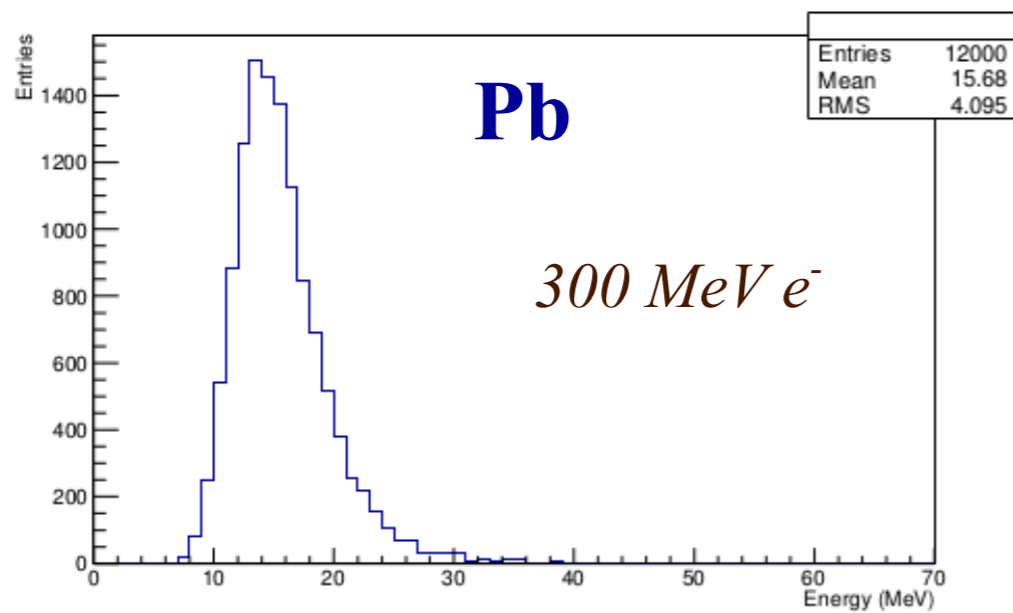
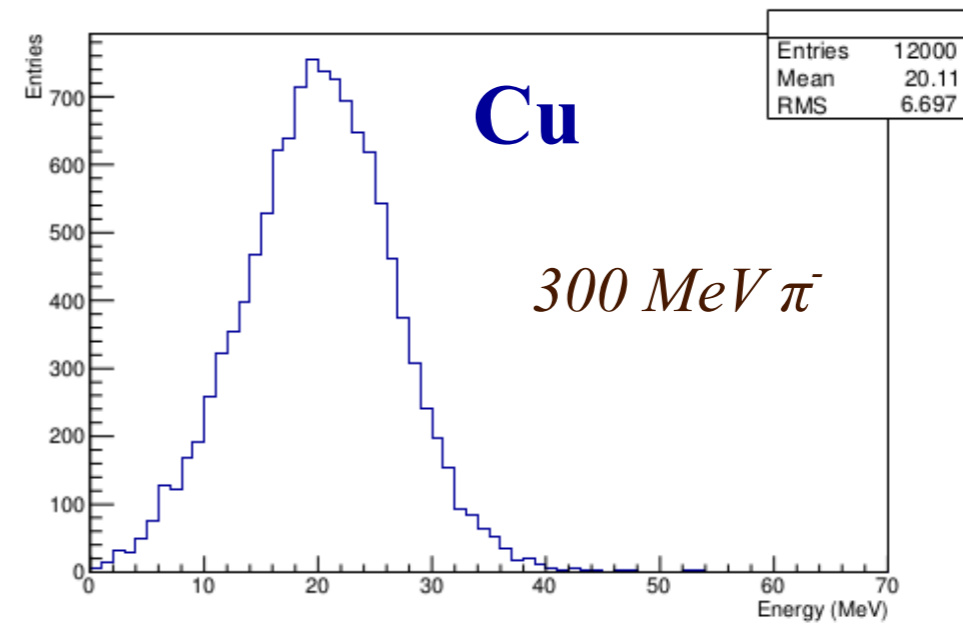
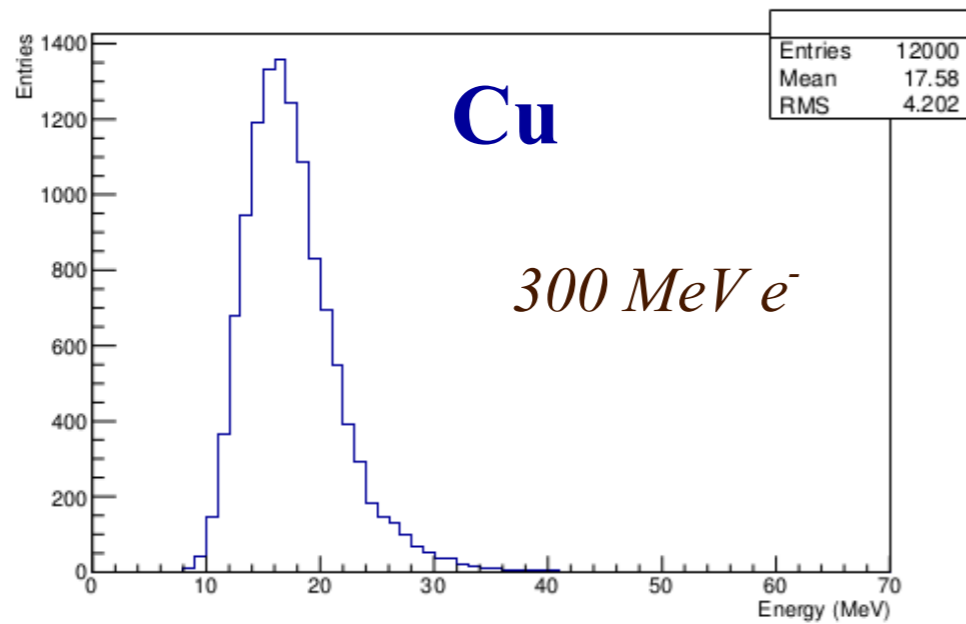

2016 → 2017 Testbeam

Some serious issues with first tests (2016) → change SiPM.s :

1) avoid/limit saturation and non-linearity:

50x50 μm^2 , 400 cells (2016) → 25x25 μm^2 , 1600 cells (2017)

a) larger dynamic range

b) lower PDE (lower fill factor)

2) avoid/limit optical crosstalk (light leakage):

$S \geq 30 \times \check{C}$! → light leakage critical

c) staggered fibre layout (readout at two different planes)

Data taking w/ electrons and muons (energy scans and position scans)

Geant4: 20 GeV electron shower containment

RD52 testbeam module: $1.014 \times 1.014 \times 112.30 \text{ cm}^3$

total energy lost (MeV)

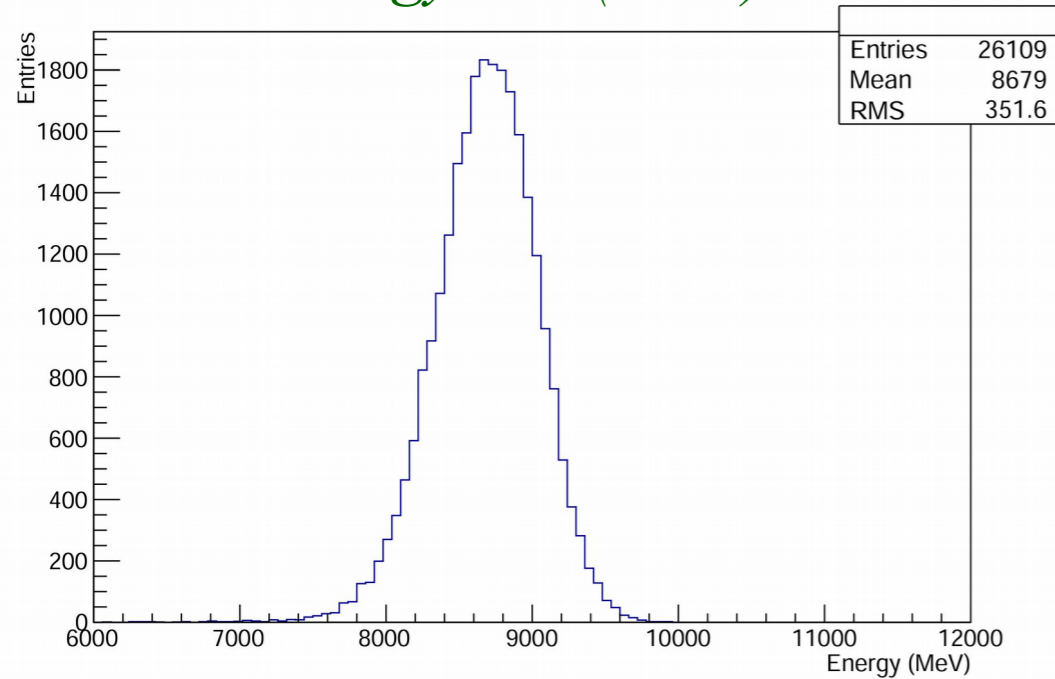

centered events: ~43% containment

containment .vs. impact point

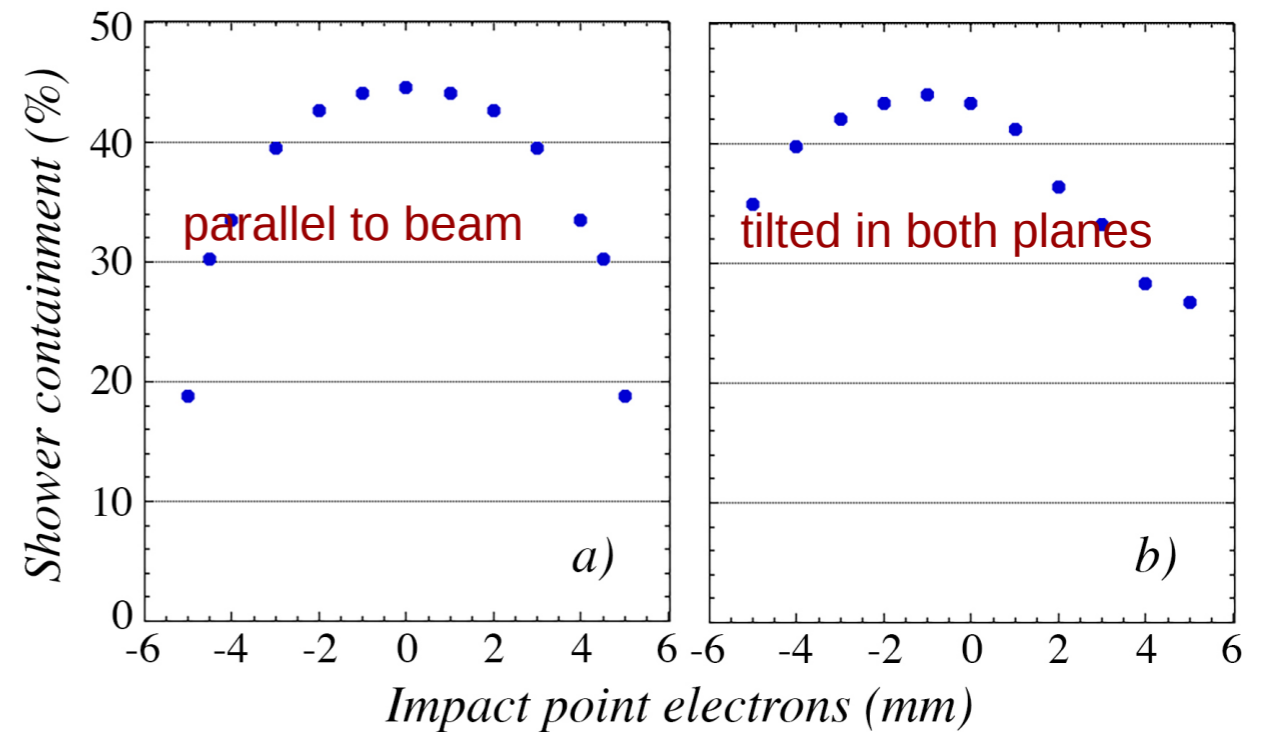

e.m. calorimeter: $31.4 \times 31.4 \times 112.30 \text{ cm}^3$

containment > 99%

(all plots for copper unless specified differently)

Geant4 - hadronic shower simulations

Dimensions:

71 x 71 units

1 unit:

1.014 x 1.014 x 250 cm³ copper module

32 (S) + 32 (Č) fibres

SiPM readout

Containment: ~99%

Calibration of both S and Č w/ 40 GeV e⁻

***** Preliminary results! *****

Geant4 – (h/e) and χ factors

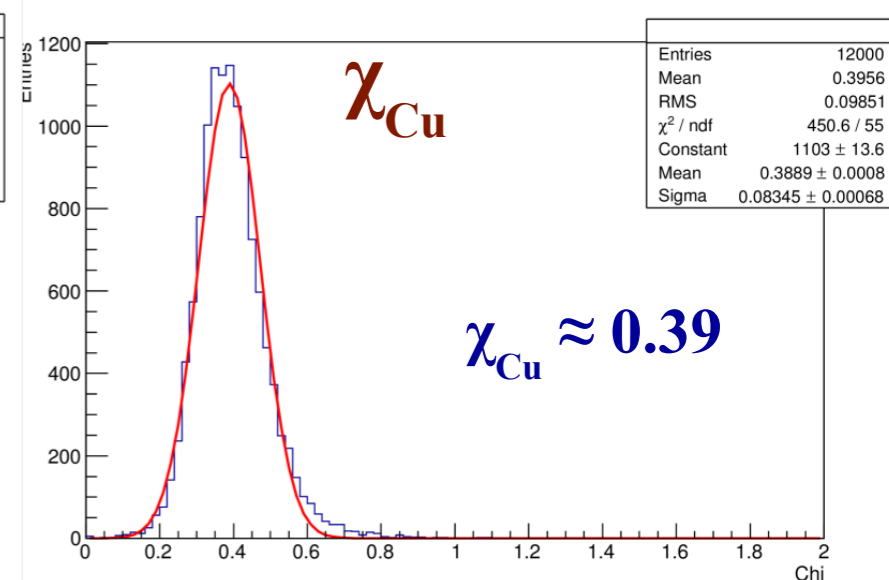
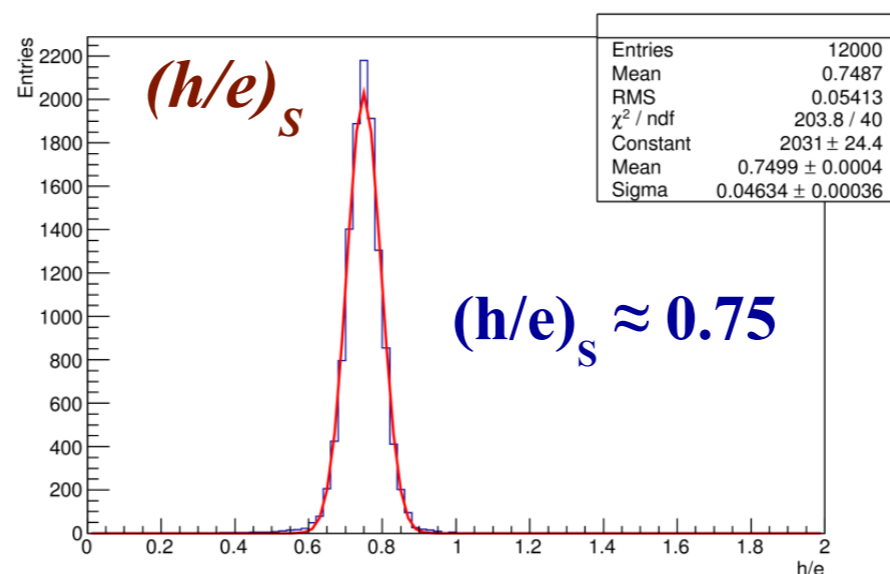
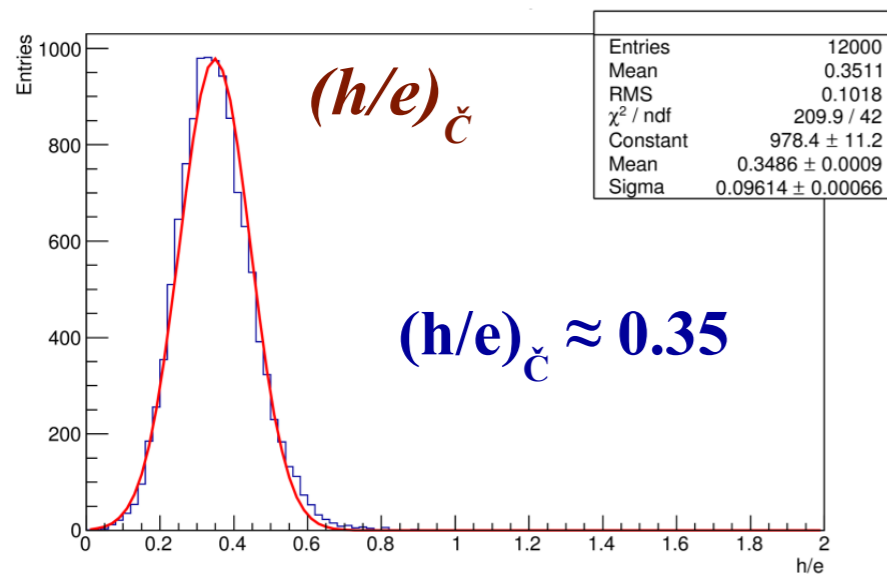

Copper →

80 GeV protons in Copper ↑ & Lead ↓

Lead →

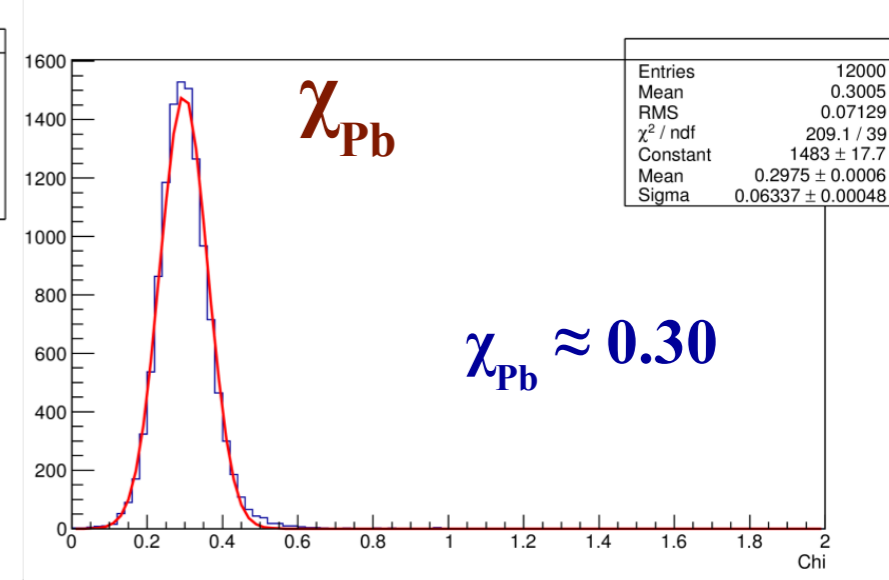
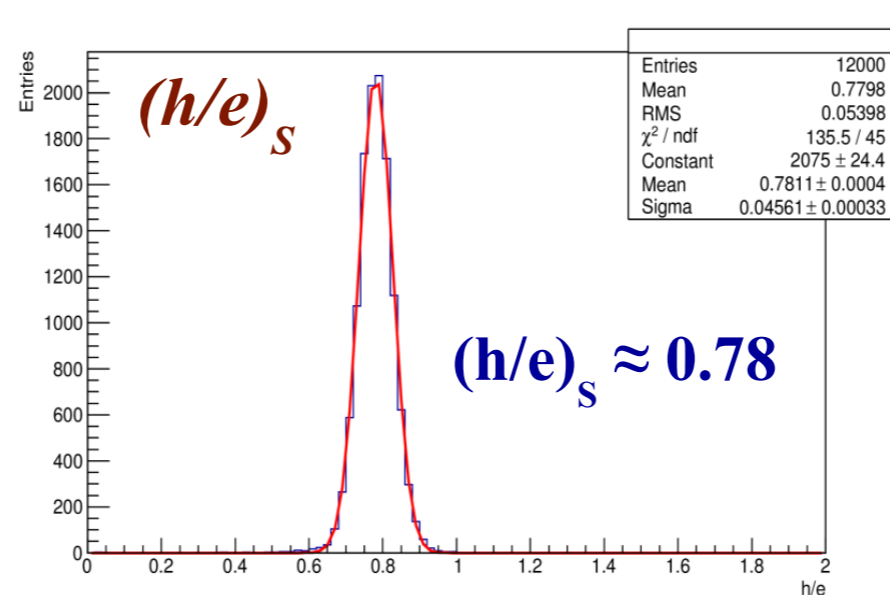
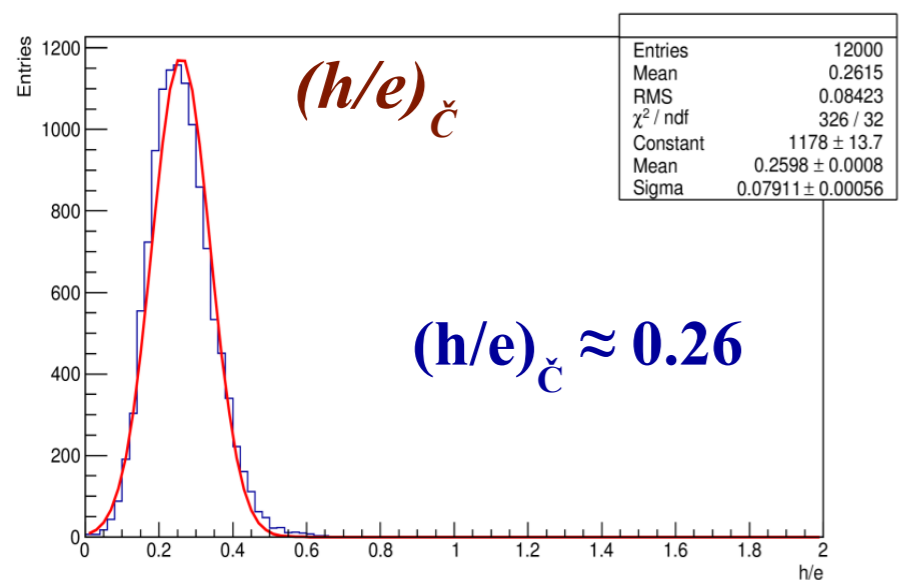

Mechanics/Sensors/Electronics

Mechanics:

from $\sim O(\sim 1 \text{ cm}^2)$ \rightarrow 5×5 / $10 \times 10 \text{ cm}^2$ few modules

Sensors:

\rightarrow SiPM performance: go to $10 \times 10 \mu\text{m}^2$, 10000 pixels, sensors

\rightarrow follow developments on SiC devices (meant to be solar light blind and provide exclusive UV sensitivity) ?

Electronics:

search for SiPM tailored multi-channel ASIC.s

\rightarrow test channel grouping / adding (1, 3, 5, 6 channels summed up)

target: demonstrate the feasibility of a scalable solution made of $\sim 10 \times 10 \text{ cm}^2$ modules w/ 5000-10000 fibres, individually coupled to electronics

Readout

We have this:

:-)



- 32-channel read out system
- FPGA based charge integration algorithm
- data: event timecode and integrated charge for all pixels

→ need something more tailored (shorter integration time, time information, peak/charge ratio, ...)

but we would like this:

:-)

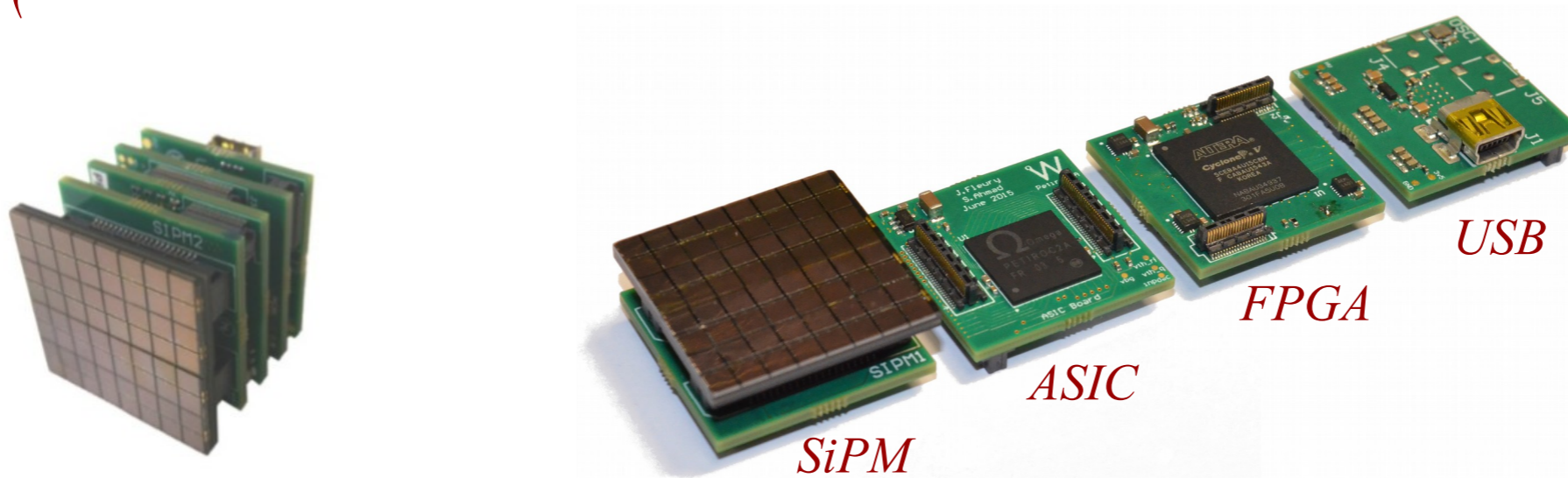

first step: ASIC (to be identified)