

---

# Status of detector research in Minsk

---

K. Afanaciev

32<sup>nd</sup> FCAL Collaboration Workshop, Krakow  
2018

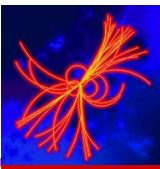

## New everything

---

New institute since 2016.

Had to move to a new building in 2017. All the measurement setups disassembled and assembled back in a new place. Took me a few months to get everything back to working order.

Moved to a new laboratory this year.

There is a contract with Dubna to build a test setup for gas detectors: GEMs (Gas Electron Multipliers), Drift tubes, Straw tubes.

Got some new equipment and more to come in the next few months. The idea is to build a detector lab and do detector research. Basic infrastructure is the same: DAQ system, front end electronics, power and HV sources, particle sources.



# GEM proof of work setup

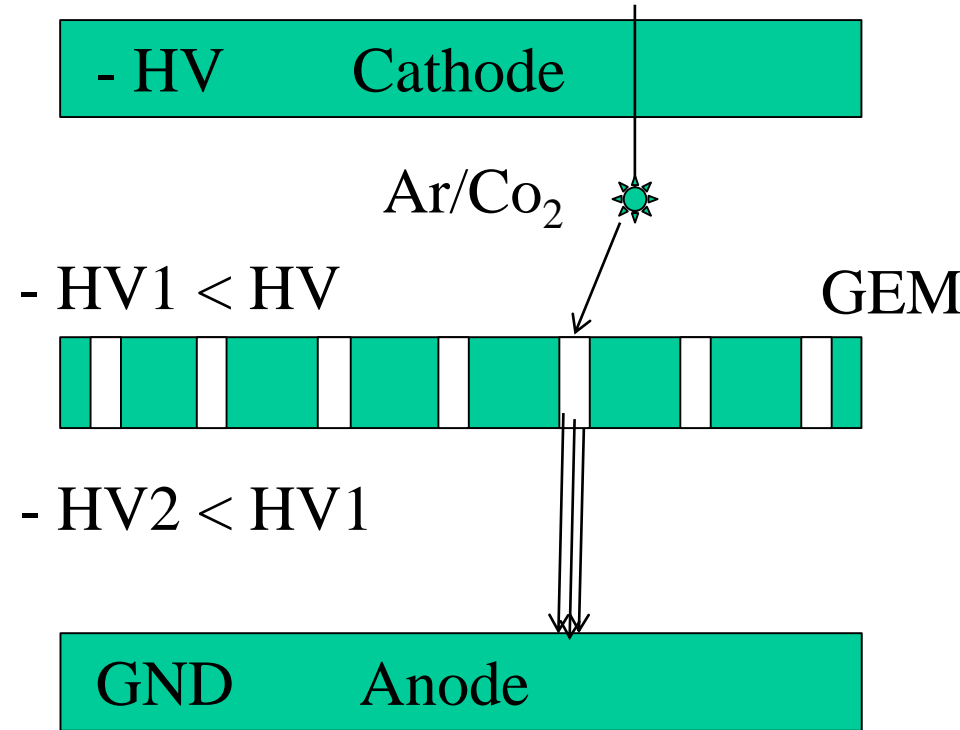
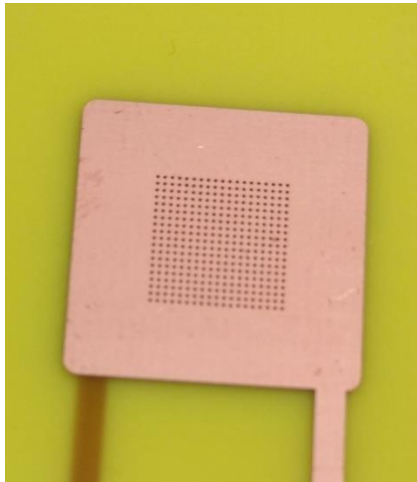
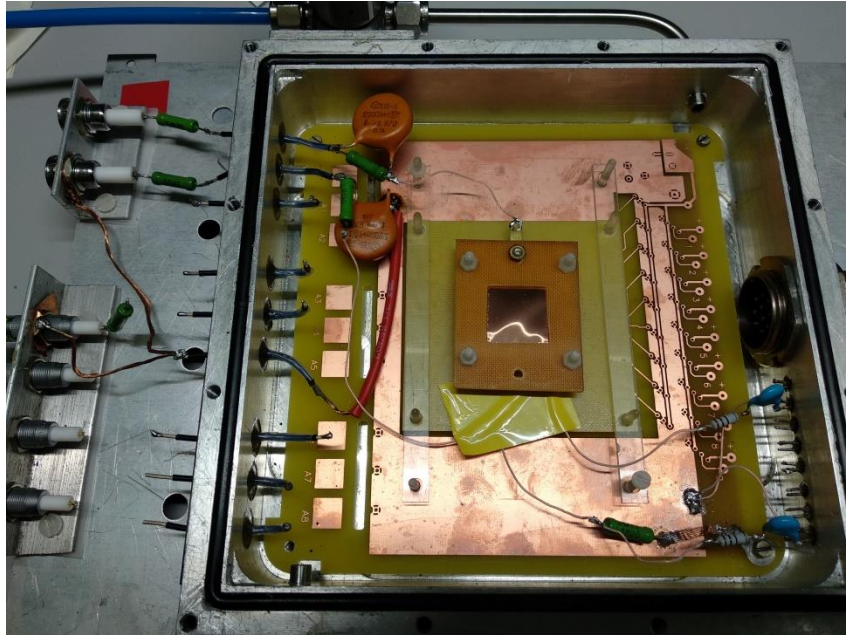

Gas multiplication in the holes up to  $10^4$  for thick gems, up to  $10^3$  for thin ones.  
Usually electron drift to anode is registered

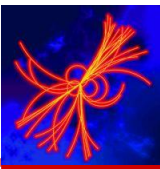

# GEM proof of work setup



Fe 55 x-ray source used for testing  
5,9 keV main peak,  
2,9 keV escape peak in Ar

~ 5k gain on this plot

For comparison

gem5\_3020\_1420.txt

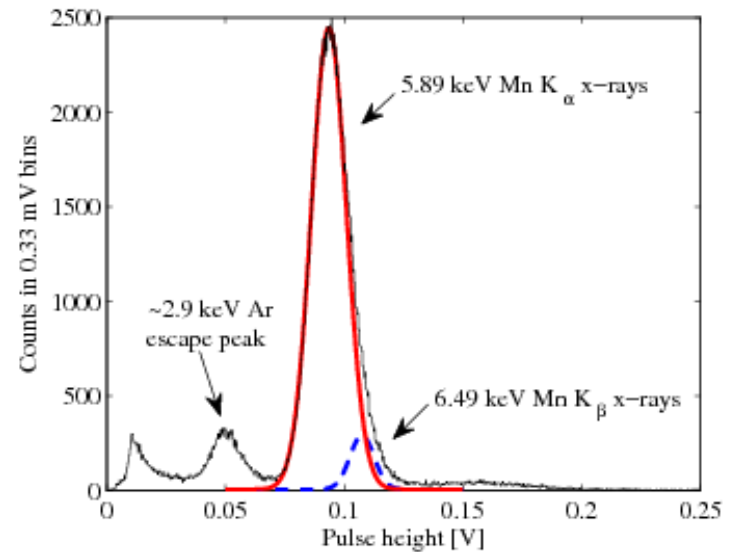
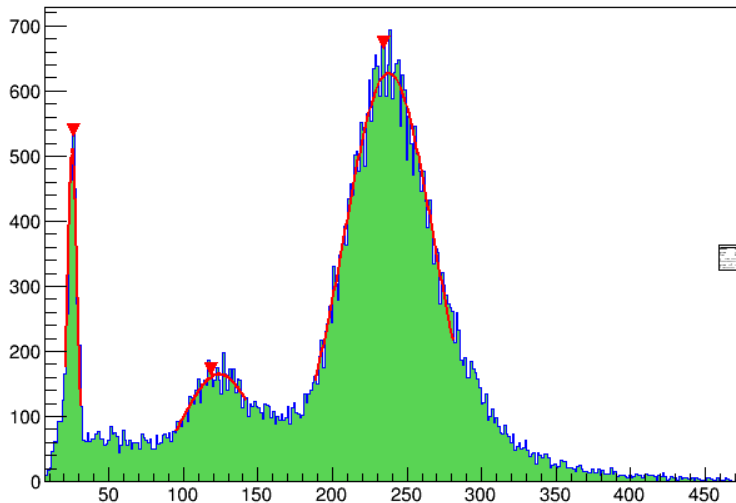

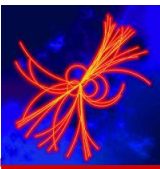

## Other GEMs

