



Overview of the LHCb results

Frédéric FLEURET

*Laboratoire Leprince-Ringuet, École polytechnique
and Laboratoire de l'Accélérateur Linéaire, Orsay*

QGP-France 2018

02/07/2018

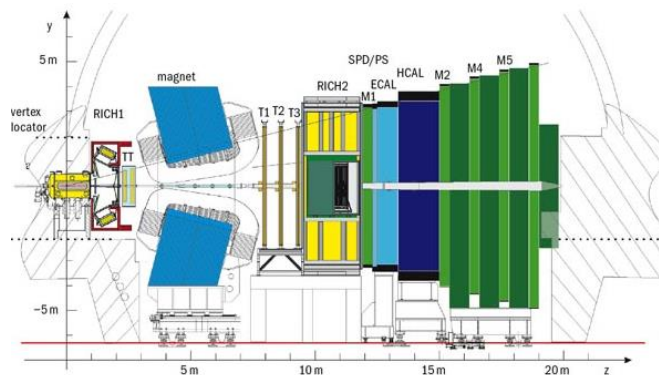

Single arm spectrometer, the only LHC experiment fully instrumented in $2 < \eta < 5$

Designed for heavy flavor physics

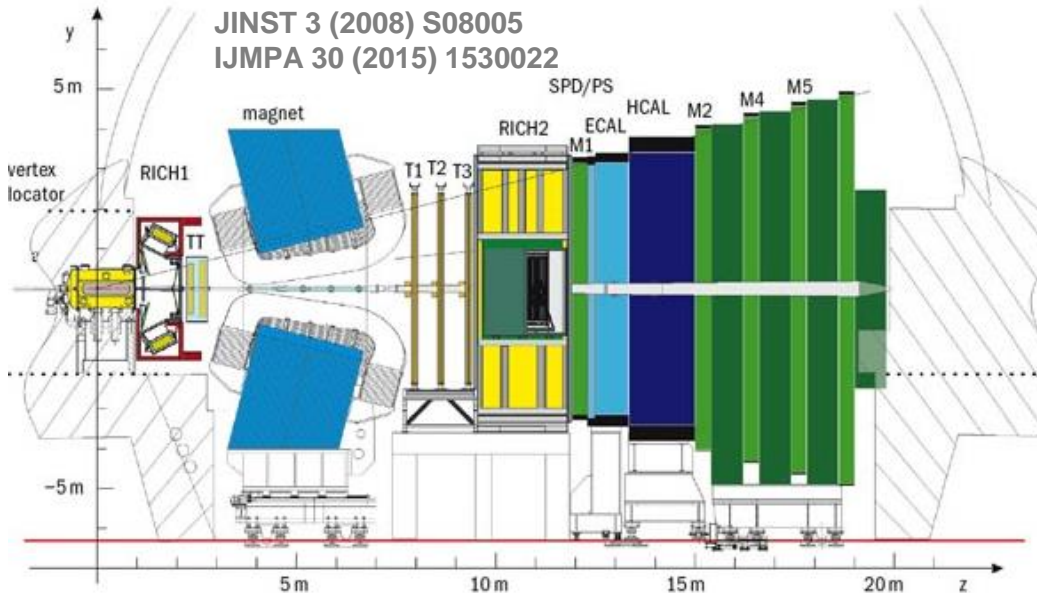

- hadron PID
- muon system
- lumi counters
- HCAL
- ECAL
- tracking

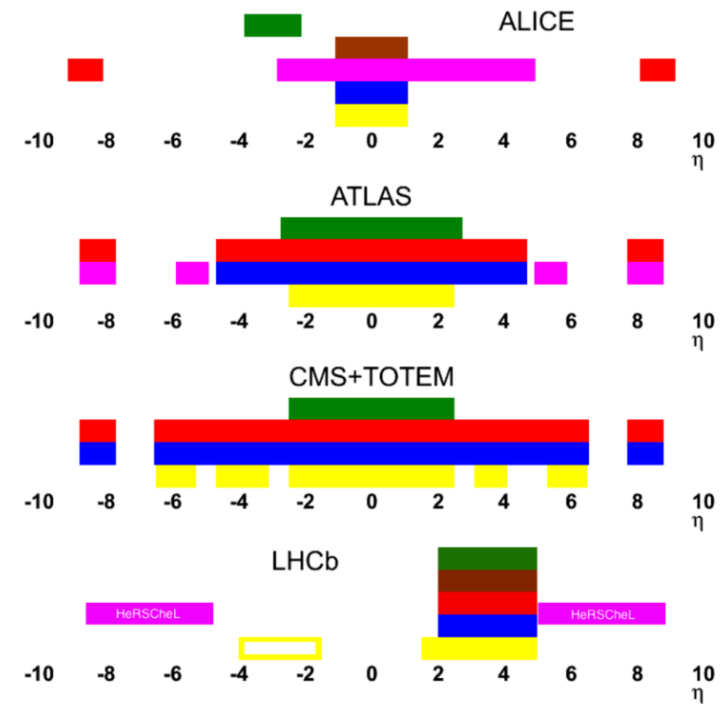

Excellent vertex, IP and decay time resolution

$$\sigma(\text{IP}) \approx 20 \mu\text{m}$$

Very good momentum resolution

$$\delta p/p \approx 0.5\text{--}1\% \text{ for } 0 < p < 200 \text{ GeV}/c$$

Particle identification

$$\varepsilon_{K \rightarrow K} \approx 95\% \text{ for } \varepsilon_{\pi \rightarrow K} \approx 5\% \text{ up to } 100 \text{ GeV}/c$$

$$\varepsilon_{\mu \rightarrow \mu} \approx 97\% \text{ for } \varepsilon_{\pi \rightarrow \mu} \approx 1\text{--}3\%$$

LHCb can operate p -Pb and Pb-Pb collisions

- Can also operate in **fixed-target mode**: unique at LHC
 - Injecting gas in the LHCb VERTeX LOcator (VELO) tank, primarily done to perform luminosity measurement.
 - Can be used as an **internal gas target**
 - Allows measurement of p -gas and ion-gas interactions

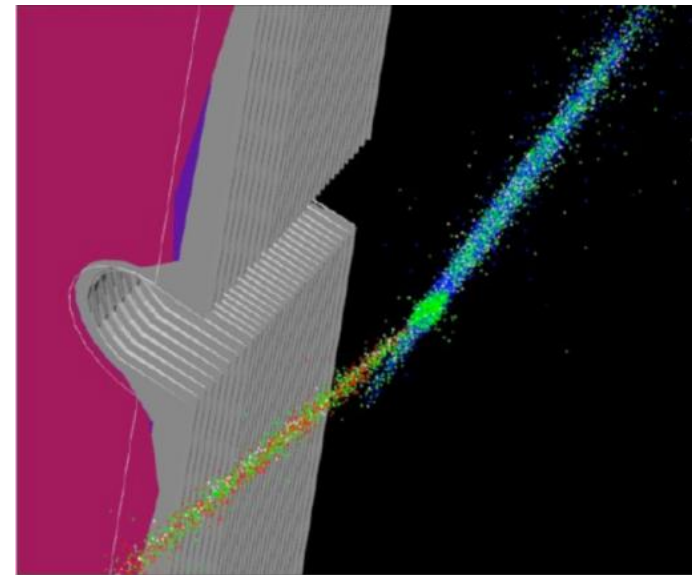

Distribution of vertices overlaid on detector display. z-axis is scaled by 1:100 compared to transverse dimensions to see the beam angle.

Beam 1 - Beam 2, Beam 1 - Gas, Beam 2 - Gas.

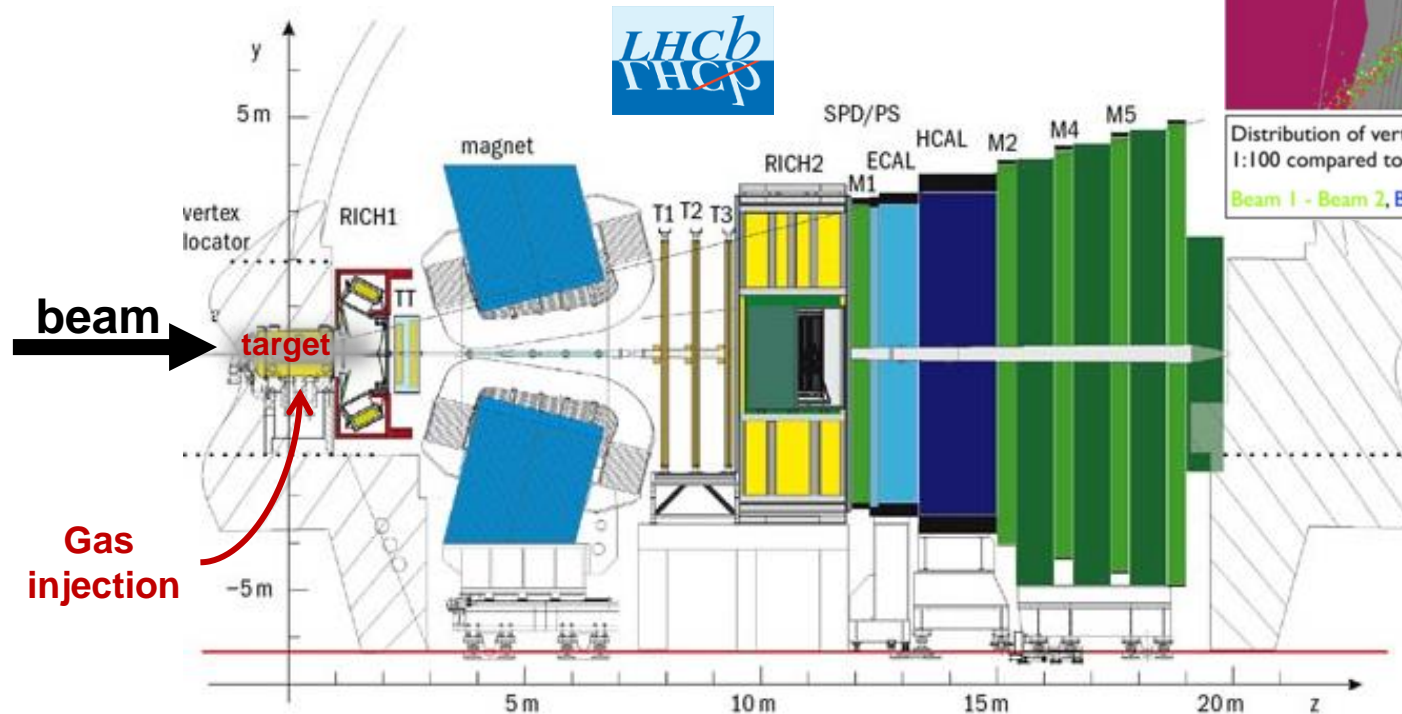

Noble gas only :
(very low chemical reactivity)

He, Ne, Ar, Kr, Xe
A = 4, 20, 40, 84, 131

Gas pressure:
 10^{-7} to 10^{-6} mbar

LHCb rapidity coverage in the centre-of-mass system

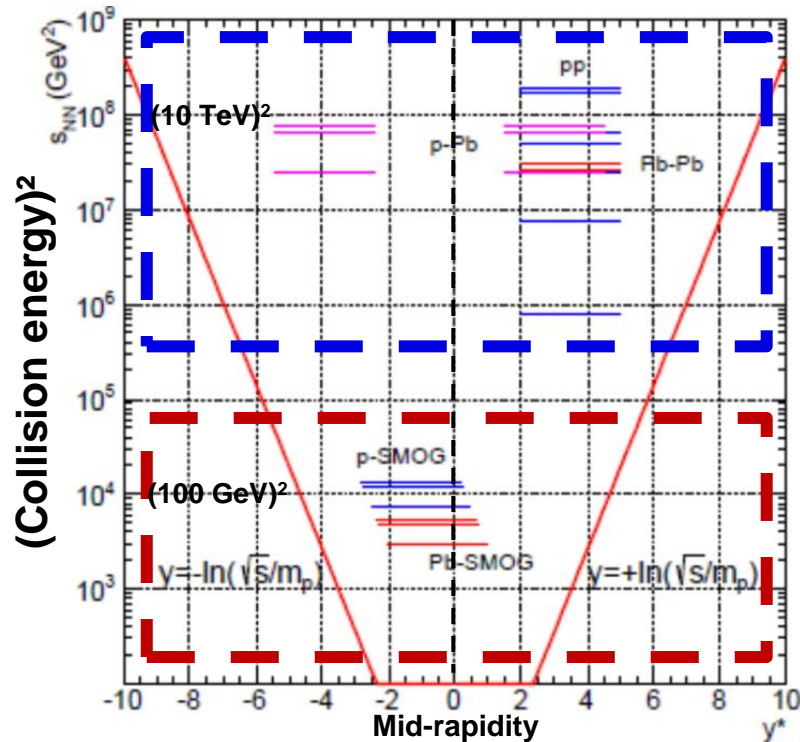

Colliding mode

$E_{beam}(p)$	pp	p-SMOG	p-Pb/Pb-p	Pb-SMOG	Pb-Pb
450 GeV	0.90 TeV				
1.38 TeV	2.76 TeV				
2.5 TeV	5 TeV	69 GeV			
3.5 TeV	7 TeV				
4.0 TeV	8 TeV	87 GeV	5. TeV	54 GeV	
6.5 TeV	13 TeV	110 GeV	8.2 TeV	69 GeV	5.02 TeV
7.0 TeV	14 TeV	115 GeV	8.8 TeV	72 GeV	5.5 TeV



Fixed-target mode

At $\sqrt{s_{NN}} = 110 \text{ GeV}$ $y^* = y_{lab} - 4.77$

Outline of this talk

1. Pb-Pb collisions at $\sqrt{s_{NN}} = 5 \text{ TeV}$
2. p-Pb collisions at $\sqrt{s_{NN}} = 5 \text{ TeV}$ and $\sqrt{s_{NN}} = 8.16 \text{ TeV}$
3. p-Ar and p-He collisions at $\sim 100 \text{ GeV}$ scale

1. Pb-Pb collisions @ $\sqrt{s_{NN}} = 5$ TeV



Event 1755501
Run 168926
Tue, 01 Dec 2015 19:40:23

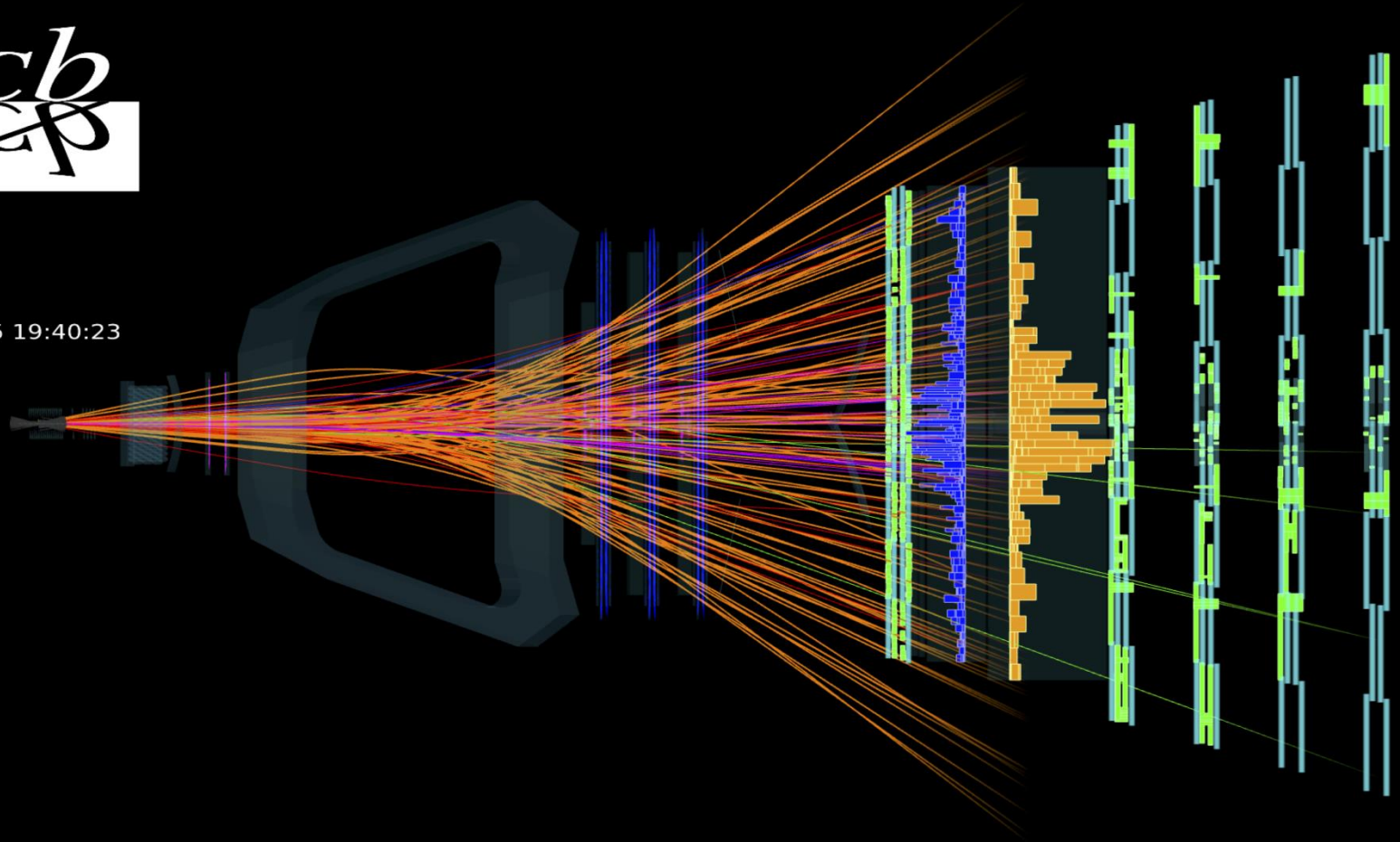

December 2015. First participation of LHCb in Pb-Pb data taking
Only 24 colliding bunches. Very small luminosity $\sim 10 \mu\text{b}^{-1}$
Minimum bias trigger configuration: all inelastic interactions recorded

1. Pb-Pb collisions @ $\sqrt{s_{NN}} = 5$ TeV

Low Ecal Energy

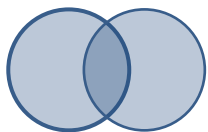

peripheral

High Ecal Energy

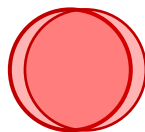

central

- **LHCb centrality reach**

- Detector limitation due to high occupancy in Pb-Pb collisions
- No saturation of the calorimeter
- But, saturation in the Vertex Locator (VELO)

- **LHCb current limitations**

- Current tracking algorithm efficient up to 50% most central
- **Physics studies limited to 50% less central events**

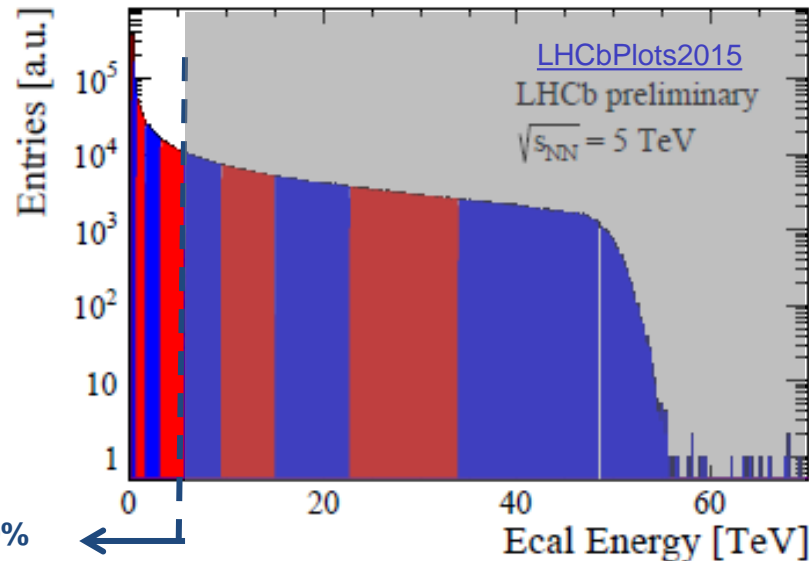

50%
less central

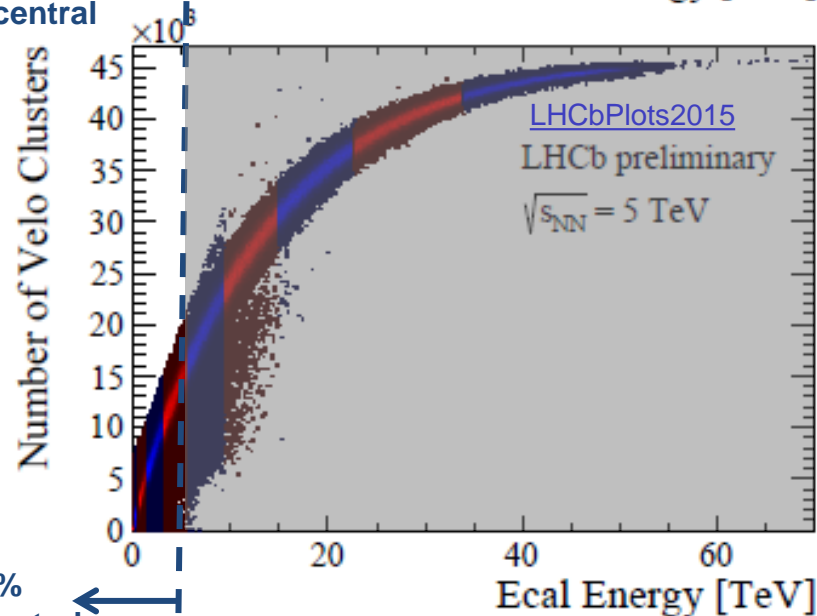

50%
less central

50% most central

$J/\psi \rightarrow \mu^+ \mu^-$ in Ultra-Peripheral Collisions

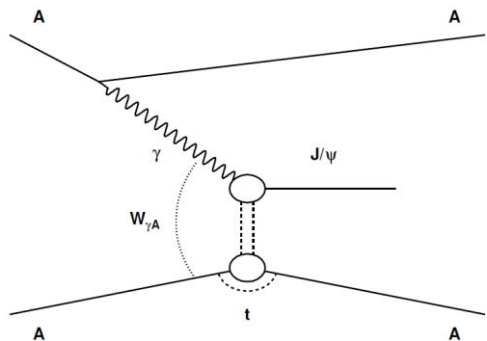

One ion interacts with the electromagnetic field of the other : coherent J/ψ photo-production
 Sensitive to nPDF, saturation, ...

$$\sigma_{J/\psi}^{\text{coherent}} = 5.27 \pm 0.21 \pm 0.49 \pm 0.68 \text{ mb}$$

(stat.) (syst.) (lumi.)

LHCb-CONF-2018-003 in preparation

LHCb will participate in the 2018 PbPb run (expect $\times 10$ larger luminosity than 2015)

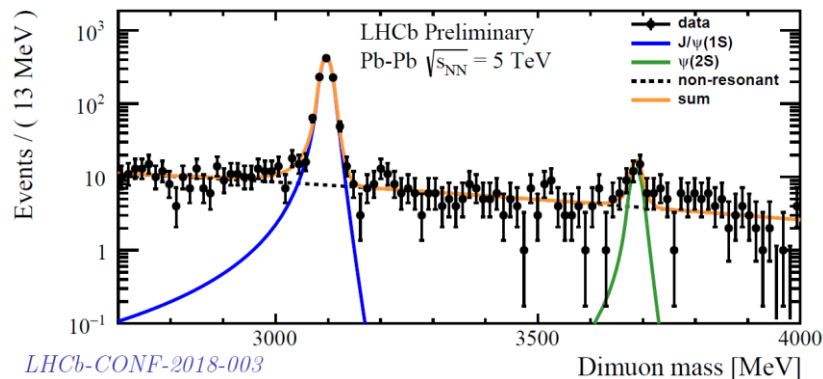

LHCb-CONF-2018-003

Nothing in the detector but two tracks

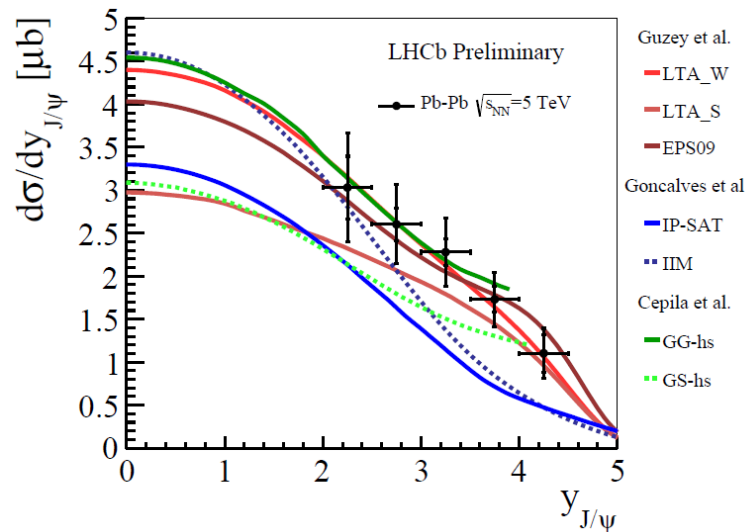

2. Proton-Pb/Pb-proton collisions



Event 351483885

Run 187340

Fri, 02 Dec 2016 20:56:29

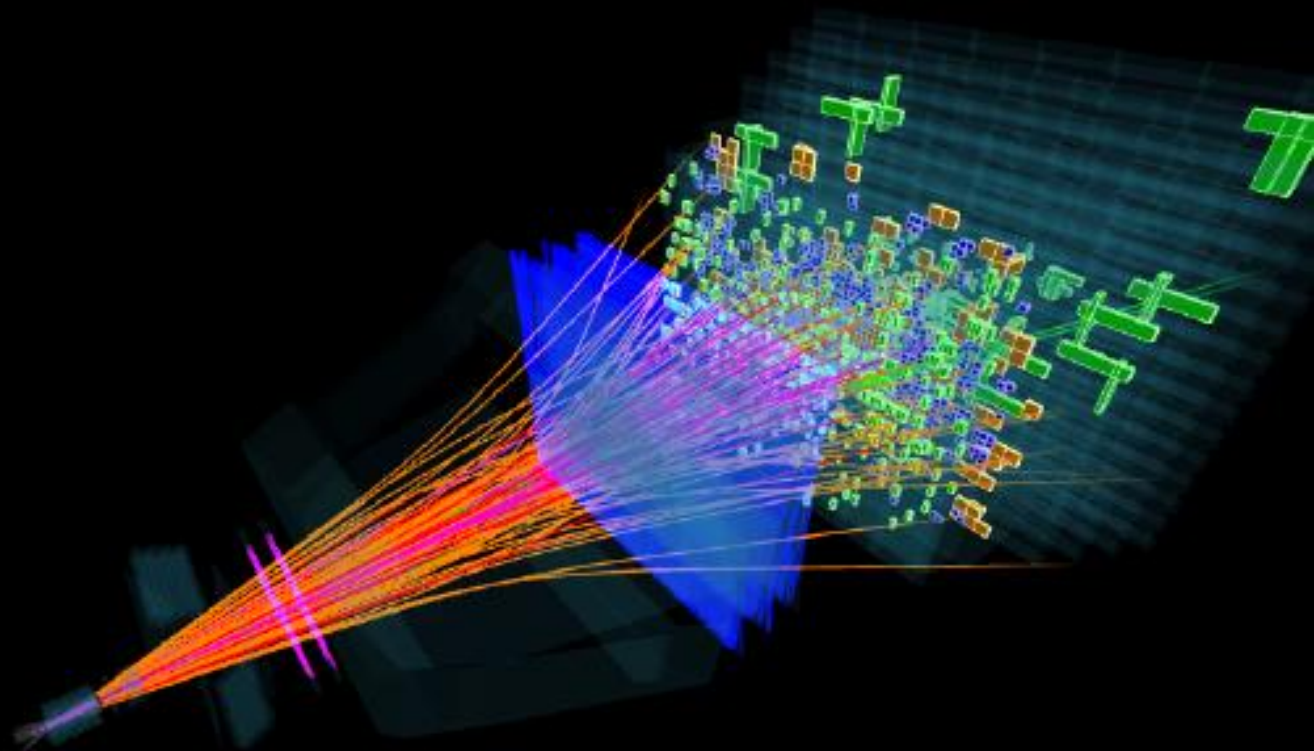

Two data sets presented here:

- $\sqrt{s_{NN}} = 5$ TeV proton-Pb interactions recorded in 2013: ~ 1.6 nb $^{-1}$
- $\sqrt{s_{NN}} = 8.16$ TeV proton-Pb interactions recorded in 2016: ~ 30 nb $^{-1}$

2. $\sqrt{s_{NN}} = 5 \text{ TeV}$ (2013) $p\text{Pb}$ collisions

- **Charm: Prompt J/ψ , $\psi(2S)$ and D^0**

- Baseline for nucleus-nucleus collisions
- Study of nuclear PDF (nPDF), coherent energy loss, gluon saturation (CGC), interaction with outgoing hadrons,...

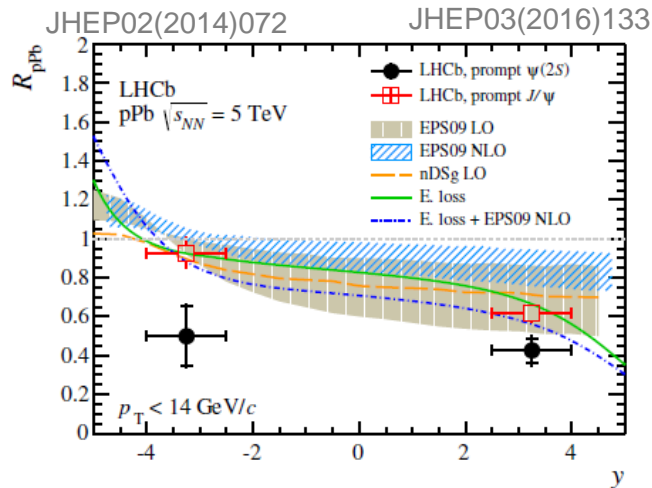

$$R_{pPb} = \frac{\sigma_{pPb}}{A_{Pb} \sigma_{pp}} = \frac{\sigma_{pPb}}{208 \sigma_{pp}}$$

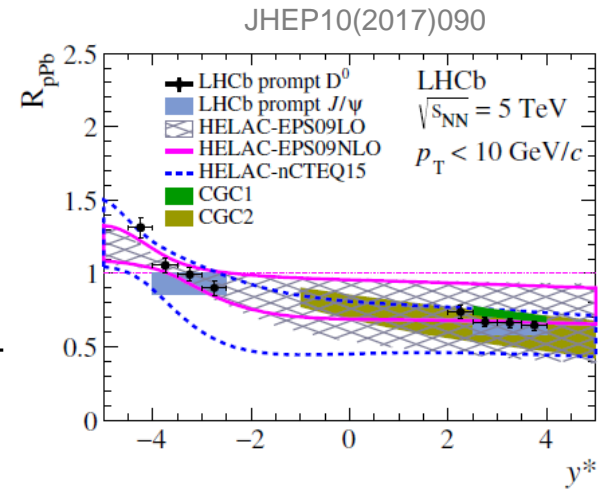

- **Forward rapidity region ($y^* > 0$) : $p\text{-Pb}$ collisions**

- **Significant J/ψ , $\psi(2S)$ and D^0 suppression with respect to $p\text{-p}$ yields**
- J/ψ and D^0 compatible with nPDF, coherent energy loss mechanism (JHEP 03 (2013) 122) and CGC (PRD 91 (2015) 114005)

- **Backward rapidity region ($y^* < 0$) : $\text{Pb-}p$ collisions**

- **J/ψ and D^0 modification compatible with theoretical expectations**
- **Strong $\psi(2S)$ suppression w.r.t. J/ψ , not compatible with nPDF and coherent energy loss.** Could be due to the interaction of the lightly-bound $\psi(2S)$ with the outgoing partons/hadrons. (*Phys. Lett. B* 749(2015)98, *Nucl.Phys. A* 943 (2015), *Phys. Rev. C* 97, 014909 (2018))

2. $\sqrt{s_{NN}} = 5$ TeV (2013) pPb collisions

- **Beauty: $\Upsilon(1S)$, non-prompt J/ψ and $\psi(2S)$**
 - Baseline for nucleus-nucleus collisions
 - Study of nuclear PDF (nPDF), coherent energy loss, gluon saturation (CGC), interaction with outgoing hadrons,...

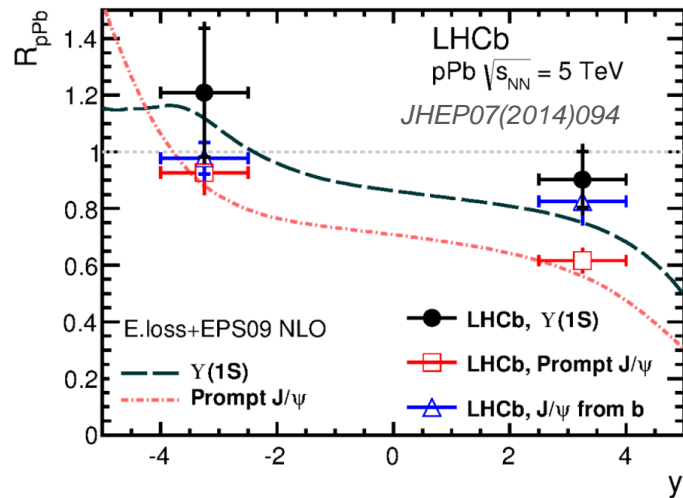

$$R_{pPb} = \frac{\sigma_{pPb}}{A_{Pb} \sigma_{pp}} = \frac{\sigma_{pPb}}{208 \sigma_{pp}}$$

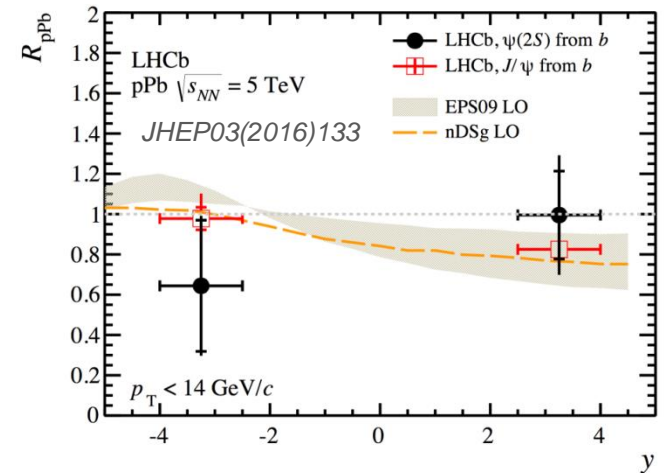

- **Forward rapidity region ($y^* > 0$) : p-Pb collisions**
 - **Little non-prompt J/ψ (J/ψ from b-hadrons) and Υ suppression**
 - compatible with nPDF and coherent energy loss mechanism
- **Backward region ($y^* < 0$) : Pb-p collisions**
 - **No significant non-prompt J/ψ (from b) and Υ modification**, compatible with expectations
 - **Large stat. uncertainty for non-prompt $\psi(2S)$ suppression**, see 2016 data.

2. $\sqrt{s_{NN}} = 8.16$ TeV (2016) pPb collisions

- **Prompt and non-prompt J/ψ**

- Baseline for nucleus-nucleus collisions
- Study of nuclear PDF (nPDF), coherent energy loss, gluon saturation (CGC), interaction with outgoing hadrons,...

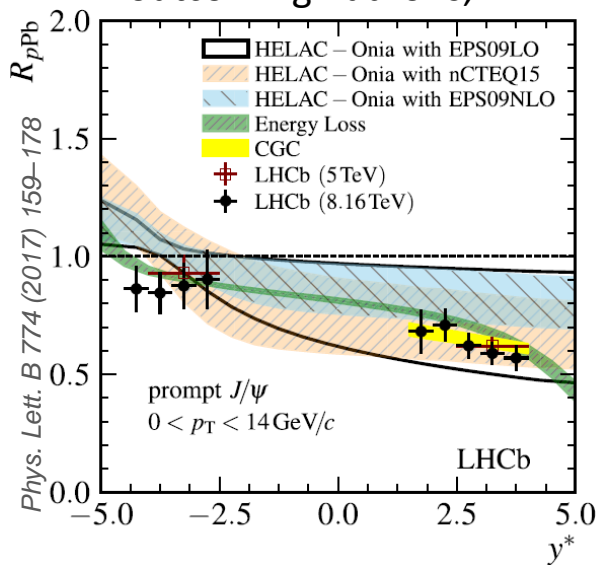

Prompt J/ψ

Non-prompt J/ψ
(J/ψ from b-hadrons)

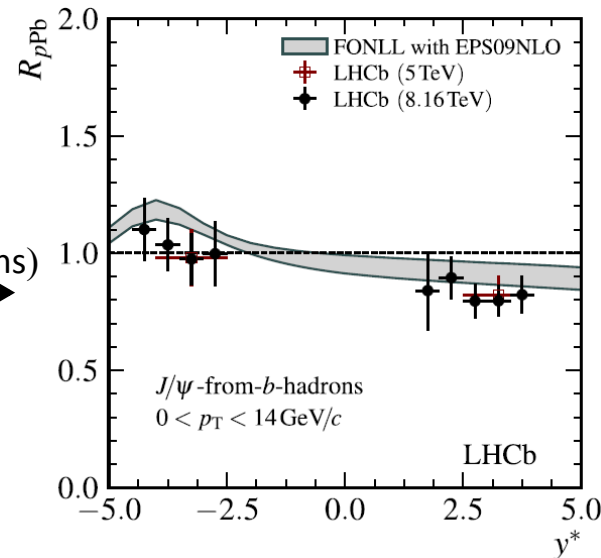

Phys. Lett. B 774 (2017) 159–178

- **Prompt and non-prompt J/ψ results compatible with lower energy data and theoretical expectations**

- **Put strong constraints on nPDF parametrizations (arXiv: 1712.07024)**

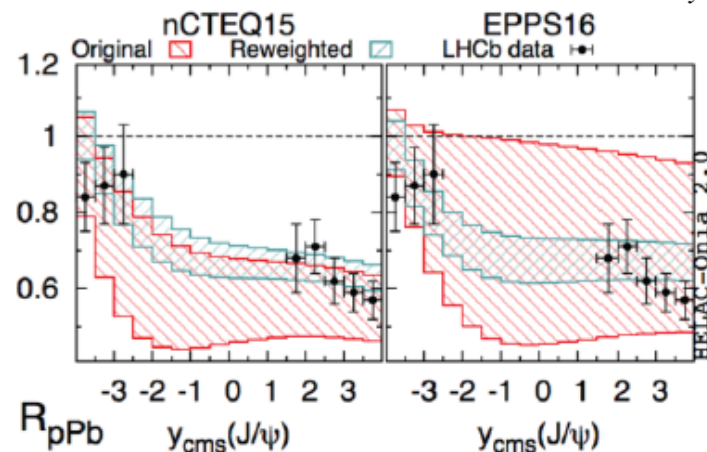

arXiv: 1712.07024

Charm baryon: prompt Λ_c production

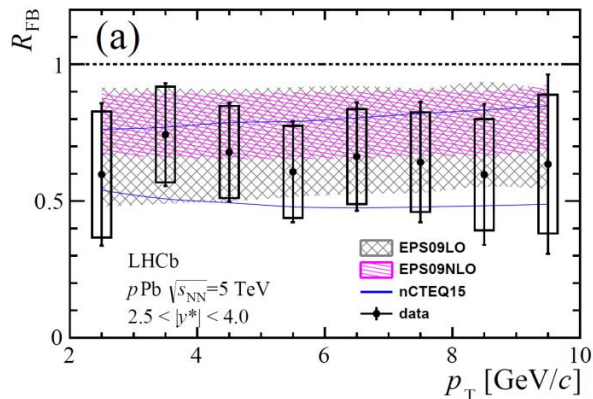

$$\text{Forward/backward ratio: } R_{FB} = \frac{\sigma(+|y^*, p_T)}{\sigma(-|y^*, p_T)}$$

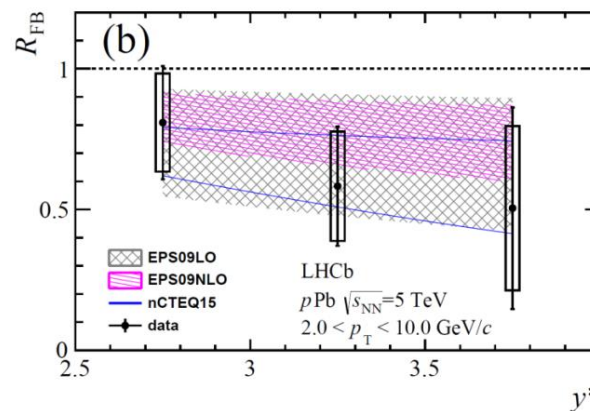

• Data are consistent with nPDF predictions

Baryon/meson: prompt Λ_c / prompt D^0

- Most of the nPDF uncertainties cancel out
- Λ_c/D^0 ratio sensitive to quark fragmentation
- Model based on measured pp cross sections

Model from Lansberg, Shao EPJ C77 (2015) 1

Forward rapidity region ($y^* > 0$): p-Pb

- Some discrepancies observed at high p_T

Backward rapidity region ($y^* < 0$): Pb-p

- Compatible with expectations

• To be improved with larger 2016 data set

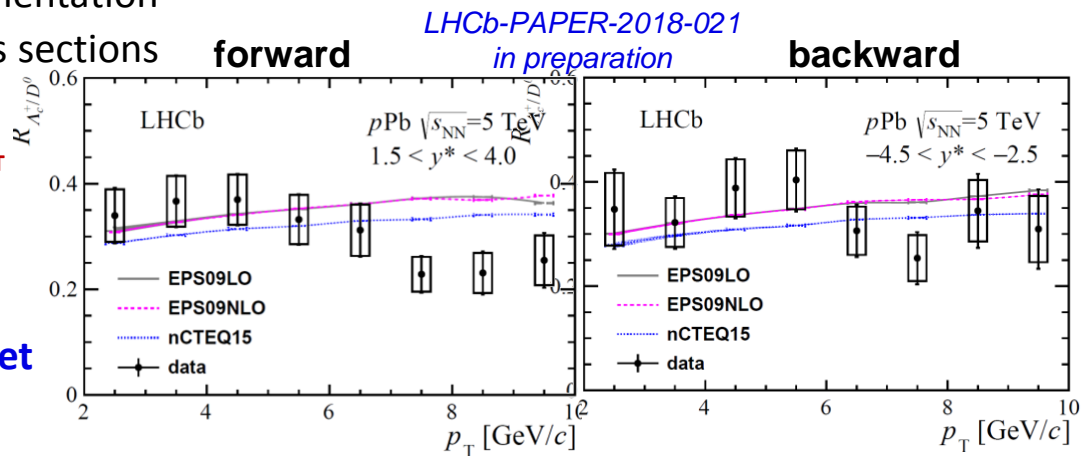

LHCb-PAPER-2018-021
in preparation

3. Fixed-target collisions

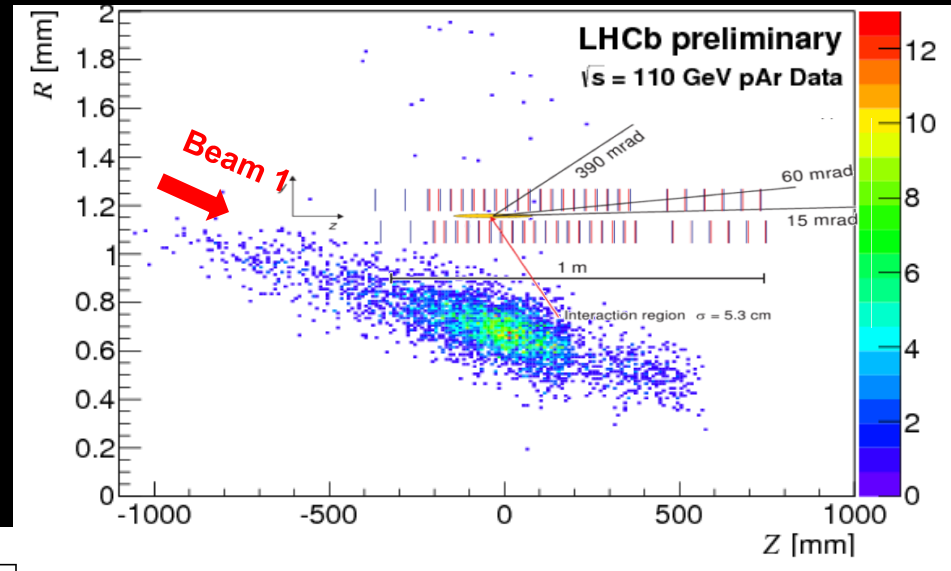

LHCb SMOG recorded data

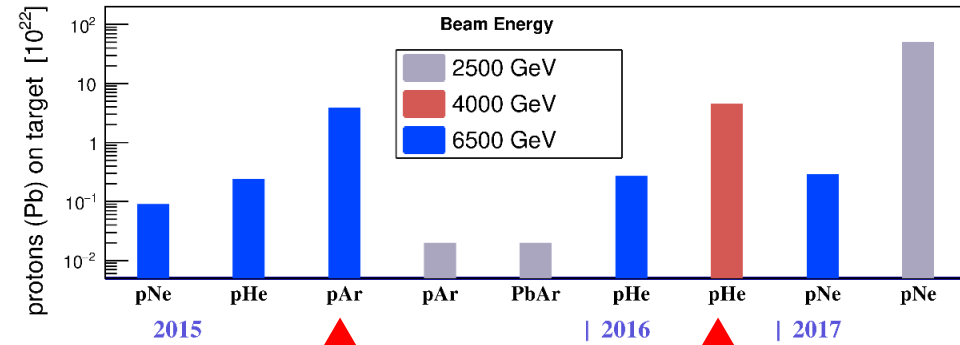

Two data sets presented here:

- $\sqrt{s_{NN}} = 110$ GeV proton-Ar interactions 2015: $\sim 4 \times 10^{22}$ Protons On Target (17h)
- $\sqrt{s_{NN}} = 86.6$ GeV proton-He interactions 2016: $\sim 4 \times 10^{22}$ POTs (87h)

$$\mathcal{L}_{pHe} = 7.6 \pm 0.5 \text{ nb}^{-1}$$

3. Charm in fixed-target proton-nucleus collisions

- **pA collisions**
 - Serve as a baseline for nucleus-nucleus collisions
 - Study of nuclear PDF (nPDF), nuclear absorption, ...
- **With LHCb-SMOG, large rapidity coverage (~ 3 rapidity units) at large Bjorken- x in the target (x_2)**
 - Give access to **nPDF anti-shadowing** region and **intrinsic charm** content in the nucleon

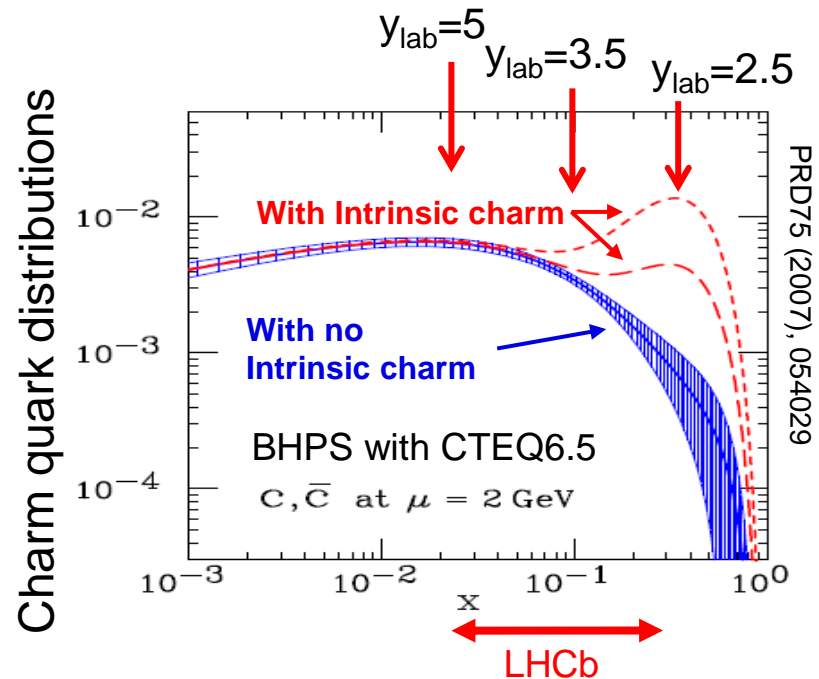
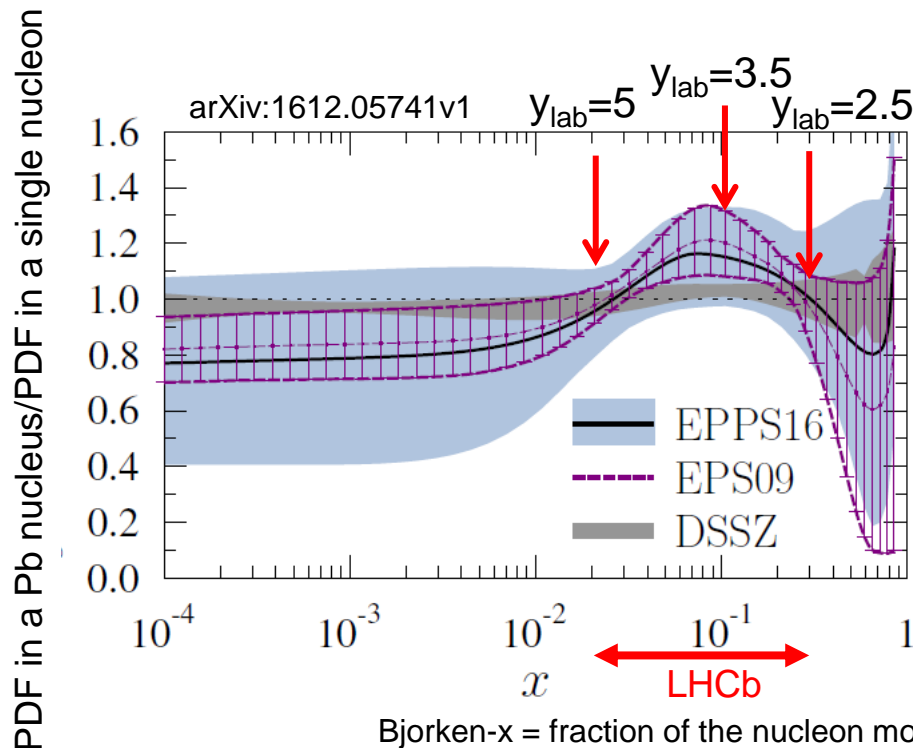

3. Charm in fixed-target proton-nucleus collisions

New results

- $J/\psi \rightarrow \mu^+\mu^-$ and $D^0 \rightarrow K^+\pi^\pm$ inclusive cross sections in pHe @86.6 GeV

LHCb-PAPER-2018-023
in preparation

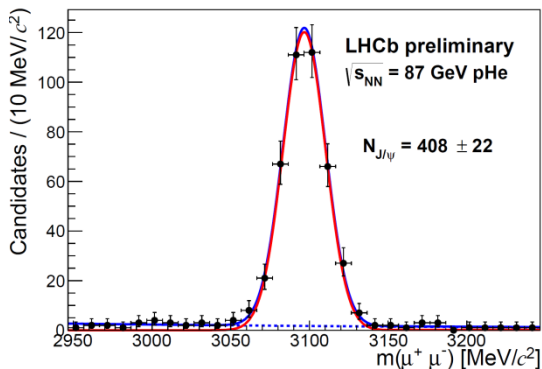

$$\sigma_{J/\psi} = 1225.6 \pm 62.0 \text{ (stat)} \pm 81.6 \text{ (syst) nb/nucleon}$$

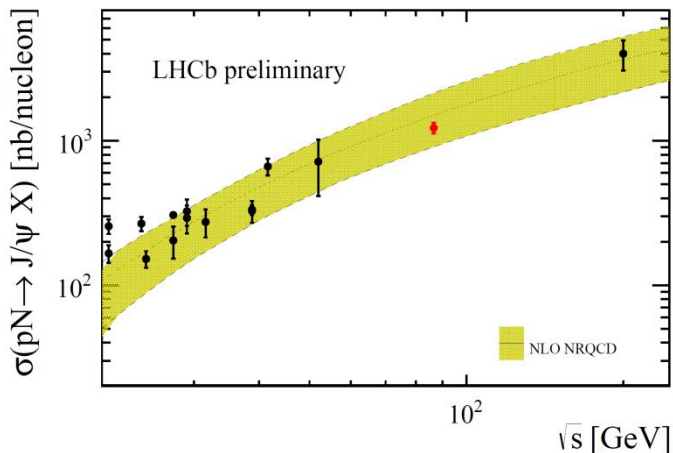

LHCb result in good agreement with NRQCD fit and other measurements

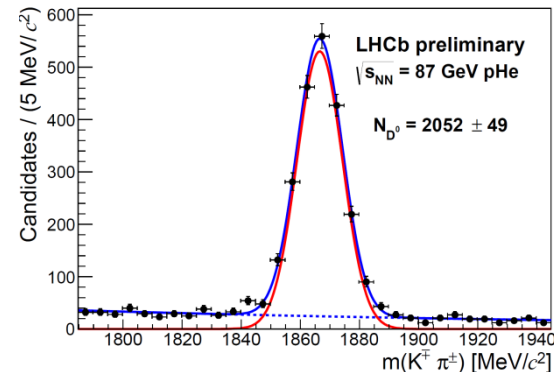

$$\sigma_{D^0} = 156.0 \pm 4.6 \text{ (stat)} \pm 12.3 \text{ (syst) } \mu\text{b/nucleon}$$

with fraction ($c \rightarrow D^0$) = 0.542 ± 0.024

$$\sigma_{c\bar{c}} = 287.8 \pm 8.5 \text{ (stat)} \pm 25.7 \text{ (syst) } \mu\text{b/nucleon}$$

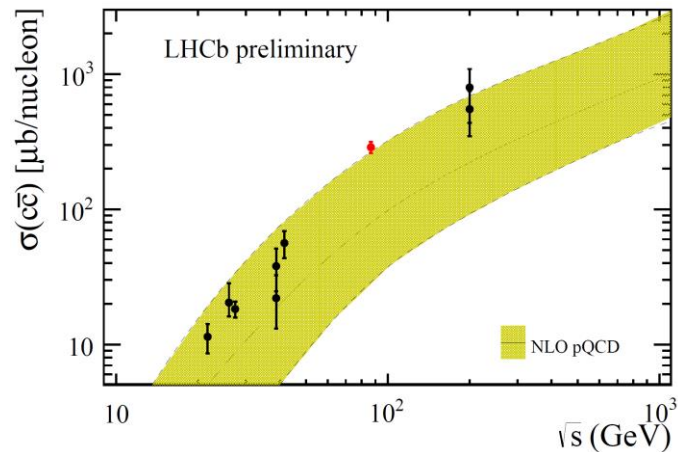

LHCb result in reasonable agreement with NLO pQCD (MNR) predictions and other measurements

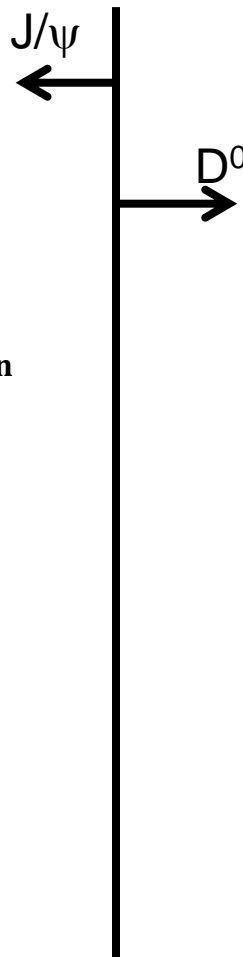

- **J/ψ Differential yields (pAr@110 GeV) and cross sections (pHe@86.6 GeV)**
 - Plain and dashed **red lines**, phenomenological parametrization: JHEP 05 (2013) 155
 - **HELAC-ONIA** predictions for pp (blue lines) and pA (yellow boxes): EPJC(2017) 77:1

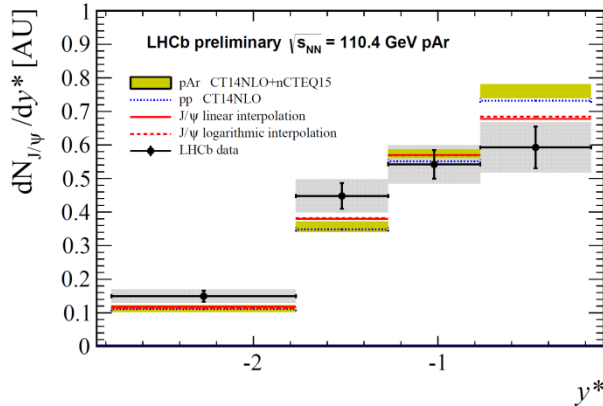

LHCb-PAPER-2018-021
in preparation

pAr @ 110 GeV
yields

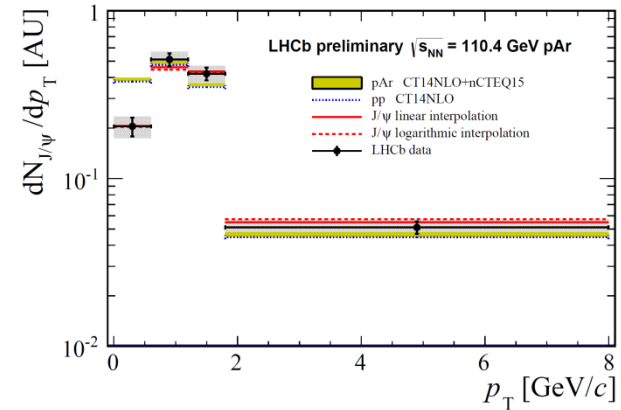

pHe @ 86.6 GeV
Cross sections

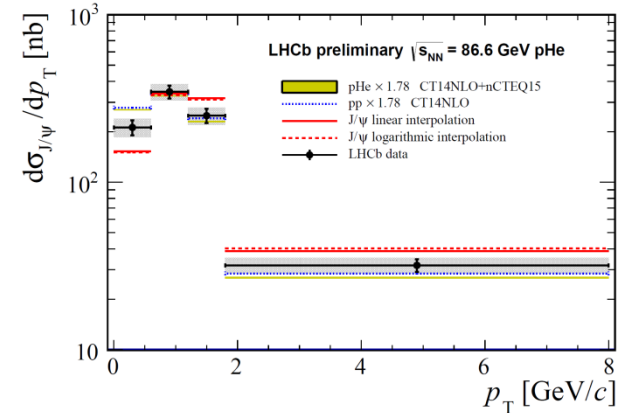
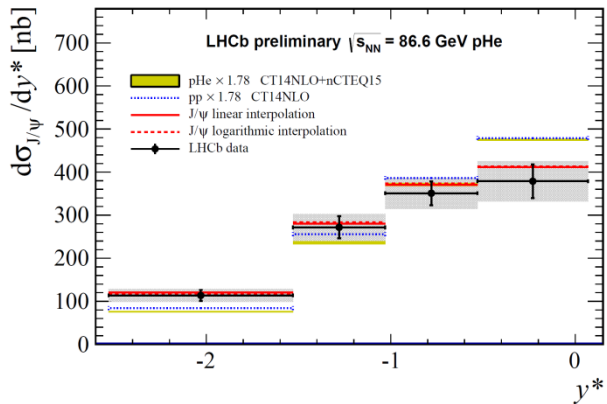

- **HELAC-ONIA under-estimate J/ψ cross section (pHe) by a factor 1.78**
- **Good shape agreement with phenomenological predictions**

- **D⁰ Differential yields (pAr@110 GeV) and cross sections (pHe@86.6 GeV)**
 - HELAC-ONIA predictions for pp (blue lines) and pA (yellow boxes): EPJC(2017) 77:1

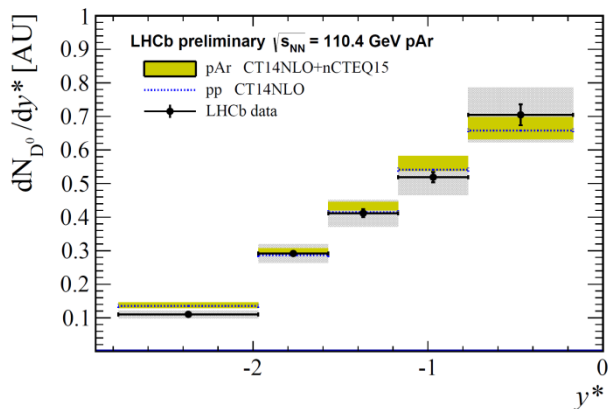

LHCb-PAPER-2018-021
in preparation

pAr @ 110 GeV
yields

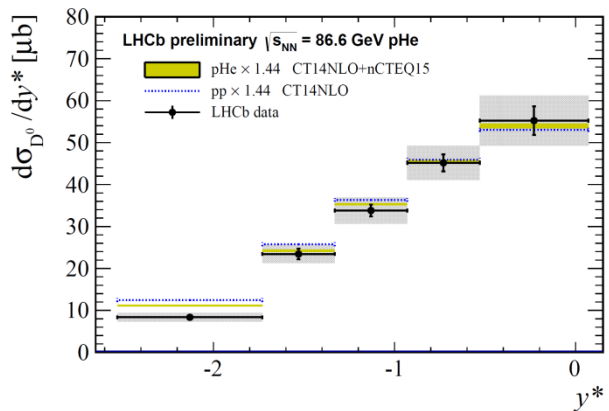
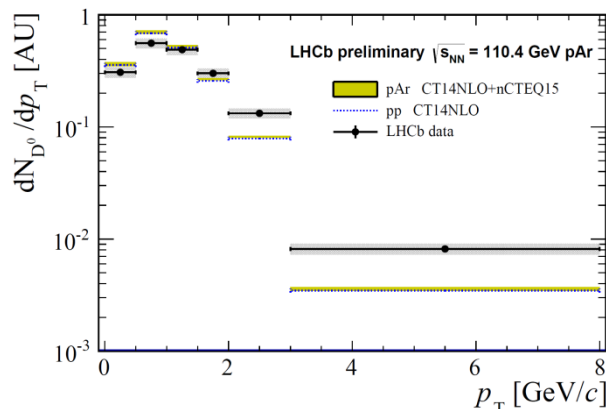

pHe @ 86.6 GeV
Cross sections

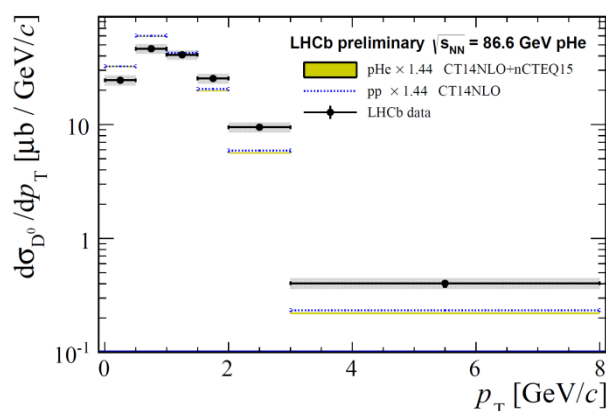

- HELAC-ONIA under-estimate D⁰ cross section (pHe) by a factor 1.44
- Good agreement in rapidity shapes between data and predictions

3. Charm in Fixed-target proton-nucleus collisions

New results

LHCb-PAPER-2018-021
in preparation

- **D⁰ cross sections (pHe@86.6 GeV) .vs. Intrinsic charm**
 - HELAC-ONIA predictions for pp (blue lines) and pA (yellow boxes): EPJC(2017) 77:1

– With $x_2 \simeq \frac{2 \times m_c}{\sqrt{s_{NN}}} \exp(-y^*)$ $y^* \in [-1.73, -2.53] \Leftrightarrow x_2 \in [0.17, 0.37]$

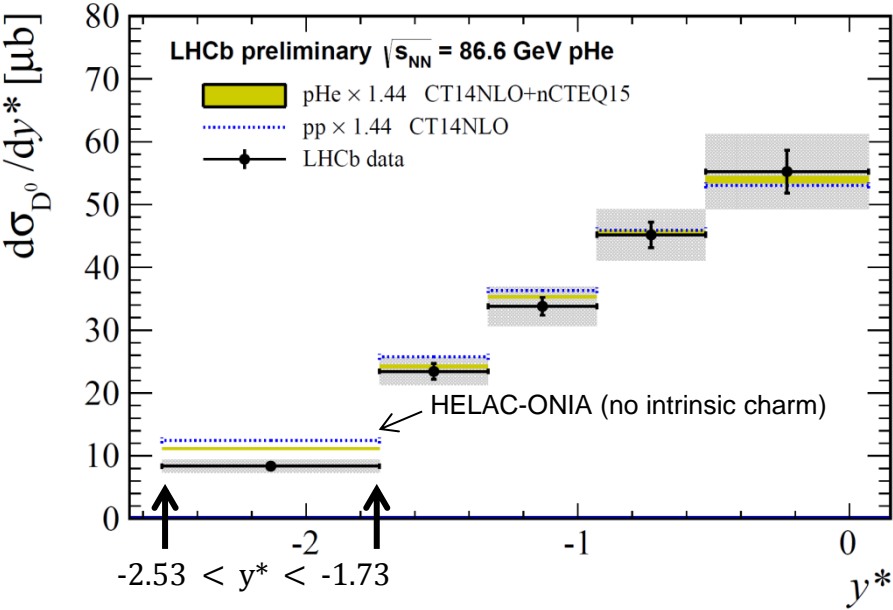
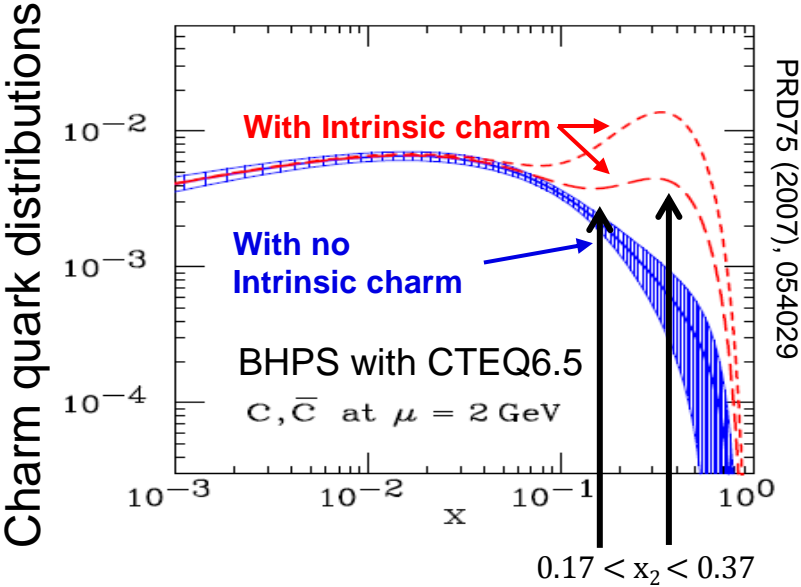

- HELAC-ONIA does not contain intrinsic charm contribution
- No evidence of strong intrinsic charm contribution

- **The LHCb detector**
 - has unique capabilities for heavy flavor measurements at LHC
 - Currently **limited to peripheral collisions in Pb-Pb**, but **full performances in p-Pb collisions**
 - Can operate a **fixed-target program**, unique at LHC

- **Current results**
 - Demonstrate **capabilities to run in Pb-Pb** collisions

 - Performed **prompt J/ψ , $\psi(2S)$, D^0** and **non-prompt J/ψ** and **Y** measurements in **$\sqrt{s_{NN}} = 5 \text{ TeV p-Pb}$** collisions
 - *J/ψ , D^0 and Y measurements compatible with theoretical expectations*
 - *Strong backward-rapidity $\psi(2S)$ suppression, maybe due to interactions with outgoing partons/hadrons.*

 - Performed prompt and non-prompt **J/ψ** measurements in **$\sqrt{s_{NN}} = 8.16 \text{ TeV p-Pb}$** collisions
 - *Compatible with lower energy data and theoretical expectations*

 - Performed **prompt Λ_c** measurements in **$\sqrt{s_{NN}} = 5 \text{ TeV p-Pb}$** collisions
 - *Λ_c / D^0 ratio shows possible discrepancy with models at forward rapidity and high p_T*

 - Performed **J/ψ and D^0** measurements in **$\sqrt{s_{NN}} = 110 \text{ GeV p-Ar}$** and **$\sqrt{s_{NN}} = 86.6 \text{ GeV p-He}$** collisions
 - *No evidence of strong intrinsic charm contribution*

- **Still to come**
 - $\psi(2S)$ in p -Pb at $\sqrt{s_{NN}} = 8$ TeV
 - $Y(1S), Y(2S), Y(3S)$ in p -Pb at $\sqrt{s_{NN}} = 8$ TeV
 - D^0, D^\pm, Λ_c^+ in p -Pb at $\sqrt{s_{NN}} = 8$ TeV
 - B^0, B^\pm, Λ_b in p -Pb at $\sqrt{s_{NN}} = 8$ TeV
 - charm production ($J/\psi, \psi', \chi_c, D^0, \Lambda_c, \dots$) in pNe @ 69 GeV fixed-target
 - **LHCb will participate to the 2018 Pb run:**
 - **x10 lumi. in 5 TeV PbPb collisions**
 - **PbNe @ 69 GeV fixed-target**

- **L'upgrade SMOG2**

- R&D en cours
- NIKHEF, INFN-Ferrara, INFN-Frascati

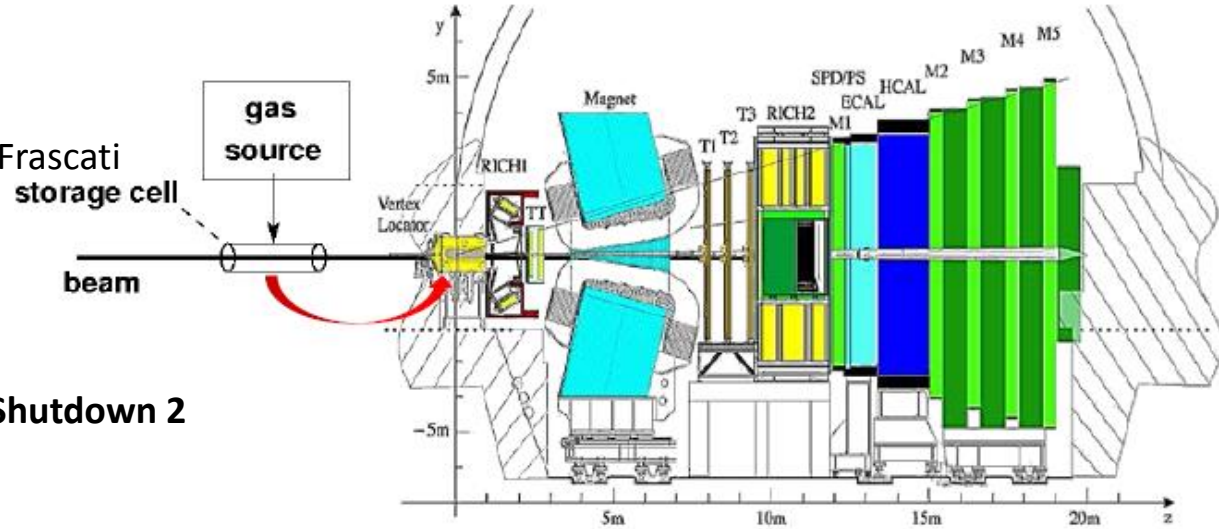

- **Upgrade de LHCb pendant Long Shutdown 2 (LS2: 2 ans, fin 2018)**

- Remplacement du VELO
 - Strips → pixels
- Installation d'une storage cell
 - Diamètre = 1cm, longueur = 20 cm
 - Placée en amont du VELO (-50 à -30 cm par rapport à IP)
 - Augmentation de la densité locale de gaz jusqu'à un facteur 100
 - Augmentation de la luminosité jusqu'à un facteur 100 par rapport à SMOG

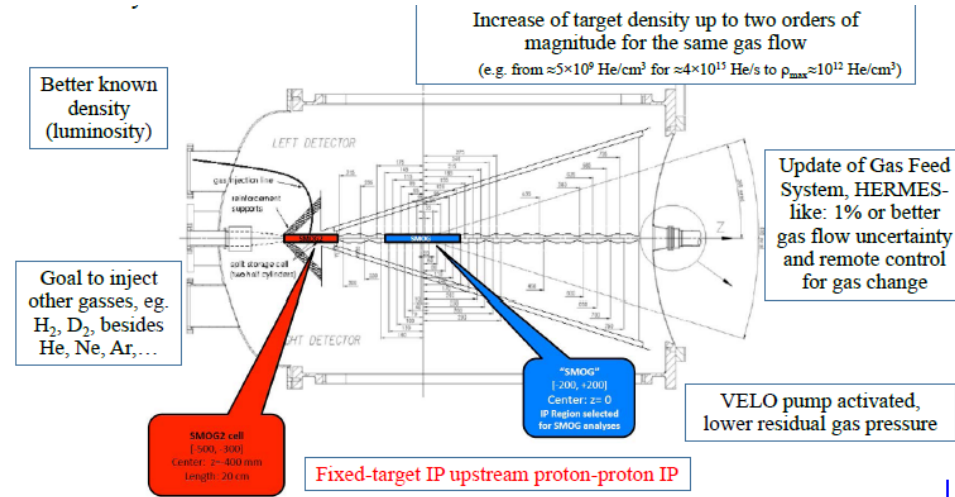

Futur – moyen terme (2021 – 2025)

- SMOG2: R&D on storage cell at NIKHEF, INFN-Ferrara, INFN-Frascati

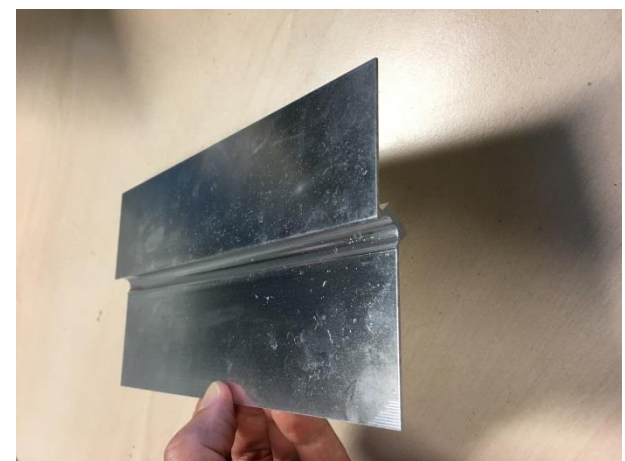
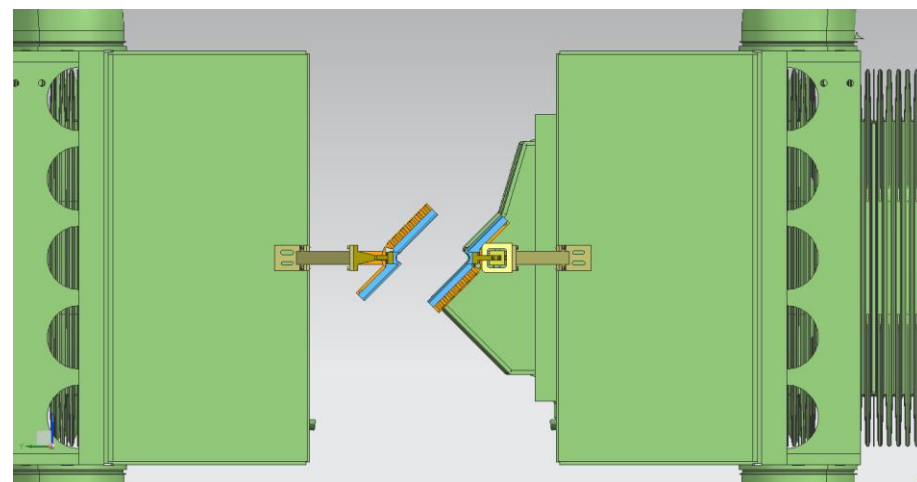
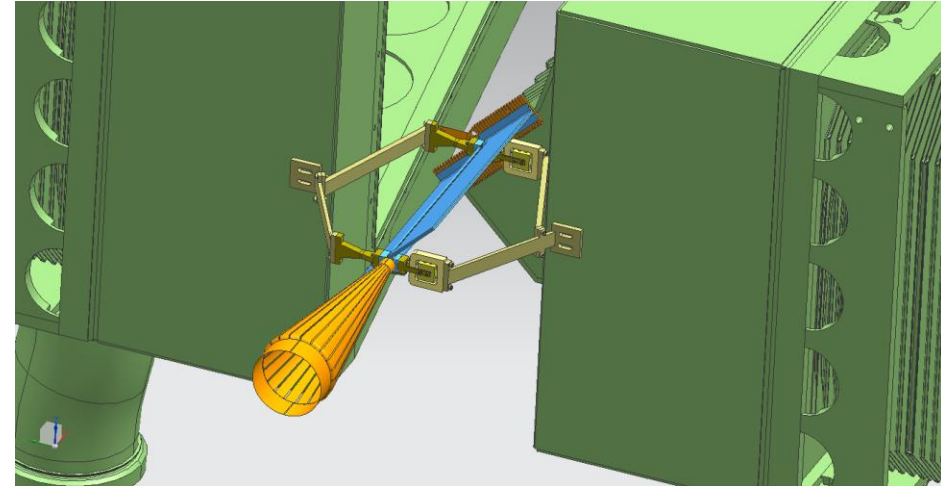
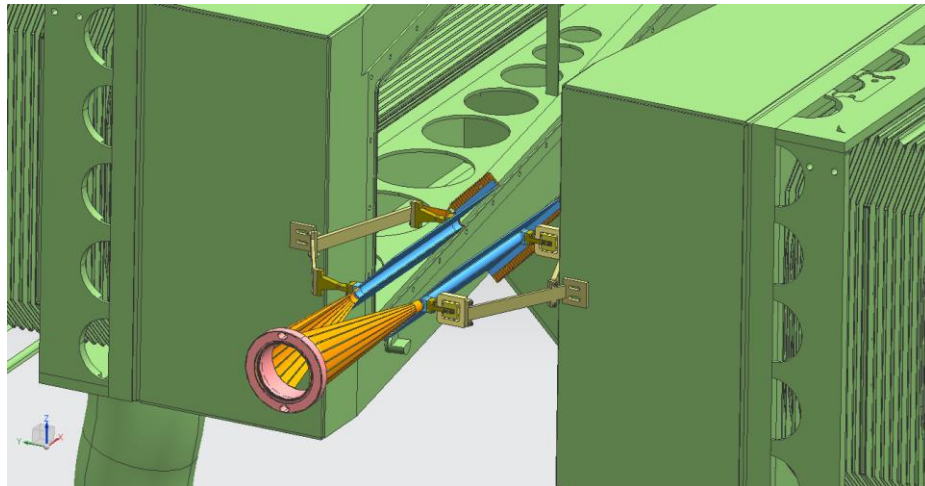

• SMOG2 - performances

Beware: SMOG2 approval still pending.
Assumed numbers below are guesstimates,
not approved by LHCb

pH @ 115 GeV $\sim 10/\text{pb}$
pD @ 115 GeV $\sim 10/\text{pb}$
pAr @ 115 GeV $\sim 10/\text{pb}$

PbAr @ 72 GeV $\sim 5/\text{nb}$
pAr @ 72 GeV $\sim 1/\text{pb}$

	Current SMOG result pHe@86 GeV	SMOG largest sample pNe@68 GeV	SMOG2 example pAr@115 GeV
Int. Lumi.	7.6/nb	$\sim 100/\text{nb}$	$\sim 10/\text{pb}$
syst. error on J/ψ x-sec.	7%	6 - 7%	3 - 4 %
J/ψ yield	400	15k	3.5M
D^0 yield	2000	100k	35M
Λ_c yield	20	1k	350k
ψ' yield	negl.	150	35k
$\Upsilon(1S)$ yield	negl.	10	3k
DY $\mu^+\mu^-$ yield ($5 < M < 9$ GeV)	negl.	10	3k

Notes:

- list is far from being exhaustive;
- extrapolations are crude estimates, just to provide figures of merit;
- assuming quarkonium absorption by the nuclear target leading to a decrease of its cross section by a factor 0.75 (0.6) in pNe and 0.5 (0.4) in pAr for J/ψ (ψ') with respect to pHe.
- the smaller systematic uncertainty with SMOG2 is expected from the reduction of the dominant uncertainty on the luminosity (6%) for SMOG data .

Slides taken from G. Graziani – PBC working group meeting CERN – 13 – 14 juin 2018

https://indico.cern.ch/event/706741/contributions/2938767/attachments/1668174/2675082/LHCb_PBC180614.pdf