

Electrodynamics of the vortex lattice in untwinned YBaCuO by complex impedance measurements

A. Pautrat^{1,a}, A. Daignere¹, C. Goupil¹, Ch. Simon¹, B. Andrzejewski², A.I. Rykov³, and S. Tajima³

¹ CRISMAT/ISMRA^b, boulevard du Maréchal Juin, 14050 Caen Cédex, France

² Institute of molecular physics, Smoluchowskiego 17, Poznan, Poland

³ Superconductivity Research Laboratory, ISTEC, Tokyo 135, Japan

Received 22 November 2002 / Received in final form 17 February 2003

Published online 20 June 2003 – © EDP Sciences, Società Italiana di Fisica, Springer-Verlag 2003

Abstract. We report complex impedance measurements in an untwinned YBaCuO crystal. Our broad frequency range covers both the quasi static response and the resistive response of the vortex lattice. It allows us to characterize the irreversibility line without the need of any frequency dependent pinning parameters. We confirm the validity of the two modes model of vortex dynamic, and extract both the surface critical current and the flux flow resistivity around the first order transition T_m . This latter is identified by the abrupt loss of pinning and by an unexpected step of $\rho_{ff}(T)$ at T_m .

PACS. 74.72.Bk Y-based cuprates – 74.60.Ge Flux pinning, flux creep, and flux-line lattice dynamics – 74.25.Nf Response to electromagnetic fields (nuclear magnetic resonance, surface impedance, etc.)

The dynamic response of a vortex lattice is mainly determined by the critical current I_c and by the flux flow resistivity ρ_{ff} . The classical method used to measure these values is to pass a transport current in the superconducting sample and to measure the voltage V generated by the vortex lattice flow. A critical current can be extracted by extrapolating the linear part of this $V(I)$ curve down to $V = 0$, and the flux flow resistance is given by the slope of this linear part. This simple and powerful method is unfortunately not applicable for high T_c materials, due to the high critical current in the pinned vortex state, and to the corresponding heating due to Joule effect in the contact leads. Another way to proceed is to measure the high frequency skin depth of the complex penetration [1]. This response has been first observed by Gittleman and Rosenblum, who noticed that the linear high frequency response of a pinned vortex lattice mimics the ideal response of a free vortex lattice (the viscous force becomes greater than the “pinning force” at high frequencies) [2]. On the contrary, the low frequency regime is linked to the critical current *via* the quasi static regime (the “Campbell” regime) where the penetration λ_{ac} is purely real (inductive response) as in the Meissner state [3]. Between these two regimes, the frequency spectrum around the depinning frequency Ω_p is the quantity of interest for discriminating between different types of pinning state (bulk or surface) [4]. Therefore, the frequency response of the vortex lattice allows investigation of the inductive and the

resistive regimes. It is a powerful method to characterize both pinned and depinned vortex states. A small ac field is used as a probe, and one detects the vortex response in the form of a susceptibility, surface impedance or resistivity. HT_c materials have been extensively studied by these different ac techniques, but it is quite difficult to draw an unique picture. Ac susceptibility focuses mainly on the so called loss peak (χ'' peak) and on its frequency dependence. After strong controversy about its significance (onset of superconductivity [5], melting transition [6], depinning transition [7]...), other interpretations deal with the finite size effect of a resistivity driven by thermal depinning [8,9]. On the other hand, strong contradictions exist between the resistivity values and the expected geometrical frequencies [8], which raise questions about this theoretical treatment of vortex dynamics.

Among other cuprates, the case of untwinned YBaCuO is of particular interest. It is now obtained with a large enough size to avoid spurious size effects which may obscure experimental signatures contained in the full spectrum of the depinning transition. Moreover, thermodynamical evidence of a first order transition separating a pinned vortex state and a depinned vortex state have appeared recently [10]. This transition is usually interpreted as the melting of a Bragg-Glass phase into a liquid phase without pinning [11]. By analogy with real crystals, thermally induced displacements of bulk pinned vortices added to a Lindemann criterion are the key elements of this transition. Nevertheless, the properties of these two phases are not so well known. In particular, it is usually assumed that vortex lattice pinning and dynamics are quite different in

^a e-mail: alain.pautrat@ismra.fr

^b UMR 6508 associée au CNRS

high T_c materials compared to what is currently observed in low T_c 's. To evidence peculiarities of vortex dynamics in HT_c materials, one has to perform experiments, the analysis of which successfully applies in conventional superconductors. As an example, high temperatures should lead to strong thermally activated behaviour, which is supposed to be reflected in pinning properties, leading to dominant thermally driven depinning. In such a case, the ac response should be quite different from what is observed in the samples where thermal activation was shown to be negligible for vortex depinning [12].

In this paper, we present a study of vortex lattice depinning in an untwinned YBaCuO crystal by means of complex surface impedance measurements. Due to the important role of skin effects, we express this impedance in the form of a complex penetration depth. If the measurements of these complex penetration depths *versus* temperature looks quite complicated to interpret, due to frequency dependent features, we show that a study of the depinning spectrum leads to a simpler picture of a surface pinned vortex lattice with a bulk free flow resistivity, as it is observed in several conventional low T_c superconductors [4]. Nevertheless, the data exhibit two important differences. We observe the well known disappearance of the critical current at $T_m < T_{B,c2}$, but this disappearance is simultaneous with a less expected step in the temperature dependence of ρ_{ff} .

The sample is an untwinned crystal of $\text{YBa}_2\text{Cu}_3\text{O}_{7-\delta}$ ($\ell_a = L = 600, \ell_b = 3000, \ell_c = 1000$) μm^3 , the preparation of which was detailed in reference [13]. The post annealing procedure and the high T_c of 93.5 K corresponds to the optimally doped state with $\delta = 0.07$ in the Lindemer scale. Normal state resistivity ρ_b has been measured using standard four probe techniques and gives a value of about $40 \mu\Omega\text{cm}$ at 100 K. Both this low value and the high T_c attest to the good quality of the sample, as do the observed magnetization step at the first order transition [14]. The main part of the experimental set up consists of a waveform generator (DS345) and two lock-in amplifiers (SR850 and SR844), so as to cover a frequency range of about $30 \text{ Hz} = 30 \text{ MHz}$. The ac response is the flux taken by a small pick-up coil, directly glued to the sample, which reposes, itself, in the excitation coil. We have carefully checked that the applied alternative field $b_{ac} = b_o \exp(-i\Omega t)$ has a low enough magnitude ($\approx 1 \mu T$) to stay in the linear regime. The complex penetration depth is then given by $\lambda_{ac} = \phi_{ac}/2\ell_b b_o = \lambda' + i\lambda''$ (Fig. 1). The whole set up drives to an experimental resolution of few microns, and hence the London penetration can be easily neglected. Therefore, the calibration of the phase and of the zero of penetration have been done using the Meissner state as a reference ($\lambda' = \lambda'' = 0$). For the highest frequency points, we have renormalized the signal using a small reference coil near the sample (when high frequencies and circuitry began to cause phase shifts). The complete penetration has been measured in the normal state at 100 K and at low frequency and the resistivity value has been confirmed by a skin effect fit which gave a value of $\rho_b \approx 40.5 \mu\Omega\text{cm}$. As the theoretical models

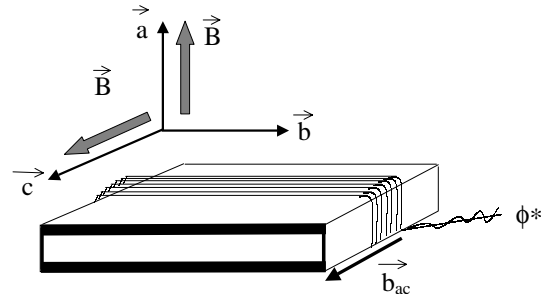

Fig. 1. Geometry of the experiment. The quantity of interest is the measured flux $\phi_{ac} = \int b_{ac} dS \approx 2\lambda_{ac}\ell_b b_o$ in a 1D approximation.

of interest are one dimensional in the simplest case, one has to choose a geometry which is as close as possible to a 1D penetration (Fig. 1). b_{ac} is applied along the c -axis and the flux is measured through the (\vec{a}, \vec{b}) surface. Most of the data were taken in the geometry $\vec{B} \parallel \vec{a}$. In this case, the currents are mainly confined in the (\vec{b}, \vec{c}) surfaces. This is specially true at high frequencies which restrict the penetration of the resistive wave in a thin layer. Vortices are shaken on the (\vec{b}, \vec{c}) surface and the wave penetrates along the \vec{a} direction. In the mixed state, there is also an anisotropy induced by the Josephson relation ($\vec{E} = -\vec{V}_L \wedge \vec{\omega}$) so the electric field $\parallel \vec{j}_b$ is perpendicular to the vortex field $\vec{\omega}$). The small part of the current along the \vec{a} direction (along the vortices) can thus be neglected. To confirm the main conclusion of this study, a few measurements have been taken with $\vec{B} \parallel \vec{c}$. Even if this geometry does not allow as many quantitative results, because of the problems of the closing currents along the \vec{a} direction which are now perpendicular to vortices, the results were typically the same. The data presented here were taken at a magnetic field of 6 T.

Before discussing the experimental results, we have to recall the main features of the linear response of a vortex lattice. At high frequencies $\Omega \gg \Omega_p$, all the models of ac response predict the response of a resistive medium: $\lambda_{ac} = \lambda_{bulk} = \lambda_{ff} = \frac{(1+i)\delta_{ff}}{2}$, where $\delta_{ff} = \sqrt{\frac{2\rho_{ff}}{\mu_o\Omega}}$ is the usual flux-flow skin depth. A review of the ac response of bulk pinned vortices can be found in the reference [15]. The main idea is that the bulk pinning response is governed by a modified skin depth equation with one mode. In the simplest case, this leads to $K_{bulk} = (\lambda_c + \frac{\delta_{ff}}{2i})^{-1}$ [3], ($\lambda_c = \sqrt{\frac{B^2}{\mu_o}}\alpha_{Lo}$ is the Campbell length and α_{Lo} the Labusch parameter). The thermal activation is taken into account when rewriting α_{Lo} as $\alpha_L = \alpha_{Lo} \frac{i\Omega}{1+i\Omega\tau}$ where $\tau = \tau_o \exp(\frac{U}{kT})$ is the creep relaxation time [15–17]. It is formally equivalent to introducing a low frequency skin effect governed by an activated resistivity $\rho_{ff} \exp(-\frac{U}{kT})$. Bulk pinning models with thermal activation predicts so two depinning frequency, $\Omega_p = \frac{\rho_{ff}}{\mu_o\lambda_c^2}$ and $\tilde{\Omega}_p = \Omega_p \exp(-\frac{U}{kT})$. The low frequency response ($\Omega \rightarrow 0$) must follow the law $\lambda_{ac} \propto \Omega^{-\frac{1}{2}}$ (resistive response). The ac frequency

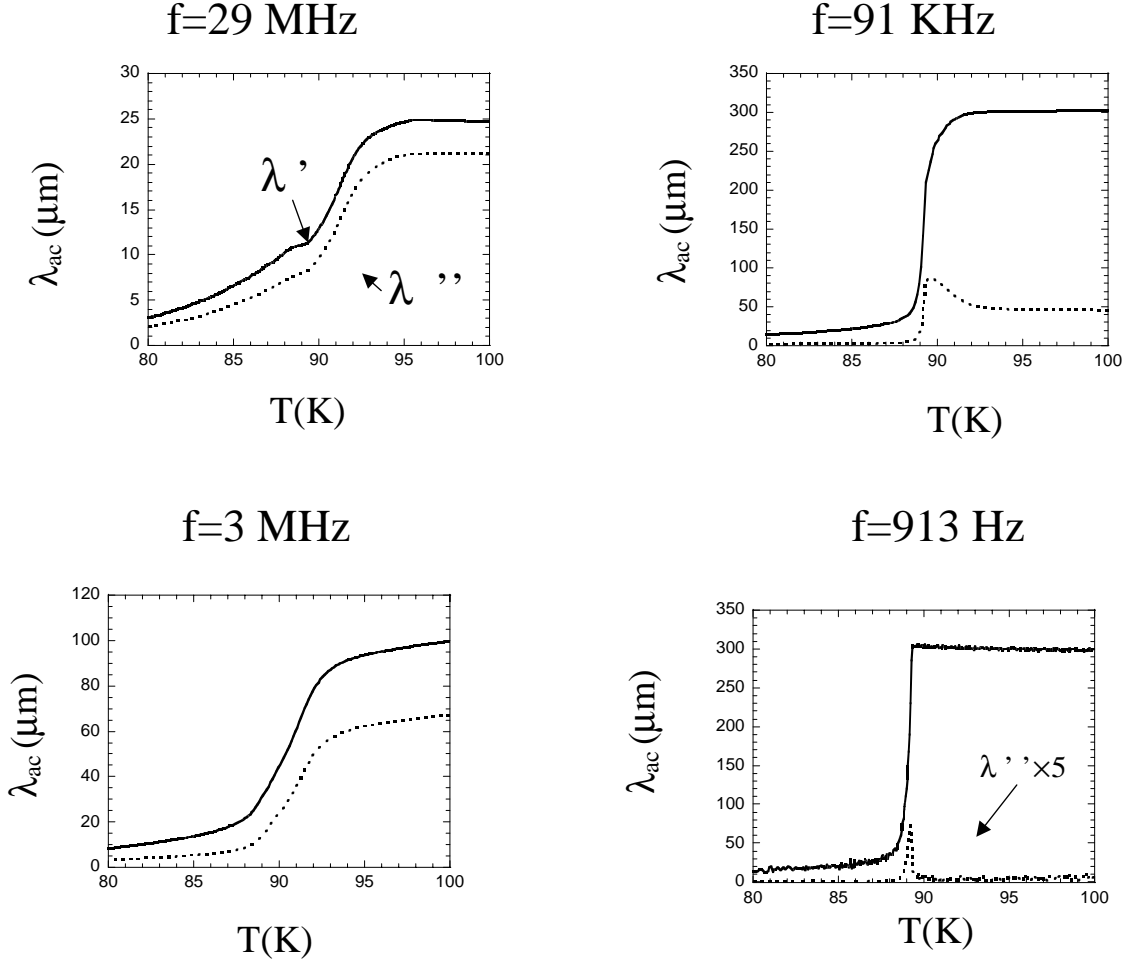

Fig. 2. λ_{ac} as function of the temperature for a fixed field ($\vec{B} \parallel \vec{a}$) = 6 T (λ' in full lines, λ'' in dotted lines). Note the change of scale of penetration length for the different frequencies. One can evidence both the inductive transition (low frequency, $\arctan \frac{\lambda''}{\lambda'} \approx 0^\circ$ in the pinned state, full penetration in the depinned state) which probes the pinning response, and the quasi-resistive response (high frequency, $\arctan \frac{\lambda''}{\lambda'} \approx \pi/4$).

spectrum should allow the extraction of the Boltzman like factor $\exp -(\frac{U}{kT})$. We emphasize that this kind of resistive response is at odds with the response in a Campbell-like regime $\lambda_{ac} \simeq \lambda' \simeq \text{const.}$ (inductive response) and is easily identifiable if one measures the phase of λ_{ac} .

It was also shown, both theoretically [18,19] and experimentally [4], that, taking into account vortex elasticity and appropriate boundary conditions for vortex lines, a non dissipative penetration mode $k_{surf} = \frac{i}{\lambda_{surf}}$ adds in the dispersion equation. This mode has a short spatial scale but, as shown in reference [20], allows for strong curvature of vortex lines. This mode is of particular importance for treating the case of surface pinning. Its weight is enhanced by the surface roughness present in any real sample and allows for the flow of a large non dissipative current (the critical current). Taking into account the finite size of the sample, the complex penetration depth was shown to take the form:

$$\frac{1}{\lambda_{ac}} = \frac{1}{L_S} + \frac{1-i}{\delta_{ff}} \cotanh \frac{(1-i)L}{2\delta_{ff}} \quad (1)$$

where δ_{ff} is the only frequency-dependent parameter. $L_S \approx \lambda'(0) \approx \frac{\alpha_0 \omega}{\mu_0 i_c}$ is related to the superficial critical current i_c (A/m) and L is the thickness of the sample ($L = \ell_a$ in our geometry). Note that L_S , as i_c , is independent of the frequency (as long as $\Omega \ll \Omega_{gap}$). The bulk pinning contribution can be simply introduced following the same approach as the Campbell one. This results in a strong narrowing of the depinning spectrum, easily observable by experiment [4]. Since the spectra measured in the present work always follow equation (1) with an accuracy within the noise of the data. We reach the conclusion that $\lambda_c^{-1} \approx 0$, i.e. bulk pinning is negligible compared to surface pinning in this sample.

Some typical penetration depths $\lambda_{ac}(T)$, measured for different frequencies and at a fixed field $B = 6$ T, are shown in Figure 2. We note the maximum of the out of phase component λ'' and the saturation of λ' for frequency dependent temperature values. This can be associated with a thermal depinning of the vortex lattice. Anyway, because of the possible mixing of many effects, both intrinsic (pinning, flow, transition of the vortex lattice...)

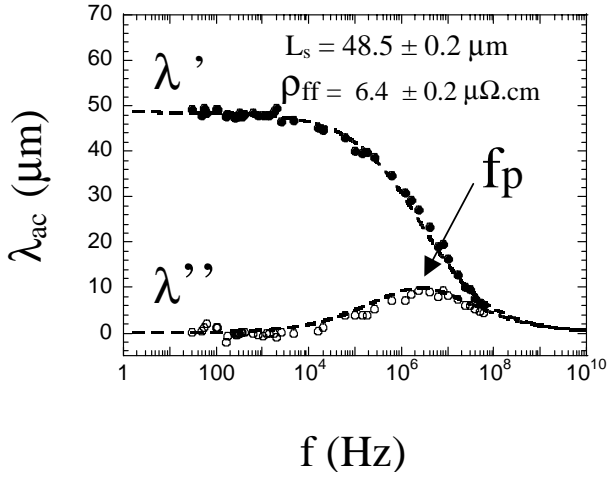

Fig. 3. Depinning spectrum of the pinned vortex lattice ($T = 88.6 \text{ K} < T_m$). The dashed line is a fit using equation (1) (pure surface pinning with $L_s = 48.5 \mu\text{m}$ and $\rho_{ff} = 6.4 \mu\Omega\text{cm}$). Other possible bulk pinning contribution is found negligible.

and extrinsic (finite size effects) and of the bad known temperature variation of thermodynamic parameters of the vortex lattice, a precise study of the ac dynamical response needs a study of the frequency dependence. Such a spectrum taken in the “solid” phase ($I_c \neq 0$) is presented in the Figure 3. It reveals a two mode spectrum, with a pure surface pinning and free vortex flow in the bulk, as previously observed in conventional superconductors [4], and in a slightly overdoped YBaCuO [21]. Other spectra taken at lower temperatures confirm this result (Fig. 4).

Comparing with previous measurements [21], we have extended the frequency range so as to investigate the pure loss free response and the pure resistive response in the overdamped regime. In particular, the low frequency behaviour has been measured near T_m ($T/T_m \simeq 0.993$), in order to increase the probability of thermally activated vortex jumps. As evidenced in Figure 5, λ' is nevertheless constant, within noise due to the smallest of low frequency signal, and there is no loss ($\lambda'' = 0$) down to a frequency of about $10^{-5} \Omega_p$. In others words, the critical current does not depend on the frequency even very close to T_m , and creep effects are thus negligible up to our lowest measurable frequency (few tens Hz) even close to T_m .

In the “liquid” phase ($T > T_m, I_c = 0$), one measures the spectrum of a superconductor free from defects, as expected from the disappearance of any vortex pinning (Fig. 6). This is a classical electromagnetic skin effect driven by the flow resistivity ρ_f , growing up to T_{BC2} . As there is no more critical current, the surface mode is turned off ($L_s^{-1} = 0$ in Eq. (1)) and only the bulk resistive mode is active. The low frequency penetration is that of a perfectly transparent slab: $2L = \lambda_{ac}$, which allows identification of the irreversibility temperature without ambiguity. Let us emphasize that $2L = \lambda_{ac}(\frac{\Omega}{2\pi} \rightarrow 0)$ only for $T \geq T_m = 89.2 \text{ K}$, and that T_m is not frequency dependent. As the critical current and the irreversibility line do not depend on the frequency, the pinning parameters are not dispersing in the frequency range we have inves-

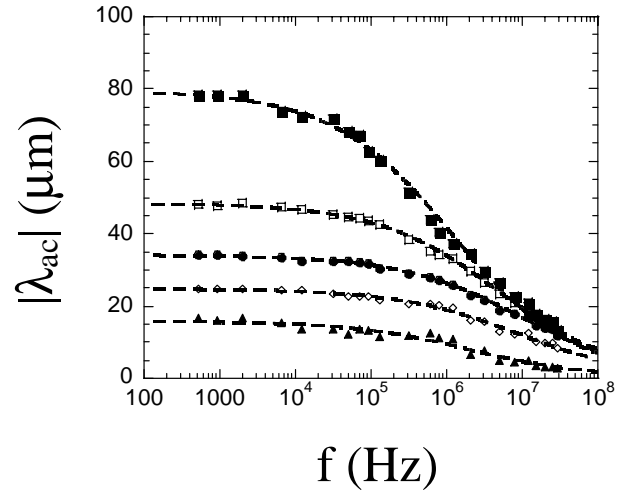

Fig. 4. Frequency spectra of the vortex lattice in the “solid” state ($I_c \neq 0, T = 78.4, 85.7, 87.8, 88.5, 88.8 \text{ K}$). The low frequency penetration increases (and the surface critical current decreases) as the temperature increases. Note the broad depinning spectrum due to the surface mode compared to the one mode skin effect spectrum of Figure 6. The dashed line is a fit with equation (1) with the following parameters: $L_s = 15.8, 24.7, 34.1, 48.5, 79.6 \mu\text{m}$ and $\rho_{ff} = 0.3, 3.1, 6.2, 6.5, 6.4 \mu\Omega\text{cm}$.

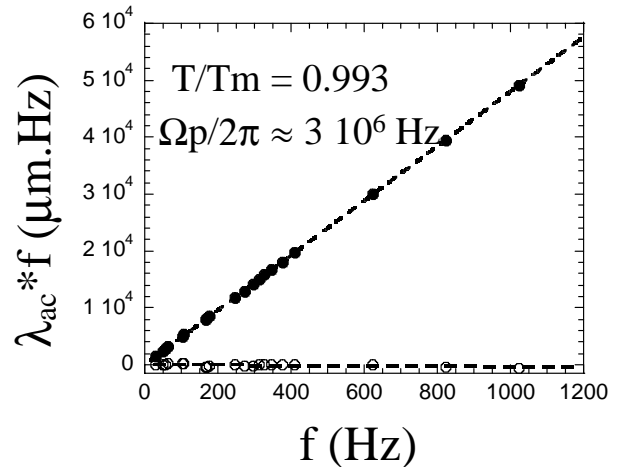

Fig. 5. The low frequency response of the vortex lattice $\lambda_{ac} \times f$ as function of the frequency f , so as to emphasize the low frequency linearity which implies $\lambda' \simeq 48.5 \mu\text{m} < \ell_a/2$.

igated. We conclude that we do not observe any role of thermal assisted depinning of vortices.

In Figure 7, we present the two parameters extracted from the low frequency and the high frequency curves, the critical current and the flux flow resistivity. In the surface pinning model, i_c is simply link with the main reversible magnetization $M = -\int_{vol} \epsilon dV$, as diamagnetic currents and surface non dissipative currents are the same kind of equilibrium currents [20]. The only adjustable parameter is the phenomenological angle $\theta_{cr} \simeq \frac{i_c}{\epsilon}$, which takes into account both the surface roughness and the vortex lattice elasticity. We have measured the main reversible magnetization of the sample by means of a squid magnetometer.

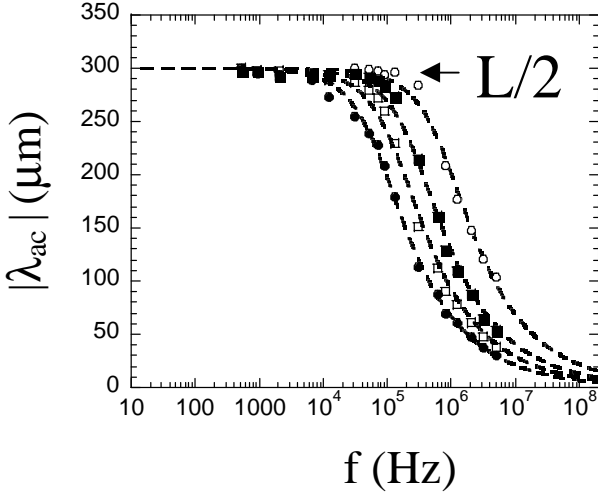

Fig. 6. Frequency spectra of the vortex lattice in the “liquid” state ($I_c = 0$, $T = 89.3, 89.9, 90.9, 91.9$ K). The low frequency depth is a constant and given by the half thickness of the sample. The shift of the skin effect frequency is due to the growing flux flow resistivity. The dashed line is a fit with equation (1) with the following parameters: $L_s^{-1} \propto i_c = 0$ and $\rho_{ff} = 6.9, 9.9, 14.3, 29.5 \mu\Omega \text{ cm}$.

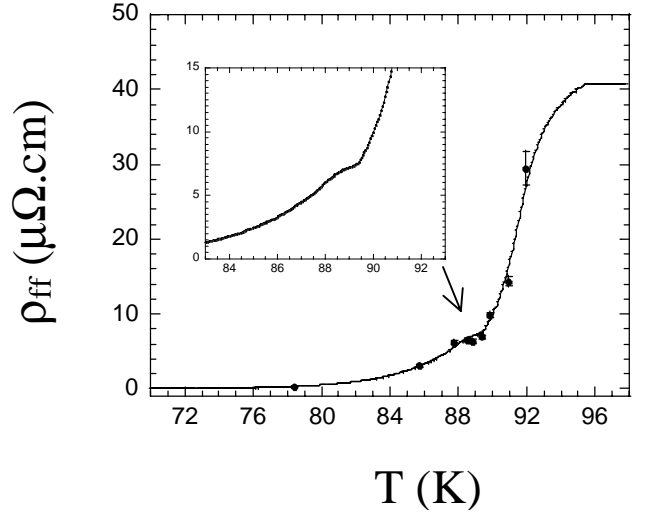

Fig. 8. Flux flow resistivity extracted from a fit of the whole depinning spectrum (point) compared to the values measured at a constant frequency ($f = 29$ MHz) assuming $\lambda_{ac} = \lambda_{ff} = \frac{(1+i)\delta_{ff}}{2}$ (solid line).

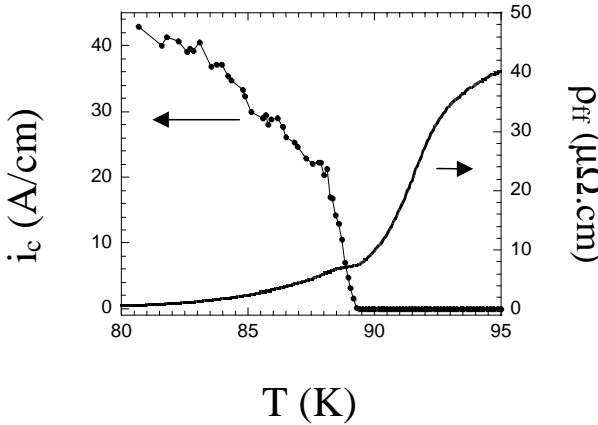

Fig. 7. The surface critical current and the flux flow resistivity around the first order transition.

Comparing with i_c ($T < T_m$), this leads to a reasonable and quite standard value of $\theta_{cr} \approx 5^\circ$ (corresponding to a standard surface roughness) which goes to zero at $T = T_m$.

We will now focus on the cross over between the pinned and depinned state. As now well established, some very clean YBaCuO samples present a thermodynamic first order transition [10], at a field (temperature) where the critical current disappears. Such a feature is usually interpreted as the melting of a vortex solid into a liquid state. The vortex solid is Abrikosov-like, and more recent theories predict a quasi long range ordered lattice in the case of low enough pinning (the Bragg Glass) [11]. The properties of the “liquid” state are badly known. As structural studies of the high temperature state of the VL are not possible due to the lack of resolution so close to T_c , most of the experimental answers are indirect. One can use transport

measurements in order to test a pertinent property. Recent complex resistivity measurements in YBaCuO have interpreted the inductive to resistive transition as a collapse of the vortex shear constant C_{66} [22], as claimed if the first order transition is a genuine melting. We have shown here and discussed in [23], that this transition is simply described by the disappearance of the pinning strength, as it appends at B_{C2} in low T_c materials. However, another feature appears in our data. The high frequency $\lambda_{ac}(T)$ curves present a step at the temperature of the first order transition. This is observed in the two directions ($\vec{B} \parallel \vec{a}$ -axis and $\vec{B} \parallel \vec{c}$ -axis). The remaining question is what could cause this feature. In principle, when measuring at high enough frequencies, the vortex lattice behaves as if it was ideal leading to $\lambda_{ac} \simeq \lambda_{ff} = \frac{(1+i)\delta_{ff}}{2}$. In fact, one has to correct this result by the diamagnetism of the mixed state $\mu = \mu_o \frac{B}{B + \mu_o \epsilon}$, *i.e.* $\lambda_{ac} \simeq \frac{\mu}{\mu_o} \lambda_f$ and $\delta_{ff} = \sqrt{\frac{2\rho_{ff}}{\mu\Omega}}$ [19]. As the first order transition suddenly modifies this diamagnetism by $\Delta\epsilon$, it could lead to a concomitant effect on λ_{ac} . Nevertheless, as $B \gg \mu_o \Delta\epsilon$ ($\lesssim 10^{-4}$ T), this effect is far too small to affect our measurement. Moreover, at the highest frequencies used, $\delta_{ff} \lesssim 50 \mu\text{m} < L/10$, so the thick limit is well justified and spurious size effects are neglected. We have also checked that the values extracted both from a fit of the complete spectra or at a constant frequency $f \gg f_p$ are equivalent (Fig. 8). Our conclusion is that the step of λ_{ac} reflects the one of ρ_{ff} . We emphasize that in conventional superconductors, there is no link between the flux flow resistivity and the critical current [24], except at a critical field as B_{C2} ($I_c \approx 0$, $\rho_{ff} \approx \rho_n$). Such independence between the pinning characteristics and the bulk flow resistivity of a superconductor in the mixed state was evidenced in reference [25]. As an example, the flux flow resistivity, measured in dc or at high frequencies, was shown to be the same and clearly

insensitive to the critical current peak effect in conventional superconductors [26]. On the contrary, we see here that the first order transition affects both the critical current and the flux flow resistivity. As this latter is linked to the nature of the order parameter and to the quasiparticle excitations in the vortex state, it is tempting to conclude that the first order transition affects the electronic structure inside and (or) around the vortex core, or in contrast that a transition in this electronic structure drives the first order transition. The difficulty lies in understanding the key role of the different peculiarities of the vortex core in YBaCuO (short coherence length, d -wave symmetry with nodes, strong antiferromagnetic fluctuations even for optimally doped samples [27]) compared to the simplest case of a conventional dirty s -wave superconductor. A question of the same type has been previously addressed by D'Anna *et al.* [28], who observed a strong decrease of the Hall resistivity at a temperature just below the one of the first order transition. We note that a small distortion of the vortex lattice in a d -wave superconductor should lead to an important thermodynamic contribution ($\Delta S \approx k_B$) via the fermionic entropy [29], and that such kind of distortion does not necessarily correspond to a melting.

In conclusion, complex impedance measurements have been performed in a clean YBaCuO crystal, with a particular attention to the vortex depinning transition. Two mode electrodynamic analysis of the data allow us to conclude that the vortex pinning is due to the surface roughness of the sample, and that the depinning (and the irreversibility line) is not driven by thermal activation. The flux flow resistivity exhibits a step at the first order transition, that remains to be interpreted, in the framework of a melting or using alternative descriptions.

This work was partially supported by NEDO, Japan for the R and D of Industrial Science and Technology Frontier Program. AP, CG and CS are indebted to Bernard Plaças *et al.* (ENS, PARIS) whose work is at the origin of this type of experiment.

References

1. N. Lütke-Entrup, R. Blaauwgeers, B. Plaças, A. Huxley, S. Kambe, M. Krusius, P. Mathieu, Y. Simon, *Phys. Rev. B* **64**, 020510 (2001)
2. J.I. Gittleman, B. Rosenblum, *Phys. Rev. Lett.* **16**, 734 (1966)
3. A.M. Campbell, *J. Phys. C* **2**, 1492 (1969); A.M. Campbell, in *Magnetic Susceptibility of Superconductors and Other Spin Systems*, edited by R.A. Hein (Plenum, New York, 1992), p. 129
4. N. Lütke-Entrup, B. Plaças, P. Mathieu, Y. Simon, *Phys. Rev. Lett.* **79**, 2538 (1997); *ibid.*, *Physica B* **255**, 75 (1998)
5. T.K. Worthington, W.J. Gallagher, D.L. Kaiser, F.H. Holzberg, T.R. Dinger, *Physica C* **153-155**, 32 (1998)
6. P.L. Gammel, L.F. Schneemeyer, J.V. Wasczak, D.J. Bishop, *Phys. Rev. Lett.* **61**, 1666 (1988)
7. J. Van der Berg, C.J. Van der Beek, P.H. Kes, J.A. Mydosh, M.J.V. Menken, A.A. Menovski, *Supercond. Sci. Technol.* **1**, 249 (1999)
8. D.G. Steel, J.M. Graybeal, *Phys. Rev. B* **45**, 12643 (1992)
9. F. Supple, A.M. Campbell, J.R. Cooper, *Physica C* **242**, 233 (1995)
10. F. Bouquet, C. Marcenat, R. Calemczuc, A. Erb, A. Junod, M. Roulin, U. Welp, W.K. Kwok, G.W. Crabtree, N.E. Phillips, R.A. Fisher, A. Schilling, in *Physics and Material science of vortex states*, edited by R. Kossowsky (NATO Science Series, 1998), p. 743; F. Bouquet, Ph.D. Université de Grenoble (1998)
11. T. Giamarchi, S. Bhattacharya, *Vortex phases*, in *High Magnetic Fields: Applications in Condensed Matter Physics and Spectroscopy*, edited by C. Berthier *et al.* (Springer-Verlag, 2002)
12. A.M. Campbell, J.E. Evetts in *Critical currents in superconductors*, Vol. 21 (Taylor and Francis, London, 1972), p. 302
13. A.I. Rykov, S. Tajima, in *Advances in Superconductivity VIII*, edited by H. Hayakawa, Y. Enomoto (Springer-Verlag, 1996), p. 341
14. A.I. Rykov, S. Tajima, F.V. Kusmartsev, E.M. Forgan, Ch. Simon, *Phys. Rev. B* **60**, 7601 (1999)
15. C.J. van der Beek, V.B. Geshkenbein, V.M. Vinokur, *Phys. Rev. B* **48**, 3393 (1993)
16. M.W. Coffey, J.R. Clem, *Phys. Rev. B* **45**, 9872 (1992)
17. E.H. Brandt, *Phys. Rev. Lett.* **67**, 2219 (1991)
18. E.B. Sonin, A.K. Tagantsev, K.B. Traito, *Phys. Rev. B* **46**, 5830 (1992)
19. B. Plaças, P. Mathieu, Y. Simon, E.B. Sonin, K.B. Traito, *Phys. Rev. B* **54**, 13083 (1996)
20. P. Mathieu, Y. Simon, *Europhys. Lett.* **5**, 67 (1988)
21. A. Pautrat, Ch. Goupil, C. Simon, N. Lütke-Entrup, B. Plaças, P. Mathieu, Y. Simon, A.I. Rykov, S. Tajima, *Phys. Rev. B* **63**, 054503 (2001)
22. P. Matl, N.P. Ong, R. Gagnon, L. Taillefer, *Phys. Rev. B* **65**, 214514 (2002)
23. A. Pautrat, C. Goupil, Ch. Simon, B. Plaças, P. Mathieu, *cond-mat/0207074*, *Phys. Rev. B* **67**, 146501 (2003)
24. A.C. Rose-Innes, E.H. Rhoderick, in *Introduction to Superconductivity*, 2nd edn. (Pergamond Press, 1978), p. 206
25. B. Rosenblum, M. Cardona, *Phys. Rev. Lett.* **12**, 657 (1964)
26. Y.B. Kim, M.J. Stephen, *Superconductivity*, Vol. 2, edited by R.D. Parks (Marcel Dekker, INC, 1969), p. 1120 and references herein
27. V.F. Mitrović, E.E. Sigmund, H.N. Bachman, M. Eschrig, W.P. Halperin, A.P. Reyes, P. Kuhns, W.G. Moulton, *Nature* **413**, 505 (2001)
28. G. D'Anna, V. Berseth, L. Forro, A. Erb, E. Walker, *Phys. Rev. Lett.* **81**, 2530 (1998)
29. G.E. Volovik, *JETP Lett.* **65**, 491 (1997)