

# *LLP seaches with CODEX-b*

COmpact Detector for EXotics at LHC**b**

[1708.09395]

Biplab Dey

on behalf of the CODEX-b WG



Third workshop of the LHC LLP Community,  
May 16<sup>th</sup>-18<sup>th</sup> 2018, CERN

# THE LIFETIME FRONTIER AT THE LHC

- Weakly coupled **long lived particles** (LLP) encompass all three other frontiers
- The SM already has templates for such particles ( $\nu$ ,  $K_L^0$ , ...)

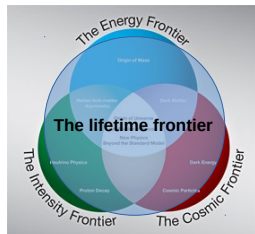

$$\Gamma \sim \boxed{\epsilon^2} \left( \frac{m}{\Lambda} \right)^n \boxed{\Phi}$$

small mixing angle from broken symm. (pink box)  
 mass hierarchy,  $m \ll \Lambda$  (red text)  
 loop suppression  $n \geq 4$  (blue text)  
 small phase space (green text)

- Large lifetimes are driven by several factors

- $pp$  collisions at LHC are excellent source of LLP's. But high  $p_T$  (ATLAS/CMS) or restricted  $c\tau$  (LHCb) searches can miss these.

## CAST A WIDE NET

## SUPERSYMMETRY

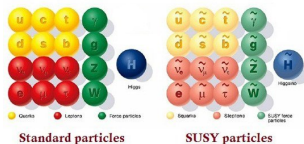

R-parity violation  
 Gauge mediated SUSY  
 (mini-)split SUSY  
 stealth SUSY

Asym. DM  
 Freeze-in  
 Composite DM  
 Coannihilating DM

Baryogenesis  
 Neutrino masses  
 Neutral naturalness  
 Hidden Valleys

- Lifetimes as long as sub-second-ish (BBN limit) possible
- Masses can range from sub-MeV to 100 GeV

# LHCb PERSPECTIVE [SEE ALSO Elena's TALK]

- Complementarity between ATLAS/CMS and LHCb: luminosity, acceptance, triggers, lifetime reach.

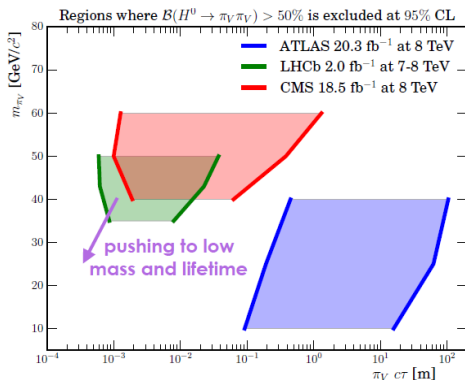

- Our best tracks originate inside the VeLo ( $L \sim 20\text{cm}$ ). Longer lifetimes are challenging.

## OTHER LLP DETECTOR PROPOSALS AT THE LHC

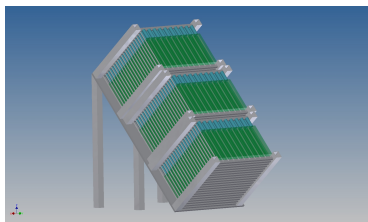

MilliQan: 1607.04669

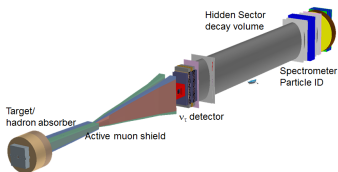

SHiP: 1504.04855

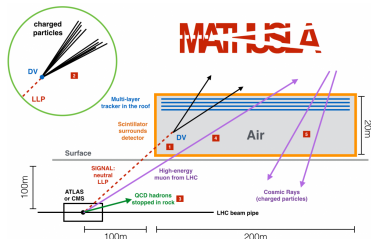

MATHUSLA: 1606.06298

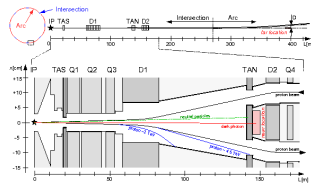

FASER: 1708.09389

# CODEX-B: PROPOSAL AT POINT 8

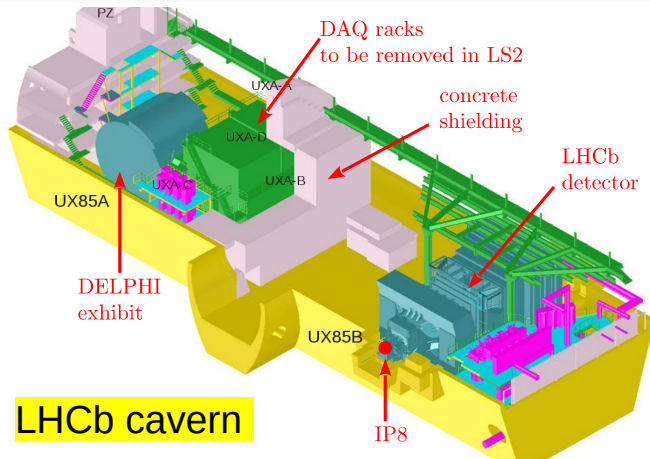

- DAQ racks in UX-A-D move to surface for Run 3. Space available.
- Shielded, underground,  $10 \times 10 \times 10$  m box, around 25 m from IP.
- Instrument with tracking layers  $\Rightarrow$  CODEX-b

# CODEX-B: ANOTHER VIEW

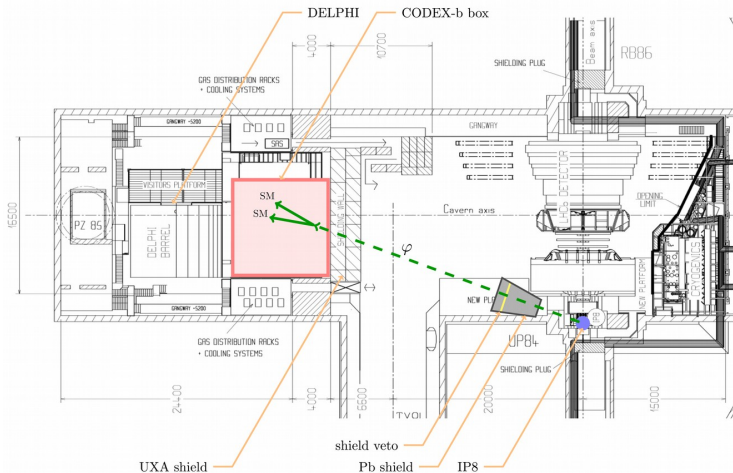

- If DELPHI is removed, access to even  $20 \times 10 \times 10$  m box.
- Angular acceptance  $\sim 1\%$ .

# MINIMAL GEOMETRY FOR TRACKING

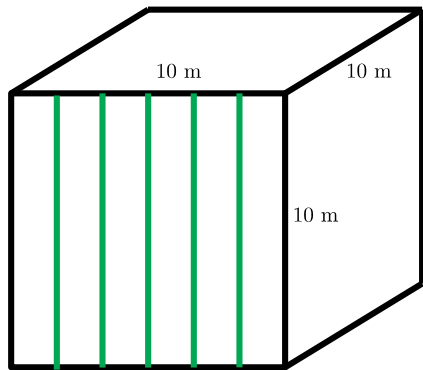

- 6 RPC layers at 4 cm intervals on each box face with 1 cm granularity
- 5 equally spaced triplets along the depth to minimize distance between reconstructed vertex and 1st measurement.  $\epsilon_{\text{tracking}} \sim \mathcal{O}(1)$ .
- 50-100 ps timing from RPC's foreseen for mass reconstruction



## WHY IS CODEX-B ATTRACTIVE

- Small volume to instrument. **Cheaper** and more leverage to try out additional calorimetry, 4d-tracking detectors
- **Backgrounds** are controllable. Underground and existing shields. Space for additional shields
- Only  $\sim 4$  bunch-crossing away from IP8. With good timing (sub-100 ps), can **couple** with LHCb. Eg. tag a  $B \rightarrow K^* \varphi$  between the two detectors.
- **Complementarity** and competitive NP reach wrt other searches.

# MINIMAL SHIELD DESIGN

- CODEX-b sits behind the UXA (concrete) shield. From RP group, charged fluxes nominally quite low (access area!).

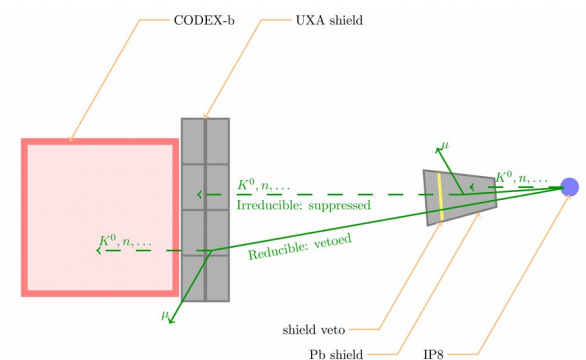

- Add passive **Pb shield** to attenuate muon and neutral hadrons. Thin **active veto** for secondaries inside the shield.

# BACKGROUND STUDIES: SIMULATION

- Min. bias w/ Pythia8. HL-LHC projections: 300/fb @ 14 TeV.
- Propagation thru' Pb, air and concrete in Geant4.

BG species	Particle yields		Baseline Cuts
	irreducible by shield veto	reducible by shield veto	
$n + \bar{n}$	7	$5 \cdot 10^4$	$E_{\text{kin}} > 1 \text{ GeV}$
$K_L^0$	0.2	870	$E_{\text{kin}} > 0.5 \text{ GeV}$
$\pi^\pm + K^\pm$	0.5	$3 \cdot 10^4$	$E_{\text{kin}} > 0.5 \text{ GeV}$
$\nu + \bar{\nu}$	0.5	$2 \cdot 10^6$	$E > 0.5 \text{ GeV}$

- Main remnant background is  $n$ .
- Air- $\mu$  interactions vetoable by front detector face RPC's
- Very little neutrino bkgd.

- Track topology and timing will also help vetoing in the future.
- Study shows active veto suggests  $\epsilon_{\text{veto}} \sim 10^{-5}$  needed and doable.

# BACKGROUND STUDIES: SIMULATION (CNTD.)

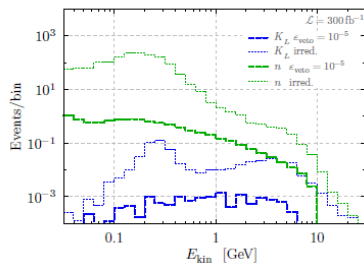
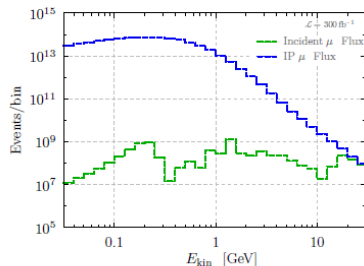

- Spectrum after veto is also soft. Expected multiple scattering is reduced.
- Geant4 study broadly consistent with simplified propagation models with inputs from available data (PDG etc.).

## BACKGROUND STUDIES: VALIDATION MEASUREMENTS

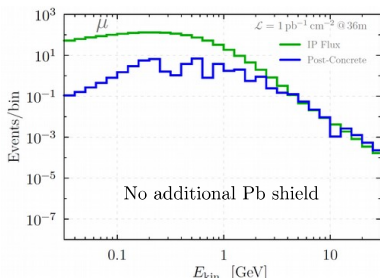

- Neutrals are hard, but charged flux in the simulation can be **validated**.
- Use to **calibrate** the simulation as well

- Measure **charged flux** during current Run 2 **behind UXA** wall.
- Later, more extensive measurements with different shield thickness, orientations, etc.

# BACKGROUND STUDIES: MEASUREMENTS (CNTD.)

- Two  $30 \times 30 \times 2$  cm wrapped plastic scintillators + PMT + mechanical stand.

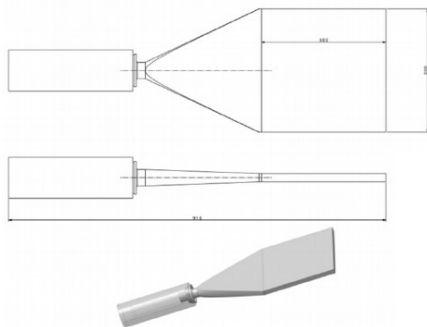

# BACKGROUND STUDIES: MEASUREMENTS (CNTD.)

- Setup tested with cosmics.  $\mathcal{O}(3000)$  in a couple of hours.

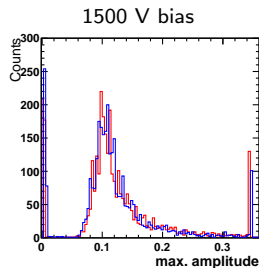
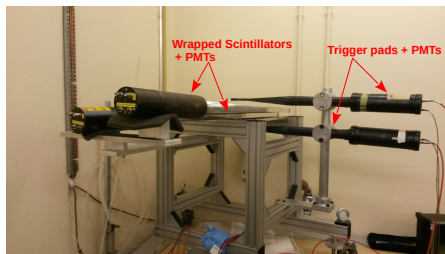

- Hope to get enough events within around a week in the cavern.

# SNAPSHOT OF BENCHMARK SCENARIOS

- Evolving situation depending on what timing, calorimetry, PID capabilities of the final detector will be.
- Some benchmark scenarios:
  - Light GeV-scale **scalar  $\varphi$**  (Higgs mixing)
  - Massive **dark photons  $\gamma_d$**  from exotic Higgs decays (kinematic mixing)
  - **Heavy Neutral Leptons**, (mixing w/ SM neutrinos)
  - **Dark glueballs, axion like particles** (need calorimetry for  $\gamma$  modes)

(present reach plots from D. Robinson *et al.*)

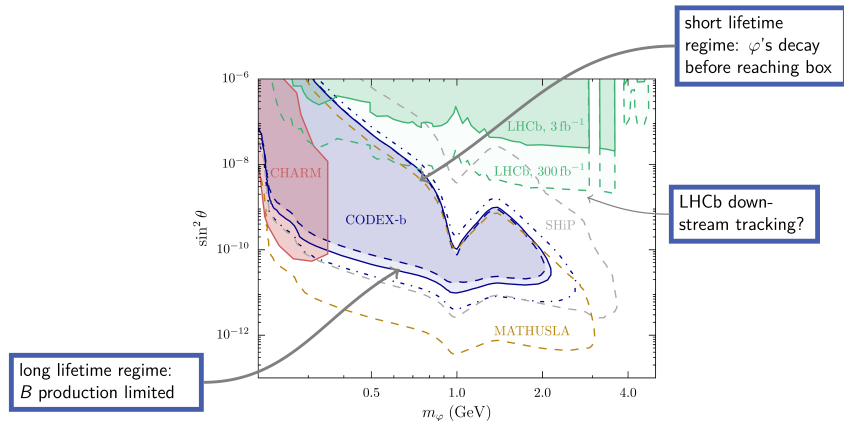

$b \rightarrow s\varphi$  HIGGS-SCALAR MIXING

- Extends LHCb reach considerably and covers large part of MATHUSLA/SHiP reach.

# DARK PHOTONS FROM $h \rightarrow \gamma_d \gamma_d$ DECAYS

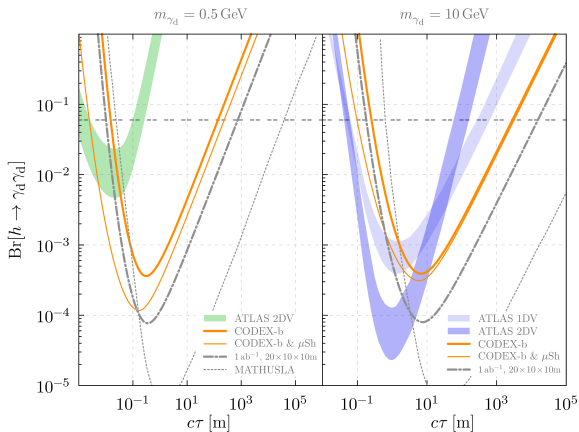

- Extends LHCb reach and at low masses (large boosts), coverage beyond ATLAS.

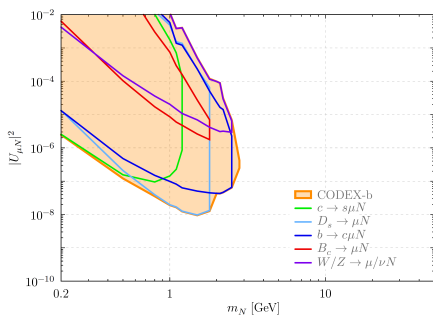
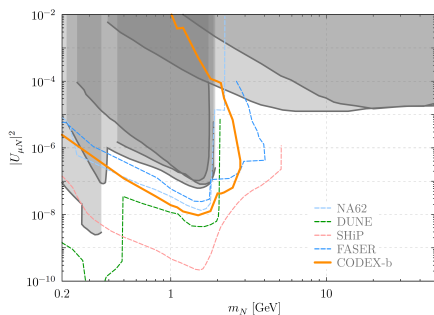
HNL's:  $U_{\ell N}$ 

- Different reaches/constraints for  $\ell \in \{e, \mu, \tau\}$
- Dominated by charm/B decays at low/high masses.

# MASS RESOLUTION

- CODEX-b should also be able to do mass analysis depending on tracking + timing resolutions [1705.06327, Curtis/Peskin]
- Require minimum 6 hits/daughter track. Shown for  $B \rightarrow X\varphi$ :

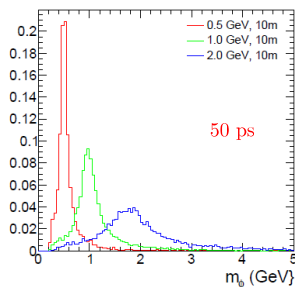
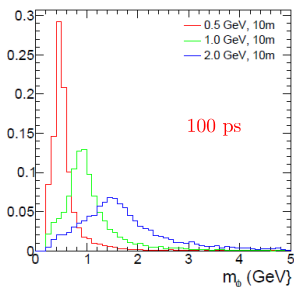

# TODO'S: NEAR AND LONG-TERM FUTURE

- Studies for physics reach + BG measurements are on track.
- Realistic **simulation + tracking** in DD4Hep.
- **Detector technologies**: options for 4d timing+tracking in low radiation/background environment? **Calorimetry** options?

# TODO'S: NEAR AND LONG-TERM FUTURE

- Studies for physics reach + BG measurements are on track.
- Realistic **simulation + tracking** in DD4Hep.
- **Detector technologies**: options for 4d timing+tracking in low radiation/background environment? **Calorimetry** options?

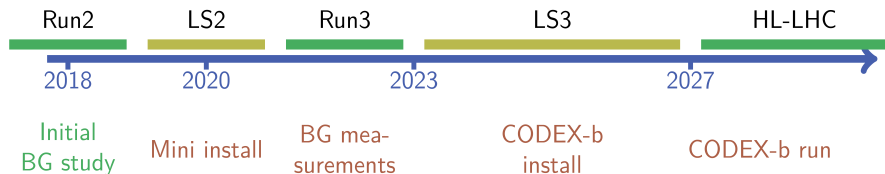

# CODEX-B: WHO WE ARE

- **Theory** colleagues:  
S. Knapen, M. Papucci, D. Robinson
- **LHCb** physicists:  
V. Coco, B. Dey, R. Dumps, V. Gligorov, T. Szumlak, H. Schindler,  
T. Szumlak, X. Vidal + many others...
- Growing collaboration...you're very welcome to join!!!

# CODEX-B: WHO WE ARE

- **Theory** colleagues:  
S. Knapen, M. Papucci, D. Robinson
- **LHCb** physicists:  
V. Coco, B. Dey, R. Dumps, V. Gligorov, T. Szumlak, H. Schindler,  
T. Szumlak, X. Vidal + many others...
- Growing collaboration...you're very welcome to join!!!

*Thanks!*