

---

# Medical Applications of Modern Physics

Marco Silari  
CERN, Geneva, Switzerland  
marco.silari@cern.ch

---

# Medical Physics

=

A branch of applied physics concerning  
the application of physics to medicine

or, in other words

The application of physics techniques to the  
human health

Physics discoveries

Tools for physics applied to medicine

Medical imaging

X-ray CT

PET and PET/CT

Photon/electron radiation therapy

Hadron therapy

Physics discoveries

Tools for physics applied to medicine

Medical imaging

X-ray CT

PET and PET/CT

Photon/electron radiation therapy

Hadron therapy

# The beginnings of modern physics and of medical physics

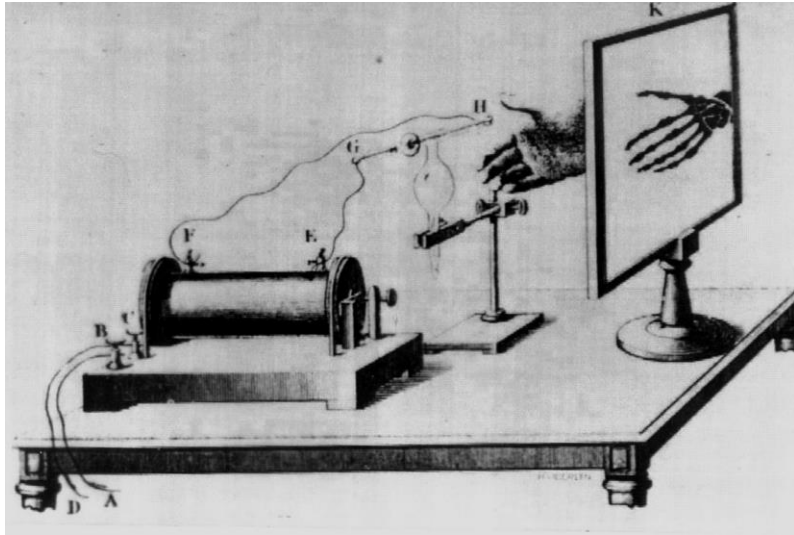

1895  
Discovery of X rays  
**Wilhelm C. Röntgen**



1897  
First treatment of  
tissue with X rays  
**Leopold Freund**

**J.J. Thompson**

1897  
"Discovery" of the  
electron

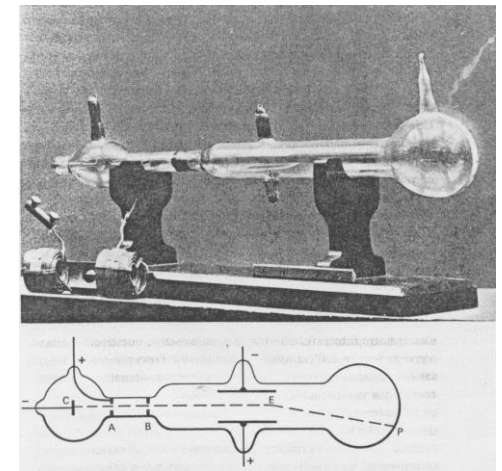

# The beginnings of modern physics and of medical physics



**Henri Becquerel  
(1852-1908)**

1896

Discovery of natural  
radioactivity

Thesis of Mme. Curie – 1904

$\alpha$ ,  $\beta$ ,  $\gamma$  in magnetic field

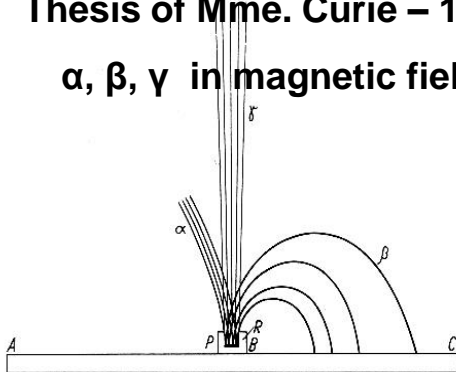

Hundred years ago

1898

Discovery of polonium  
and radium

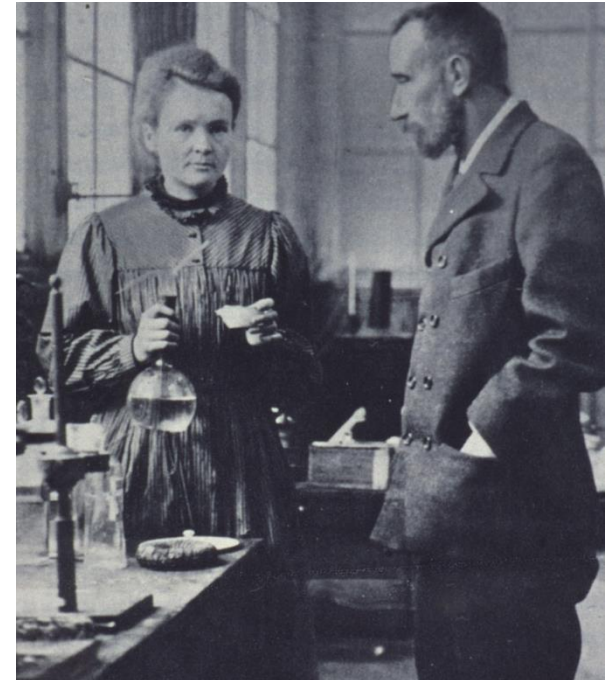

**Marie Curie    Pierre Curie  
(1867 – 1934) (1859 – 1906)**

# First practical application of a radioisotope

---

- **1911: first practical application of a radioisotope** (as *radiotracer*) by G. de Hevesy (a young Hungarian student working with naturally radioactive materials) in Manchester
- **1924:** de Hevesy, who had become a physician, used radioactive isotopes of lead as tracers in bone studies

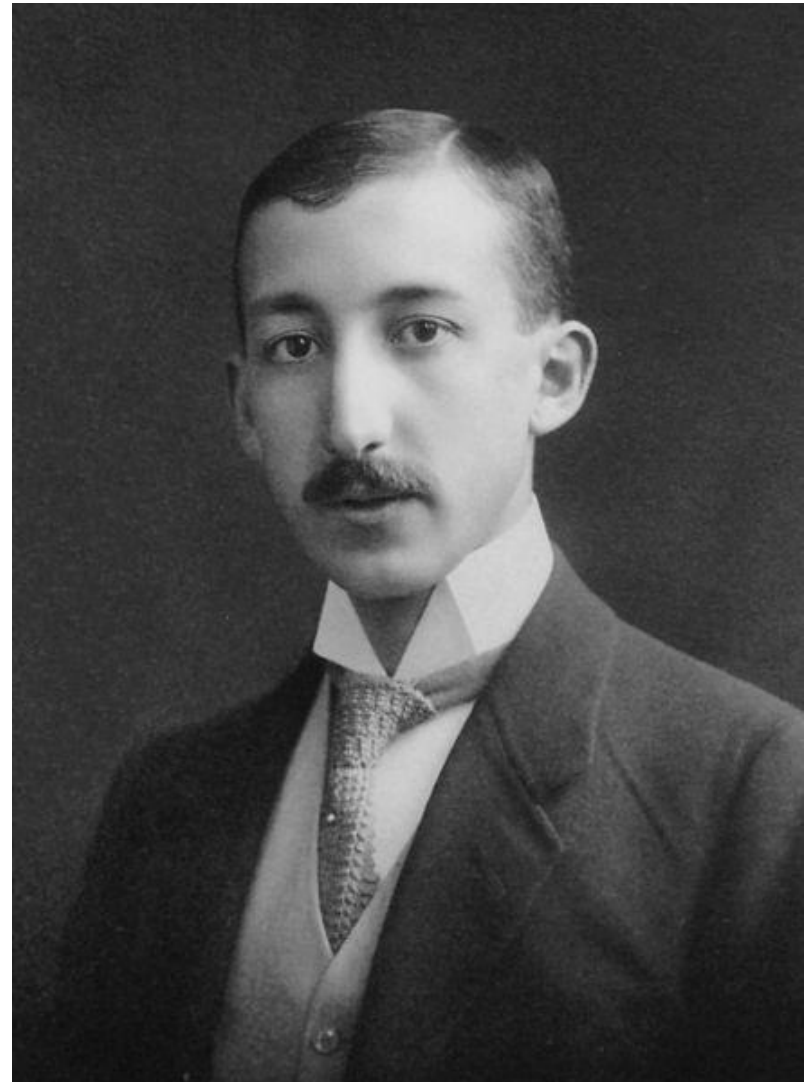

# Tools for (medical) physics: the cyclotron



1930

Invention of the cyclotron

**Ernest Lawrence**

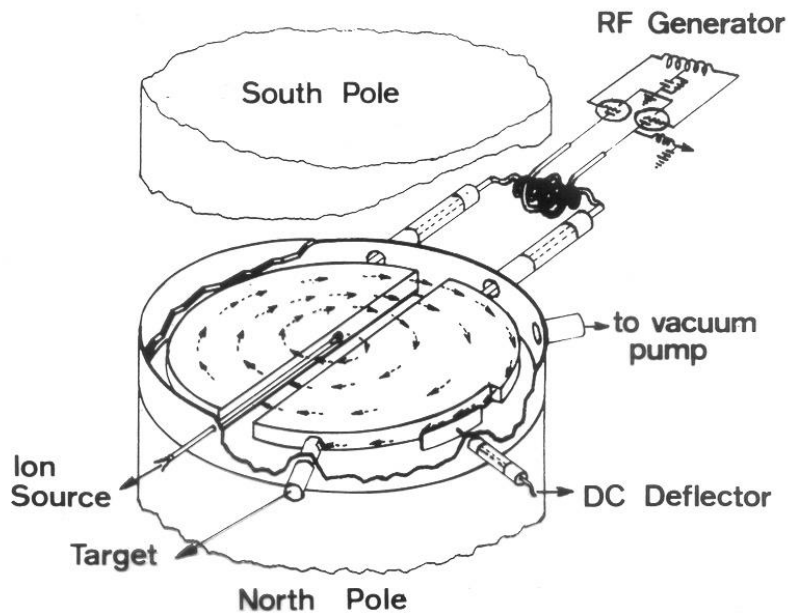

**M. S. Livingston and E. Lawrence  
with the 25 inch cyclotron**



# The beginnings of modern physics and of medical physics



**James Chadwick**  
**(1891 – 1974)**

1932

## Discovery of the neutron

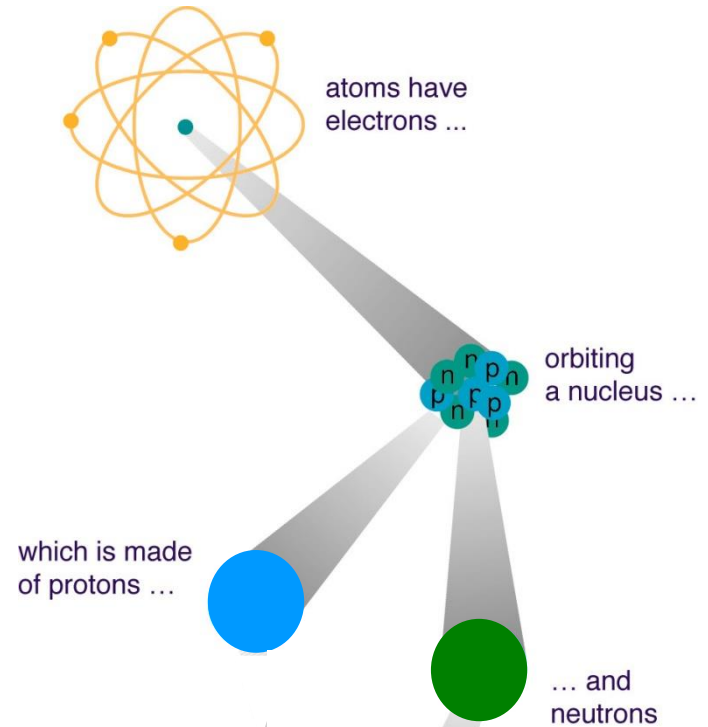

**Cyclotron + neutrons = first attempt of radiation therapy with fast neutrons at LBL (R. Stone and J. Lawrence, 1938)**

# The beginnings of modern physics and of medical physics

1932

Discovery of the positron

**C. D. Anderson**

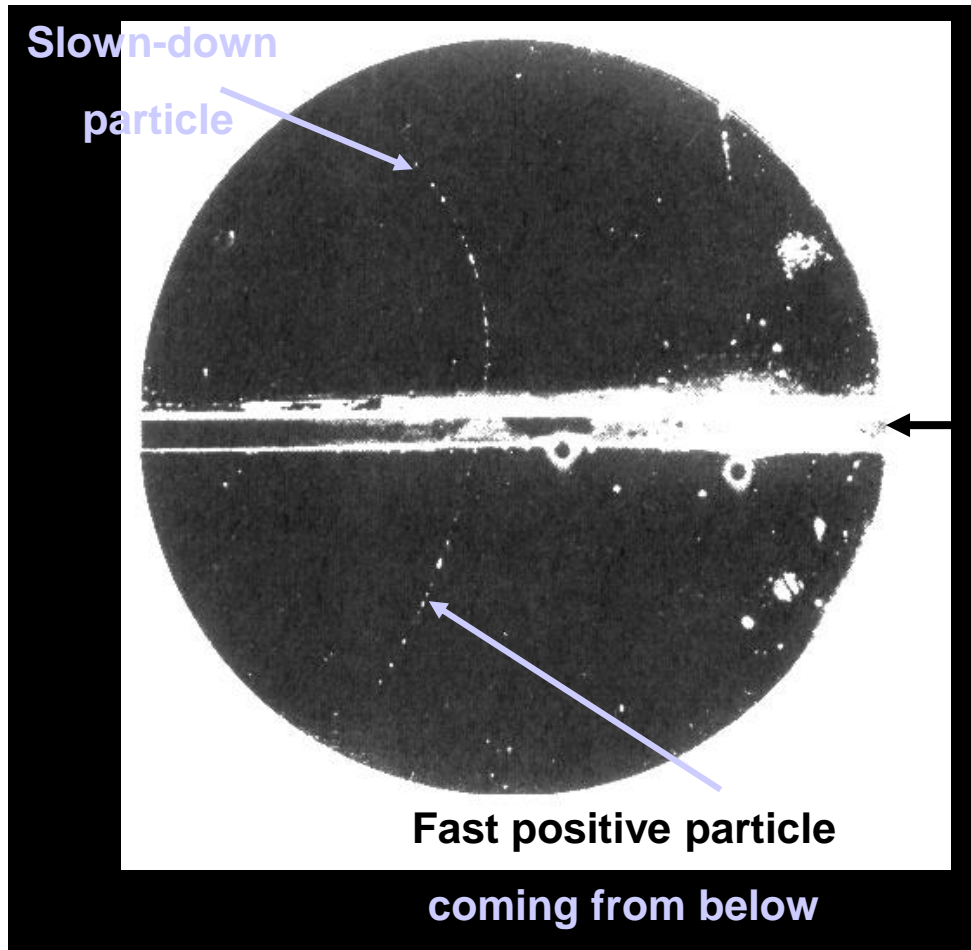

Layer of lead  
Inserted in a cloud chamber

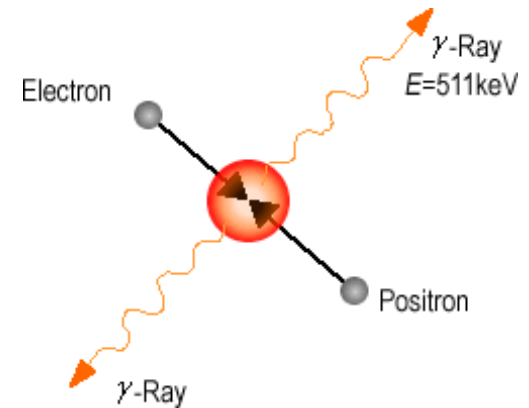

## Historical development of radioisotopes for medicine

---

- **1932:** the invention of the cyclotron by E. Lawrence makes it possible to produce radioactive isotopes of a number of biologically important elements
- **1941:** first medical cyclotron installed at Washington University, St Louis, for the production of radioactive isotopes of phosphorus, iron, arsenic and sulphur
- **After WWII:** following the development of the fission process, most radioisotopes of medical interest begin to be produced in nuclear reactors
- **1951:** Cassen et al. develop the concept of the rectilinear scanner
- **1957:** the  $^{99}\text{Mo}/^{99\text{m}}\text{Tc}$  generator system is developed by the Brookhaven National Laboratory
- **1958:** production of the first gamma camera by Anger, later modified to what is now known as the Anger scintillation camera, still in use today

# Tools for (medical) physics: the electron linac

Sigmur Varian

William W. Hansen

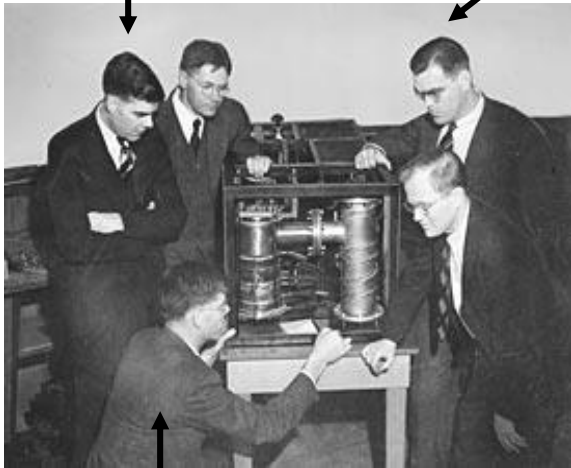

Russell Varian

1939

Invention of the klystron

1950's: development of compact linear electron accelerators by various companies

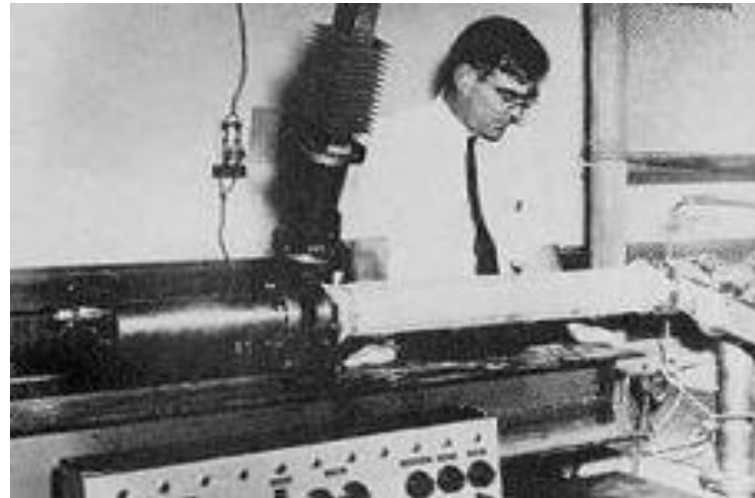

1947  
first linac for electrons  
4.5 MeV and 3 GHz



# Tools for (medical) physics: the synchrotron

**1945: E. McMillan and V.J.Veksler**

discover the  
principle of phase stability

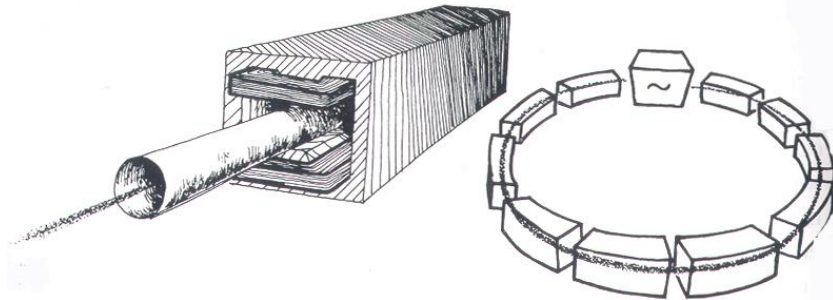

1 GeV electron synchrotron

Frascati - INFN - 1959

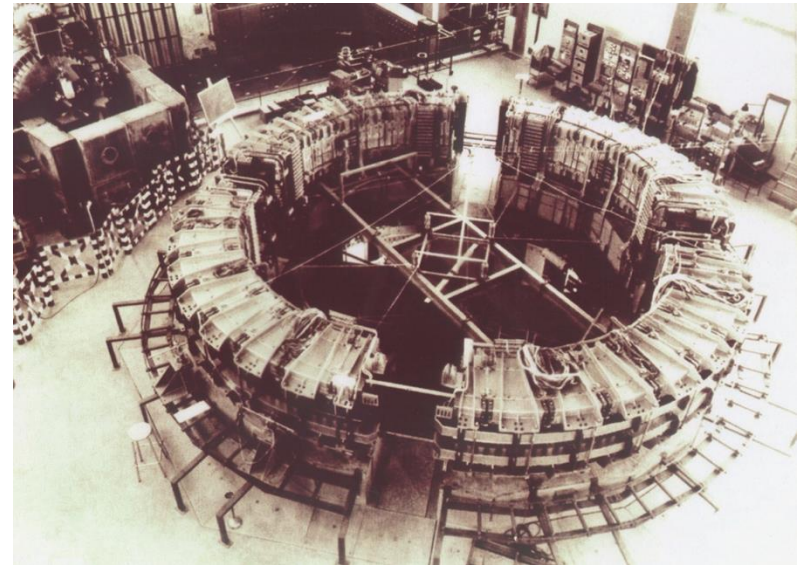

6 GeV proton synchrotron

Bevatron - Berkeley - 1954

# CERN accelerators

Large Hadron Collider  
7 TeV + 7 TeV  
Start in 2008

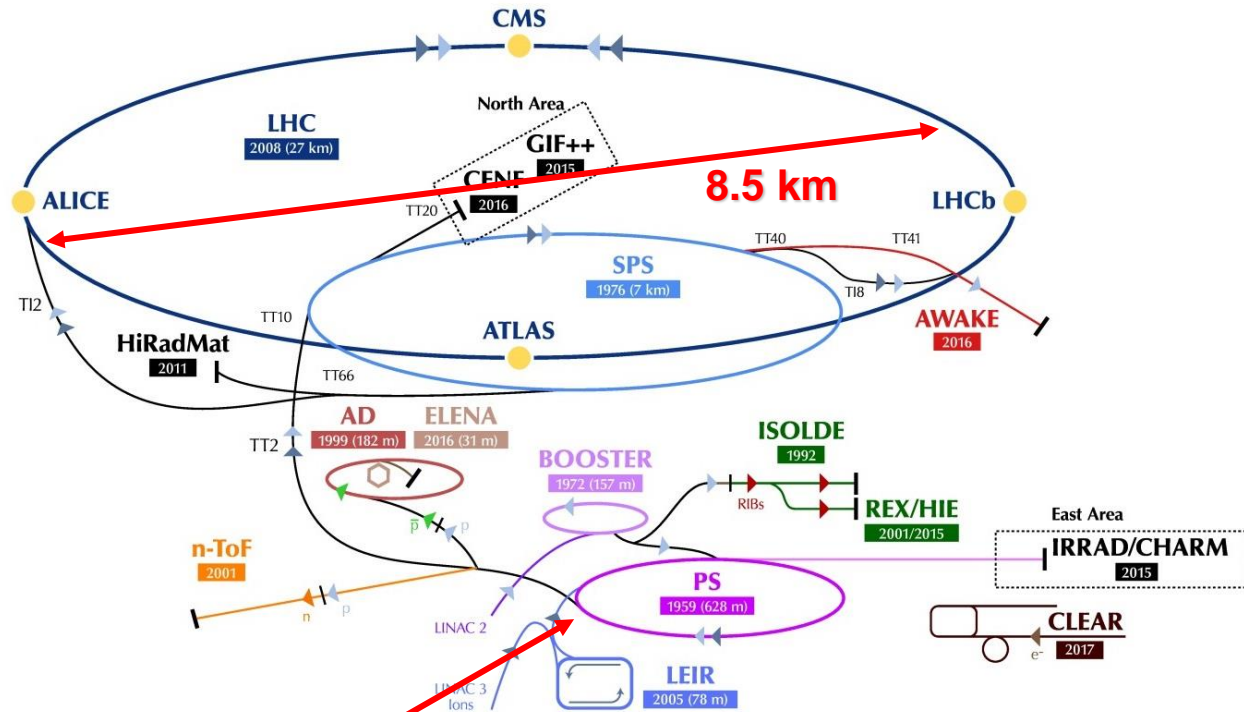

The PS in 1959

In 1952 the "strong-focusing" method  
invented at BNL (USA)  
was chosen for the CERN PS

# Outline of the lecture

---

Physics discoveries

Tools for physics applied to medicine

Medical imaging



X-ray CT

PET and PET/CT

Photon/electron radiation therapy

Hadron therapy

# Medical imaging

TECHNIQUE		YEAR	ENERGY	PHYSICAL PROPERTY	IMAGING
RADIOLOGY	X RAYS IMAGING	<b>1895</b>	X RAYS	ABSORPTION	
ECHOGRAPHY	ULTRASOUND IMAGING	1950	US	REFLECTION TRANSMISSION	
NUCLEAR MEDICINE	RADIOISOTOPE IMAGING	1950	$\gamma$ RAYS	RADIATION EMISSION	

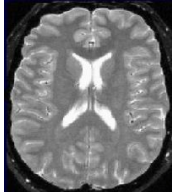
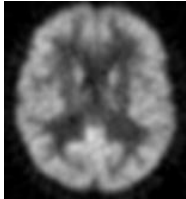

# Medical imaging

TECHNIQUE		YEAR	ENERGY	PHYSICAL PROPERTY	IMAGING	
X RAYS COMPUTERIZED TOMOGRAPHY	<b>CT</b>	<b>1971</b>	X RAYS	ABSORPTION		MORPHOLOGY
MAGNETIC RESONANCE IMAGING	MRI	1980	RADIO WAVES	MAGNETIC RESONANCE		MORPHOLOGY /FUNCTION
POSITRON EMISSION TOMOGRAPHY	PET	1973	$\gamma$ RAYS	RADIATION EMISSION		FUNCTION

# Emission versus transmission imaging

External versus internal radiation sources

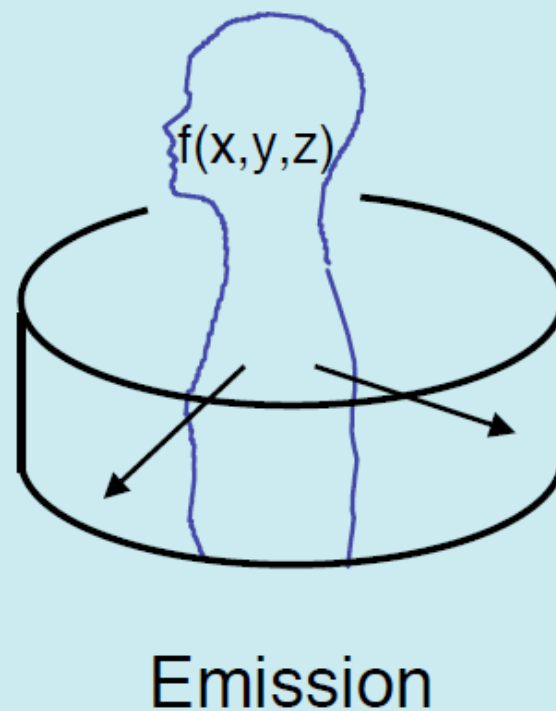
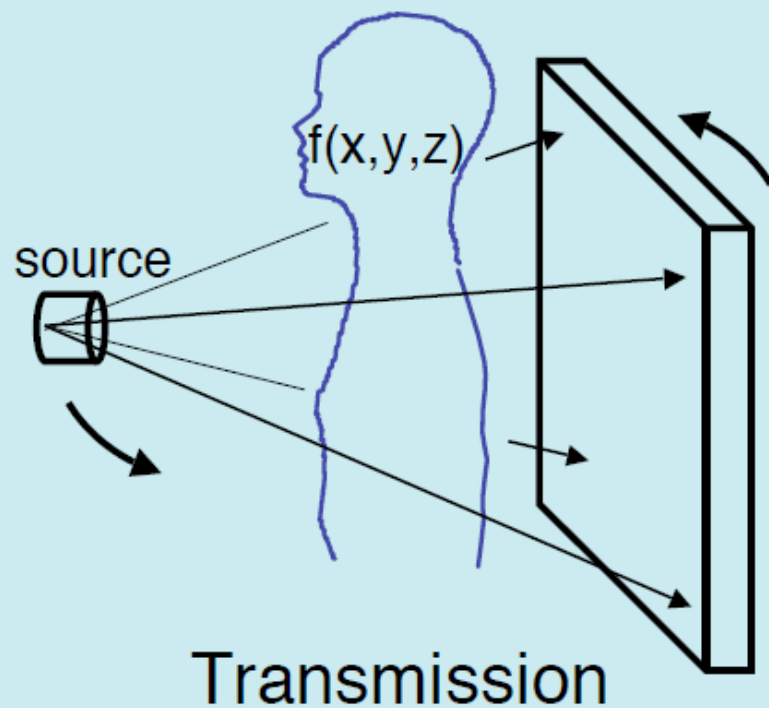

## X-ray image versus CT scan

A conventional X-ray image is basically a **shadow**: you shine a “light” on one side of the body, and a piece of film on the other side registers the silhouette of the bones (to be more precise, **organs and tissues of different densities show up differently on the radiographic film**).

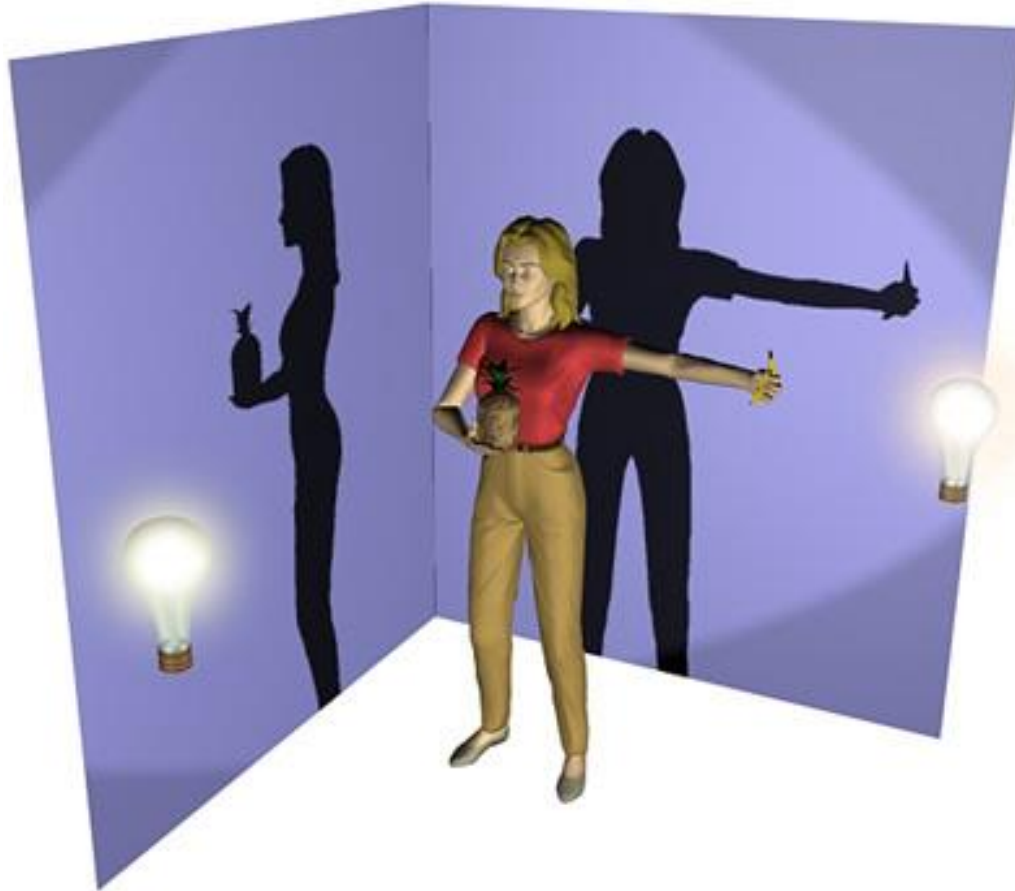

**Shadows give an incomplete picture of an object's shape.**

Look at the wall, not at the person. If there's a lamp in front of the person, you see the silhouette holding the banana, but not the pineapple as the shadow of the torso blocks the pineapple. If the lamp is to the left, you see the outline of the pineapple, but not the banana.

© 2002 HowStuffWorks

# Computed tomography

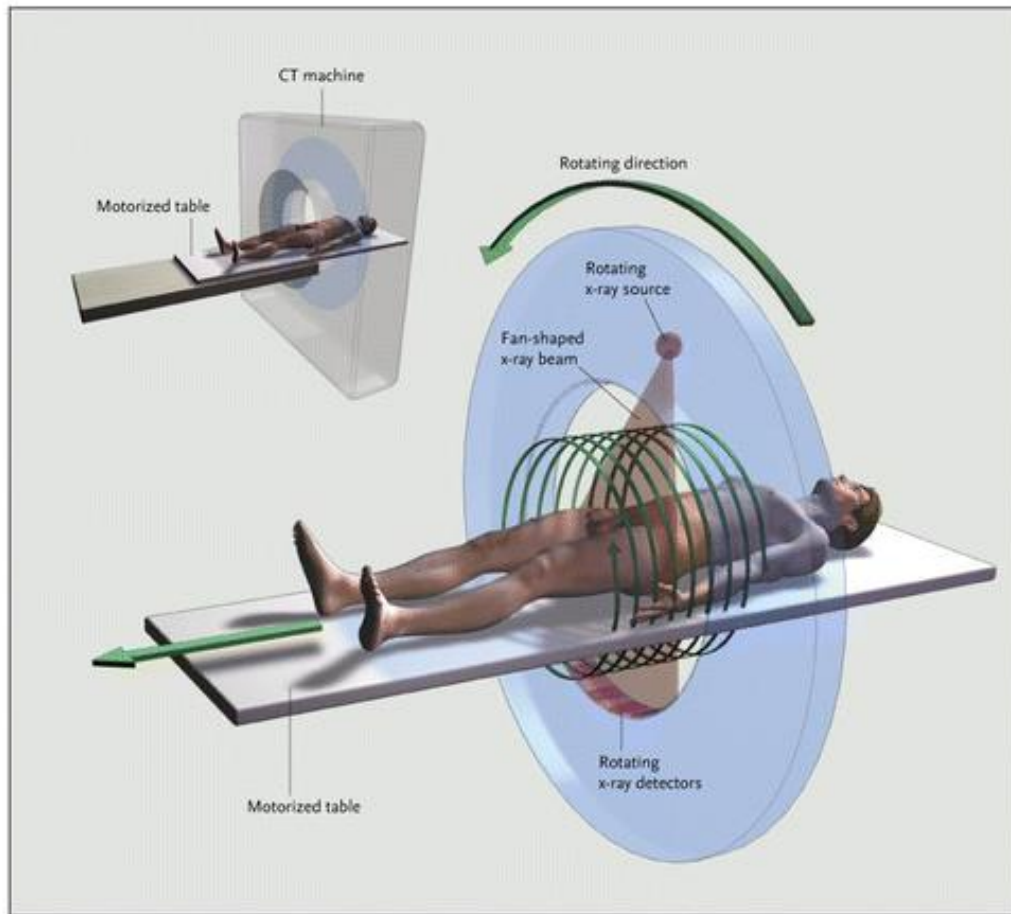

- The X-rays source rotates around the longitudinal axis of the body: it moves  $360^\circ$  around the patient, scanning from hundreds of different angles
- Opposite to the x-ray source, a series of detectors measure the radiation emerging from the body
- Each rotation scans a different body slice
- The couch moves to scan the next slice
- A computer analyses the data and reconstructs the **3D image** through mathematical algorithms.

# Volumetric CT

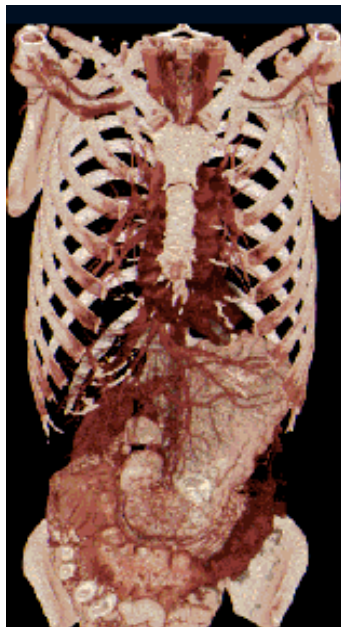
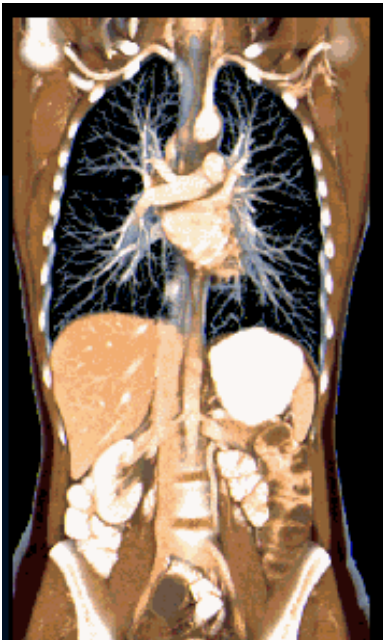

< 0.4 sec/rotation  
Organ in a sec (17 cm/sec)  
Whole body < 10 sec

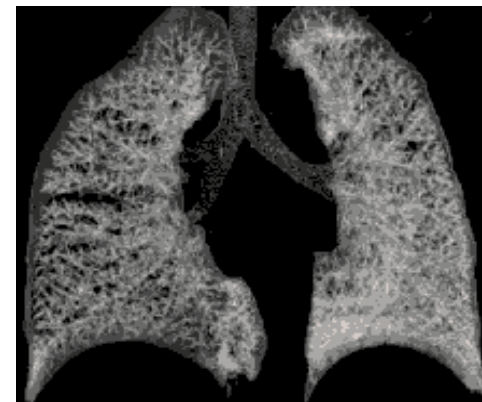
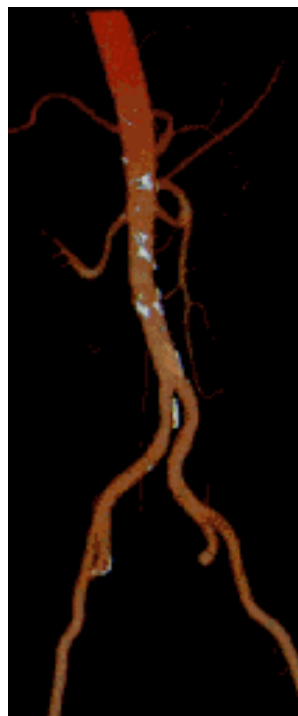

# Cardiac CT

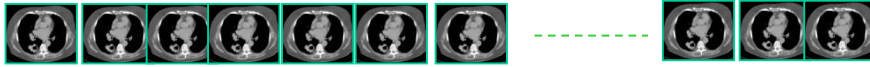

DYNAMIC CT ACQUISITION



ECG

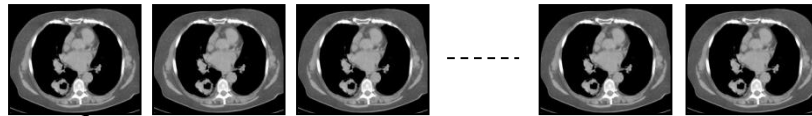

PHASES OF A CARDIAC CYCLE

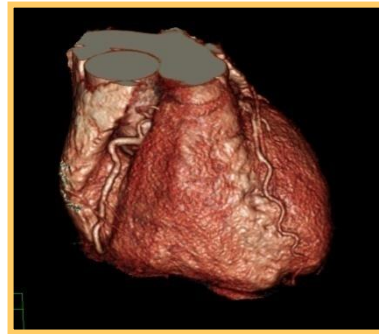
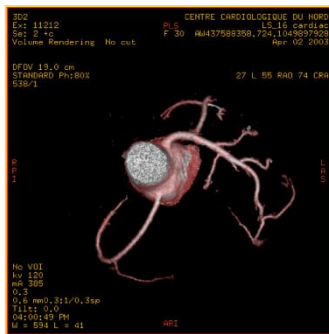
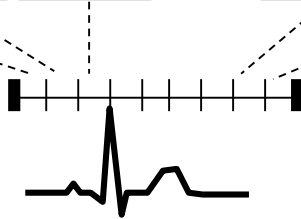

- EJECTION FRACTION
- CARDIAC OUTPUT
- REGIONAL WALL MOTION
- ..

v

msec

FUNCTIONAL PARAMETERS

VOLUME RENDERED IMAGE OF HEART AND VESSELS

All **radionuclides** commonly administered to patients in nuclear medicine are *artificially* produced

Three production routes:

- **(n,  $\gamma$ ) reactions (nuclear reactor)**: the resulting nuclide has the same chemical properties as those of the target nuclide
- **Fission (nuclear reactor)** followed by separation
- **Charged particle induced reaction (cyclotron)**: the resulting nucleus is usually that of a different element

# Positron Emission Tomography (PET)

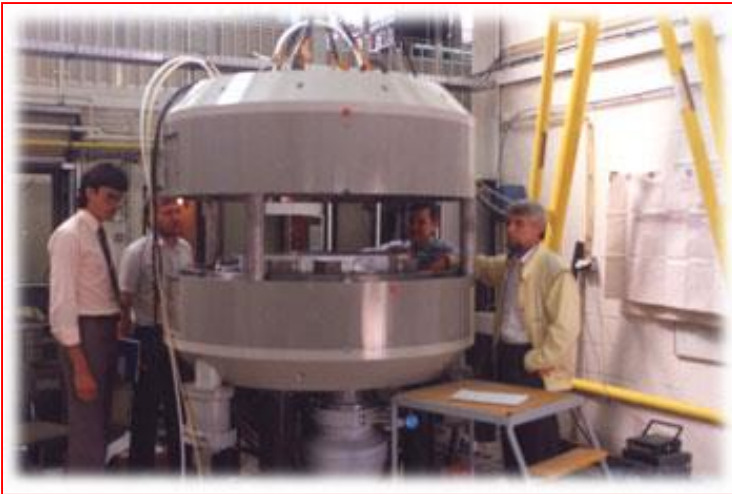

Cyclotron

Radiochemistry



ISOTOPES	Half-Life	
11-C	20.4 min,	"natural"
13-N	10.0 min	"natural"
15-O	2.0 min	"natural"
18-F	109.8 min	"pseudo-natural"

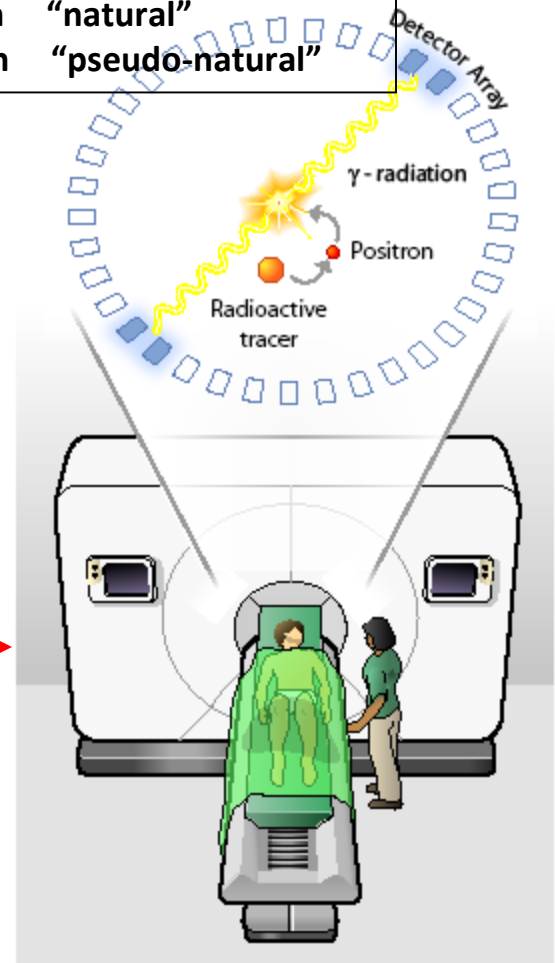

PET camera



# Positron Emission Tomography (PET)

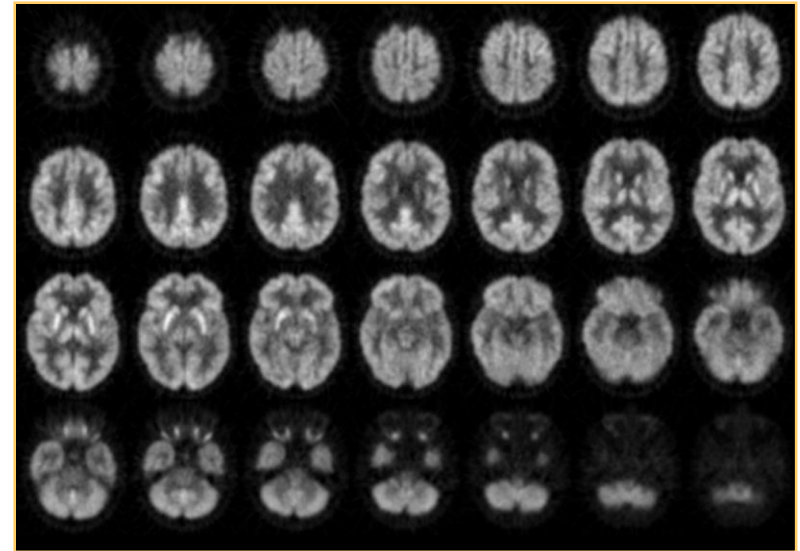
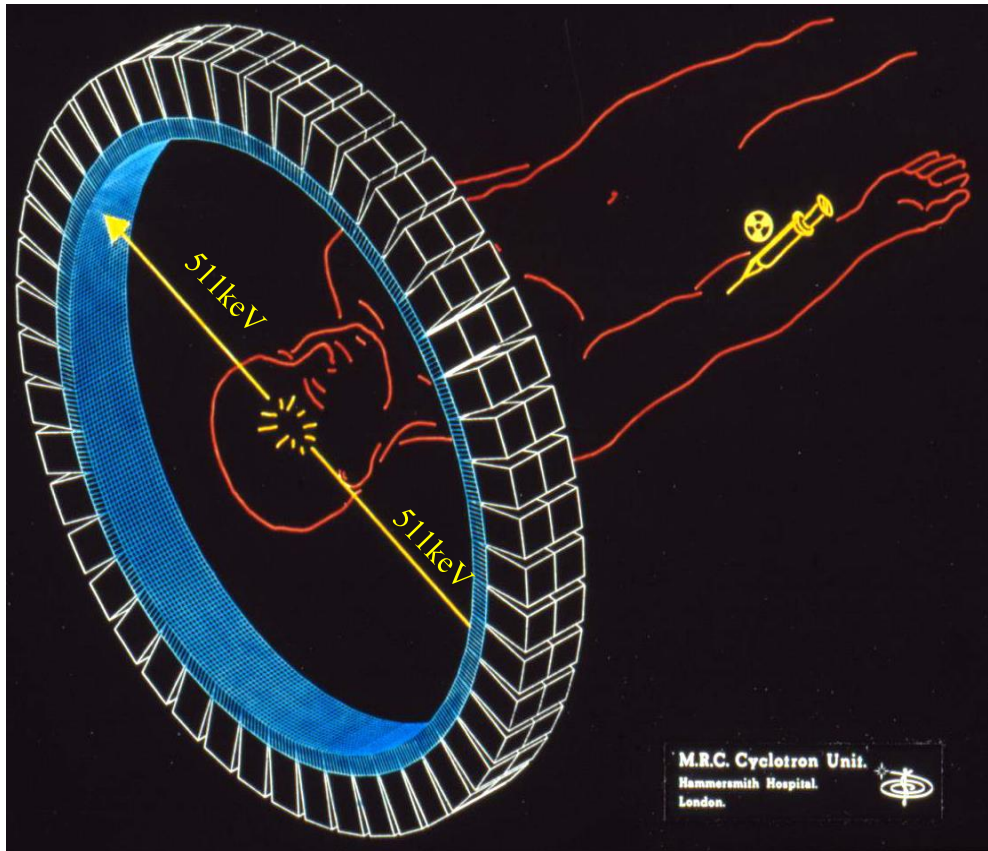

COVERAGE:

~ 15-20 cm

SPATIAL RESOLUTION:

~ 5 mm

SCAN TIME to cover an entire organ:

~ 5 min

CONTRAST RESOLUTION:

depends on the radiotracer

# PET functional receptor imaging

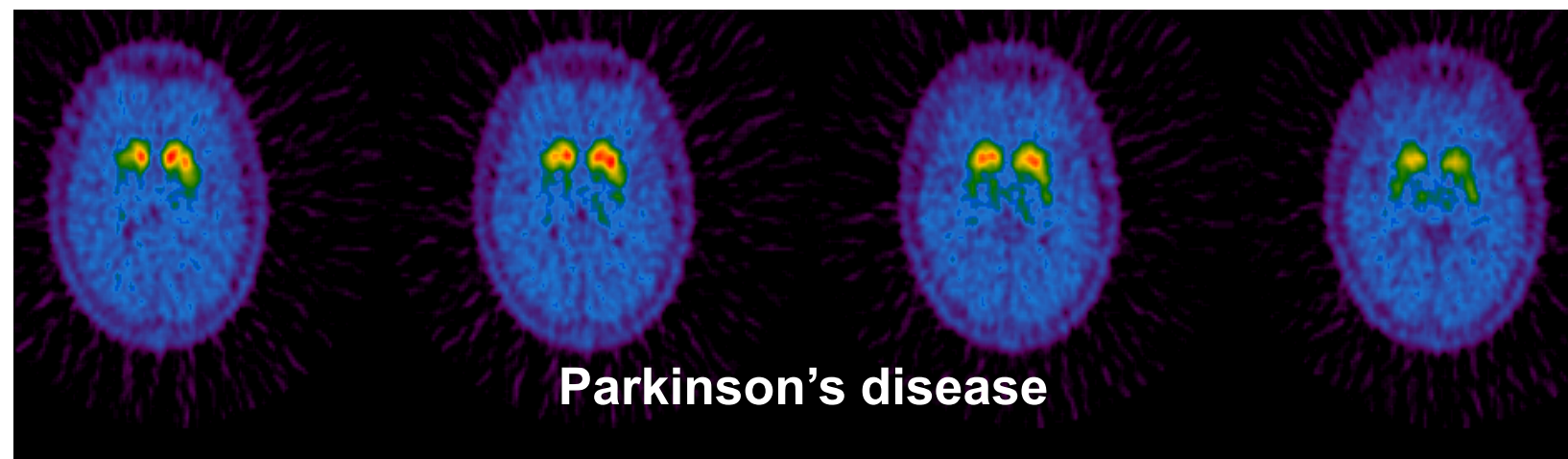
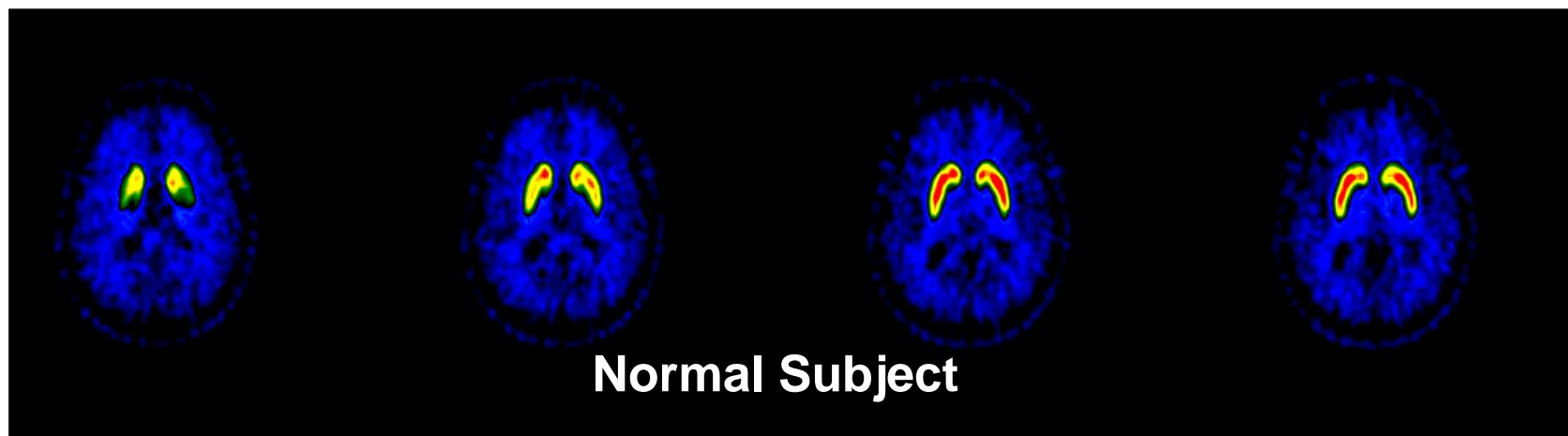

**[<sup>11</sup>C] FE-CIT**

Courtesy HSR MILANO

# PET coverage and axial sampling

---

## FIRST GENERATION PET

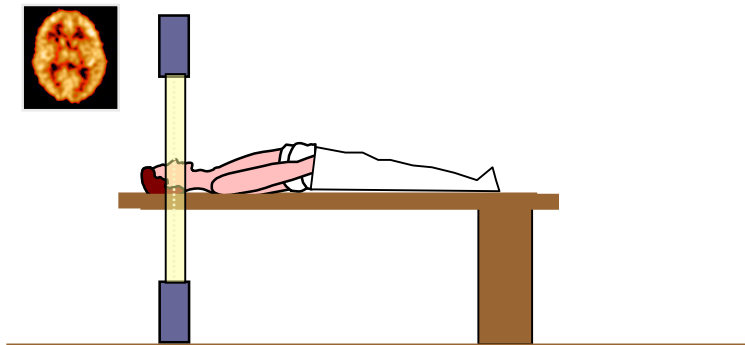

1 SLICE – 2 cm

## CURRENT GENERATION PET

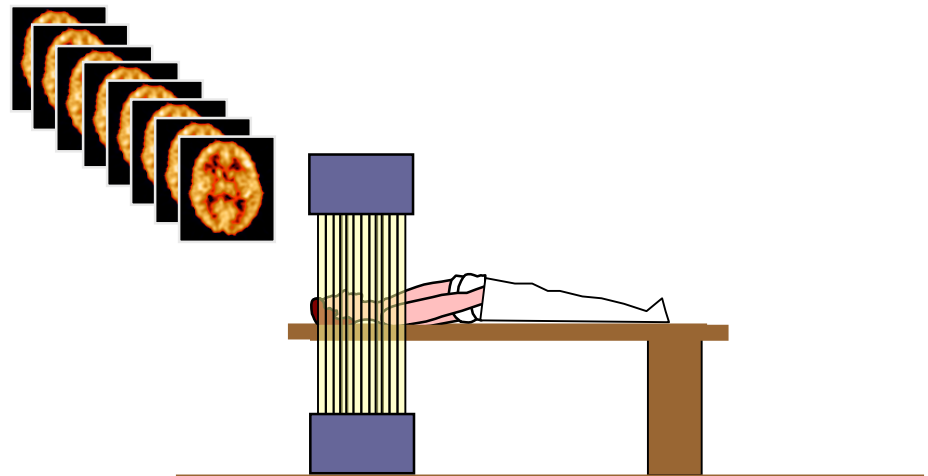

> 40 SLICES – 6 mm  
Axial FOV: 15 – 20 cm

# PET: total body studies

TRANSAXIAL  
IMAGES

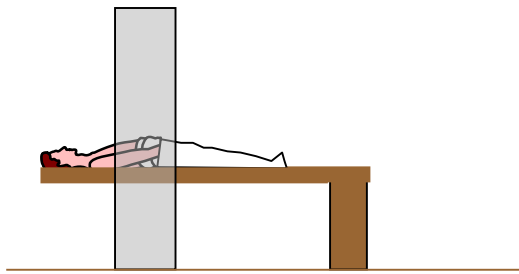
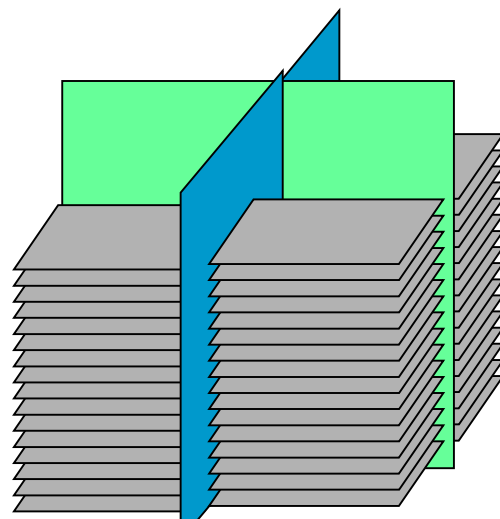

CORONAL

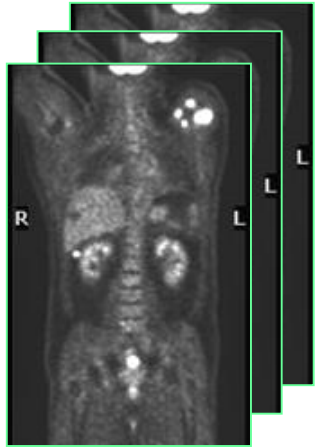

SAGITTAL

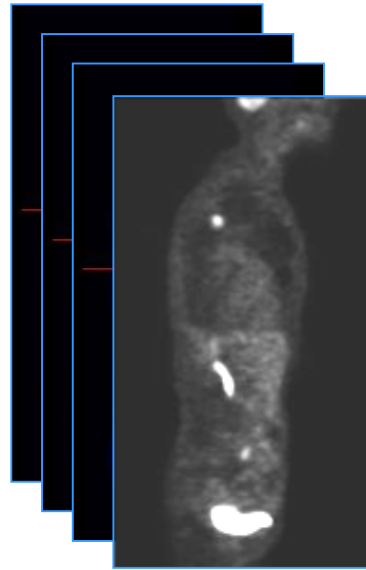

# PET/CT scanner

---

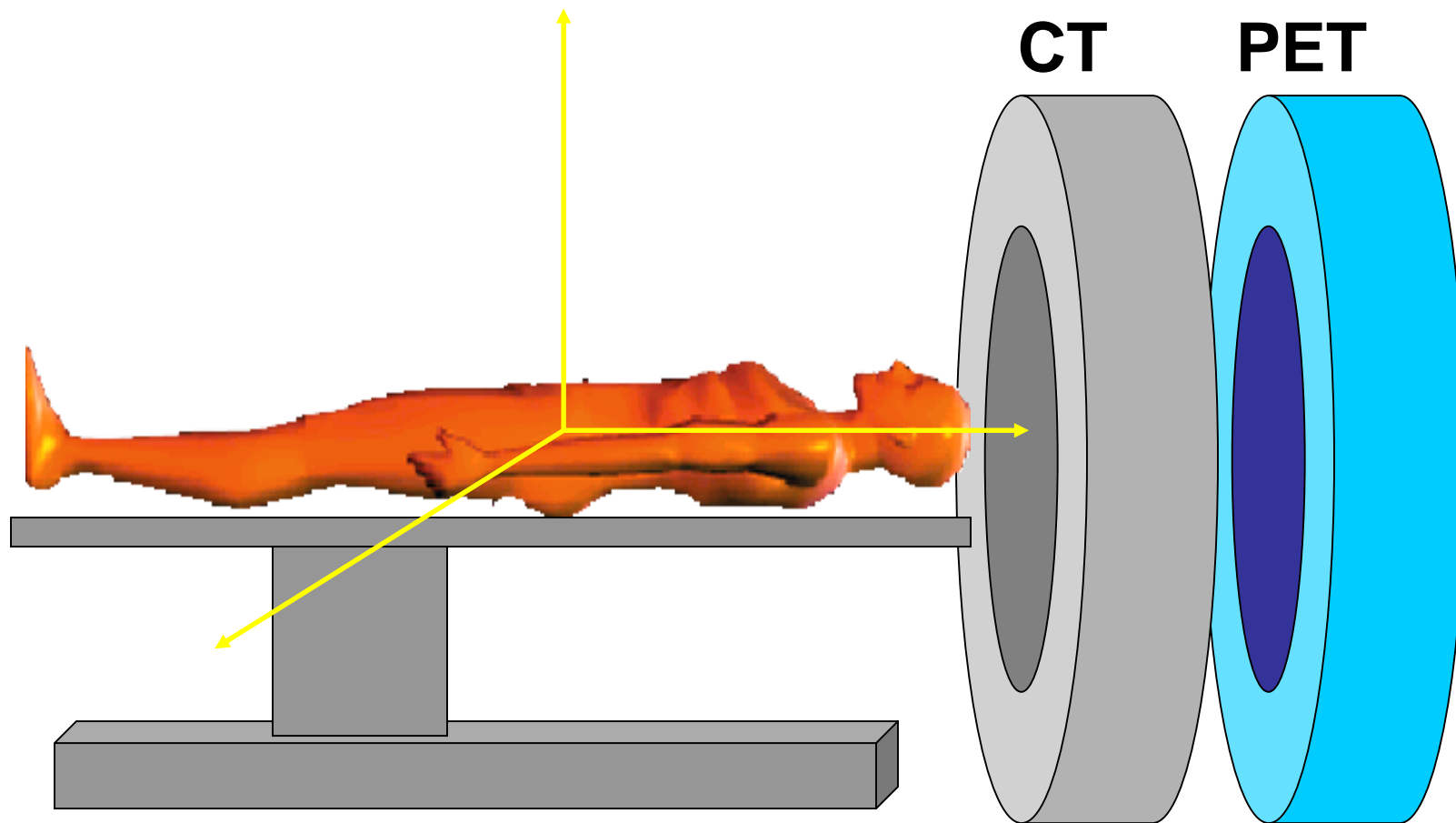

# PET/CT scanner

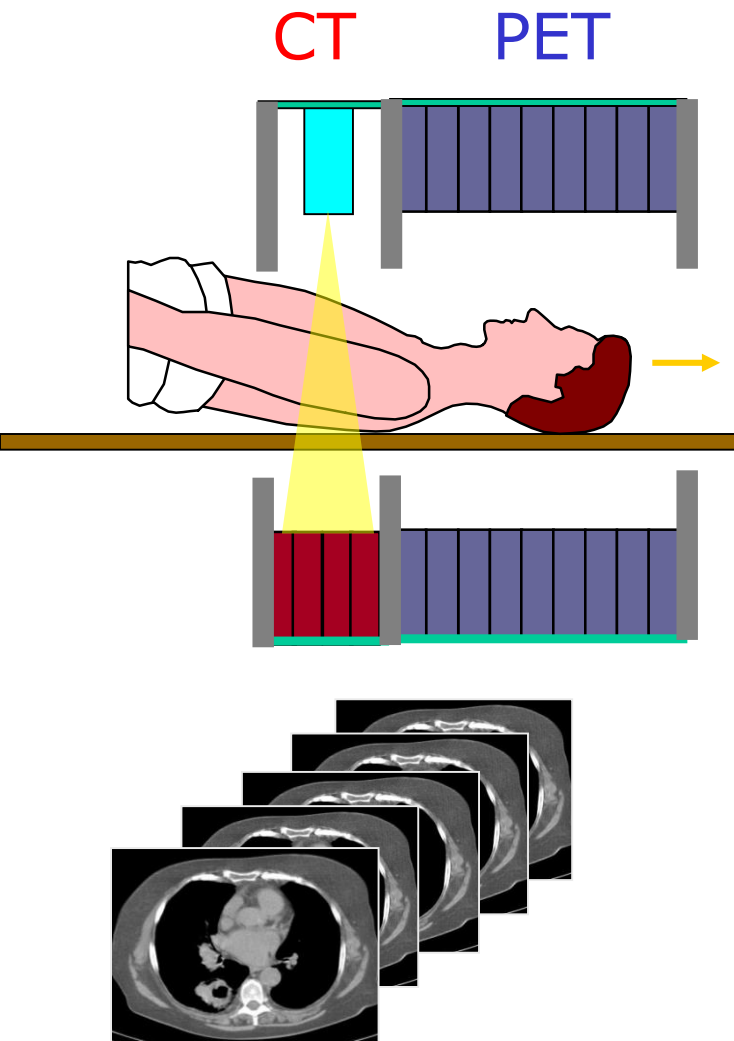

Courtesy HSR MILANO

# PET/CT scanner

CT    PET

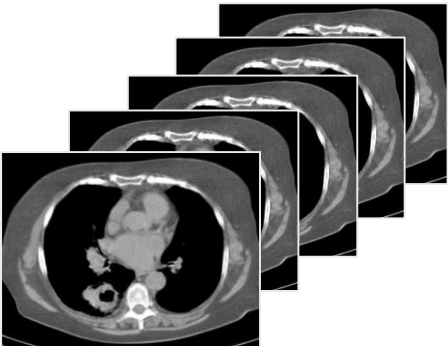
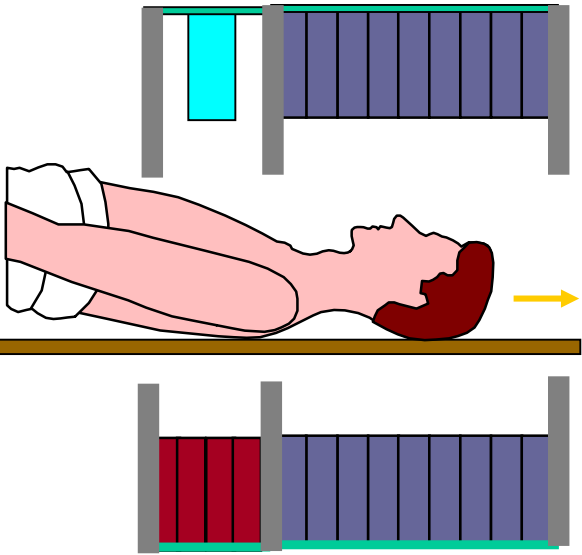

CT    PET

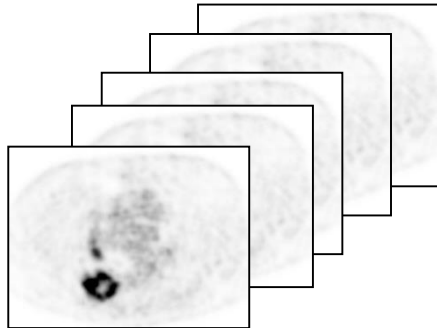
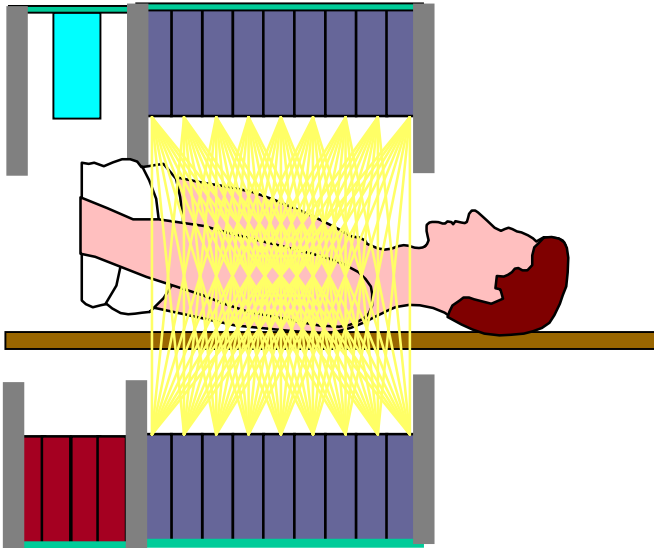

Courtesy HSR MILANO

# $^{18}\text{F}$ -FDG PET/CT

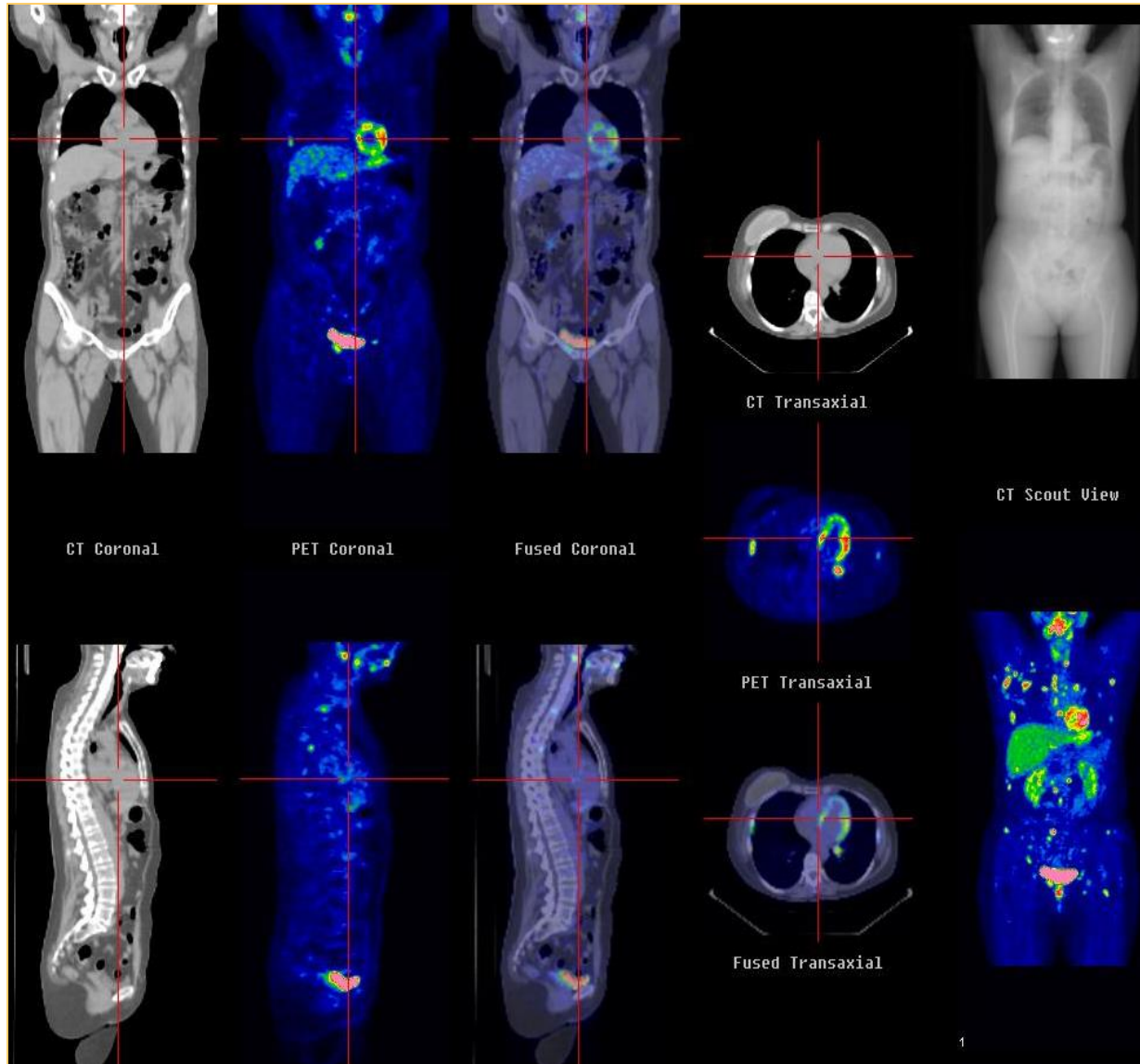

Courtesy HSR MILANO



# A look into the future: whole-body PET

---

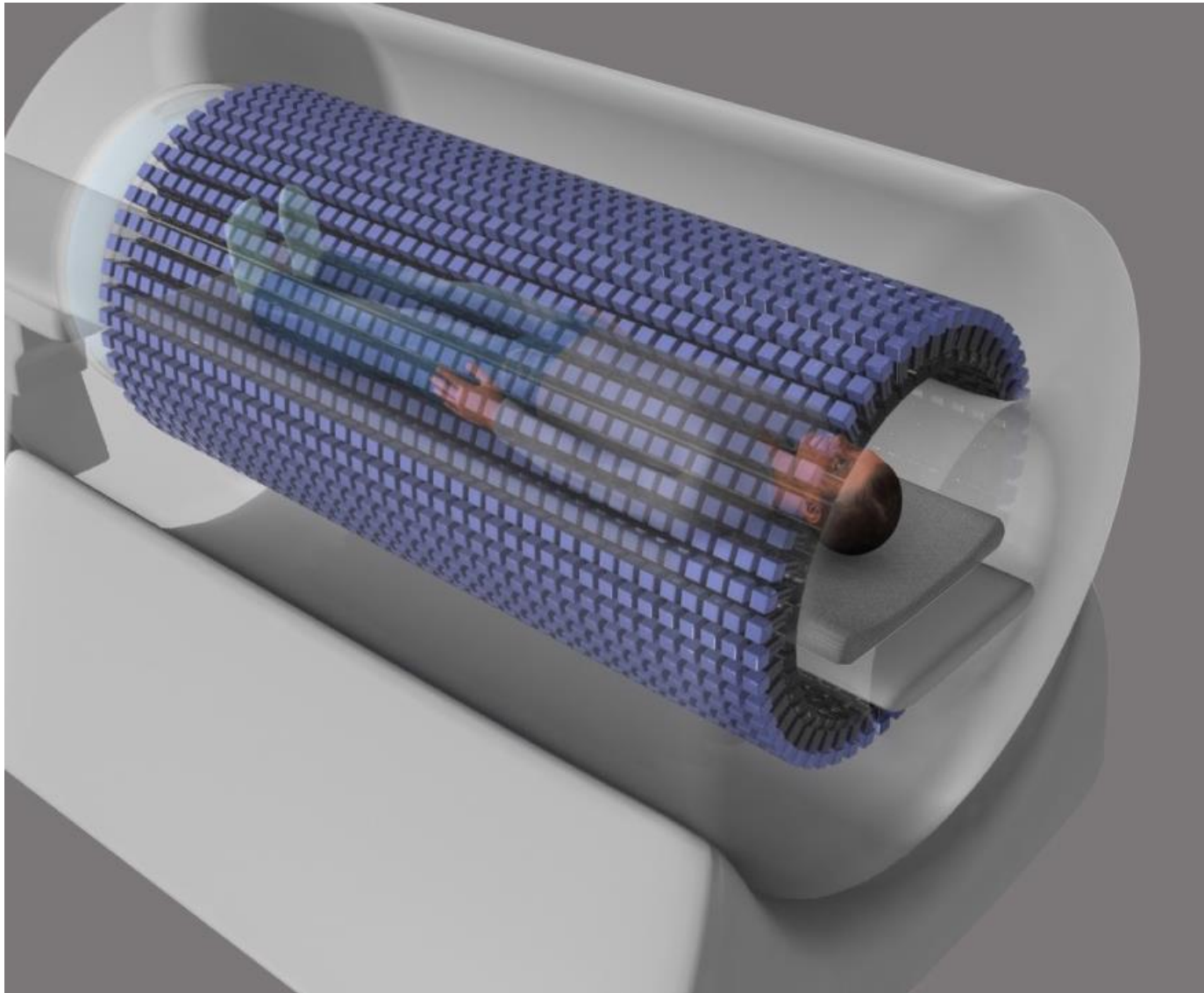

# A look into the future: MARS CT



The New York Times

TRILOBITES

## 3-D Color X-Rays Could Help Spot Deadly Disease Without Surgery

A new medical scanner, derived from technology used by particle physics researchers at CERN, "is like the upgrade from black-and-white film to color," one of its developers said.

By Emily Baumgaertner

July 17, 2018

f t y



nature

NEWS & COMMENT Research

NEWS • 03 AUGUST 2018

## Whales, scales and moons – July's best science images

The month's sharpest science shots – selected by Nature's photo team.



SCIENCES Avenir

NTS

### IAGES. Premières radiographies couleur 3D

Sciences et Avenir avec AFP le 13.07.2018 à 15h06

scientifiques néo-zélandais ont réalisé la toute première radiographie couleur en trois dimensions (3D) d'un corps humain. La technique employée pourrait contribuer à améliorer le diagnostic médical, selon le laboratoire de physique européen du CERN.

Science Home News Journals Topics Careers

X-rays get upgrade to 3D, full color

By Frankie Schemberl | Jul. 18, 2018, 4:10 PM

MARS BIOIMAGING

NEW ZEALAND

## Kiwi 3D scanner could revolutionise x-ray, detect disease

8 Apr, 2018 2:13pm

© 2 minutes to read

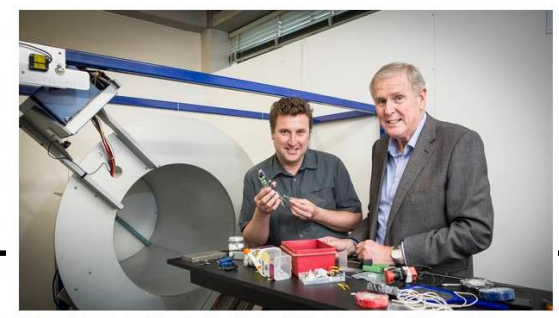

Professor Anthony Butler (left) and his father Professor Phil Butler have built the MARS spectral CT scanner. Photo / University of Canterbury

NZ Herald

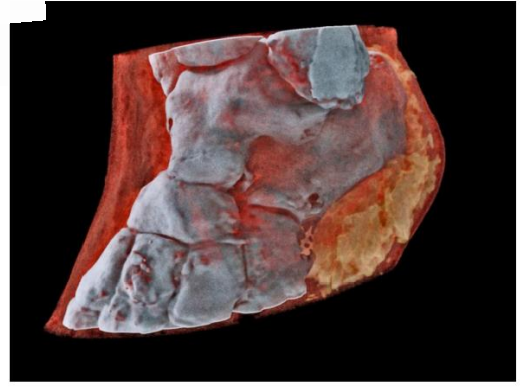

Radiographie 3D d'une cheville en vue frontale où le tissu mou (coloré en rouge) a été rendu translucide pour montrer les os (blanc) et le matériel lipidique (jaune) à l'intérieur de la cheville.

MARS BIOIMAGING LTD



High-school teachers 2019

Silari – Medical Physics

# Outline of the lecture

---

Physics discoveries

Tools for physics applied to medicine

Medical imaging

X-ray CT

PET and PET/CT

Photon/electron radiation therapy

Hadron therapy

# Three classes of medical accelerators

Electron linacs for conventional radiation therapy, including advanced modalities:

- Cyberknife
- IntraOperative RT (IORT)
- Intensity Modulated RT



Low-energy cyclotrons for production of radionuclides for medical diagnostics

Medium-energy cyclotrons and synchrotrons for hadron therapy with protons (250 MeV) or light ion beams (400 MeV/u  $^{12}\text{C}$ -ions)

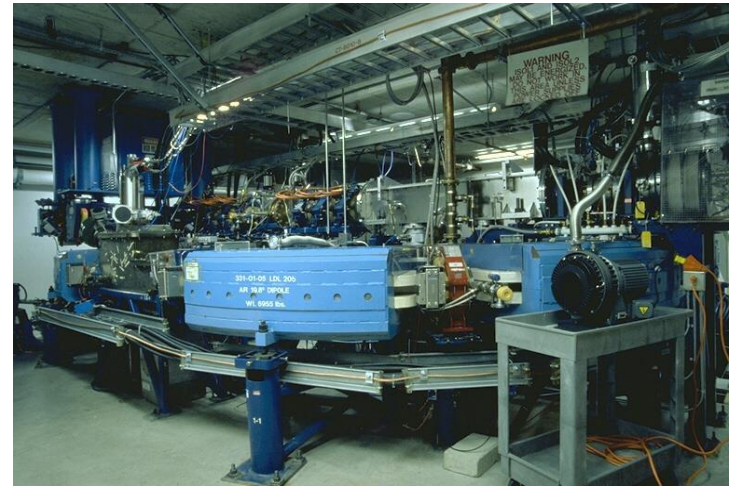

# Availability of radiation therapy worldwide

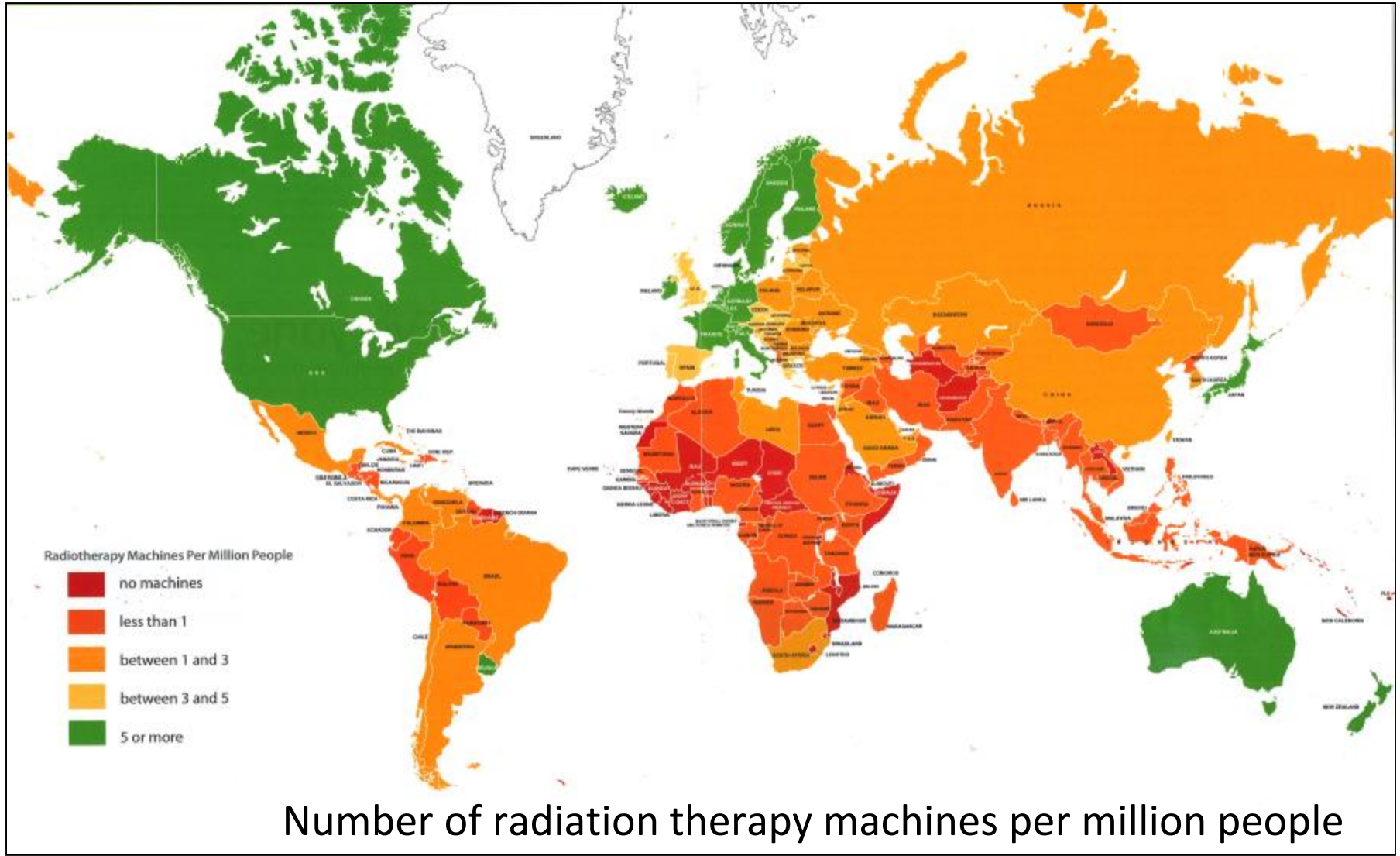

# Treatment planning and dose delivery to tumour volume

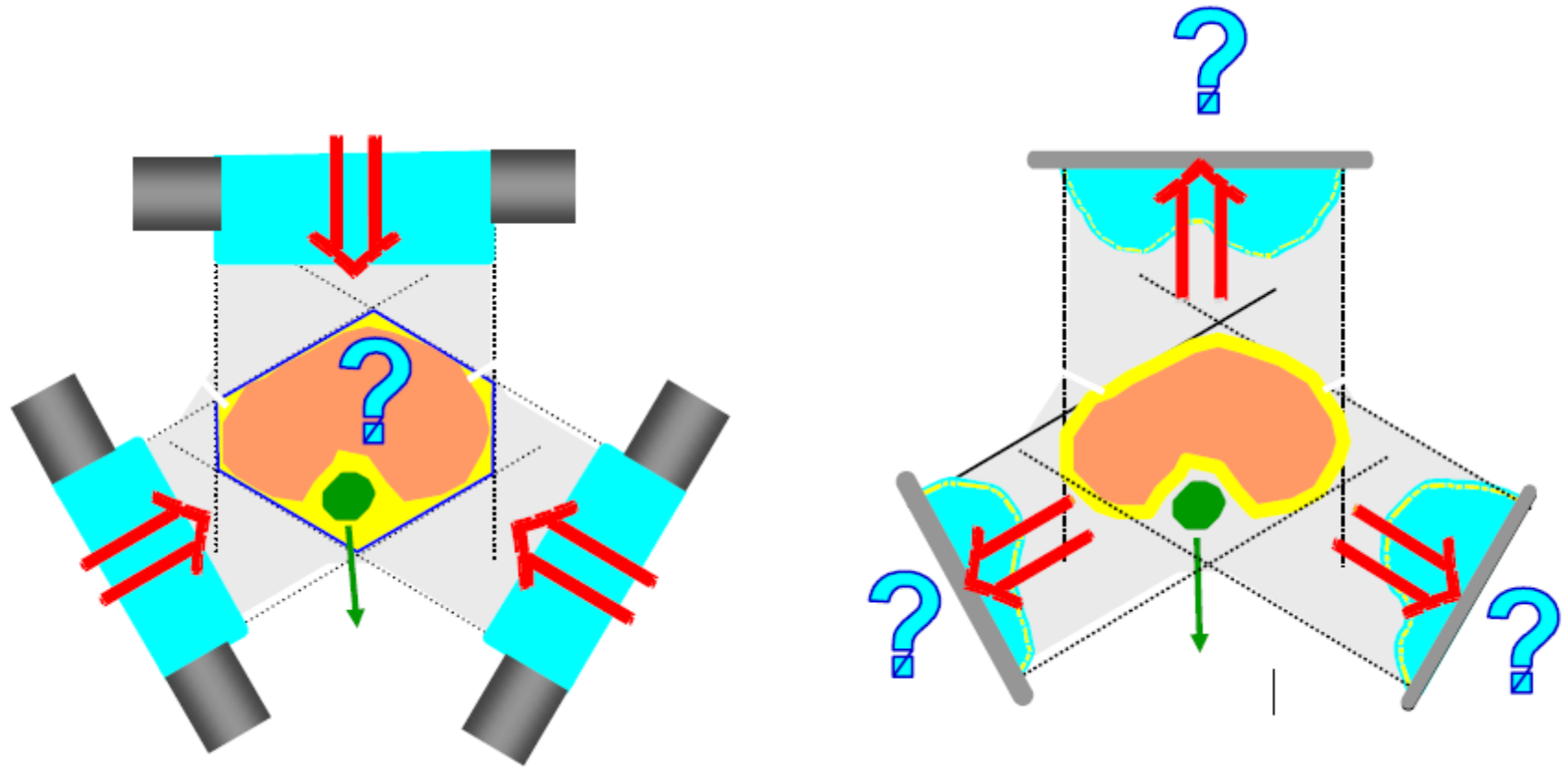

# Tumour control and therapeutic window

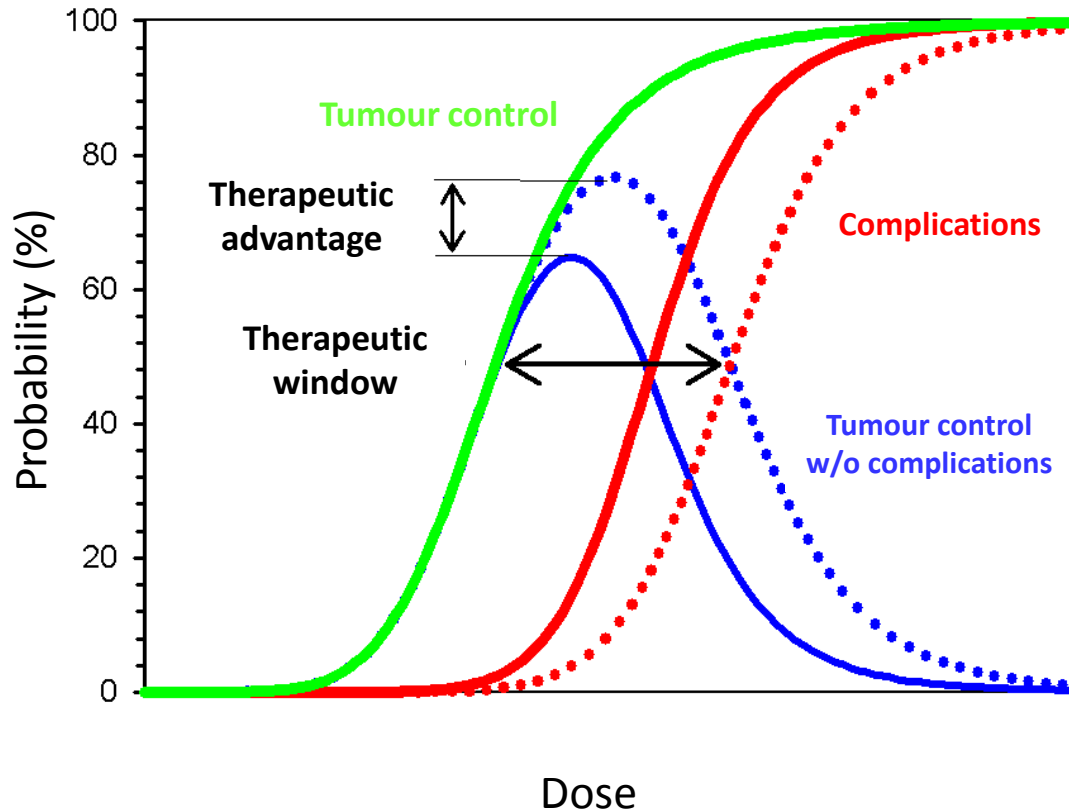

# X-rays in radiation therapy: medical electron linacs

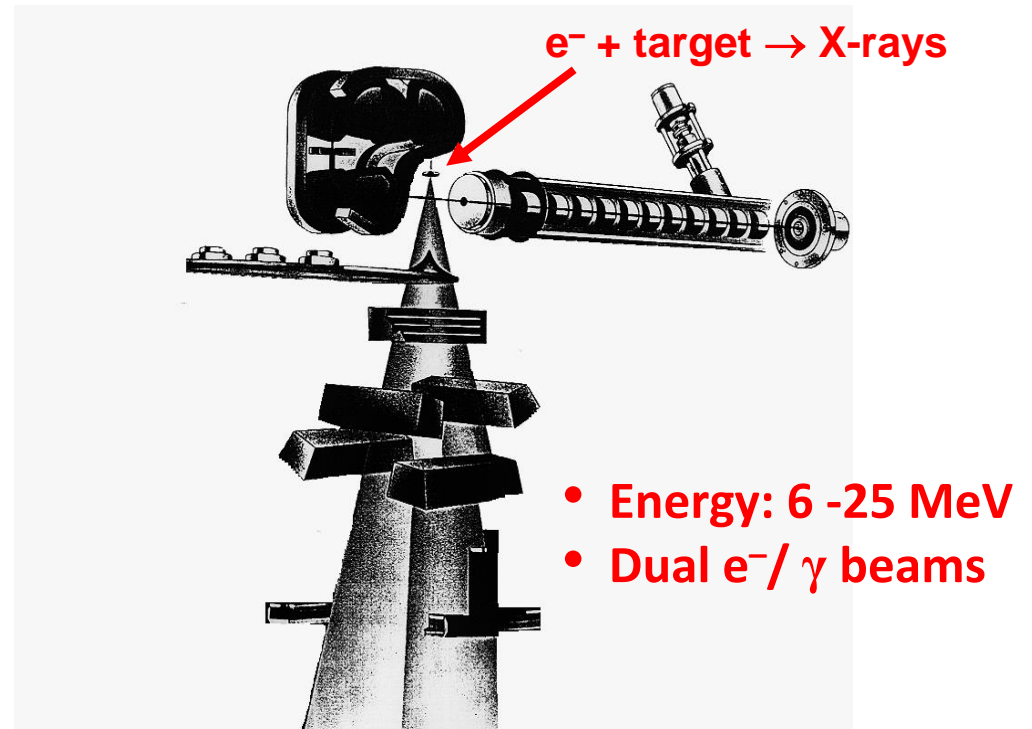
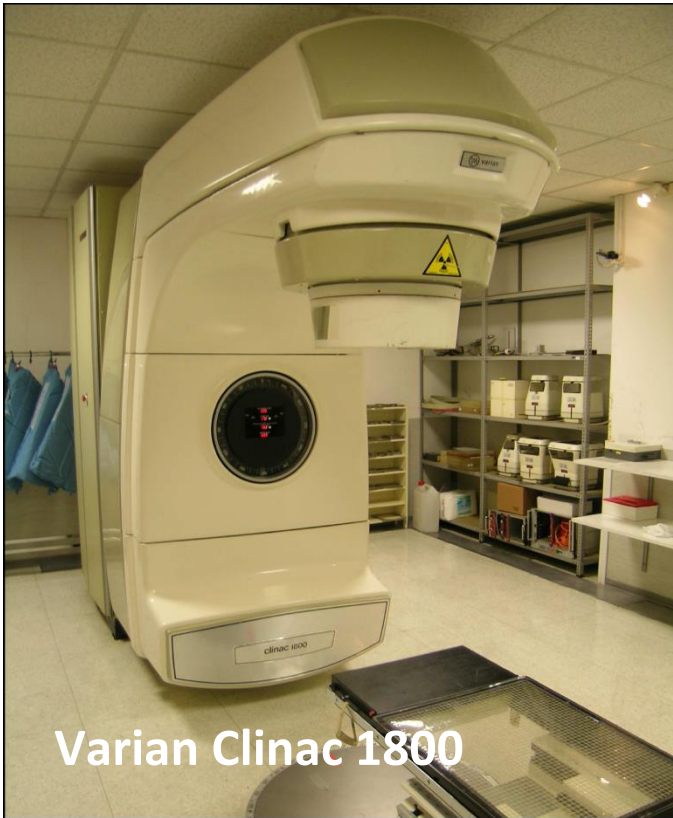

Multi-leaf collimator

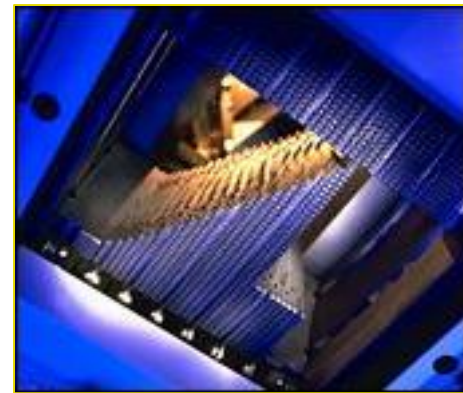



# Intra-Operative Radiation Therapy (IORT)



- Small electron linac
- Energy 6 – 12 MeV
- Treatment with electrons only
- Single irradiation
- Three models of linac produced by three manufacturers (two in Italy)



# CyberKnife (CK) Robotic Surgery System

6 MV Linac mounted on a robotic arm



- Non-Isocentric
- Average dose delivered per session is 12.5 Gy
- 6 sessions/day
- Dose rate @ 80 cm = 400 cGy/min

<http://www accuray.com/Products/Cyberknife/index.aspx>

# Intensity Modulated Radiation Therapy

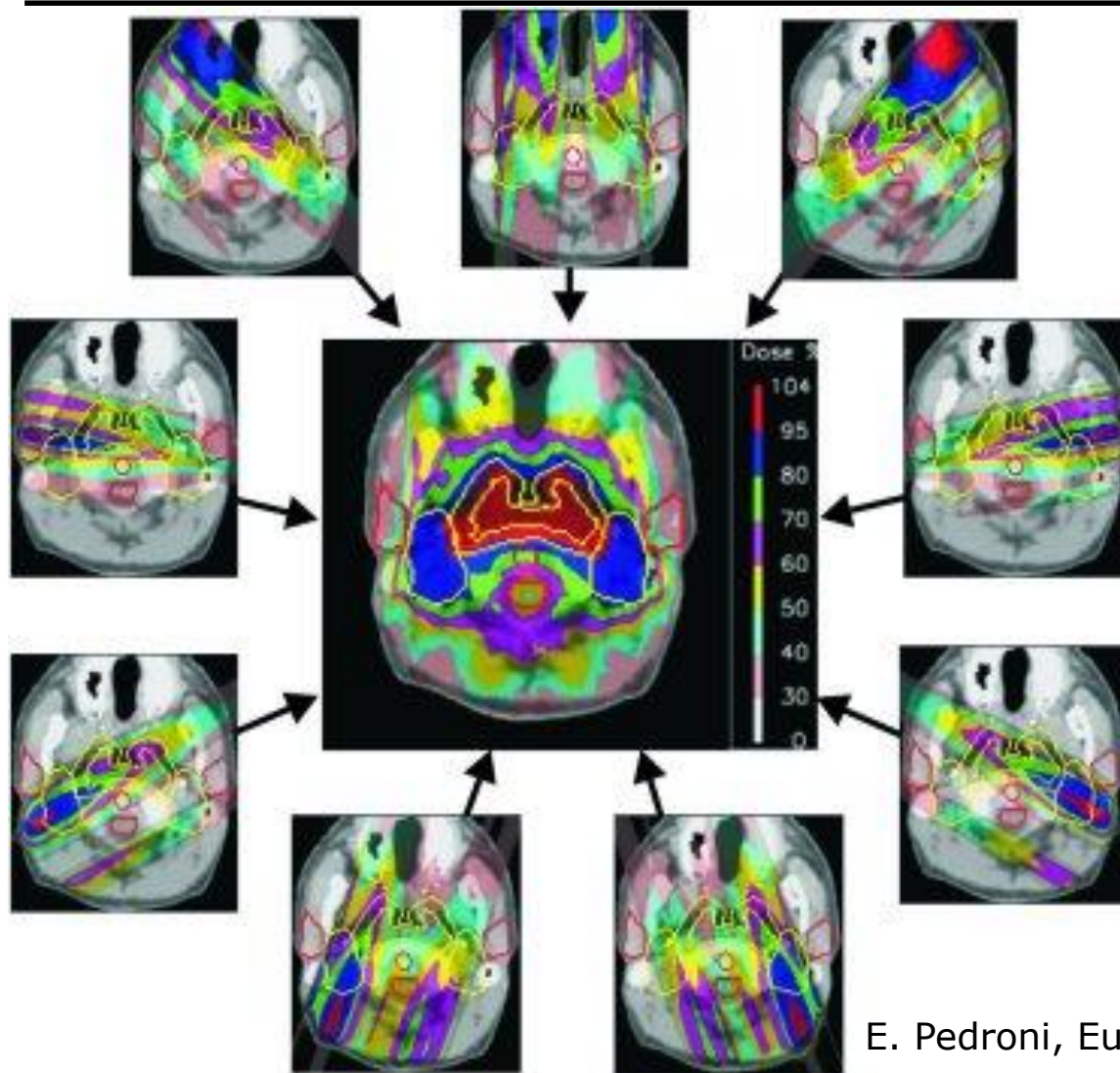

An example of intensity modulated treatment planning with photons. Through the addition of 9 fields it is possible to construct a highly conformal dose distribution with good dose sparing in the region of the brain stem (courtesy of T. Lomax, PSI).

E. Pedroni, Europhysics News (2000) Vol. 31 No. 6

Yet X-rays have a comparatively poor energy deposition as compared to protons and carbon ions

# Helical tomotherapy

---

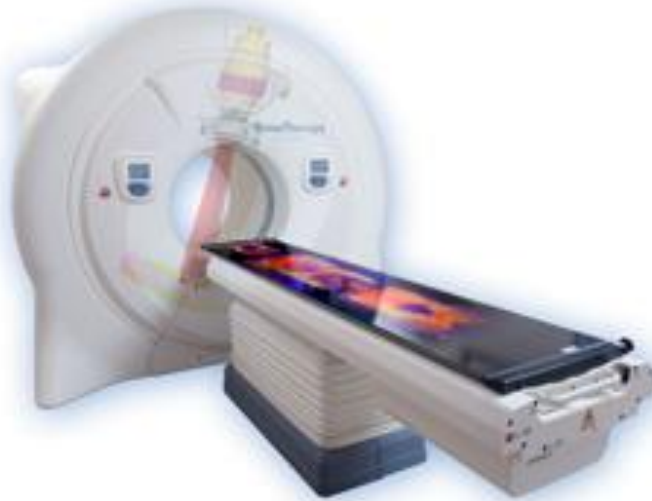

www.tomotherapy.com

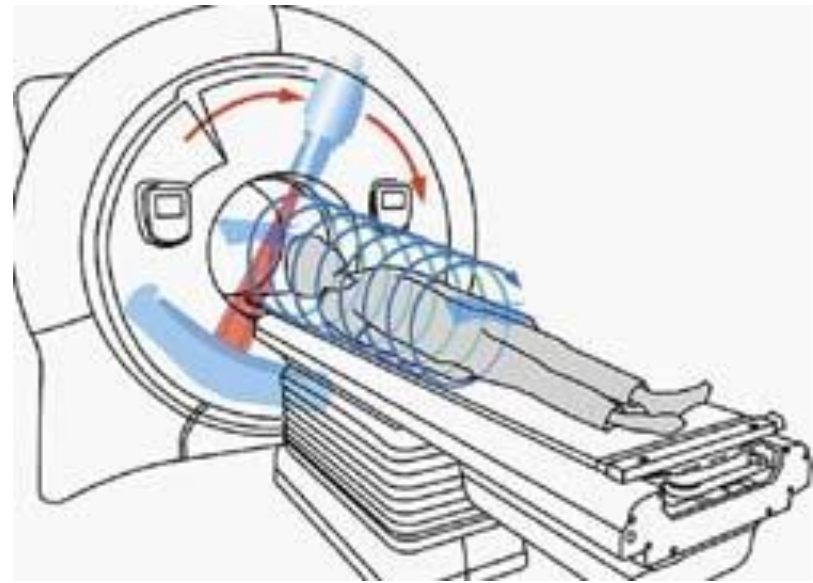

- **Integrated CT guidance**
  - Integrated CT scanner allowing efficient 3D CT imaging for ensuring the accuracy of treatment
- **A binary multi-leaf collimator (MLC)** for beam shaping and modulation
- **A ring gantry design** enabling TomoHelical delivery
  - As the ring gantry rotates in simultaneous motion to the couch, **helical fan-beam IMRT** is continuously delivered from all angles around the patient
- Very large volumes can be treated in a single set-up

# MRI-guided radiation therapy

## Dedicated sequences for MRI guided radiotherapy treatments

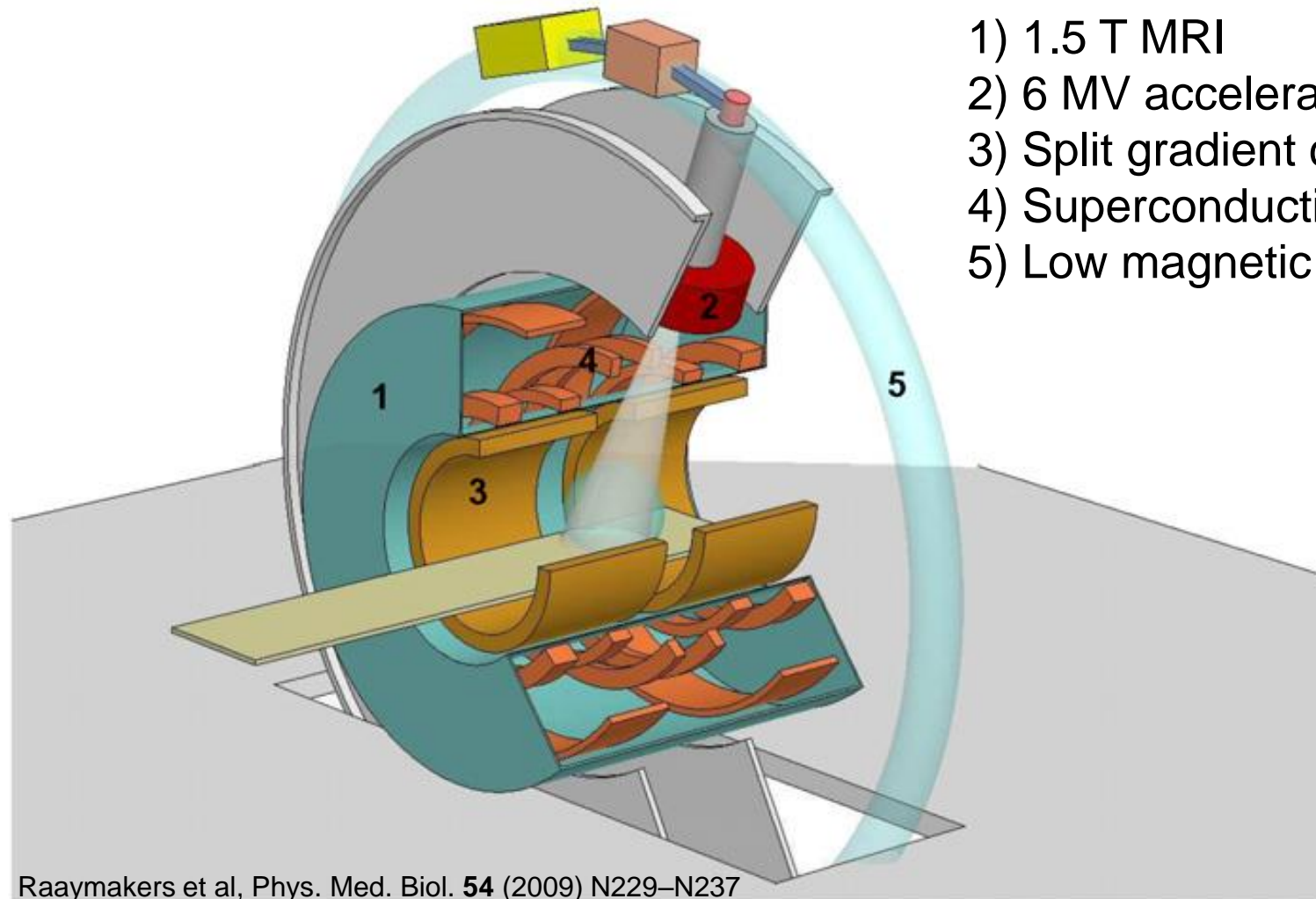

- 1) 1.5 T MRI
- 2) 6 MV accelerator
- 3) Split gradient coil
- 4) Superconducting coils
- 5) Low magnetic field toroid

Raaymakers et al, Phys. Med. Biol. **54** (2009) N229–N237

# Hadrontherapy: n, p and C-ion beams

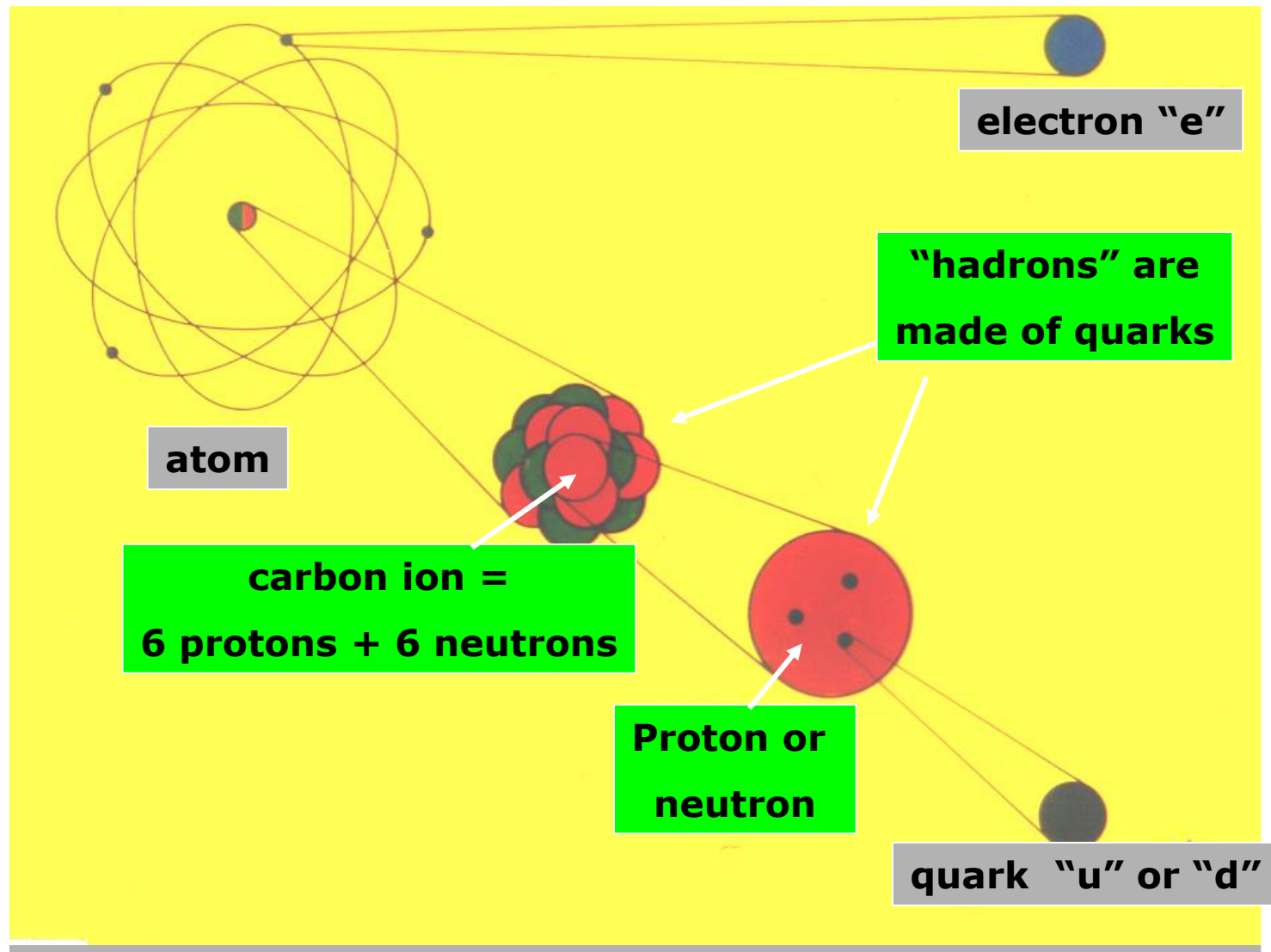

# Proton radiation therapy

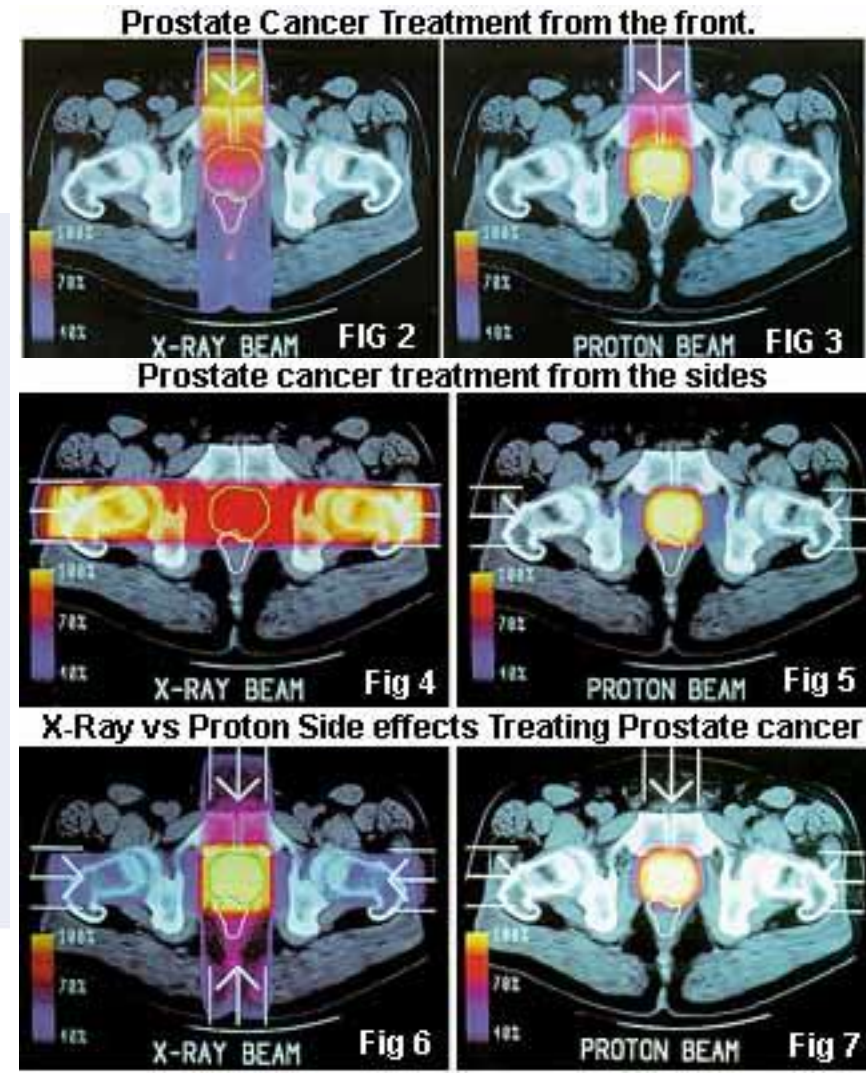
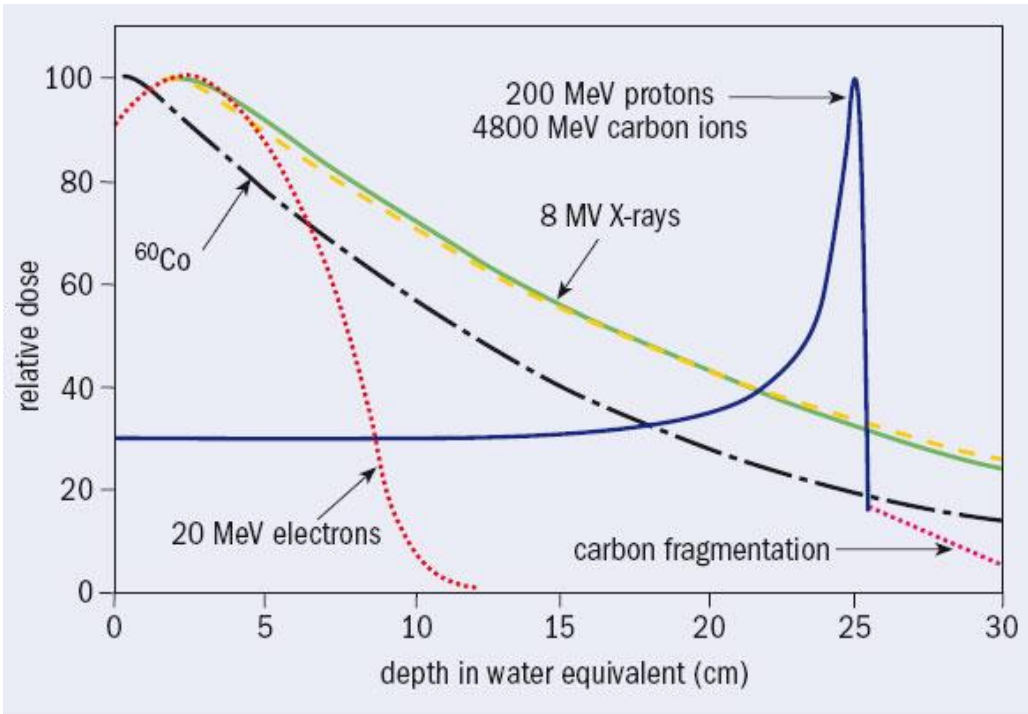

## Treatment planning

- *Ion beam therapy is more conformal than photon beam RT*
- *Sharper dose fall off*
- *Range of ions much more influenced by tissue heterogeneities than photon beams with direct impact on TCP and NTCP*
- *Image guidance is necessary for ion beam therapy*

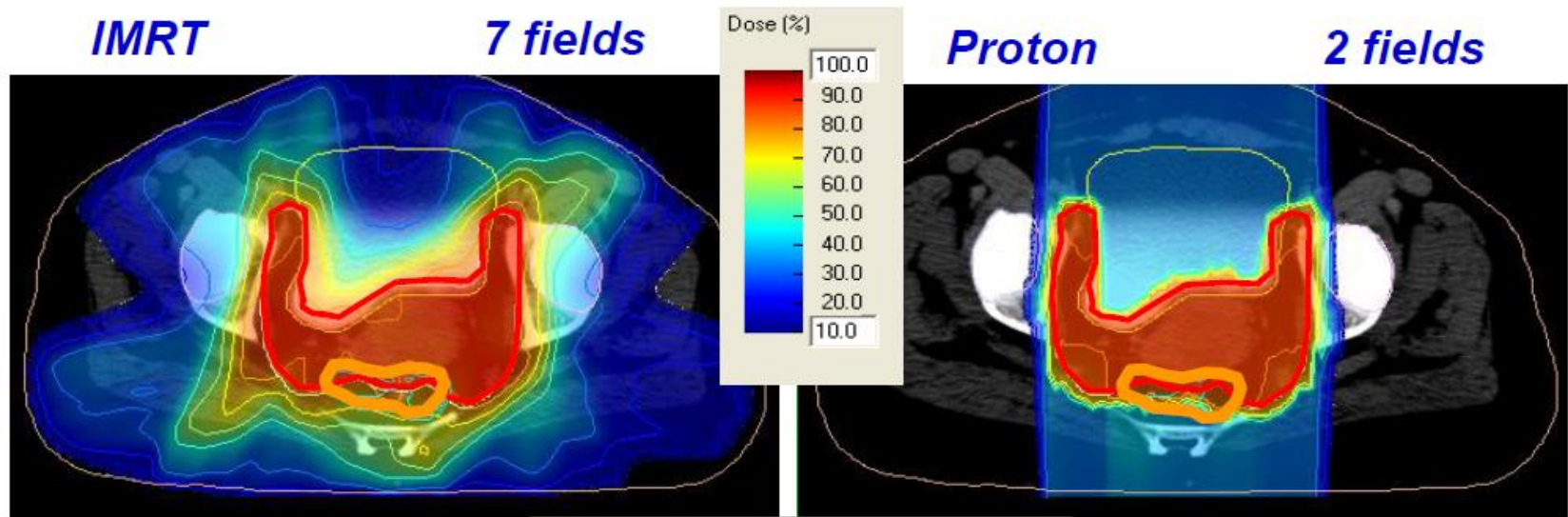



# Radiobiological effectiveness (RBE)

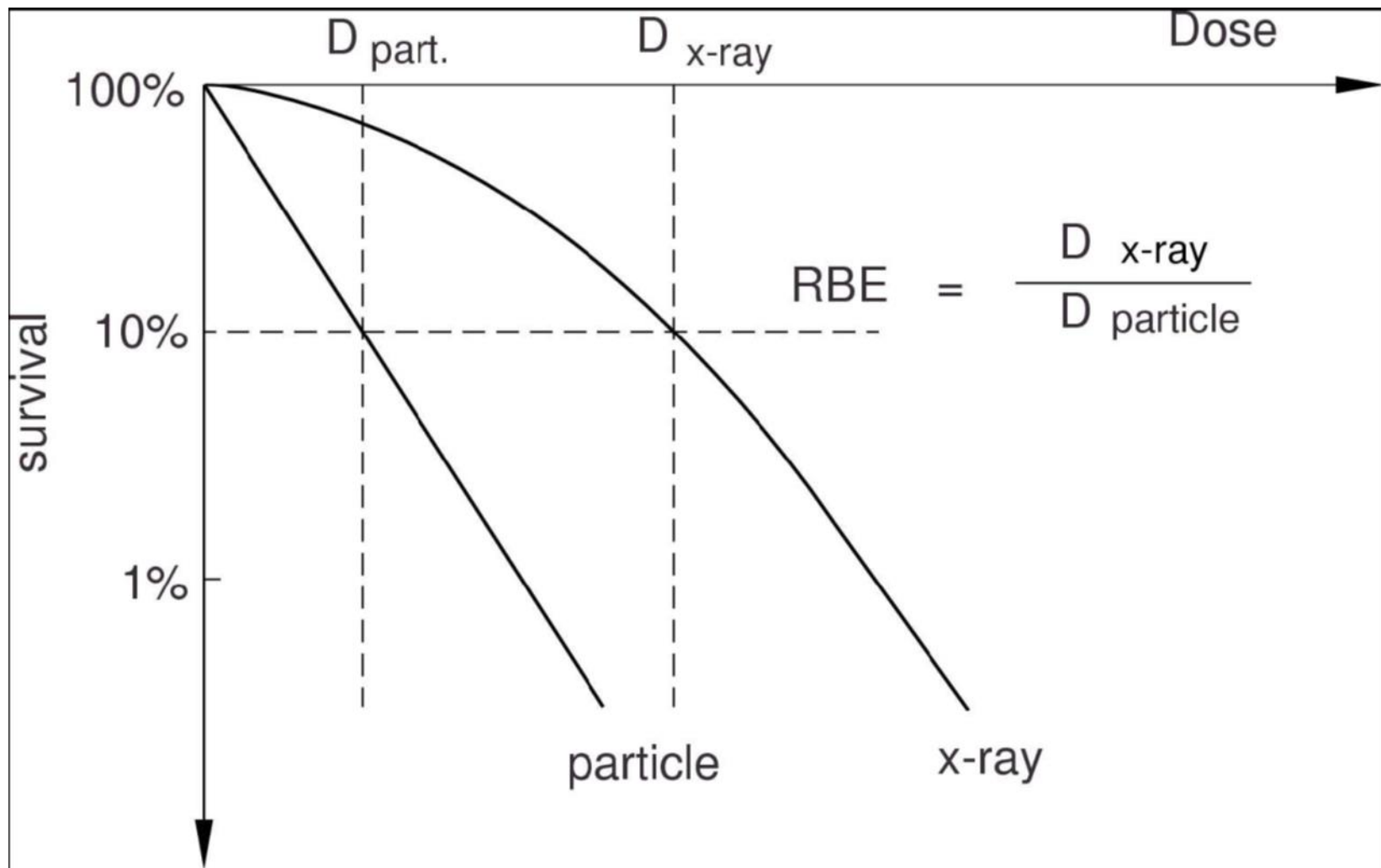

# Hadrontherapy

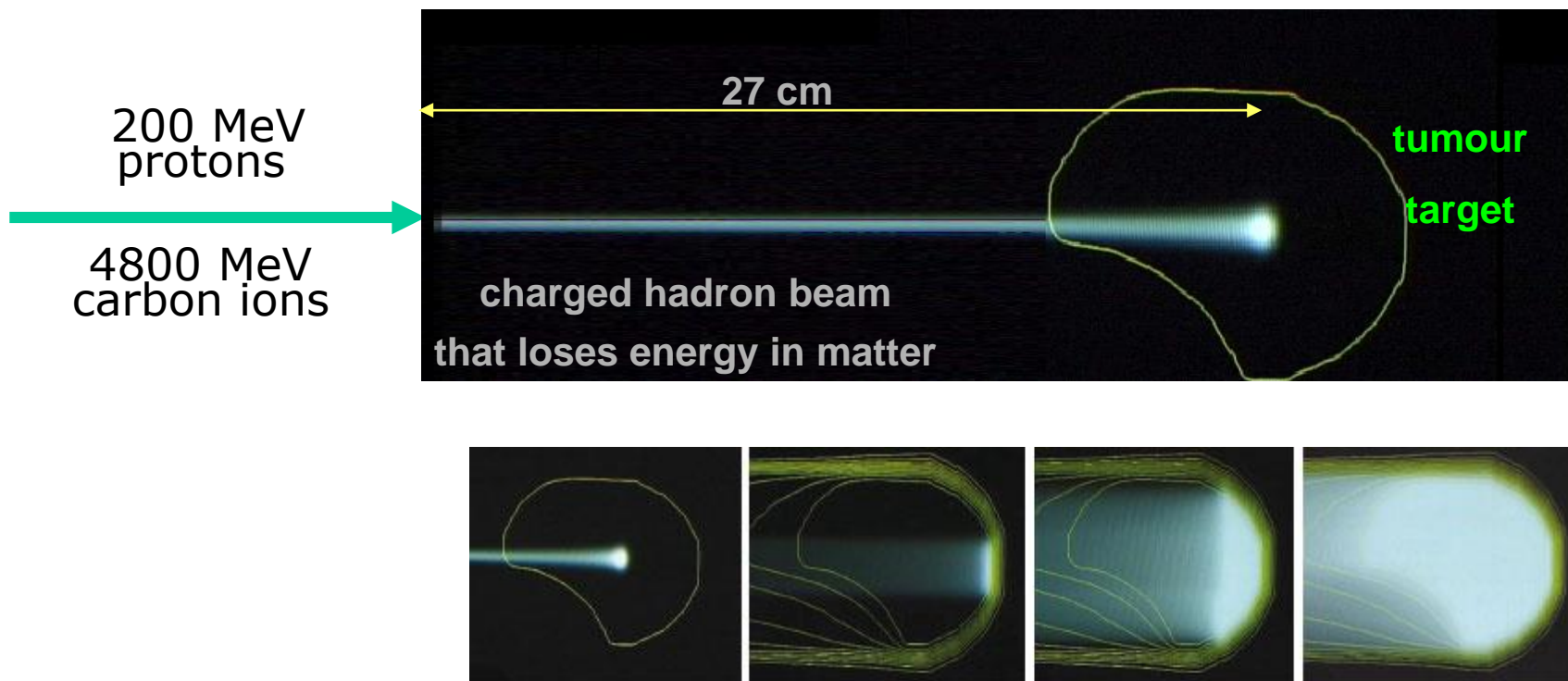

# Hadrontherapy in Europe and worldwide

Particle Therapy Facilities worldwide

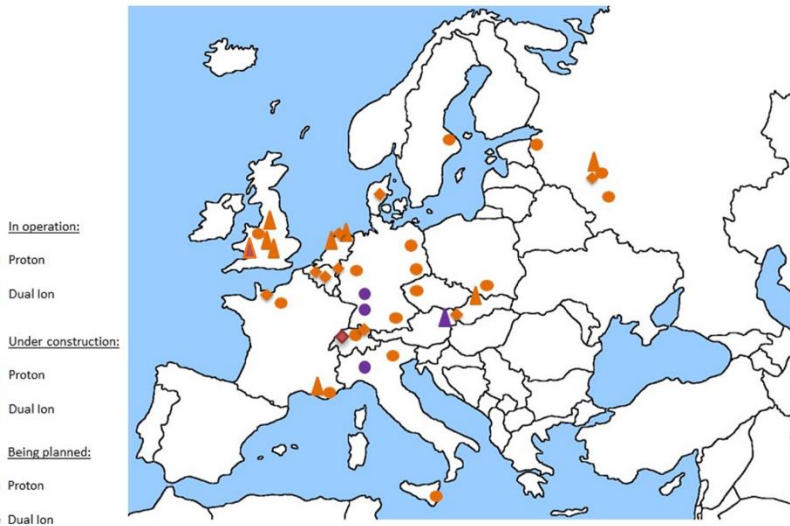
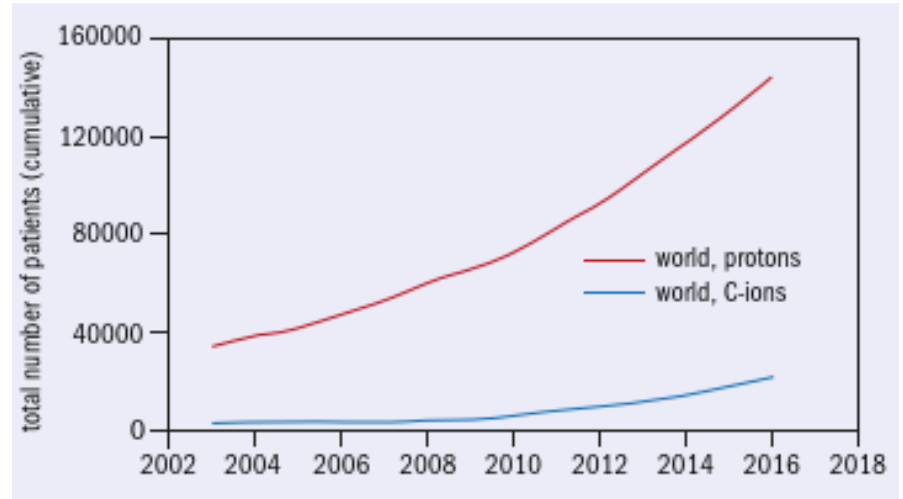
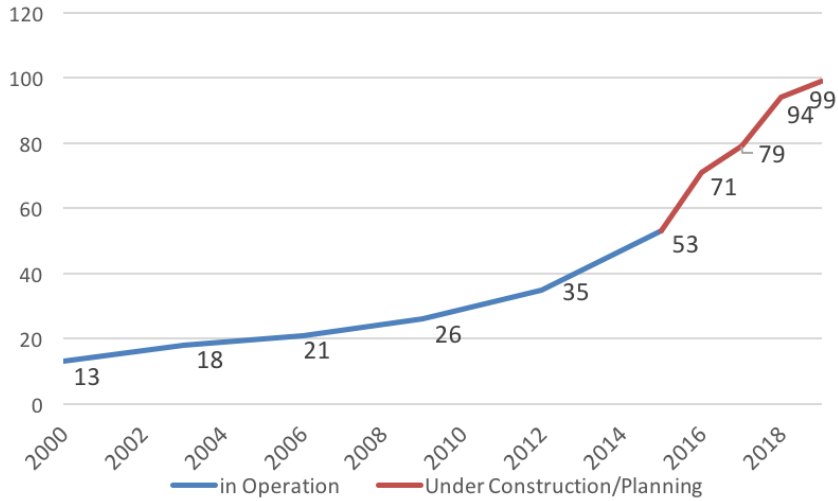

CERN Courier Jan/Feb 2018

# Proton radiation therapy



**Accel-Varian**

**Loma Linda  
(built by FNAL)**

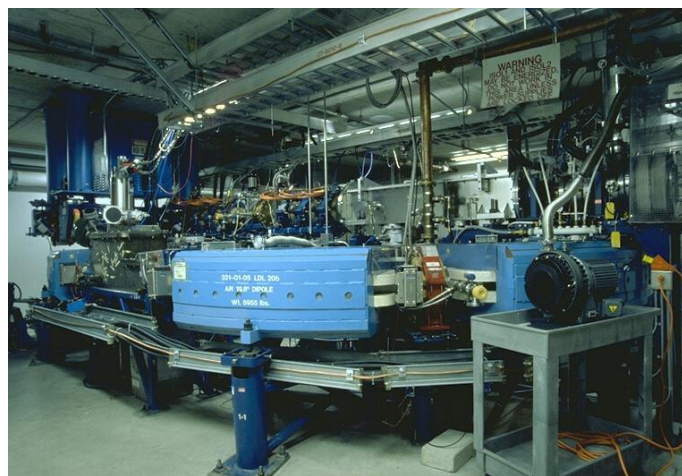

# Isocentric gantry

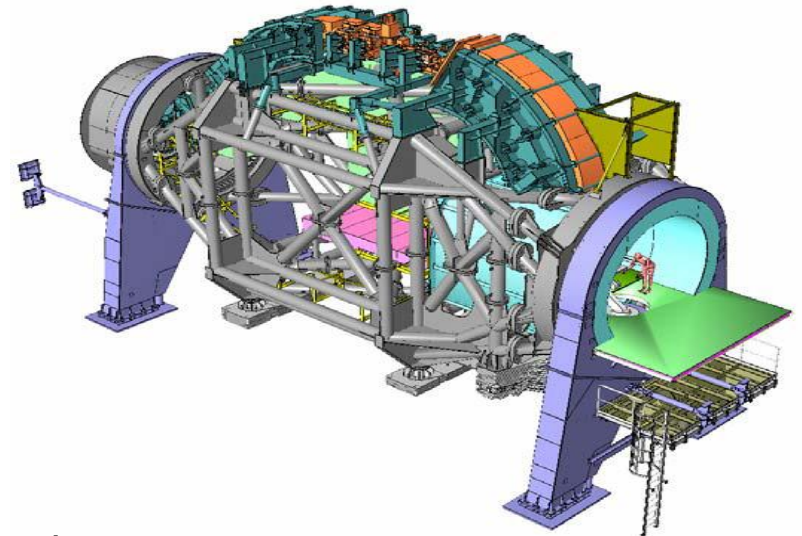
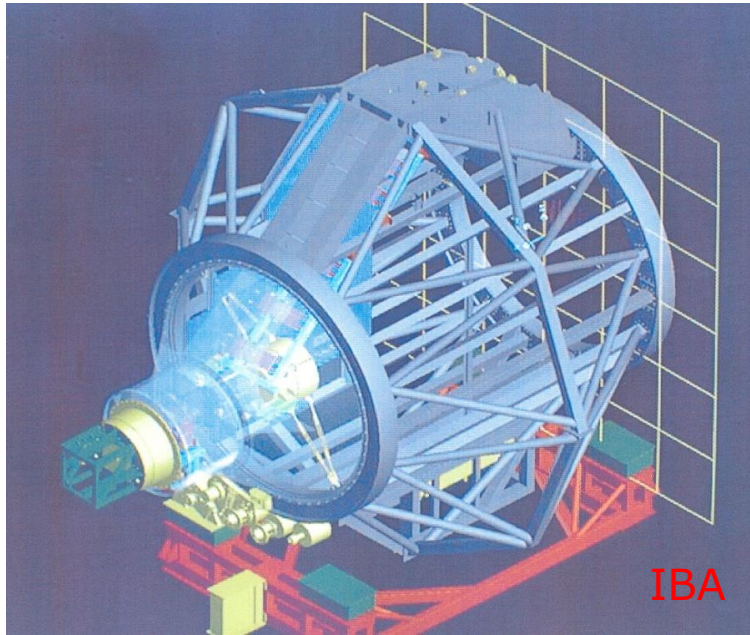

A gantry is a massive structure that allows directing the beam to the tumour from any direction. It carries:

- the final section of the beam line
- the beam spreading 'nozzle'
- the proton 'snout' which carries the aperture and range compensator

# National Centre for Oncological Hadrontherapy, CNAO, Pavia, Italy

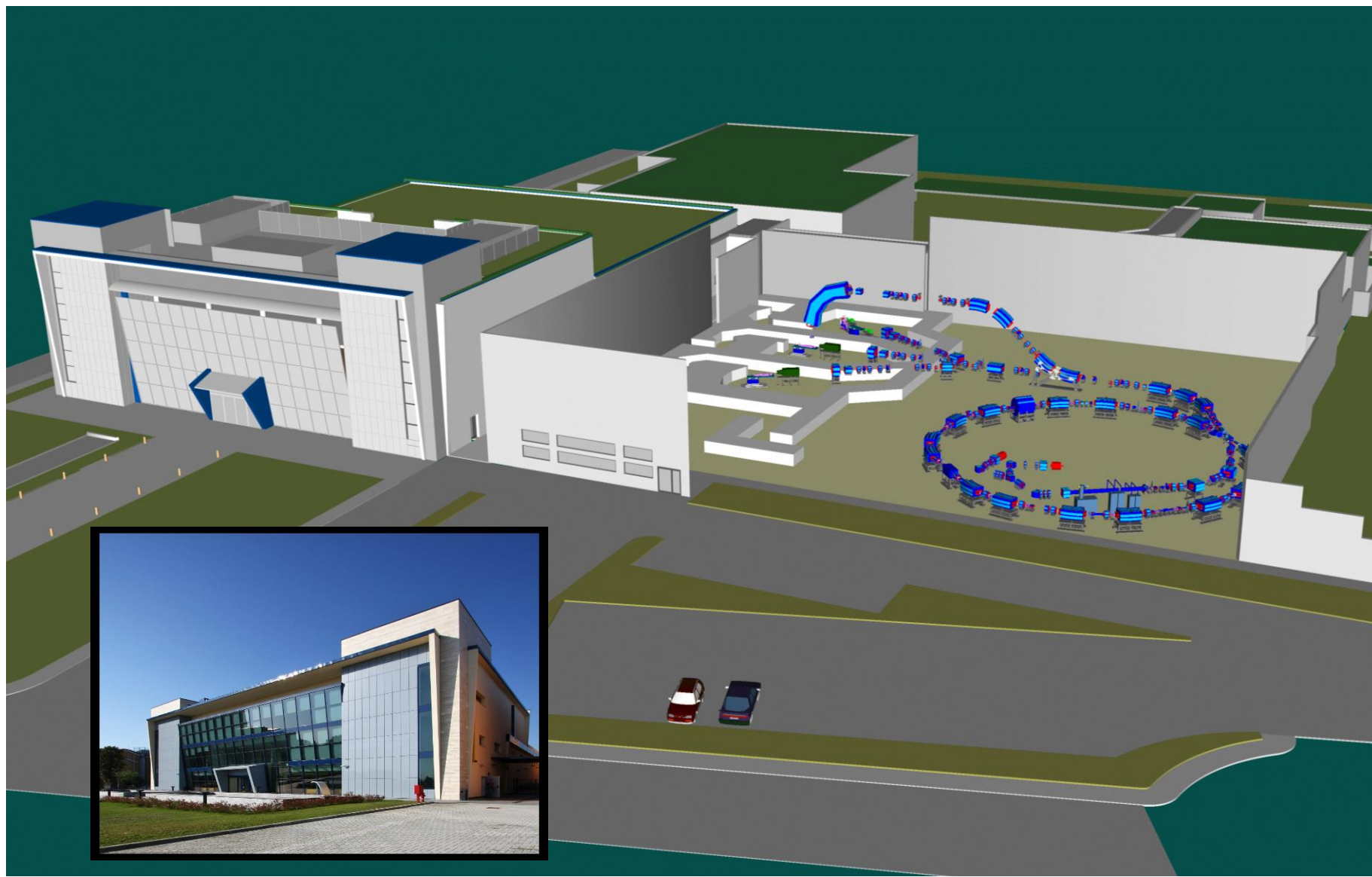

# National Centre for Oncological Hadrontherapy, CNAO, Pavia, Italy

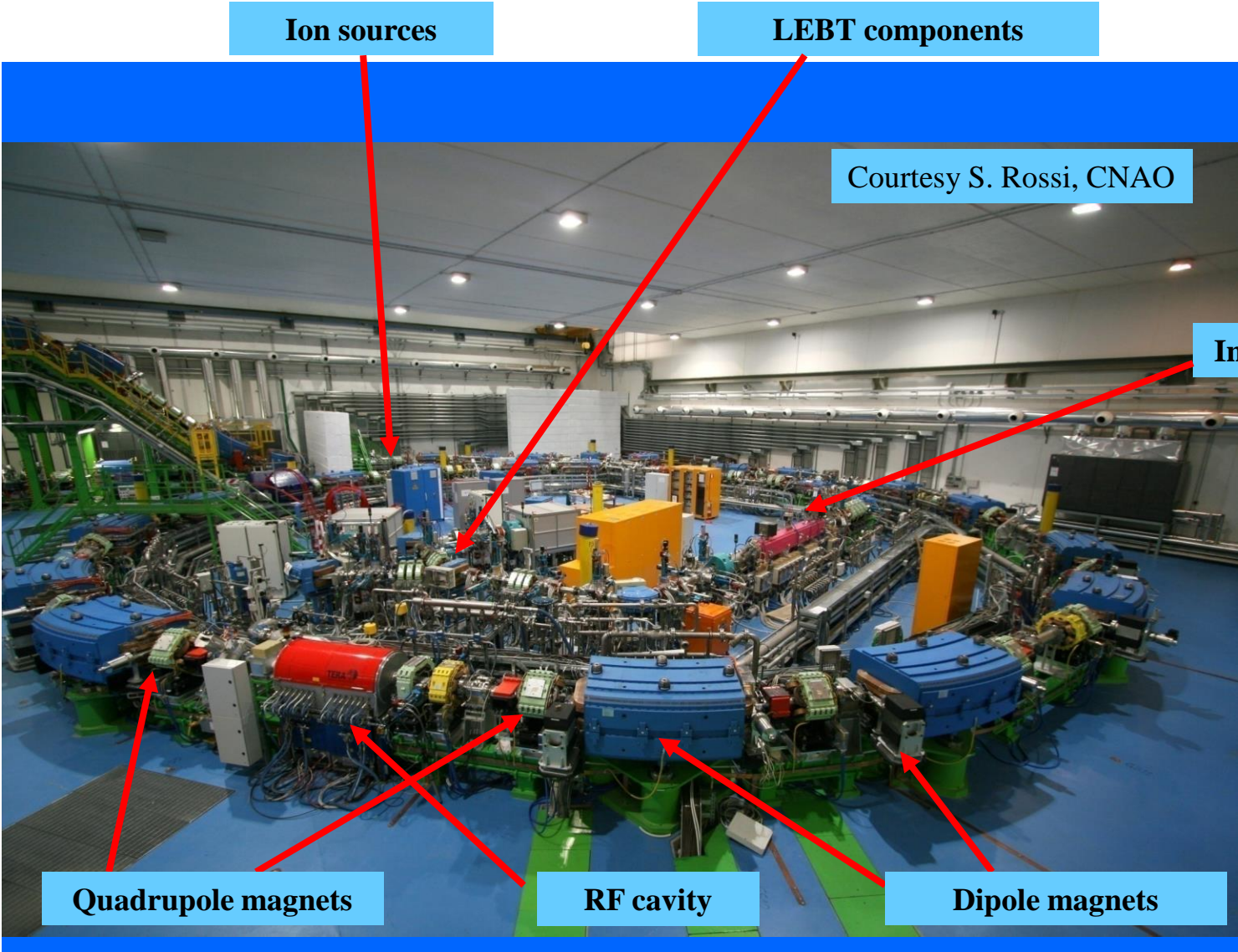





# The future of hadrontherapy: single room facilities ?

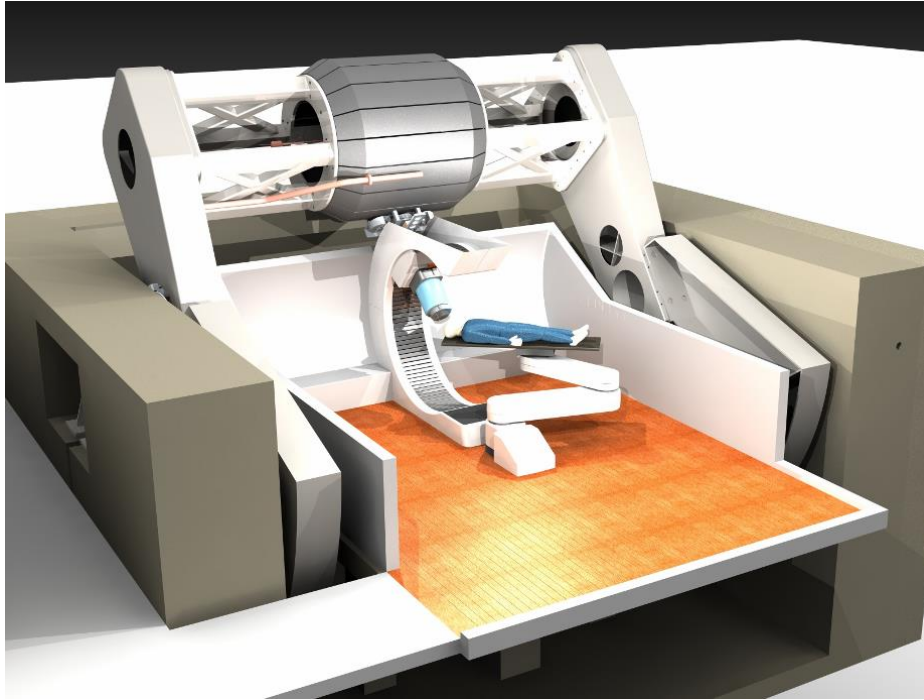

Mevion Medical Systems

IBA Proteus Nano

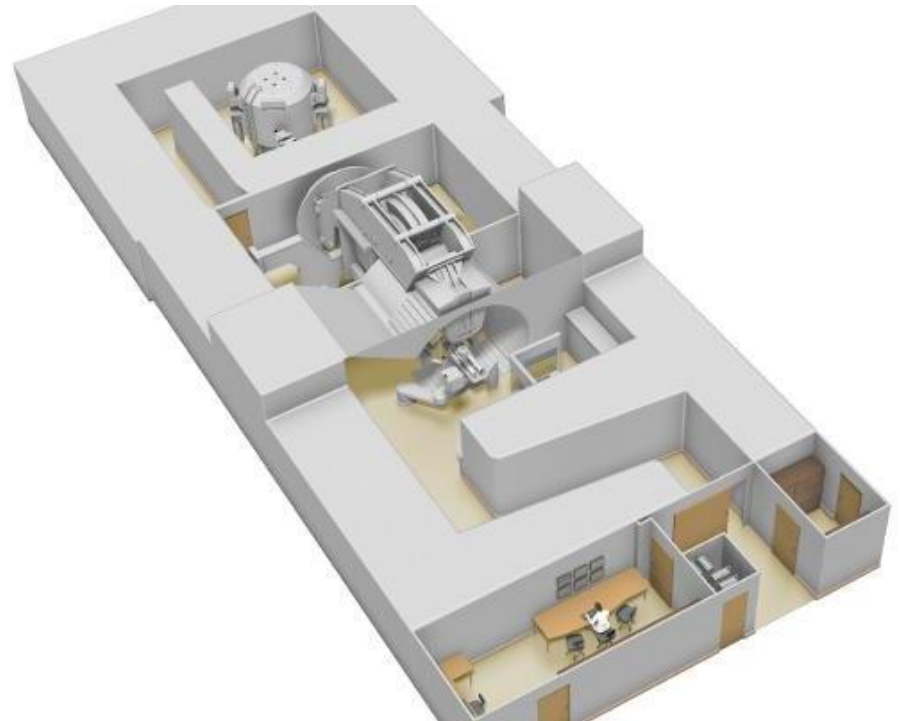

# A look into the future: flash irradiation

- New accelerator-based technology being developed by the Department of Energy's SLAC National Accelerator Laboratory and Stanford University
- Irradiation time reduced from minutes to under a second
- Tumour position "frozen"
- Technology for X-rays and protons
- Need accelerator structures that are hundreds of times more powerful than today's technology
- PHASER: flash delivery system for X-rays
- PHASER version for protons
- In mice healthy cells suffer less damage when radiation dose is applied very quickly, with same tumour-killing effect
- Make radiation therapy more accessible for patients worldwide

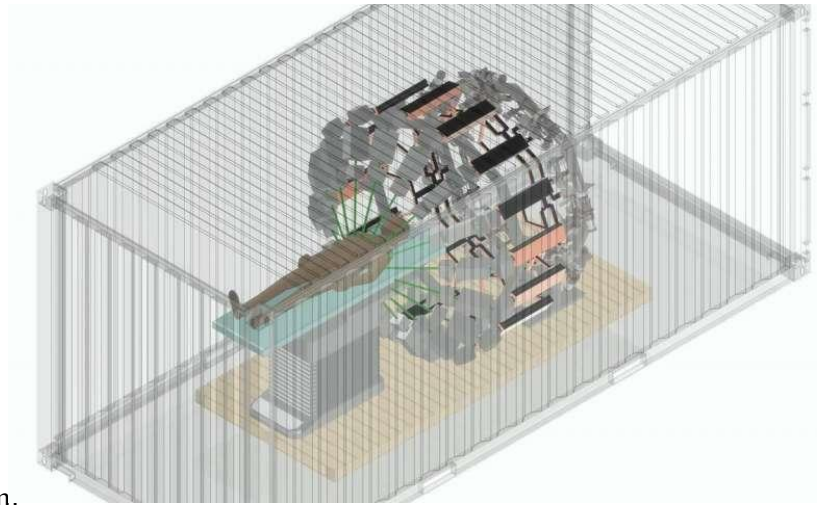
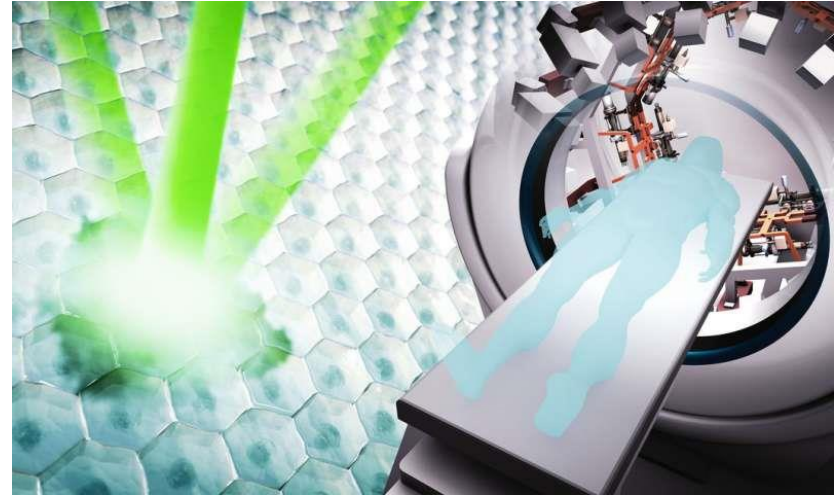

<https://phys.org/news/2018-11-future-cancer-zapping-tumors.htm>.

# A look into the future: CERN's compact gantry

Gantry + Toroid = GaToroid → *GaTo*

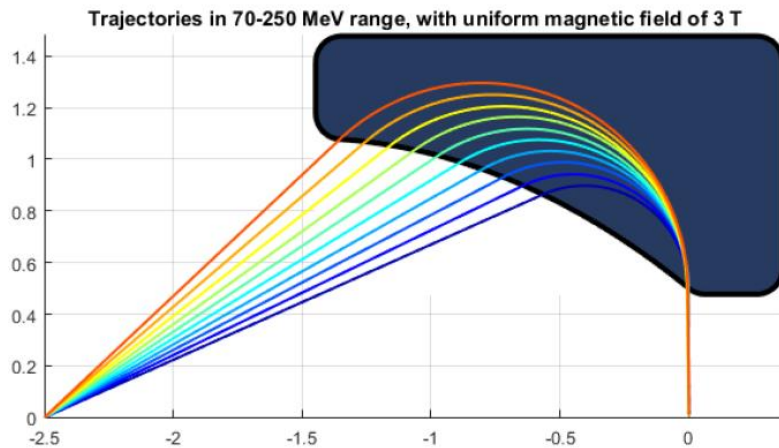
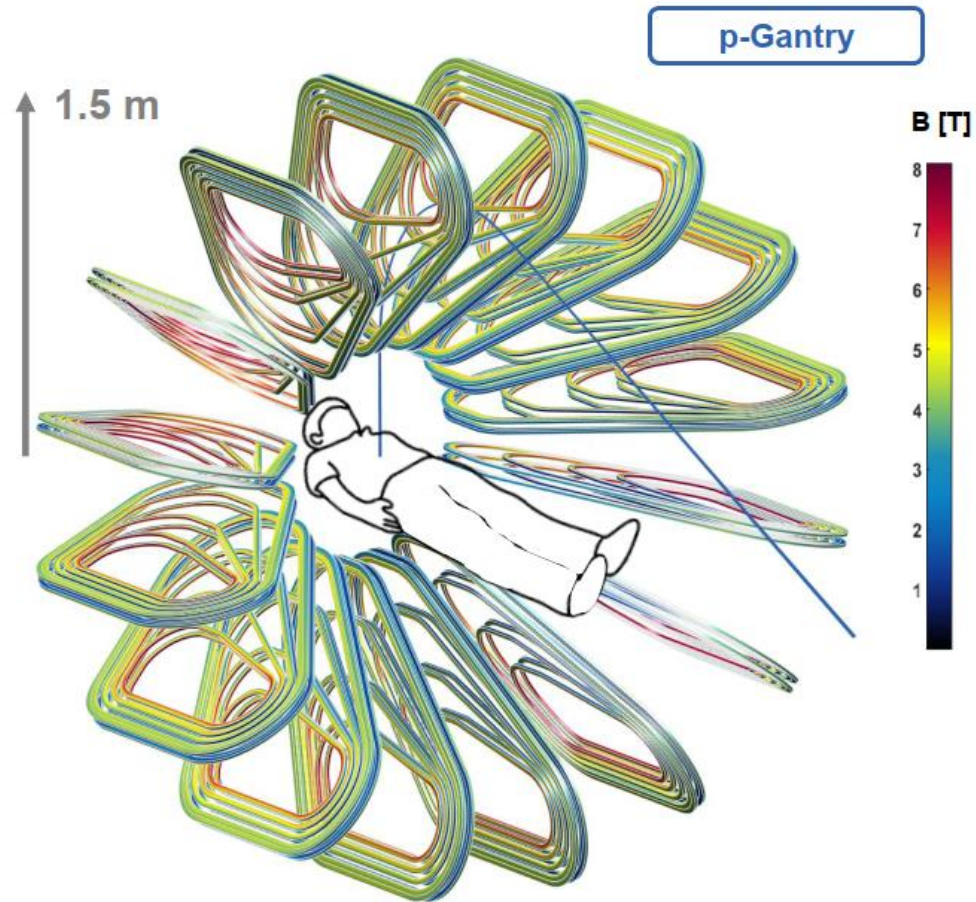

L. Bottura, E. Felcini et al, TE-MSC

# Acknowledgements

---

I am indebted to Prof. Ugo Amaldi (TERA Foundation and University of Milano Bicocca, Italy) and Prof. Maria Carla Gilardi (University of Milano Bicocca, Italy) for providing me with some of the slides that I have shown you today.