

1. Esittely
2. Vierailu show-room

CLIC-TUTKIMUSPROJEKTI

Mitä LHC:n jälkeen?

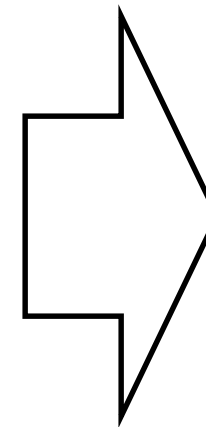
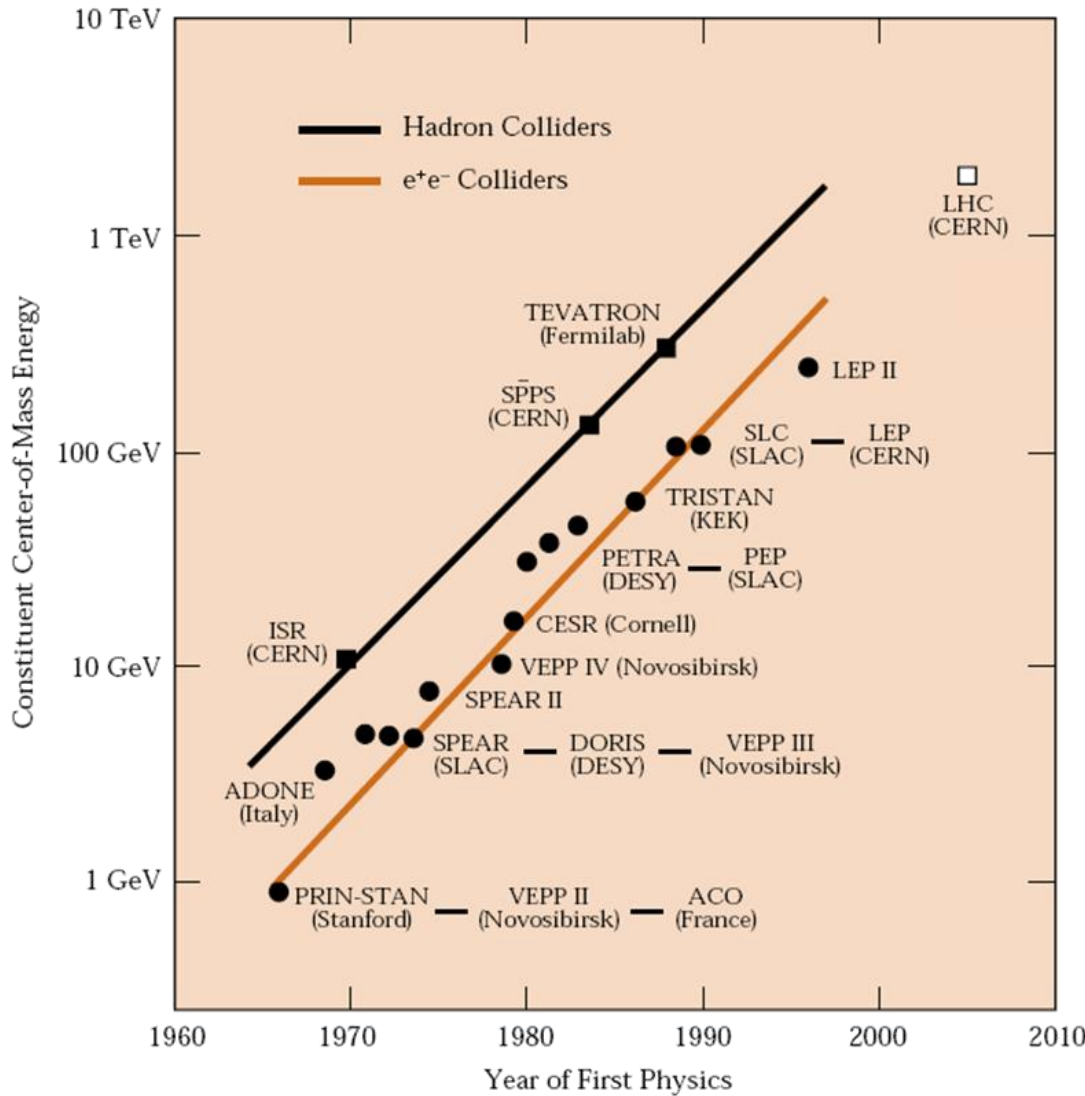

CLIC 3 TeV
ILC 0.5 TeV

!!
LHC 7 TeV
SLHC 13 TeV

1 TeV ≈ yhden lentävän
hytysen liike-energia

Miksi multi TeV $e^- e^+$ törmäytin?

Miksi lineaaritörmäytin?

Hadroni-törmäyttimet (esim. LHC)

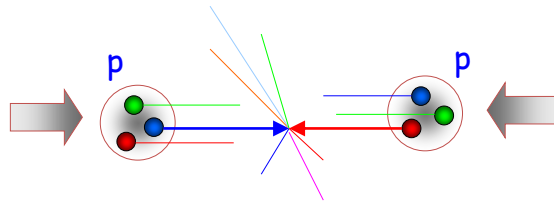

Leptoni-törmäyttimet (esim. LEP, CLIC & ILC)

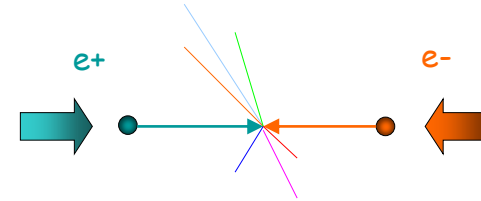

- Hadronit, esim. protonit, koostuvat kvarkeista eli alkeishiukkasista
- Leptonit, esim. elektronit, taas ovat alkeishiukkasia, mutta
- Elektronit noin 2000 kertaa protoneja pienempiä
- Feynman: *"What will one ever learn colliding Swiss watches against Swiss watches?"* (about collisions between protons)

Leptonit mahdollistavat hyvin tarkkojen mittausten tekemisen

Yleinen näkemys tiedemaailmassa siitä että LHC:n jälkeen rakennettava kiihdytinlaitteisto on lineaarikiihdytin

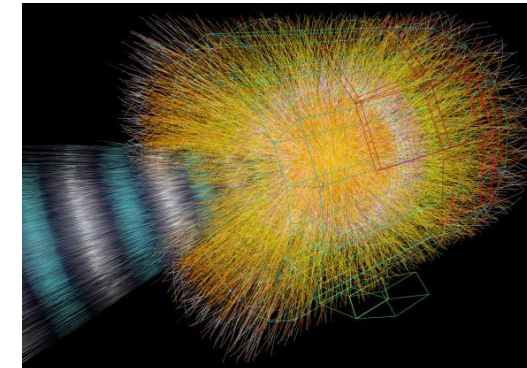

Courtesy of F. Tecker

Circular colliders use magnets to bend particle trajectories
 Their advantage is that they re-use many times

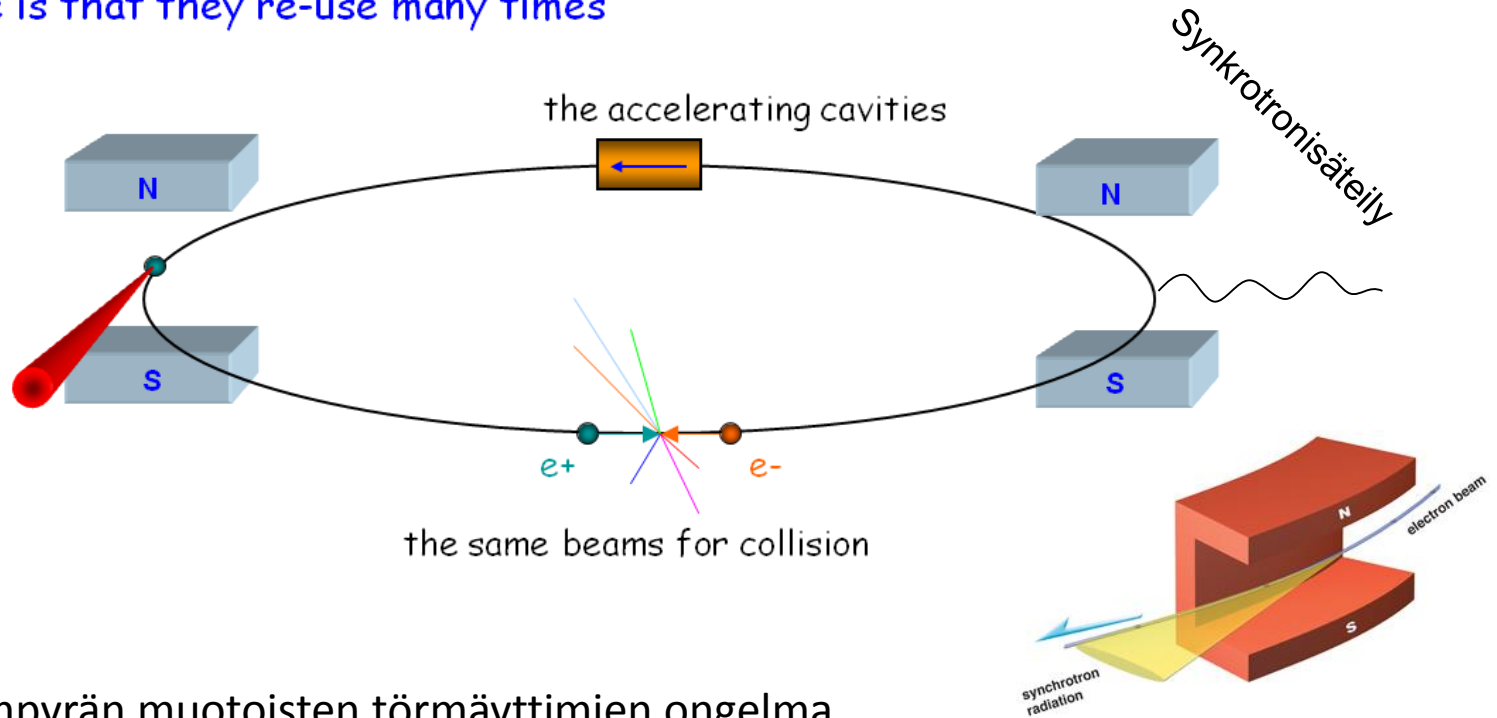

- Kaikkien ympyrän muotoisten törmäyttimien ongelma
- Säteilystä energia kasvaa hiukkasten energian kasvaessa suhteessa E^4

$$P \propto \frac{E^4}{m^4 r}$$

→ ei ole niin suuri ongelma painavilla hiukkasilla (kuten esimerkiksi protoneilla LHC:ssä)

Courtesy of H. Schickler

LEP (27 km, 200 GeV $e^+ e^-$) will probably remain the largest **circular** lepton collider ever built

LEP 0,1 TeV

3%



LEP (27 km, 200 GeV $e^+ e^-$) will probably remain the largest **circular** lepton collider ever built

LEP 0,2 TeV

45%

9 km



LEP (27 km, 200 GeV $e^+ e^-$) will probably remain the largest **circular** lepton collider ever built

LEP @ 3 TeV → sähkönkulutus terawatteja

Ydinvoimalla tuotettu sähkö maittain		
Maa	Reaktorit	Teho MW
Yhdysvallat	104	100683
Ranska	58	63130
Japani	54	46823
Venäjä	32	22693
Saksa	17	20490
Etelä-Korea	21	18665
Ukraina	15	13107
Kanada	18	12569
Iso-Britannia	19	10097
Kiina	13	10048
Muut	90	56387
Yhteensä	441	374692

Alle terawatti!

9 km

Lineaaritörmäytin

CDR and cost review for the next ESU (2018)

- 80-100 km tunnel infrastructure in Geneva area
- pp-collider (VHE-LHC) defining the infrastructure requirements
- e+e- collider (TLEP) as potential intermed. step and p-e (VLHeC) option
- CERN-hosted study performed in international collaboration

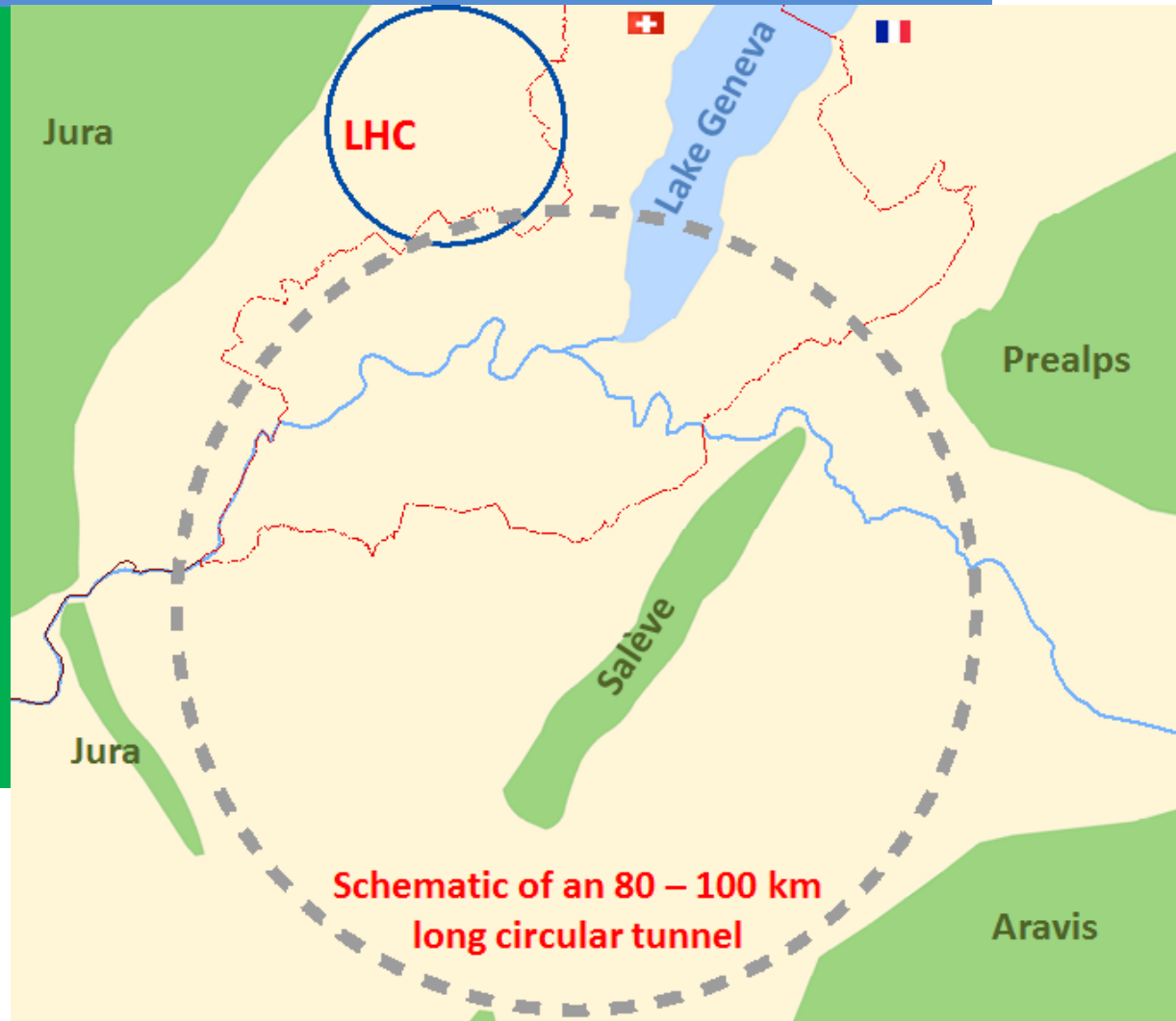

$\sim 15 \text{ T} \Rightarrow 100 \text{ TeV in } 100 \text{ km}$

$\sim 20 \text{ T} \Rightarrow 100 \text{ TeV in } 80 \text{ km}$

COLLISION COURSE

Particle physicists around the world are designing colliders that are much larger in size than the Large Hadron Collider at CERN, Europe's particle-physics laboratory.

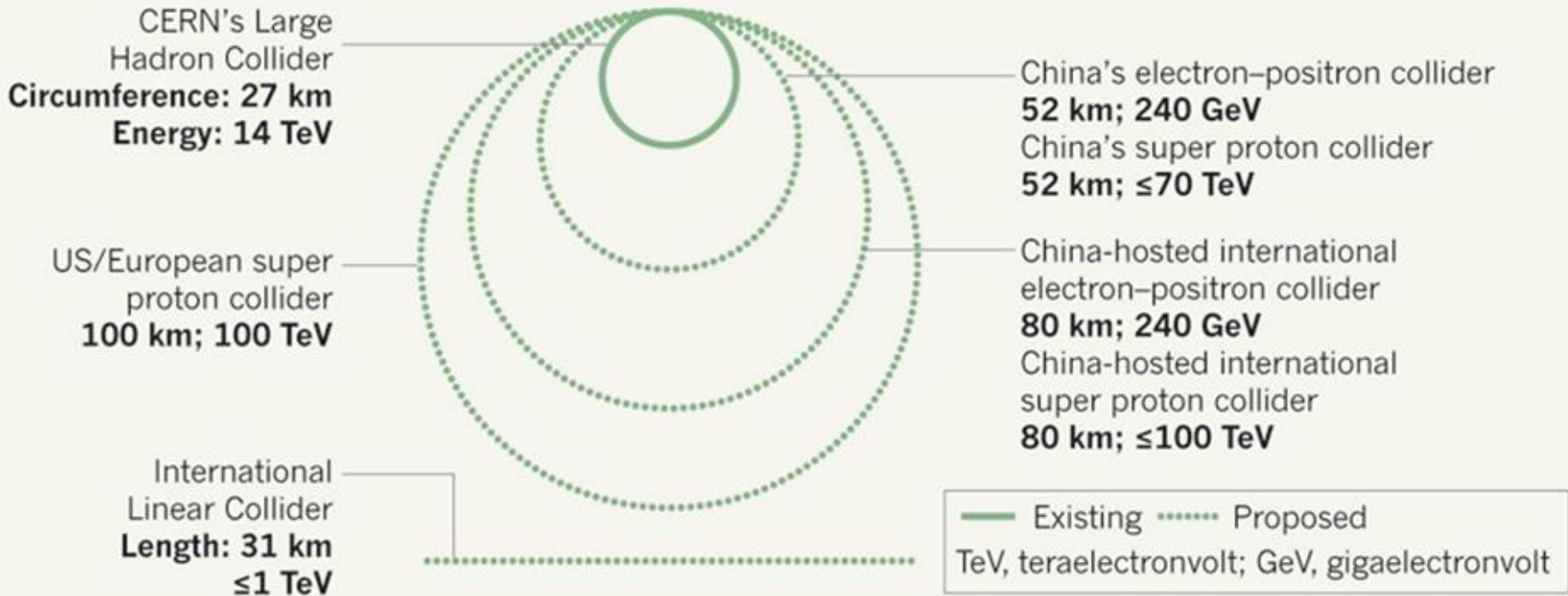

ILC 0.5 TeV

Suprajohtava

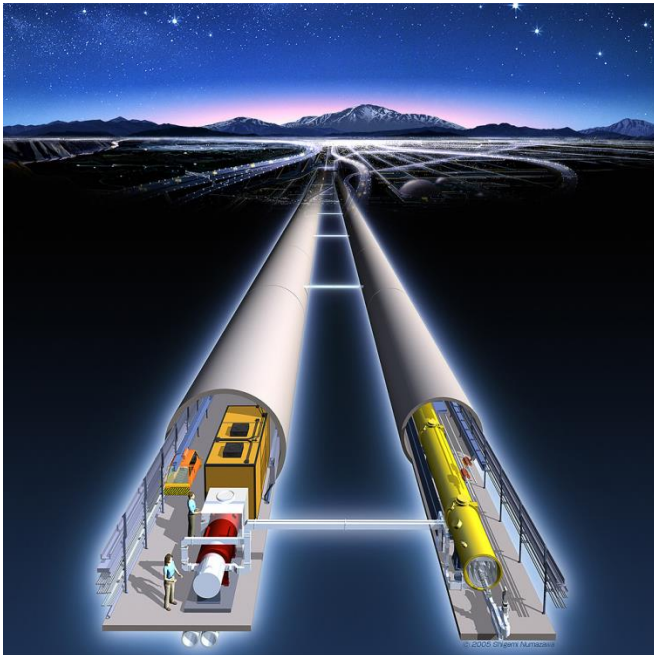

CLIC – 3 TeV

Normaalikonduktiivinen

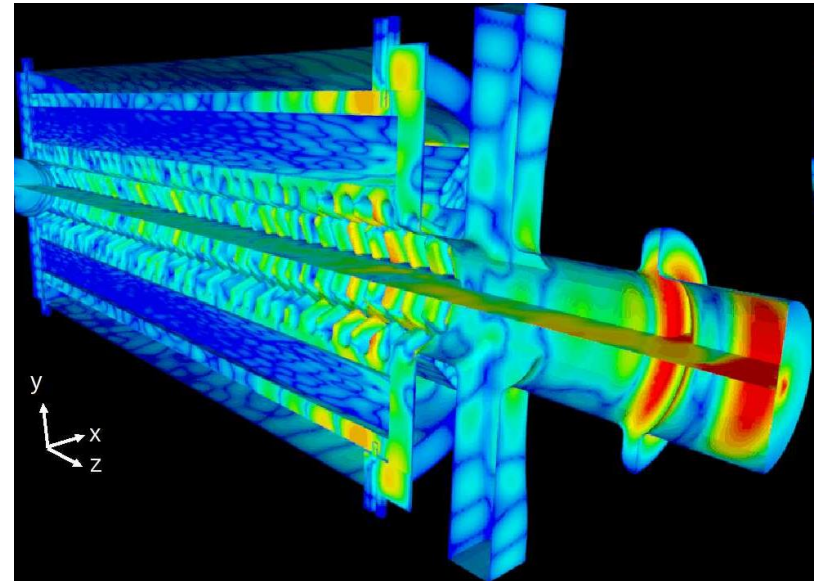

Suunnitelmat tulevaisuuden lineaaritörmäyttimeksi

- “It is an exiting time to live in for a physicist!”
- Perusfysiikan ja LHC:n tulosten täydentäminen
 - Standardimallin vahvistaminen ja fysiikka sen takana
 - Uudet Gauge, Higgs bosonit ym.
 - Supersymmetria
- Nämä tutkimuskohteet täsmentyvät ja uusia saattaa ilmaantua LHC:n tulosten perusteella

Three generations of matter (fermions)

	I	II	III	
mass	2.4 MeV/c ²	1.27 GeV/c ²	171.2 GeV/c ²	0
charge	2/3	2/3	2/3	0
spin	1/2	1/2	1/2	1
name	u up	c charm	t top	γ photon
	4.8 MeV/c ²	104 MeV/c ²	4.2 GeV/c ²	0
	-1/3	-1/3	-1/3	0
	1/2	1/2	1/2	1
Quarks	d down	s strange	b bottom	g gluon
	<2.2 eV/c ²	<0.17 MeV/c ²	<15.5 MeV/c ²	91.2 GeV/c ²
	0	0	0	0
	1/2	1/2	1/2	1
	ν_e electron neutrino	ν_μ muon neutrino	ν_τ tau neutrino	Z⁰ Z boson
	0.511 MeV/c ²	105.7 MeV/c ²	1.777 GeV/c ²	80.4 GeV/c ²
	-1	-1	-1	±1
	1/2	1/2	1/2	1
Leptons	e electron	μ muon	τ tau	W[±] W boson

Gauge bosons

- CLIC: **C**ompact **L**inear **C**ollider.
- Lineaarinen kiihdytin synkrotronisätelyn ja energiahäviöiden minimoimiseksi kun tavoitellaan korkeita energiatasoja.
- Törmäysenergia (center of mass) 380GeV-3TeV.
- **Elektronit** vastaan **positronit**
- Kompakti? Mutta 50km pitkä?
- CLIC:ssä elektromagneettinen kiihdyttävä gradientti 100 MV/metri!
- ILC 35 MV/metri suprajohdavalla tekniikalla.

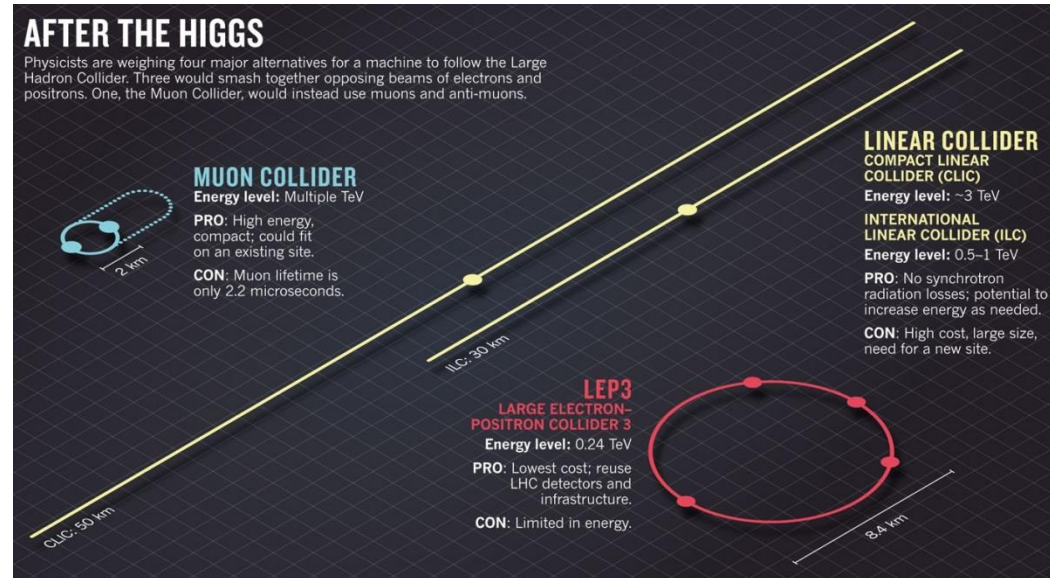



LEP → LHC → CLIC?

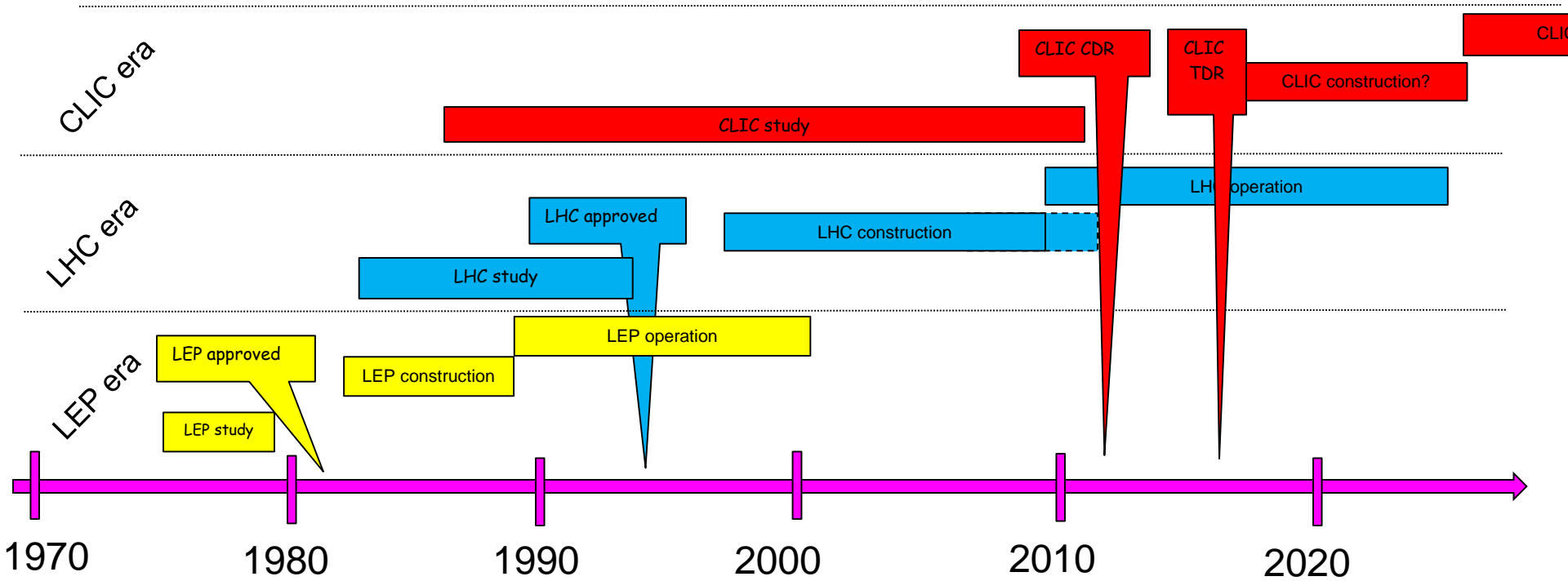

Yli 30 valtiota – yli 70 instituuttia



- Accelerator collaboration
- Detector collaboration
- Accelerator + Detector collaboration



Goal for next strategy update:
Present a CLIC project that is a “credible” option for CERN beyond LHC, a Project Implementation Plan.
Guidelines used internally:

- Adapt to physics results – LHC mostly – taking into account LHC at 13-14 TeV as results become available (be flexible)
- Physics no later than 2035, solid luminosities from Higgs/top at 380 GeV to 3 TeV (staging)
- Initial costs compatible with earlier projects (order LHC+50%) (staging)
- Upgradable in 2-3 stages over a 20-30y period, without major (max 3-4 years) operational breaks, and with upgrade costs also in reasonable agreement with current budget level.
- Cover accelerator, detector, physics

2013 - 2019 Development Phase
 Development of a Project Plan for a staged CLIC implementation in line with LHC results; technical developments with industry, performance studies for accelerator parts and systems, detector technology demonstrators

2020 - 2025 Preparation Phase
 Finalisation of implementation parameters, preparation for industrial procurement, Drive Beam Facility and other system verifications, Technical Proposal of the experiment, site authorisation

2026 - 2034 Construction Phase
 Construction of the first CLIC accelerator stage compatible with implementation of further stages; construction of the experiment; hardware commissioning



2019 - 2020 Decisions
 Update of the European Strategy for Particle Physics; decision towards a next CERN project at the energy frontier (e.g. CLIC, FCC)

2025 Construction Start
 Ready for construction; start of excavations

2035 First Beams
 Getting ready for data taking by the time the LHC programme reaches completion



 Compact Linear Collider

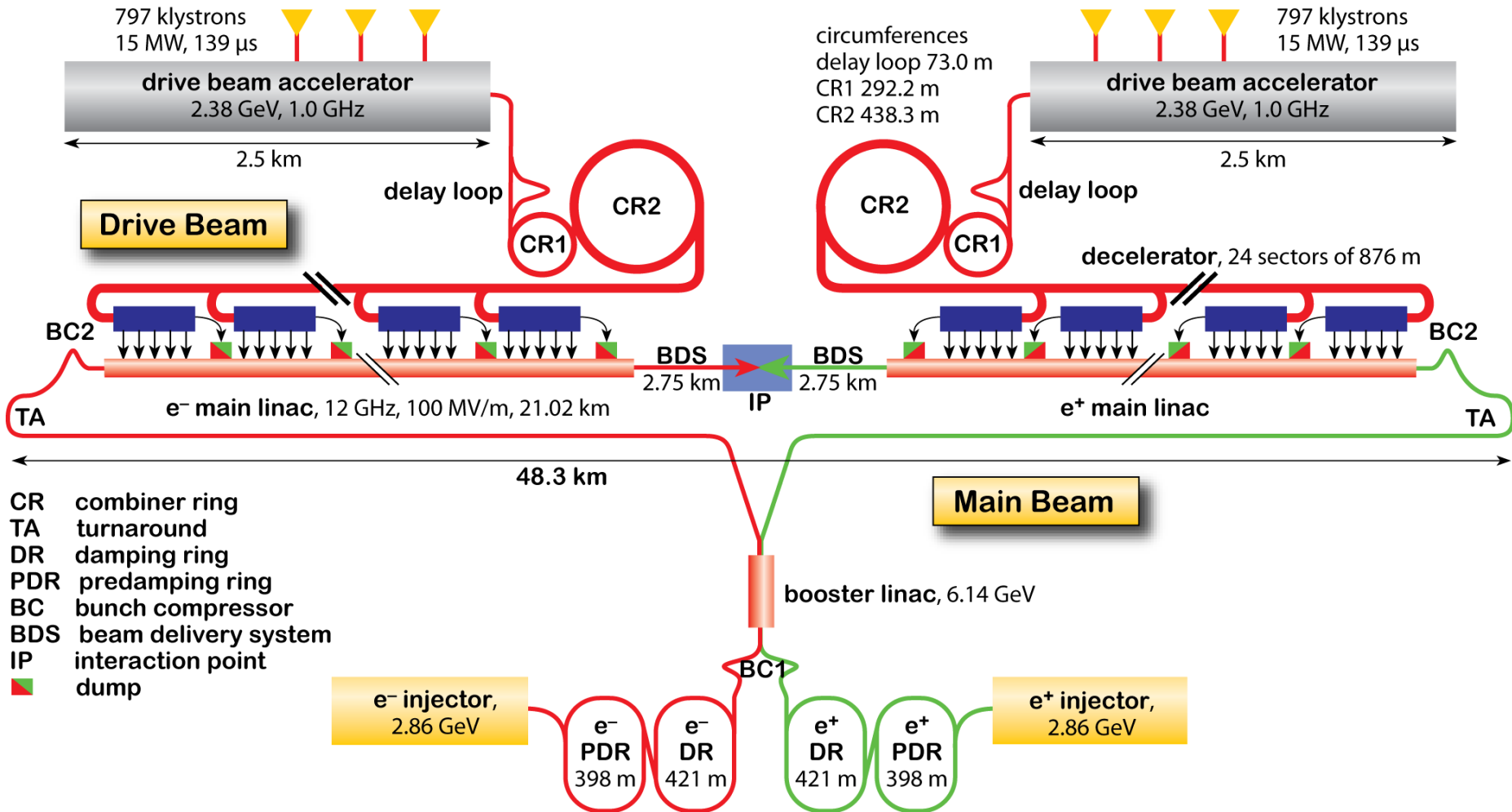

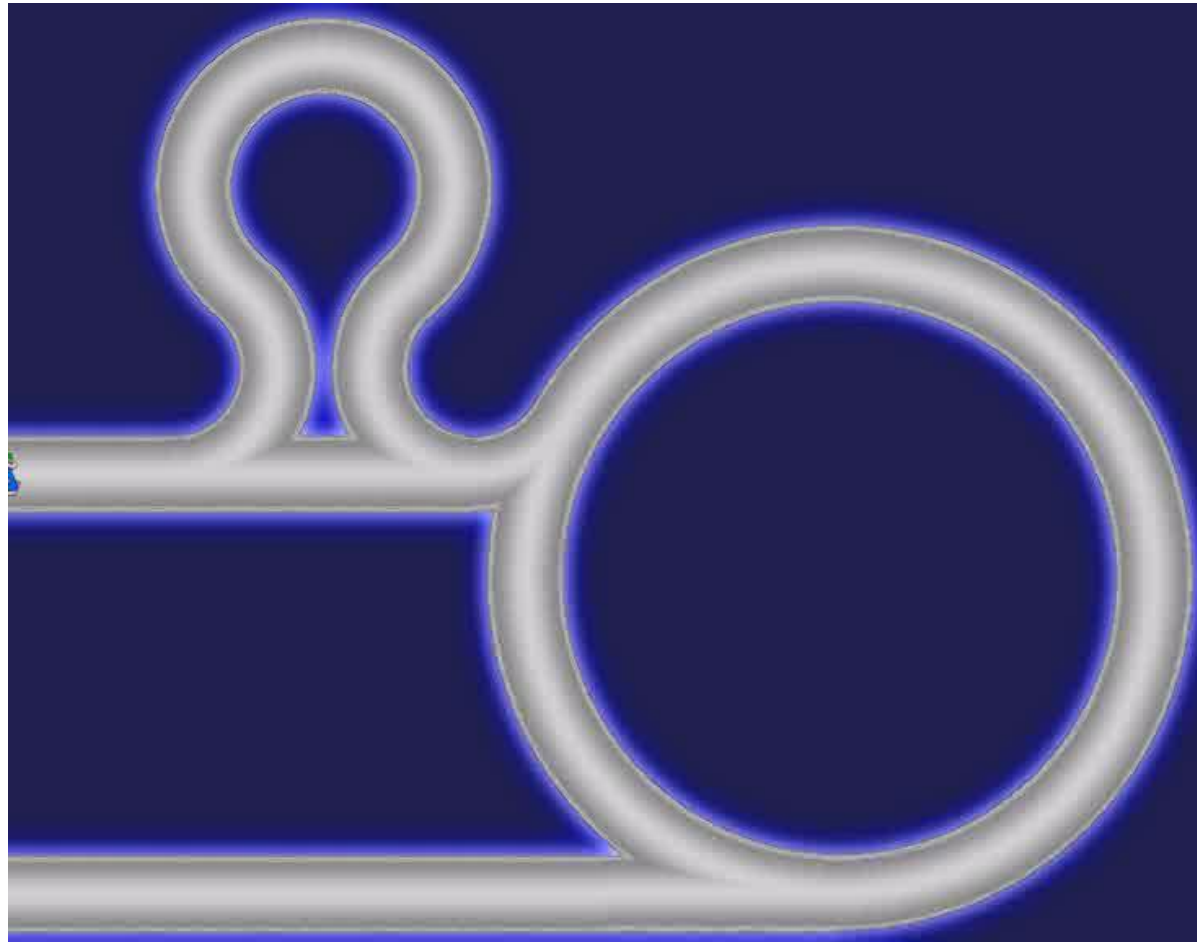

Courtesy of A.
Andersson

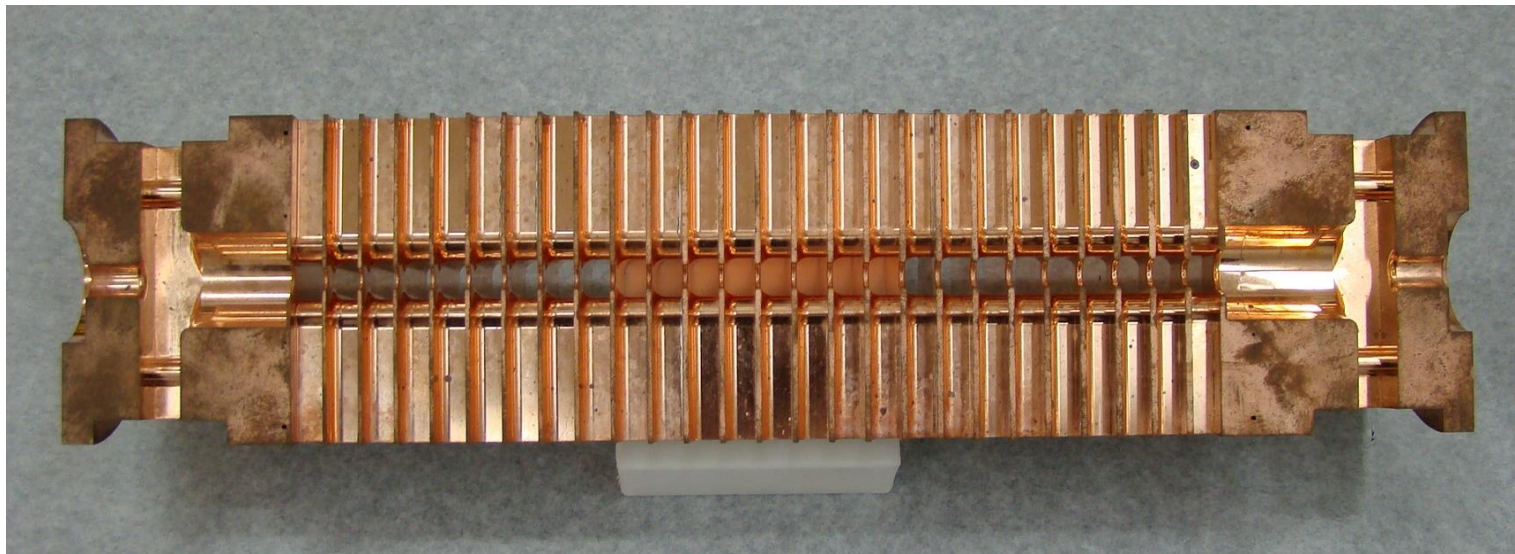

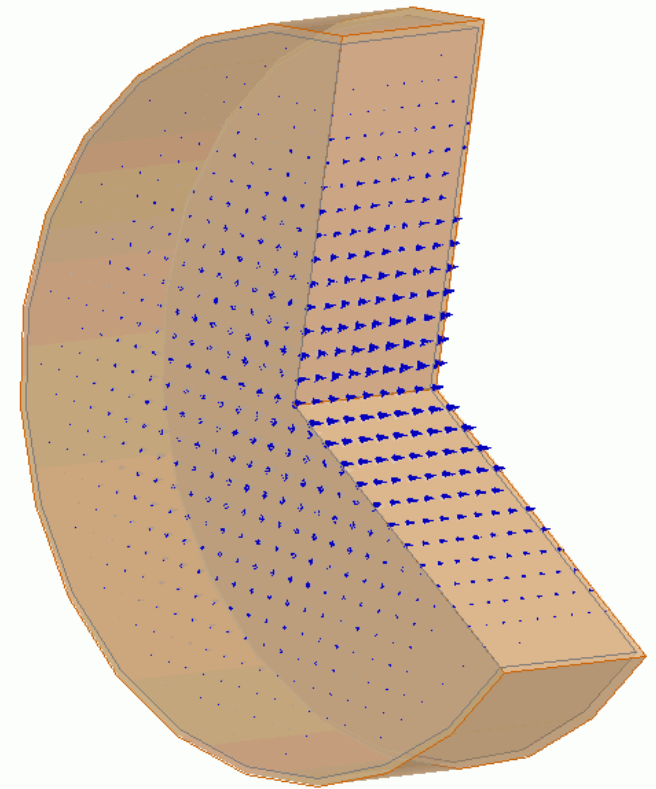
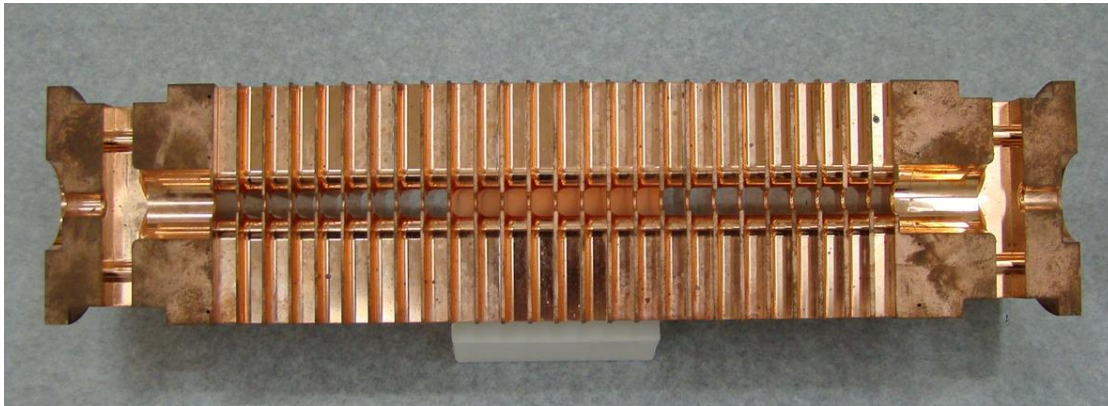

0 4 8 (mm)

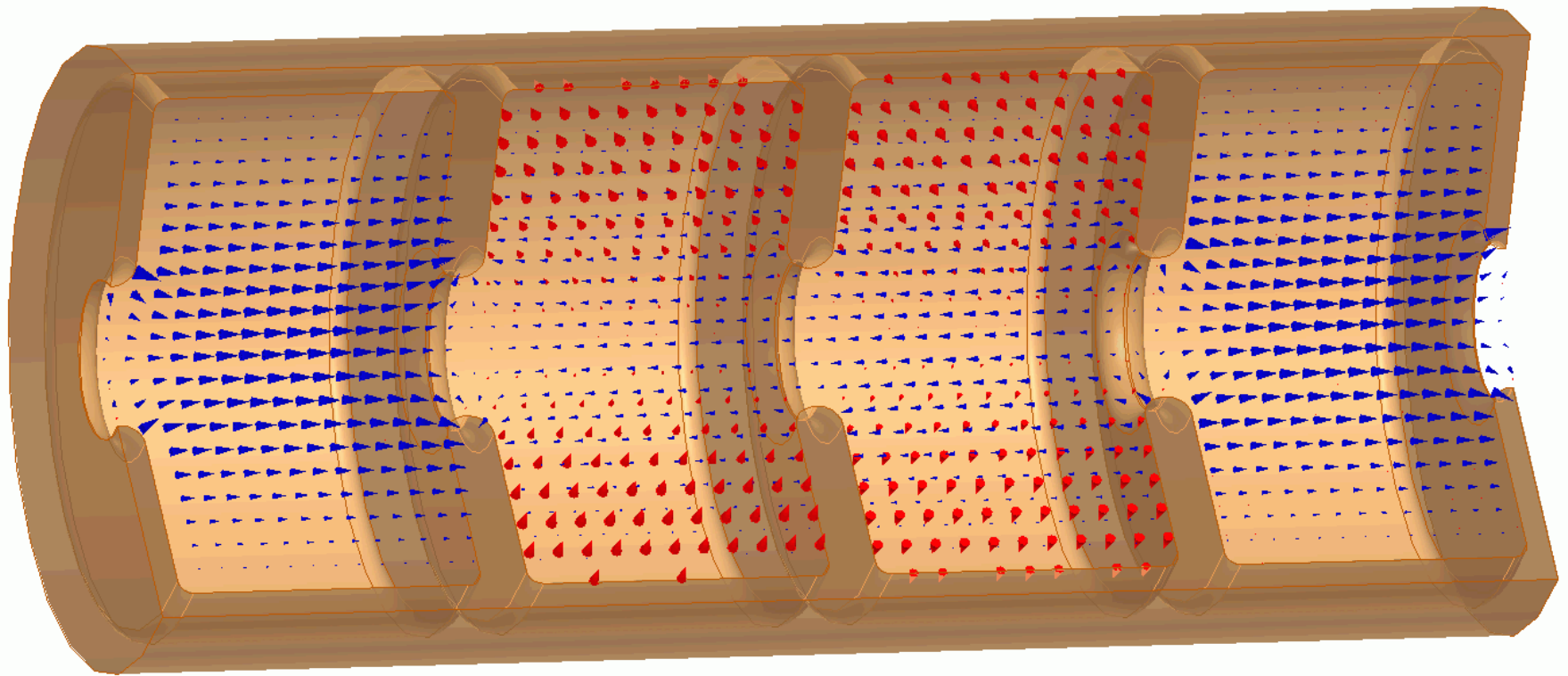

0 10 20 (mm)



beam propagation direction

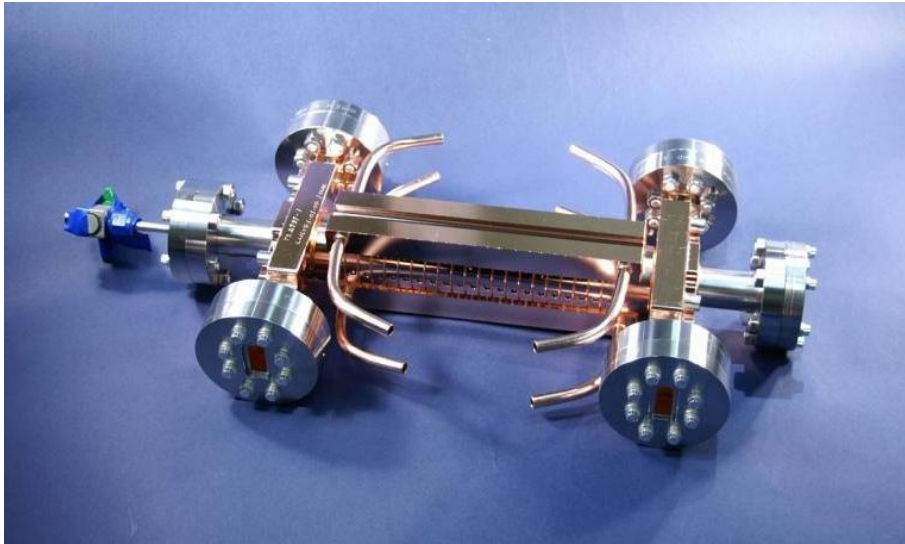

CLIC target gradient: 100 MV/m

LEP gradient ~ 5 MV/m

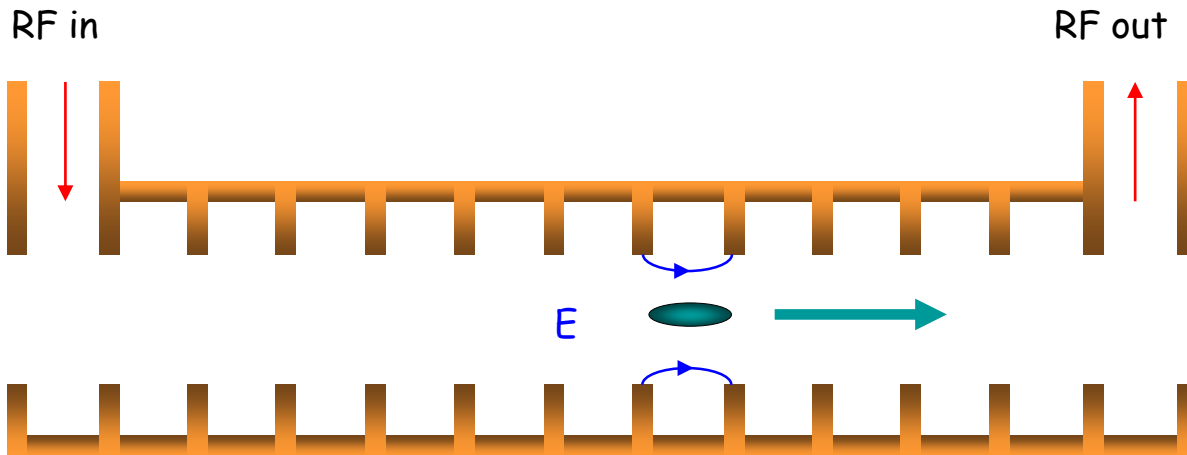

CLIC perustuu ns. kahden hiukassuihkun kiihdytykseen, jossa ajohiukassuihkun (korkea sähkövirta, matala energia) avulla kiihdytetään päähiukassuihkua (matala virta, korkea energia).

Ajohiukkasuihku (Drive beam)

Päähiukkasuihku (Main beam)

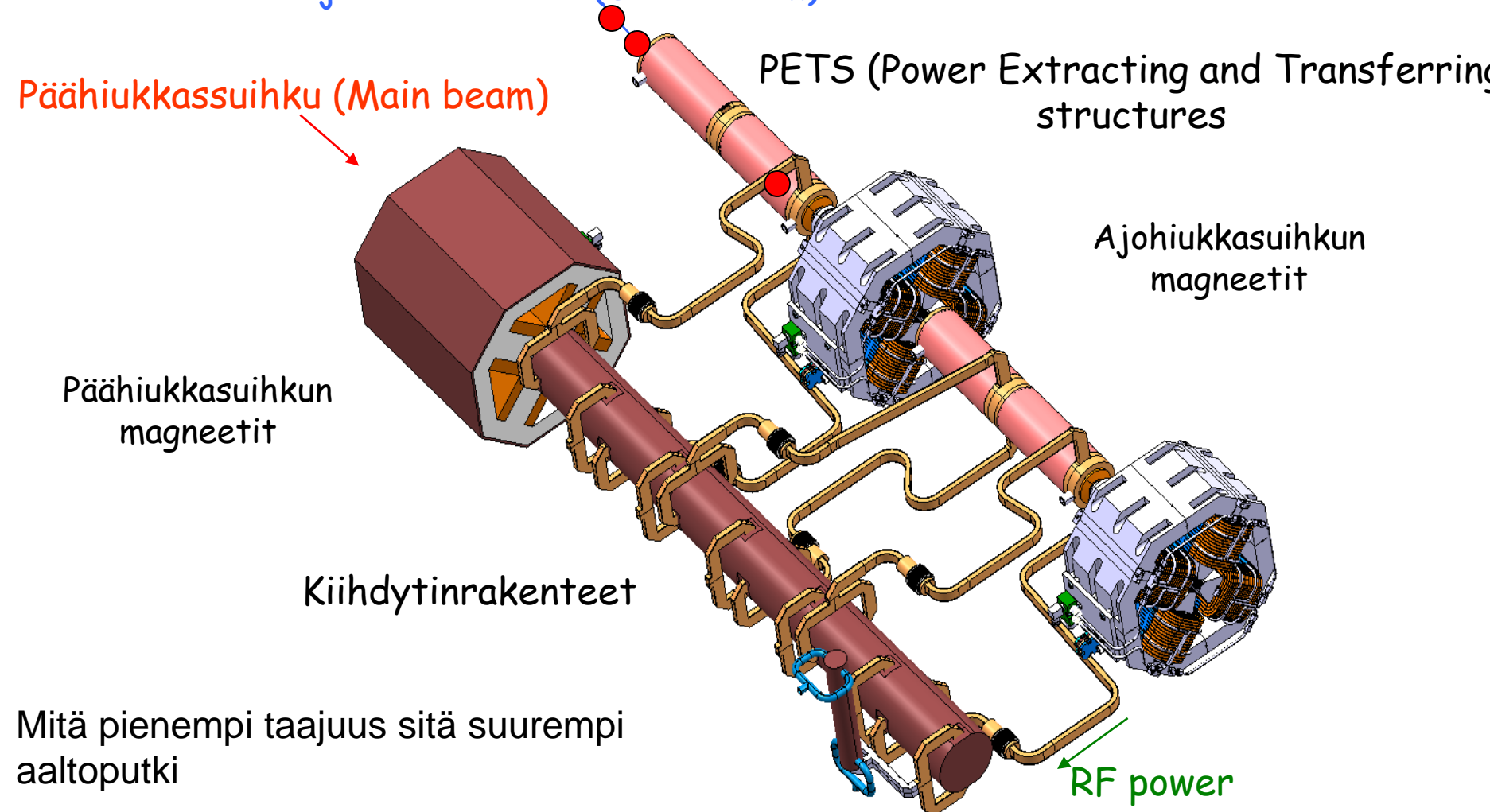

time: **0 0 . 0** ns

Slide courtesy of A. Candel (SLAC)

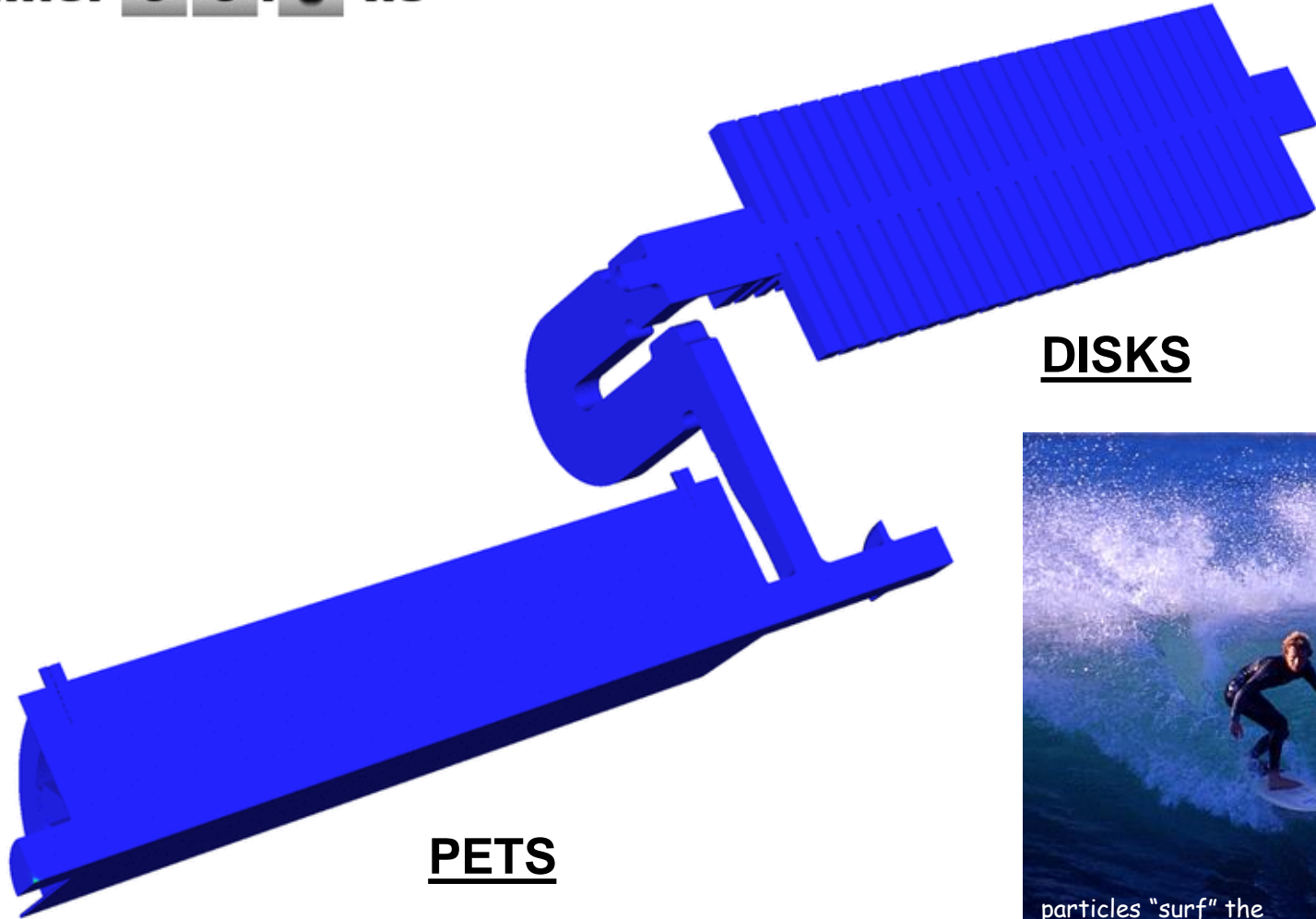

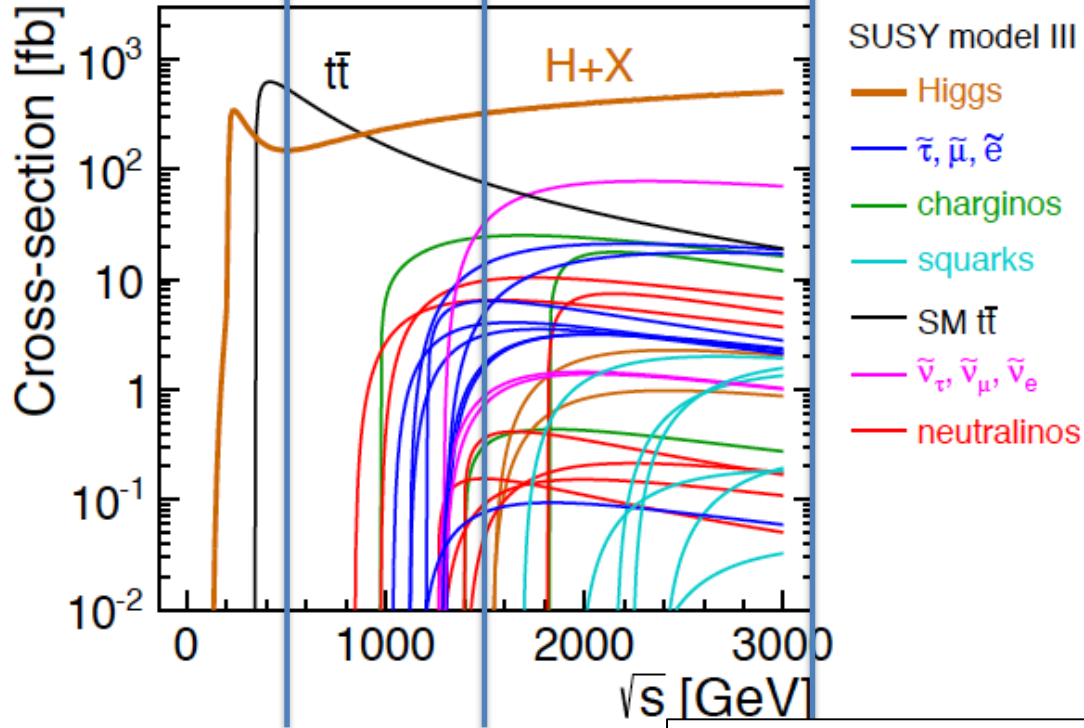

CERN energian kulutus vuonna 2012: 1.35 TWh

CLIC teho 582 MW

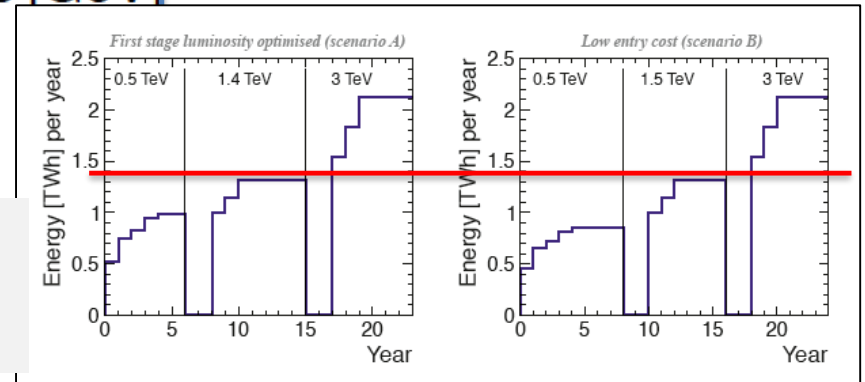

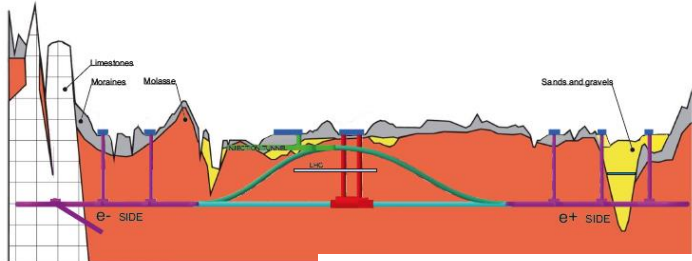
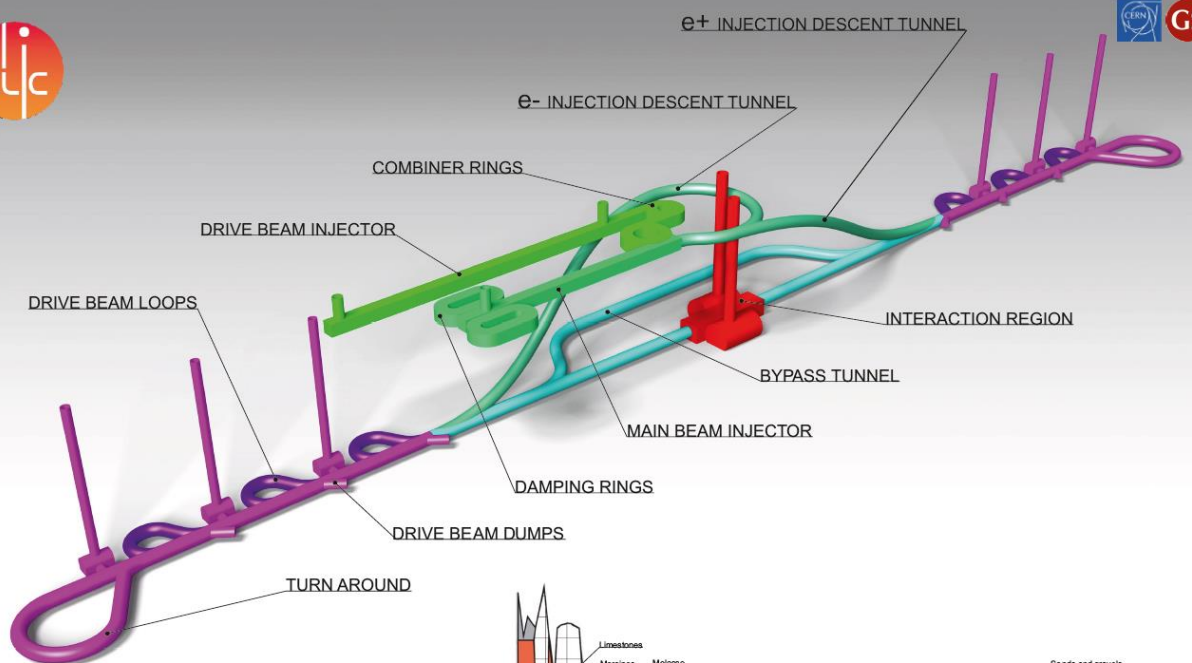

CLIC SCHEMATIC

(not to scale)

- detector
- BDS
- accelerator

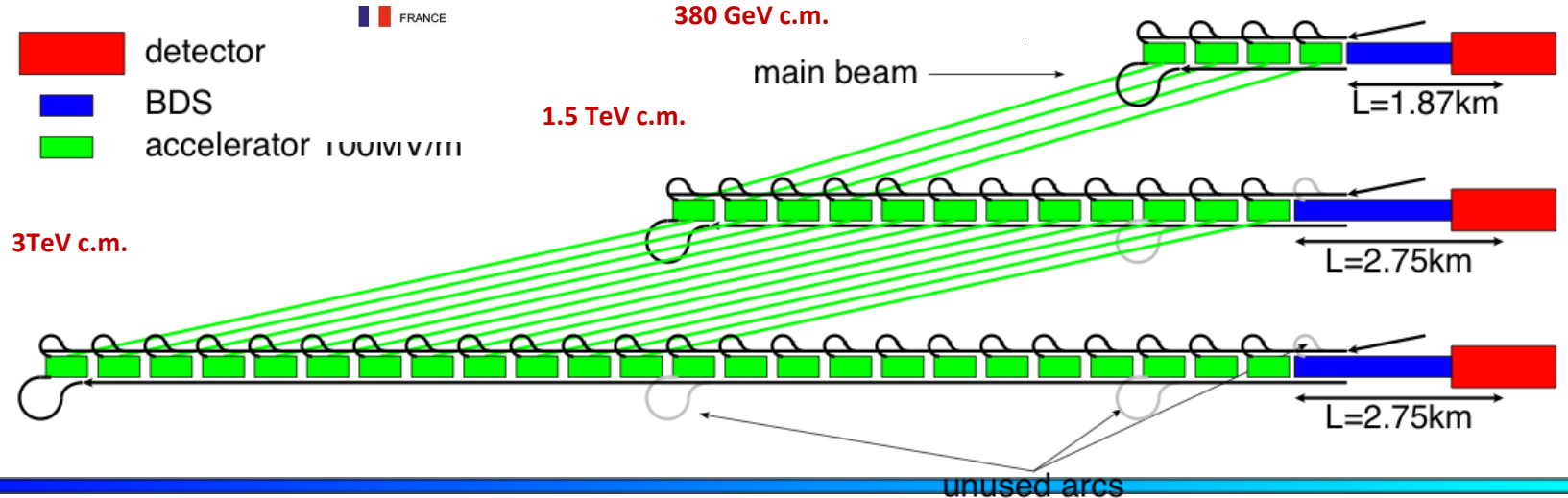

IP under CERN Preveessin site

Vaihe 1: 380 GeV pituus 11 km, Vaihe 2: 1,5 TeV, Vaihe 3: 3 TeV pituus 48.5 km

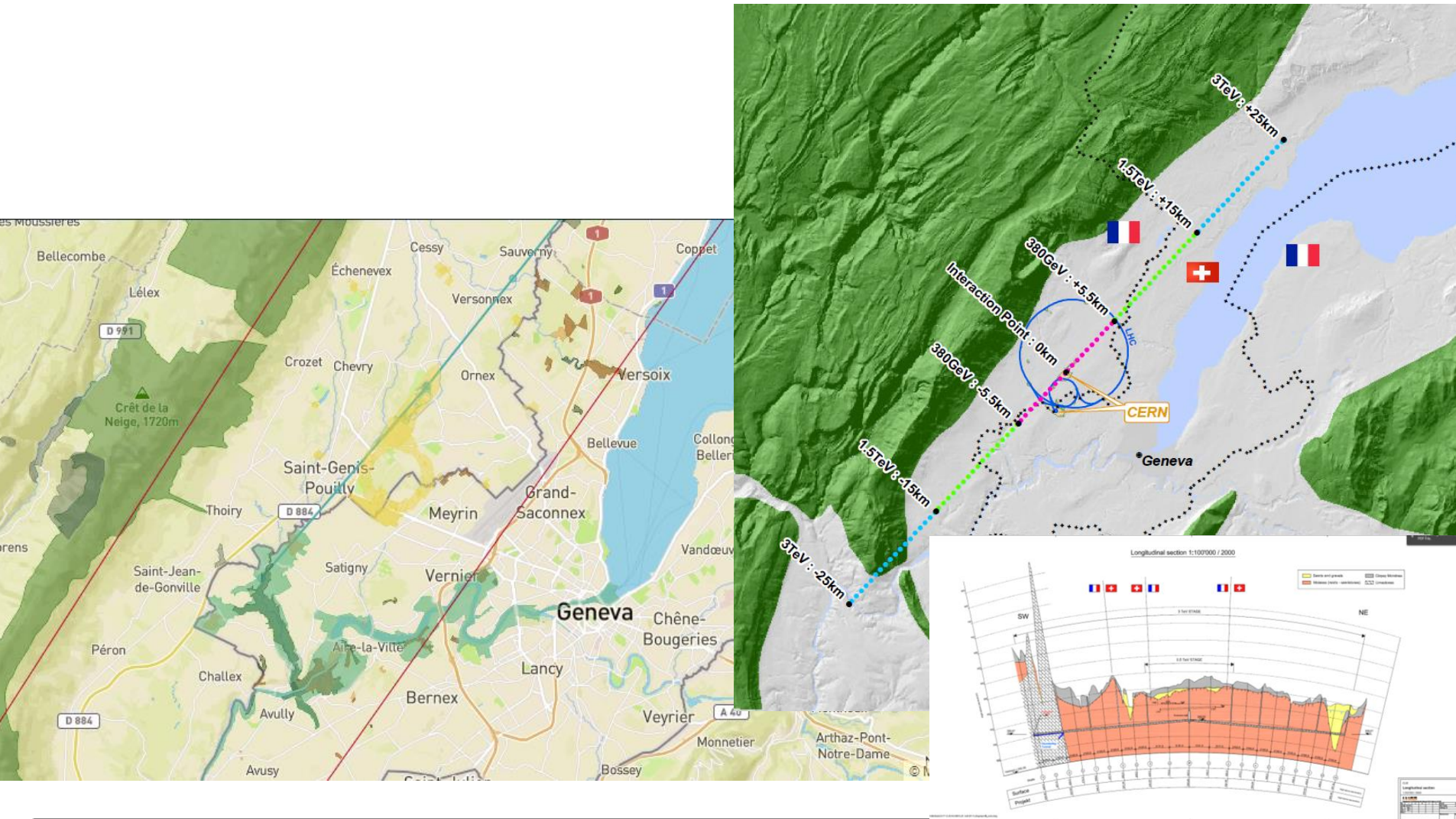

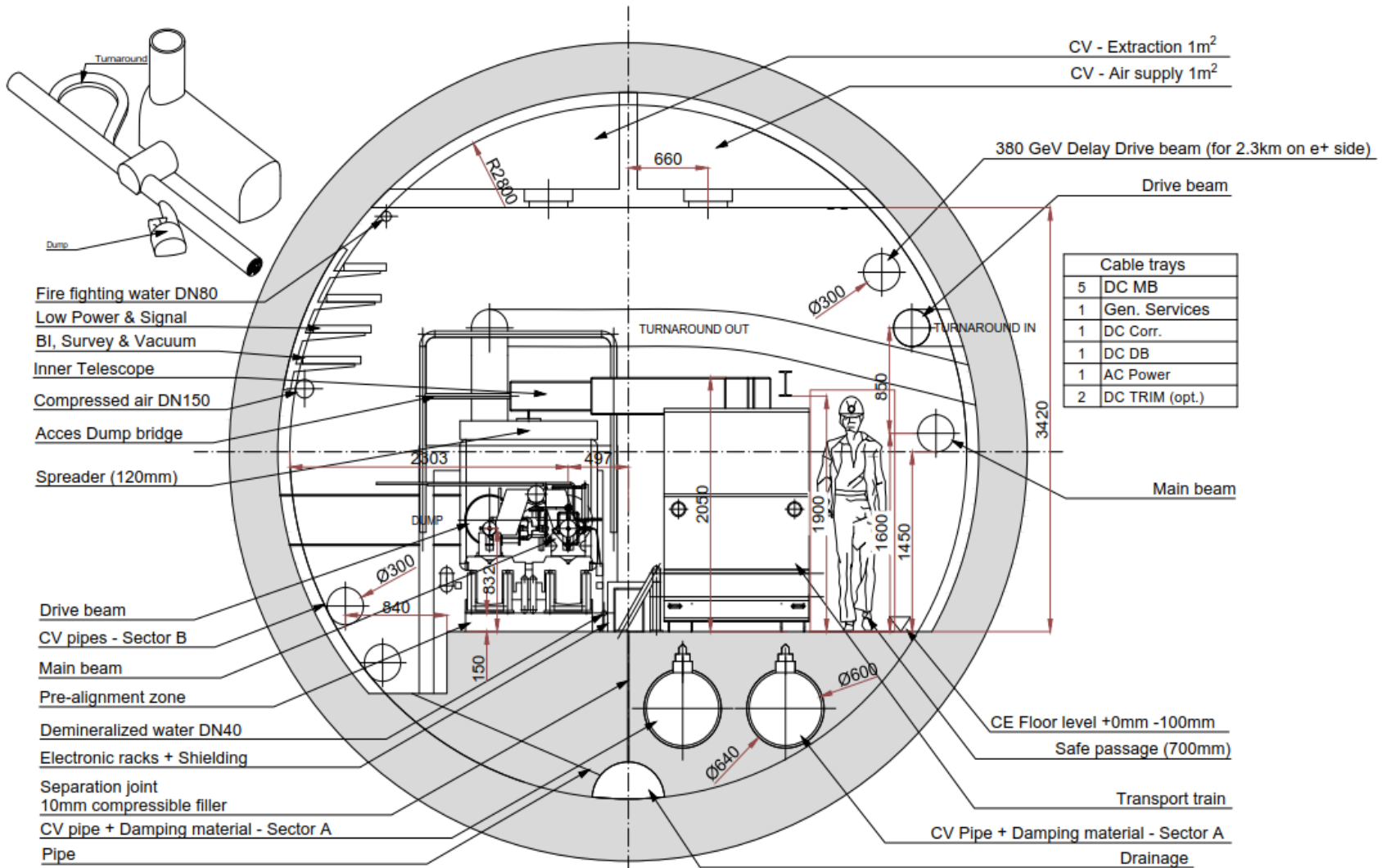

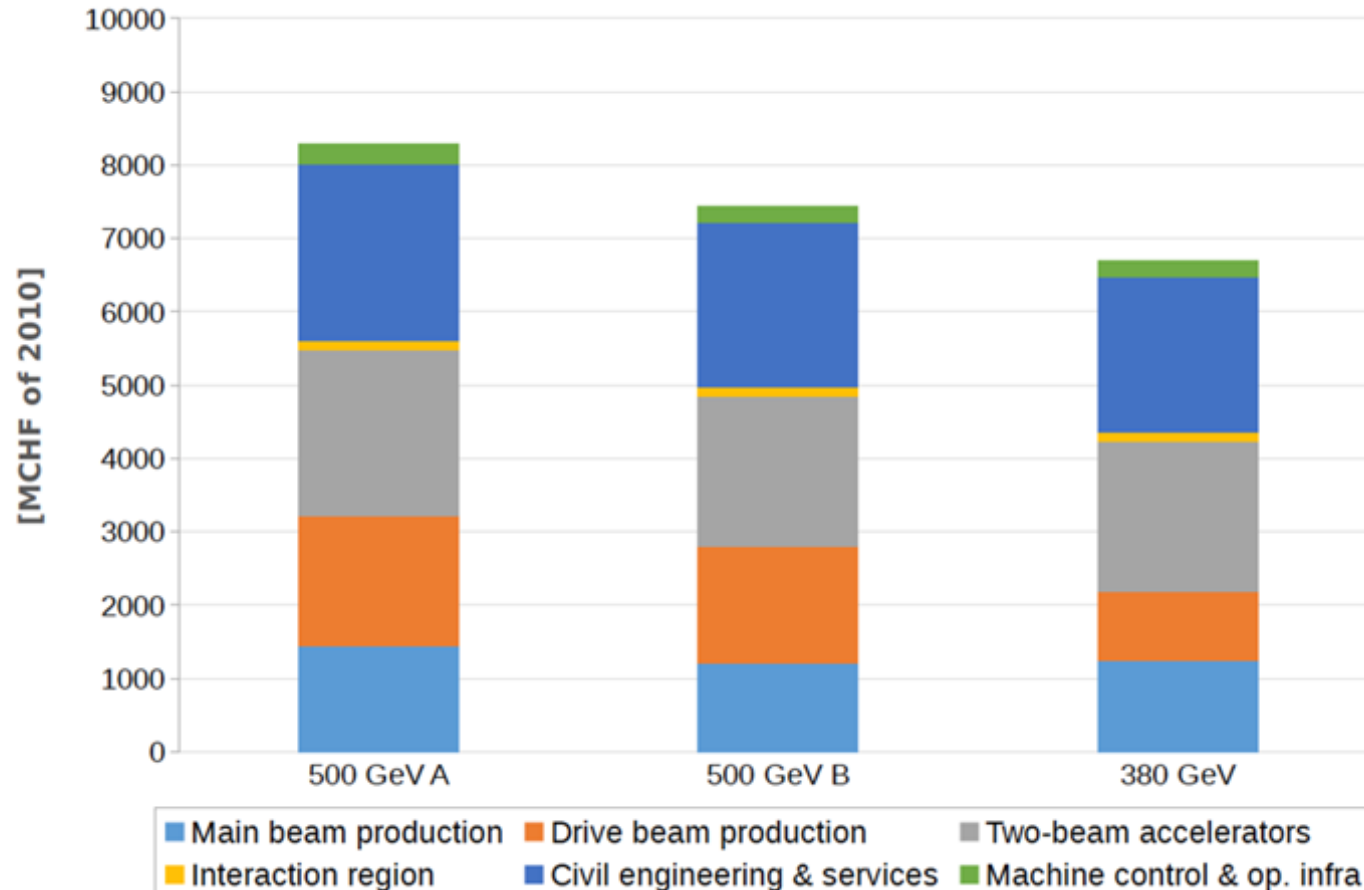

First to second stage: 4 MCHF/GeV (i.e. initial costs are very significant)

Caveats:

- Uncertainties 20-25%
- Possible savings around 10%
- However – first stage not optimised (work for next phase), parameters largely defined for 3 TeV final stage

Table 11: Value estimate of CLIC at 380 GeV centre-of-mass energy.

	Value [MCHF of December 2010]
Main beam production	1245
Drive beam production	974
Two-beam accelerators	2038
Interaction region	132
Civil engineering & services	2112
Accelerator control & operational infrastructure	216
Total	6690

1. Suuri kiihdyttävä gradientti törmäytin piteuden minimoimiseksi
2. Hiukkassuihkut nanometriluokkaa valmistustarkkuus, kohdistus, suoruuus ja stabilointi
3. Kustannukset ja rahoitus

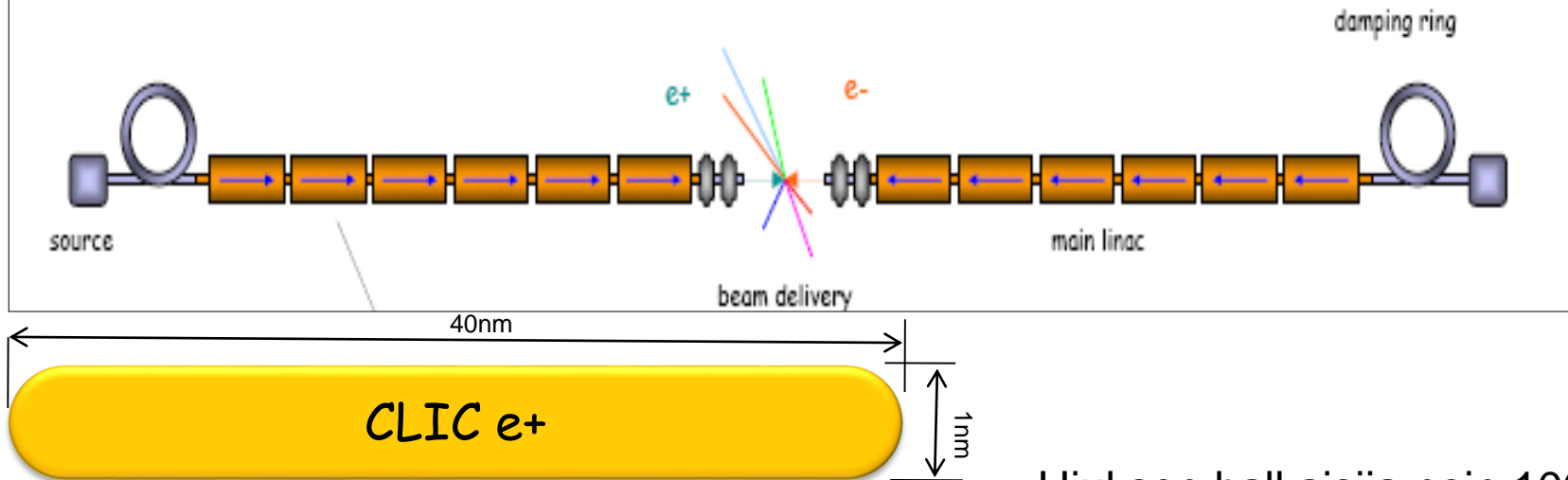

Hiuksen halkaisija noin $100 \mu\text{m}$
(100 000 nm)

- Korkea kiihdyttävä gradientti: vahvat sähkö- ja magneettikentät RF-komponenteissa
 - Komponentit huoneenlämmössä, normaali sähkönjohtavuus
 - Kuparia käytetään RF-komponenteissa erinomaisen sähkönjohtavuutensa takia
- Vaadittava asemointitarkkuus mikrometriluokkaa
 - Suoruus, absoluuttinen tarkkuus, liukuva ikkuna -ajatus
 - Lisäksi aktiivinen asemointijärjestelmä
- Stabilointi
 - Magneetit kiihdyttimessä sekä fokusointi
- Lämmönhallinta
 - Tämän hetkinen suunnitelma on jäähdyttää moduleita vedellä
 - Törmäyttimeen kokonaishyötysuhdetta optimoidaan *jatkuvasti*
- Tyhjiö UHV-luokassa (10^{-9} mbar)
- Hiukkassuihkut liikkuvat “lähes” valonnopeudella

Kiekkojen valmistus:

- *Cu OFE UNS C10100*
- *Muototarkkuus $\pm 2.5 \mu\text{m}$*
- *Pinnankarheus $Ra 0.025 \mu\text{m}$*
- *$\varnothing 80 \text{ mm}$*
- *Liittäminen diffuusiohitsaamalla*

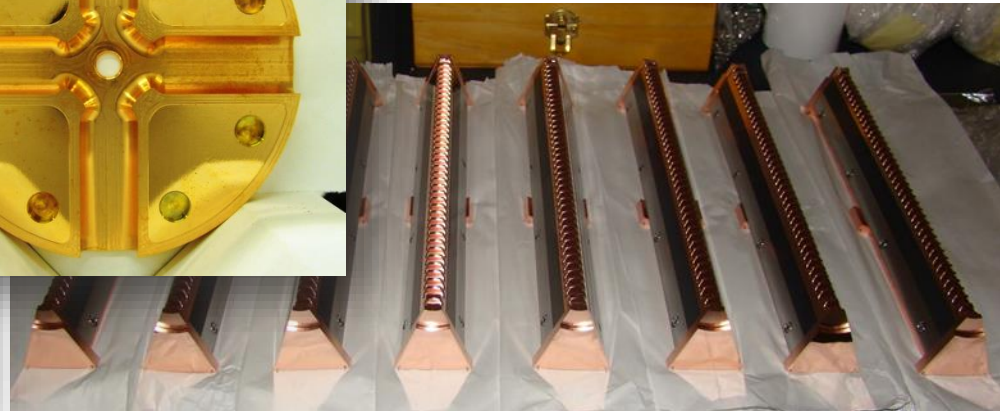
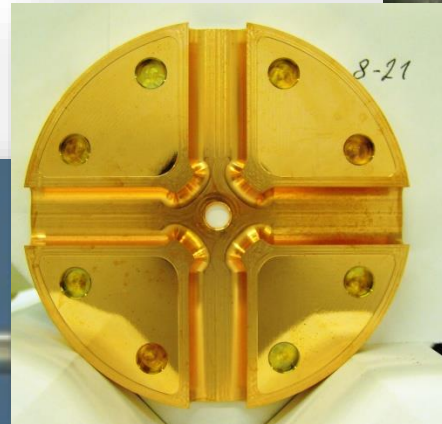
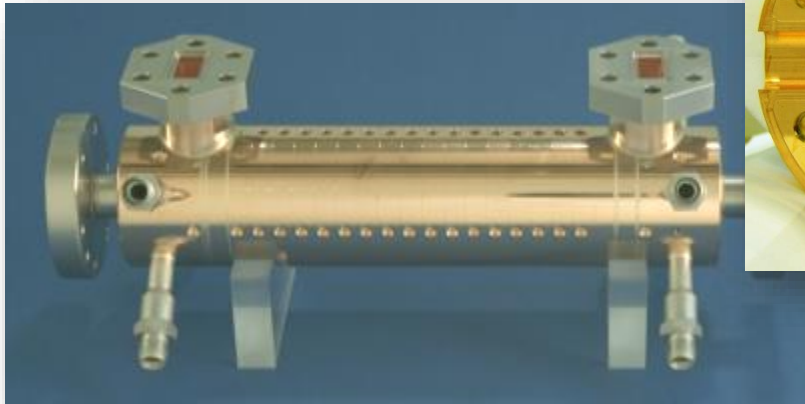
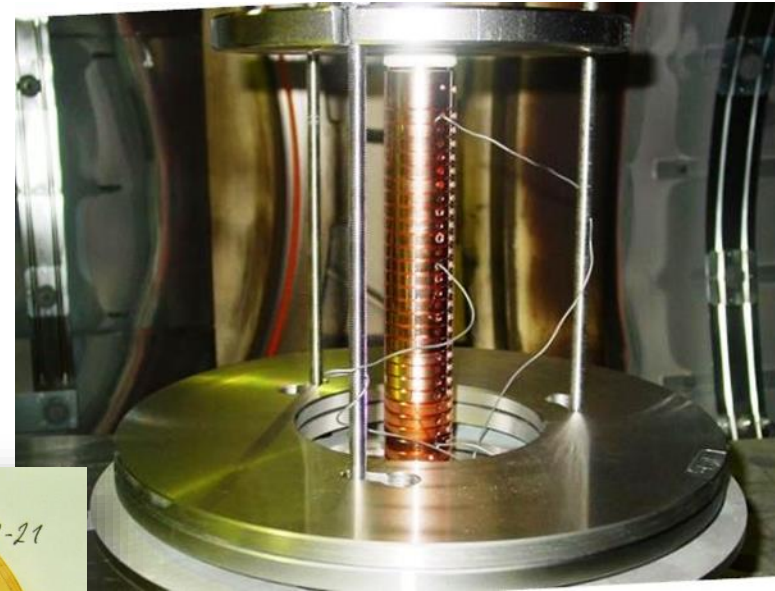

12.04.2018

L. Deparis

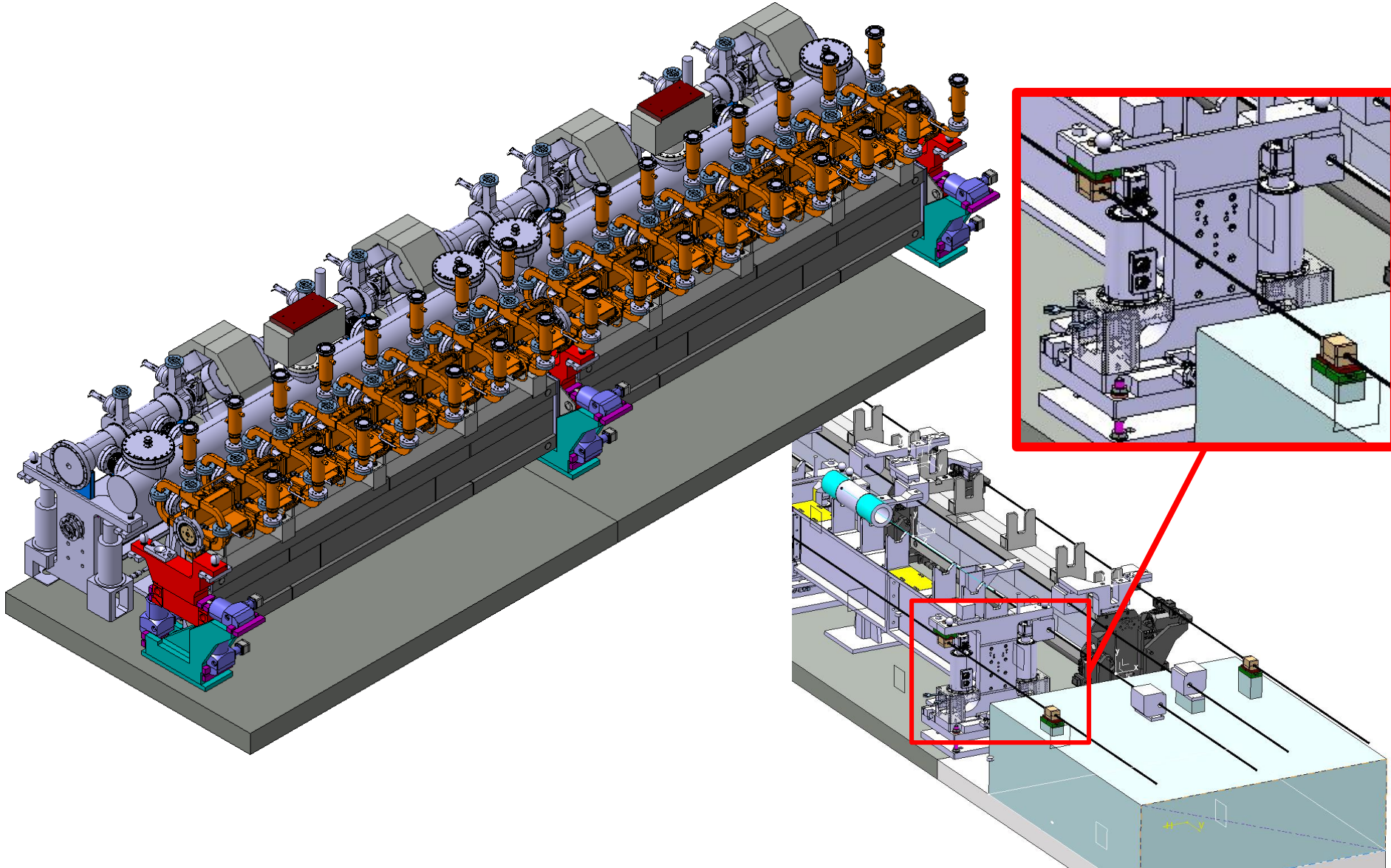

Determination of the position of the components

- Association of a propagation network every articulation point

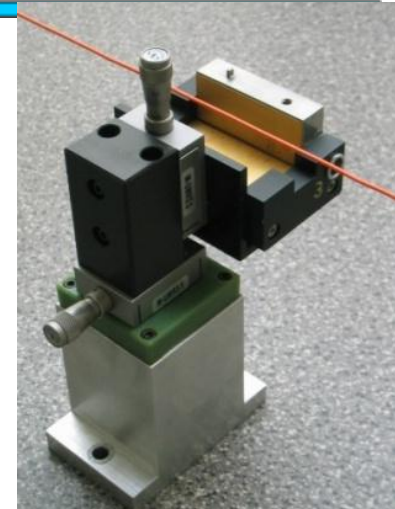
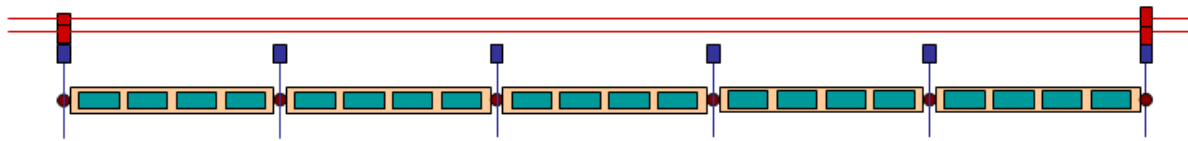

At the scale of the module:

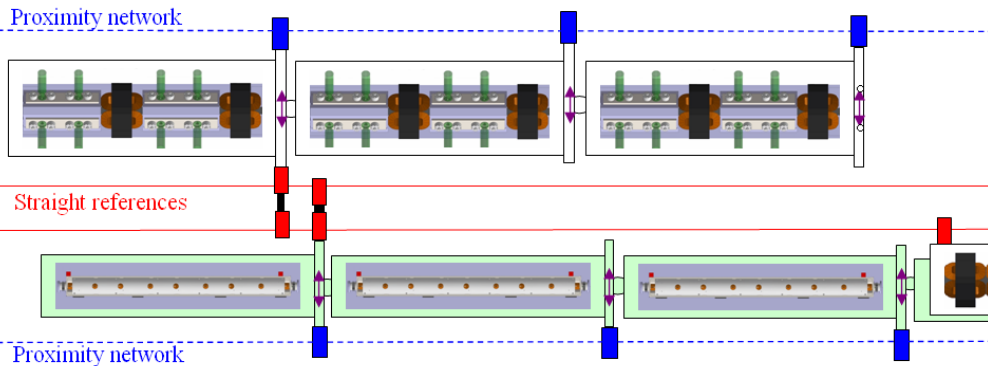
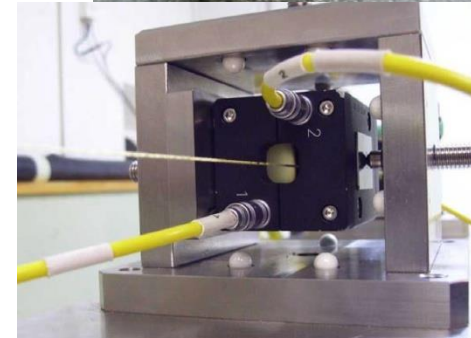
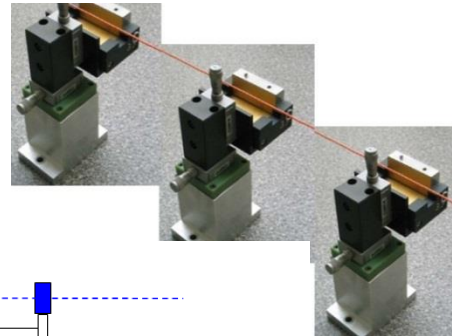

Drive beam (PETS + quad on the same girder)

Main beam (cavities on girder, quad independent)

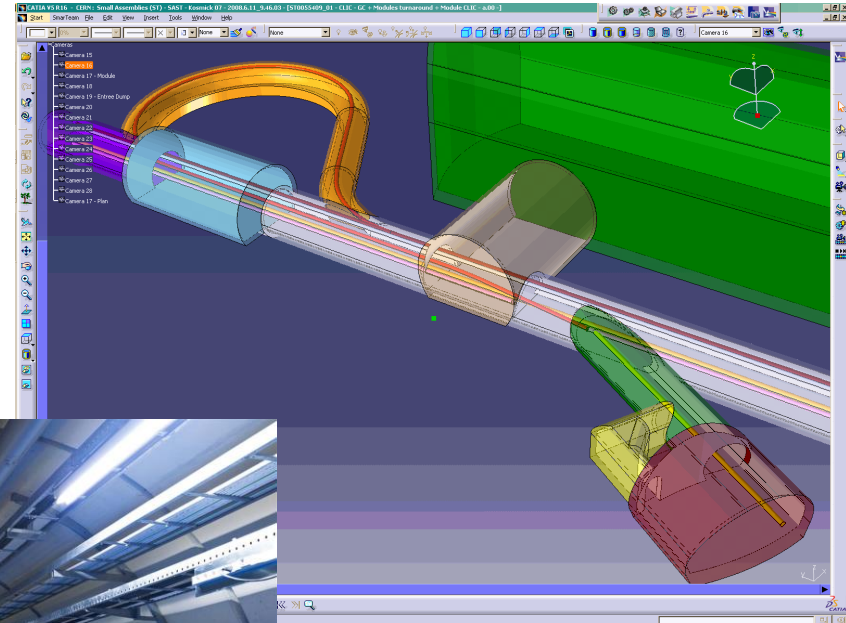
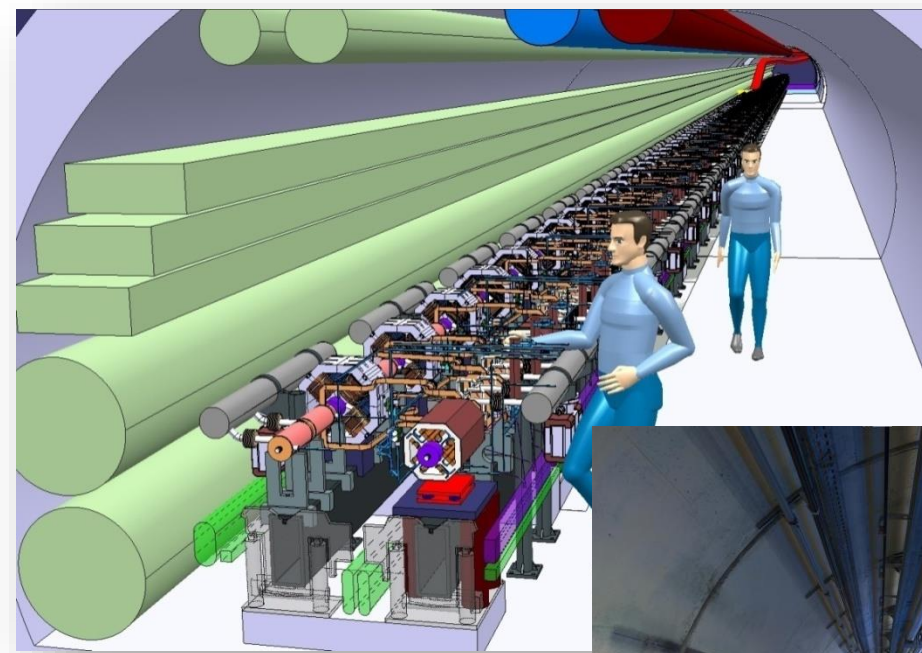

(Courtesy J. Osborne)



**Standard tunnel
with modules**

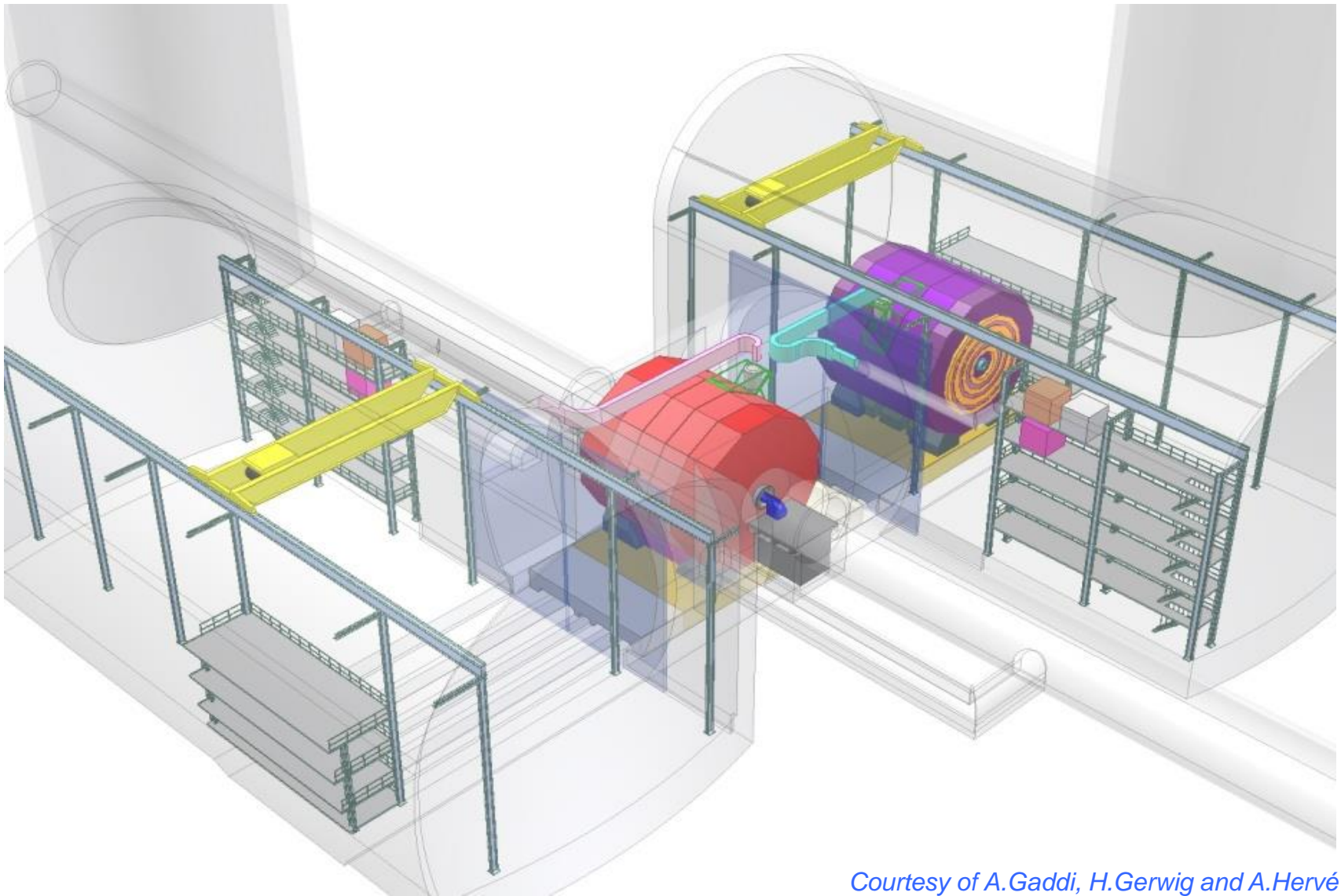

Courtesy of A.Gaddi, H.Gerwig and A.Hervé

Feedback

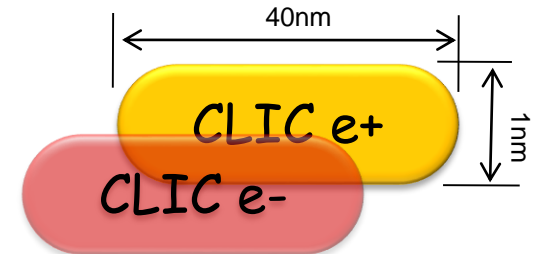

Active rejection of canteliver beam resonances: home-made

Mechanical structure and its instrumentation

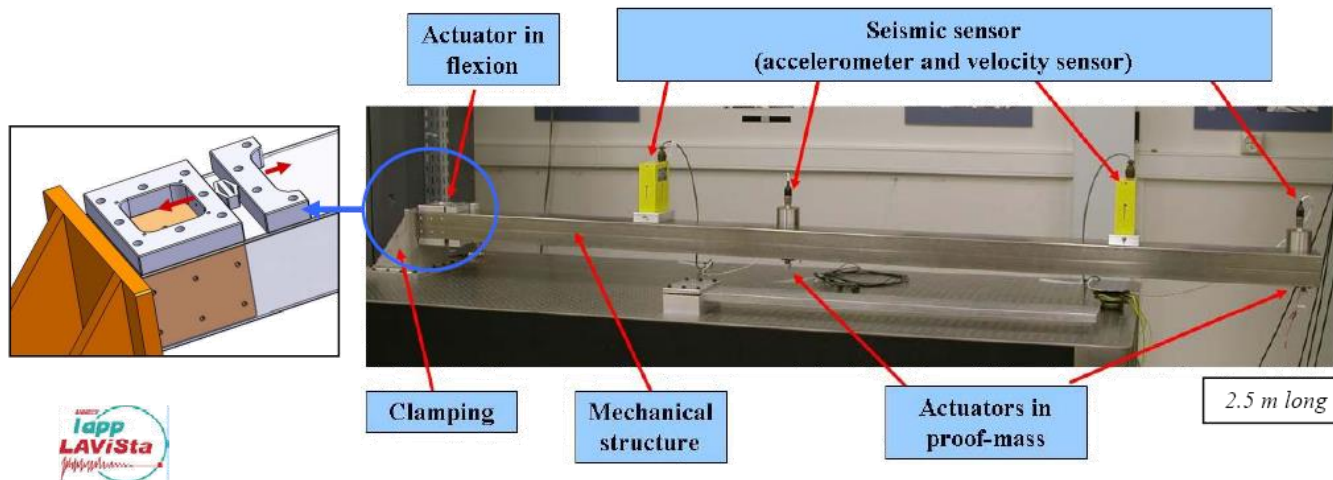

2008-05-30 C.Hauviller

CLIC seminar

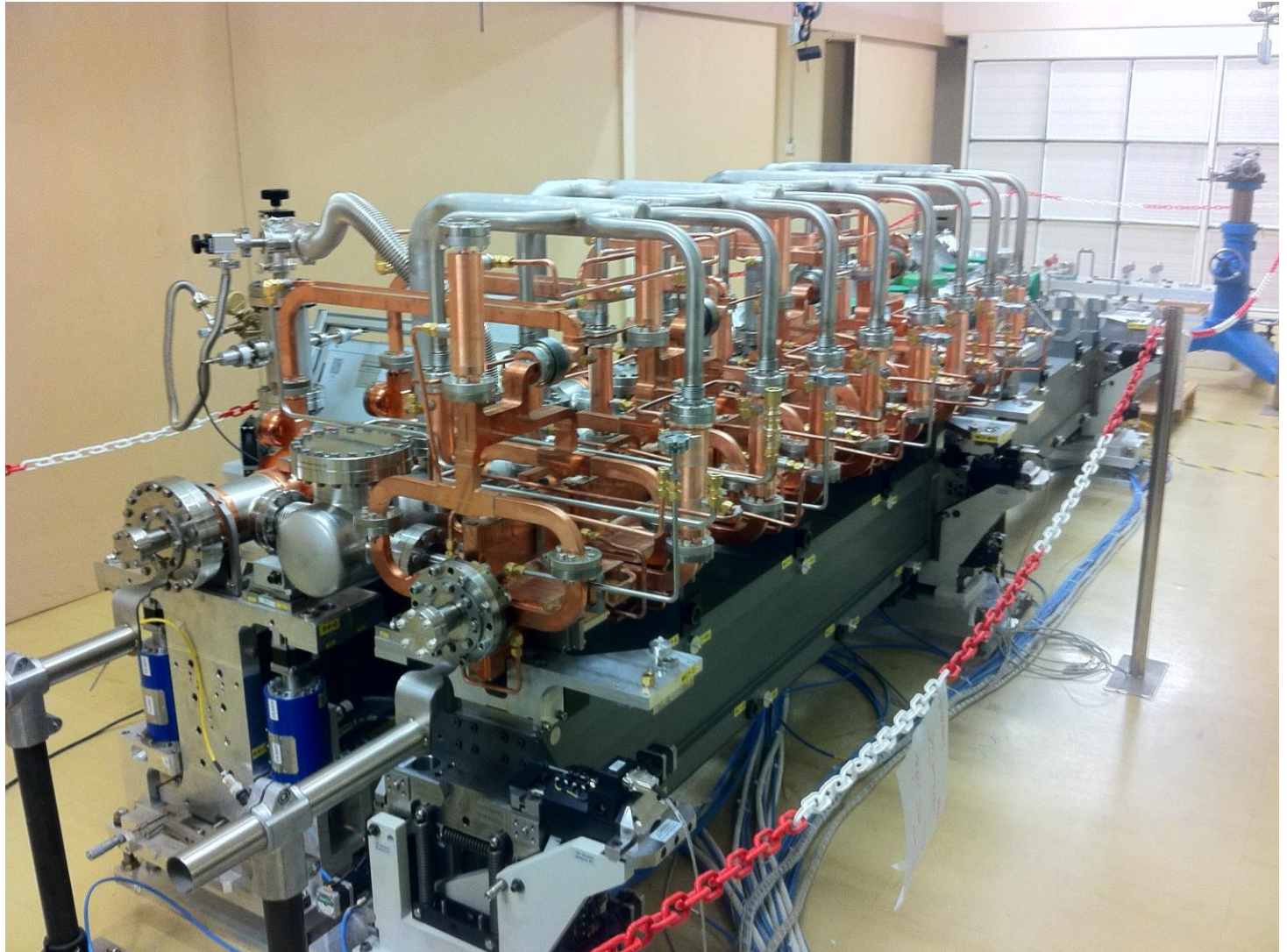
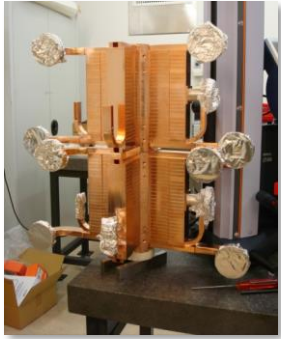

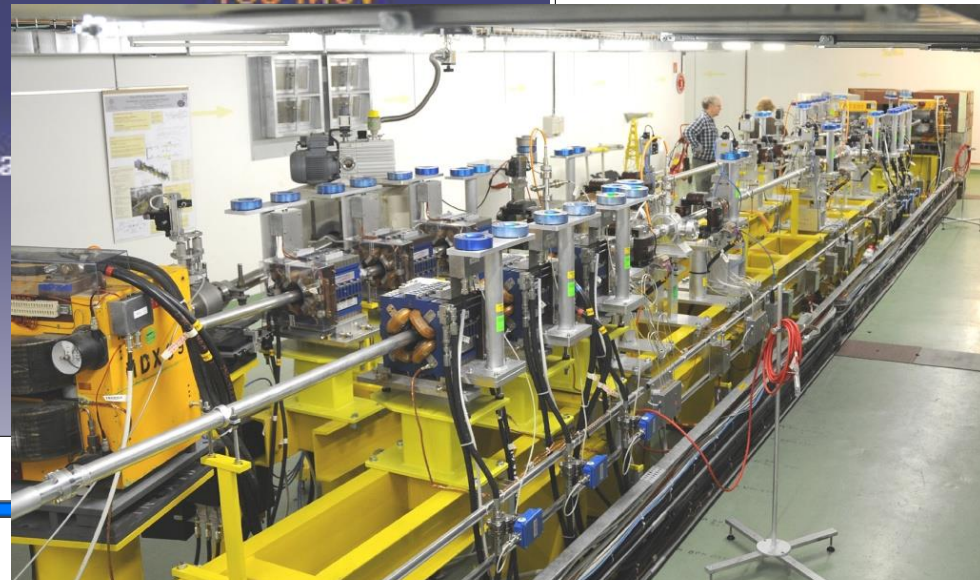
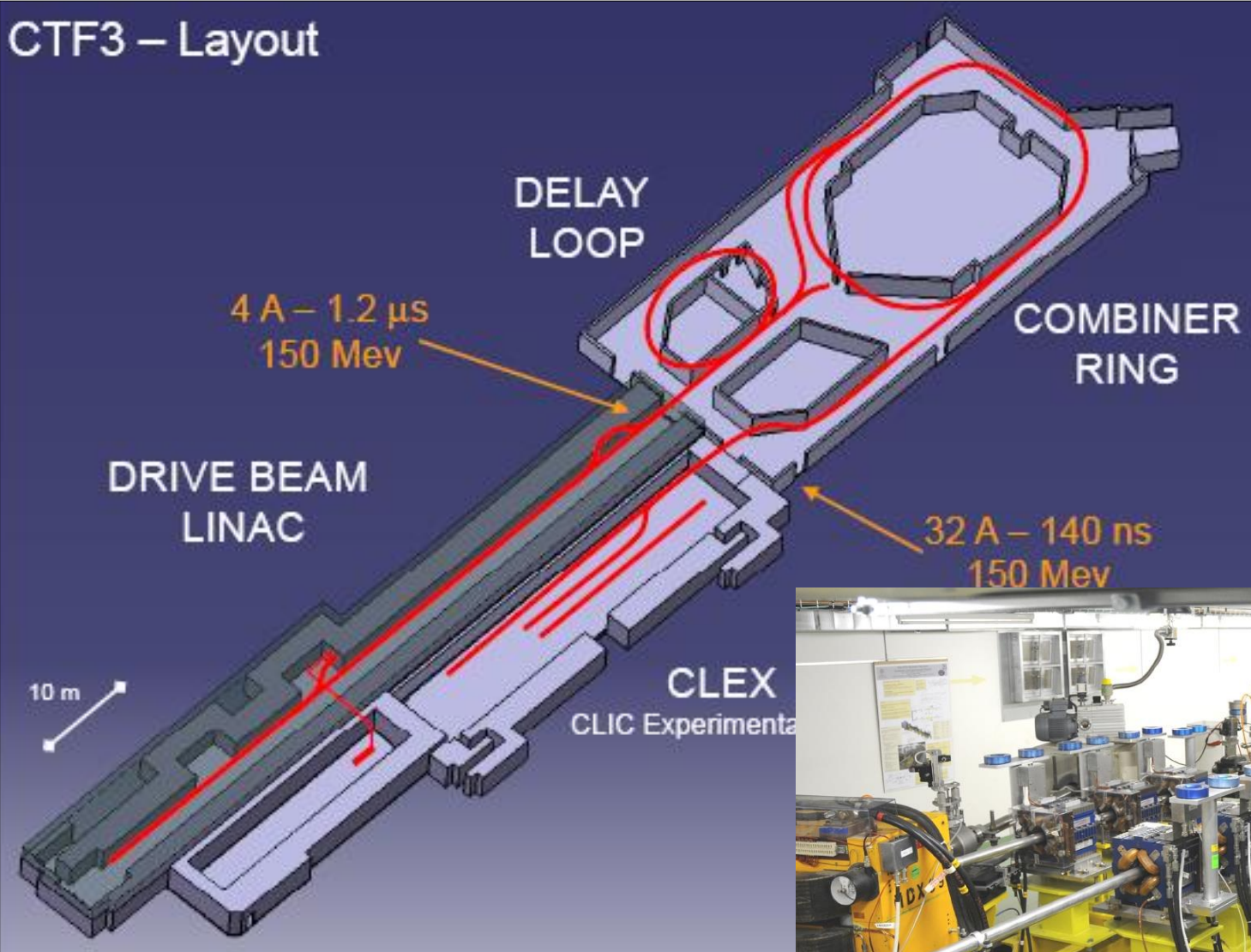

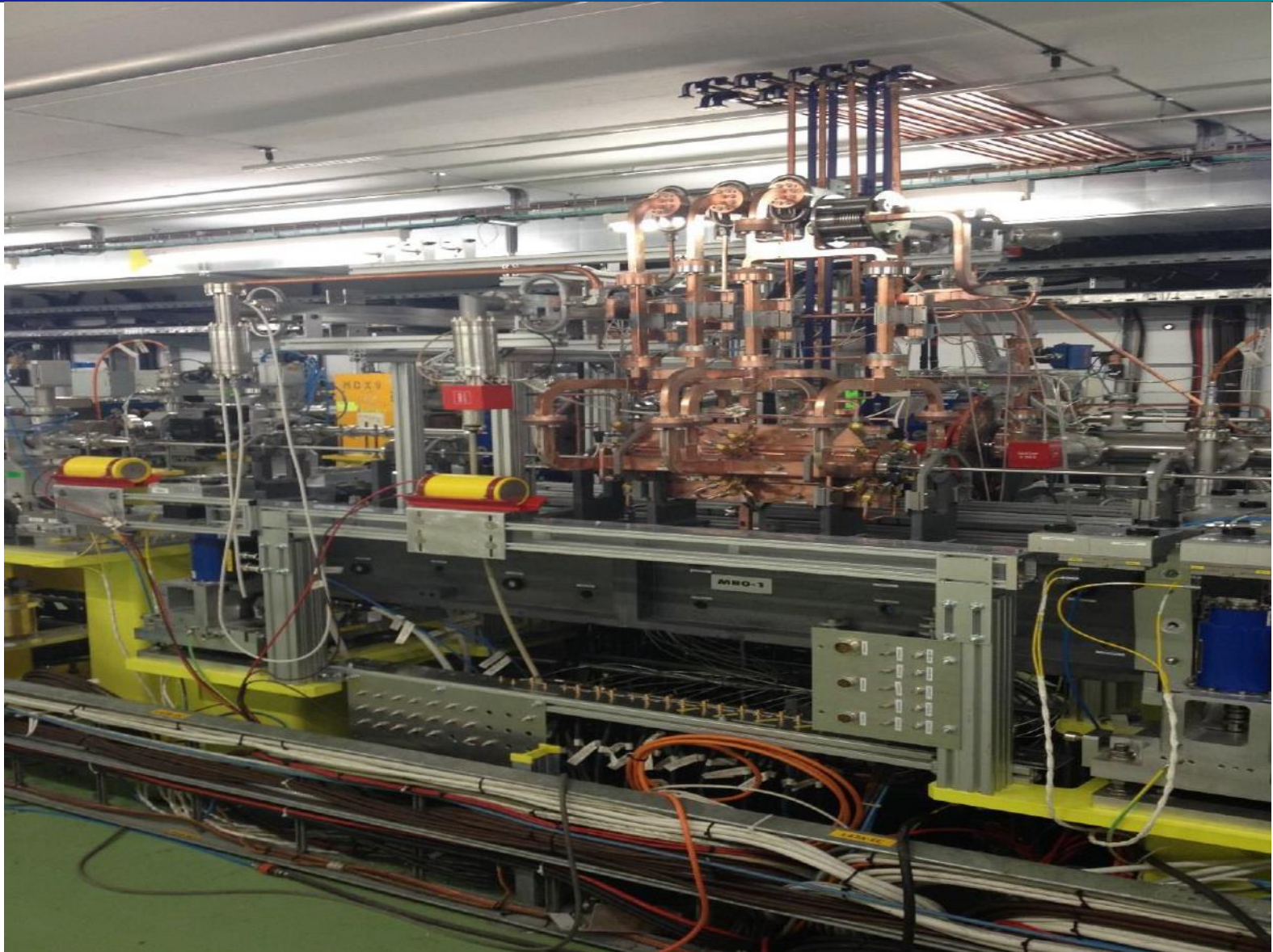

Numeerinen menetelmä, FEM

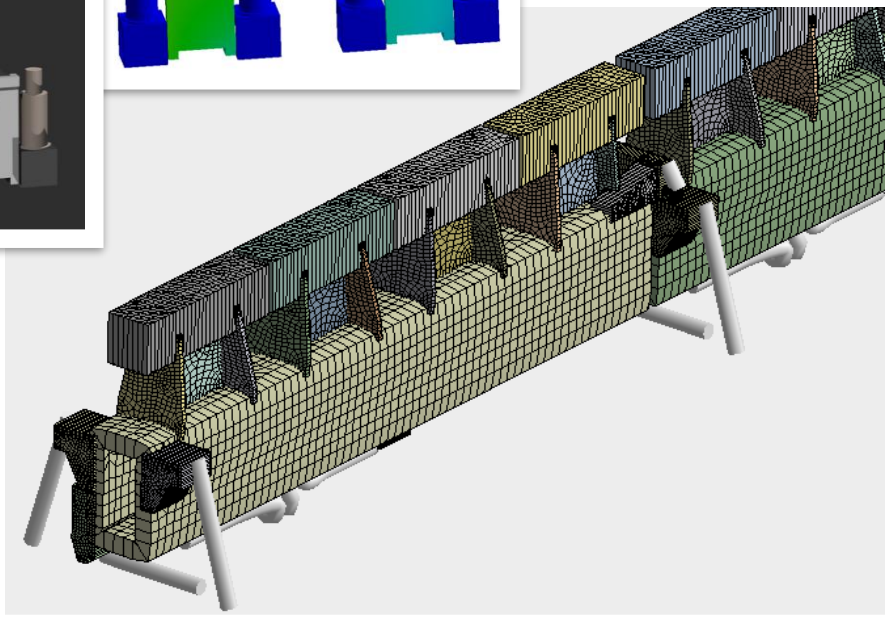
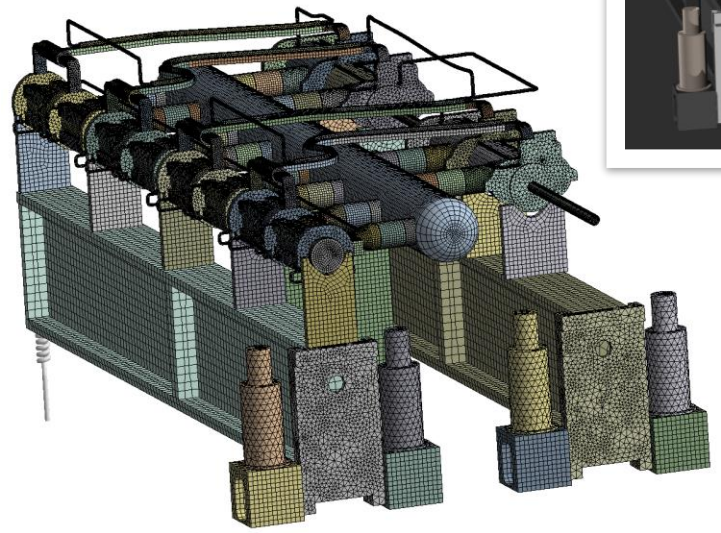
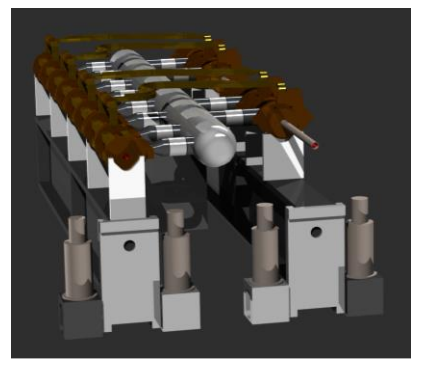
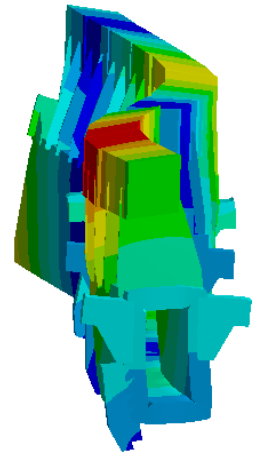
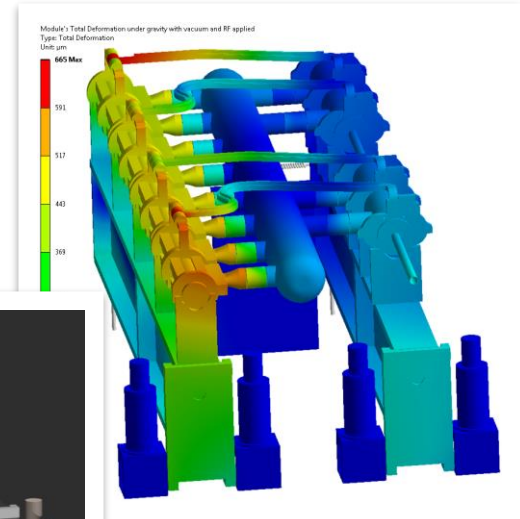
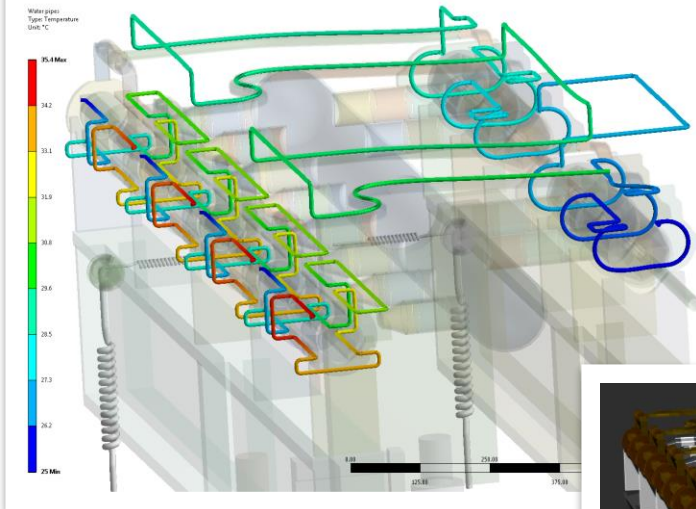

Courtesy of R. Nousiainen HIP/VTT



CLIC:n vaatimukset:
Muototarkkuus $\pm 2,5 \mu\text{m}$
Pinnankarheus Ra 25 nm

- key Technologies same as complex mechanical/optical key components
- often a combination of highly accurate 3d-form, positioning and roughness, as well as optical effects are required

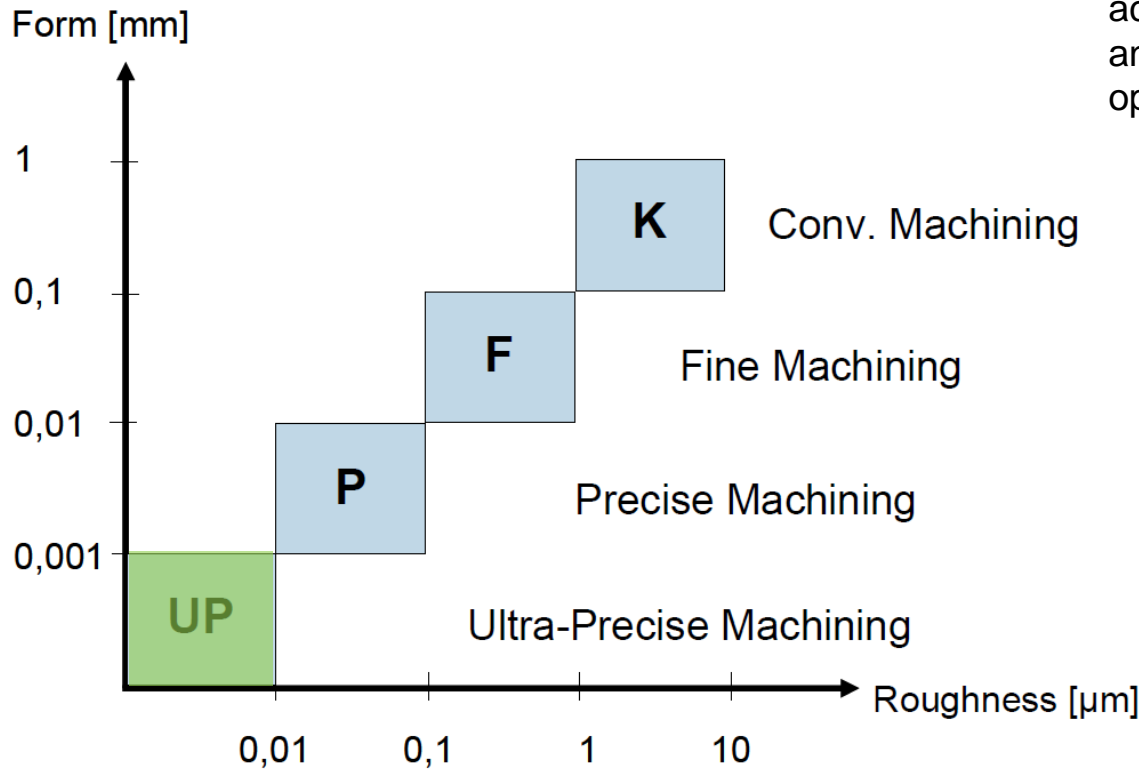

12.04.2018

L. Deparis

- Validointivaihe 1: komponentti/disk
- Validointivaihe 2: rakenne
- Hyväksytty partneri: osallistuminen tarjouskilpailuihin

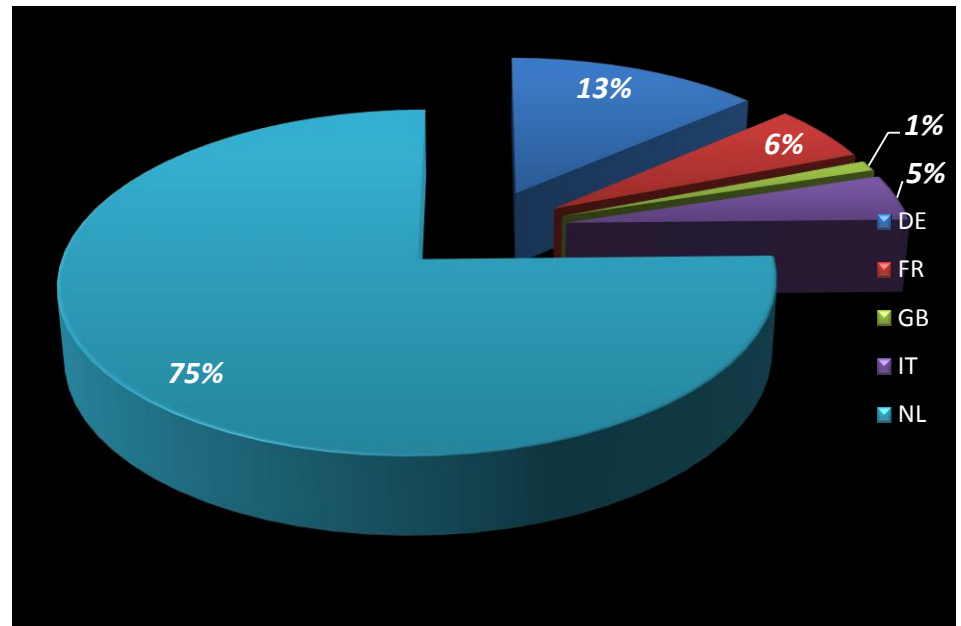

MeChanICs - Marie Curie Linking Industry to CERN

- 2010 -2014, henkilöliikkuvuusohjelma
- Cern, HY, Metso, Loval, Tarkmet, Mectalent, Lewel Group
- Yrityksistä 6-18 kuukautta Cernissä, Cernistä 2 kk yrityksissä
- 2 palkattua työntekijää 2 vuodeksi Cerniin

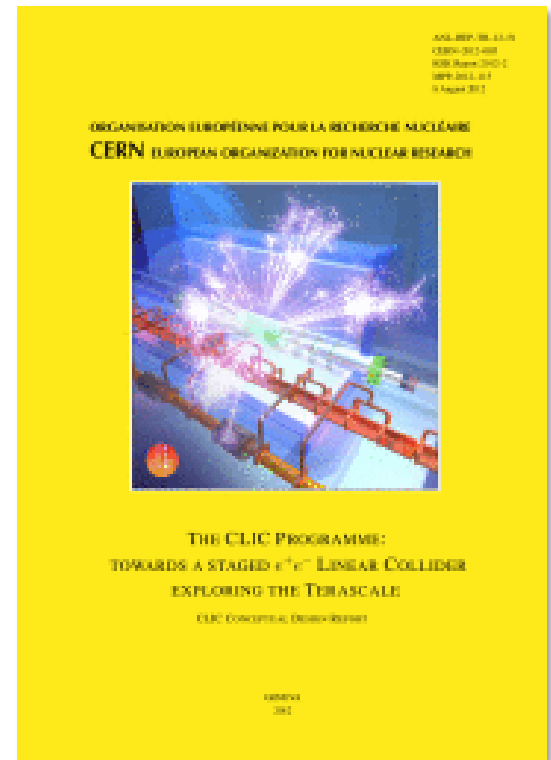
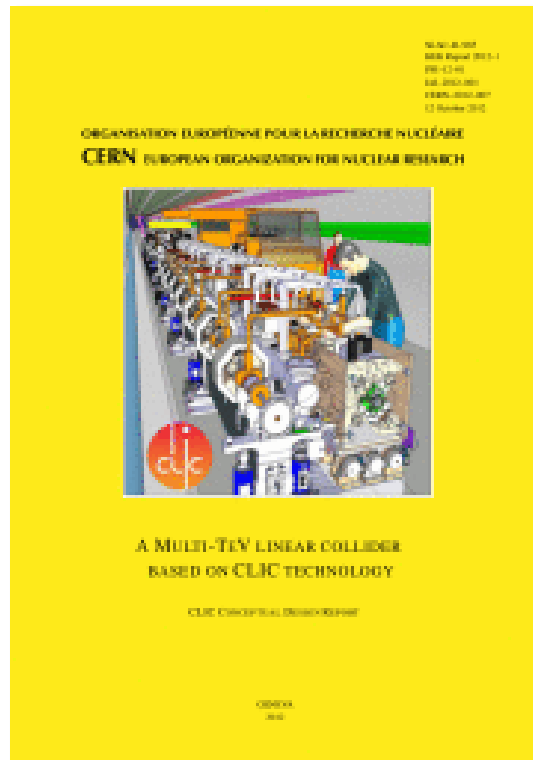
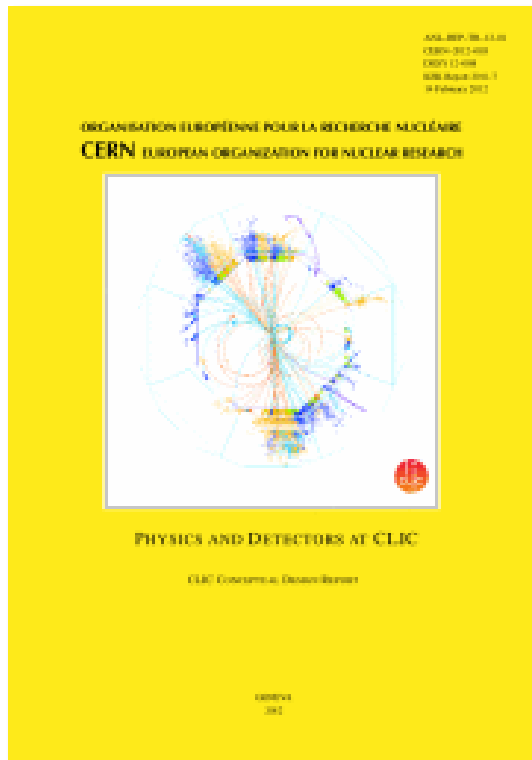

- Conceptual Design Report, CDR 2012
- 3 osaa: Fysiikka & detektorit, Kiihdytinrakenteet, Strategia, kustannukset & aikataulu
- Laajan kv-yhteistyöverkoston tulos: 40+ instituuttia osallisina, nyt jo yli 70
- Saatetaan käyttää mallina FCC CDR raportille

Lisätietoa:

<http://clic-study.org/>

CONCEPTUAL DESIGN REPORT (CDR)

<http://project-clic.cdr.web.cern.ch/project-CLIC-CDR>

CLIC showroom

Mikä on klystroni?

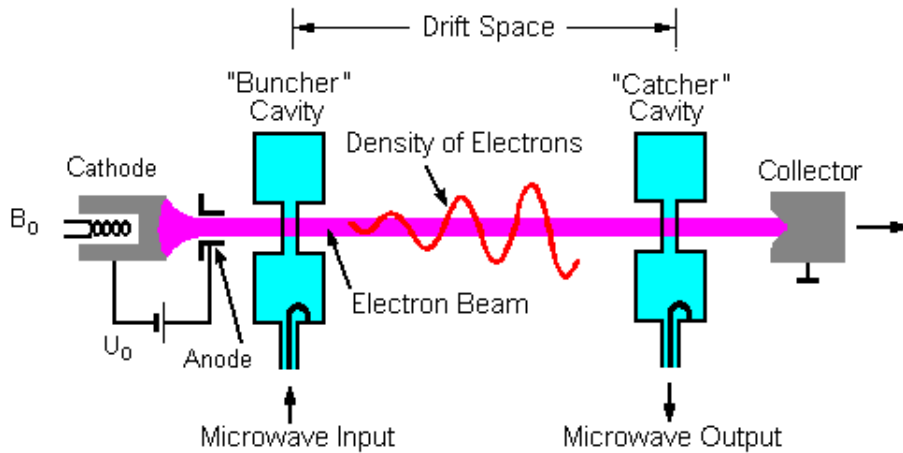

Klystronin toiminta:

1. Tasavirta elektronilähde.
2. Buncher-cavity (modulate the velocities)
3. Drift (the electrons gather in bunches)
4. Catcher-cavity (extract the electromagnetic wave)

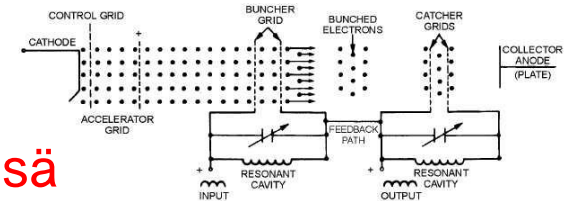

Korkea taajuus on hyödyllinen hiukkaskiidyttimessä

	1GHz klystron
	12GHz CLIC

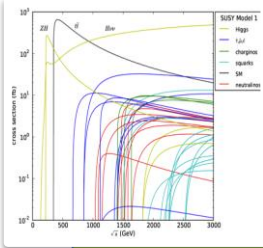

Physics - how do we build the optimal machine given a physics scenario (partly seen at LHC ?):
Understand the benefits of running close to thresholds versus at highest energy, and distribution of luminosities as function of energy

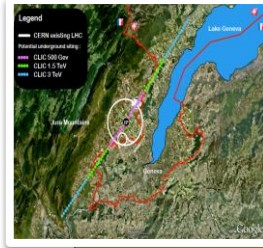

Construction scenario (and approval scenario):
Explore how we in practice will do the tunneling and productions/installation/movement of parts in a multistage approach ?
Environmental impact study

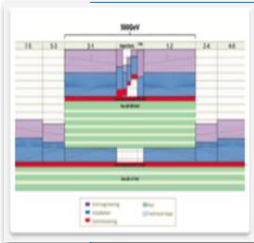

Timescale/lifecycle for project re-defined: Buildup of drive beam (CLIC zero), stage one – physics, more stages/extensions
Parameters: energy steps and scans, inst. and int. luminosities, commissioning and lum. ramp up times.

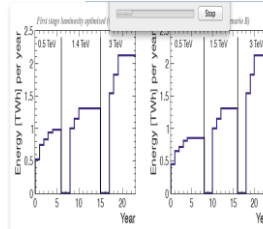

Power and energy development.
Have started to work on energy estimates (not only max power at max luminosity and the highest energy) based on running scenarios and power on/off/standby estimates

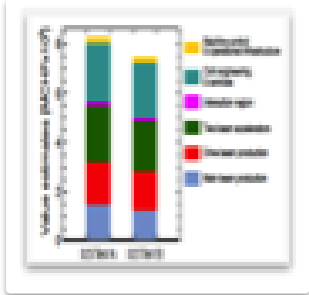

Costs - Initial machine plus energy upgrade:
External cost review 21-22.2.2012, costs discussed in volume 3 of the CDR

