

Ethernet-driven control and data acquisition scheme for the Timepix-based TPC readout

R.Degele, C.Kahra, **U.Schäfer**,
S.Tapprogge, D.Wicke, M.Zamrowski
Univ. Mainz

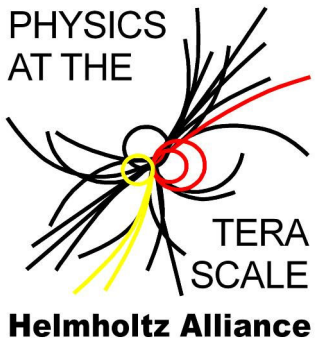

TPC readout chain

TPC to be read out by one or several pixel sensors (256*256 pixels)

- Timepix chip bonded on a FR4 carrier
 - Amplifier
 - Discriminator
 - TDC
 - Time Over Threshold
 - Common stop
 - Serialiser (LVDS link)
- Flat cable connection (ZIF) to adapter board
 - Trigger, test pulse, voltage monitor
- Flat cable connection to Xilinx ML506 evaluation board
 - FPGA Virtex-5 (XC5VSX50-TFFG1136)
 - Deserialiser
 - Buffer
 - Ethernet / IP packet engine (UDP)
- Ethernet link to computer

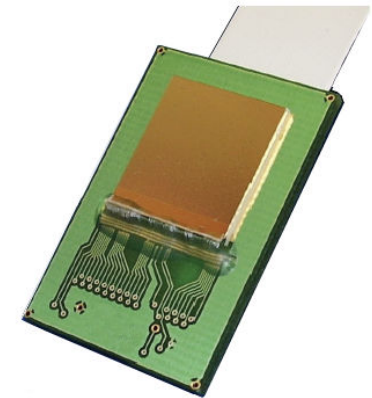

TPC readout chain

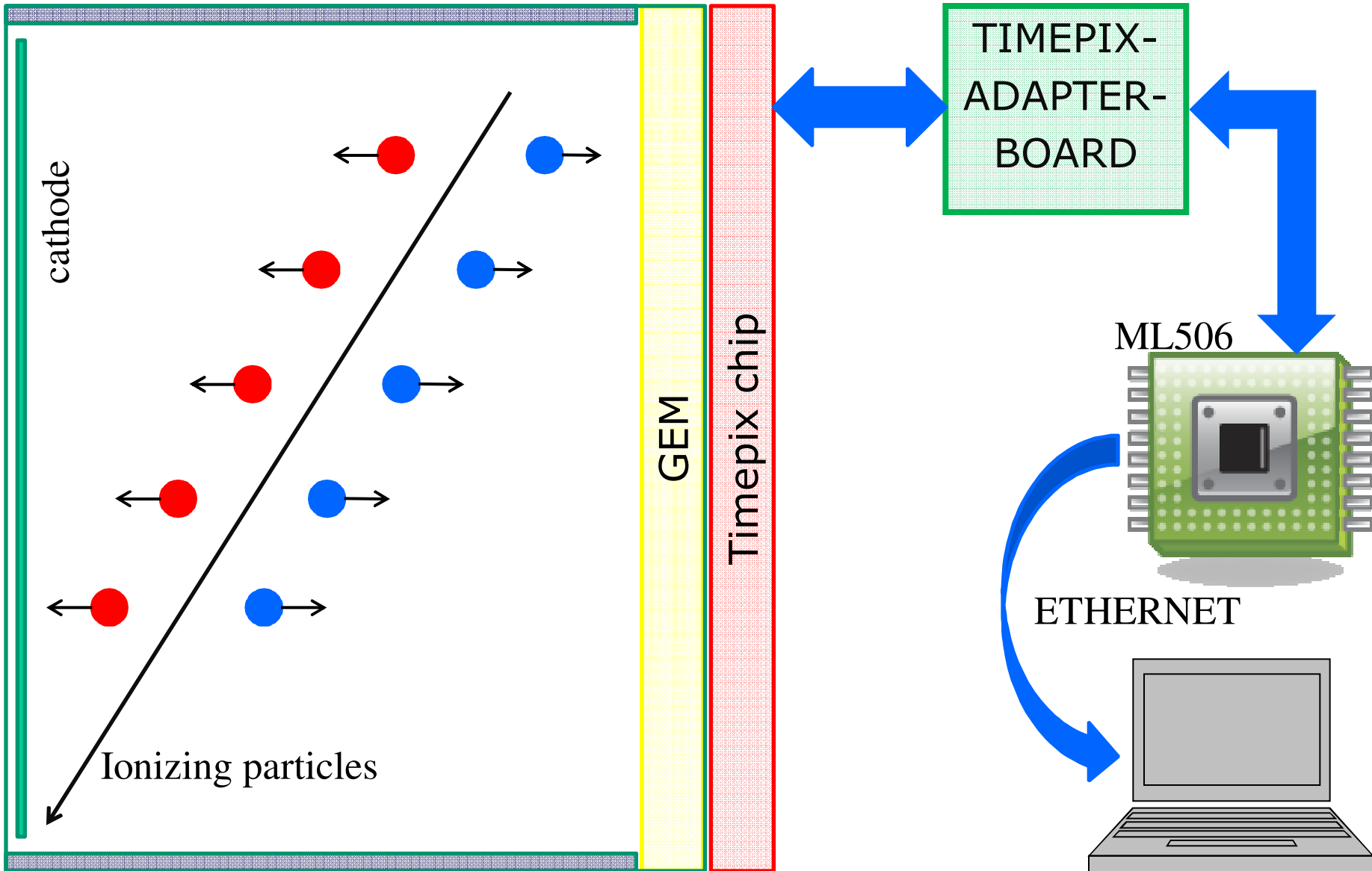

Lab test setup

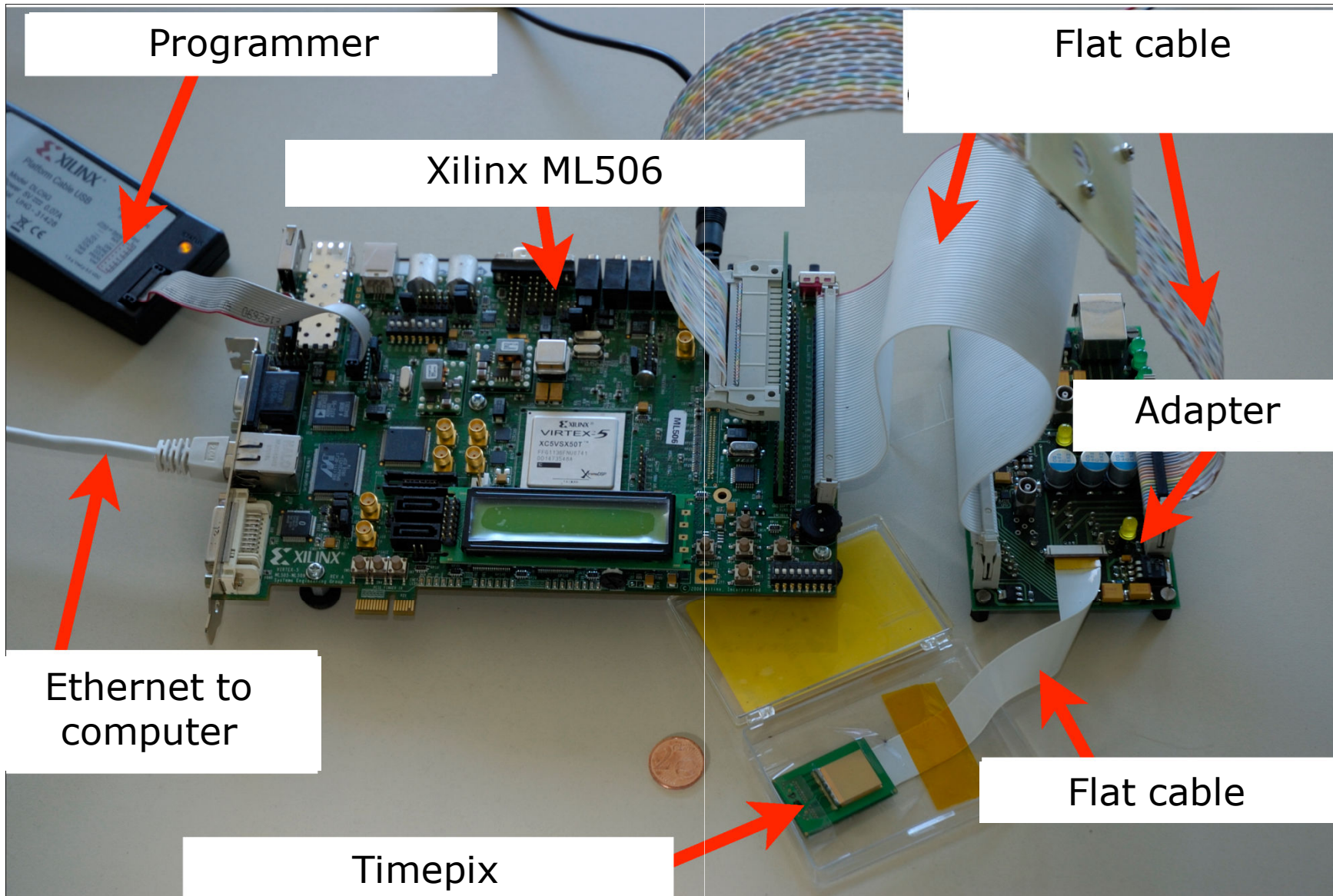

Timepix

- 256*256 channel matrix
- 55 μ m * 55 μ m pitch
- Analogue input stage with per-pixel threshold adjust
- Digital TDC w. 14-bit LFSR counters @ up to 100MHz
- Several conversion modes incl. TOT and common stop
 - shutter input
- No zero suppression
- Serialisation of matrix data (\sim 1Mbit) into LVDS output
- Auxiliary controls:
 - Test pulse in
 - Diagnostics : analogue monitor for internal current sources (DAC_OUT)

Timepix

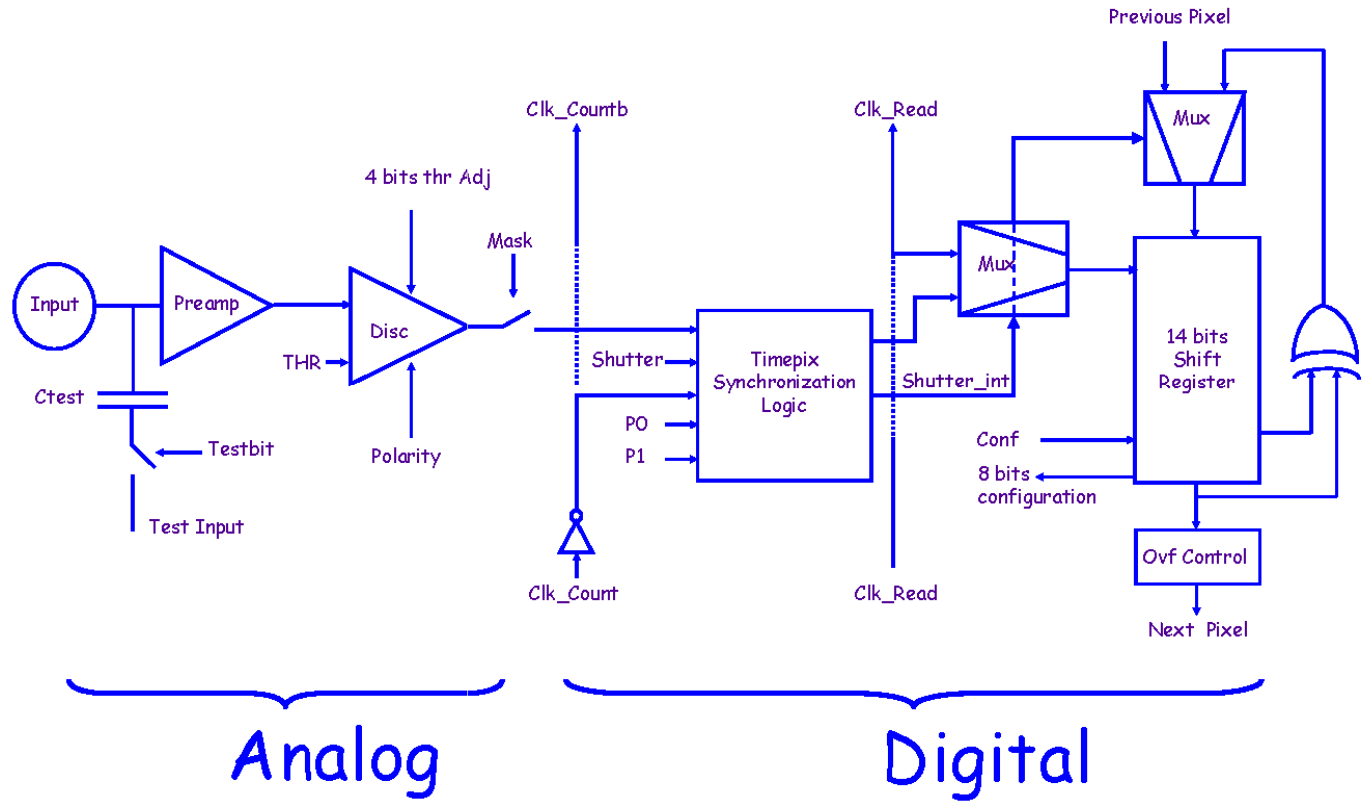
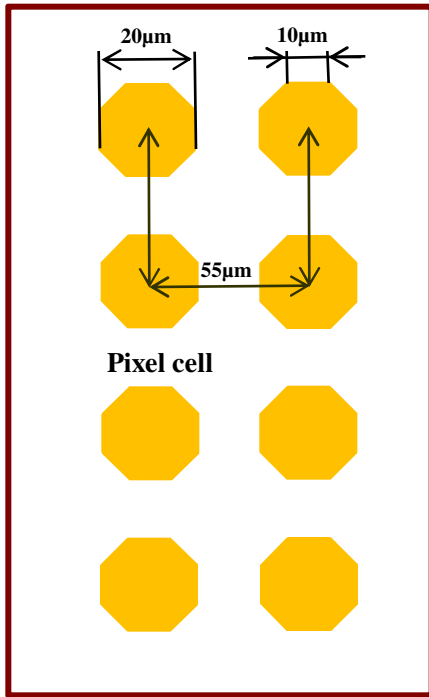

Timepix – a few particularities

- There exists a global threshold setting (THL, 14-bit)
- Pixels can be threshold-corrected individually by a 4-bit value.
- Range of threshold correction is set globally (THS)
- Above global settings and other current source settings can be read back as analogue voltages via DAC_OUT pin for diagnostic purposes
- Counters are 14-bit Linear Feedback Shift Registers = Pseudo Random Number Generators
 - Require linearisation so as to recover the time/amplitude information
 - Require special consideration if zero suppression or thresholding are to be done
- Serial communication done by a simple clock/data/enable interface, through shift register

Adapter board

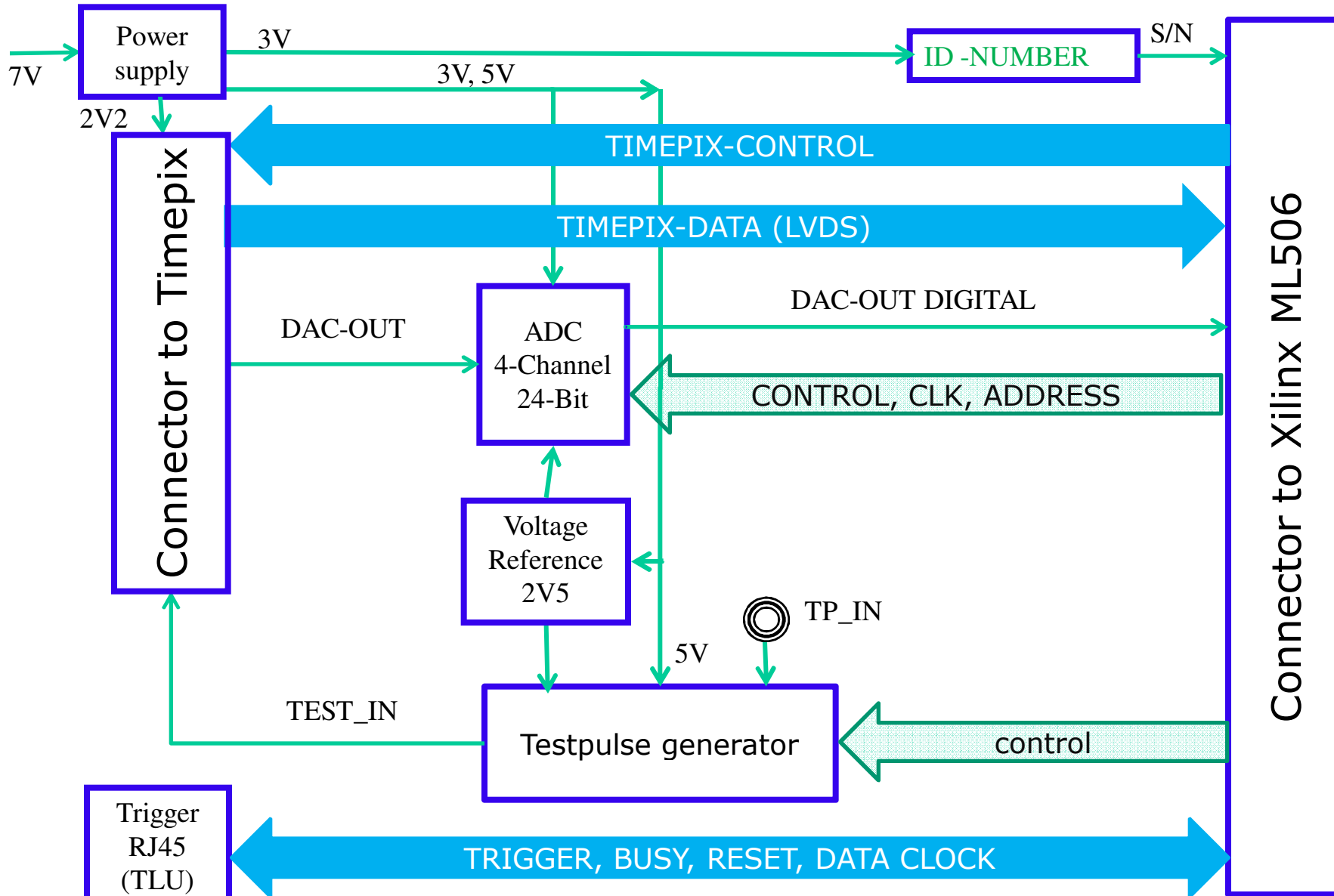

Adapter board

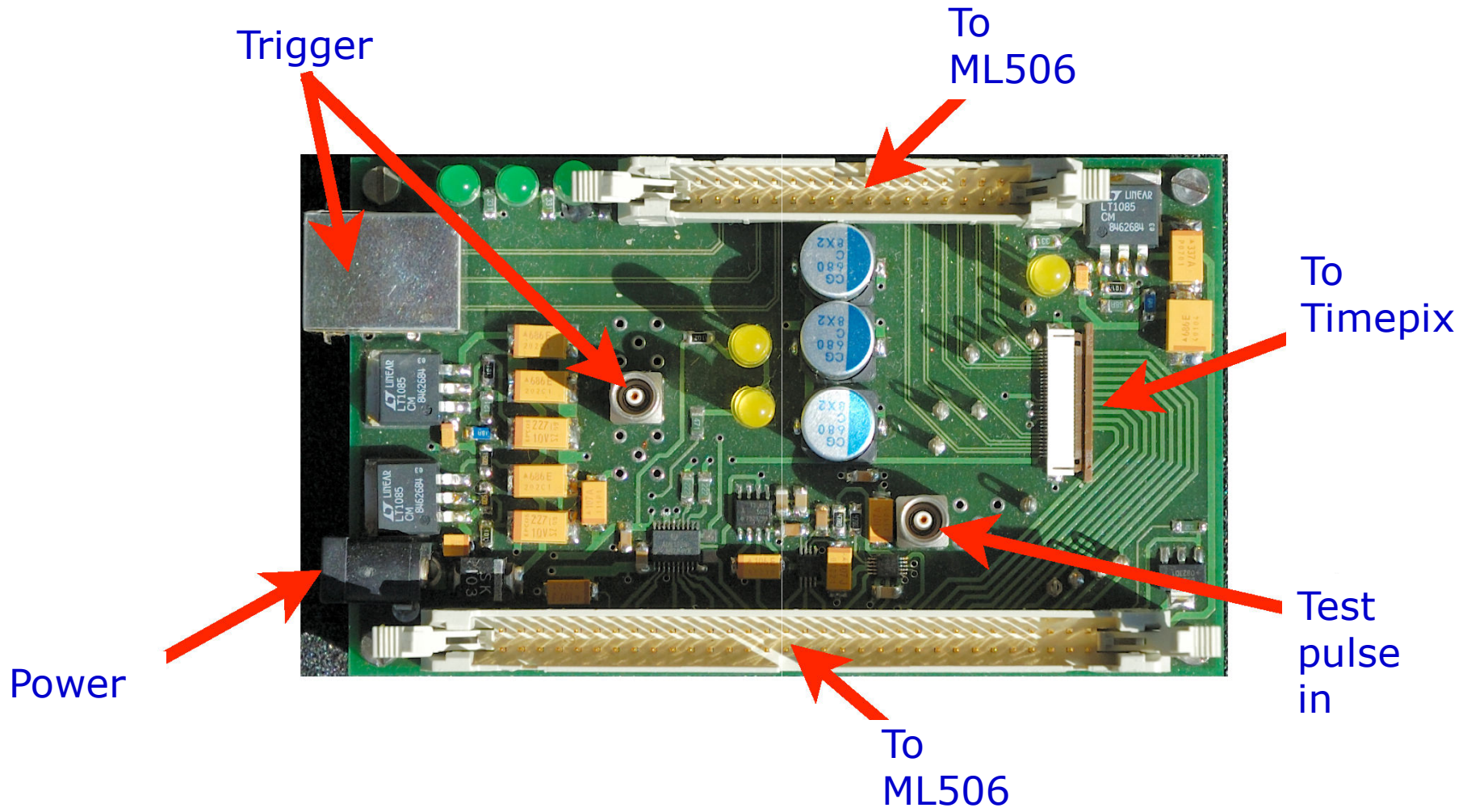

FPGA module : Xilinx ML506

- Virtex-5 based : XC5VSX50-TFFG1136
- On-chip Ethernet MAC
- On-chip 3Gb/s serial links : run at 1Gb/s for Ethernet
- On-board Gigabit Ethernet phy chip (1000BASE-T)
- 64 bit user I/O on 2.54mm headers
- Nonvolatile configuration storage via SystemACE (CompactFlash card)
- A lot of periphery, not currently used for Timepix readout

FPGA Firmware

- VHDL description
- Common clock for digitisation and data transfer, crystal based, frequency currently hard coded in VHDL
- SerDes interface to the Timepix bit-serial port
- Control and status registers, data stream pass-through
- Network communication based on Xilinx-supplied Ethernet macro (TEMAC wrapper)
 - No embedded CPU
 - Minimalist network protocol stack
 - UDP only
 - No management protocols (ARP etc.)
- Shutter operated under software control or in response to a trigger (TLU) with programmable delay and width
- Timepix protocol not fully understood from documents
→ modelled on MUROS2 readout scheme

Firmware : Data transport to computer

Data transmission scheme to readout PC using UDP protocol:

<ethernet> <IP> <UDP> <control> <data>

- standard Ethernet/IP/UDP headers
- 18-byte control field mapped to register file within the FPGA (control and status words)
- Variable length data field carrying data to/from Timepix chip
- Timepix matrix data not buffered on FPGA, data kept on Timepix while awaiting packet transmission
- Data pulled by computer (handshake)

Control software

- C++
- Currently command line interface only, no GUI
- Base functionality:
 - Reset Timepix
 - Set current sources (write FSR)
 - Enable test pulse
 - Set Timepix matrix
 - Read out matrix
 - Operate shutter
- Complex operations
 - Start a run : initialise matrix and read it out upon reception of a trigger, linearise data, write to file
 - Pixel calibration

Pixel calibration

Intercalibrate all pixels so as to achieve a uniform noise level across the whole of the chip

- Measure noise in TOT mode for a fixed period of time
- Repeat the measurement for
 - All global threshold settings (0 to 16383) (THL)
 - All per-pixel threshold corrections (0 to 15)
 - A pre-set correction scale (THS, 0 to 255)
- Calculate optimum per-pixel correction values

Software status:

Base functionality and run control done

Pixel calibration s/w development under way

To do: read back current source data (DAC_OUT)

Tests / Results

- Timepix and readout wired up in the lab (Mainz)
 - Run with TPC in Bonn
 - Readout working at
 - Event rates up to 23 Hz @ 40MHz system clock ++
 - Scaling to 33 Hz @ 100MHz clock
 - Readout rate of bare Timepix would be (100Mbit/s) / 1Mbit = 100Hz
 - FPGA code pipelined, packet overhead is low
 - FPGA currently polled by PC, i.e. handshake for each packet transmitted
- Bottleneck probably due to latency in Linux IP stack

Results: Some basic sanity checks ...

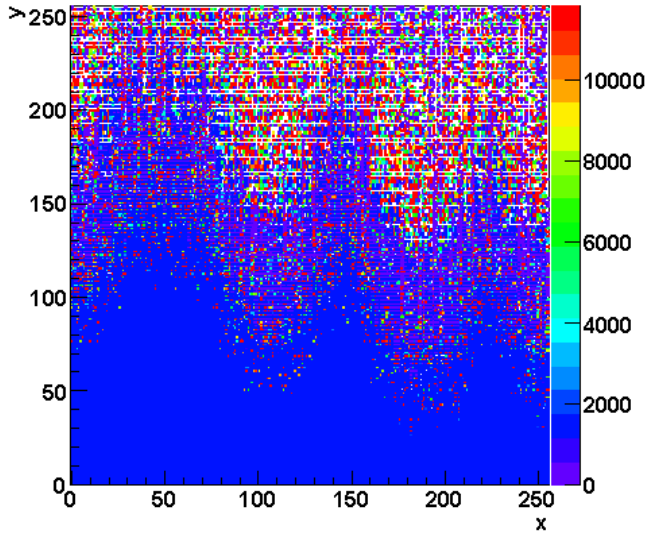

Timepix pixel
matrix
256*256

← Noise @ threshold THL=290,
common stop mode

8000 test pulses, counter mode. 17*13
pixel clusters masked out

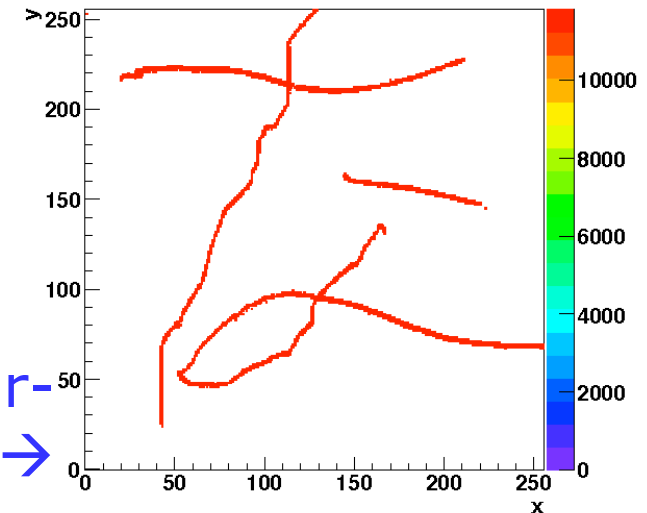
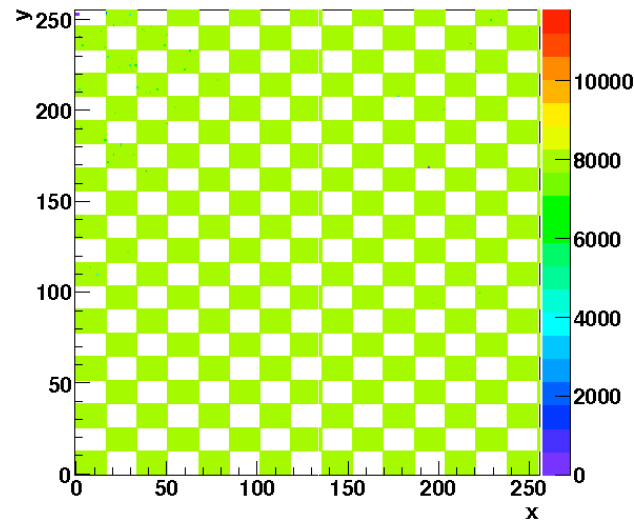

Locally induced noise, "written" to Timepix sur-
face with a pulser and an insulated wire →

Results: muons in the TPC

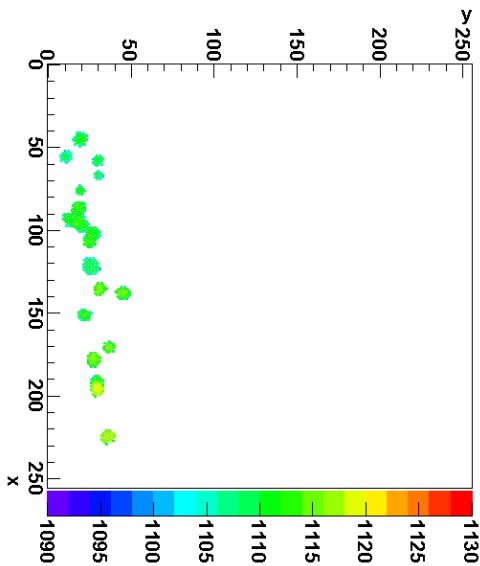
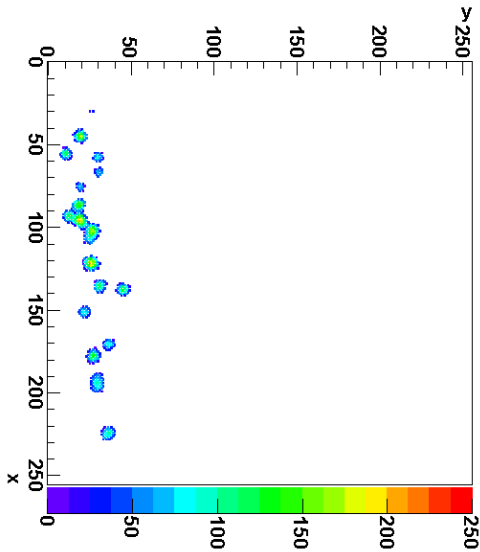

← Energy deposit →
(TOT mode)

Muon tracks crossing the TPC
← at 8.9cm and 2.8cm →
distance to readout plane.

Both deposited charge and
drift time measured
concurrently by operating
every other pixel in TOT or
common stop mode

← X-Y-Zdrift view →
(common stop mode)

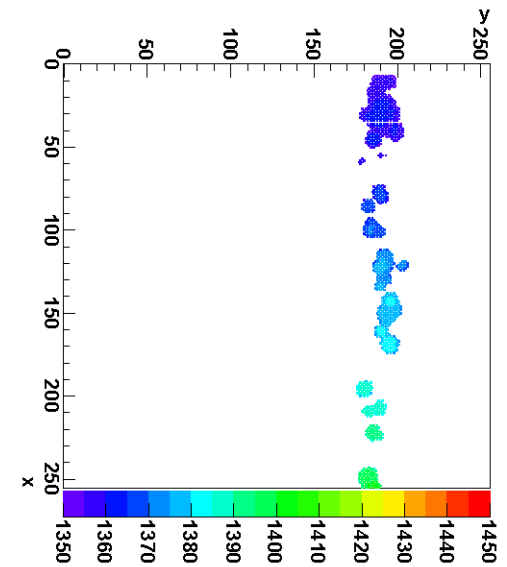
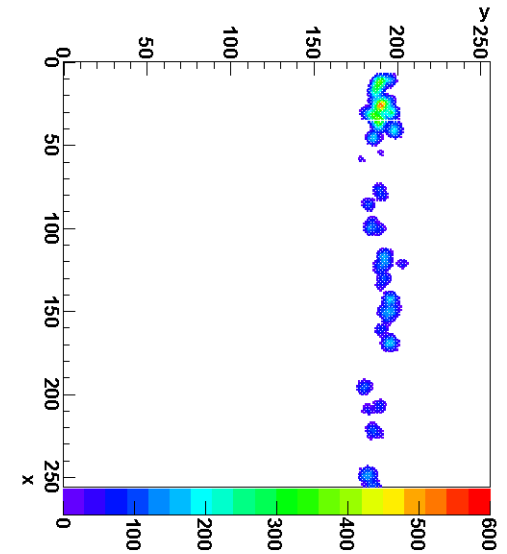

Summary / Outlook

- A readout system for a TPC, with Timepix-based digitisation, has been implemented on a Xilinx ML506 development board (Virtex-5)
- Data path off the FPGA into the computer via Gbit Ethernet and UDP protocol
- Readout rate currently up to 33 events per second
- System successfully operated in the electronics lab and on a TPC
- Plans:
 - Re-target to Virtex-6
 - Increase event rate
 - Increase channel count
 - Consider zero-suppression on the FPGA
 - ...