

SUPERSYMMETRY: MODELS AND PHENOMENOLOGY

Lectures at Pre-SUSY 2019, Corpus Christi.

XERXES TATA
University of Hawaii

- ★ Link to Steve intro lectures.
- ★ Bits about models (Michael from top-down)
- ★ Bits of supersymmetry phenomenology
- ★ What have experiments taught us?
- ★ Mention personal take on why I feel SUSY remains the best game in town despite non-appearance at LHC.

Only brief mention of SUSY DM (Graciela's domain). Also no clever collider kinematics (KC lectures).

Many review articles and lecture notes (TASI, SLAC, Swieca, Seoul...)

Haber+Kane, Nilles – old classics

Martin (ageless)

Now also a number of text books

- ★ Weak Scale Supersymmetry, Baer + XT (Cambridge)
- ★ Sparticles, Drees, Godbole, Roy (World Scientific)
- ★ Supersymmetry, Binetruy (Oxford)
- ★ Supersymmetry in Particle Physics, Aitchison (Cambridge)
- ★ Supersymmetry, Supergravity, and Unification, Nath (Cambridge)

SUSY has been an active area of phenomenological research since the early 1980s.

- Largest possible symmetry of the S -matrix
 - Synthesis of bosons and fermions
 - Possible connection to gravity (if SUSY is local) and to dark matter (if, motivated by other considerations, we impose R -parity conservation or some other symmetry).
- ★ SUSY ameliorates the big hierarchy problem. Low scale physics does not have quadratic sensitivity to high scales if the low scale theory is embedded into a bigger framework with a high mass scale, Λ . (Kaul & Majumdar; Witten)
- Only reason for superpartners at the TeV-ish scale.

Bonus: Measured gauge couplings at LEP unify in MSSM but not in SM if SUSY is at the weak scale

Recipe for writing Global SUSY Gauge Theories

- ★ Choose a gauge group $(V_{\mu A}, \lambda_A)$;
- ★ Choose the particle content (\mathcal{S}_i, ψ_i) ;
- ★ Choose a superpotential (holomorphic \hat{f} , consistent with gauge and other symmetries you want to incorporate);
- ★ Plug into master formula;
- ★ Add soft supersymmetry breaking terms consistent with Lorentz invariance, gauge symmetries and any other symmetries you want to impose.

λ_A and ψ_i are Majorana fields; ψ_{iL} is Steve's two component matter fermion field.

$$\begin{aligned}
\mathcal{L}^{\text{SUSY}} = & \sum_i (D_\mu \mathcal{S}_i)^\dagger (D^\mu \mathcal{S}_i) + \frac{i}{2} \sum_i \bar{\psi}_i \not{D} \psi_i + \sum_{\alpha, A} \left[\frac{i}{2} \bar{\lambda}_{\alpha A} (\not{D} \lambda)_{\alpha A} - \frac{1}{4} F_{\mu\nu\alpha A} F_{\alpha A}^{\mu\nu} \right] \\
& - \sqrt{2} \sum_{i, \alpha, A} \left(\mathcal{S}_i^\dagger g_\alpha t_{\alpha A} \bar{\lambda}_{\alpha A} \frac{1 - \gamma_5}{2} \psi_i + \text{h.c.} \right) \\
& - \frac{1}{2} \sum_{\alpha, A} \left[\sum_i \mathcal{S}_i^\dagger g_\alpha t_{\alpha A} \mathcal{S}_i + \xi_{\alpha A} \right]^2 - \sum_i \left| \frac{\partial \hat{f}}{\partial \hat{\mathcal{S}}_i} \right|_{\hat{\mathcal{S}}=\mathcal{S}}^2 \\
& - \frac{1}{2} \sum_{i, j} \bar{\psi}_i \left[\left(\frac{\partial^2 \hat{f}}{\partial \hat{\mathcal{S}}_i \partial \hat{\mathcal{S}}_j} \right)_{\hat{\mathcal{S}}=\mathcal{S}} \frac{1 - \gamma_5}{2} + \left(\frac{\partial^2 \hat{f}}{\partial \hat{\mathcal{S}}_i \partial \hat{\mathcal{S}}_j} \right)_{\hat{\mathcal{S}}=\mathcal{S}}^\dagger \frac{1 + \gamma_5}{2} \right] \psi_j,
\end{aligned}$$

Here, $\xi_A \neq 0$ only for $U(1)$ gauge group factors.

\hat{f} should be a gauge invariant function (and respect any other symmetries that we need to impose).

$$D_\mu \mathcal{S} = \partial_\mu \mathcal{S} + i \sum_{\alpha, A} g_\alpha t_{\alpha A} V_{\mu \alpha A} \mathcal{S},$$

$$D_\mu \psi = \partial_\mu \psi + i \sum_{\alpha, A} g_\alpha (t_{\alpha A} V_{\mu \alpha A}) \psi_L$$

$$-i \sum_{\alpha, A} g_\alpha (t_{\alpha A}^* V_{\mu \alpha A}) \psi_R,$$

$$(\not{D}\lambda)_{\alpha A} = \not{\partial}\lambda_{\alpha A} + i g_\alpha \left(t_{\alpha B}^{adj} V_{\alpha B} \right)_{AC} \lambda_{\alpha C},$$

$$F_{\mu\nu\alpha A} = \partial_\mu V_{\nu\alpha A} - \partial_\nu V_{\mu\alpha A} - g_\alpha f_{\alpha ABC} V_{\mu\alpha B} V_{\nu\alpha C}.$$

are appropriate gauge covariant derivatives.

I will not list soft SUSY breaking terms as Steve has listed these, but will only mention that if there are no gauge singlets (as is the case for the MSSM) non-analytic trilinears combinations are also soft. See Girardello and Grisaru, NPB 194 (1982) 65.

The Minimal Supersymmetric Standard Model (MSSM)

The Standard Model Menu

Field	$SU(3)_C$	$SU(2)_L$	$U(1)_Y$
$L = \begin{pmatrix} \nu_L \\ e_L \end{pmatrix}$	1	2	-1
$e_R (e_L^c)$	1	1	-2 (+2)
$Q = \begin{pmatrix} u_L \\ d_L \end{pmatrix}$	3	2	$\frac{1}{3}$
$u_R (u_L^c)$	3 (3*)	1	$\frac{4}{3} (-\frac{4}{3})$
$d_R (d_L^c)$	3 (3*)	1	$-\frac{2}{3} (\frac{2}{3})$
$\phi = \begin{pmatrix} \phi^+ \\ \phi^0 \end{pmatrix}$	1	2	1

The MSSM Menu

Field	$SU(3)_C$	$SU(2)_L$	$U(1)_Y$
$\hat{L} = \begin{pmatrix} \hat{\nu}_{eL} \\ \hat{e}_L \end{pmatrix}$	1	2	-1
\hat{E}^c	1	1	2
$\hat{Q} = \begin{pmatrix} \hat{u}_L \\ \hat{d}_L \end{pmatrix}$	3	2	$\frac{1}{3}$
\hat{U}^c	3*	1	$-\frac{4}{3}$
\hat{D}^c	3*	1	$\frac{2}{3}$
$\hat{H}_u = \begin{pmatrix} \hat{h}_u^+ \\ \hat{h}_u^0 \end{pmatrix}$	1	2	1
$\hat{H}_d = \begin{pmatrix} \hat{h}_d^- \\ \hat{h}_d^0 \end{pmatrix}$	1	2*	-1

- ★ We have written the particle content in terms of **left**-chiral superfields (could have done this for the SM also by choosing the $SU(2)_L$ singlet left-handed positron instead of the right-handed electron as the basic field, and similarly for quarks.
- ★ Two Higgs field doublet superfields with mirror Q numbers which, we will see is just what the doctor ordered for consistency. These include the Higgs bosons and their spin-half superpartners, the Majorana higgsinos with the same quantum numbers as the Higgs scalars.
- ★ The superpartners of gauge bosons, the colour octet gluinos, the $SU(2)$ -triplet winos, and the hyper-charge gaugino – the bino – are present, but not explicitly shown.

ALL THAT WE NEED IS THE SUPERPOTENTIAL AND SOFT-SUSY BREAKING TERMS AND WE WILL BE IN BUSINESS TO LOOK AT THE PHENOMENOLOGY.

The Superpotential

$$\hat{f} = \mu \hat{H}_u^a \hat{H}_{da} + \sum_{i,j=1,3} \left[(\mathbf{f}_u)_{ij} \epsilon_{ab} \hat{Q}_i^a \hat{H}_u^b \hat{U}_j^c + (\mathbf{f}_d)_{ij} \hat{Q}_i^a \hat{H}_{da} \hat{D}_j^c + (\mathbf{f}_e)_{ij} \hat{L}_i^a \hat{H}_{da} \hat{E}_j^c \right].$$

You can check that this is invariant under 3-2-1 gauge transformations.

\hat{H}_u / \hat{H}_d gives masses to up/down type fermions via their Yukawa coupling matrices, exactly as in the SM.

Why do we need two doublets when one was enough in the SM?

In the SM, we used the doublet ϕ and its “mirror” ϕ^* . But an important dictate of SUSY is that we cannot have a SF and its conjugate in the superpotential. Hence, the proliferation of Higgs multiplets.

★ With one Higgs doublet, the spin-half higgsinos would cause the theory to be anomalous. With two doublets the anomaly cancels!!!

A re-cap of the MSSM particle content

spin- $\frac{1}{2}$ $(\nu_L, e_L); e_R$

spin- $\frac{1}{2}$ $(u_L, d_L); d_R$

spin-1 (g, γ, W^\pm, Z)

spin-0 Higgs bosons $(H_u^+, H_u^0), (H_d^-, H_d^0)$

Physical particles (h^0, H^0, A^0, H^\pm)

spin-0 $(\tilde{\nu}_L, \tilde{e}_L); \tilde{e}_R \times$ generations

spin-0 $(\tilde{u}_L, \tilde{d}_L); \tilde{d}_R \times$ generations

spin- $\frac{1}{2}$ $(\tilde{g}, \tilde{\gamma}, \tilde{W}^\pm, \tilde{Z})$

spin- $\frac{1}{2}$ higgsinos $(\tilde{H}_u^+, \tilde{H}_u^0), (\tilde{H}_d^-, \tilde{H}_d^0)$

The spin $\frac{1}{2}$ $\tilde{\gamma}, \tilde{Z}, \tilde{H}_u^0, \tilde{H}_d^0$ mix to form neutral Majorana neutralinos $\tilde{Z}_1, \tilde{Z}_2, \tilde{Z}_3, \tilde{Z}_4$.

Similarly, there are two Dirac spin- $\frac{1}{2}$ charginos, \tilde{W}_1, \tilde{W}_2 .

INVENTION OF NEW PARTICLES TO COMPLETE SYMMETRY

MULTIPLETS HAS WELL-KNOWN PRECEDENTS (Positron, Ω^-)

The model that we have described, augmented by soft SUSY breaking terms, is called the Minimal Supersymmetric Standard Model

- ★ Scalar mass matrices
- ★ Gaugino masses
- ★ Trilinear and Bilinear scalar couplings $a_{ijk}\phi_i\phi_j\phi_k$, $b_{ij}\phi_i\phi_j$ 124 parameters.
- ★ Trilinear couplings $c_{ijk}\phi_i^\dagger\phi_j\phi_k$ also allowed if there are no gauge singlets 178 parameters!

Notice these are all dimensionful parameters as we mentioned before.

No SUSY-breaking dimensionless couplings – measuring equality (up to radiative corrections) of couplings of superpartners and SM particles is a direct test of SUSY.

Steve told you that we could have included,

$$\hat{f} = \sum_{i,j,k} \left[\lambda_{ijk} \epsilon_{ab} \hat{L}_i^a \hat{L}_j^b \hat{E}_k^c + \lambda'_{ijk} \epsilon_{ab} \hat{L}_i^a \hat{Q}_j^b \hat{D}_k^c \right] + \sum_i \mu'_i \epsilon_{ab} \hat{L}_i^a \hat{H}_u^b + \sum_{i,j,k} \lambda''_{ijk} \hat{U}_i^c \hat{D}_j^c \hat{D}_k^c$$

Gauge-invariant, renormalizable – so we have no excuse.

λ , λ' and μ' violate lepton number conservation;^a λ'' violates baryon number conservation.

SUSY \implies These will not be generated radiatively if these are absent to start with.

BUT THAT WE CAN WRITE SUCH COUPLINGS IS A STEP BACK FROM THE SM IN WHICH THE CONSERVATION OF B AND L IS AUTOMATIC FOR RENORMALIZABLE OPERATORS.

I will assume R -parity is conserved for most of these lectures.

^aCan rotate μ' term away from the superpotential but not simultaneously the corresponding term in the SSB sector.

Implications of R -parity conservation

- ★ Ensures proton stability from disastrous weak rate decays. (Exercise)
- ★ Non-observable $n-\bar{n}$ oscillations
- ★ Forbids mixing between leptons and charginos/neutralinos.
- ★ Superpartners can only be produced in pairs at accelerators that collide only SM particles.
- ★ Superparticles cannot decay into only ordinary particles \implies Lightest Supersymmetric Particle (LSP) must be stable.
- ★ Decays of superparticles terminates in the LSP.

Stable LSPs would have been in thermal equilibrium with everything else early in the history of the Universe

Freeze out of thermal equilibrium at $T \sim M_{LSP}/20$.

Can compute their abundance now – stringent constraints.

If LSP is electrically charged or coloured, we expect it will bind with ordinary particles to make exotic isotopes. For $M_{LSP} \lesssim \mathcal{O}(\text{TeV})$, expected abundance of heavy atoms/nuclei $\sim \mathcal{O}(10^{-10} - 10^{-6})$.

Empirical limits on heavy anomalous, heavy isotopes range from $10^{-12} - 10^{-28}$ (B, F, O, C, D, H, Fe) Lighter charged LSP's excluded by accelerator searches.

LSP generally believed to be neutral.

Measured CDM density imposes stringent constraints on thermally produced LSPs assuming standard Big Bang cosmology.....Graciela's lectures

Within the MSSM LSP candidates are $\tilde{\nu}$, \tilde{Z}_1 .

If we assume that the LSP makes up our galactic DM halo, the active $\tilde{\nu}$ is strongly disfavoured because it has “heavy neutrino-like” cross sections for scattering off nuclei and would have been detected unless its mass $\gtrsim 2$ TeV (can evade if clever.)

Neutralino is a viable DM candidate as you have heard already.

In local SUSY, the gravitino may also be a credible candidate, and in extended models, yet other objects: $\tilde{\nu}_R$, axinos.

Absolutely no reason for all the observed dark matter to consist of just one type of particle though many authors focus upon this simplest possibility.

No time to talk about this here, but I imagine there will be talks about these possibilities at SUSY 2019.

Since sparticle decays always terminate in the LSP, every SUSY event has 2 LSPs in it.

If the LSP has no strong or EM interactions, it will be like a neutrino and escape detection in the experimental apparatus.

At colliders, this will manifest itself as apparent momentum/energy imbalance..
(Steve, KC)

At hadron colliders, really in the transverse plane only as the longitudinal momentum of the initial state is not known.

E_T^{miss} events are quite generic in R -parity conserving SUSY models.

We saw that an agnostic parametrization of the MSSM had 124/178 free parameters.

Looks bad, but don't be surprised. Most of these are in the SUSY breaking sector.

Weak interactions before universal $V - A$!

Understanding that weak interactions came from a symmetry principle, AND understanding how this symmetry is "broken" led to a manageable theory.

If we discover SUSY and understand SUSY breaking, we will also get a manageable theory.

Re-emphasize that viable R -parity violating models are possible.

Why might R -parity be conserved?

We mention in passing that R -parity is automatically conserved in models where $B - L$ is a gauge symmetry charge (*e.g.* in $SO(10)$ models) broken only by *vevs* of scalars with even integer values for the $3(B - L)$ charge.

HOW DO WE DEAL WITH SO MANY PARAMETERS?

With 178 parameters, normal people's brain becomes full! What do we do?

Seek guidance from phenomenology. Two issues arise

Many scalars \implies FCNC

$\bar{q}_0 \Gamma \tilde{g} \tilde{q}_0$ "Current basis"

$$q = U q_0; \tilde{q} = \tilde{U} \tilde{q}_0$$

The gluino interaction becomes $\bar{q} U^\dagger \Gamma \tilde{g} \tilde{U} \tilde{q}$.

Problem: $U^\dagger \tilde{U} \neq I \implies$ FCNC such as $b \rightarrow s \gamma$ via squark-gluino loops.

What can we do to evade this?

- ★ Make sparticles heavy. Decoupling
- ★ Make sparticles with same Q Nos. degenerate (rotation of Unit matrix leaves it invariant). Universality
- ★ Make $U^\dagger \tilde{U} = I$, either dynamically or by crook. Alignment

In the 1980's people tried to make models with **global** SUSY, with SUSY broken at the weak scale.

Tree level sum rules

$$\sum_{\text{bosons}} (2j + 1) M_j^2 = \sum_{\text{fermions}} (2j + 1) M_j^2 \text{ in each charged sector}$$

Charge $-1/3$ squark lighter than m_b !!!!

No time to discuss details but the sum rules are evaded in today's models by

- ★ Local SUSY (supergravity based models) (mSUGRA model)
- ★ Arranging to give masses at loop level only (e.g. Gauge-mediated SUSY breaking – GMSB model)

In GMSB, scalars with the same Q Nos automatically get the same mass so FCNC advertized to be in control. But some other technical assumptions also needed.

This is not automatic in supergravity-based models, and we have to make technical assumptions on so-called Kähler potential (this is the historical reason for the “m” of mSUGRA). (Sorry, no time to talk about this here. Soni and Weldon, PL 126B (1983) 215.)

An Extreme Ansatz Universality

- ★ Universal scalar mass m_0
- ★ Universal scalar trilinear coupling A_0
- ★ Bilinear scalar higgs mixing parameter b_0
- ★ Universal gaugino mass $m_{1/2}$
- ★ Superpotential Higgsino mass μ .

Flavour physics automatically OK

Pattern realized in the minimal supergravity GUT model (mSUGRA GUT).

Universal scalar mass arises because of a technical assumption about the Kähler potential.

GUT assumption implies one gauge coupling and one gaugino mass at $Q = M_{\text{GUT}}$ (if SUSY breaking does not break GUT symmetry).

Renormalization gives $\frac{M_1}{\alpha_1} = \frac{M_2}{\alpha_2} = \frac{M_3}{\alpha_3}$ at $Q = M_{\text{Weak}}$.

Objection: How can we get correct EWSB which requires $m_H^2 < 0$ and $m_{\text{other}}^2 > 0$ with universal mass parameters?

We should think of the universal Lagrangian parameters as those of an effective theory renormalized at a very high scale (usually taken to be $M_{\text{GUT}} - M_{\text{Planck}}$).

These are then “evolved” using renormalization group techniques to near the weak scale giving rise to splitting of the degeneracies in the spectrum, in exactly the same way that RG running splits the gauge couplings in a GUT.

- Gauge couplings INCREASE scalar masses as we run from high scale to low scale.
- Yukawa couplings do just the opposite.

$m_{\tilde{q}} \geq m_{\tilde{\ell}_L} \geq m_{\tilde{\ell}_R}$ as long as Yukawa couplings are negligible.

Effect of Yukawa couplings

Focus on top quark Yukawa coupling

Effect on \tilde{t}_L mass squared = 1 unit

Effect on \tilde{t}_R mass squared = 2 units (doublets in loop)

Yukawa coupling effects reduce the mass, so

$$m_{\tilde{t}_R}^2 < m_{\tilde{t}_L}^2.$$

Effect on $m_{H_u}^2 = 3$ units (colour triplet in loop)

The Higgs mass parameter did not go up as much because Higgs fellows do not feel strong interactions, and then is pushed down the most by Yukawa interactions! We can thus have $m_{H_u}^2 < 0$

RADIATIVE EWSB

Yukawa couplings also “mix” \tilde{t}_L and \tilde{t}_R because EW symmetry is broken.

Since mixing always reduces the mass of the lighter state, \tilde{t}_1 (and possibly \tilde{b}_1) may be much lighter than other squarks. Watch that $m_{\tilde{t}_1}^2 > 0$.

Here $m = \text{sign}(m^2) \cdot \sqrt{|m^2|}$.

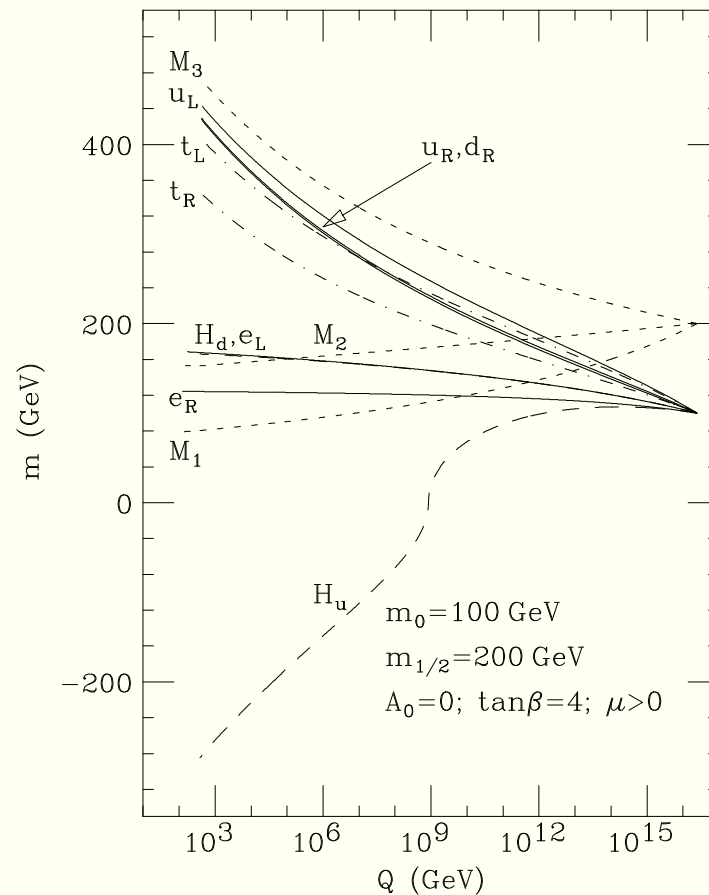

Notice the hierarchy $m_{\tilde{u}_L} \simeq m_{\tilde{u}_R} > m_{\tilde{t}_L} > m_{\tilde{t}_R}$.

Also how $m_{H_u}^2$ becomes negative.

“Excluded masses” but $m_{H_u}^2$ typically as negative as scalars are positive.

How do MSSM superpartner masses arise?

We do not have time to discuss how the model that we have described arises from supergravity, nor do we have time to discuss in detail other models of sparticle masses that have been considered in the literature.

Emphasize that we are forced to resort to models because it is hard to think with 178 parameters.

Based on untested assumptions about high scale physics.

However, these assumptions will be testable if sparticles are discovered and their properties determined.

MODELS ARE CHARACTERIZED BY THE MECHANISM FOR THE MEDIATION OF SUSY BREAKING (between the SUSY breaking and MSSM sectors). We don't have time to detail that part of the story.

★ Sparticle spectrum characteristic of the mediation mechanism.

I have mentioned the problems of global SUSY models with SUSY broken at the weak scale.

Most models today have:

- ★ The SM sector + superpartners (MSSM or its TeV scale extensions)
- ★ The SUSY-breaking sector – SUSY broken at scale M_{SUSY} . (F - or D - type breaking, condensates....)
- ★ A sector that connects the two – the “mediator” of SUSY breaking effects.....mediator scale M_X .

Since SUSY breaking effects are suppressed when $M_X \rightarrow \infty$, the effective SUSY breaking scale that SM superpartners feel typically is $\sim M_{\text{SUSY}}^2/M_X$. Polchinski and Susskind, PRD 26 (1982) 3661

Gravity mediation $\implies M_X = M_{\text{Planck}}$

Gauge mediation $\implies M_X = M_{\text{Mess}}$

Other possibilities in the literature.

Models

- ★ **Gravity-mediated SUSY breaking.** Always present because gravity exists. Problem with flavour needs a technical assumption about Kähler potential. mSUGRA model **UNIVERSAL SSB** parameters at $Q = M_{\text{GUT}}$ (Ambiguity what the high scale should be.)

$$m_0, m_{1/2}, A_0, b_0, \mu$$

$b_0 \leftrightarrow \tan \beta, \mu^2 \leftrightarrow M_Z^2$ (via minimizing the Higgs potential).

$$\frac{M_Z^2}{2} = \frac{(m_{H_d}^2 + \Sigma_d^d) - (m_{H_u}^2 + \Sigma_u^u) \tan^2 \beta}{\tan^2 \beta - 1} - \mu^2, \text{ (Weak scale relation)}$$

(Σ_u^u, Σ_d^d are finite radiative corrections.)

$m_0, m_{1/2}, A_0, \tan \beta, \text{sign}(\mu)$ (mSUGRA)

$$m_{\tilde{G}} \sim m_{\text{susy}}.$$

Variants of mSUGRA

There are good reasons to consider broader class of models with split masses for Higgs and matter scalars, and possibly also, independent third generation scalar mass $m_0(3)$. (Non Universal Higgs mass, NUHM models)

$m_0, m_{1/2}, A_0, \tan \beta, \text{sign}(\mu), m_{H_u}, m_{H_d}$ (NUHM2)

$m_0, m_0(3), m_{1/2}, A_0, \tan \beta, \text{sign}(\mu), m_{H_u}, m_{H_d}$ (NUHM3)

Typical LSP is the lightest neutralino.

★ Gauge-mediated SUSY breaking. GMSB model

The messengers have SM gauge quantum numbers, so communicate with MSSM sector via $SU(3) \times SU(2) \times U(1)$ interactions.

$m_i \propto g_i^2 \implies$ Coloured sparticles heaviest, sparticles with just hypercharge interactions lightest. GRAVITINO MAY BE THE LSP IF $M \ll M_P$.

Phenomenology and cosmology may be very different.

$$\Lambda, M, n_5, \text{sign}(\mu), C_{\text{grav}}$$

Λ sets the scale of MSSM superpartner masses; C_{grav} sets the scale of gravitino mass.

Clearly different pattern of superpartner masses, but same pattern of gaugino masses as mSUGRA.

$m_h = 125$ GeV possible only for very heavy sfermion masses.

Broader parameter space of “General gauge mediation”.

★ Anomaly-mediated SUSY breaking

Emphasize that these contributions are always there, but being loop effects, are usually suppressed. But important if the dominant contributions are strongly suppressed.

Problem with slepton mass squared.

mAMSB model $m_i \propto \beta_i \implies$ neutral wino LSP. Tiny mass gap with chargino.

$$m_0, m_{\tilde{G}}, \tan \beta, \text{sign}(\mu)$$

Other variants of this also possible.

Renormalization effects give characteristic mass patterns that can be tested if the mass spectrum is accessible.

★ Interesting combinations of mediators can lead to intricate phenomenological patterns.

An interest example is the mixed gravity and anomaly mediation

Depending on the ratio of the two contributions, the gaugino mass pattern quite different from other scenarios.

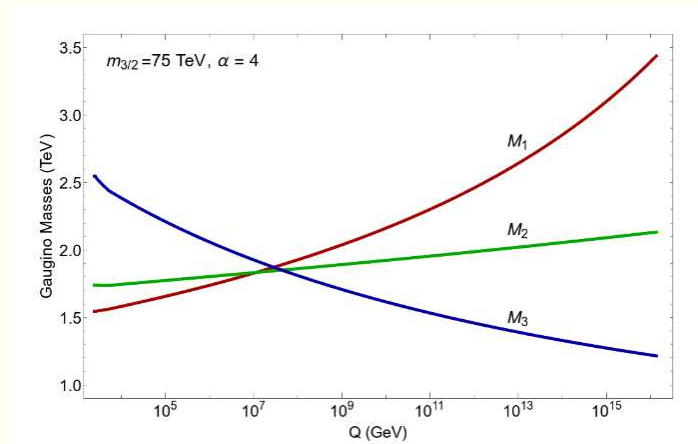

(Michael)

There is no dynamical scale where the gaugino mass parameters apparently unify.

Mirage Unification

If the mirage unification scale is small, the spectrum will be very compressed.

This pattern arises in some string-motivated models of particle physics, in particular, the mini-landscape picture being championed by Nilles and collaborators.

Despite the imagination that went into their construction, probably none of these models is right. We really need guidance from experiment to really arrive at the right scheme.

We construct the schemes to see the diversity of mass sparticle patterns that can result, and also the diversity of the LSP. Much collider phenomenology as well as DM expectations depend on this.

We should only use these models to guide our thinking of how to hunt for supersymmetry, and variety of possible signatures.

Collider Signatures

To understand collider signatures, we have to know **sparticle production mechanisms** and **sparticle decay patterns**.

These are computable from the MSSM Lagrangian.

We have to identify **sparticle production mechanisms**, evaluate the corresponding cross sections, and then compute decay rates to get the corresponding branching ratios to SM objects.

Many calculations, technically complicated but conceptually straightforward.

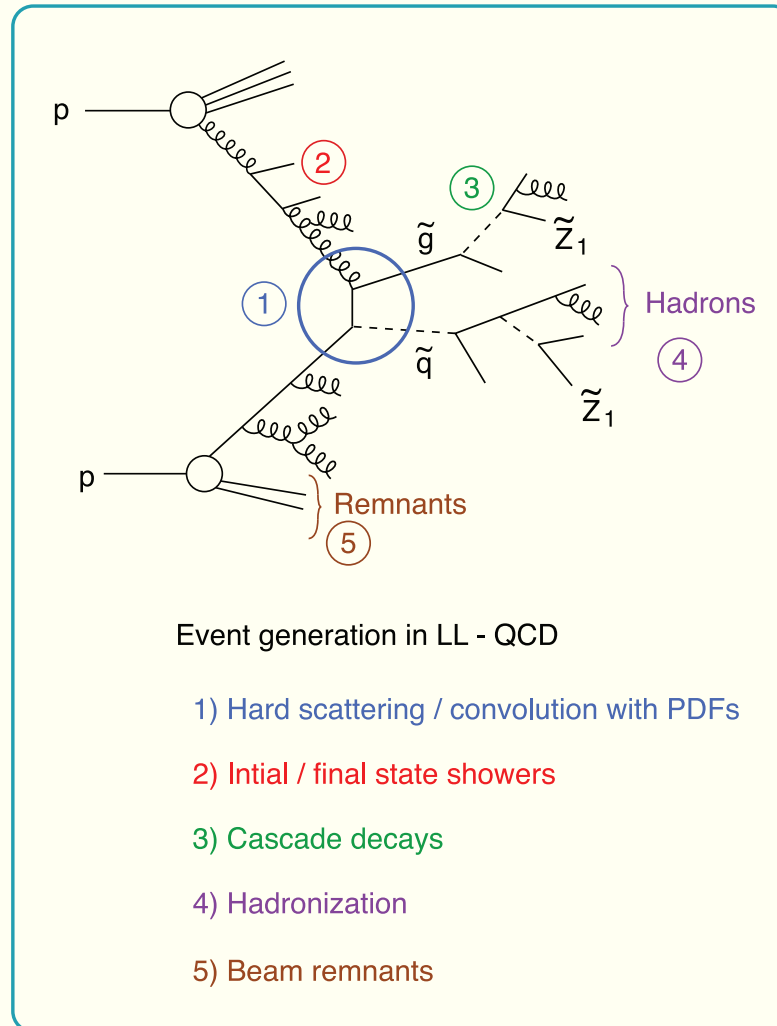

The SUSY theory describes just the hard scattering, which is all we'll talk about.

The rest is left to the KC's lectures

SPARTICLE PRODUCTION AT THE LHC

- ★ Superpartners pair-produced because of R -parity conservation.
- ★ Production mainly by gauge interactions [model indep. couplings]
- ★ Squarks and gluinos, most copiously produced if these are not too heavy.
- ★ In many models that we know, coloured particles tend to be heavier than their colourless cousins; kinematics would tend to equalize strong and weak production mechanisms.
- ★ If all squarks are very heavy, then chargino and neutralino production may dominate gluino production.

Gluino pair prod

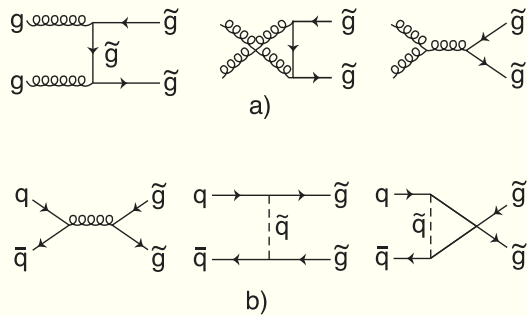

$\tilde{q}\bar{\tilde{q}}$ prod

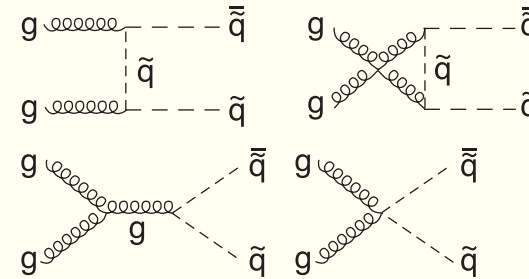

Gluino-Squark Prod

$\tilde{q}\tilde{q}$ production

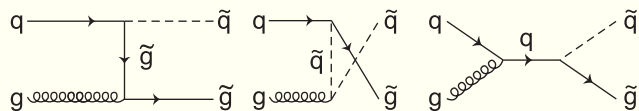
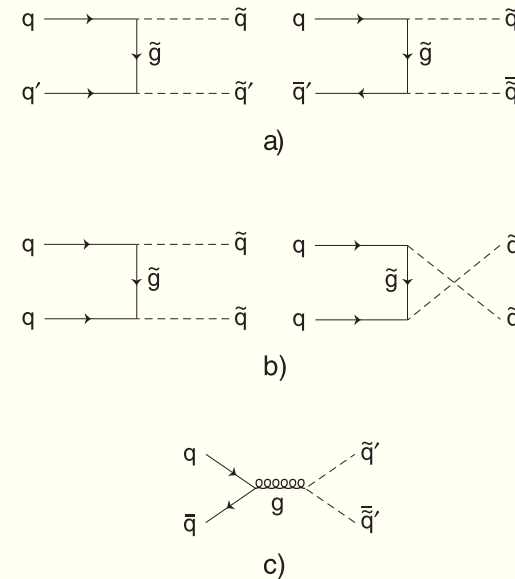

In the absence of $\tilde{q}_L - \tilde{q}_R$ mixing, vertices all fixed by $SU(3)_C$ symmetry.

Cross sections fixed by $m_{\tilde{q}}$ and $m_{\tilde{g}}$ independent of any model. First generation squarks favoured if $m_{\tilde{q}} \sim m_{\tilde{g}}$.

CHARGINOS AND NEUTRALINOS

Combinations of gauginos and higgsinos that mix upon EWSB

$$\mathcal{M}_{\text{neutral}} = \begin{pmatrix} 0 & \mu & -\frac{gv_u}{\sqrt{2}} & \frac{g'v_u}{\sqrt{2}} \\ \mu & 0 & \frac{gv_d}{\sqrt{2}} & -\frac{g'v_d}{\sqrt{2}} \\ -\frac{gv_u}{\sqrt{2}} & \frac{gv_d}{\sqrt{2}} & M_2 & 0 \\ \frac{g'v_u}{\sqrt{2}} & -\frac{g'v_d}{\sqrt{2}} & 0 & M_1 \end{pmatrix}$$

4 Majorana neutralinos that are combinations of $\tilde{h}_u^0, \tilde{h}_d^0, \widetilde{W}_3, \tilde{B}$

$$\mathcal{M}_{\text{charge}} = \begin{pmatrix} M_2 & -gv_d \\ -gv_u & -\mu \end{pmatrix} \text{ 2 Dirac charginos that are comb. of } \widetilde{W}^\pm, \tilde{h}^\pm$$

If $M_1, M_2 \gg |\mu|$, $\tilde{Z}_3 \sim \tilde{B}$, $\tilde{Z}_4 \sim \widetilde{W}$, $\widetilde{W}_1, \tilde{Z}_{1,2} \sim$ higgsino-like. (easy to arrange in NUHM models)

If $M_1, M_2 \ll |\mu|$, $\tilde{Z}_1 \sim \tilde{B}$, $\tilde{Z}_2 \sim \widetilde{W}$, $\widetilde{W}_1 \sim \widetilde{W}^-$; $\widetilde{W}_2, \tilde{Z}_{3,4} \sim$ higgsino-like.

CHARGINO AND NEUTRALINO PRODUCTION

Chargino Pair Prod

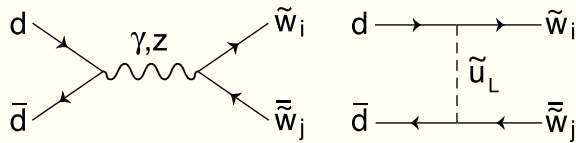

Chargino-Neutralino Prod

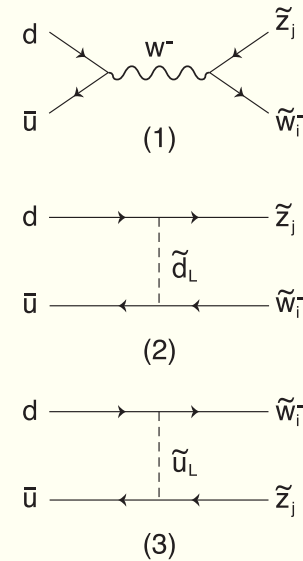

Neutralino Pair Prod

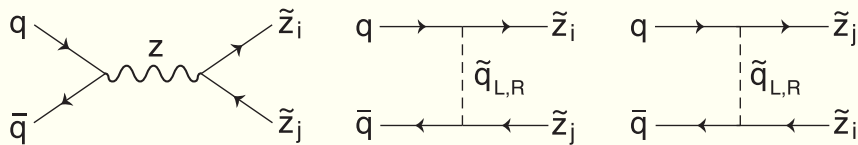

Produced by electroweak interactions, so smaller rates.

Except to the photon, the couplings of \tilde{W}_i and \tilde{Z}_j depend on model-dependent mixing angles. Cross sections are generally model-dependent

- ★ We will skip slepton pair production which occurs by Drell-Yan-like processes. Model-independent rates to the extent that slepton mixing is negligible (proportional to lepton-Yukawa coupling in many models).
- ★ I will also skip discussion of squark/gluino + chargino/neutralino associated production.
- ★ Naively expect strong interaction processes to have largest cross sections, followed by strong-weak associated processes, followed by EW processes.

MASS PATTERNS CAN UPSET THIS PREDICTION.

Prediction also upset by the finite energy of LHC and bounds that have already been set.

Production Rates at the LHC

Gaugino mass unification is assumed, $|\mu| \gg M_{1,2}$, and scales with M_{SUSY}

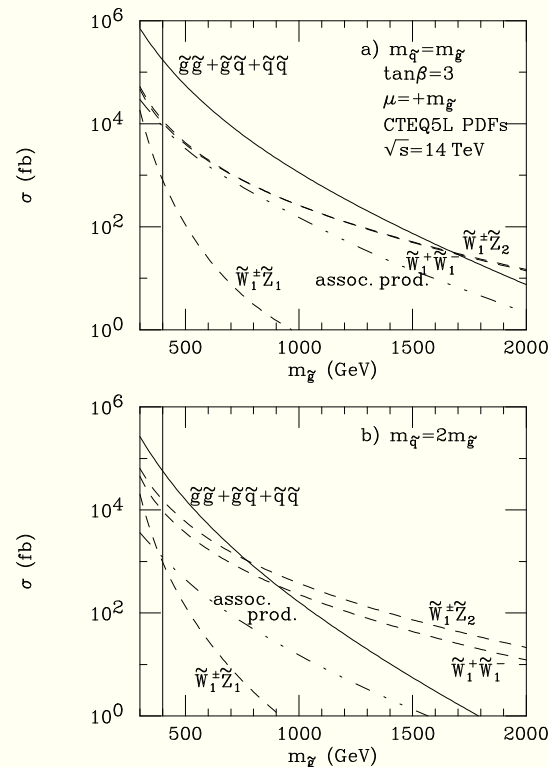

$$\sqrt{s} = 14 \text{ TeV}$$

Associated production never dominates.

If $m_{\tilde{q}} \sim m_{\tilde{g}}$ strong processes dominate to $m_{\tilde{g}} \sim 1.8$ TeV.

If squarks are heavy, strong processes dominate to $m_{\tilde{g}} \sim 0.9$ TeV.

Light higgsinos, very heavy squarks

Gaugino mass unification is still assumed, $|\mu| = 150$ GeV

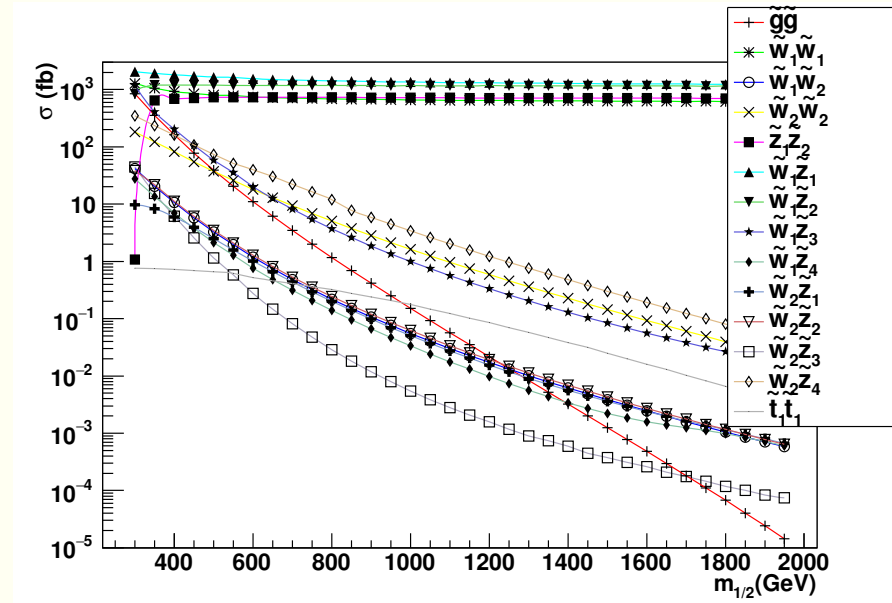
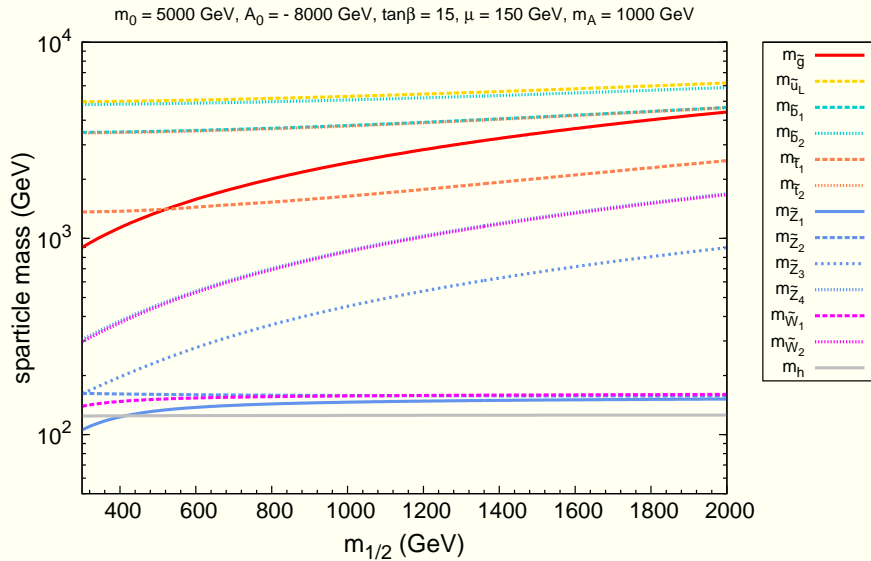

$$\sqrt{s} = 14 \text{ TeV}$$

Huge higgsino production rate, but higgsinos nearly degenerate.

EW wino rate dominates gluino rate

Squarks too heavy, stop possible?

Sparticle Decays (Naive summary)

For specificity, I will assume $M_1 \sim \frac{1}{2}M_2 \sim \frac{1}{6}M_3$ (gaugino mass unification) and large $|\mu|$

Squarks: $\tilde{q}_{L,R} \rightarrow q\tilde{g}$ if allowed (often the case).

Else, $\tilde{q}_L \rightarrow q\tilde{W}_i, q\tilde{Z}_j$; $\tilde{q}_R \rightarrow q\tilde{Z}_j$.

$\tilde{q}_L \rightarrow$ ino with highest $SU(2)_L$ content; $\tilde{q}_R \rightarrow$ bino-like \tilde{Z}_j .

$(\tilde{W}_1, \tilde{Z}_2$ if $|\mu| \gg M_2 > M_1$) $(\tilde{Z}_1$ if $M_2 > M_1$) (flip for small $|\mu|$)

Gluginos: $\tilde{g} \rightarrow \bar{q}\tilde{q}^{(*)} \rightarrow \bar{q}q\tilde{Z}_j, \bar{q}q\tilde{W}_i$.

Preference to inos with highest $SU(2)$ gaugino content. Sleptons:

$\tilde{l}_L \rightarrow \ell\tilde{Z}_j, \nu\tilde{W}_i$; $\tilde{l}_R \rightarrow \ell\tilde{Z}_j$; $\tilde{\nu} \rightarrow \nu\tilde{Z}_j, \ell\tilde{W}_i$. Sneutrinos may decay visibly!

Sparticle Decays (Complication)

Yukawa coupling effects are important for top (s)quarks and may be relevant for larger values of $\tan \beta$ even for bottom (s)quarks.

$f_d \propto \frac{1}{\cos \beta} \implies$ down type Yukawa increases with $\tan \beta$.

- ★ \tilde{t}_1 mass comes down.
- ★ \tilde{b}_1 mass comes down.
- ★ Higgsino effects become important.

Glino decays to third generation favoured. SUSY events may be rich in tagged b -jets which will help separate the SUSY signal from SM background.

$\widetilde{W}_i \rightarrow f \widetilde{f}_L, \widetilde{Z}_i W, \widetilde{Z}_i H^-$ (if kinematically allowed) Also, $\widetilde{W}_2 \rightarrow \widetilde{W}_1 + h^0$ or Z^0 .
 $\widetilde{W}_i \rightarrow \ell \nu \widetilde{Z}_1, q \bar{q} \widetilde{Z}_1$ (frequently with BFs of W decays).
 $\widetilde{Z}_j \rightarrow \widetilde{Z}_i \phi^0, \widetilde{Z}_i Z, \widetilde{W}_i W, f \widetilde{f}$ (if kinematically allowed)
 $\widetilde{Z}_2 \rightarrow f \bar{f} \widetilde{Z}_1$ (BF's very parameter-dependent)

HEAVY SQUARKS AND SLEPTONS AND GLUINOS, AS A RULE, CASCADE DECAY TO LIGHTER SUPERPARTNERS.

Despite this, many LHC analyses done assuming direct decays to the LSP.

TYPICAL LIFETIMES

$$\Gamma(2\text{body}) \sim \frac{\alpha}{(\quad)} M$$

$$\Gamma(3\text{body}) \sim \frac{\alpha^2}{(\quad)} \frac{1}{M_{\text{heavy}}^4} M^5$$

$\tau(2\text{body}) < 10^{-23}$ s for each channel.

$\tau(3\text{body}) < 10^{-18}$ s for each channel.

Sparticles typically decay “promptly” except under special circumstances; *e.g.* no displaced vertices or visible tracks of particles.

We can only see final decay products.

EXCEPTIONS DO HAPPEN....NO TIME TO DISCUSS NOW.

Escaping LSPs means no mass bumps; but clever tricks help for kinematic reconstruction, as KC has described.

We saw that we can use the SUSY Lagrangian to describe production of superparticles, and their subsequent decays into SM final states of quarks, leptons and gluons and photons.

This is often done using event generator programs.

The quarks and gluons fragment and hadronize to jets, which along with leptons and photons, are the “experimentally reconstructable” objects for our experimental colleagues.) This aspect has nothing to do with supersymmetry.

Why do we need Event Generator Programs?

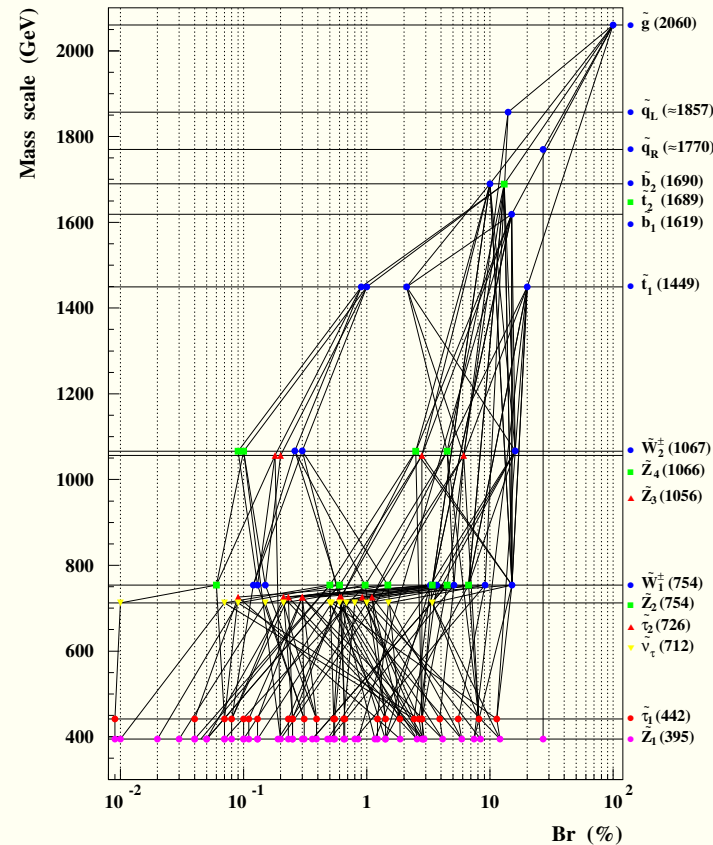

\tilde{Z}_1 qq	(27.0 %)	\tilde{Z}_1 $\tau\nu WWbb$	(4.1 %)
\tilde{Z}_1 $\tau\nu Wbb$	(12.1 %)	\tilde{Z}_1 $\tau\tau bb$	(2.9 %)
\tilde{Z}_1 $\tau\tau WWbb$	(8.4 %)	\tilde{Z}_1 $\tau\tau qq$	(2.9 %)
\tilde{Z}_1 WWbb	(7.4 %)	\tilde{Z}_1 $\tau\nu ZWbb$	(2.8 %)
\tilde{Z}_1 $\tau\nu qq$	(5.9 %)	\tilde{Z}_1 $\tau\nu hWbb$	(2.6 %)

Only main decay modes of gluino alone are shown. Also $\sim 10^3$ production subprocesses! **HARD TO DO BY HAND.**

Up to now, I implicitly assumed that the lightest neutralino was the LSP.

What if the gravitino is the LSP?

No difference to collider signals if $m_{\tilde{G}} \sim M_{\text{Weak}}$. In this case it couples so weakly that cascade decays occur as usual, and then \tilde{Z}_1 decays way outside the detector.

Disfavoured by the relic density and BBN considerations.

I won't discuss the case that some charged sparticle is the next-lightest-super-partner (NLSP). Extra track of an ionizing, slow-moving particle.

Superlight gravitinos can make a difference!

Remember, $m_{\tilde{G}} \sim M_{\text{SUSY Brk}}^2 / M_{\text{Pl}}$, so gravitino may be light if the SUSY breaking scale is small. Gauge-mediated SUSY breaking models have this feature.

WHY DOES A LIGHT GRAVITINO MAKE A DIFFERENCE?

The dimensionless coupling for a decay $\tilde{P} \rightarrow P\tilde{G}$ is $\sim E/M_{\text{Pl}}$.

The gravitino gets a mass upon SUSY breaking, and develops longitudinal components by absorbing the Goldstino, in the same way that W -bosons develop longitudinal components after eating the Goldstone bosons.

Dimensionless coupling for this longitudinal component is $\frac{E}{M_{\text{Pl}}} \times \frac{E}{m_{\tilde{G}}}$.

For $E \sim 100$ GeV, this is $\sim 10^{-6} \left(\frac{1 \text{ eV}}{m_{\tilde{G}}} \right)$, or

$$\tau(100 \text{ GeV}) \sim 10^{-12} \text{ s} \times \left(\frac{m_{\tilde{G}}}{\text{eV}} \right)^2.$$

This time scale is relevant to colliders.

Searching for SUSY

INDIRECT SEARCHES

★ Precision Measurements.

Loop effects: e.g. $g_\mu - 2$. Need good control on SM prediction. Good measurements of R in the e^+e^- resonance regions.

Flavour violation: $\mathcal{O}(1)$ effects, but SUSY contribution exquisitely sensitive to details of the model.

In my opinion, these are tests of a model and not generic.

$B \rightarrow X_s \gamma$, $X_s \ell^+ \ell^-$, $B_s \rightarrow \mu^+ \mu^-$, $B^+ \rightarrow \tau \nu$

CP violation from complex SSB parameters. Electric dipole moments.

★ SUSY from the sky

Relic density of dark matter measured to within a few percent. Stringent constraint on ANY particle physics model with a stable neutral weakly interacting particle, assuming thermal production in standard Big Bang Cosmology. But we can make up new stories.

Insisting on saturating the relic density seems to me as overkill.

Indirect searches for DM

CDM+CDM \rightarrow stuff High energy ν (IceCube); antiparticles (PAMELA, AMS); anti-nuclei (GAPS, AMS), gamma rays (Fermi LAT).

Uncertainties in the size of the expected signal as well as expected backgrounds (suggestion of positrons as secondaries).

Direct searches for galactic DM

CDM + nucleus \rightarrow CDM + recoiling nucleus (DAMA/LIBRA, XENON, CDMS, LUX, CRESST, COUPP, PANDA-X, PICO.....

I will not talk about this here (Graciela)

What do we expect at colliders?

★ Electron-Positron Colliders LEP, LEP2

Democratic production of all particles that couple to photon or Z with a cross section comparable to that for $\mu^+ \mu^-$ production (aside from spin, colour and $SU(2)$ Clebsch factors).

Since the sparticles decay promptly into visible SM stuff (leptons, jets, photons) plus pair of undetected neutralinos) the signals are kinematically very distinctive. “Physics backgrounds” just from neutrino processes.

Non-observation of an excess of such events above SM expectations implies lower limits on sparticle masses close to the LEP2 beam energy.

$m_{\tilde{e}} \gtrsim 100$ GeV, $m_{\tilde{\mu}} \gtrsim 90$ GeV, $m_{\tilde{W}_1} \gtrsim 103$ GeV, with similar limits ($\sim 80 - 90$ GeV) on other charged sparticles. Fairly model-independent.

Neutralino limits are an exception. Neutralino production cross section vanishes if the neutralino is a pure gaugino AND $m_{\tilde{e}} \rightarrow \infty$! LIMITS ARE MODEL-DEPENDENT, AND A LIGHT NEUTRALINO may be allowed. Significant limits in any model with gaugino-mass unification.

Z-line shape and “neutrino counting” experiment.

Hadron Colliders

Glueballs and squarks most copiously produced if these are kinematically accessible. Initial focus was on these signals.

Glueball production is very large (colour octet Clebsch). Generally cascade decay to LSP; often with third generation quark jets.

Multi-jet + E_T^{miss} signal; multi-jet + multi-lepton + E_T^{miss} signal suppressed by leptonic BF

Potential for distinctive SS dileptons and trilepton signals that have very small SM physics backgrounds. Though these leptonic signals have small rates, these can be competitive for large integrated luminosities.

For light squarks, dijet + E_T^{miss} signals from \tilde{q}_R -pair production; cascade decays from \tilde{q}_L production.

Heavy squarks decay to glueballs; heavy glueballs decay to squarks.

- ★ Expect that multi-jet plus multi-lepton plus E_T^{miss} signals will be the rule at the LHC.

Consequence of $SU(2) \times U(1)$ and gaugino mass unification pattern.

- ★ If first/second generation squarks are heavy compared to stops and sbottoms (as might well be the case) expect t - and b -jets as well as W , Z and h bosons in SUSY cascade decays.

ISN'T ALL THIS MODEL-DEPENDENT?

- ★ Yes, the relative rates into various channels do depend on model-dependent leptonic BFs of charginos and neutralinos. However, the model-dependence shuffles events between various channels characterized by the lepton multiplicity and type.
- ★ Multijet + 1, 2 (SS or OS), 3, 4,...leptons + possibly photons + E_T^{miss} events.
- ★ Could also be gluinos decay mainly to third generation.
- ★ Since the signal in each channel is observable with sufficient integrated luminosity the reach, when expressed in terms of $m_{\tilde{g}}$ and $m_{\tilde{q}}$, is not so sensitive to the details of the model. We will discuss notable exceptions later.
RELATIVE RATES BETWEEN TOPOLOGIES SHOULD PROVIDE INFORMATION ABOUT THE UNDERLYING MODEL.

Run 1 LHC results: an example

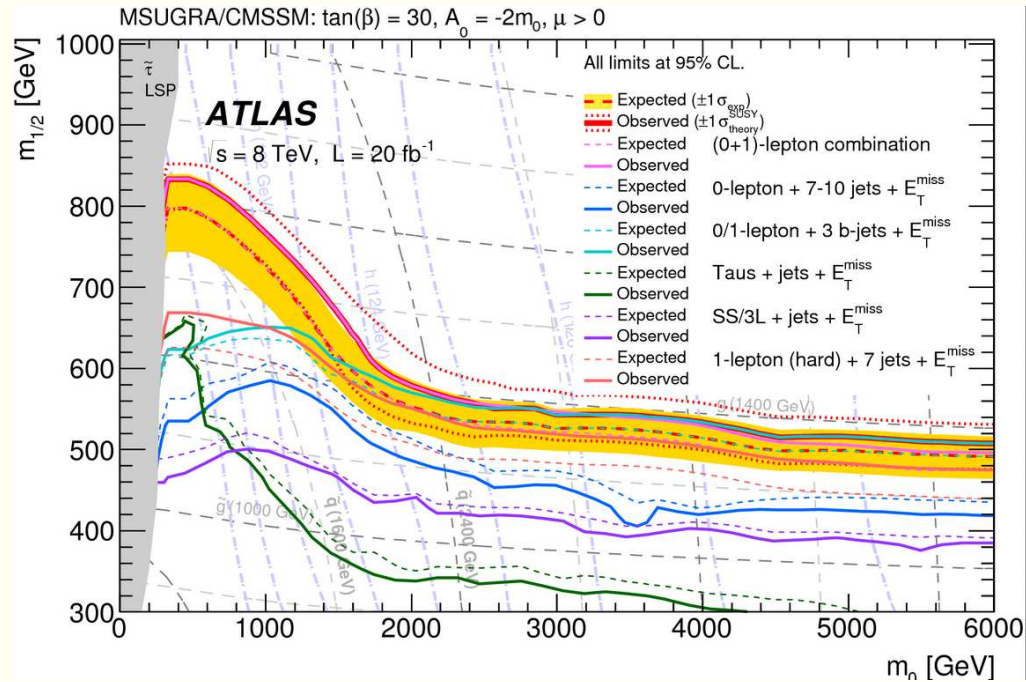

$m_{\tilde{g}} > 1800 \text{ GeV}$ if $m_{\tilde{q}} = m_{\tilde{g}}$; $m_{\tilde{g}} > 1300 \text{ GeV}$, squarks heavy. First generation squarks. **Earlier theory projections qualitatively OK.**

Consider seriously models with splitting between first/second and third generation squarks if SUSY does not show up..

Some Run 2 LHC results

There are still no direct SUSY signals in the LHC data.

ATLAS

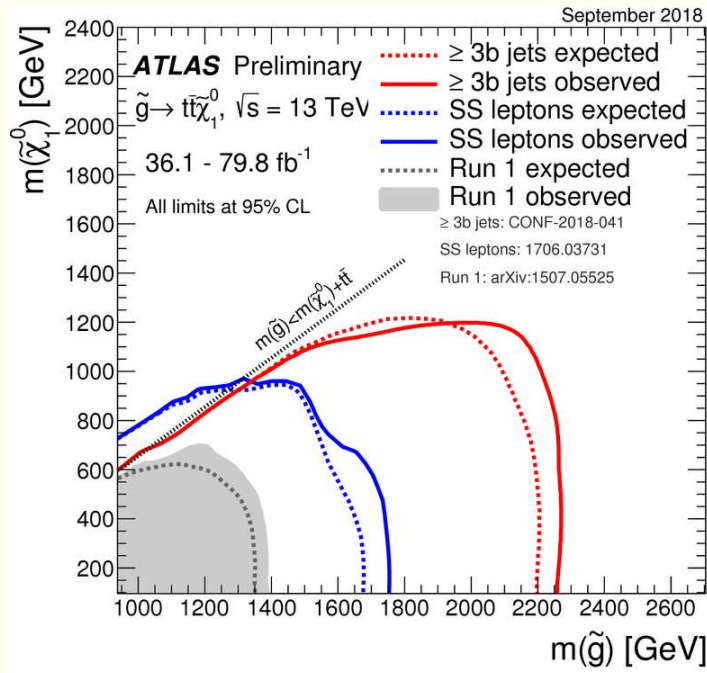

CMS

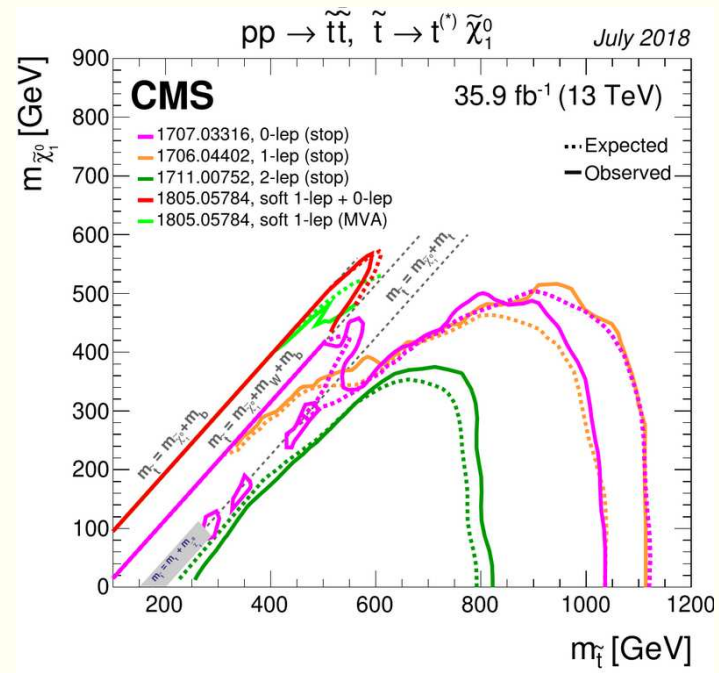

$m_{\tilde{g}} > 1900 - 2200$ GeV if squarks are heavy, and gluinos decay to third generation.

Top and sbottom squarks are heavier than 1.1 TeV.

Electroweak ino-Searches

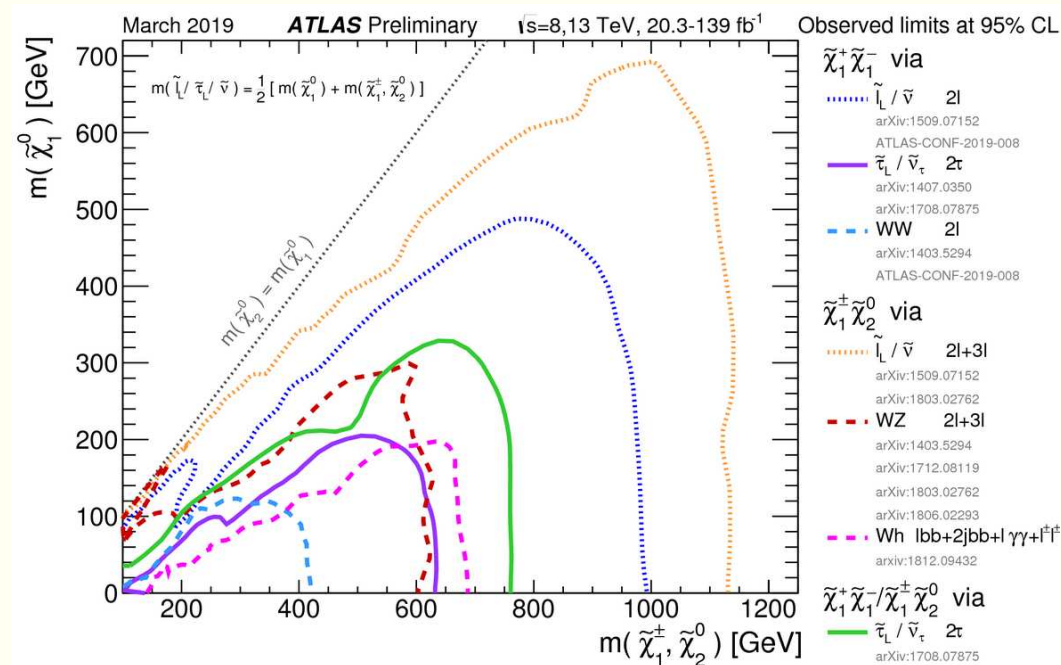

Interesting electroweak-ino mass limits around 500-600 GeV. Bounds are less stringent as these are produced with smaller cross sections, by electroweak interactions.

Many other searches also, but no signal!

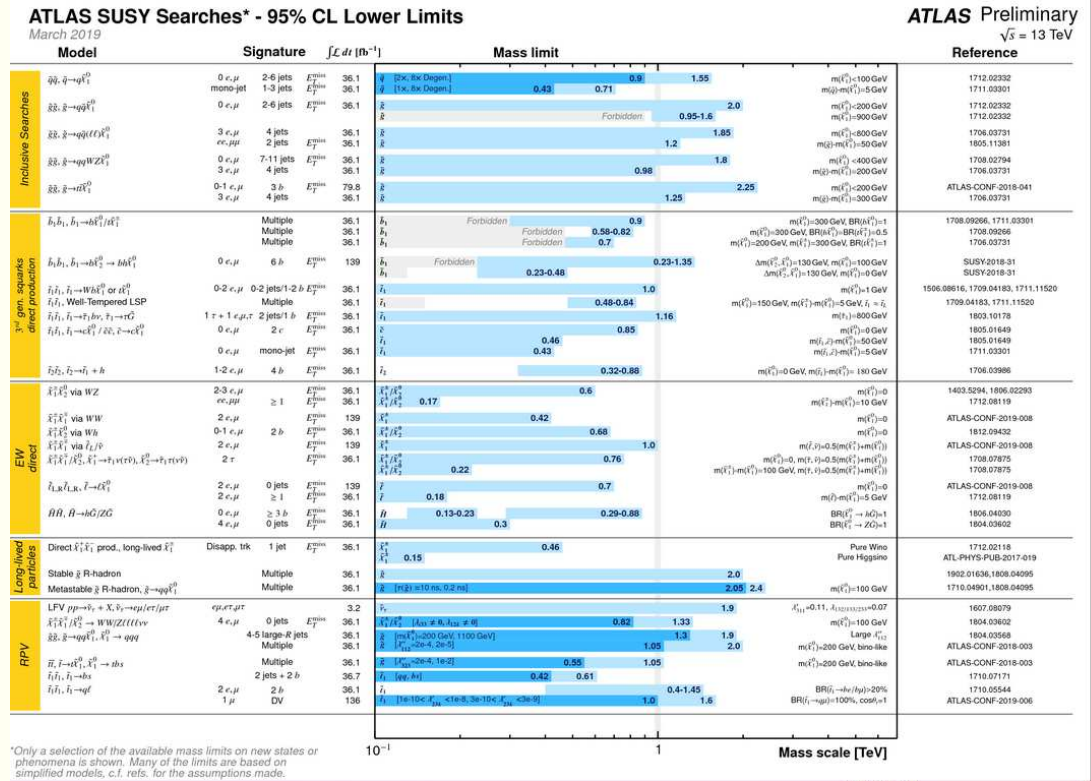

A change in Analysis Strategy?

Notice that for the most part under simplified model assumptions. Analysis will change under other scenarios.

More importantly, any information about (model-dependent) inter-relations between searches is absent. Not a big deal now, but will be an issue if any signals are observed!

In my opinion, the thinking that simplified model analyses are model-independent, and that the results from these can be readily adapted to specific models is misguided.

This is not to say that I believe that the mSUGRA model, or any other framework for that matter, is the way to go. Just that we should be prepared to extract information about how to zero in on what the underlying physics might be and ultimately any “organizing principle” should signals for new physics be observed.

Since there are no experimental analyses, illustrate with theorist projections with mSUGRA.

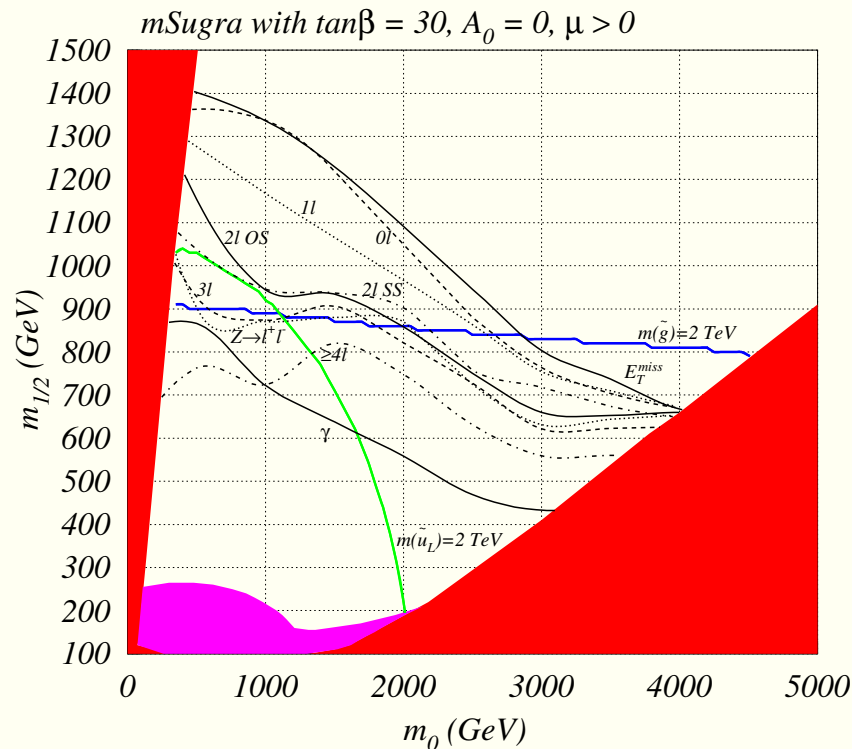

JHEP 0306 (054)

mSUGRA (100 fb^{-1})

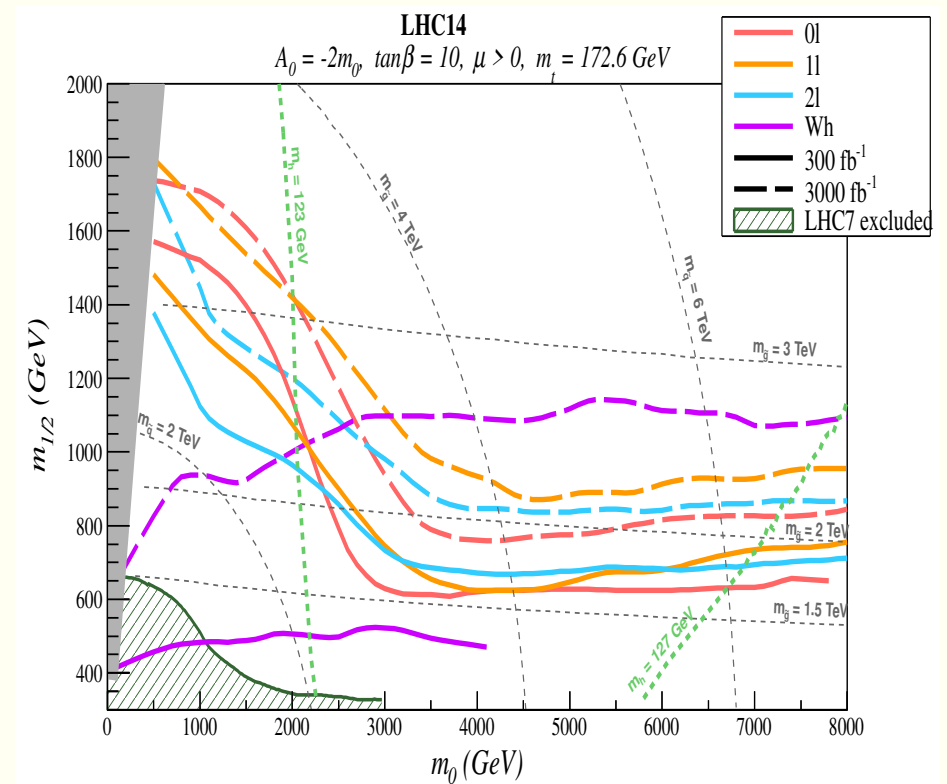

High luminosity LHC14

Note the reach from Wh channel at very high integrated luminosity in the plot on the right. EW wino production is beating gluino production.

Some Observations

- ★ There may be observable signals in several channels (true in many SUSY models).
- ★ The LHC reach, measured in terms of $m_{\tilde{g}}$ and $m_{\tilde{q}}$, is roughly the same for a wide variety of models. This is because the signals dominantly come from gluino/squark production with a large mass gap.
- ★ The relative rate for the various event topologies is model-dependent, and so can provide some information about the underlying framework. Of course, there is more direct information in the spectrum (if this can be determine).
- ★ The ultimate high luminosity reach in models with gaugino mass unification is determined by EW production processes, since coloured particle production is kinematically suppressed.

WHILE WE HAVE ILLUSTRATED THIS FOR mSUGRA, THESE STATEMENTS PROBABLY APPLY TO ALL MODELS WITH A HANDFUL OF PARAMETERS.

Emphasize that the existence of these signals mostly was a consequence of the 3-2-1 gauge symmetry, and the existence of a significant mass gap between superpartners and the LSP.

In some frameworks, there may even be additional handles.

In models with a light gravitino, the next-to-lightest superpartner can only decay to a gravitino. If this happens inside the detector, this could lead to additional tags to reduce SM backgrounds.

$\tilde{Z}_1 \rightarrow \gamma, Z, h$ plus \tilde{G} in GMSB models or even $\tilde{\ell}_R \rightarrow \ell + \tilde{G}$.

If the LSP is a wino, then very small mass gap between the charged wino and the neutral LSP, possibly leading to stubby tracks with kinks.

If R -parity is violated by lepton number violating operators, the putative LSP would decay to leptons leading to SUSY events with high lepton multiplicity,

However, the grass is not always greener on the other side.

Cautions and Caveats

- ★ SUSY spectrum may be “compressed” *i.e.* Smaller than expected mass gaps. Efficiency affected.
- ★ R -parity may not be conserved, so LSP may decay. Softer E_T^{miss} spectrum, so hard E_T^{miss} cuts only at analysis level. Reach may go up or down.
- ★ We have assumed prompt sparticle decays. Possibility of long-lived charged or coloured sparticles. Since coloured sparticles hadronize, the lightest R -hadron may be neutral but strongly interacting. It can have soft charge-exchange processes in traversing a detector, leading to unusual tracks.
- ★ Long-lived charged sparticles may leave stubby tracks with kinks, *e.g.* $\widetilde{W}_1^+ \rightarrow \widetilde{Z}_1 \pi^+$ with $\tau(\widetilde{W}_1) \sim 10^{-9} \text{s}$.
- ★ Long-lived neutral particles may have very large decay gaps, *e.g.* a neutralino NLSP of GMSB models, or neutralino LSP of R -parity violating models.

It is also possible to engineer SUSY models to hide supersymmetry by reducing the E_T^{miss} expected in SUSY events. Fan, Reece, Ruderman; Fan, Krall, Pinner, Reece, Ruderman,...

The idea is that a small mass gap may be better motivated in a secluded sector if its coupling to the SUSY breaking sector is dynamically suppressed.

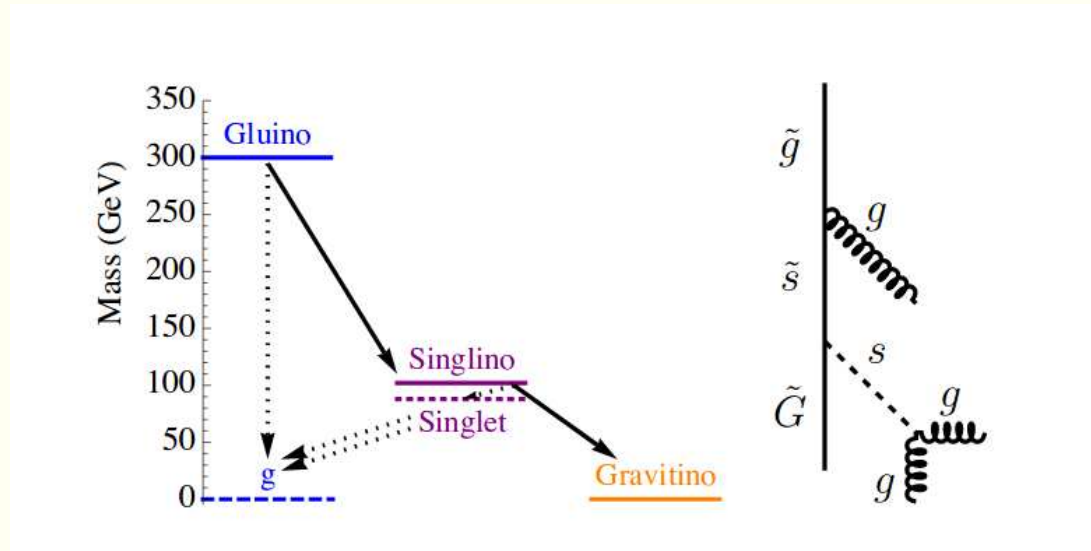

Since $m_{\tilde{g}} - m_S \ll m_{\tilde{g}}$, the \tilde{G} is typically soft, and the E_T^{miss} in SUSY events is small.

While it is true that there was much hope and expectation that LHC experiments would discover superpartners because these had to “lie below a TeV”, the question is what does the lack of direct evidence for their production mean?

SUSY HAS RECEIVED A LOT OF BAD PRESS.

315 Physicists Report Failure In Search for Supersymmetry

Malcolm Browne, NYT, Jan 15, 1993

Is Supersymmetry Dead?

Davide Castelvecchi, Scientific American, May 1, 2012

Why Supersymmetry May Be The Greatest Failed Prediction

in Physics History

Ethan Siegel, Science, Feb 12, 2019

There is a lot of negativity about SUSY, so we need to take stock and ask:

Where did these strong expectations come from, and has SUSY not lived up to these?

I remind you that in SUSY theories,

$\delta m_h^2 \sim \frac{g^2}{16\pi^2} m_{\text{SUSY}}^2 \times \log(\Lambda^2/m_{\text{SUSY}}^2) \sim m_{\text{SUSY}}^2$, if the weak SUSY theory is coupled to a theory with heavy particles with masses $\sim \Lambda$, *e.g.* in a SUSY GUT, $\Lambda \sim M_{\text{GUT}}$. There is no Λ^2 correction because softly broken SUSY has no big hierarchy problem.

(Martin lectures)

Since the $\log \sim 30$, setting $\delta m_h^2 < m_h^2 \Rightarrow m_{\text{SUSY}}^2 < m_h^2$, and there was much optimism for superpartners at LEP/Tevatron.

$\Delta_{\log} = \frac{\delta m_h^2}{m_h^2}$ suggested as a measure of fine tuning.

WHAT WENT WRONG?

- ★ Perhaps $\delta m_h^2 < m_h^2$ is too stringent? Many examples of accidental cancellations in nature of one or two orders of magnitude.
- ★ Argument applies only to superpartners with large couplings to the EWSB sector (not, *e.g.* to first generation squarks probed at the LHC).
- ★ Most importantly, once we understand SUSY breaking, almost certainly we will find that contributions from the various superpartners are correlated, leading to the possibility of automatic cancellations.
Ignoring this, will overestimate the UV sensitivity of any model.

Traditionally, the sensitivity is measured by checking the fractional change in M_Z^2 (rather than m_h^2) relative to the corresponding change in the independent parameters (p_i) of the theory. (Ellis, Enqvist, Nanopoulos, Zwirner, reinvented and explored by Barbieri and Giudice): $\Delta_{\text{BG}} = \text{Max}_i \frac{p_i}{M_Z^2} \frac{\partial M_Z^2}{\partial p_i}$,

$$\Delta_{\text{log}} \geq \Delta_{\text{BG}},$$

since Δ_{log} ignores correlations we just mentioned.

Since we do not really understand SUSY breaking, it is entirely possible that soft-SUSY breaking model parameters we usually take to be independent from our bottom-up perspective may turn out to be correlated.

With the appropriate correlations, the $\log \frac{\Lambda}{M_{\text{SUSY}}}$ terms that we had (approximately) cancel, leading to a much lower estimate of the fine-tuning.

How can we allow for this when we do not have a theoretical understanding of how superpartners masses arise?

Electroweak Fine-tuning

$$\frac{M_Z^2}{2} = \frac{(m_{H_d}^2 + \Sigma_d^d) - (m_{H_u}^2 + \Sigma_u^u) \tan^2 \beta}{\tan^2 \beta - 1} - \mu^2, \text{ (Weak scale relation)}$$

(Σ_u^u, Σ_d^d are finite radiative corrections.)

Requiring no large cancellations on the RHS, motivates us to define,

$$\Delta_{EW} = \max \left(\frac{m_{H_u}^2}{\frac{1}{2} M_Z^2} \frac{\tan^2 \beta}{\tan^2 \beta - 1}, \frac{\Sigma_u^u}{\frac{1}{2} M_Z^2} \frac{\tan^2 \beta}{\tan^2 \beta - 1}, \dots \right). \text{ Small } \Delta_{EW} \Rightarrow m_{H_u}^2, \mu^2 \text{ close to } M_Z^2.$$

Since Δ_{EW} has no large logs in it, $\Delta_{EW} \leq \Delta_{BG}$, but not a fine-tuning measure.

However, Δ_{EW} is a bound on the fine-tuning. Although a small Δ_{EW} does not guarantee low fine-tuning, a large value is a sign that the spectrum is fine-tuned.

We have checked that if UV scale parameters of the model are suitably correlated so the $\log \frac{\Lambda^2}{m_{SUSY}^2}$ terms essentially cancel, $\Delta_{BG} \rightarrow \Delta_{EW}$ (modulo technical caveats).

(The large logs are hidden because I wrote $m_{H_u}^2 = m_{H_u}^2(\Lambda) + \delta m_{H_u}^2$.)

BECAUSE WE KNOW SO LITTLE ABOUT HOW SUPERPARTNER MASSES ARISE, WE SUGGEST USING Δ_{EW} FOR DISCUSSIONS OF FINE-TUNING.

Some smart person will, perhaps, figure out why the soft SUSY breaking parameters are so that $\Delta_{BG} \simeq \Delta_{EW}$.

We suggest using $\Delta_{EW} < 30$ (between one and two orders of magnitude) as a conservative bound for naturalness.

Underlying philosophy is that if we find an underlying theory of SUSY breaking parameters with low Δ_{BG} that yields essentially the same spectrum, it will have the same phenomenological implications since these are mostly determined by the spectrum. The NUHM2, or some other top-down model with low Δ_{EW} is a surrogate for exploring the phenomenology of this (as yet unknown) theory with low ($\Delta_{EW} < 30$) fine-tuning.

Phenomenology of $\Delta_{EW} < 30$ models

- ★ Four light higgsino-like inos, $\tilde{Z}_{1,2}$, \tilde{W}_1^\pm ;
- ★ $m_{\tilde{t}_1} = 1 - 3.5$ TeV.
- ★ $m_{\tilde{g}} = 1 - 6$ TeV [9 TeV in an exceptional case] (else \tilde{t} s becomes too heavy and make Σ_u^u too large).
- ★ Split the generations and choose $m_0(1, 2)$ large to ameliorate flavour and CP issues. This is separate from getting small Δ_{EW} . NUHM3 model

Large intra-generation splittings among heavy first/second generation squarks leads to large Δ_{EW} except for specific mass patterns.

LHC signals for light higgsinos

EW production cross section for 150 GeV higgsino pairs is $\mathcal{O}(1 \text{ pb})$. However, the $\widetilde{W}_1 - \widetilde{Z}_1$ and $\widetilde{Z}_2 - \widetilde{Z}_1$ mass gaps are typically below $\sim 25 \text{ GeV}$, so the visible higgsino decay products are soft and the signal is swamped by SM backgrounds.

There has been much talk about detecting light higgsinos via inclusive $E_T^{\text{miss}} + \text{monojet}$ events from $pp \rightarrow \widetilde{W}_1 \widetilde{W}_1, \widetilde{W}_1 \widetilde{Z}_{1,2}, \widetilde{Z}_{1,2} \widetilde{Z}_{1,2} + \text{jet}$ production, where the jet comes from QCD radiation.

- ★ Although there is a “ 5σ signal”, even after hard cuts, the signal to background ratio is typically at the percent level. We are pessimistic that the backgrounds can be controlled/measured at the subpercent level needed to extract the signal in the inclusive $E_T^{\text{miss}} + \text{monojet}$ channel. Baer, Mustafayev, XT arXiv:1401.1162; C. Han *et al.*, arXiv:1310.4274; P. Schwaller and J. Zurita, arXiv:1312.7350

★ However, as first noted by G. Giudice, T. Han, K. Wang and L-T. Wang, and elaborated on by Z. Han, G. Kribs, A. Martin and A. Menon that backgrounds may be controllable by identifying soft leptons in events triggered by a hard monojet.

Hard monojet + soft OS/SF dilepton pair ($m_{\ell\ell} < m_{\tilde{Z}_2} - m_{\tilde{Z}_1}$) in the event.

OS/SF dilepton pair with $m_{\ell\ell} < m_{\ell\ell}^{\text{cut}}$ analysis with $m_{\ell\ell}^{\text{cut}}$ as an analysis variable.

Alternatively, examine dilepton flavour asymmetry $\frac{N(SF) - N(OF)}{N(SF) + N(OF)}$ in monojet plus OS dilepton events. (Gives better control on systematics as normalization uncertainty cancels.)

No time to describe details of the analysis here.

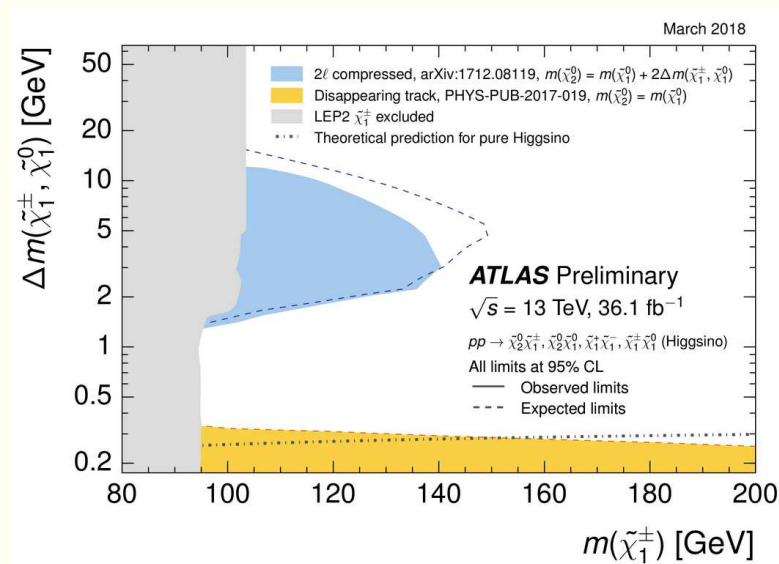
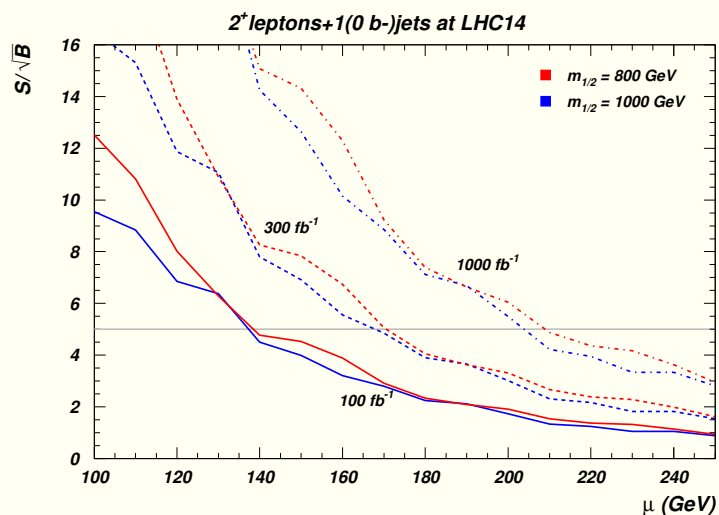

LHC14 reach extends to about $|\mu| = 170$ (210) GeV for integrated luminosity of 300 (1000) fb^{-1} . Baer, Mustafayev and XT

Recent ATLAS analysis gives reassurance that this is doable, but the issue is how low a ΔM they will cover, as M goes up.

A novel LHC signal for light higgsinos

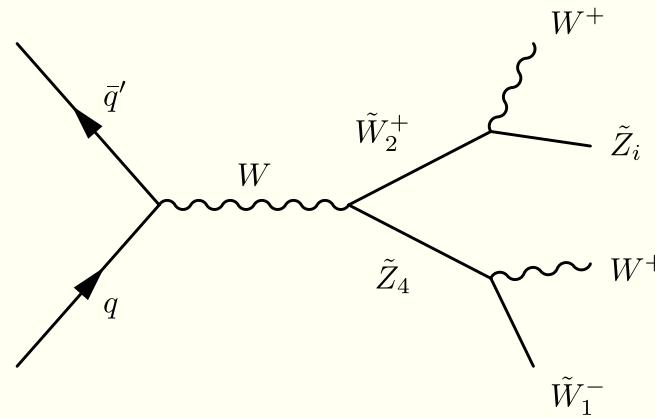

Decays of the parent \widetilde{W}_2^+ and \widetilde{Z}_4 that lead to W boson pairs give the same sign 50% of the time. Novel same sign dilepton events with jet activity essentially only from QCD radiation since decay products of higgsino-like \widetilde{W}_1^- and \widetilde{Z}_2 are typically expected to be soft.

Leptons from daughter higgsinos may be observable – novel 4ℓ signature in events free from jet activity in addition to the canonical trilepton signal.

This new SSdB signal may point to the presence of light higgsinos.

NUHM2: $m_0=5 \text{ TeV}$, $A_0=-1.6m_0$, $\tan\beta=15$, $\mu=150 \text{ GeV}$, $m_A=1 \text{ TeV}$

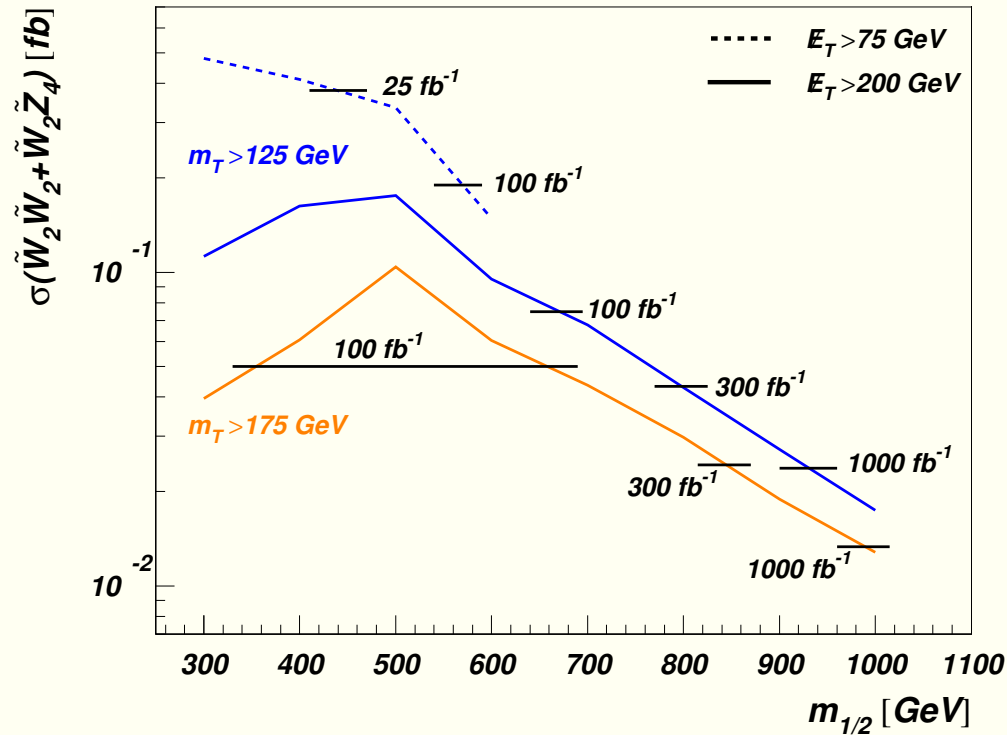

Hard cuts on E_T^{miss} and minimum transverse mass $m_T(\ell_{1,2}, E_T^{\text{miss}})$ are crucial to pull out the signal. PRL 110, 151801 (2013)

Additional confirmatory signals from 3 and 4 lepton production. JHEP06 (2015) 053

Reach for SSdB and monojet+ soft dilepton channels

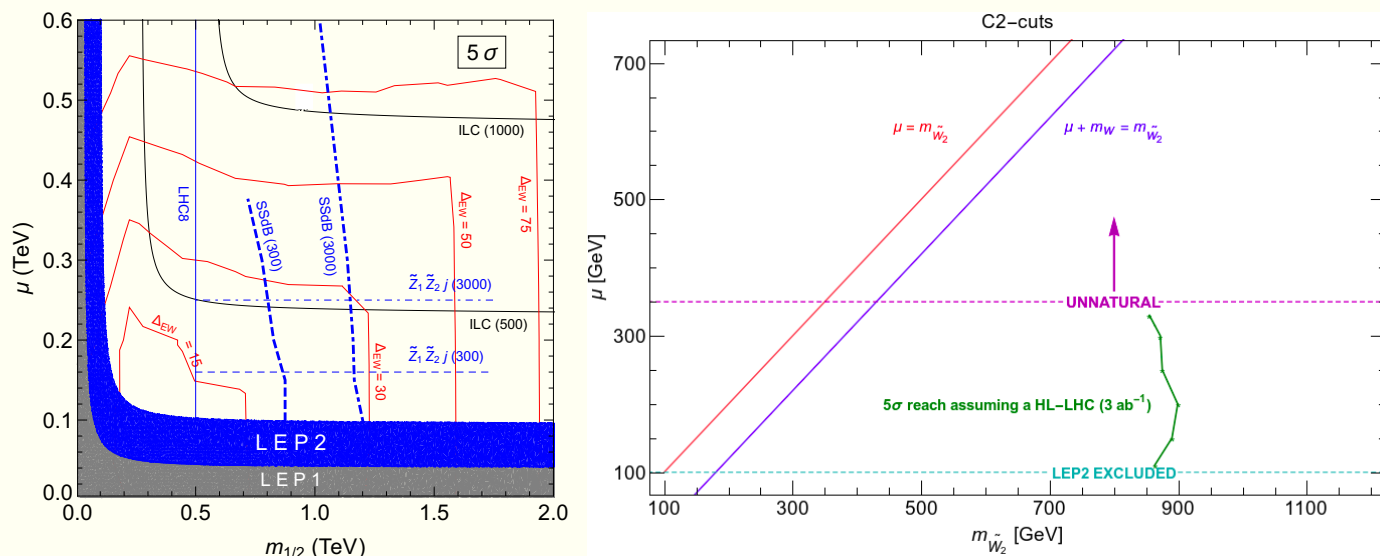

The SSdB signal requires not too heavy winos (small M_2 , or equivalently, $m_{1/2}$).

The monojet + soft dilepton signal requires light higgsinos, *i.e.* not too large $|\mu|$.

This picture misleadingly rosy as we implicitly assumed gaugino mass unification!

Winos can be heavy without jeopardizing naturalness. WHAT ELSE CAN WE DO?

Glino reach at LHC14 with lighter stops

Present stop limits $\sim 0.9 - 1 \tilde{\text{TeV}}$; Snowmass studies project that HL-LHC may cover stops out to 1.4 TeV.

Since stops are light, gluinos typically decay via $\tilde{g} \rightarrow t\tilde{t}_1$, with $\tilde{t}_1 \rightarrow t\tilde{Z}_{1,2}$ and $\tilde{t}_1 \rightarrow b\tilde{W}_1$. Decay products of the daughter higgsinos are too soft for efficient detection. Else even more handles on the signal.

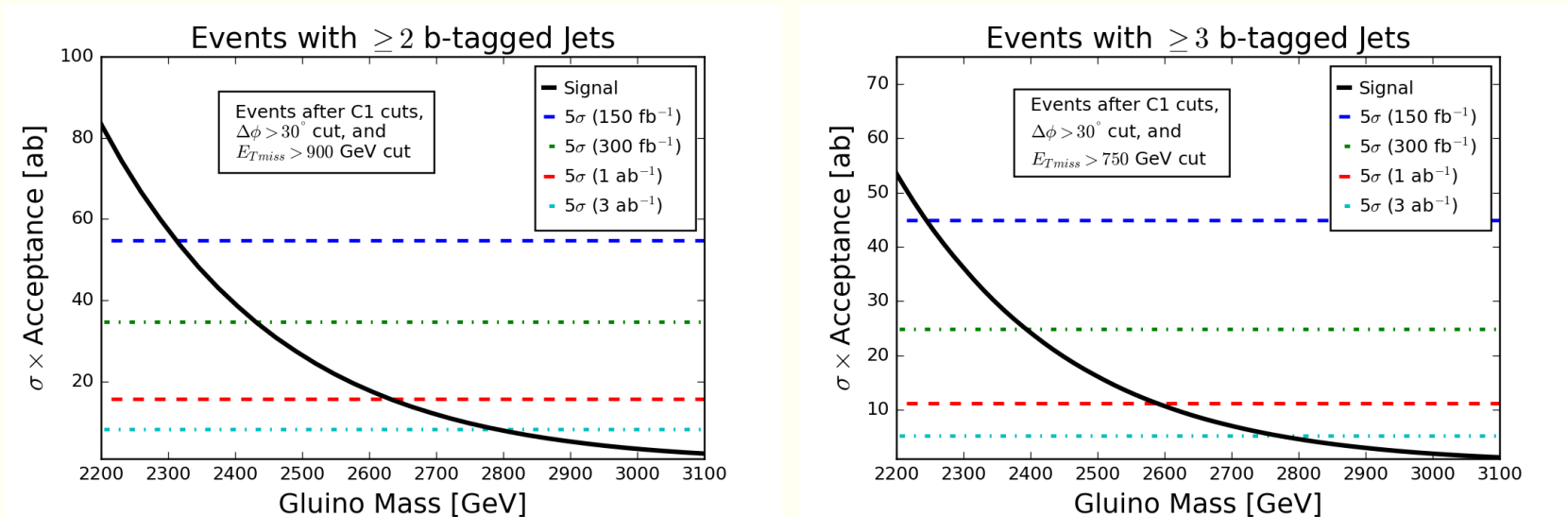

Even with 3 ab^{-1} , gluinos heavier than 2.8 TeV will not be detectable at LHC14.
(arXiv:1612.00795)

In extracting the signal, we had made very hard cuts to get large S/B ratios: > 5 (10) in 2- (3-) tagged b -jet channels.

This suggests the possibility of extracting the gluino mass via counting experiments.

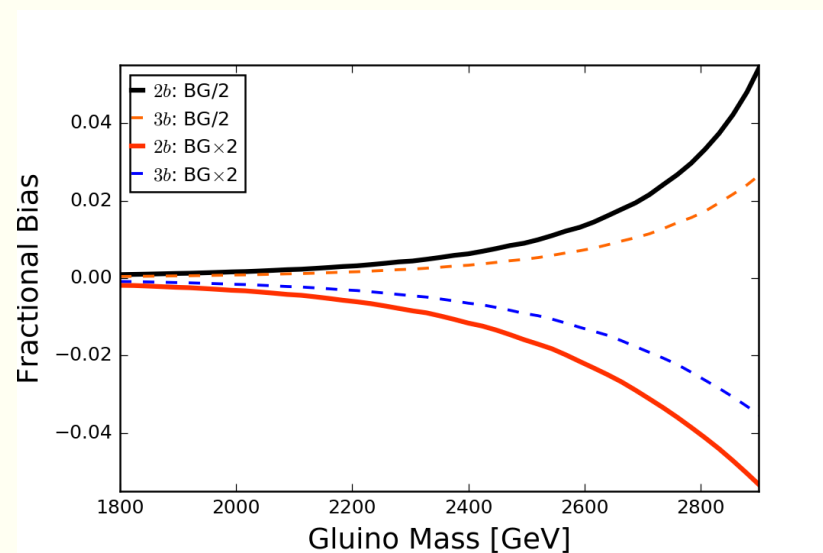
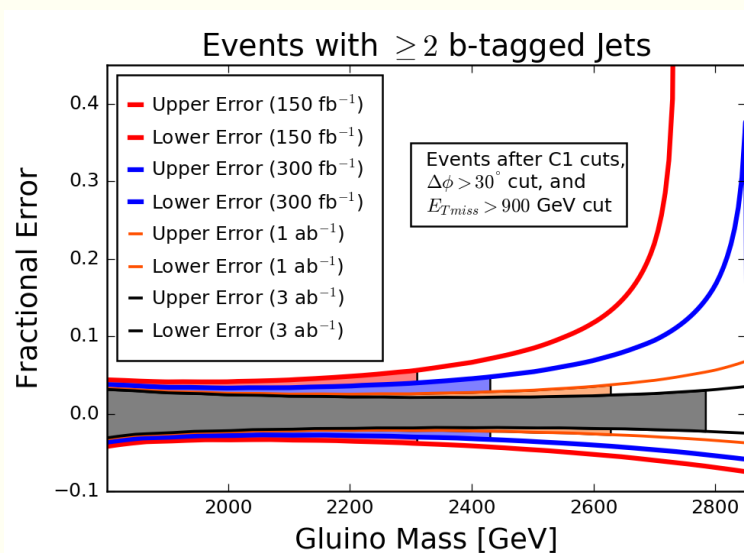

Mass measurements at the 2.5-5% level may be possible at least in models where the assumed decay patterns may be confirmed via other signals. (arXiv:1612.00795)

A Recap of the LHC14 Reach for light higgsinos in terms of $m_{\tilde{g}}/\text{TeV}$

Int. lum. (fb^{-1})	$\tilde{g}\tilde{g}$ (can)	SSdB	$WZ \rightarrow 3\ell$	4ℓ	$\tilde{g} \rightarrow \tilde{t}$
10	1.4	–	–	–	
100	1.6	1.6	–	~ 1.2	2.2
300	1.7	2.1	1.4	$\gtrsim 1.4$	2.4
1000	1.9	2.4	1.6	$\gtrsim 1.6$	2.6

Gaugino mass unification is assumed when correlating SSdB signal with $m_{\tilde{g}}$.

The canonical gluino signature yields the highest reach only for integrated luminosities up to 100 fb^{-1} . (Higher \tilde{g} reach if $\tilde{g} \rightarrow tt, tb + X$.) The SSdB signal is a generic characteristic of small $|\mu|$ models.

If the SSdB signal is present, there may be confirmatory signals in the 3ℓ and 4ℓ channels.

We had seen that assuming gaugino mass unification, experiments at the HL-LHC seemed to cover essentially all the “natural” SUSY region via the SSdB and monojet+ soft lepton channels.

But this is not good enough because gaugino mass unification is not expected in many well-motivated SUSY GUT models maintaining naturalness.

- ★ **Mirage unification** (KKLT, Choi et. al., Falkowski et al.) (Michael)
- ★ **The mini-landscape picture** (Nilles and collaborators.) (Michael)
- ★ **Non-universality is generic if the field that breaks SUSY transforms non-trivially under the GUT gauge group.** (Gauge couplings will still unify at M_{GUT} !)

In such scenarios, we may have low Δ_{EW} , but no observable signals at even the HL-LHC. How small a ΔM is accessible at the HL-LHC? (under examination)

Motivation to look at energy upgrades of the LHC

Gluino and stop reach at LHC27 (arXiv:1708.09054 and arXiv:1808.04844)

CERN is considering a plan for an energy upgrade of LHC. arXiv:1108.1617 [phys.acc-ph] suggested a 33 TeV collider to deliver a data sample of $\sim 1 \text{ ab}^{-1}$ in LEP tunnel. (HE-LHC study at 27 TeV, 15 ab^{-1} , arXiv:1812.07831.)

Natural to examine prospects for gluinos and stops of natural SUSY whose masses are bounded above by about 3.5 and 6 TeV/9 TeV, respectively.

Examined the reach of LHC33 assuming $\tilde{g} \rightarrow \tilde{t}_1^{(*)} t$, $\tilde{t}_1 \rightarrow t \tilde{Z}_1$, $b \tilde{W}_1$.

Used very hard cuts to get the maximal reach.

Gluino: $n_b \geq 2$, isolated lepton veto, $E_T^{\text{miss}} > \text{Max}(1900 \text{ GeV}, 0.2M_{\text{eff}})$, $n_j \geq 4$ with $E_{Tj_i} > 1300, 900, 200, 200 \text{ GeV}$, $S_T > 0.1$, $\Delta\phi > 10$ degrees.

Stop: $n_b \geq 2$, isolated lepton veto, $E_T^{\text{miss}} > \text{Max}(1500 \text{ GeV}, 0.2M_{\text{eff}})$
 $E_{Tj_i} > 1000, 600 \text{ GeV}$, $S_T > 0.1$, $\Delta\phi > 30$ degrees.

Main SM backgrounds from $t\bar{t}$, $b\bar{b}Z$, $t\bar{t}b\bar{b}$, $4t$ and single t production.

LHC27 reach for gluinos and squarks

The various dots denote gluino and stop masses in various models with $\Delta_{EW} < 30$ that I showed you earlier. The vertical (horizontal) lines are our projections for the stop (gluino) reach/exclusion region for an integrated luminosity of 15 ab^{-1} .

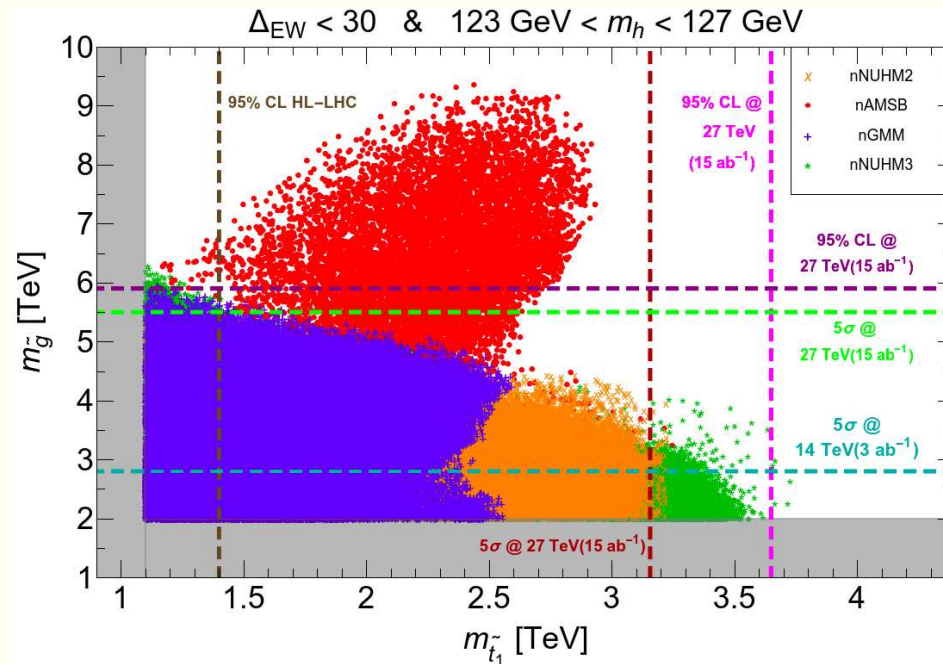

We see that the LHC27 reach will be sensitive to at least one of the stop, or the gluino, and over most of the parameter range to both! Independent analysis by Han, Ismail and Haghi with 4.7 TeV reach in gluino and 2.8 TeV in stop (arXiv:1902.05109). They find larger backgrounds, but have softer cuts.

SUSY things to watch for at this meeting

- ★ Updates on searches for superpartners with LHC13 data Beyond Moriond
- ★ Treat EW-ino production independently of gluino production; gaugino mass unification is an added assumption.
- ★ I am personally very interested in how searches for superpartners in light higgsinos pan out. We talked about the ATLAS result in the monojet plus soft dilepton channel.
- ★ Direct WIMP searches. The light DM battles will probably continue.
- ★ Indirect DM detection?? Is the “positron excess” a signal (of something) or hype? Kruskal, Ahlen, Tarle, Ap. J. 818 (2016) 70
- ★ Keep eye open for flavour violation data; FV processes could provide indirect evidence for new physics.

Agenda for 2012-2020 (from Beijing SUSY lectures)

- ★ Establish a clear New Physics signal.
- ★ Make the case it is SUSY. The case will be circumstantial.
 - Rates vs. mass. Strong vs. EW \implies Q. Nos.
 - Same sign dileptons+jet+ E_T^{miss} signal \implies strongly interacting Majorana particles. ($N(\ell^+\ell^+)$ vs. $N(\ell^-\ell^-)$)
 - Cascade decays evidence of charginos and neutralinos?
 - Clean trileptons as evidence of charginos and neutralinos
 - Higgs bosons (Baer, Bisset, XT, Woodside) and stops in gluino cascade decays (Hisano, Kawagoe, Nojiri)
 - Spin measurements (Cambridge, São Paulo,....), Mass Measurements (multiple techniques by many groups.)

BUILD A CONSISTENT PICTURE.

I think this slide still works, except I'd add SS dilepton events without jets as an interesting possibility at the LHC.

In the next several years, we hope there will be a lot of new data as we have many beautiful experiments.

- ★ LHC, Direct and indirect WIMP detection searches Only part of DM may be of SUSY origin.
- ★ Probes of flavour physics in the b and c meson systems....also at the LHC. Must also probe lepton flavour violation. **REMEMBER THAT WE DO NOT UNDERSTAND FLAVOUR CONSERVATION IN THE SUSY CONTEXT.** Even if flavour violation is only in the Yukawa sector, KM matrix may not completely encode it!
- ★ We do not understand the goodness of CP in the SUSY context. Push experiments in meson systems to see if we can break the KM tyranny. Probe neutron and electron EDMs.
- ★ Axion searches *e.g.* for mixed SUSY-axion DM.

SUSY Anti-Propoganda

- ★ Why are baryon and lepton numbers apparently conserved when we can write down gauge invariant renormalizable operators that do not conserve these?
- ★ Why is $\mu \sim M_{\text{Weak}}$? (can accommodate)
- ★ Why are flavour and CP violating effects that should generically have been large, so small?

These “generic problems” will hopefully be understood when we figure out the origin of superpartner masses, but right now the SM is ahead of the MSSM on these points.

- ★ SUSY does not provide any explanation of the weird parameters of the SM.

Still, it is a beautiful idea that enables us to extrapolate physics sensibly to high energy scales.

Despite this, I think that:

- ★ Dismay at the non-appearance of SUSY seems premature. We were over-optimistic in our expectations from naturalness. The LHC run has a long way to go, and novel signals from, *e.g.* light higgsinos may yet appear.
- ★ The stakes are high enough to dream of what we may unearth at future accelerators, and we dream of LHC energy upgrades, or even a 100 TeV machine.
- ★ I believe that our original aspirations for SUSY dating back to early 1980s remain unchanged if we accept that “accidental cancellations” at the few percent level are ubiquitous, and that DM may be multi-component.
- ★ In my opinion, weak scale SUSY still offers the best resolution of the big hierarchy problem, and there may well be viable models with just the MSSM spectrum where the fine-tuning is no worse than a few percent. The discovery potential is enormous, and we should not be discouraged.

CONCLUSIONS

- ★ WE ARE IN AN ERA OF OPPORTUNITIES WITH THE LHC AND ITS UPGRADES AS WELL AS OF OTHER FACILITIES THAT WILL ALLOW US TO STUDY STUFF FROM THE SKY.
- ★ PARTICLE PHYSICS AND COSMOLOGY HAVE BECOME INTER-RELATED AT AN UNPRECEDENTED LEVEL.
- ★ I DO NOT KNOW WHAT NATURE HAS IN STORE FOR US, BUT WE MUST LOOK TO SEE WHAT WE FIND.
- ★ WE HOPE THAT OUR EXPERIMENTAL COLLEAGUES WILL TELL US SOMETHING NEW SOON, PERHAPS EVEN NEXT WEEK!!!!