

Run Number: 152166, Event Number: 347262

Date: 2010-03-30 13:05:04 CEST

ATLAS Status, Results and Prospects

Stathes Paganis (University of Sheffield), on behalf of the ATLAS Collaboration
PLANCK2010 , CERN, June 2nd 2010

Outline

- Introduction
- Status of the ATLAS experiment/Detector
- Performance results at $\sqrt{s} = 0.9$ and 7 TeV
- First ATLAS Physics Results at 7 TeV
- Conclusions

ATLAS Collaboration



- | | |
|----------------|-------------|
| Argentina | Morocco |
| Armenia | Netherlands |
| Australia | Norway |
| Austria | Poland |
| Azerbaijan | Portugal |
| Belarus | Romania |
| Brazil | Russia |
| Canada | Serbia |
| Chile | Slovakia |
| China | Slovenia |
| Colombia | Spain |
| Czech Republic | Sweden |
| Denmark | Switzerland |
| France | Taiwan |
| Georgia | Turkey |
| Germany | UK |
| Greece | USA |
| Israel | CERN |
| Italy | JINR |
| Japan | |

ATLAS
Collaboration

37 countries
173 Institutes
~ 2900 Authors
(1000 students)



A Toroidal LHC ApparatuS: the ATLAS detector

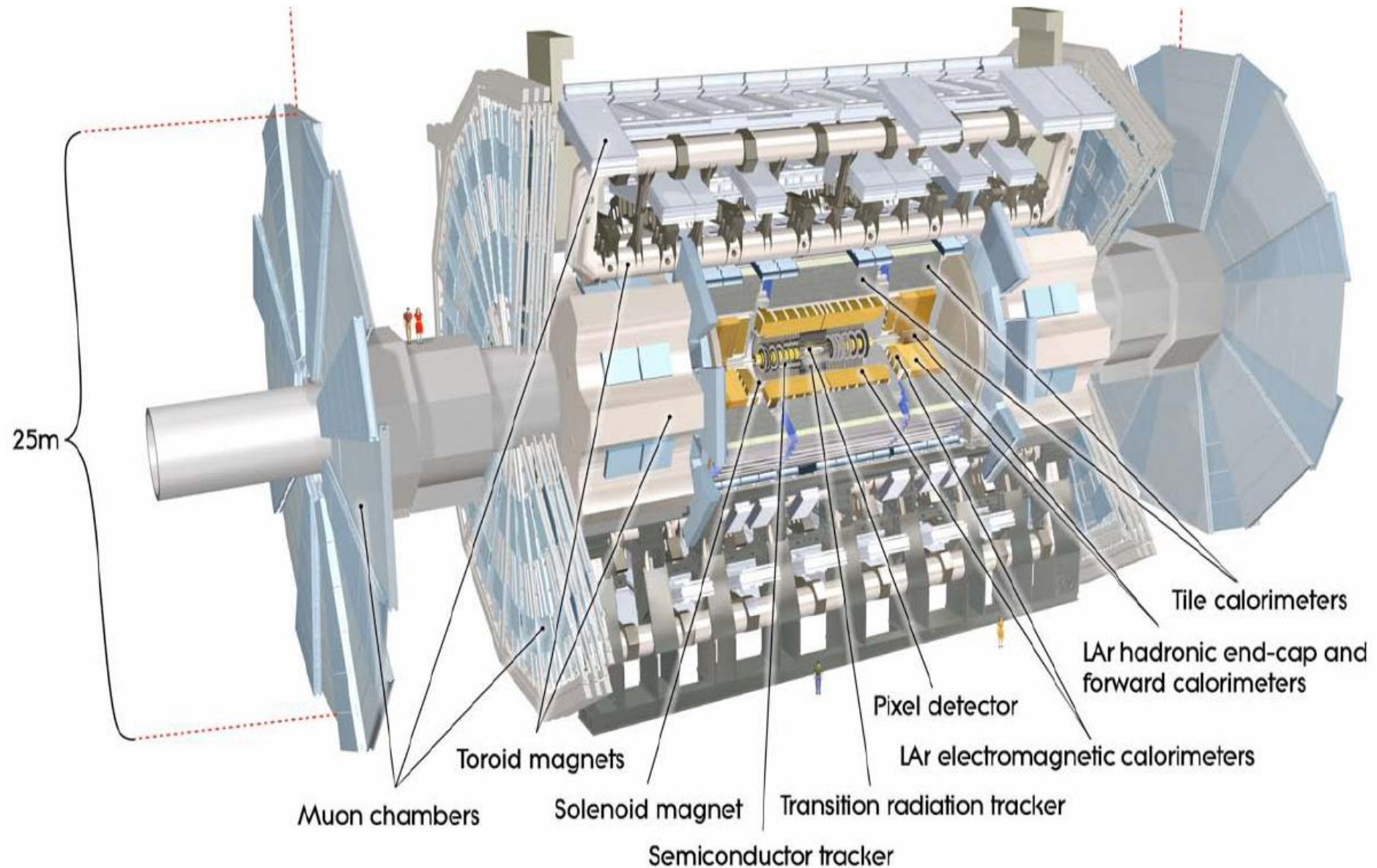

Overall ATLAS Detector Performance

Subdetector	Number of Channels	Approximate Operational Fraction
Pixels	80 M	97.5%
SCT Silicon Strips	6.3 M	99.3%
TRT Transition Radiation Tracker	350 k	98.0%
LAr EM Calorimeter	170 k	98.5%
Tile calorimeter	9800	97.3%
Hadronic endcap LAr calorimeter	5600	99.9%
Forward LAr calorimeter	3500	100%
LVL1 Calo trigger	7160	99.8%
LVL1 Muon RPC trigger	370 k	99.7%
LVL1 Muon TGC trigger	320 k	100%
MDT Muon Drift Tubes	350 k	99.7%
CSC Cathode Strip Chambers	31 k	98.5%
RPC Barrel Muon Chambers	370 k	97.3%
TGC Endcap Muon Chambers	320 k	98.8%

Overall recorded Luminosity

- Total luminosity about 15 nb^{-1} , 865M total events recorded, 1.6MB/evt
- Present overall scale uncertainty $\sim 20\%$

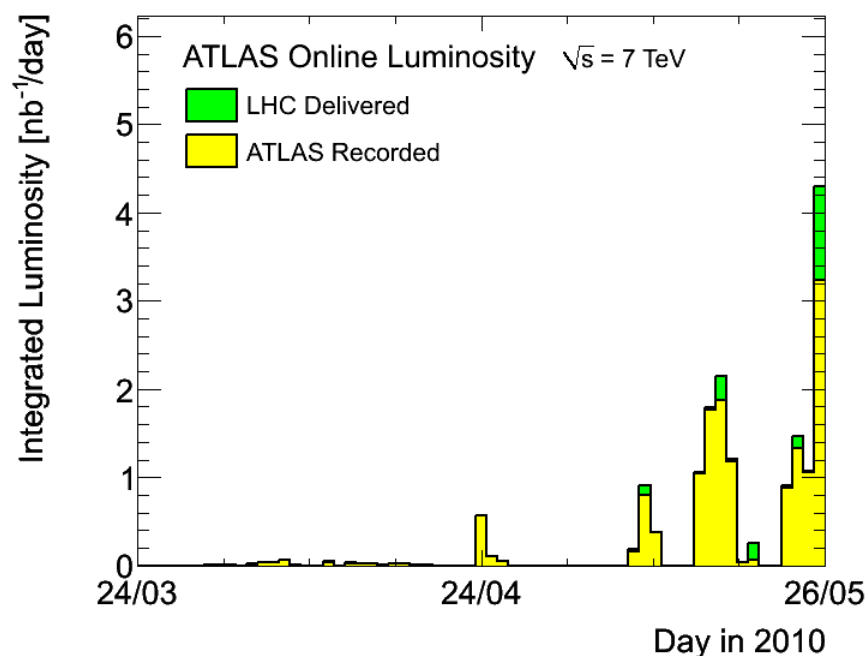
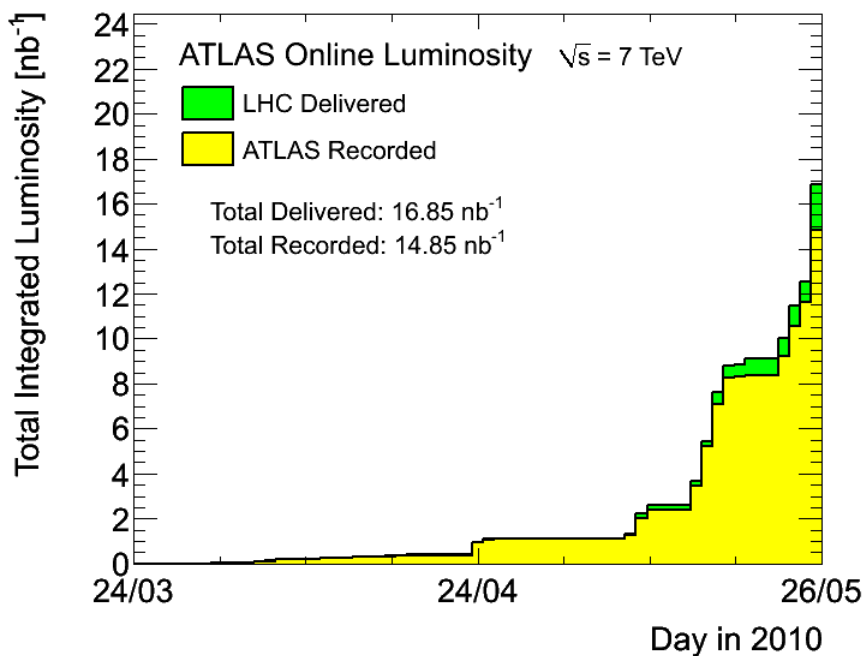

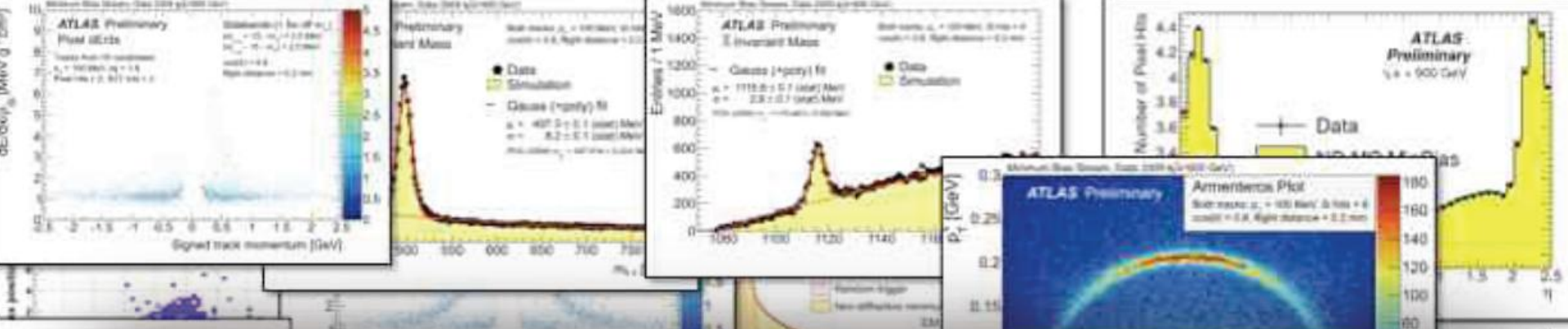

Many results have been produced in a short period of time
 I can only show a few ...
 more at
<http://atlas.web.cern.ch/>

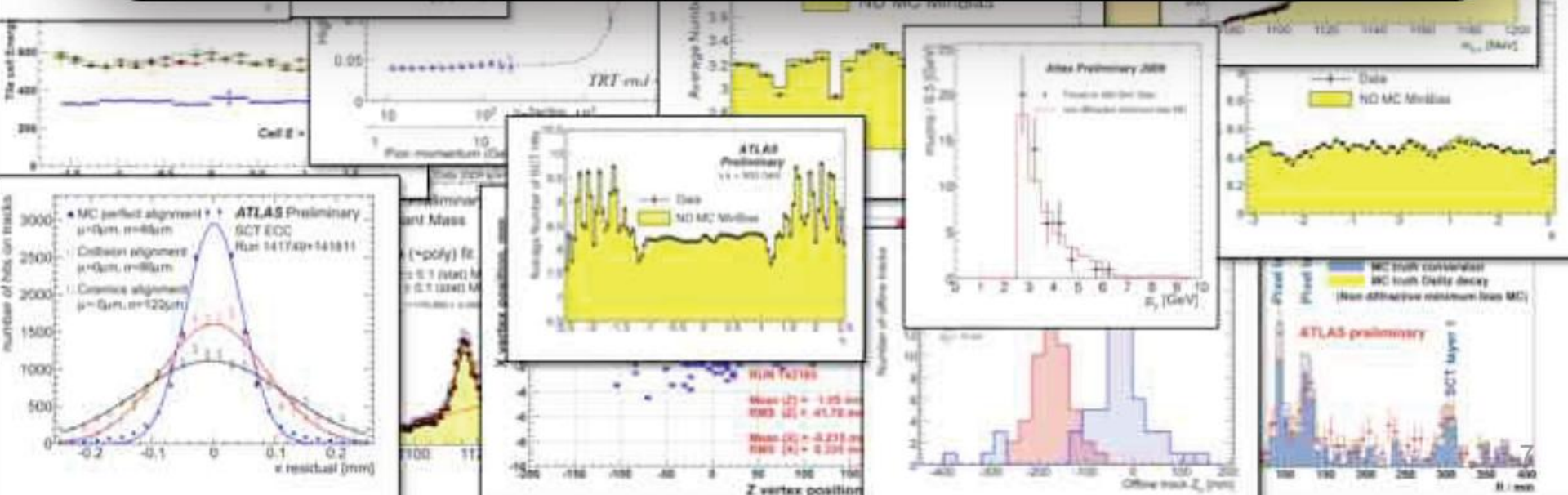

Collision Event at 7 TeV with 2 Pile Up Vertices

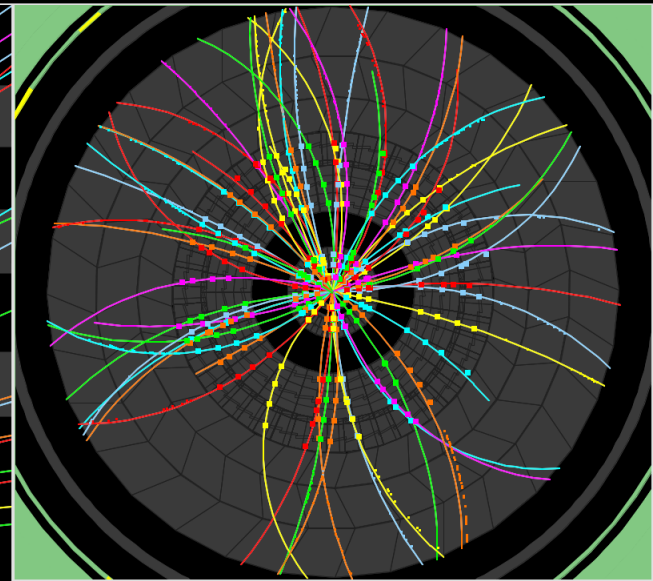
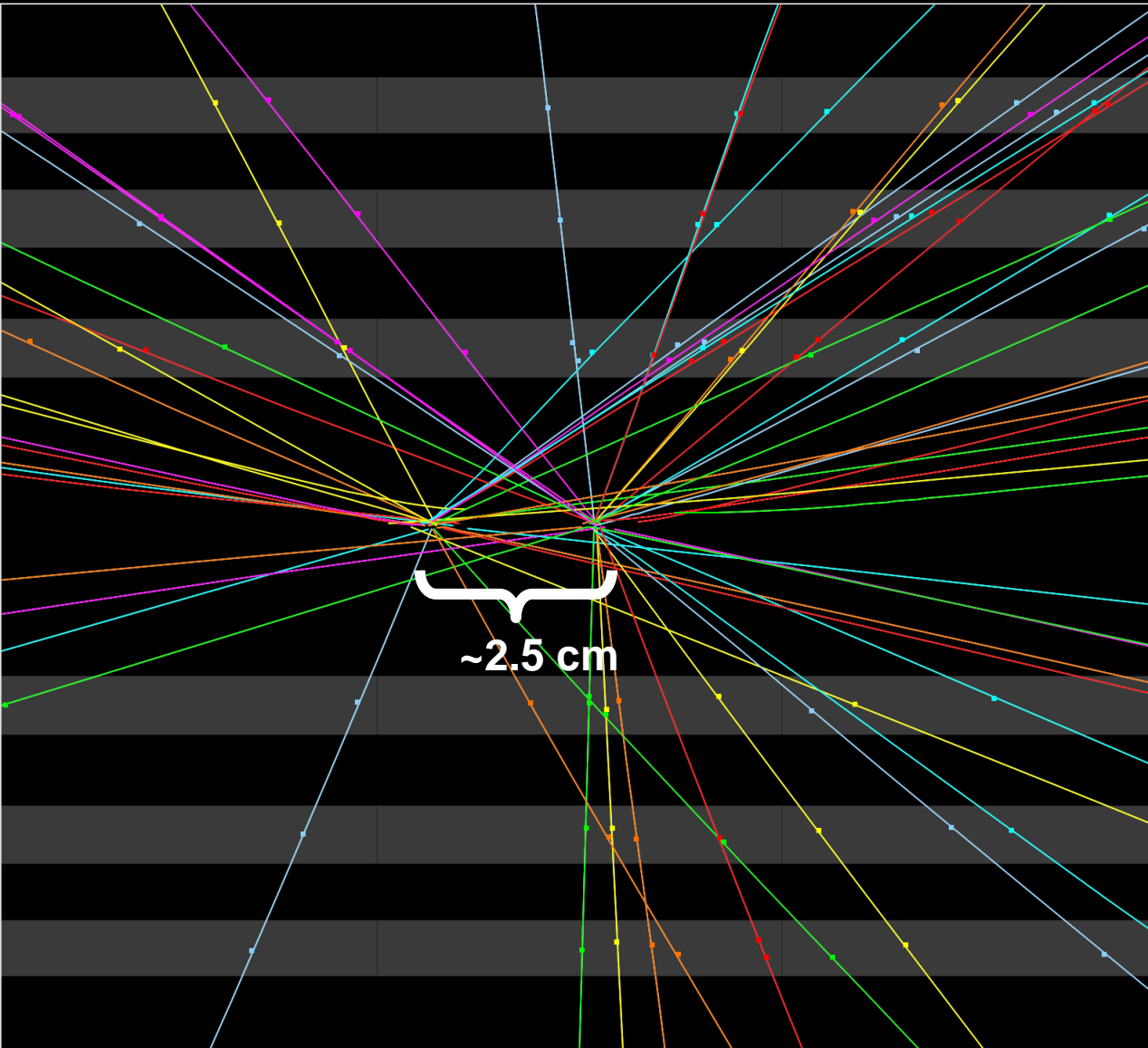

ATLAS
EXPERIMENT

Run Number: 152166, Event Number: 467774

Date: 2010-03-30 13:31:46 CEST

<http://atlas.web.cern.ch/Atlas/public/EVTDISPLAY/events.html>

Vertex resolution $75\mu\text{m}$

Charged hadron final states reconstructed with the Inner Detector

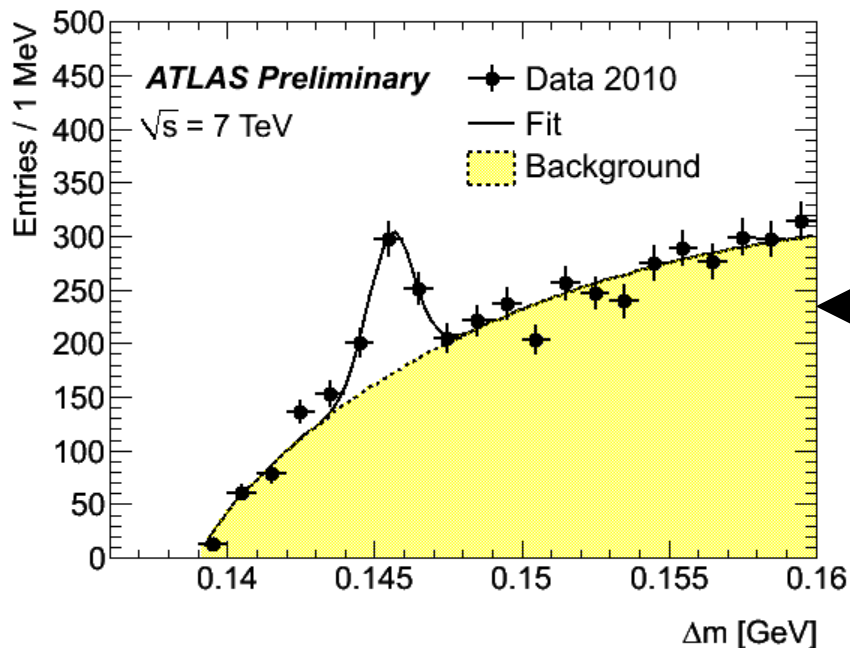
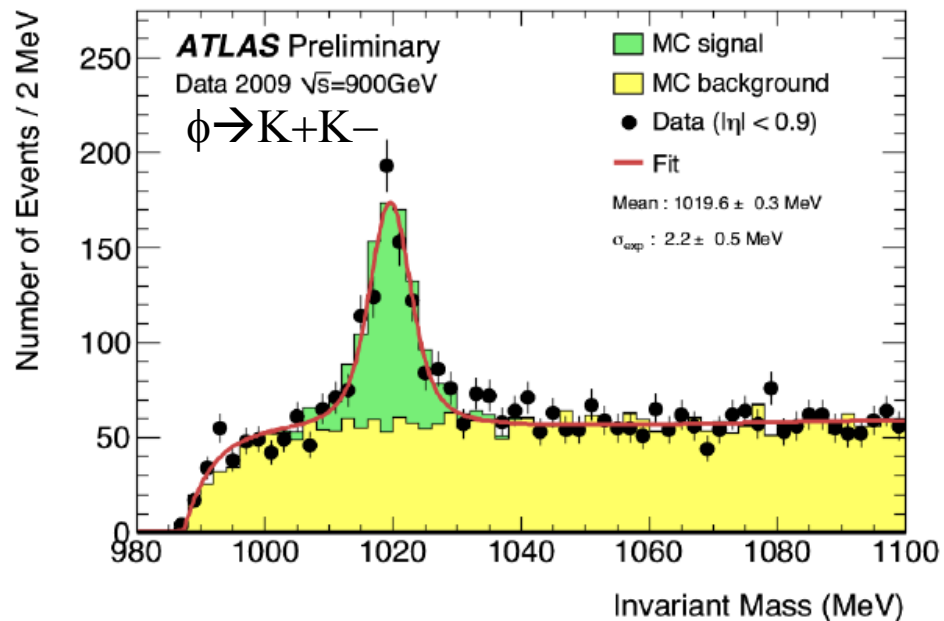
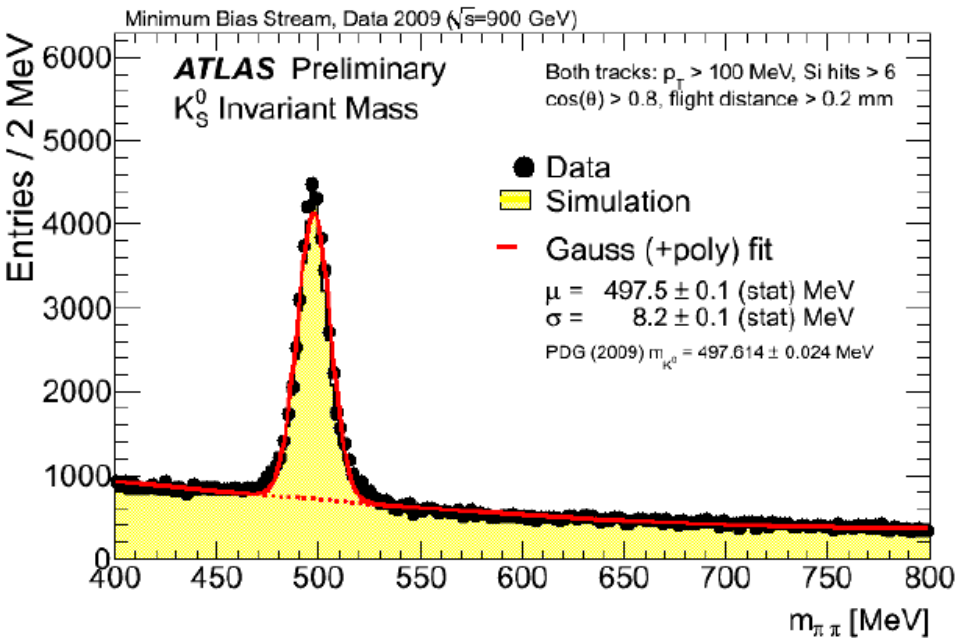

mass difference between the D^* and the $D0$ candidates in the signal region, i.e. the region where $|m(K\pi) - 1.865 \text{ GeV}| < 20 \text{ MeV}$

Photon final states reconstructed with the LAr EM calorimeter

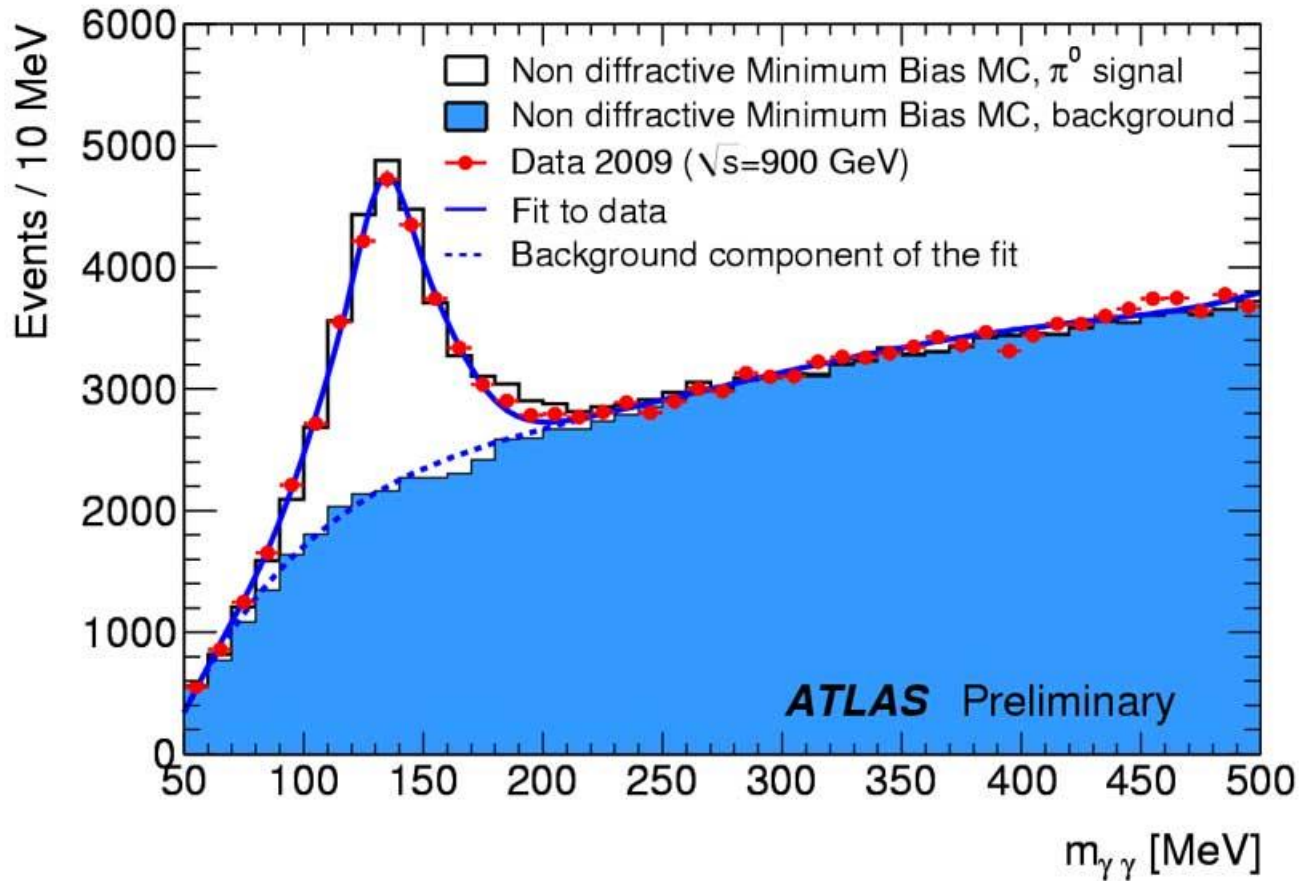

Good agreement between data and MC in all calorimetric discriminating variables suggests high degree of understanding of the detector performance.

Muon final states: J/psi with the ID and Muon spectrometer

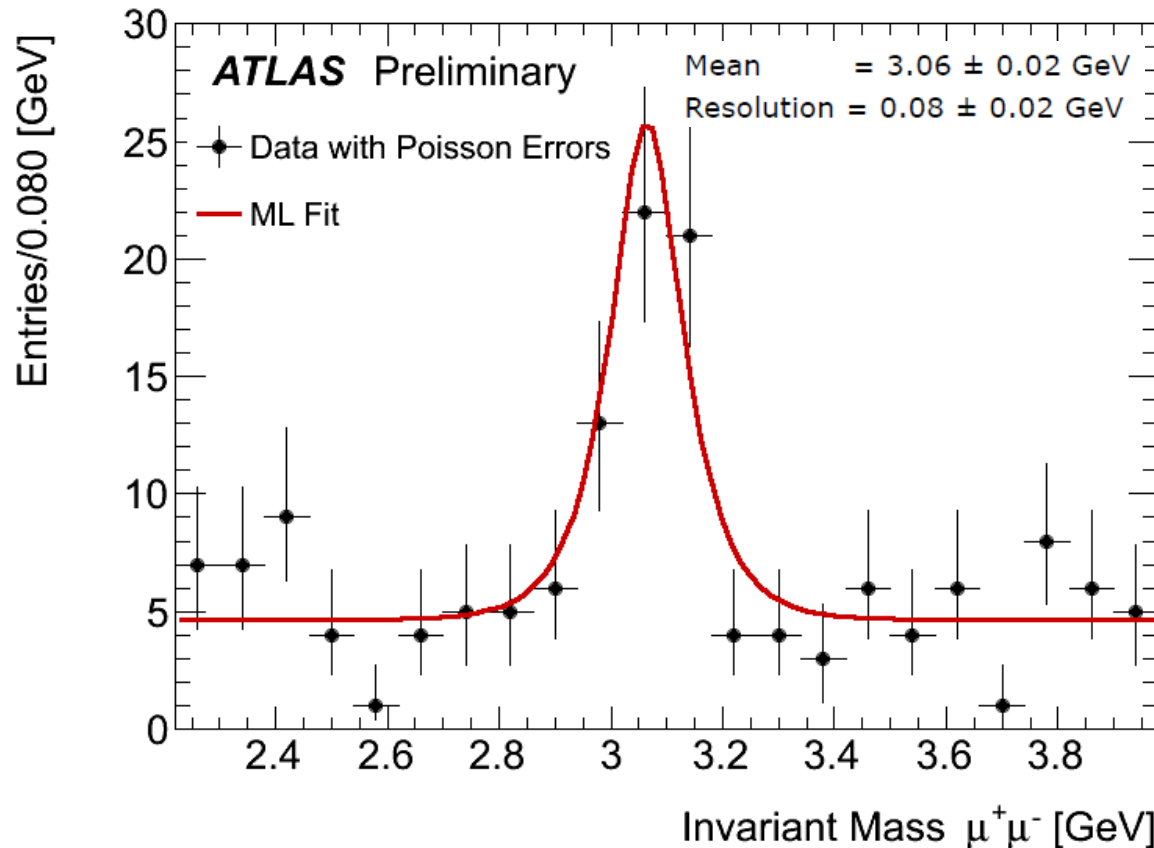

- Data for integrated luminosity $\sim 320 \mu\text{b}^{-1}$
- Select muons with $E > 3$ GeV at the IP.
- Require one muon be “combined” (matched tracks in MuonSpectrometer and ID).
- The other muon can be “combined” or “tagged” (Inner Detector track matched to segment in Muon Spectrometer).
- Perform vertex fit to two Inner Detector tracks (no mass or pointing constraint).

Inclusive Jet Et distribution at 350/ub

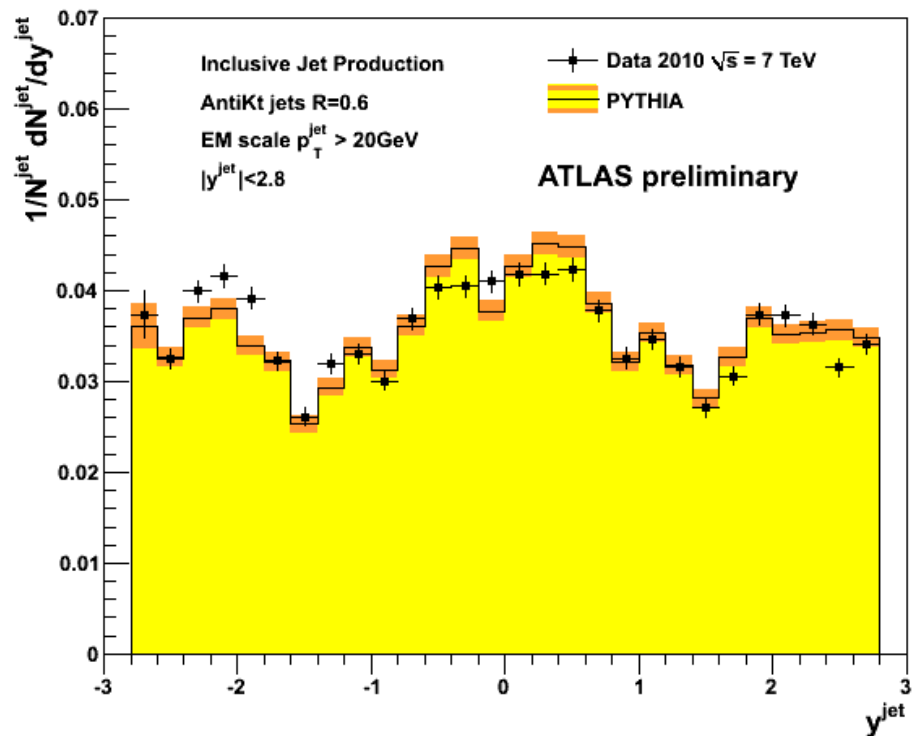
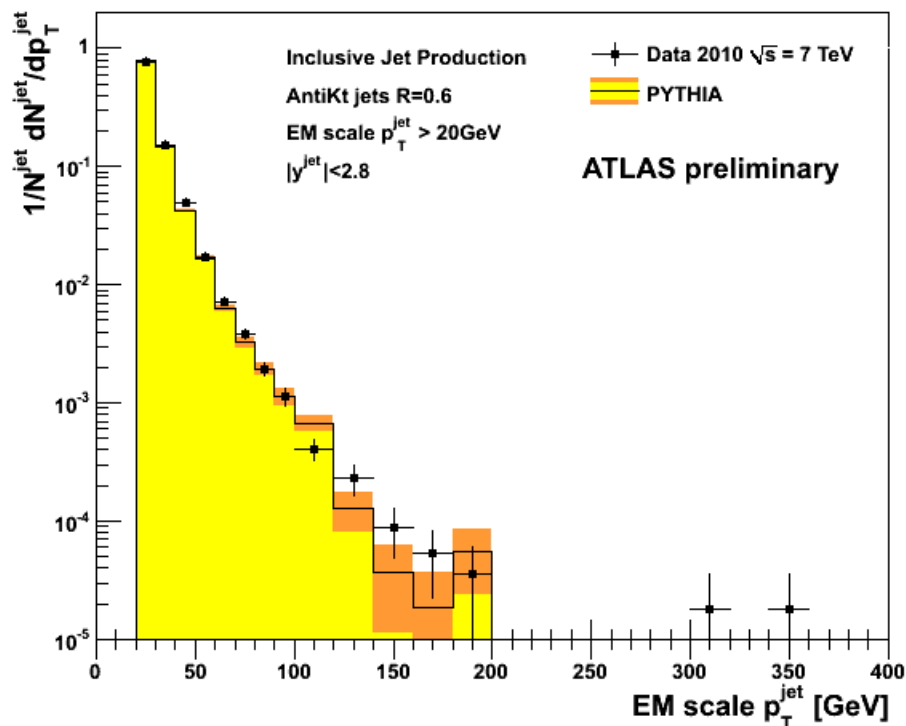

- Inclusive jet Et and rapidity as measured with the ATLAS detector. Jets are reconstructed with R=0.6 (anti-kt)
- Minimum bias triggers, approximately 350 inverse microbarns of integrated luminosity.
- No calibration is applied (uncorrected electromagnetic-scale).
- Jets are selected with rapidity $|y| < 2.8$ and with a pT cut of 20 GeV (EM-scale).
- The measurement (black dots) is compared to PYTHIA MC predictions (yellow histogram).
- Only statistical uncertainties in data (error bars) and Monte Carlo (brown areas) are considered. The distributions are normalized to the total number of jets. With this normalization, the number of jets with pT above 200 GeV predicted by the PYTHIA MC is about consistent with the 2 jets observed in the data.

Missing Et at 7 TeV

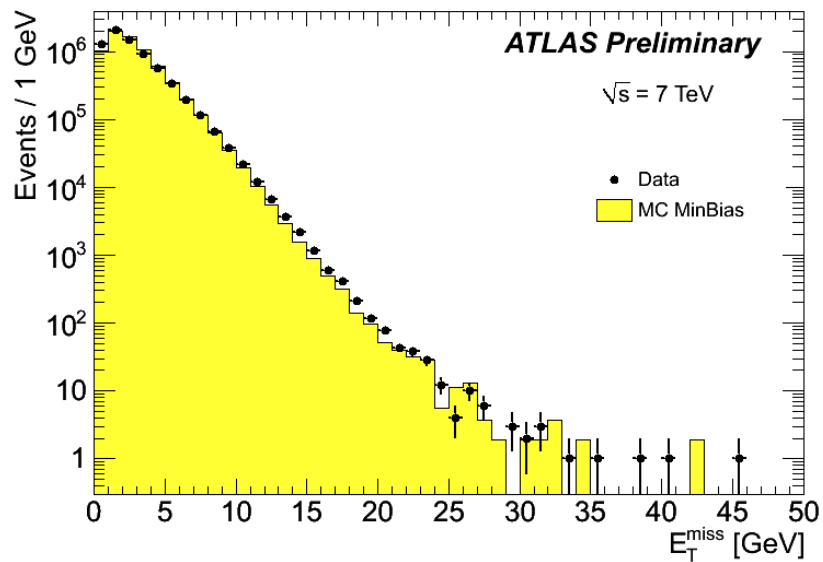

Missing ET computed using noise-suppressed clusters at EM scale, integrated luminosity of $110 \mu\text{b}^{-1}$

Specific criteria used to remove a few events with problematic detector behavior.

Excellent description over 6 orders of magnitude !

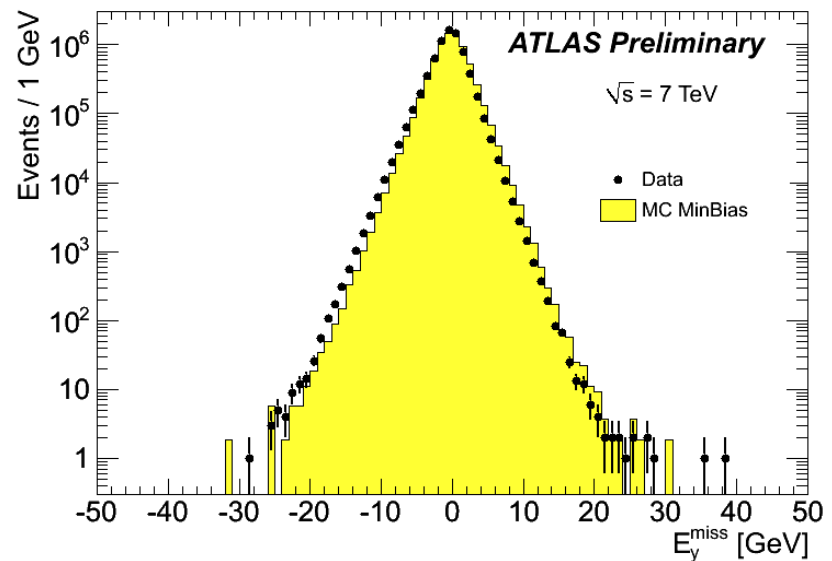
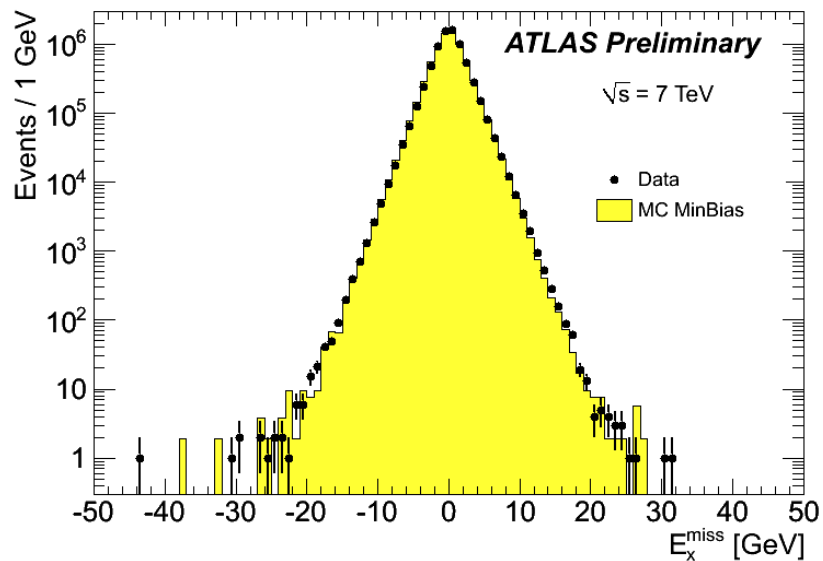

Impact parameter significance

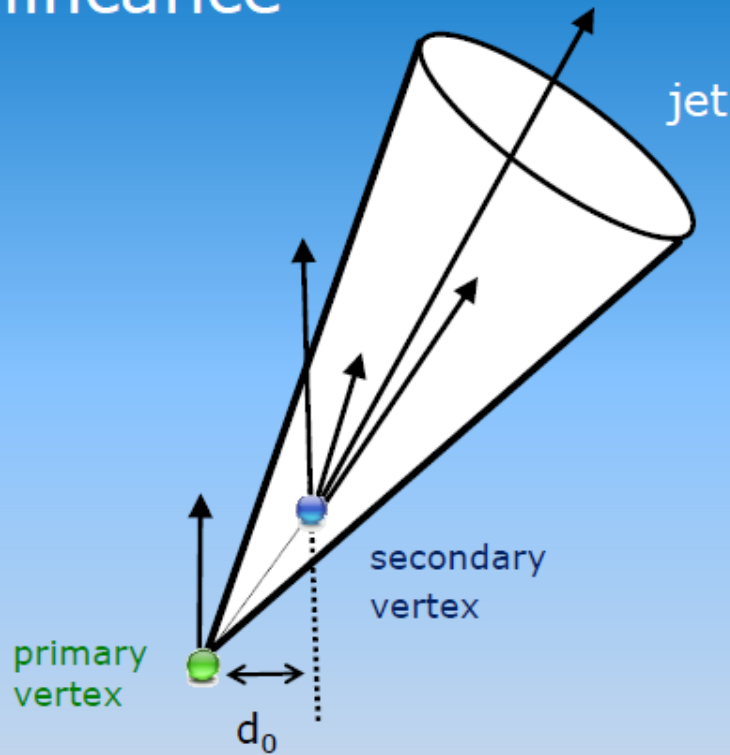

B-tagging algorithms:

- jet tracks (combined) incompatibility with originating from primary vertex
- soft lepton tagging
- secondary vertices & their properties

d_0 significance: d_0/σ_{d_0}

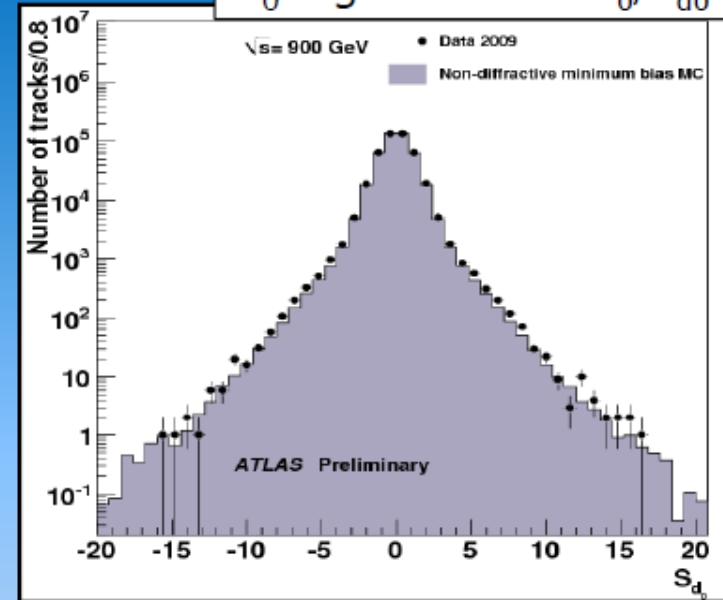

Flight length significance: L/σ_L

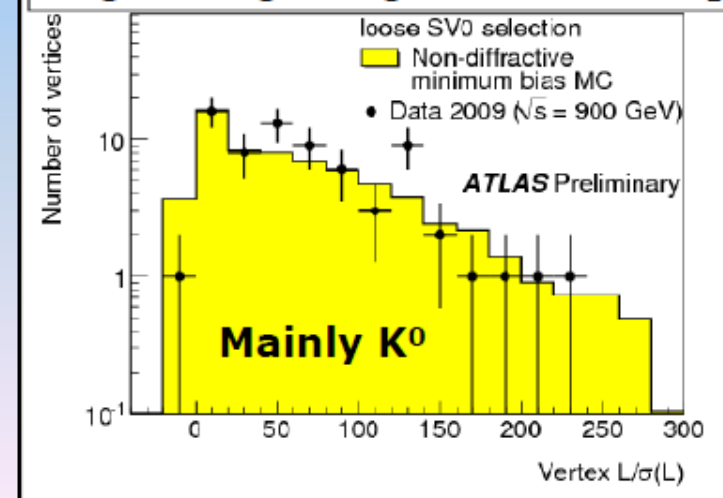

'Typical' b-jet candidate

$\sqrt{s}=7$ TeV

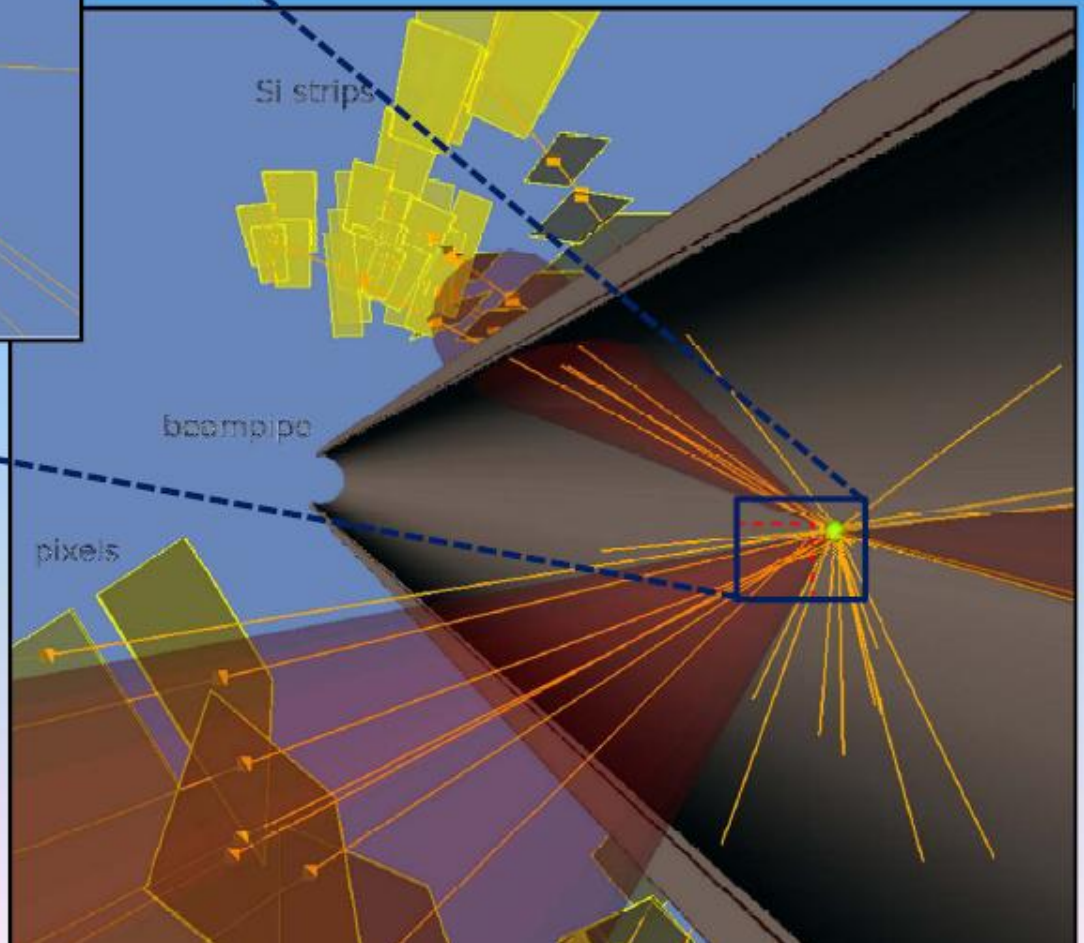
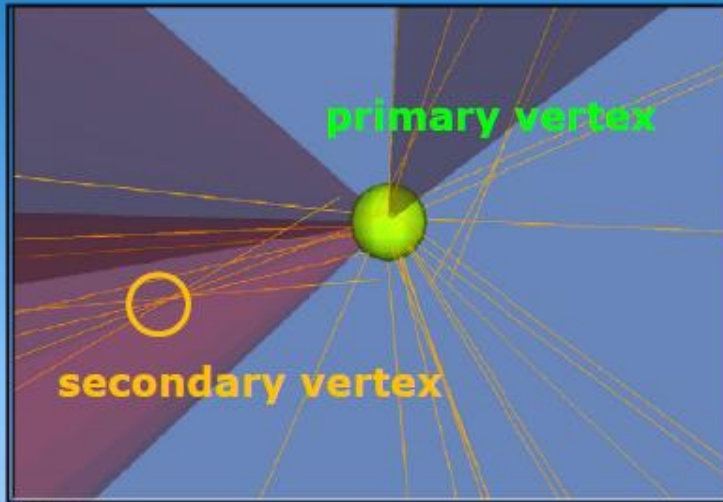

B-jet details:

- $P_T = 19$ GeV (EM scale)
- 4 b-tag quality tracks
Prob(PV compatibility) $9 \cdot 10^{-6}$
- Secondary vertex:
 - o 50 sigma in 3d away from PV
 - o Mass sec. vertex = 3.9 GeV

Minimum Bias pp events at $\sqrt{s} = 0.9$ and 7 TeV

Basic selections:

- Primary vertex found
- at least one good track, i.e.
 - a. $p_T > 500$ MeV
 - b. close to primary vertex, i.e.
 - $|d_0| < 1.5$ mm,
 - $|z_0^* \sin \phi| < 1.5$ mm
 - c. $|\eta| < 2.5$
 - d. $> (1 \text{ pixel hit} + 6 \text{ SCT hits})$

Based on (#nb events/luminosities)

Basic philosophy:

- As much as possible detector performance/corrections from data
 - no corrections for physics models
 - comparison with models and tunes
- ➔ Distribution of pile-up events + understanding of underlying event

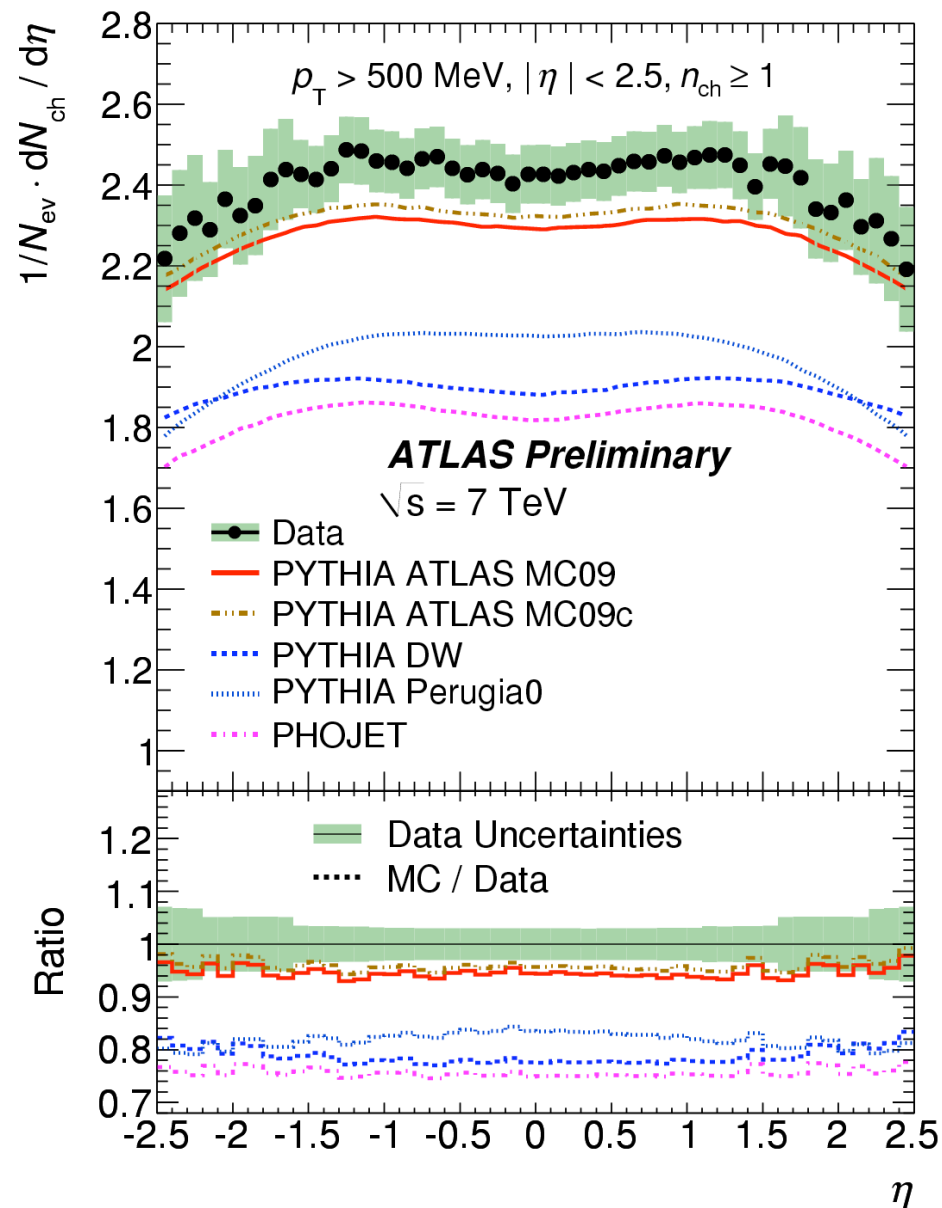

All tunes/models under-predict data yields

Charged-particle multiplicities in pp interactions at $\sqrt{s} = 0.9$ and 7 TeV

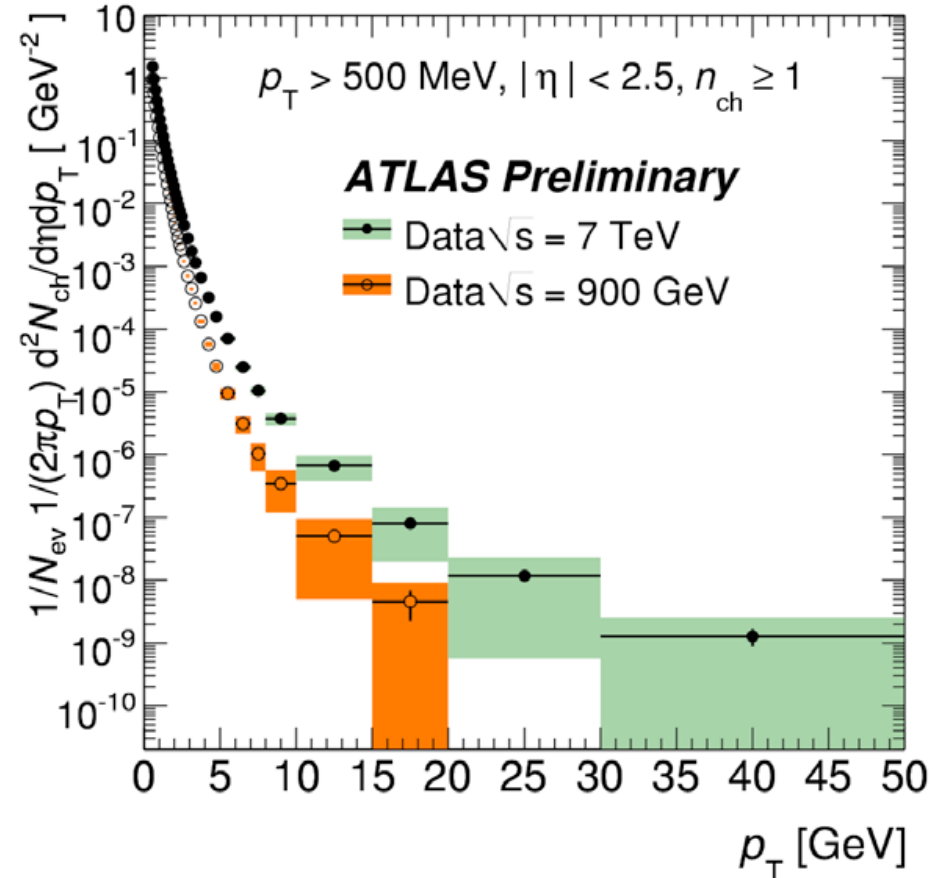
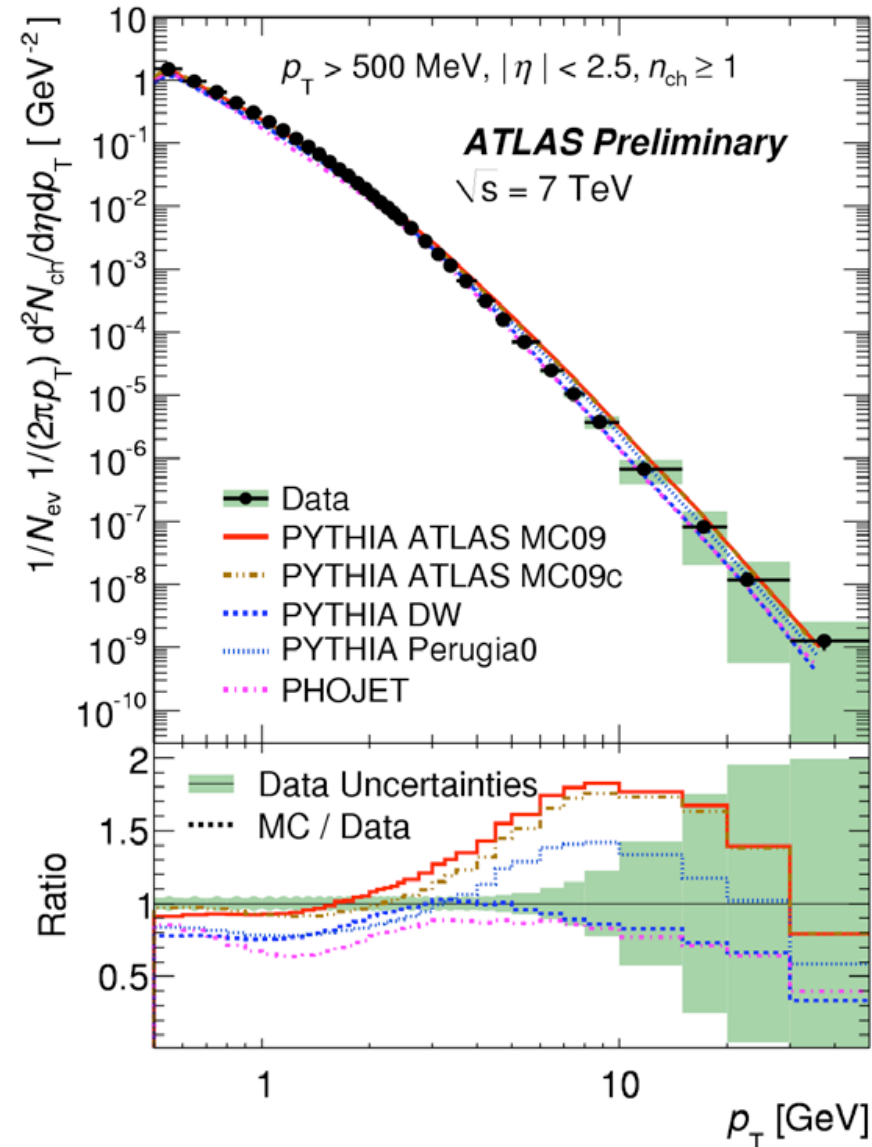

Charged-particle momenta for events with $n_{\text{ch}} \geq 1$ within the kinematic range $p_T > 500 \text{ MeV}$ and $|\eta| < 2.5$ at $\sqrt{s} = 7 \text{ TeV}$ compared to MC predictions (left) and to the published results at $\sqrt{s} = 900 \text{ GeV}$ (right [PLB 688,1,21-42](#)).

MC shows significant excess in several GeV momentum range, also seen at 900 GeV. Large impact on modeling rate for low PT objects (EM clusters, muons, jets) in data.

Charged-particle multiplicities in pp interactions at $\sqrt{s}=0.9$ and 7 TeV

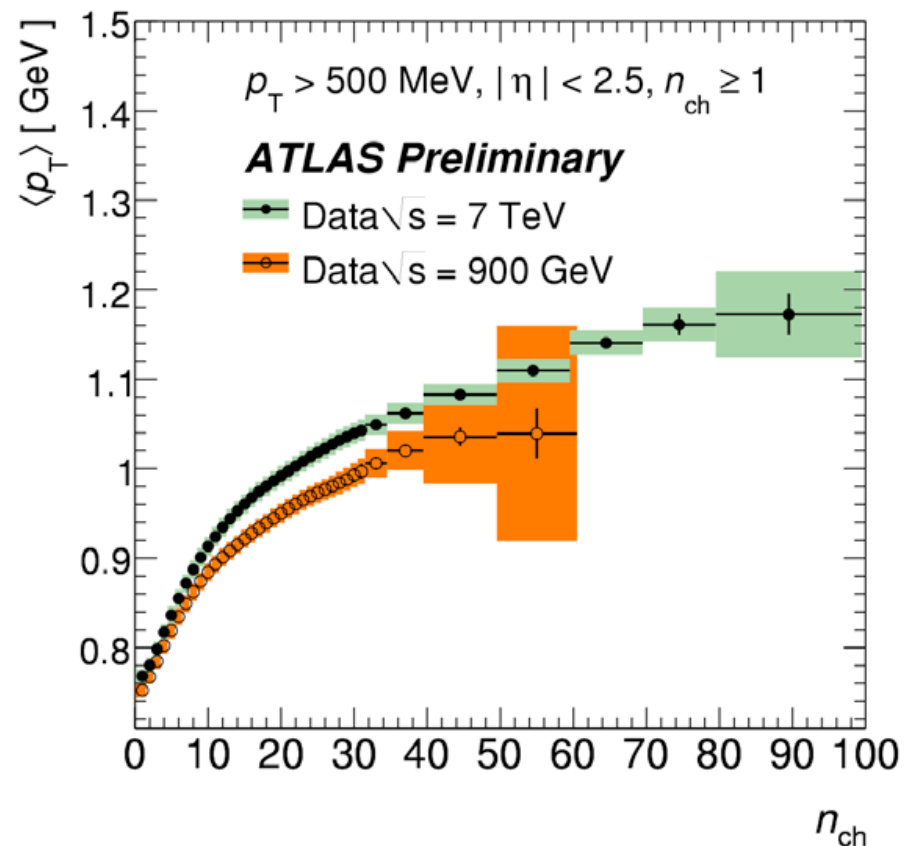
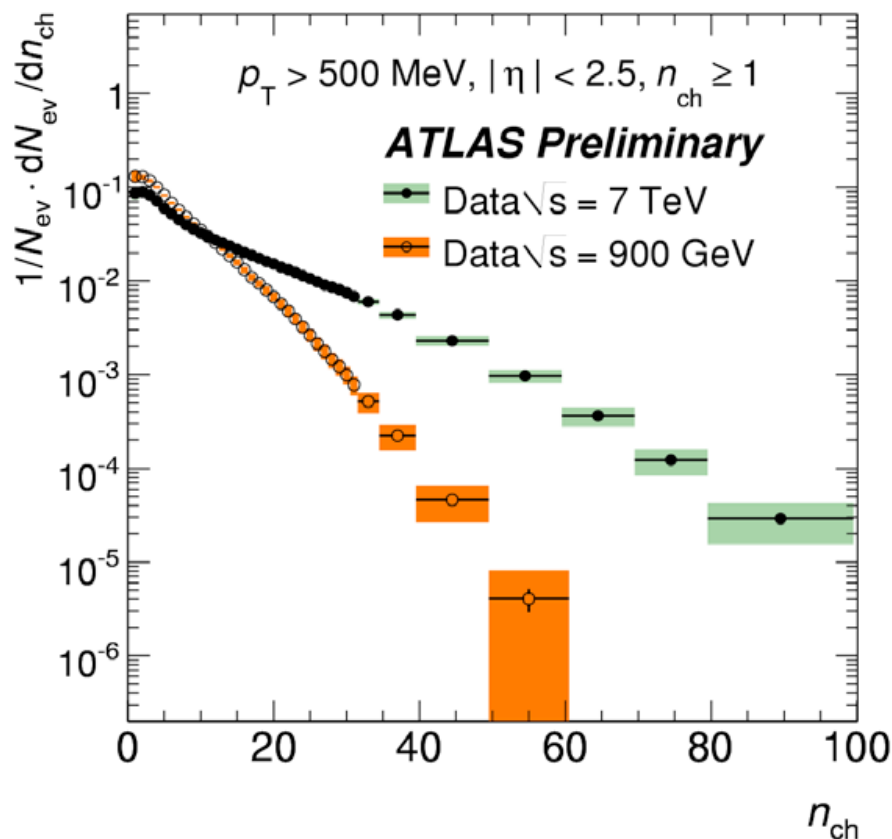

Charged-particle multiplicities for events with $n_{ch} \geq 1$ within the kinematic range $p_T > 500$ MeV and $|\eta| < 2.5$ at $\sqrt{s} = 7$ TeV compared to the published results at $\sqrt{s} = 900$ GeV. The panels compare the charged-particle multiplicities as a function of the charged-particle multiplicity (left), and the average transverse momentum as a function of the number of charged particles in the event (right).

Next step: perform the data analysis reducing the minimum track p_T to 100 MeV. 18

Observation of $W \rightarrow e\nu, \mu\nu$ candidates

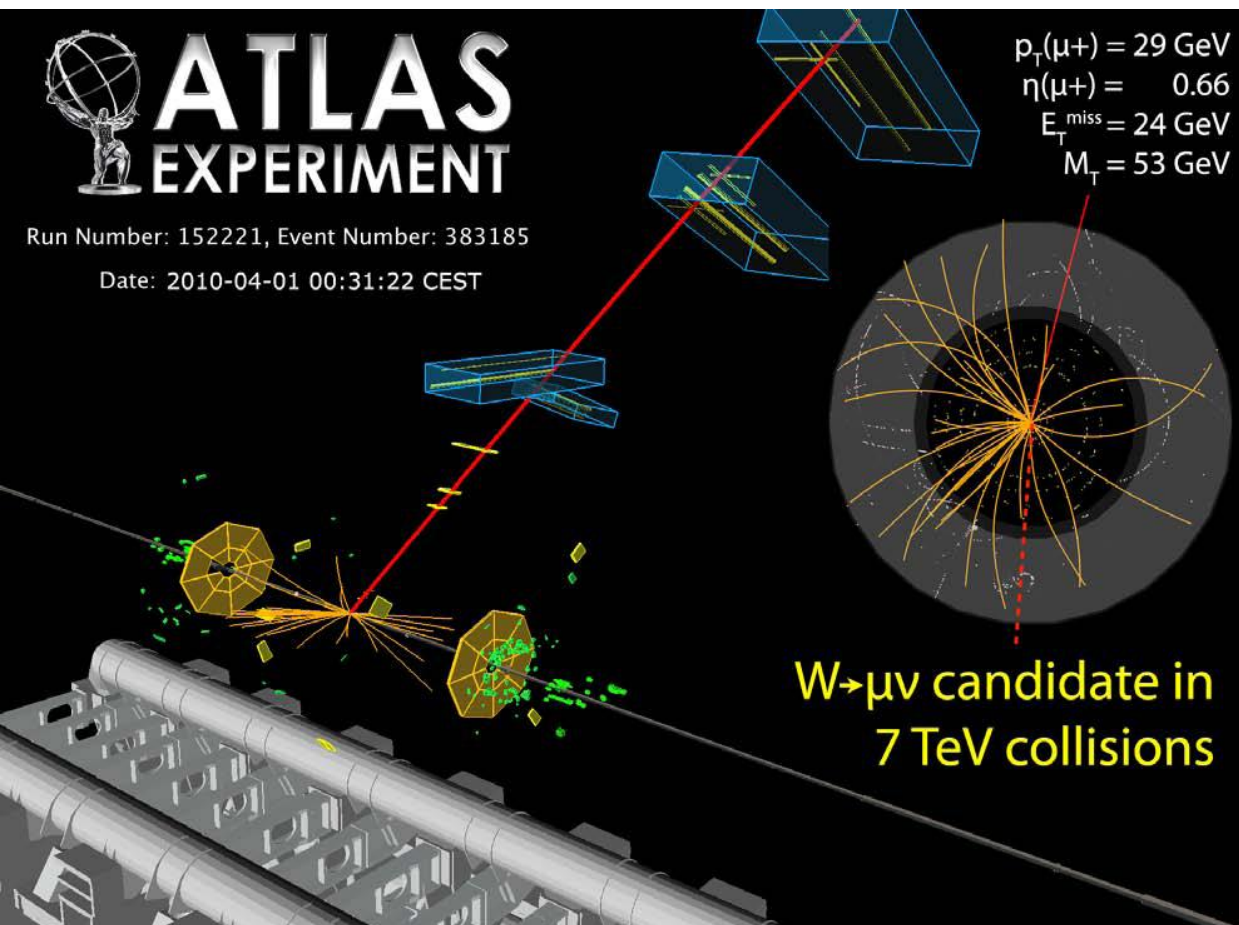

Now have observed about 30 candidate events.

This rate is consistent with SM expectations.

Properties of all events under intense study.

Optimization of event selection and background rejection are in progress.

Observation paper is in preparation.

$W \rightarrow e\nu$ candidate

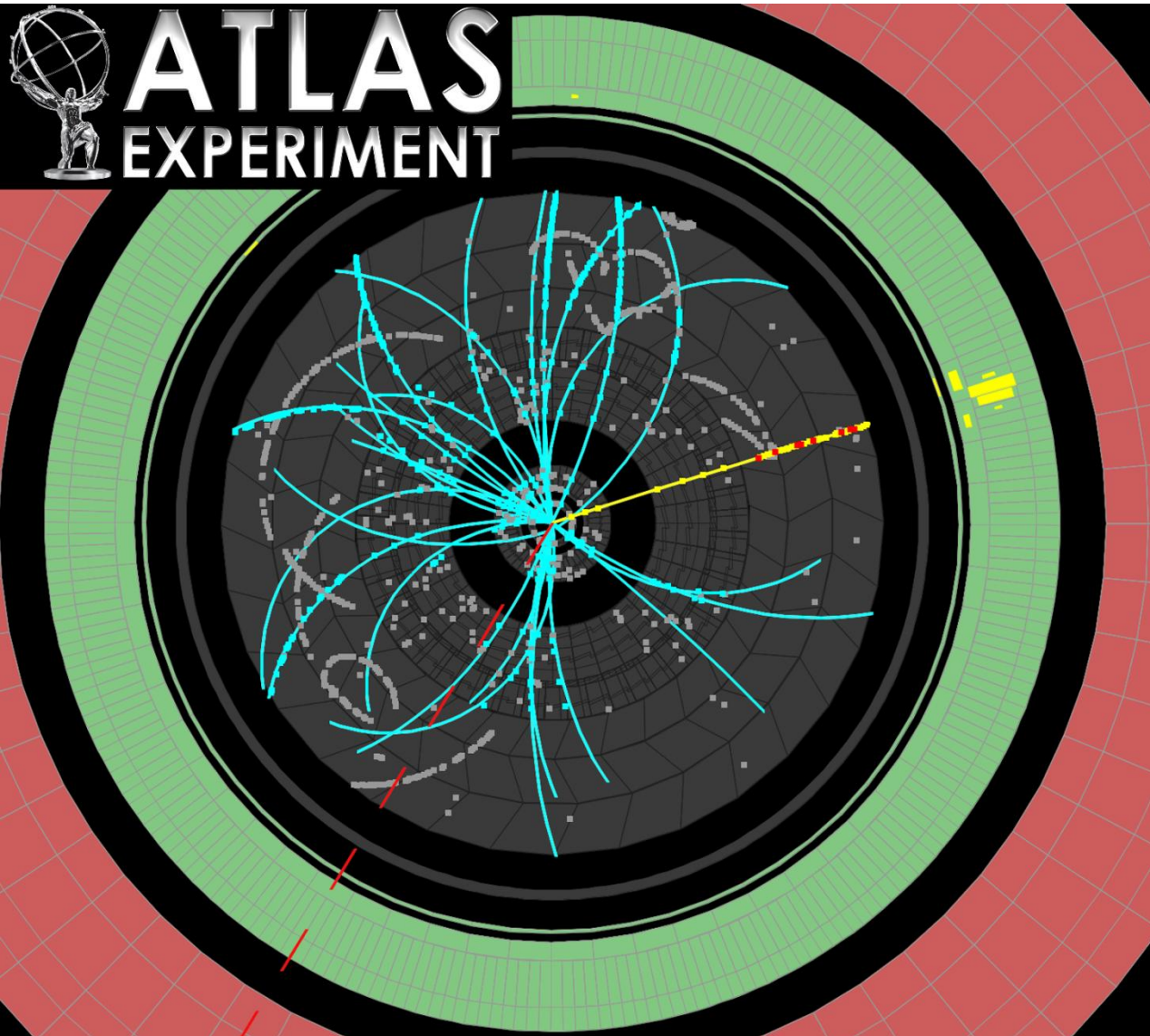

Run Number: 152409, Event Number: 5966801

Date: 2010-04-05 06:54:50 CEST

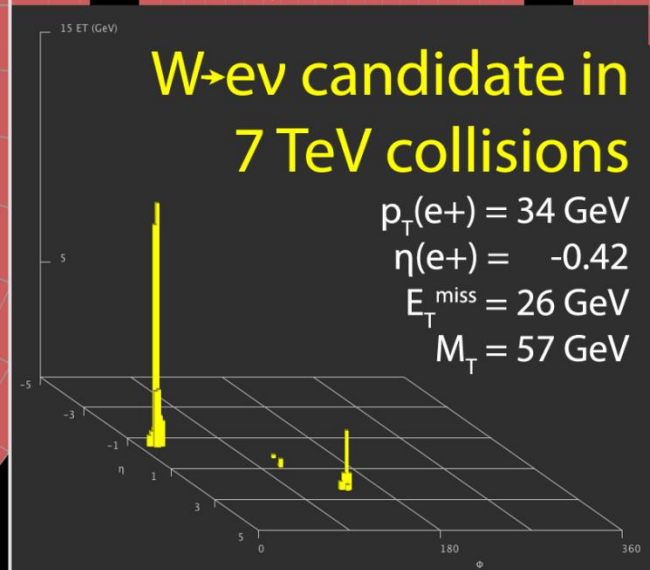
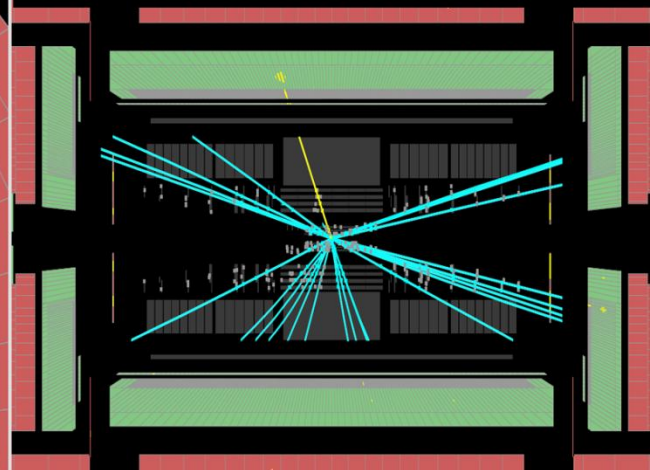

Collision Event at 7 TeV with Muon Candidate

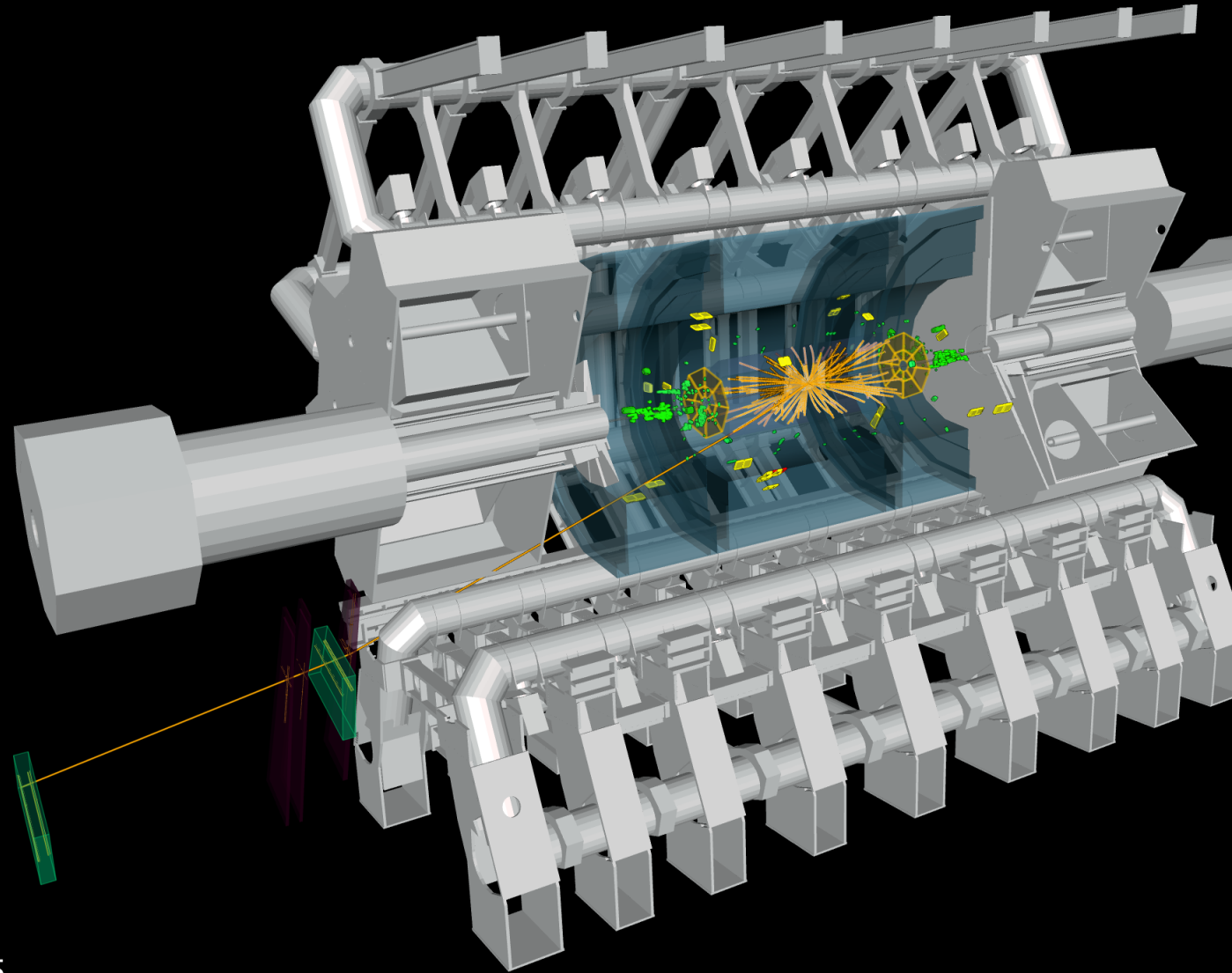
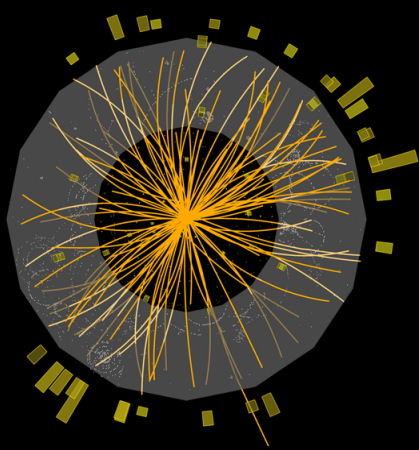

 **ATLAS**
EXPERIMENT

2010-03-30, 12:59 CEST
Run 152166, Event 322215

<http://atlas.web.cern.ch/Atlas/public/EVTDISPLAY/events.html>

Z → ee candidate



Run Number: 154817, Event Number: 968871

Date: 2010-05-09 09:41:40 CEST

$M_{ee} = 89 \text{ GeV}$

Z → ee candidate in 7 TeV collisions

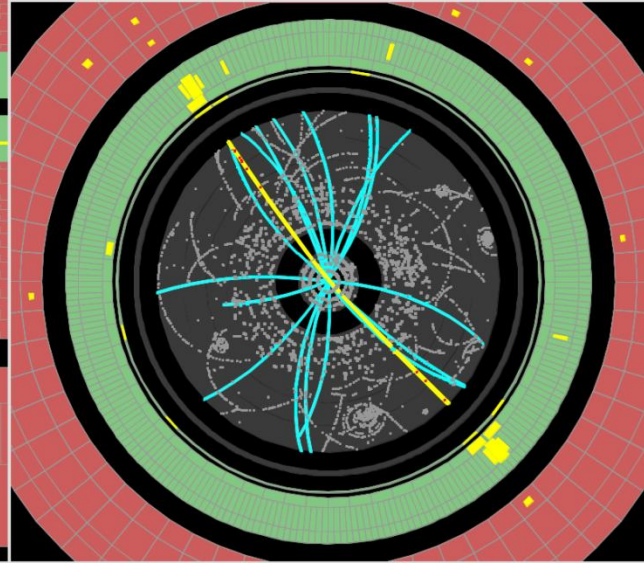
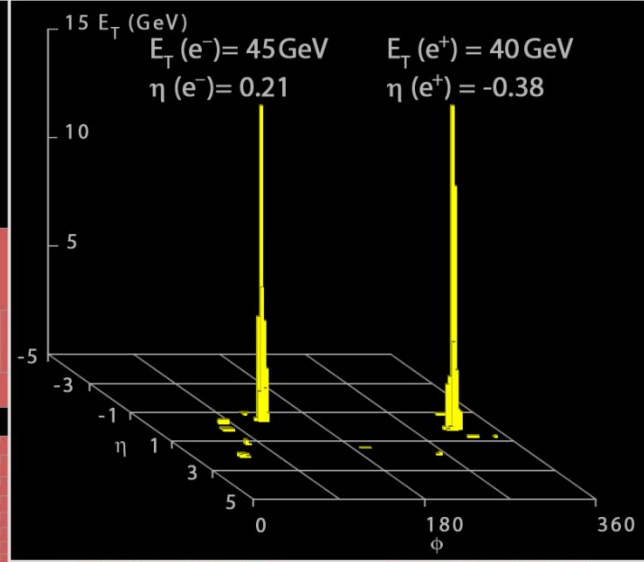
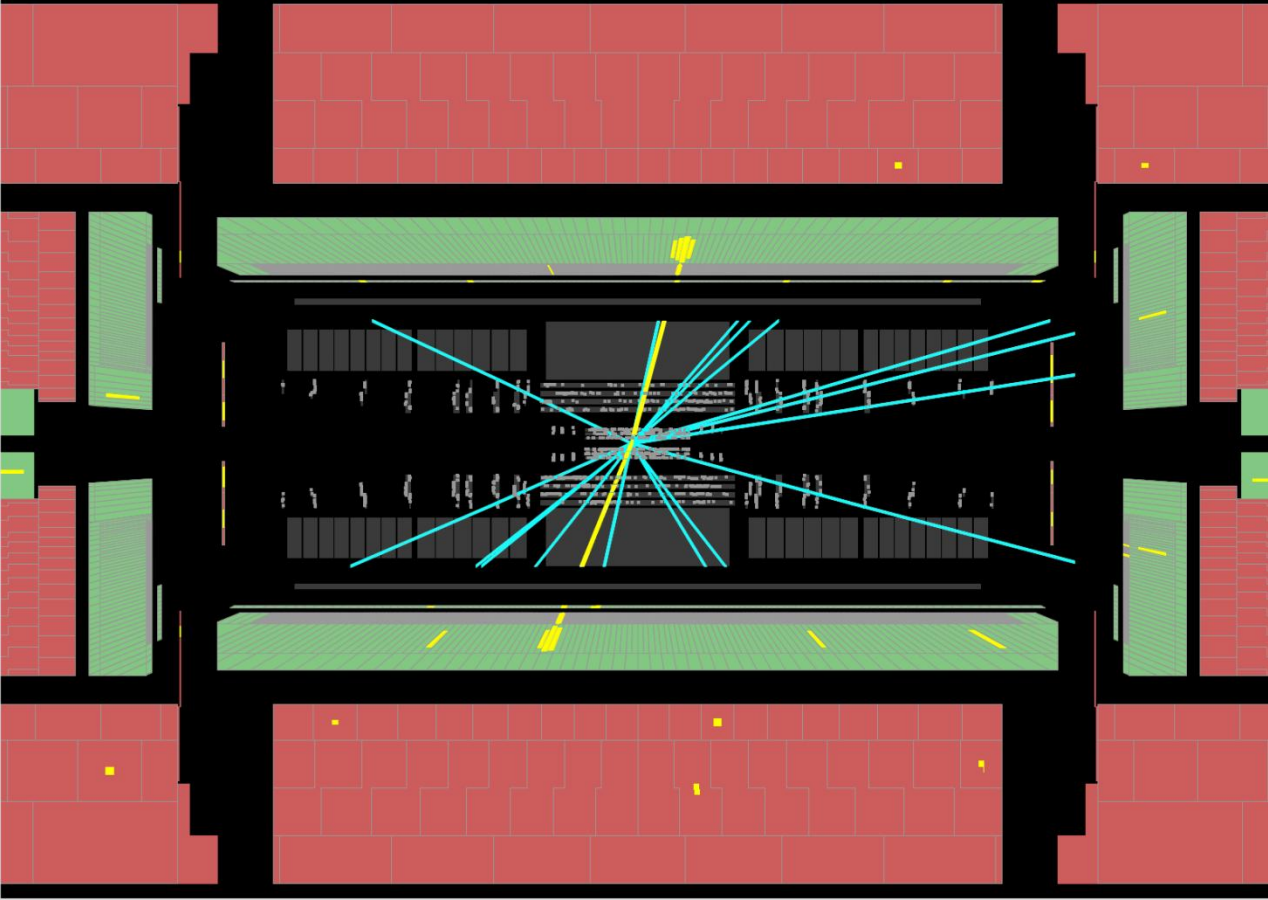

Expected physics reach with 1fb^{-1}

In 2010/11 we expect to record up to 1fb^{-1} of integrated luminosity at 7 TeV

Standard Model

- $W \rightarrow l + \nu$ (4M events)
- $Z \rightarrow ll$ (400k)
- $t\bar{t} \rightarrow l + \text{jets}$ (6k)
- $t\bar{t}$ dilepton (2.5k)

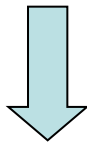

Detector Commissioning
Std Model measurements

Discovery Potential

- Susy 5σ discovery above Tevatron limit with a few 100pb^{-1}
- $Z' \rightarrow \mu\mu$: sensitive up to 1.5TeV
- Higgs: 3σ evidence in the mass range 145-180GeV

Conclusions

- ATLAS detector commissioning with 7 TeV data is ongoing.
- All detectors are performing remarkably well.
 - First 15 nb⁻¹ of recorded luminosity.
 - Inner detector commissioned by reconstructing charged leptons/hadrons, and composites (conversions, Ksh, phi, D,D*,Lambdas and more).
 - LAr EM and ID are providing photons, electrons and W's, with all discriminating variables consistent with expectations from MC.
 - Hadronic calorimeters are providing Jets and EtMiss in accordance with MC expectation.
 - ID and Muon-spectrometer have recorded the first J/psi's and W's.
 - First Z candidates have also been recorded.
- We expect to record up to 1fb⁻¹ in 2010/2011.
- ATLAS is ready for physics with high luminosity runs.

Back-up

Missing Et Resolution

- ATLAS 2009 collision data: Minimum bias triggers.
- Resolution of the two components of the missing transverse energy as a function of the total sum of the transverse energy at centre-of-mass energy of 2.36 TeV.
- Overlaid earlier data at 900 GeV and a fit to the MC simulation.
- no calibration is applied (uncorrected electromagnetic scale = EM scale).

