

HIGGS PRECISION PHYSICS AT THE LHC

.....
Amplitudes in the LHC era
GGI, Florence Oct. 29th 2018
Lorenzo Tancredi - CERN TH

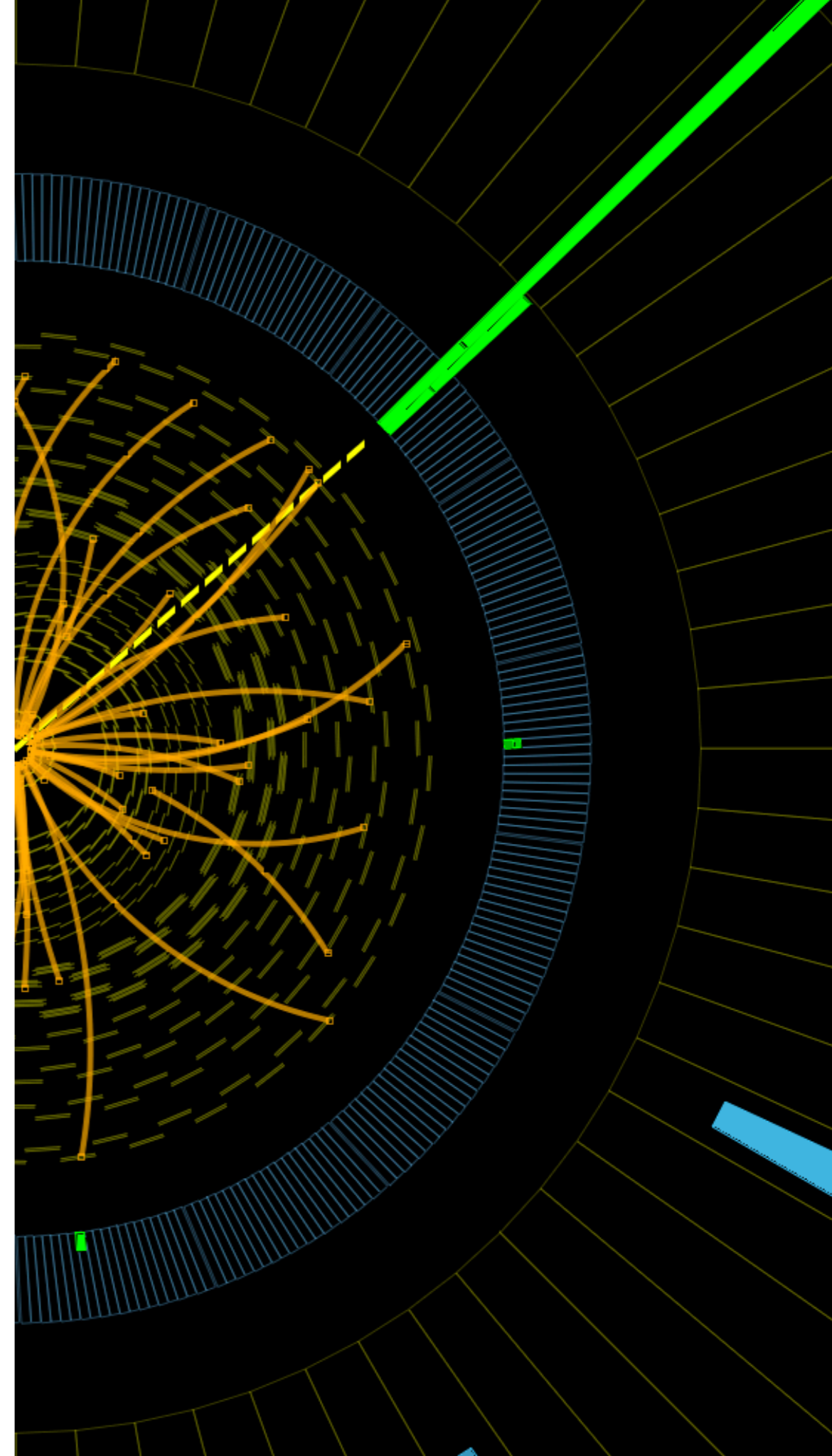

INTRODUCTION: WHY THE HIGGS?

Higgs discovery has opened a new chapter in particle physics

The SM is far from being understood!

INTRODUCTION: WHY THE HIGGS?

Higgs discovery has opened a new chapter in particle physics

The SM is far from being understood!



Being able to **MODEL** something
doesn't mean to **UNDERSTAND** it!



Details of SSB mechanism? **Higgs potential**? Vacuum stability?
Origin of **masses** and **hierarchy** (why *up quark* lighter than *down quark*?...)

INTRODUCTION: WHY THE LHC?

The LHC is the first machine able to probe this energy scale!

First direct observation of H coupling to quarks, $t\bar{t}bH$ @ LHC

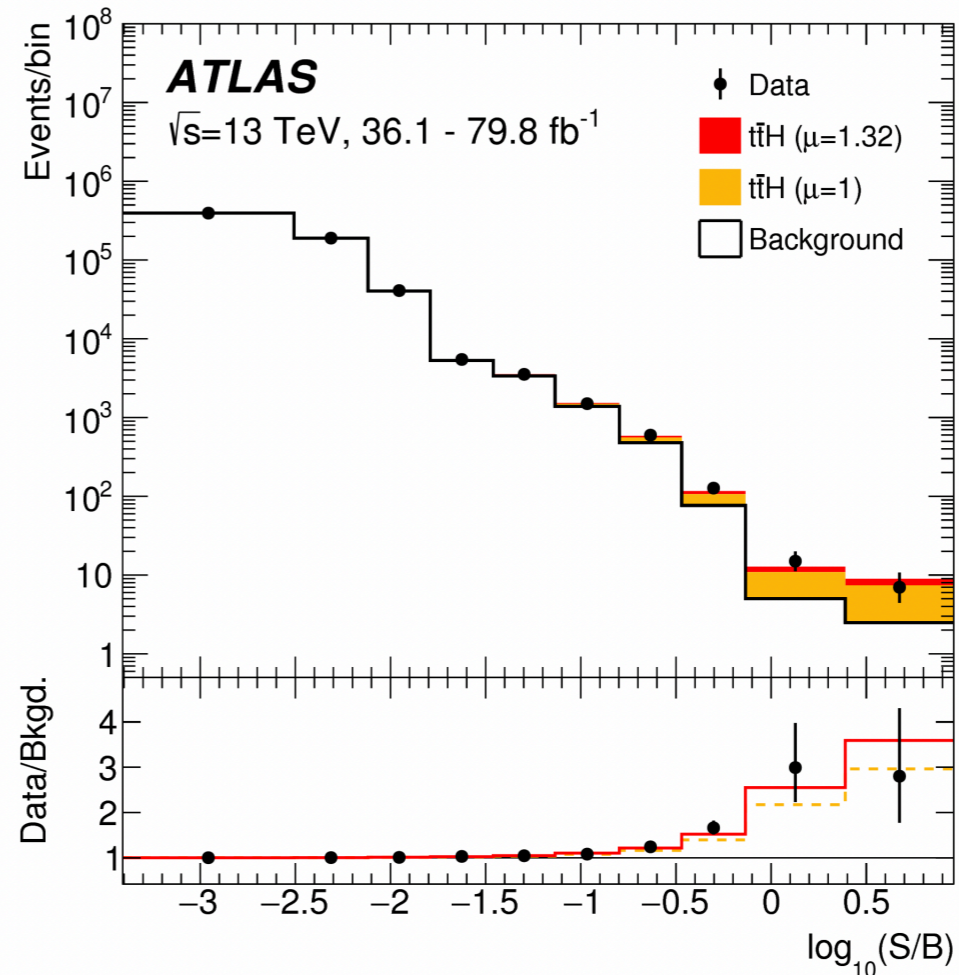
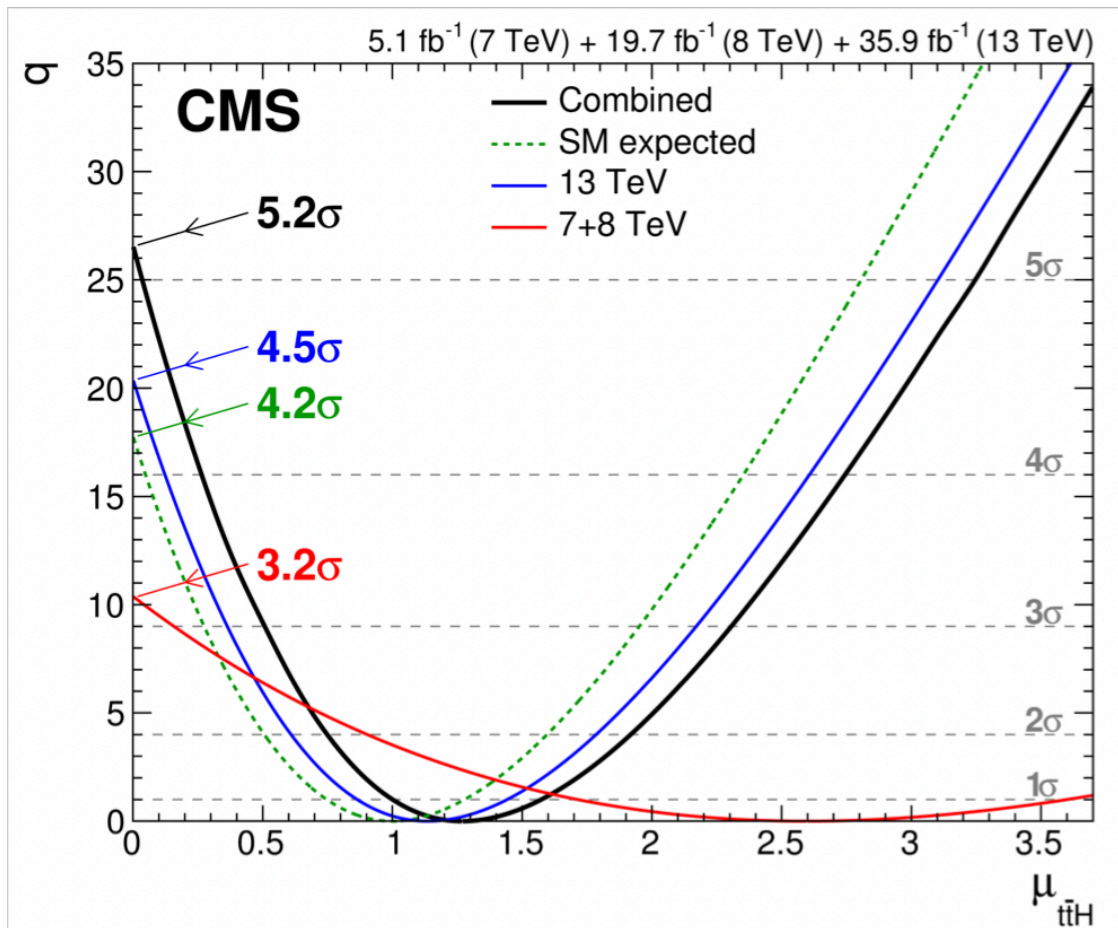
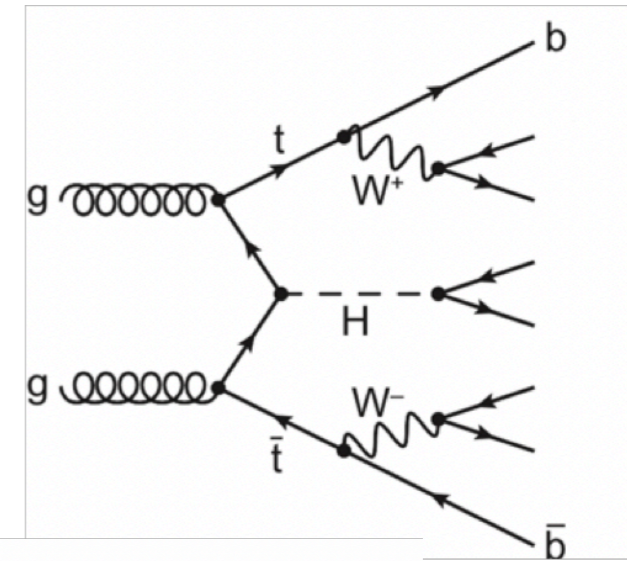

INTRODUCTION: WHY PRECISION?

Without precision, new physics would be everywhere

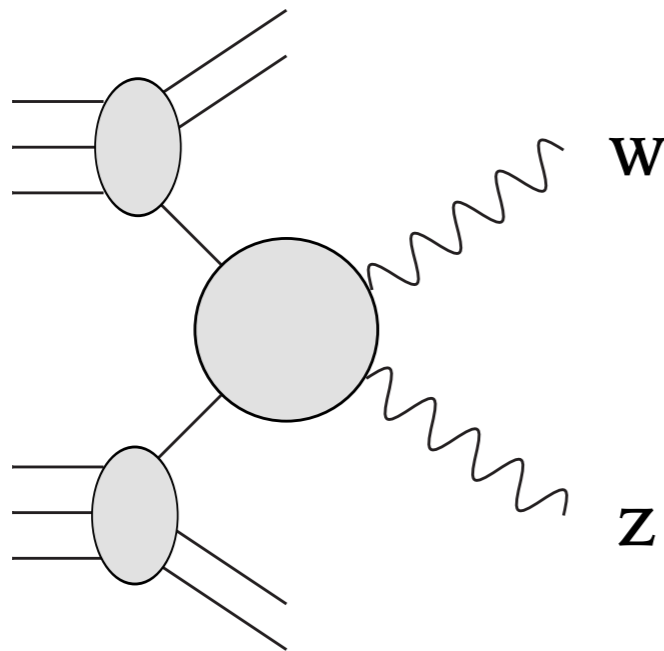

[ATLAS Phys. Lett. B 762 (2016) 1]

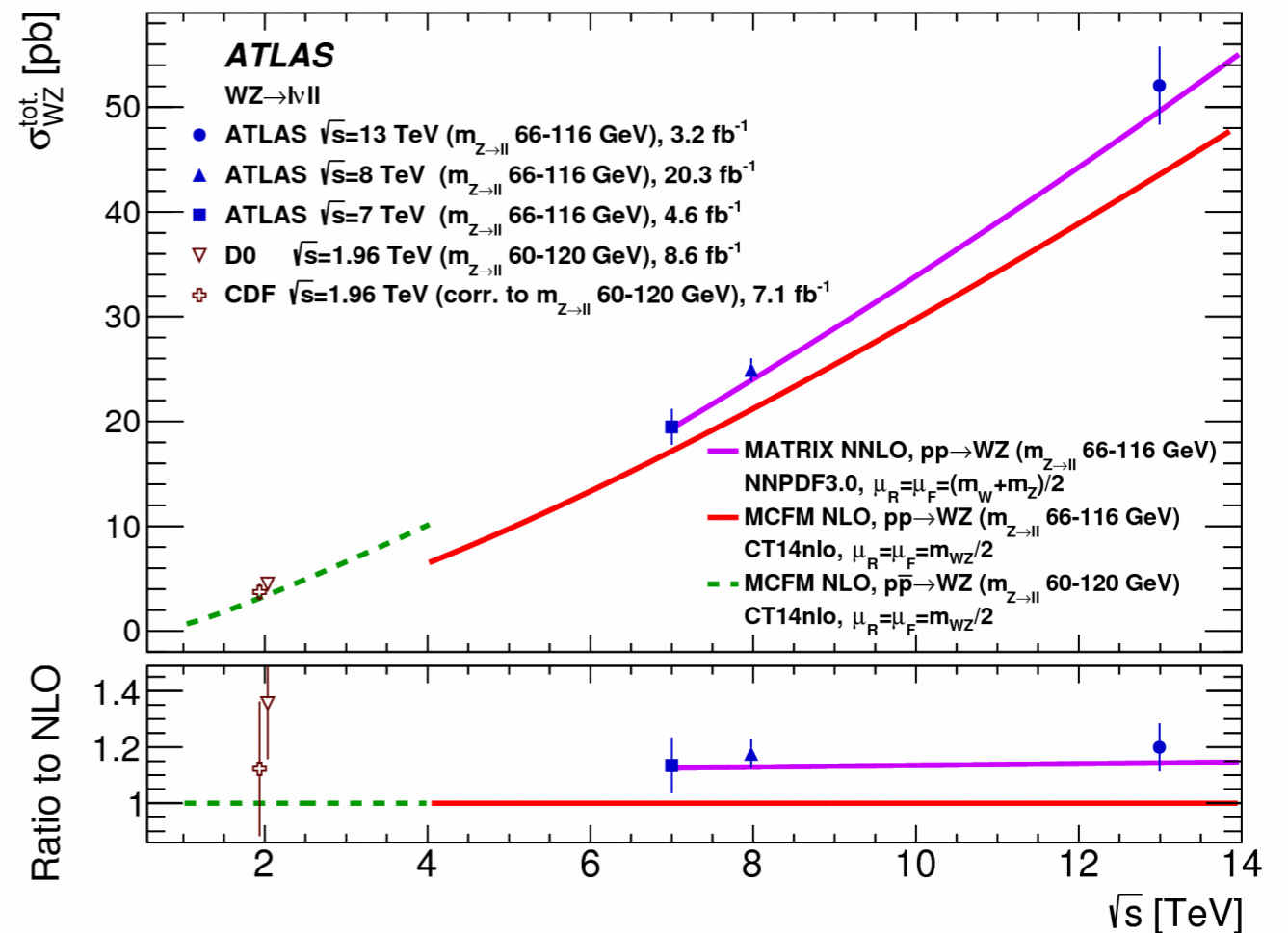

Higher order corrections are essential to describe properly the data!

PRECISION QCD @ LHC: WHAT AND HOW

Precision @ the LHC, means (mainly) precision in QCD, in a very dirty environment!
How precise can we hope to get?

$$pp \rightarrow HX \rightarrow l_1 \bar{l}_1 + l_2 \bar{l}_2 + X$$

PRECISION QCD @ LHC: WHAT AND HOW

Precision @ the LHC, means (mainly) precision in QCD, in a very dirty environment!
How precise can we hope to get?

$$pp \rightarrow HX \rightarrow l_1 \bar{l}_1 + l_2 \bar{l}_2 + X$$

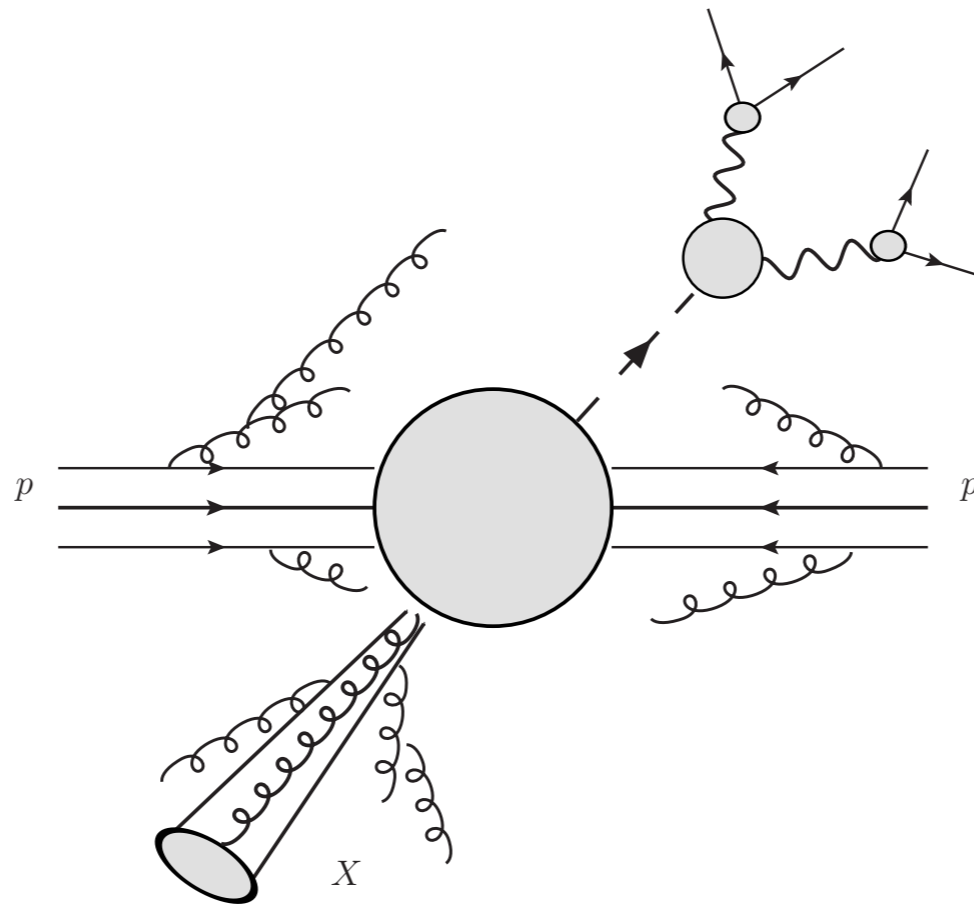

PRECISION QCD @ LHC: WHAT AND HOW

Precision @ the LHC, means (mainly) precision in QCD, in a very dirty environment!
How precise can we hope to get?

Factorisation of long and short range physics

Non perturbative corrections

$$\mathcal{O}\left(\frac{\Lambda_{QCD}}{Q}\right) \sim \text{few percent?}$$

$$pp \rightarrow HX \rightarrow l_1\bar{l}_1 + l_2\bar{l}_2 + X$$

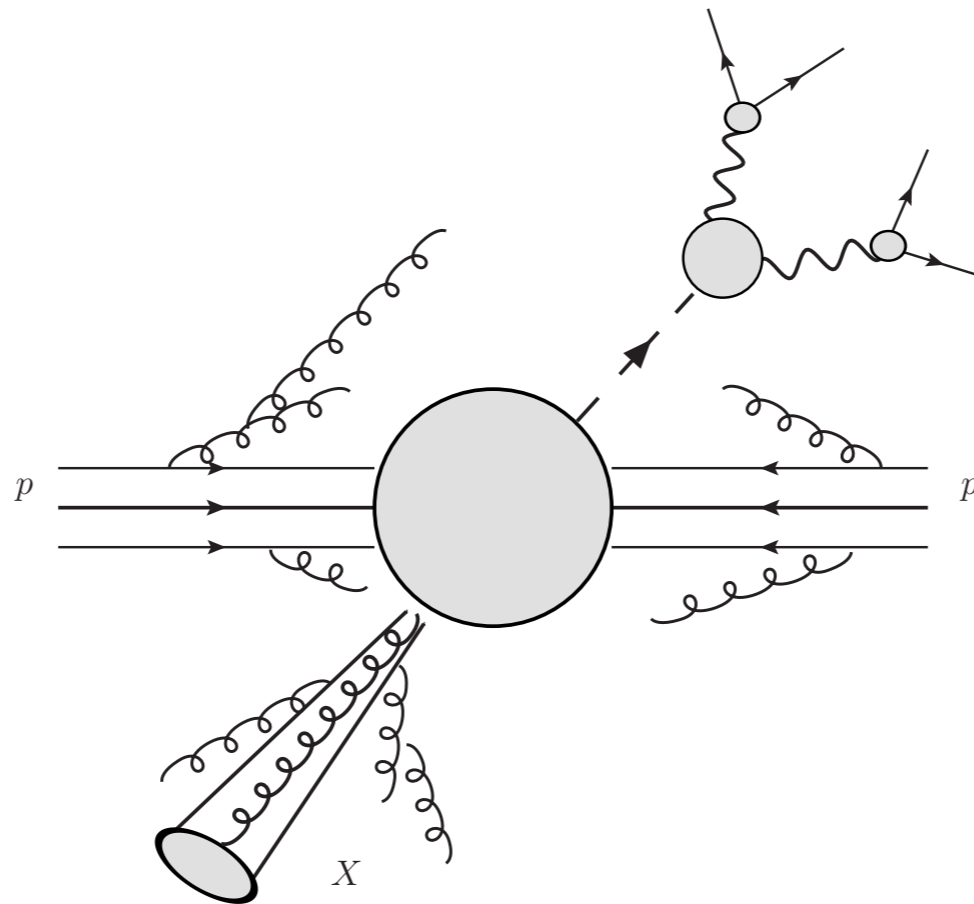

PRECISION QCD @ LHC: WHAT AND HOW

Precision @ the LHC, means (mainly) precision in QCD, in a very dirty environment!
How precise can we hope to get?

Factorisation of long and short range physics

Non perturbative corrections

$$\mathcal{O}\left(\frac{\Lambda_{QCD}}{Q}\right) \sim \text{few percent?}$$

$$pp \rightarrow HX \rightarrow l_1\bar{l}_1 + l_2\bar{l}_2 + X$$

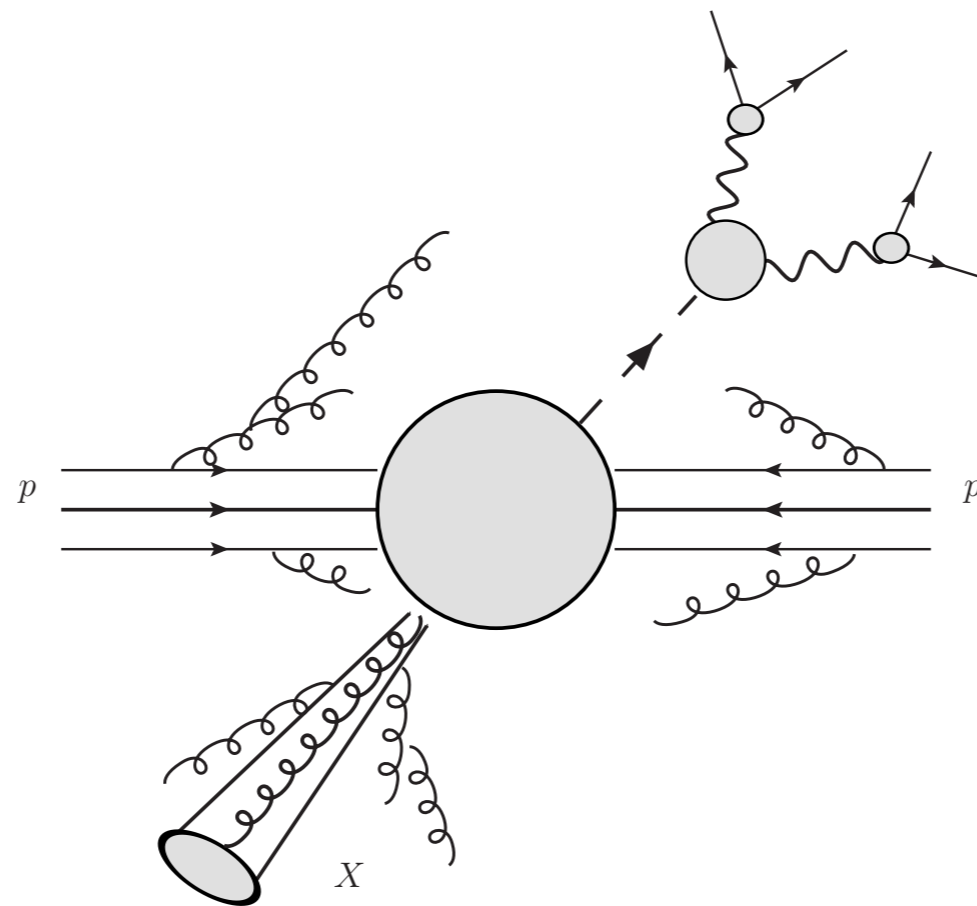

Precise determination of parton content of proton

PDFs Currently known at level ~ **few % for LHC**

PRECISION QCD @ LHC: WHAT AND HOW

Precision @ the LHC, means (mainly) precision in QCD, in a very dirty environment!
How precise can we hope to get?

Factorisation of long and short range physics

Non perturbative corrections

$$\mathcal{O}\left(\frac{\Lambda_{QCD}}{Q}\right) \sim \text{few percent?}$$

$$pp \rightarrow HX \rightarrow l_1\bar{l}_1 + l_2\bar{l}_2 + X$$

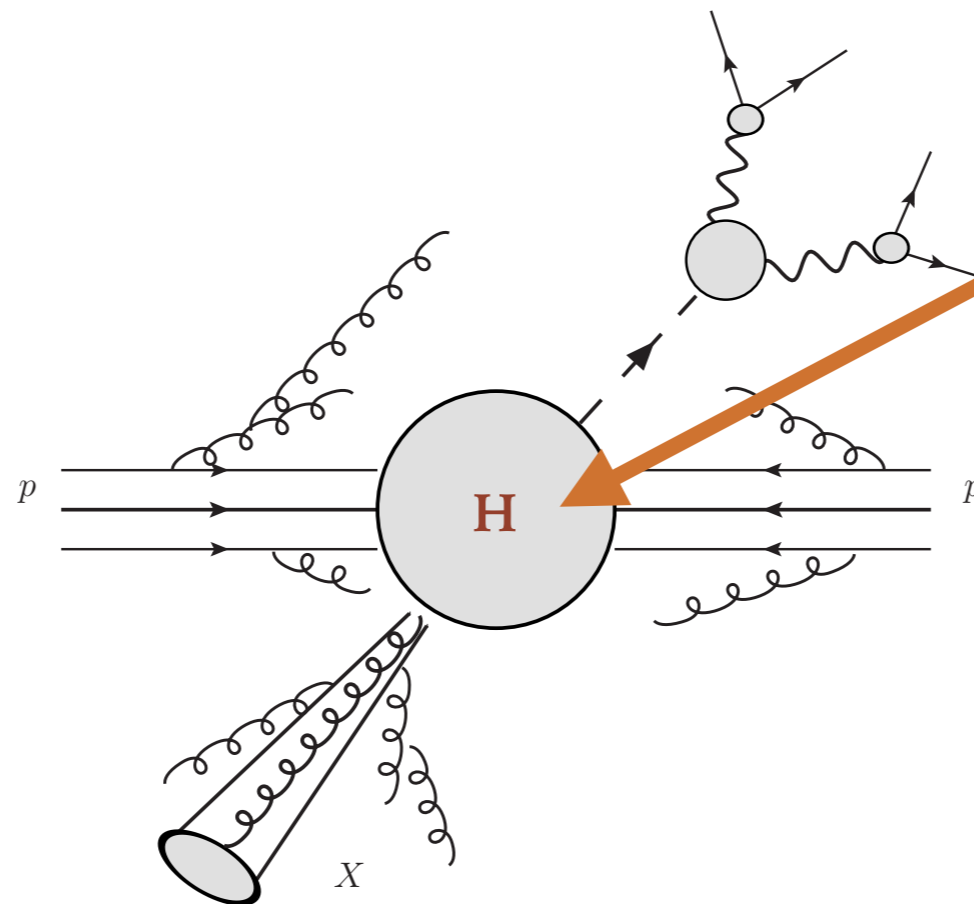

Hard scattering process
Aim to ~ few % precision

Precise determination of parton content of proton
PDFs Currently known at level ~ **few % for LHC**

HIGGS PRODUCTION AND DECAYS

Production channels

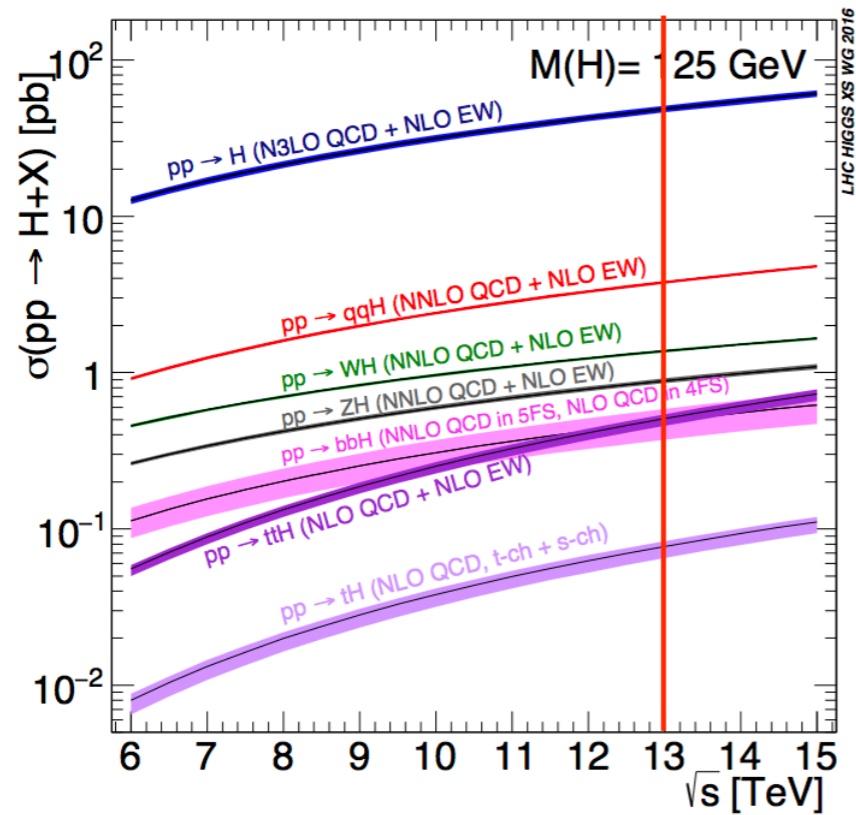

\sqrt{s} (TeV)	Production cross section (in pb) for $m_H = 125$ GeV					total
	ggF	VBF	WH	ZH	$t\bar{t}H$	
1.96	$0.95^{+17\%}_{-17\%}$	$0.065^{+8\%}_{-7\%}$	$0.13^{+8\%}_{-8\%}$	$0.079^{+8\%}_{-8\%}$	$0.004^{+10\%}_{-10\%}$	1.23
7	$16.9^{+5\%}_{-5\%}$	$1.24^{+2\%}_{-2\%}$	$0.58^{+3\%}_{-3\%}$	$0.34^{+4\%}_{-4\%}$	$0.09^{+8\%}_{-14\%}$	19.1
8	$21.4^{+5\%}_{-5\%}$	$1.60^{+2\%}_{-2\%}$	$0.70^{+3\%}_{-3\%}$	$0.42^{+5\%}_{-5\%}$	$0.13^{+8\%}_{-13\%}$	24.2
13	$48.6^{+5\%}_{-5\%}$	$3.78^{+2\%}_{-2\%}$	$1.37^{+2\%}_{-2\%}$	$0.88^{+5\%}_{-5\%}$	$0.50^{+9\%}_{-13\%}$	55.1
14	$54.7^{+5\%}_{-5\%}$	$4.28^{+2\%}_{-2\%}$	$1.51^{+2\%}_{-2\%}$	$0.99^{+5\%}_{-5\%}$	$0.60^{+9\%}_{-13\%}$	62.1

Decay channels

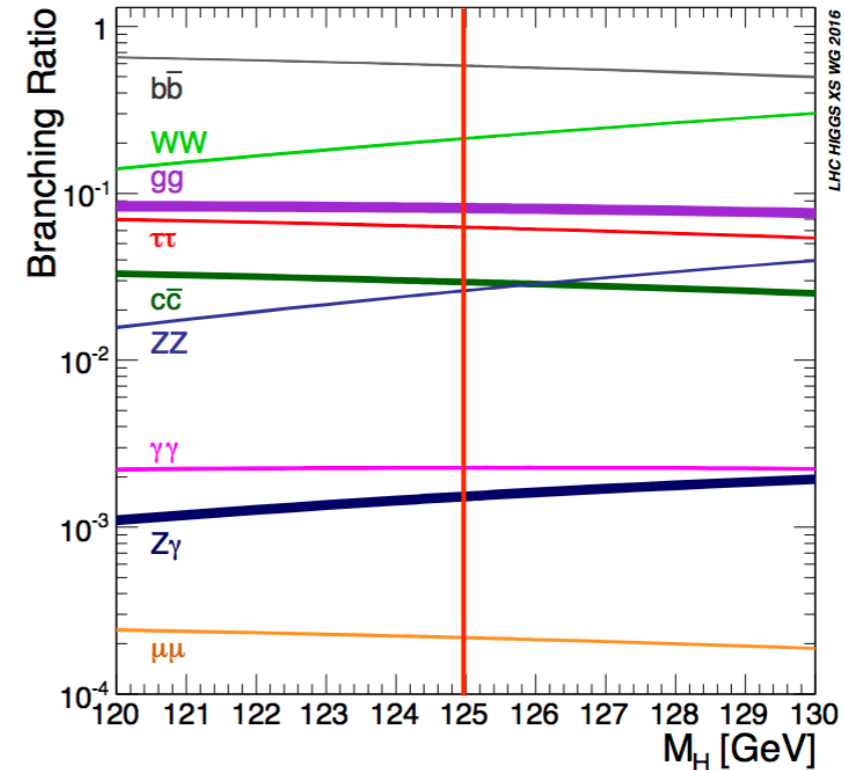

Decay channel	Branching ratio	Rel. uncertainty
$H \rightarrow \gamma\gamma$	2.27×10^{-3}	+5.0% -4.9%
$H \rightarrow ZZ$	2.62×10^{-2}	+4.3% -4.1%
$H \rightarrow W^+W^-$	2.14×10^{-1}	+4.3% -4.2%
$H \rightarrow \tau^+\tau^-$	6.27×10^{-2}	+5.7% -5.7%
$H \rightarrow b\bar{b}$	5.84×10^{-1}	+3.2% -3.3%
$H \rightarrow Z\gamma$	1.53×10^{-3}	+9.0% -8.9%
$H \rightarrow \mu^+\mu^-$	2.18×10^{-4}	+6.0% -5.9%

HIGGS PRODUCTION AND DECAYS

Production channels

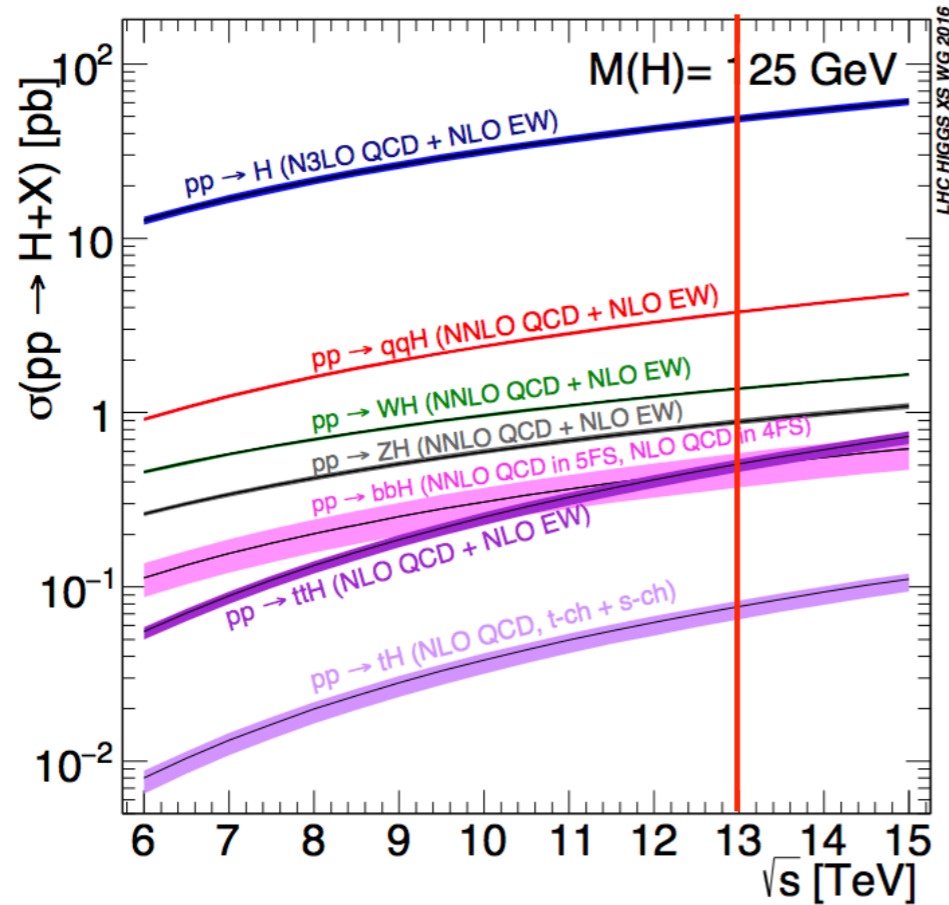

\sqrt{s} (TeV)	Production cross section (in pb) for $m_H = 125$ GeV					total
	ggF	VBF	WH	ZH	$t\bar{t}H$	
13	$48.6^{+5\%}_{-5\%}$	$3.78^{+2\%}_{-2\%}$	$1.37^{+2\%}_{-2\%}$	$0.88^{+5\%}_{-5\%}$	$0.50^{+9\%}_{-13\%}$	55.1

HIGGS PRODUCTION AND DECAYS

Production channels

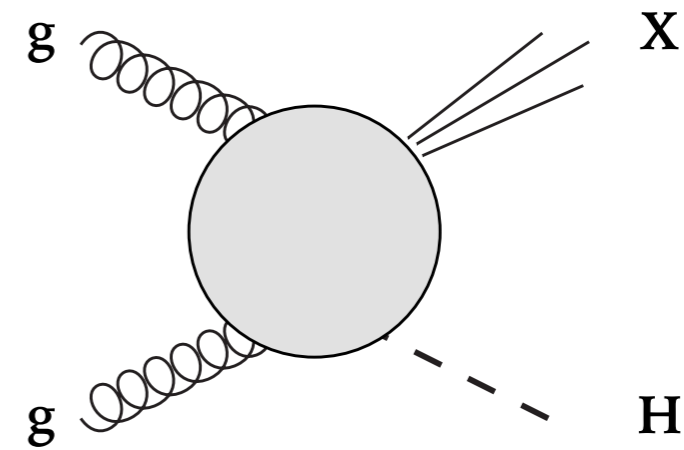
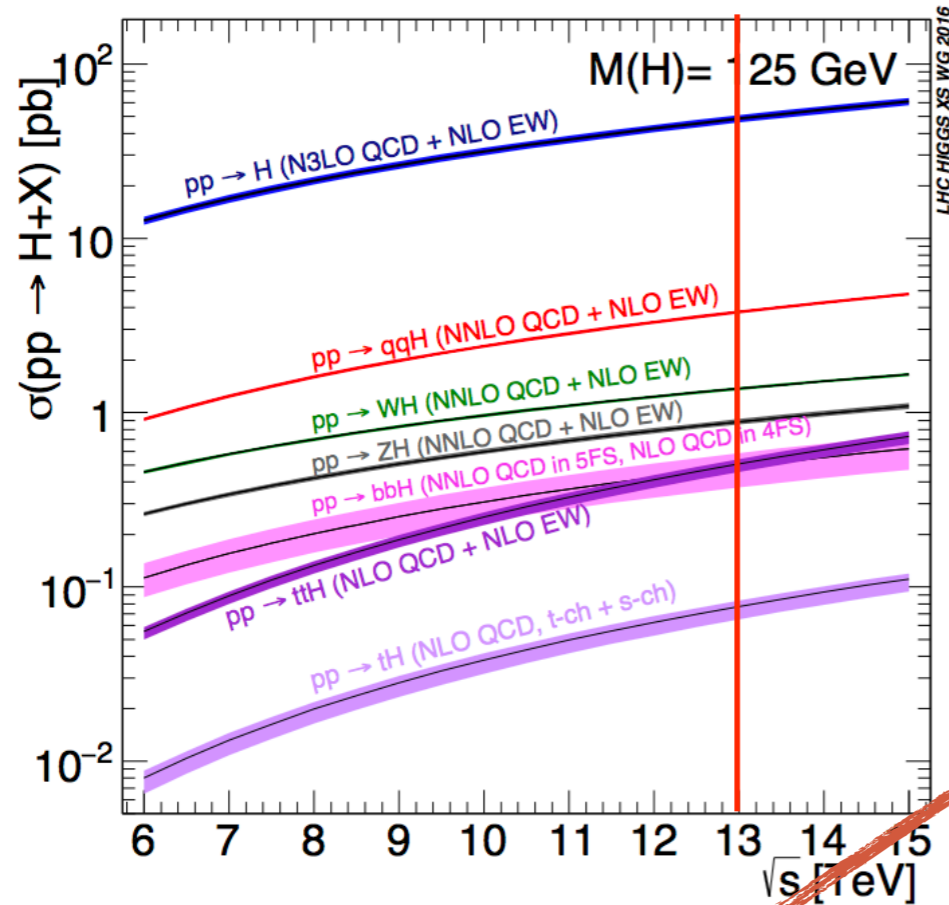

\sqrt{s} (TeV)	Production cross section (in pb) for $m_H = 125$ GeV					total
	ggF	VBF	WH	ZH	$t\bar{t}H$	
13	$48.6^{+5\%}_{-5\%}$	$3.78^{+2\%}_{-2\%}$	$1.37^{+2\%}_{-2\%}$	$0.88^{+5\%}_{-5\%}$	$0.50^{+9\%}_{-13\%}$	55.1

gg is 90% at 13 TeV

HIGGS INCLUSIVE PRODUCTION

90% given by gluon fusion channel. To be understood with very high precision!

Pure QCD 95%:
see Bernhard's Talk

HIGGS INCLUSIVE PRODUCTION

90% given by gluon fusion channel. To be understood with very high precision!

Pure QCD 95%:
see Bernhard's Talk

QCD-EW:
5%

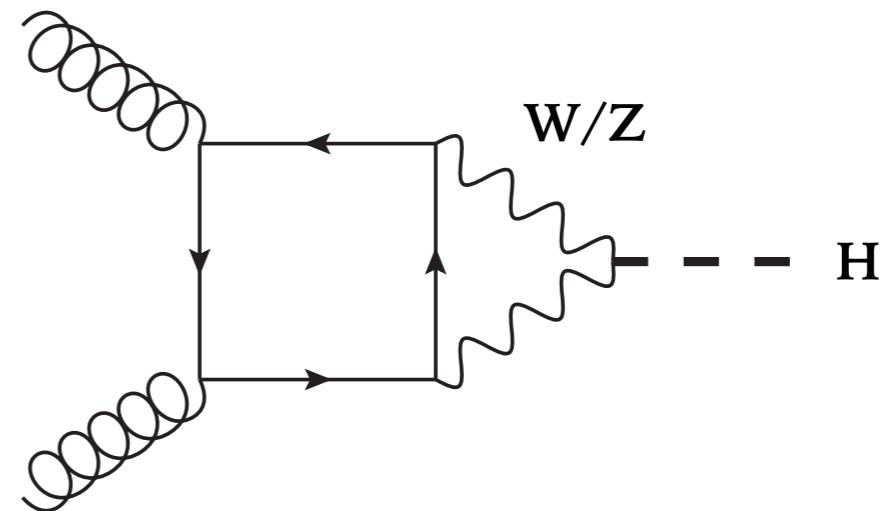

Higgs known to suffer of poor convergence of the perturbative series. Following pattern of pure QCD corrections, this 5% could change of up to 100% @ NLO

HIGGS INCLUSIVE PRODUCTION

Estimate of radiative corrections in unphysical limit $mW \gg mH$

[Anastasiou et al 2009]

Theoretical uncertainties

δ_{scale}	$\delta_{\text{PDF-TH}}$	$\delta_{\text{QCD-EW}}$	$\delta_{t, b, c}$	δ_{1/m_t}
$\sim 2\%$	1.16%	1%	0.83%	1%

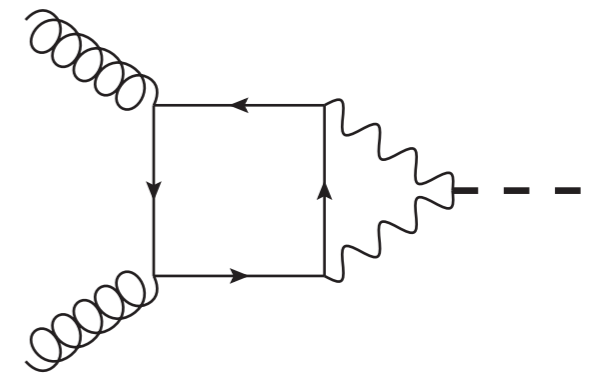

HIGGS INCLUSIVE PRODUCTION

Estimate of radiative corrections in unphysical limit $m_W \gg m_H$

[Anastasiou et al 2009]

Theoretical uncertainties

δ_{scale}	$\delta_{\text{PDF-TH}}$	$\delta_{\text{QCD-EW}}$	$\delta_{t, b, c}$	δ_{1/m_t}
$\sim 2\%$	1.16%	1%	0.83%	1%

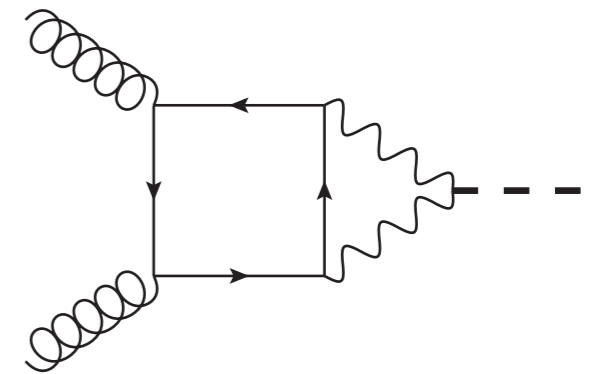

To really claim theory uncertainty at the 1% requires going one order higher (NLO)

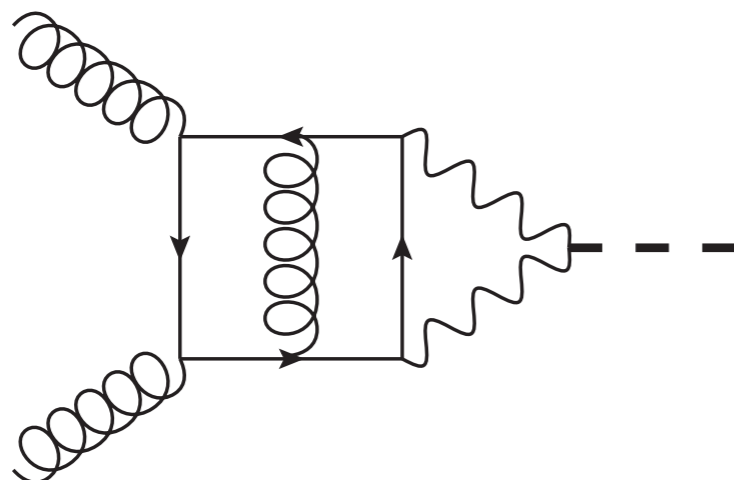

Virtual: 3 loops with masses

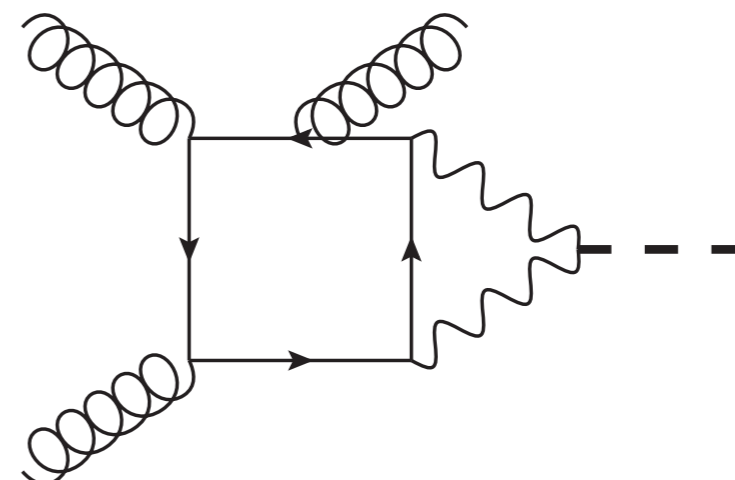

Real: 2 loops with masses

THE QCD-EW CORRECTIONS: VIRTUAL

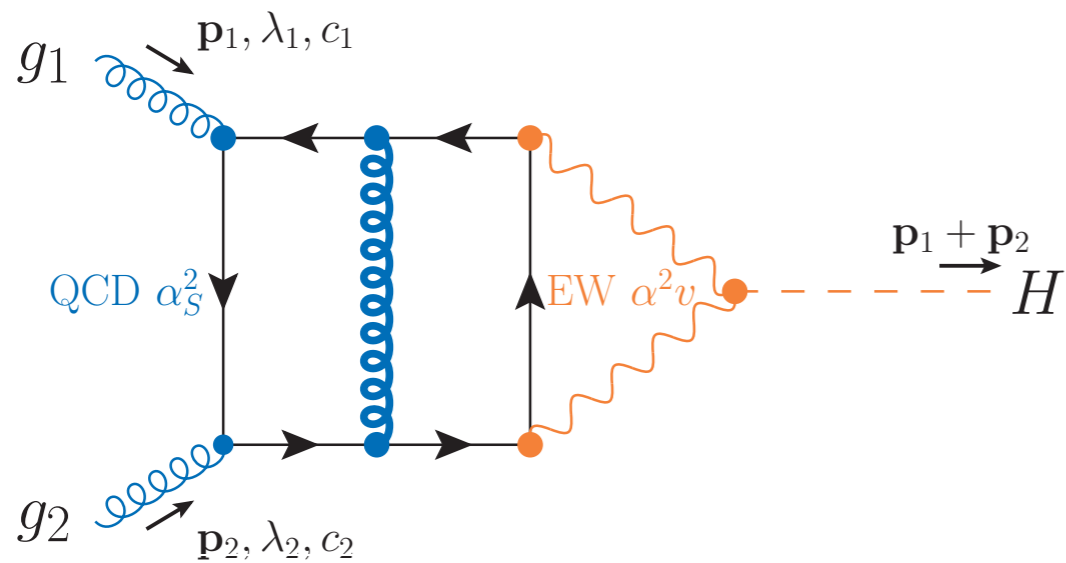

47 3-loop Feynman Integrals, with two internal massive propagators, functions of *one ratio*:

$$y := \frac{\sqrt{1 - 4m^2/s} - 1}{\sqrt{1 - 4m^2/s} + 1}$$

$$\mathcal{M}_{\lambda_1 \lambda_2}^{c_1 c_2} = \delta^{c_1 c_2} \epsilon_{\lambda_1}(\mathbf{p}_1) \cdot \epsilon_{\lambda_2}(\mathbf{p}_2) \mathcal{F}(s, m_W, m_Z)$$

$$\mathcal{F}(s, m_W, m_Z) = -i \frac{\alpha^2 \alpha_S(\mu) v}{64\pi \sin^4 \theta_W} \sum_{V=W,Z} C_V A(m_V^2/s, \mu^2/s)$$

$$C_W = 4$$

$$C_Z = \frac{2}{\cos^4 \theta_W} \left(\frac{5}{4} - \frac{7}{3} \sin^2 \theta_W + \frac{22}{9} \sin^4 \theta_W \right)$$

$$A(m^2/s, \mu^2/s) = A_{2L}(m^2/s) + \frac{\alpha_S(\mu)}{2\pi} A_{3L}(m^2/s, \mu^2/s) + \mathcal{O}(\alpha_S^2)$$

THE QCD-EW CORRECTIONS: VIRTUAL

Fulfil a system of differential equations in canonical form [Henn '13]

$$d\mathbf{F}(y, \epsilon) = \epsilon \left[B_+ d \log(1 - y) + B_r d \log(y^2 - y + 1) + \right. \\ \left. + B_- d \log(y + 1) + B_0 d \log y \right] \mathbf{F}(y, \epsilon)$$

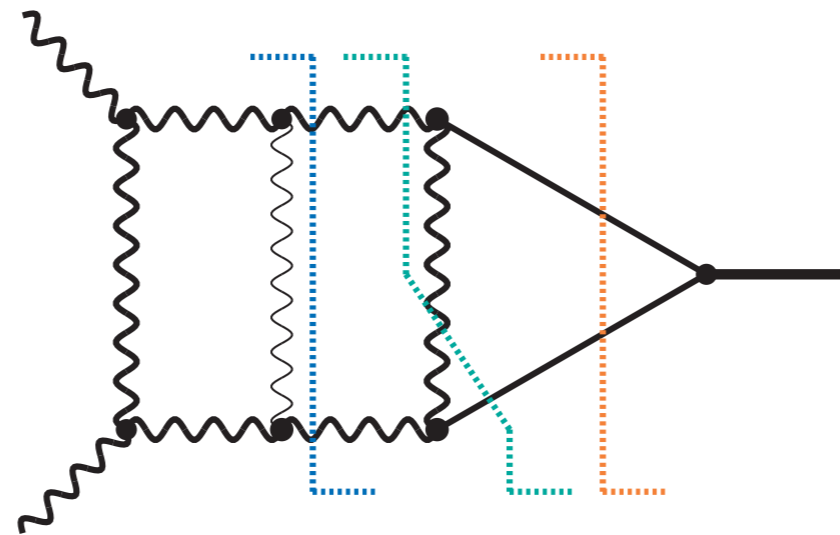

s	0	m^2	$4m^2$	$[\infty]$
y	+1	$e^{i\pi/3}$	-1	[0]
Kernel	$\frac{1}{\xi-1}$	$\frac{2\xi-1}{\xi^2-\xi+1}$	$\frac{1}{\xi+1}$	$\left[\frac{1}{\xi} \right]$

[Drawings by M. Bonetti]

THE QCD-EW CORRECTIONS: VIRTUAL

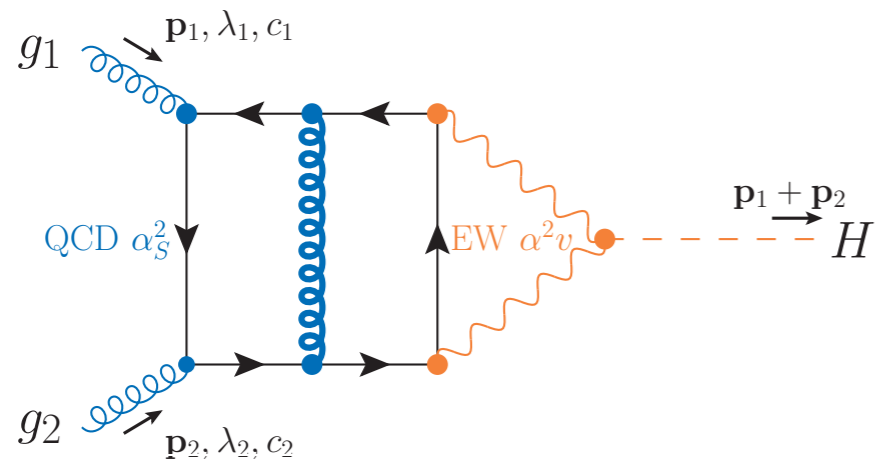

$$\mathcal{M}_3^{c_1 c_2}_{\lambda_1 \lambda_2} = \delta^{c_1 c_2} \epsilon_{\lambda_1}(\mathbf{p}_1) \cdot \epsilon_{\lambda_2}(\mathbf{p}_2) \mathcal{F}_3(s, m_W, m_Z)$$

$$\mathcal{F}(s, m_W, m_Z) = -i \frac{\alpha^2 \alpha_S(\mu) v}{64\pi \sin^4 \theta_W} \sum_{V=W,Z} C_V A(m_V^2/s, \mu^2/s)$$

$$s = \mu = m_H = 125.09 \text{ GeV}, m_W = 80.385 \text{ GeV}, m_Z = 91.1876 \text{ GeV}, N_C = 3, N_f = 5$$

$$A_{2L}(m_Z^2/m_H^2, 1) = -6.880846 -i 0.5784119$$

$$A_{2L}(m_W^2/m_H^2, 1) = -10.71693 -i 2.302953$$

$$A_{3L}^{\text{fin}}(m_Z^2/m_H^2, 1) = -2.975801 -i 41.19509$$

$$A_{3L}^{\text{fin}}(m_W^2/m_H^2, 1) = -11.31557 -i 54.02989$$



UV renormalized +
Catani subtracted

THE QCD-EW CORRECTIONS: VIRTUAL (IMAGINARY PART)

$$s = 0$$

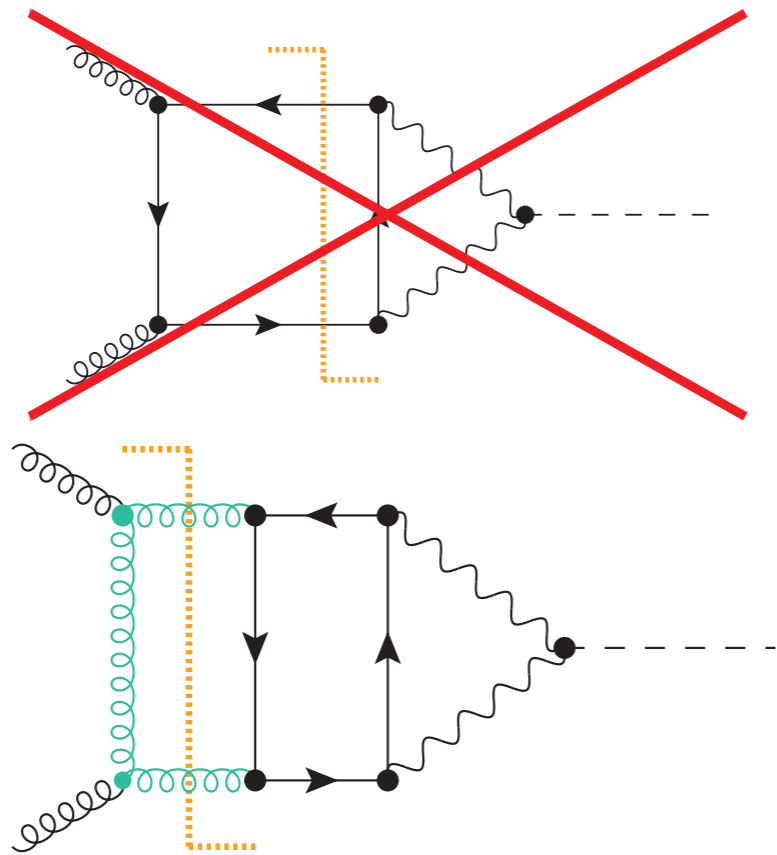

$$-i 2.302953$$

$$s = m^2$$

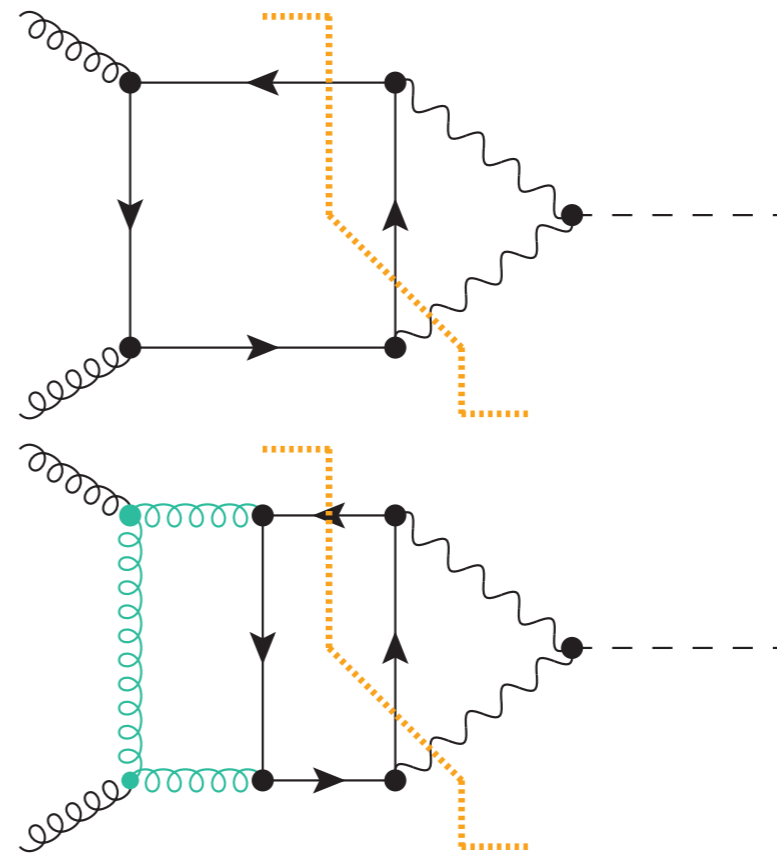

$$-i 54.02989$$

THE QCD-EW CORRECTIONS: THE REALS

What about the real corrections? Non-trivial using standard methods.

Since small corrections (5% of total cross-section) we can do an approximations:

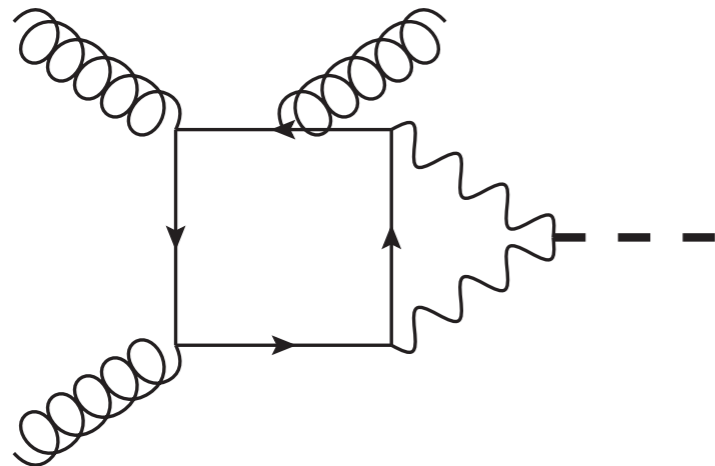

Most of the cross-section comes from region where **extra gluon is soft** (PDFs suppression, parton xsection evaluated close to threshold!):
Soft gluon approximation

[de Florian et al 2012, Forte et al 2013]

THE QCD-EW CORRECTIONS: THE REALS

What about the real corrections? Non-trivial using standard methods.

Since small corrections (5% of total cross-section) we can do an approximations:

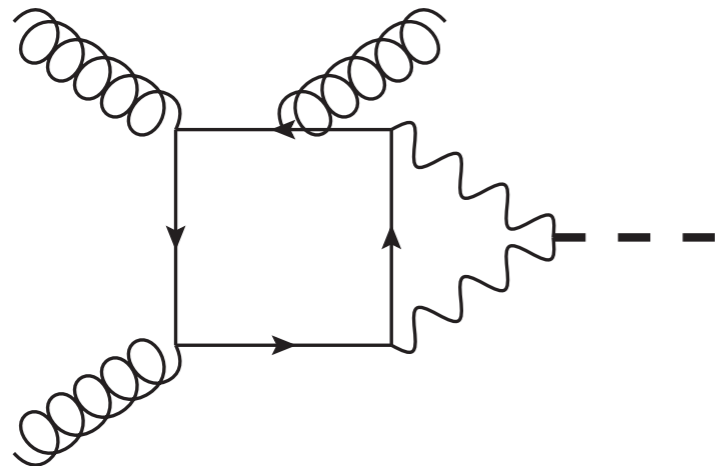

Most of the cross-section comes from region where **extra gluon is soft** (PDFs suppression, parton xsection evaluated close to threshold!):
Soft gluon approximation

[de Florian et al 2012, Forte et al 2013]

$$\left| \text{EW} \right|^2 \underset{E_g \rightarrow 0}{=} \frac{\alpha_S}{4\pi} C_A \frac{2 p_1 \cdot p_2}{p_1 \cdot p_4 p_2 \cdot p_4} \left| \text{EW} \right|^2 + O(p_4^{-1})$$

Eikonal approximation

THE QCD-EW CORRECTIONS

$$\sigma = \int_0^1 \int_0^1 f(x_1, \mu) f(x_2, \mu) \sigma_{\text{LO}} z G(z, \mu, \alpha_S) dx_2 dx_1$$

$$z := m_H^2 / (S_h x_1 x_2), \quad gg \rightarrow H \text{ energy}$$

$$G = \delta(1-z) + \frac{\alpha_S}{2\pi} \left[8C_A \left(\mathcal{D}_1 + \frac{\mathcal{D}_0}{2} \log \frac{m_H^2}{\mu^2} \right) + \left(\frac{2\pi^2}{3} C_A + \frac{\sigma_{\text{NLO}}^{\text{fin}}}{\sigma_{\text{LO}}} \right) \delta(1-z) \right]$$

$$\mathcal{D}_0 = \left[\frac{1}{1-z} \right]_+$$

$$\mathcal{D}_1 = \left[\frac{\log(1-z)}{1-z} \right]_+ + (2 - 3z + 2z^2) \frac{\log[(1-z)/\sqrt{z}]}{1-z} - \frac{\log(1-z)}{1-z}$$

$$\sigma_{\text{LO}}^{\text{QCD}} = 20.6 \text{ pb} \quad \sigma_{\text{LO}}^{\text{QCD-EW}} = 21.7 \text{ pb} \quad \Rightarrow \quad +5.3\% \text{ at LO}$$

$$\sigma_{\text{NLO}}^{\text{QCD}} = 32.7 \text{ pb} \quad \sigma_{\text{NLO}}^{\text{QCD-EW}} = 34.4 \text{ pb} \quad \Rightarrow \quad +5.2\% \text{ at NLO}$$

THE QCD-EW CORRECTIONS

$$\sigma = \int_0^1 \int_0^1 f(x_1, \mu) f(x_2, \mu) \sigma_{\text{LO}} z G(z, \mu, \alpha_S) dx_2 dx_1$$

$$z := m_H^2 / (S_h x_1 x_2), \quad gg \rightarrow H \text{ energy}$$

$$G = \delta(1-z) + \frac{\alpha_S}{2\pi} \left[8C_A \left(\mathcal{D}_1 + \frac{\mathcal{D}_0}{2} \log \frac{m_H^2}{\mu^2} \right) + \left(\frac{2\pi^2}{3} C_A + \frac{\sigma_{\text{NLO}}^{\text{fin}}}{\sigma_{\text{LO}}} \right) \delta(1-z) \right]$$

$$\mathcal{D}_0 = \left[\frac{1}{1-z} \right]_+$$

$$\mathcal{D}_1 = \left[\frac{\log(1-z)}{1-z} \right]_+ + (2 - 3z + 2z^2) \frac{\log[(1-z)/\sqrt{z}]}{1-z} - \frac{\log(1-z)}{1-z}$$

$$\sigma_{\text{LO}}^{\text{QCD}} = 20.6 \text{ pb} \quad \sigma_{\text{LO}}^{\text{QCD-EW}} = 21.7 \text{ pb} \quad \Rightarrow \quad +5.3\% \text{ at LO}$$

$$\sigma_{\text{NLO}}^{\text{QCD}} = 32.7 \text{ pb} \quad \sigma_{\text{NLO}}^{\text{QCD-EW}} = 34.4 \text{ pb} \quad \Rightarrow \quad +5.2\% \text{ at NLO}$$

Supports complete factorization of QCD-EW corrections!

THE QCD-EW CORRECTIONS

$$\sigma = \int_0^1 \int_0^1 f(x_1, \mu) f(x_2, \mu) \sigma_{\text{LO}} z G(z, \mu, \alpha_S) dx_2 dx_1$$

$$z := m_H^2 / (S_h x_1 x_2), \quad gg \rightarrow H \text{ energy}$$

$$G = \delta(1-z) + \frac{\alpha_S}{2\pi} \left[8C_A \left(\mathcal{D}_1 + \frac{\mathcal{D}_0}{2} \log \frac{m_H^2}{\mu^2} \right) + \left(\frac{2\pi^2}{3} C_A + \frac{\sigma_{\text{NLO}}^{\text{fin}}}{\sigma_{\text{LO}}} \right) \delta(1-z) \right]$$

$$\mathcal{D}_0 = \left[\frac{1}{1-z} \right]_+$$

$$\mathcal{D}_1 = \left[\frac{\log(1-z)}{1-z} \right]_+ + (2 - 3z + 2z^2) \frac{\log[(1-z)/\sqrt{z}]}{1-z} - \frac{\log(1-z)}{1-z}$$

$$\sigma_{\text{LO}}^{\text{QCD}} = 20.6 \text{ pb} \quad \sigma_{\text{LO}}^{\text{QCD-EW}} = 21.7 \text{ pb} \quad \Rightarrow \quad +5.3\% \text{ at LO}$$

$$\sigma_{\text{NLO}}^{\text{QCD}} = 32.7 \text{ pb} \quad \sigma_{\text{NLO}}^{\text{QCD-EW}} = 34.4 \text{ pb} \quad \Rightarrow \quad +5.2\% \text{ at NLO}$$

Theoretical uncertainties now

δ_{scale}	$\delta_{\text{PDF-TH}}$	$\delta_{\text{QCD-EW}}$	$\delta_{t, b, c}$	δ_{1/m_t}
$\sim 2\%$	1.16%	0.7% $\mu \in [m_H/4, m_H]$	0.83%	1%

GOING DIFFERENTIAL

WHY GOING DIFFERENTIAL? (THE DEVIL IS IN THE DISTRIBUTIONS)

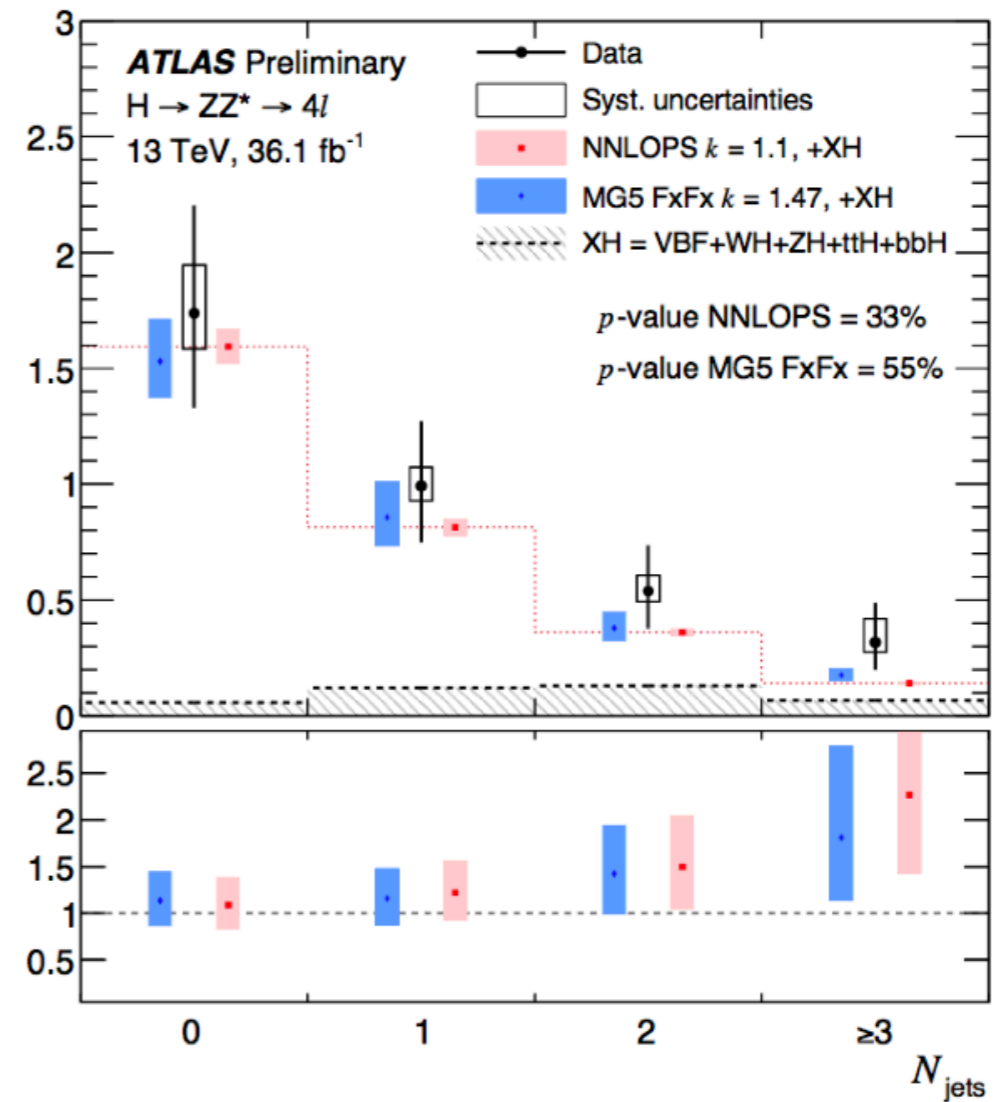
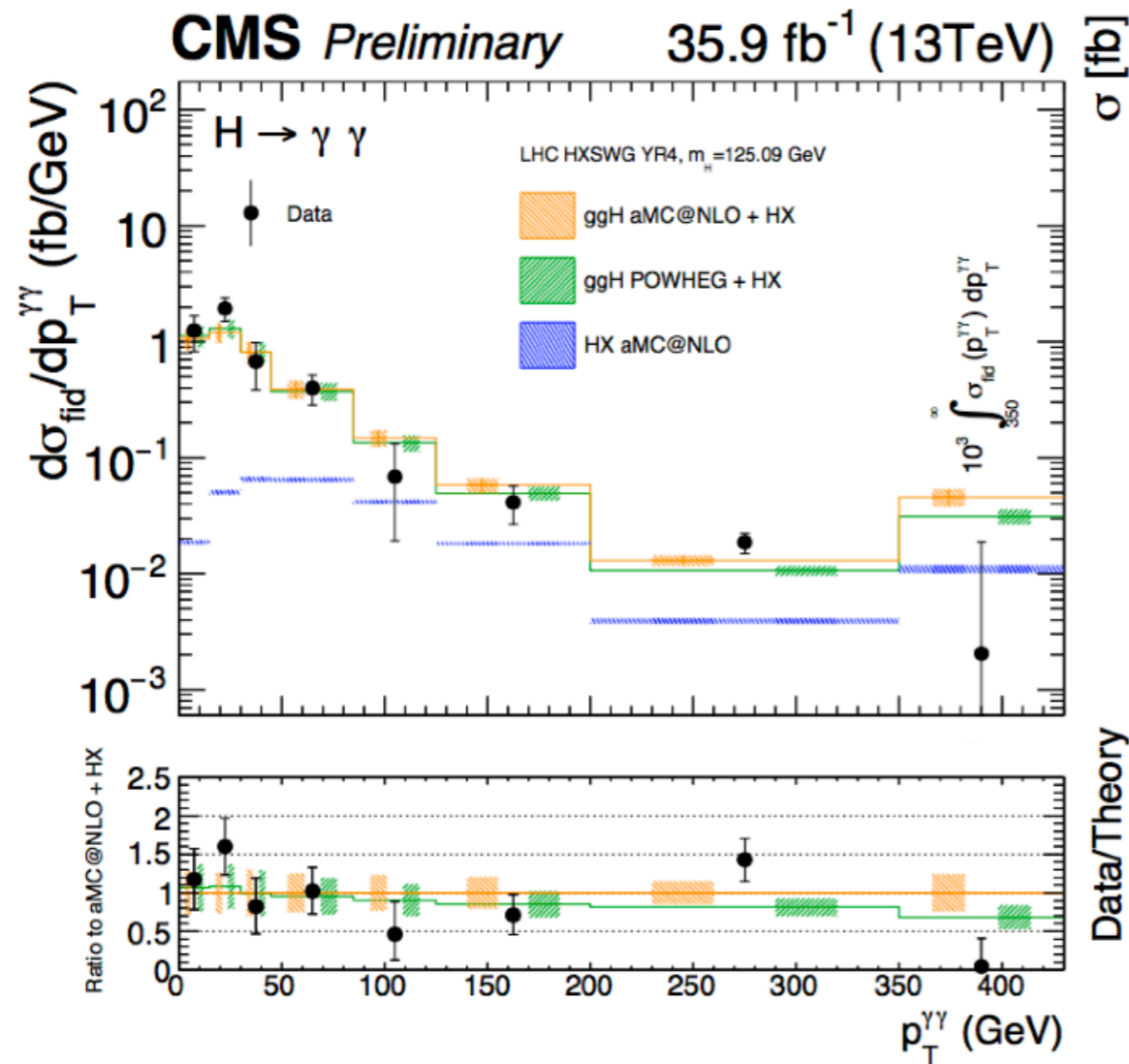

Distributions contain much more information (shape distortion often very non-trivial)

Theory errors more often underestimated, exp. error catching up and already competitive.

THE HIGGS TRANSVERSE MOMENTUM

Higgs transverse momentum distribution as a **new physics probe**

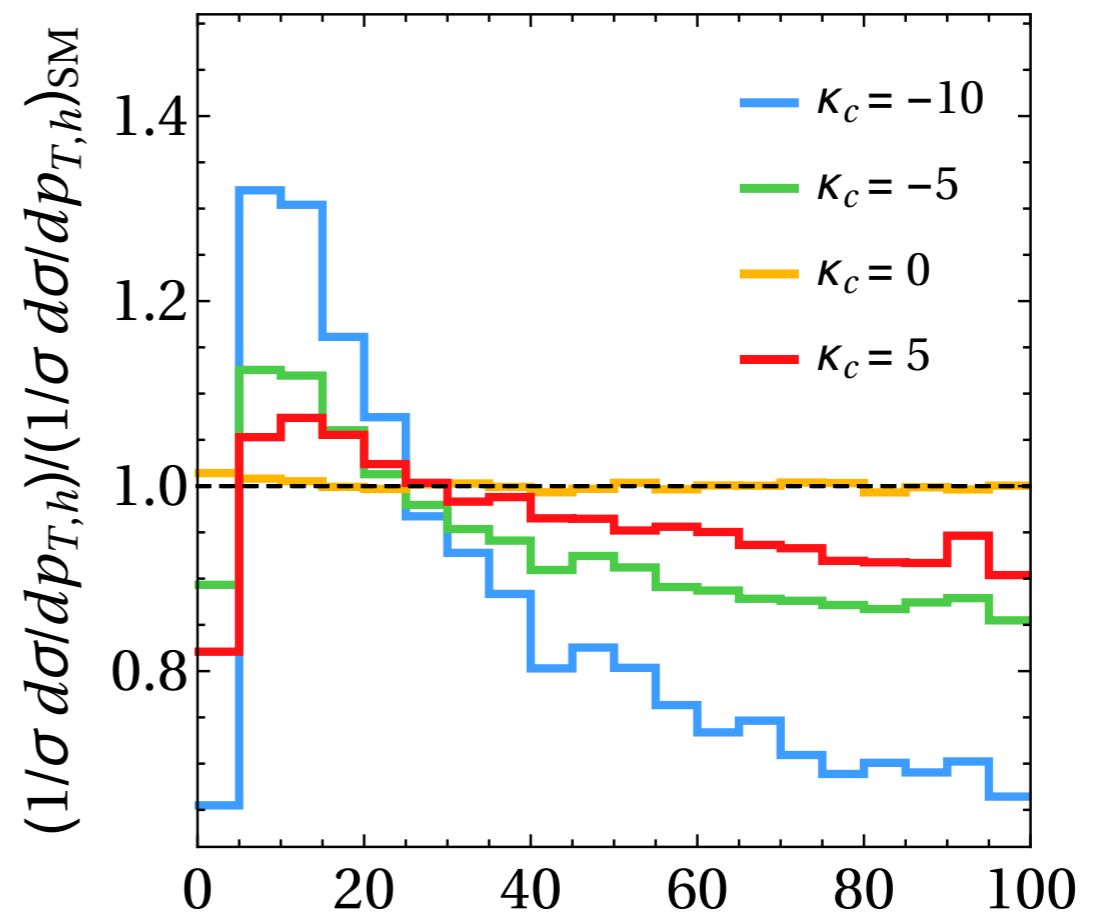
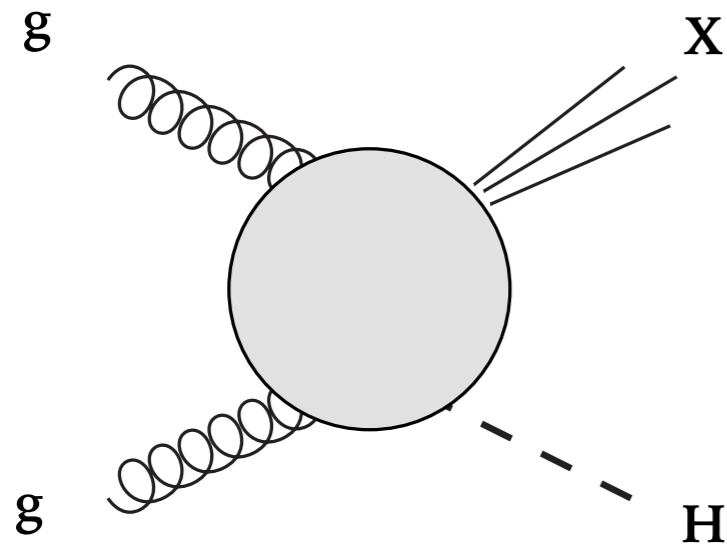

$p_{T,h}$ [GeV] [Bishara, Haisch, Monni, Re, '16]
[Soreq, Zhu, Zupan, '16]

High precision theory determination of Higgs p_T , allows to put constraints on **Higgs couplings to light quarks**

HOW WELL DO WE MODEL THE TRANSVERSE MOMENTUM?

The Higgs transverse momentum distribution is shaped by:

- **Top-quarks** running in the loops: **HEFT** provides a good description for **small p_T**

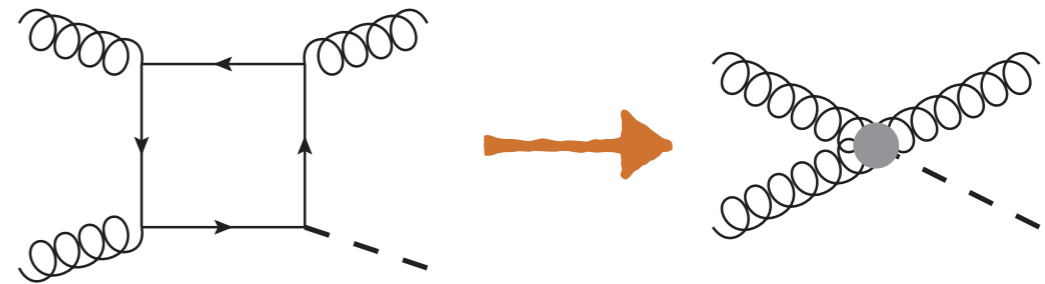

HOW WELL DO WE MODEL THE TRANSVERSE MOMENTUM?

The Higgs transverse momentum distribution is shaped by:

► **Top-quarks** running in the loops: **HEFT** provides a good description for **small p_T**

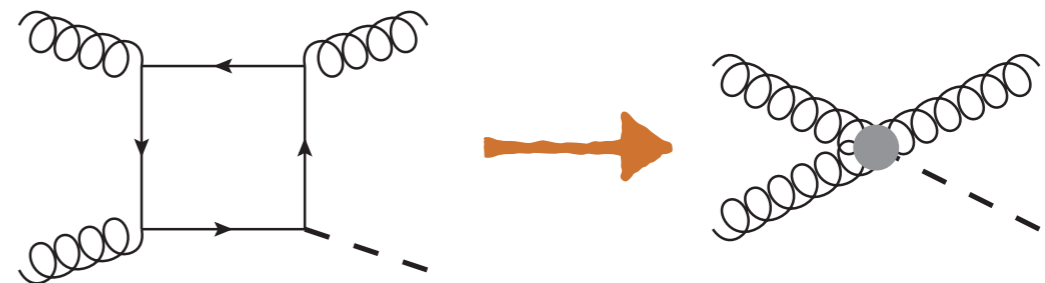

► At high p_T , **top-quarks resolved in the loops**. Need full mass dependence (NLO is a 2-loop process already)

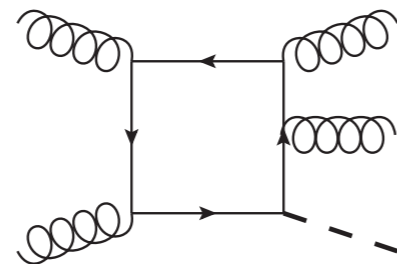
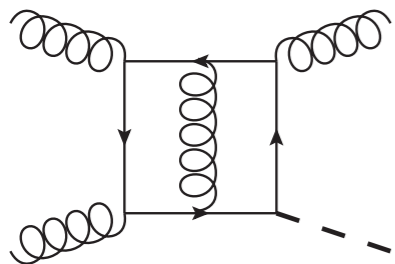

HOW WELL DO WE MODEL THE TRANSVERSE MOMENTUM?

The Higgs transverse momentum distribution is shaped by:

► **Top-quarks** running in the loops: HEFT provides a good description for **small pT**

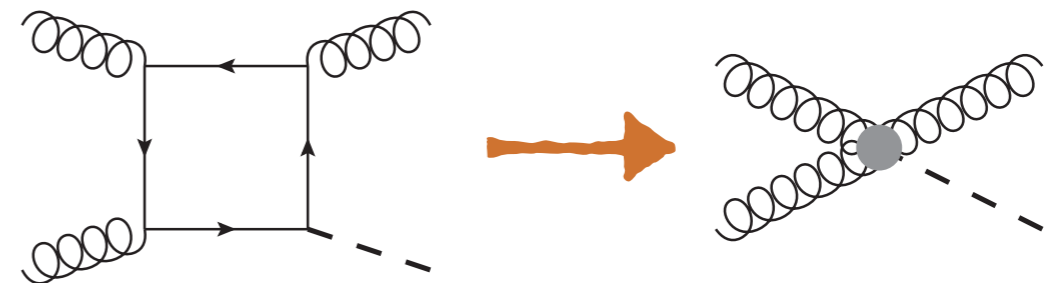

► At high pT, **top-quarks resolved in the loops**. Need full mass dependence (NLO is a 2-loop process already)

► What about **b-quarks**? Amplitude suppressed by two powers of m_b ! Still, **interference top-bottom** contributes **O(5%)** to the pT distribution at LO



$$A_{gg \rightarrow Hg} \sim \left\{ \frac{m_b^2}{m_H^2} \log^2 \left(\frac{m_H^2}{m_b^2} \right), \frac{m_b^2}{m_H^2} \log^2 \left(\frac{p_\perp^2}{m_b^2} \right) \right\}$$

TOP-QUARK CONTRIBUTION

NNLO QCD in HEFT theory known since a couple of years

[Boughezal et al '15, Chen et al '16]

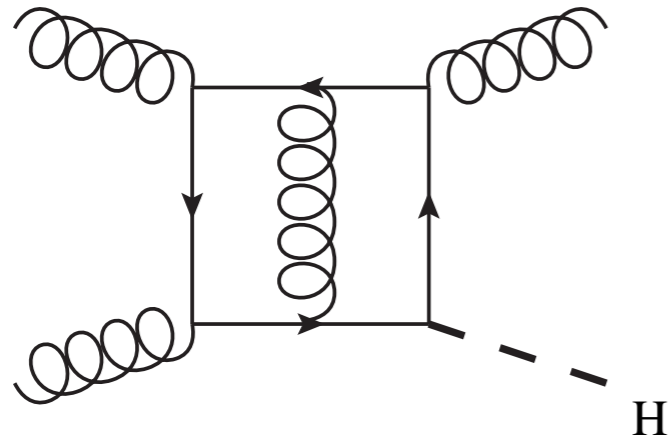

$$\sigma_{pp \rightarrow H+j} = 10.2^{+4.0}_{-2.6} \text{ pb}, 14.7^{+3.0}_{-2.5} \text{ pb}, 17.5^{+1.1}_{-1.4} \text{ pb}$$

NNLO + N3LL resummation

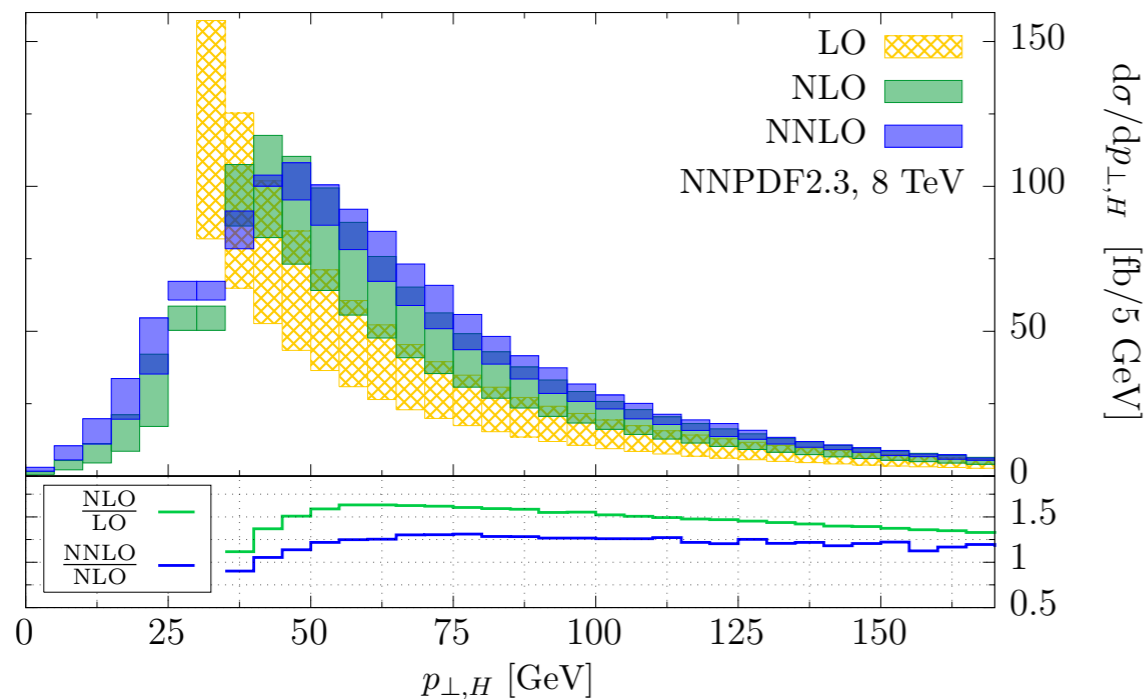

QCD radiative corrections depend on the kinematics. Indeed, the NNLO to NLO cross-sections ratio changes from 1.25 at $p_{\perp} = 30$ GeV to ~ 1 at $p_{\perp} \sim 150$ GeV.

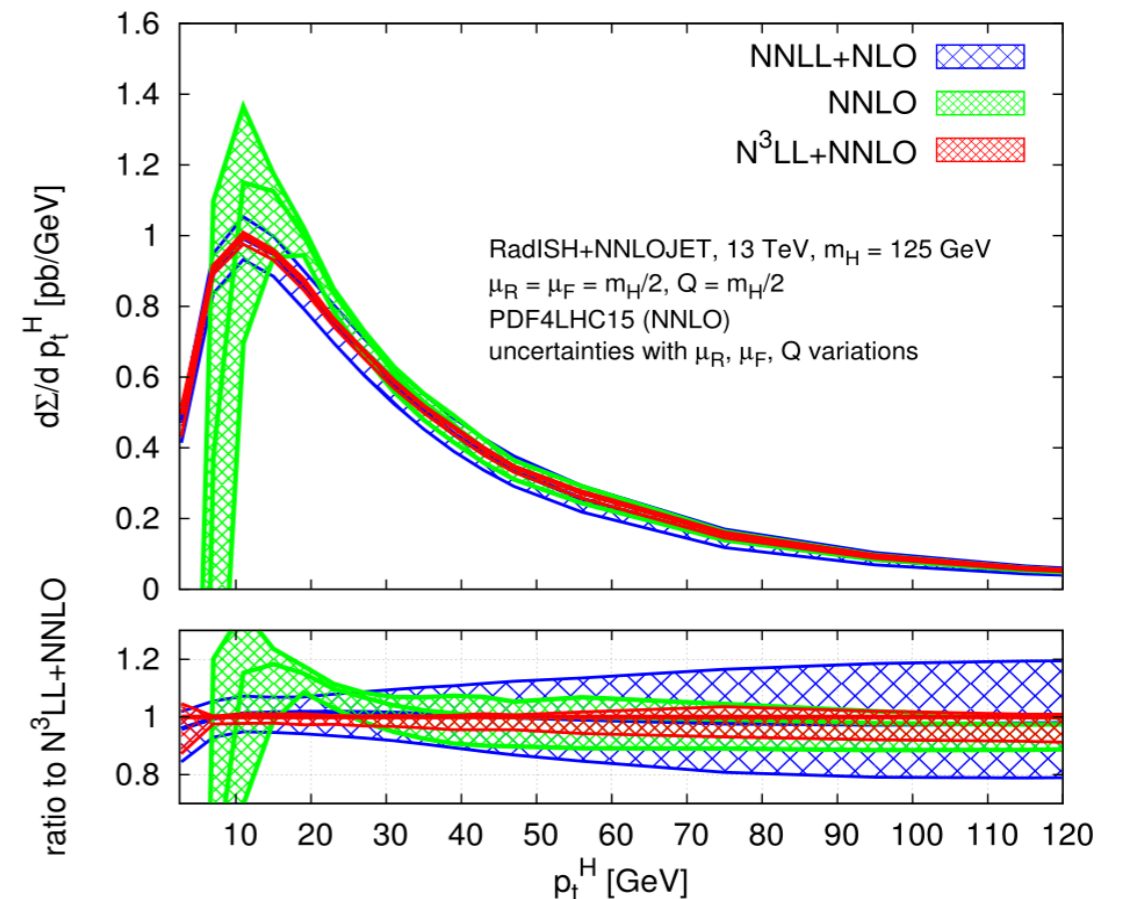

[Bizon et al '18]

TOP-QUARK CONTRIBUTION

Exact dependence on the top-mass [Jones, Kerner, Luisoni '18]

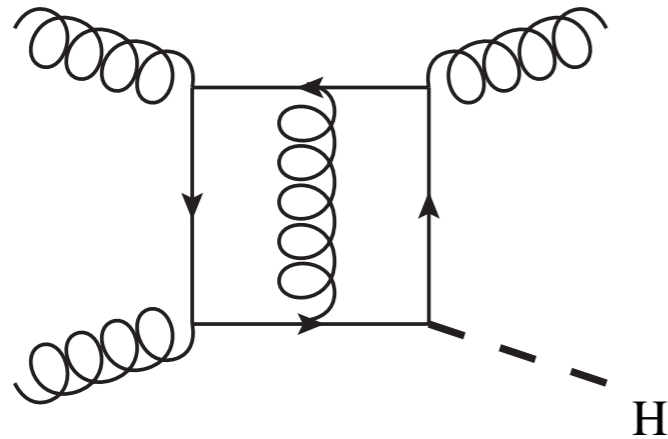

- ▶ Top-mass effects increase NLO of $\sim 9\%$.
- ▶ Different scaling HEFT vs Full Theory

$$\frac{d\sigma}{dp_{\perp}^2} \sim p_{\perp}^{-2} \quad \text{HEFT}$$

$$\frac{d\sigma}{dp_{\perp}^2} \sim p_{\perp}^{-4} \quad \text{full theory}$$

- ▶ Nearly constant K factor @ NLO in full theory

Virtual amplitudes can be computed numerically using **Sector Decomposition**.
Using *Finite basis of master integrals*
[von Manteuffel, Panzer, Schabinger '14]

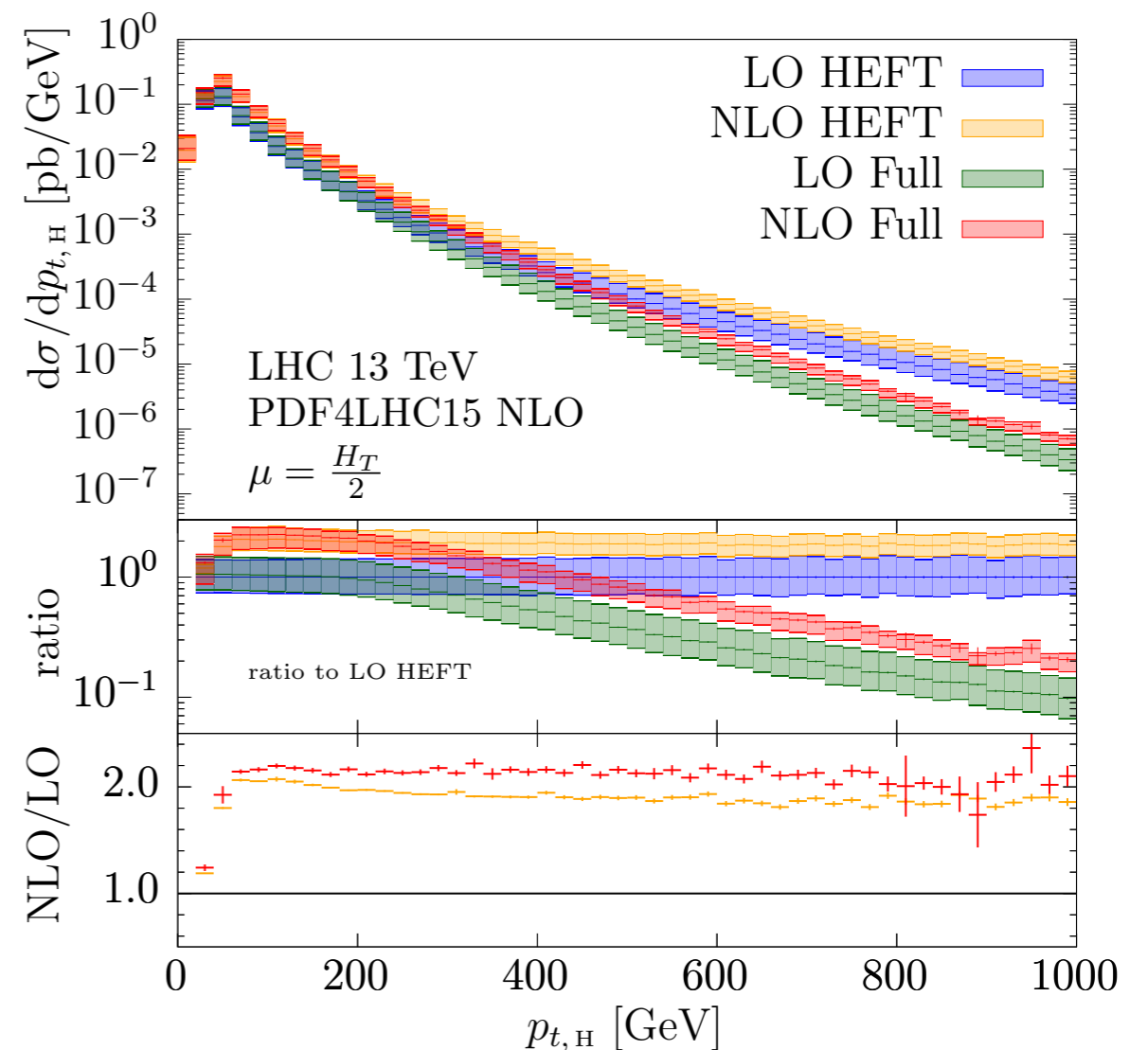

EFFECT OF BOTTOM QUARKS ON THE HIGGS PT

Most important contribution is clearly the interference with the top-induced diagrams

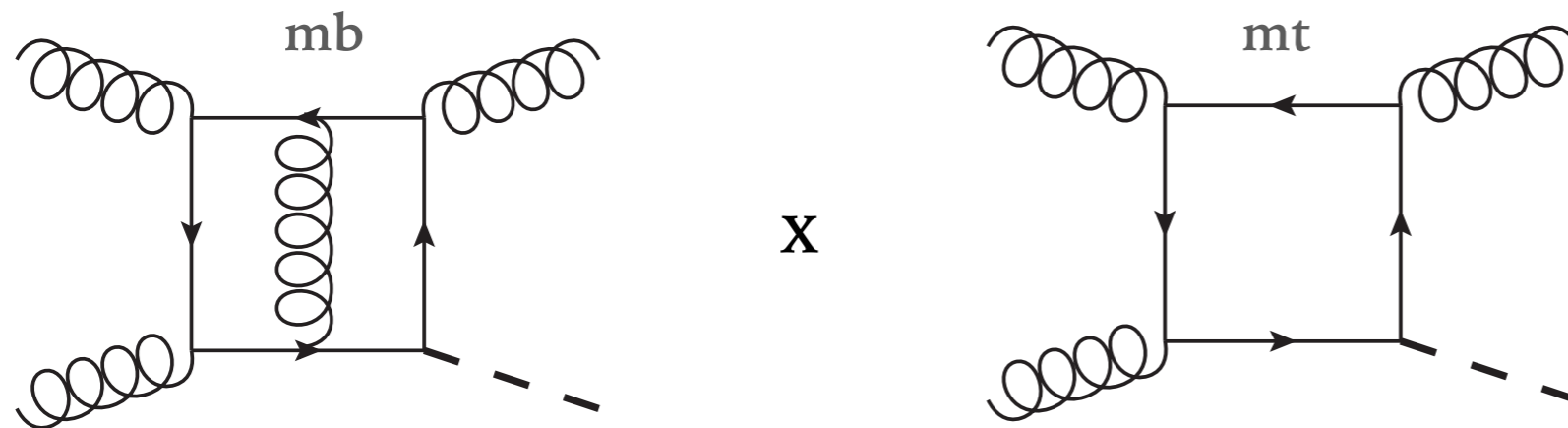

$$A_{gg \rightarrow Hg} \sim \left\{ \frac{m_b^2}{m_H^2} \log^2 \left(\frac{m_H^2}{m_b^2} \right), \frac{m_b^2}{m_H^2} \log^2 \left(\frac{p_{\perp}^2}{m_b^2} \right) \right\}$$

$$m_H = 125 \text{ GeV}$$

$$m_b \sim 4.7 \text{ GeV}$$

$$p_{\perp}^{\text{typ}} \sim 30 \text{ GeV}$$

EFFECT OF BOTTOM QUARKS ON THE HIGGS PT

Most important contribution is clearly the interference with the top-induced diagrams

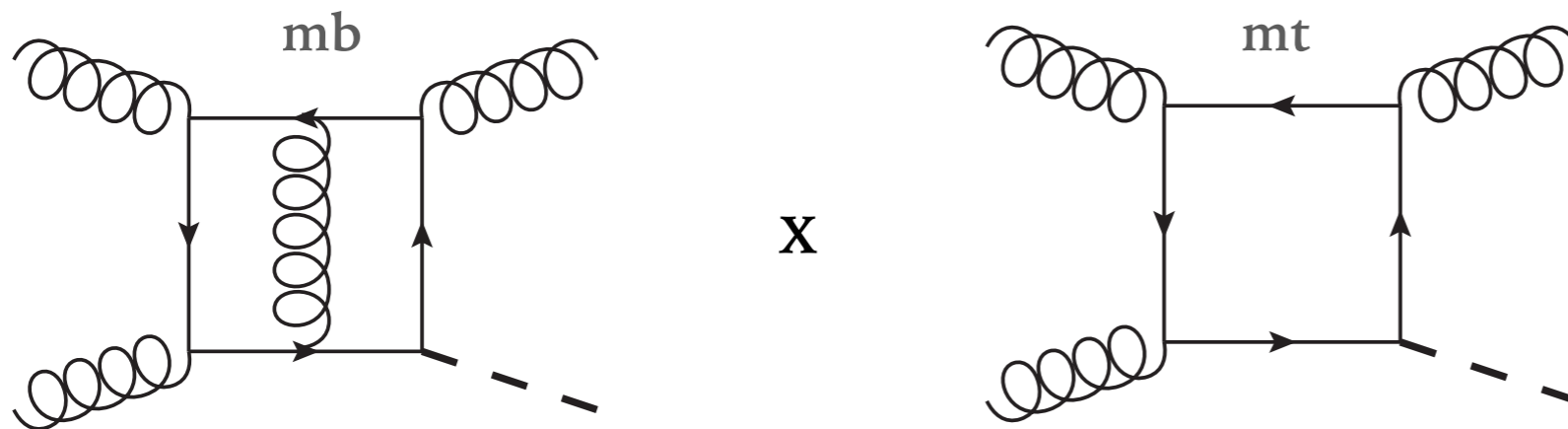

$$A_{gg \rightarrow Hg} \sim \left\{ \frac{m_b^2}{m_H^2} \log^2 \left(\frac{m_H^2}{m_b^2} \right), \frac{m_b^2}{m_H^2} \log^2 \left(\frac{p_\perp^2}{m_b^2} \right) \right\}$$

$$m_H = 125 \text{ GeV}$$

$$m_b \sim 4.7 \text{ GeV}$$

$$p_\perp^{\text{typ}} \sim 30 \text{ GeV}$$

$$10^{-3} \times (\sim 6.5)^2 \sim 10^{-1}$$

Potentially 10%!

RESULTS @ FIXED ORDER

Handling the **bottom-mass** is delicate. Being so small can also generate numerical instabilities!

$$m_b \ll m_H, p_{\perp}^{\text{typ}}, \text{ where } p_{\perp}^{\text{typ}} \sim 30 \text{ GeV}$$



Amplitudes can be evaluated by *expanding in the small bottom mass!*

[Melnikov, Tancredi, Wever '16]

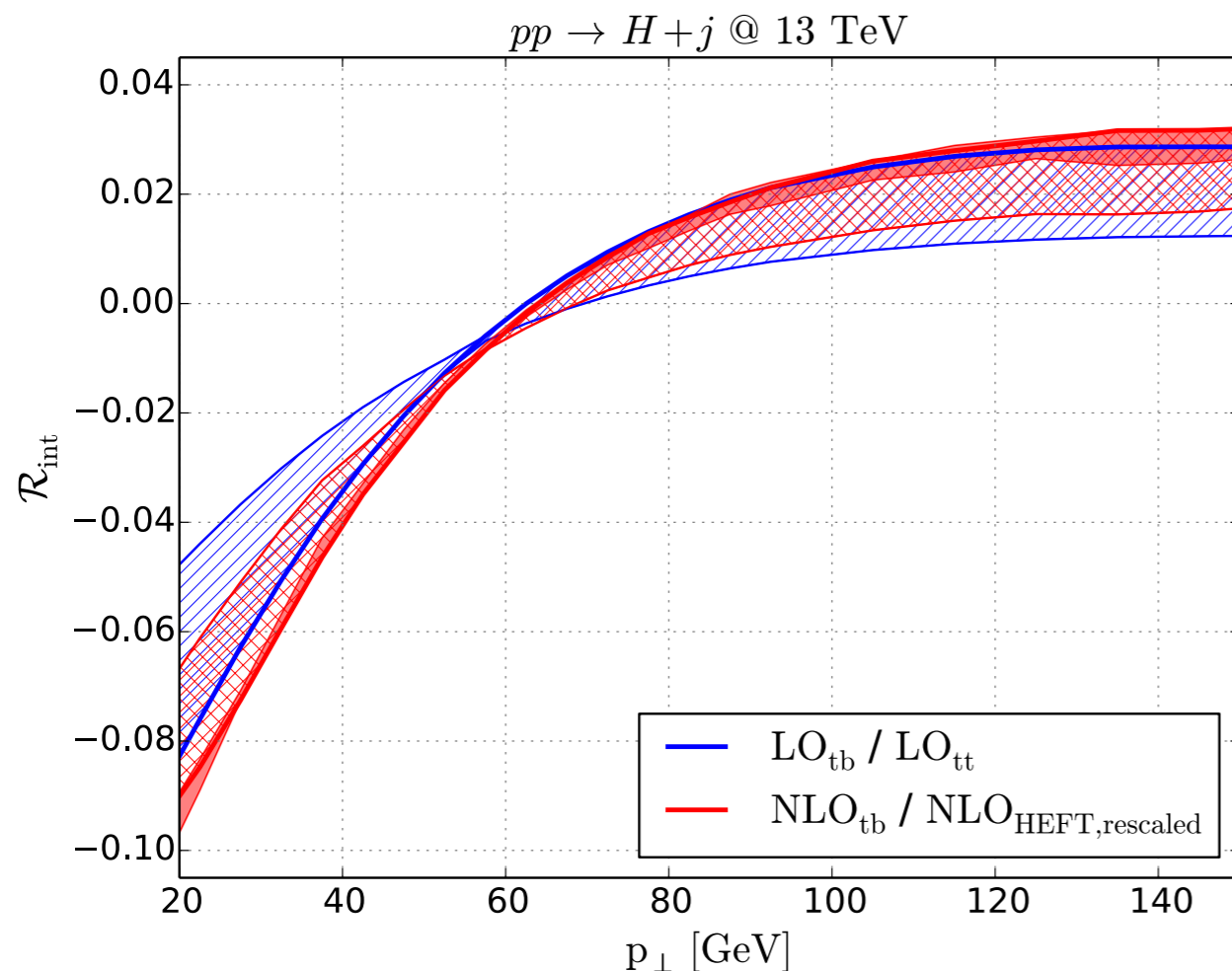

At LO, bottom quark affects Higgs p_T by
 -8% at $p_{\perp} \sim 20 \text{ GeV}$ and $+2\%$ at $p_{\perp} \sim 100 \text{ GeV}$

$$\mathcal{R}_{\text{int}} [\mathcal{O}] = \frac{\int d\sigma_{tb} \delta(\mathcal{O} - \mathcal{O}(\vec{x}))}{\int d\sigma_{tt} \delta(\mathcal{O} - \mathcal{O}(\vec{x}))}$$

NLO gives sizable corrections on interference proper $\mathcal{O}(40 - 50\%)$

[Lindert, Melnikov, Tancredi, Wever '17]

RESULTS @ FIXED ORDER

Handling the **bottom-mass** is delicate. Being so small can also generate numerical instabilities!

$$m_b \ll m_H, p_{\perp}^{\text{typ}}, \text{ where } p_{\perp}^{\text{typ}} \sim 30 \text{ GeV}$$



Amplitudes can be evaluated by *expanding in the small bottom mass!*

[Melnikov, Tancredi, Wever '16]

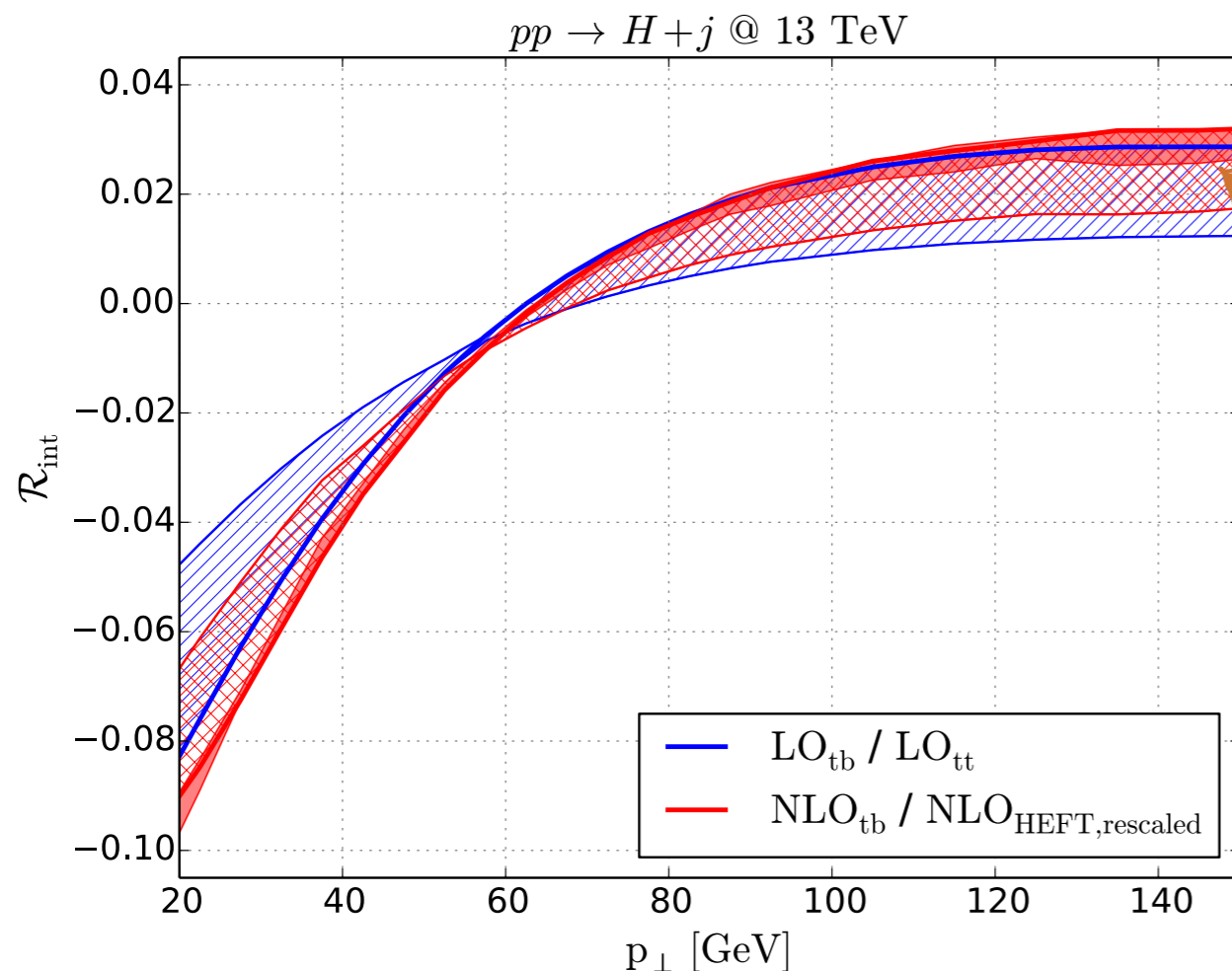

At LO, bottom quark affects Higgs p_T by
 -8% at $p_{\perp} \sim 20 \text{ GeV}$ and +2% at $p_{\perp} \sim 100 \text{ GeV}$

$$\mathcal{R}_{\text{int}}[\mathcal{O}] = \frac{\int d\sigma_{tb} \delta(\mathcal{O} - \mathcal{O}(\vec{x}))}{\int d\sigma_{tt} \delta(\mathcal{O} - \mathcal{O}(\vec{x}))}$$

Scale variation

Vs

Mass renormalization ambiguity

$$m_b^{\overline{\text{MS}}}(100 \text{ GeV}) = 3.07 \text{ GeV}$$

$$m_b = 4.75 \text{ GeV}$$

[Lindert, Melnikov, Tancredi, Wever '17]

THE HIGGS AT MEDIUM TRANSVERSE MOMENTA

Full control on the region of low/medium p_T requires also resummation, at least of those logs that we can resum!

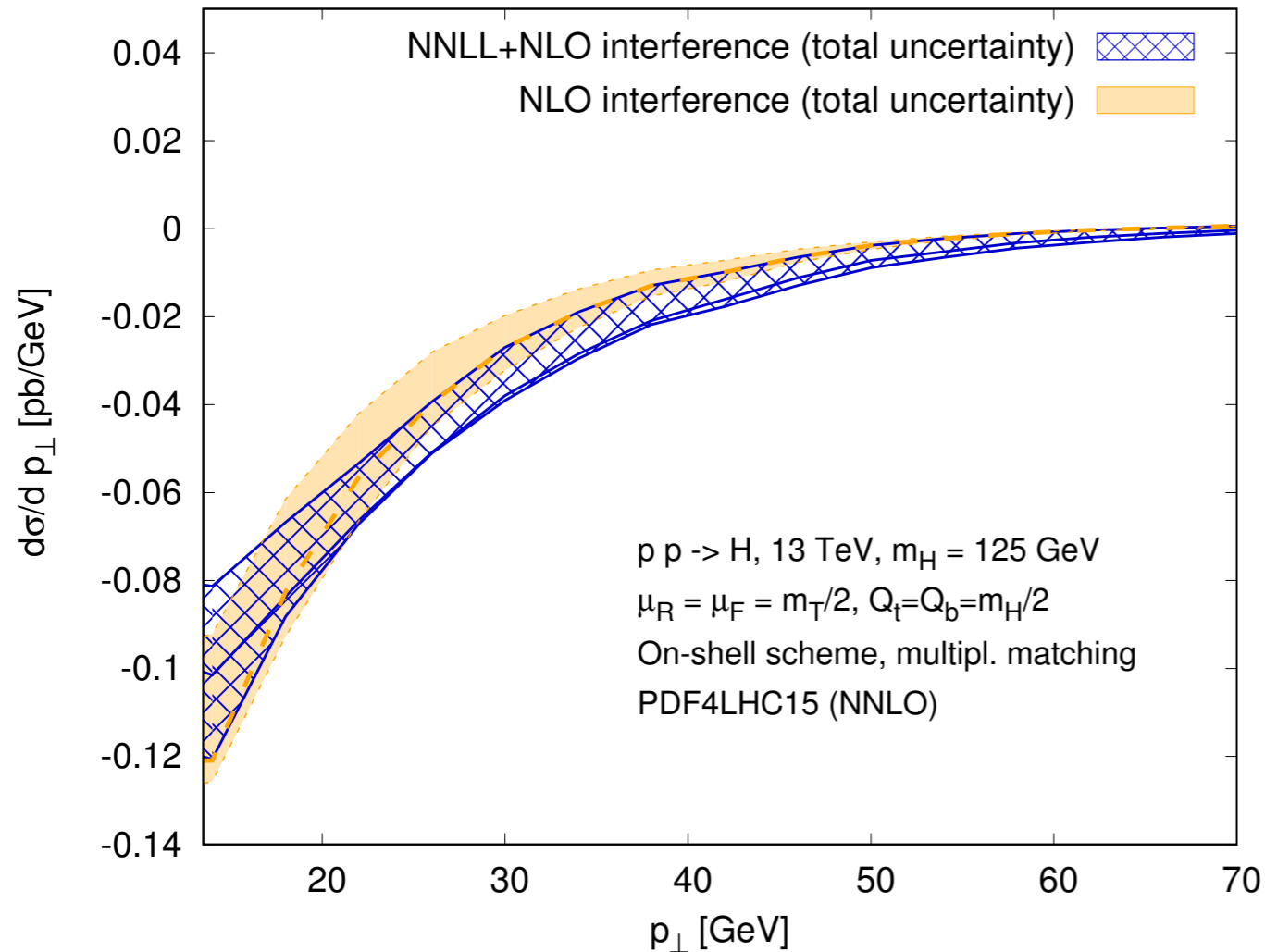

Main residual uncertainty remains due to **bottom mass renormalisation ambiguities:**
~ 10-15% down to $p_T \sim 10$ GeV

WHAT ABOUT THE OTHER LOGS?

Conceptually these new logarithms are troublesome!

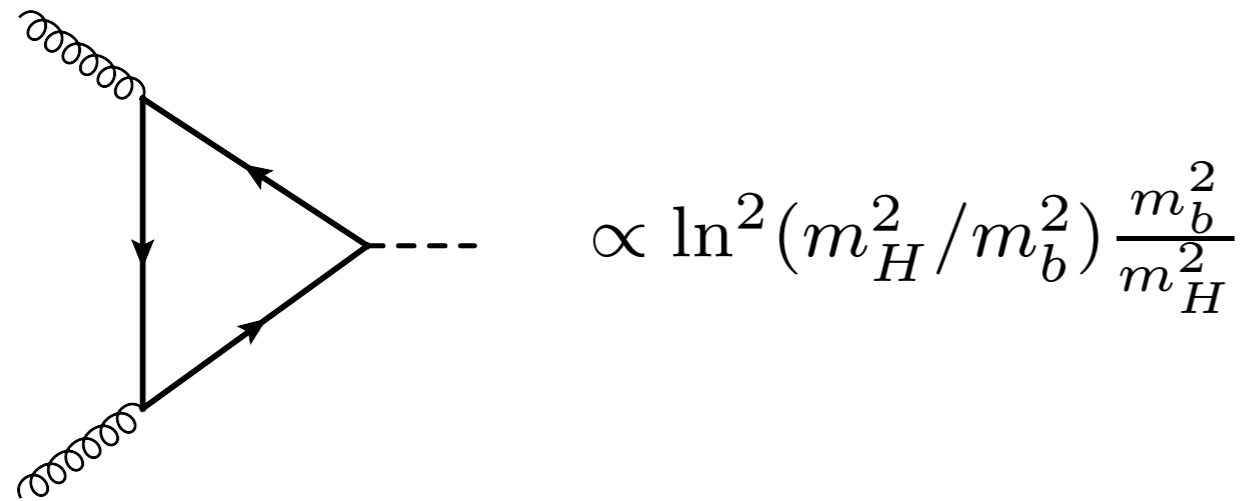

Means that, effectively, the expansion parameter becomes $\alpha_s \ln^2(m_H^2/m_b^2) \sim 40\alpha_s$

Requires LL resummation beyond leading power in QCD

Double logs induced by soft quark exchange! [Penin, '14; Liu, Penin '17, '18]

Used to estimate contribution from bottom quarks at NNLO \rightarrow 3 loops $\sim -0.6\%$!

[Liu, Penin '18]

CONCLUSIONS

- **The Higgs is NEW PHYSICS!**
- We have the chance to study the Higgs at the LHC with % precision, both inclusively and exclusively.
- This requires many contributions: top quarks, bottom quarks, QCD-EW corrections etc..
- Their calculation is very involved and requires going beyond the current machinery for higher order calculations
- Lately a lot of progress, not only in QCD! Still a lot to do from the more formal side.
- Theoretical description of Higgs physics under good control soon!

THANK YOU!

BACK UP SLIDES

HIGGS INCLUSIVE PRODUCTION

Can we describe Higgs with % precision in the Standard Model, consistently with experiments?

Inclusive Higgs Production

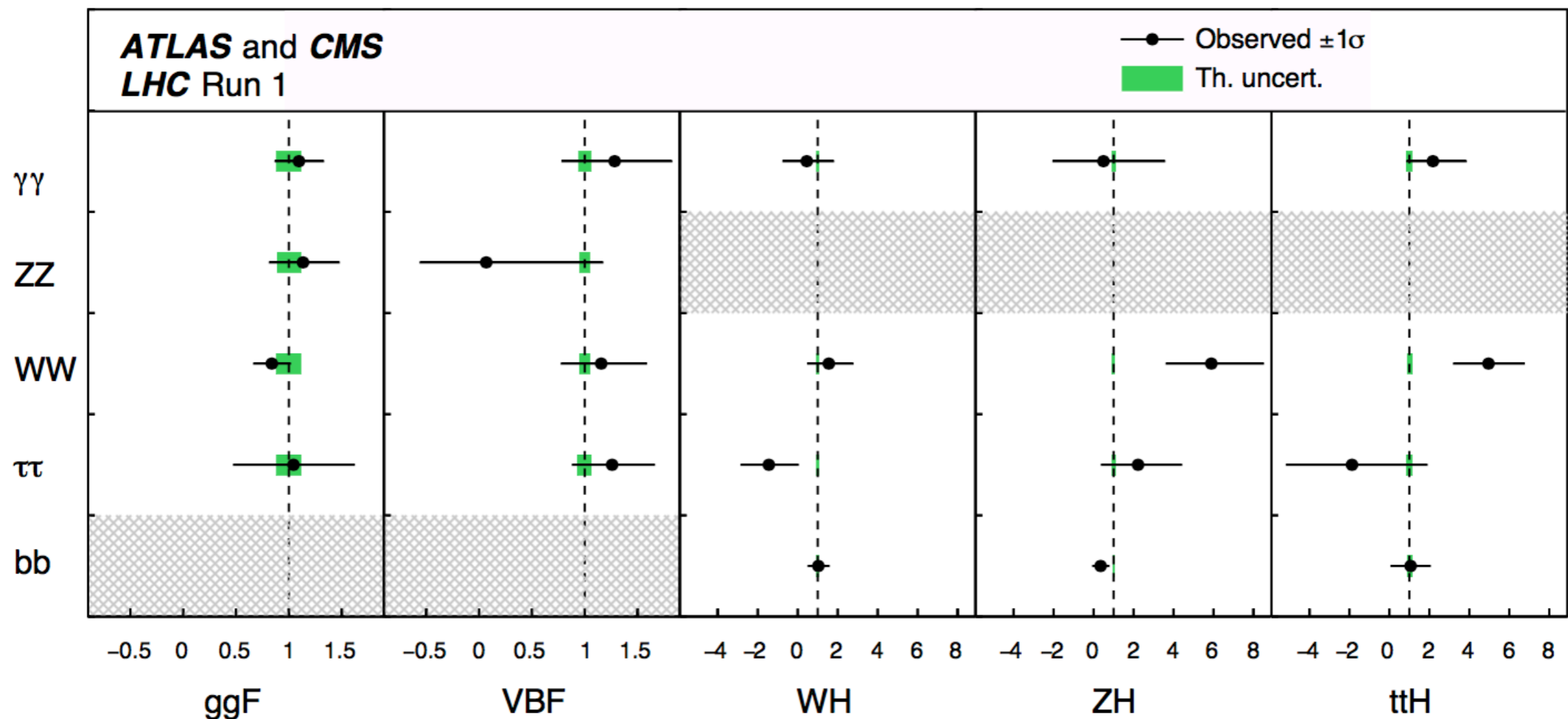

Theory looks pretty good! How did we get to such a good theory precision?