

# LS2 preparatory meeting

A.Tauro



# General information

- LS2 duration: 27 months
- Access mode: general
- Underground visits: possible from 16 December 2018 (no visits during Xmas closure)
- IMPACT requests: possible to make one request per activity (e.g. TPC disconnection).  
Not possible to make generic request to cover 1 year...
- RP: personal dosimeter needed (no declassification)

# LS2 master plan

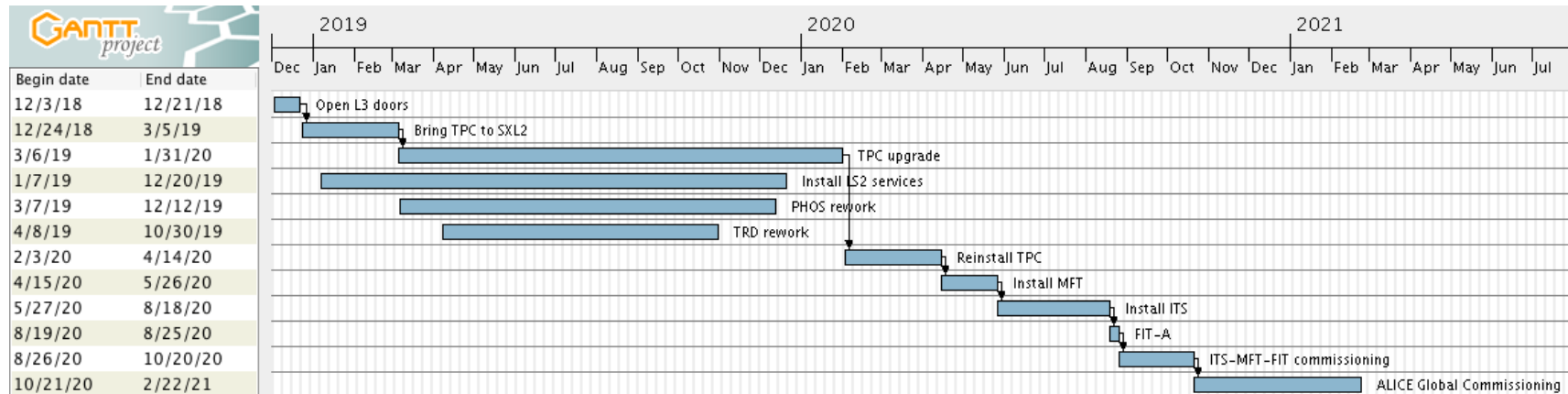

# December timeline



**Remove  
shieldings**

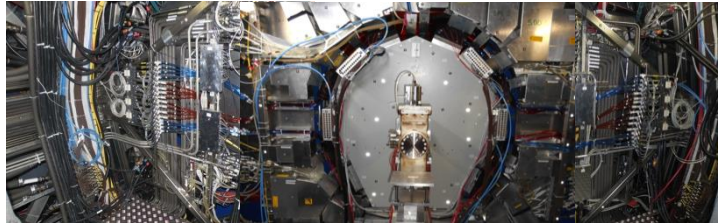

**Disconnect  
PP0/PP1**

**Remove  
forward  
detectors  
and  
beampipe**



**Open L3  
doors**

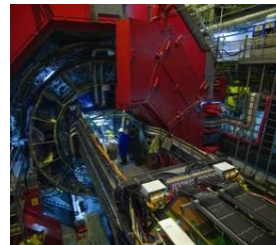

**Extract  
TRD SM6**

**LS2 starts  
3 Dec '18**

**10 Dec**

**13 Dec**

**19 Dec**

**21 Dec '18**

# Preparatory and follow-up meetings

- Dates LS2 preparatory meetings:
  - Fri 26 Oct: TS3 and LS2 preparatory meeting: <https://indico.cern.ch/event/766357/>
  - Fri 16 Nov
  - Fri 30 Nov
- Daily meetings from 3<sup>rd</sup> Dec 16h30
- Weekly Friday's meeting throughout whole LS2

# Underground access in December

- w49:
  - **No access** between 6:00 AM and 10:00 AM (ALTEAD only)
  - **Restricted access** between 10:00 AM and 17:00 PM (Miniframe disconnection)
  - **Normal access** after 17:00 PM
- w50:
  - **No access** between 6:00 AM and 10:00 AM (ALTEAD only)
  - **Normal access** after 10:00 AM
- w51:
  - **Normal access**
- No activities foreseen during Xmas closure

# Day-by-day sequence w49



# UX25 activities w49 – Mon 3 Dec 2018

RP: cavern access from 8:30 AM

Reinstall crane electronics

RP analysis cooling fluids

Lockout ZEM rack

Close sector valves and vent vacuum sector with air (TE-VSC), start at 8:00 AM

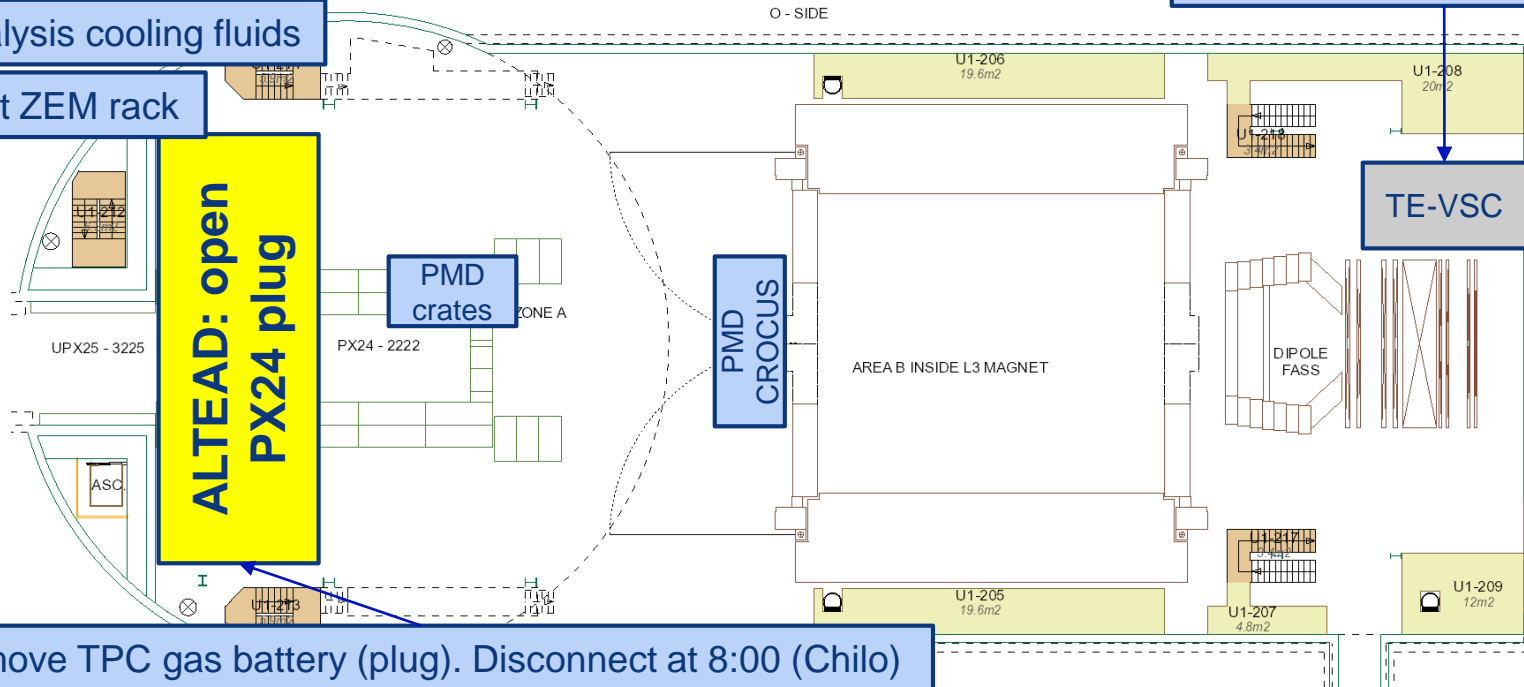

Remove TPC gas battery (plug). Disconnect at 8:00 (Chilo)



# Miniframe activities w49 – Mon 3 Dec 2018 AM

**Miniframe access from 10:00**

TPC cooling water evacuation

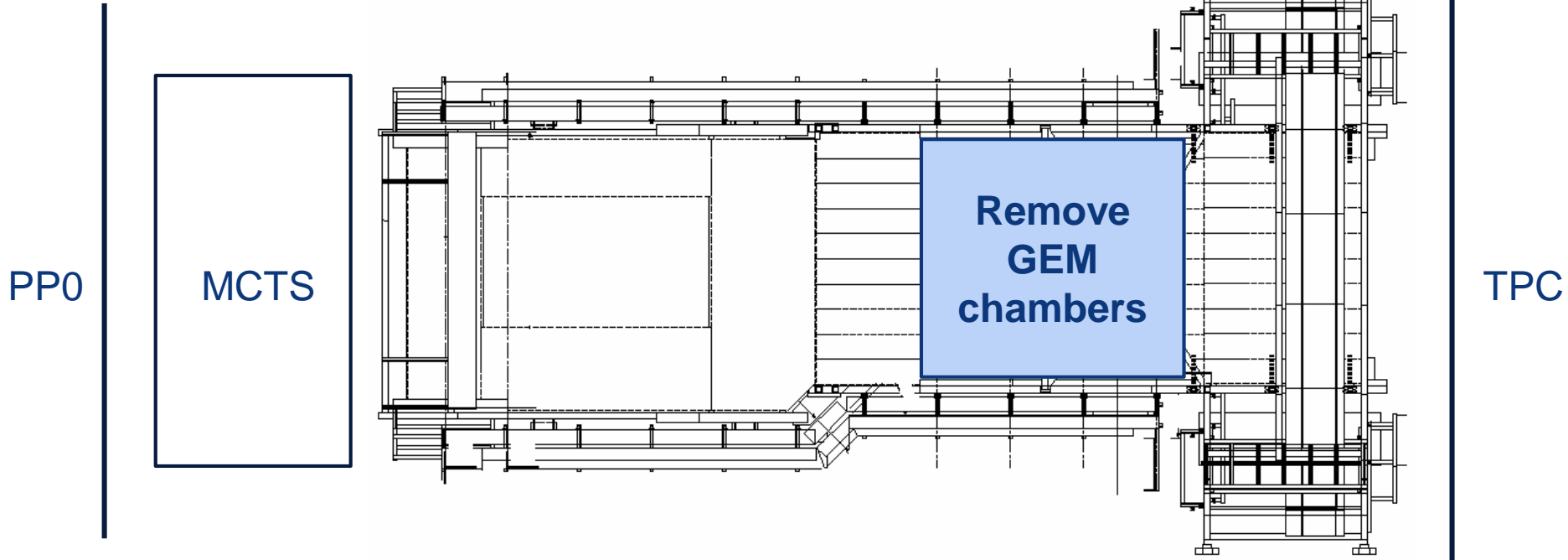

# Miniframe activities w49 – Mon 3 Dec 2018 PM

Miniframe access from 10:00

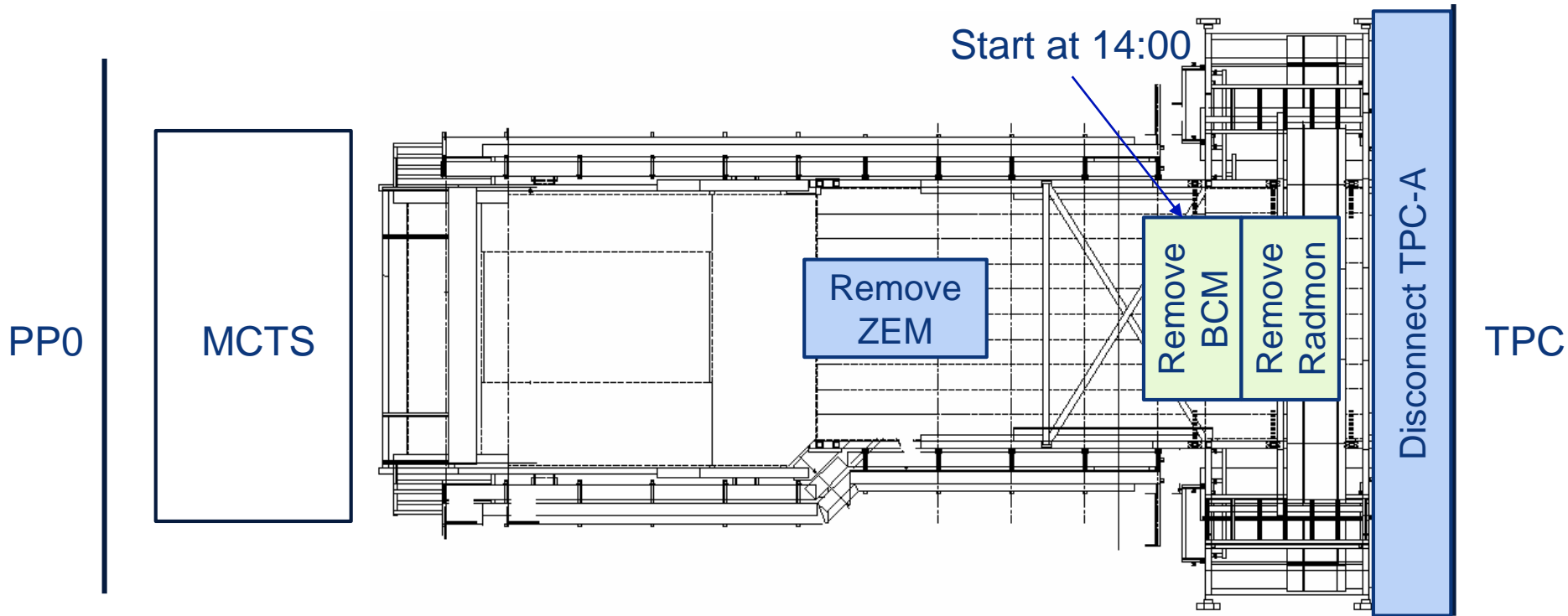

# UX25 activities w49 – Tue 4 Dec 2018

**Cavern access from 10:00, restricted access until 17:00**

**No access CR1-5**

ALTEAD (SX2): start bringing concrete blocks outside

Surface: SX2-CR0 asphalt – until 7 Dec

After 17:00

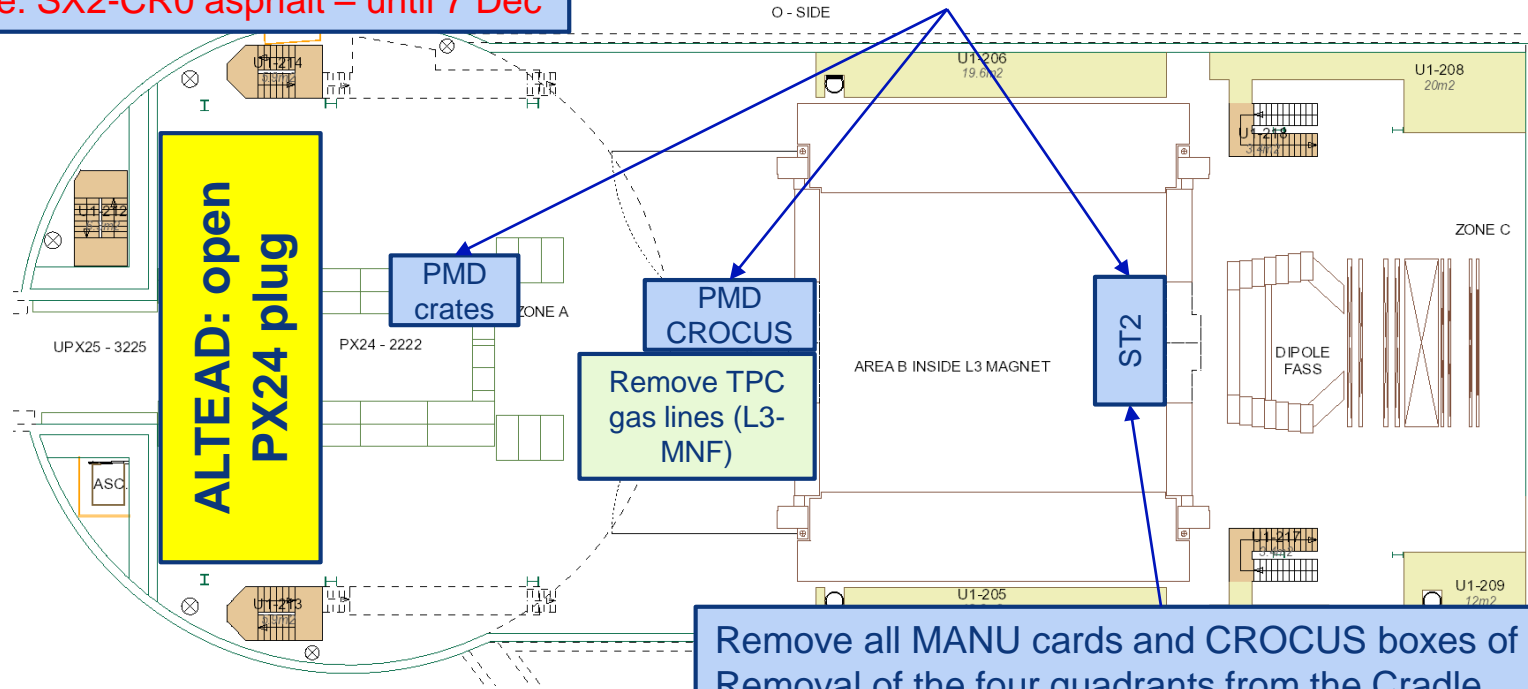

# Miniframe activities w49 – Tue 4 Dec 2018

**Cavern access from 10:00, restricted access until 17:00**

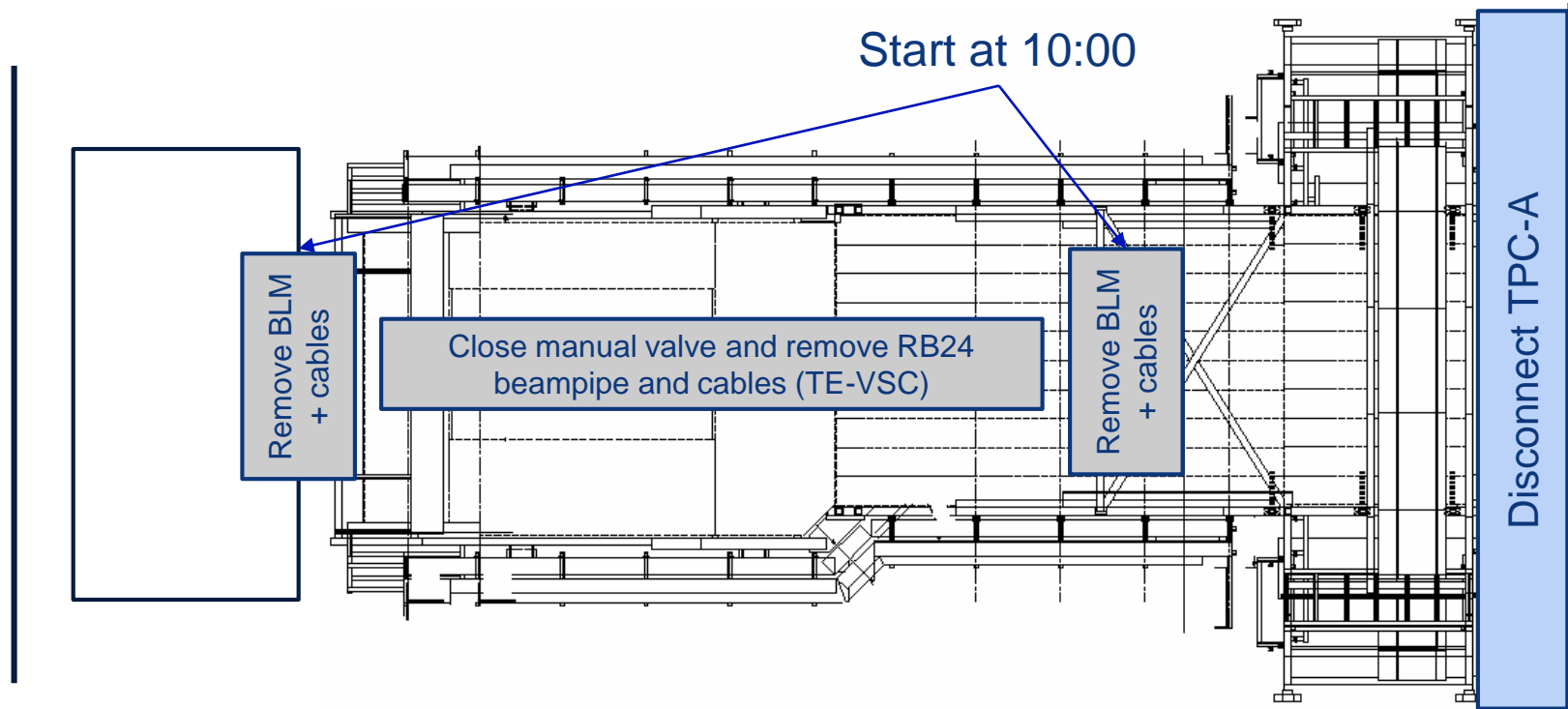

# UX25 activities w49 – Wed 5 Dec 2018

**Cavern access from 10:00, restricted access until 17:00**

Bring down cherry pickers and transport boxes

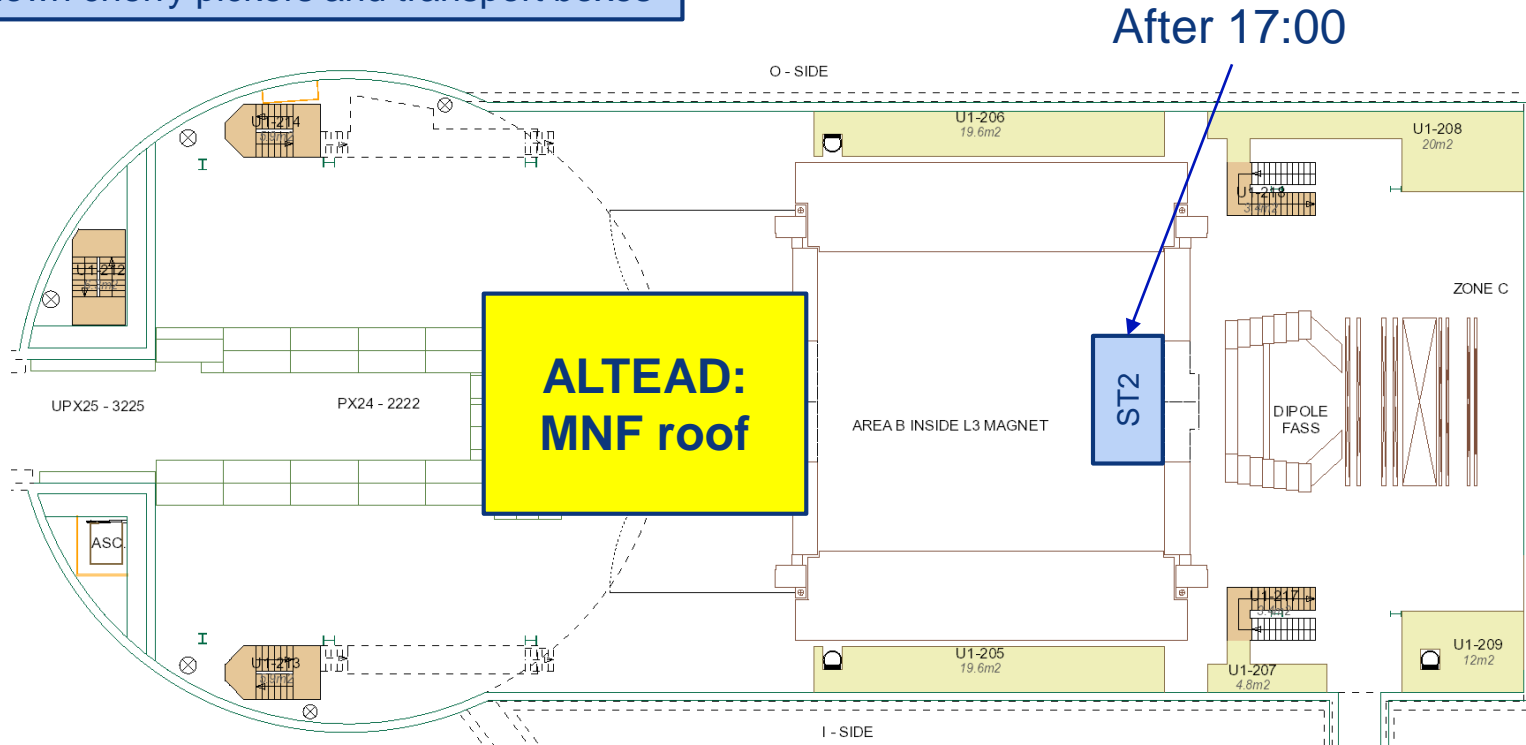

# Miniframe activities w49 – Wed 5 Dec 2018

**Cavern access from 10:00, restricted access until 17:00**

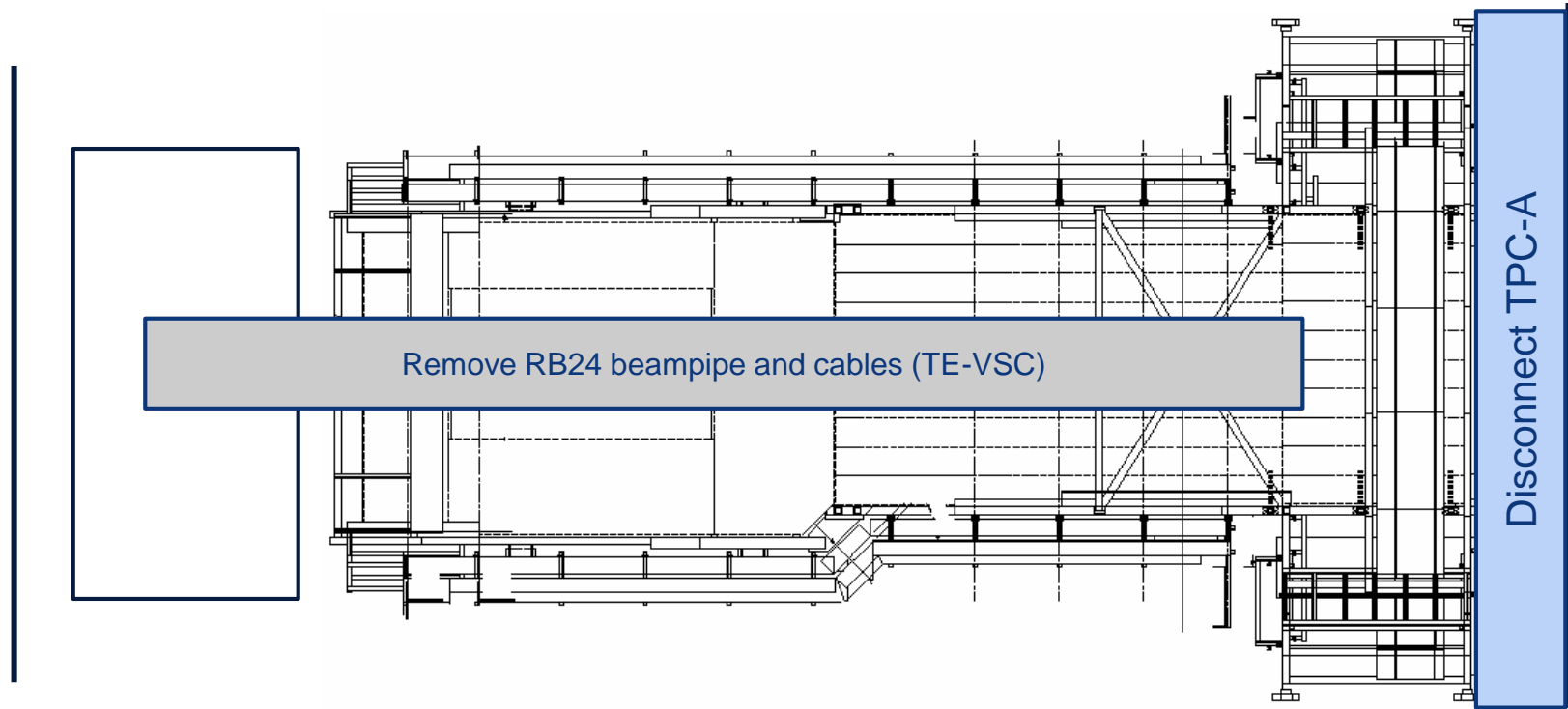

# UX25 activities w49 – Thu 6 Dec 2018

**Cavern access from 10:00, restricted access until 17:00**

ALTEAD: bring down the VSC transportation box

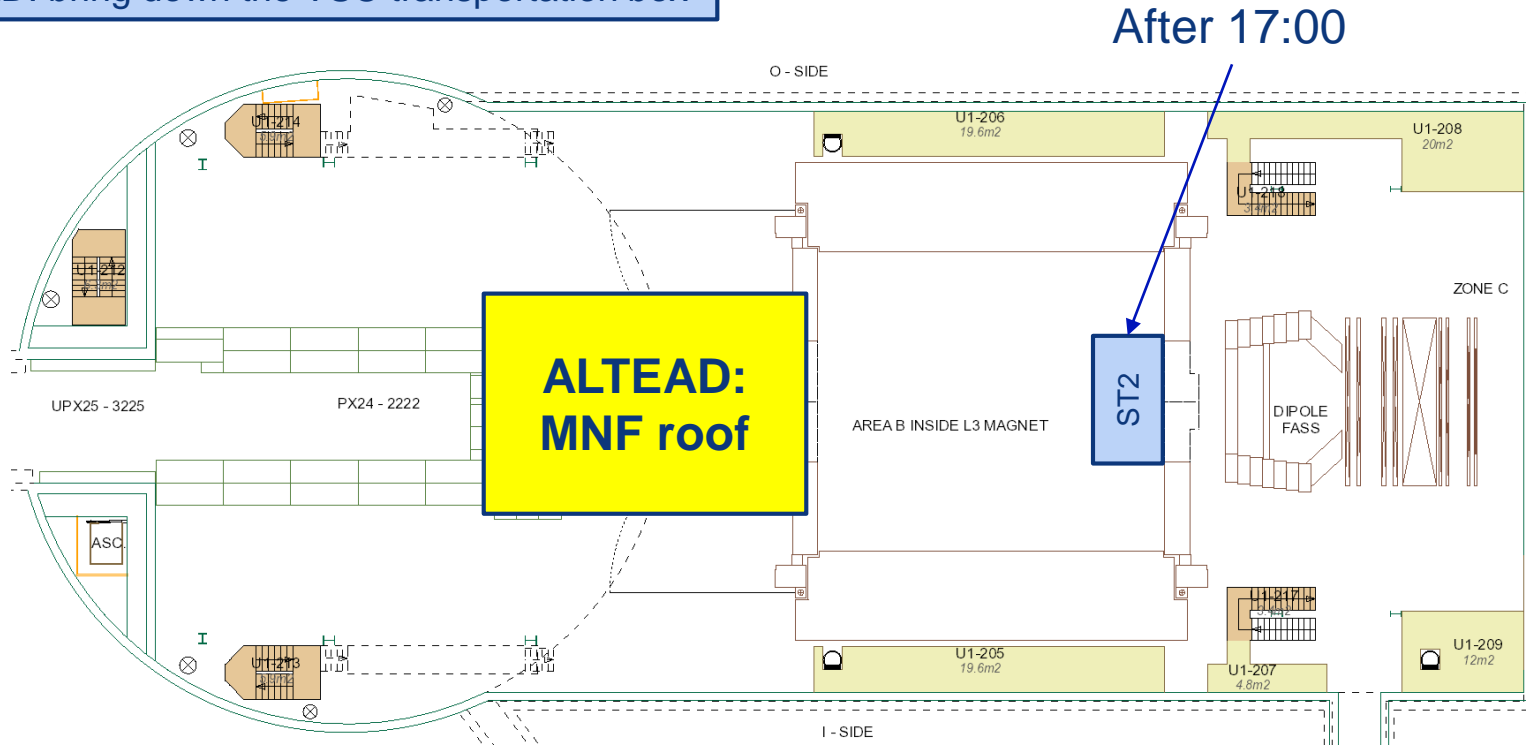

# Miniframe activities w49 – Thu 6 Dec 2018

**Cavern access from 10:00, restricted access until 17:00**

ALTEAD: evacuate RB24 beampipe (→ FLEX)

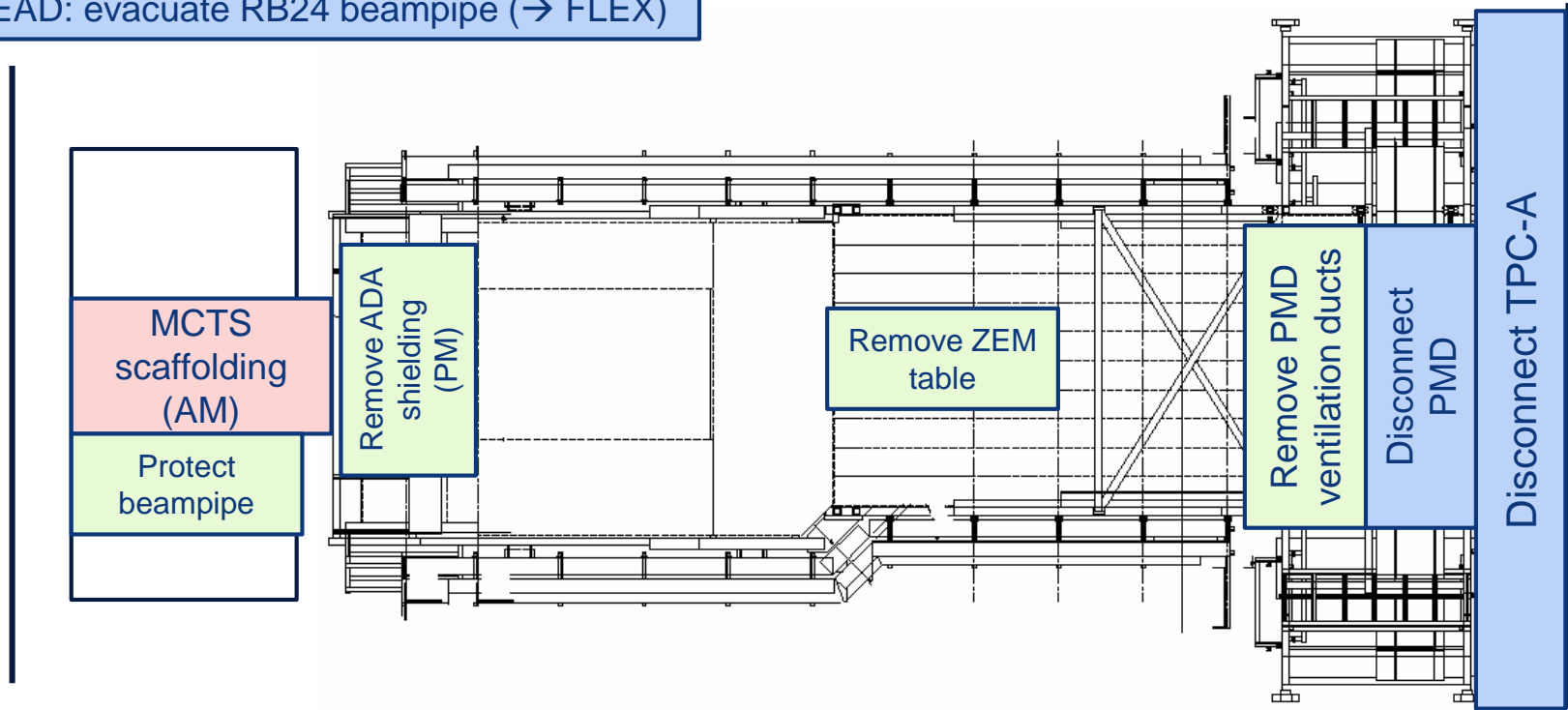



# UX25 activities w49 – Fri 7 Dec 2018

**Cavern access from 10:00, restricted access until 17:00**

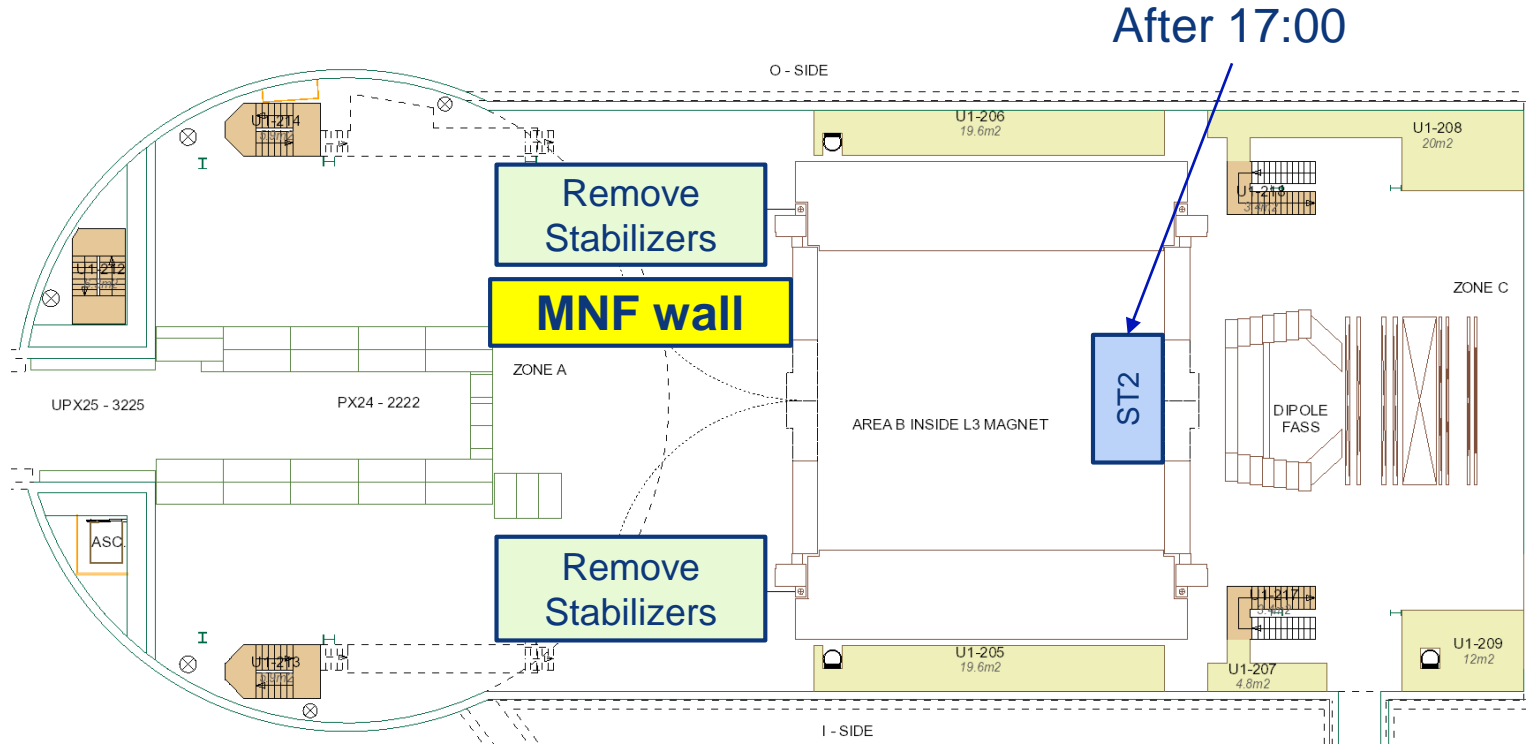

# Miniframe activities w49 – Fri 7 Dec 2018

Cavern access from 10:00, restricted access until 17:00

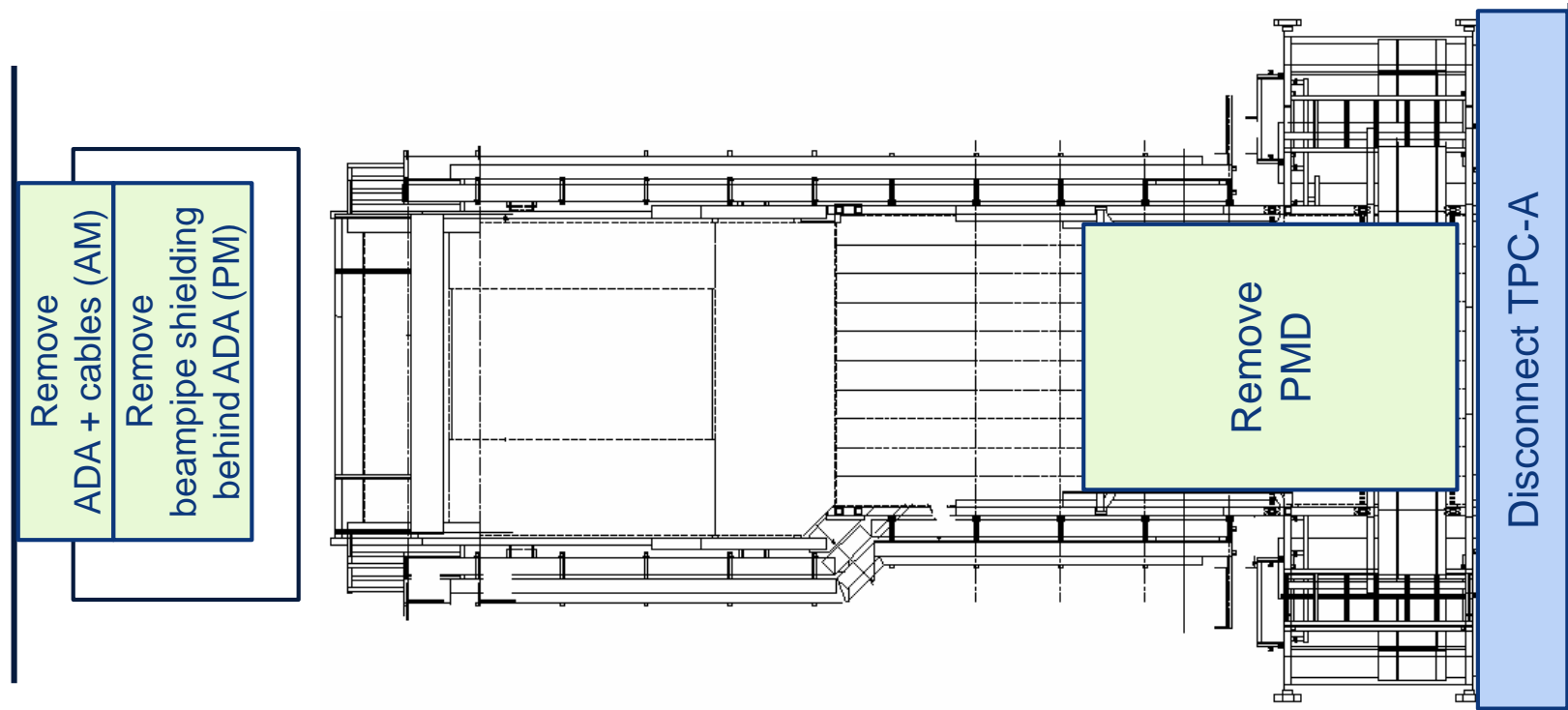

# Miniframe activities w49 – Sat 8 and Sun 9 Dec

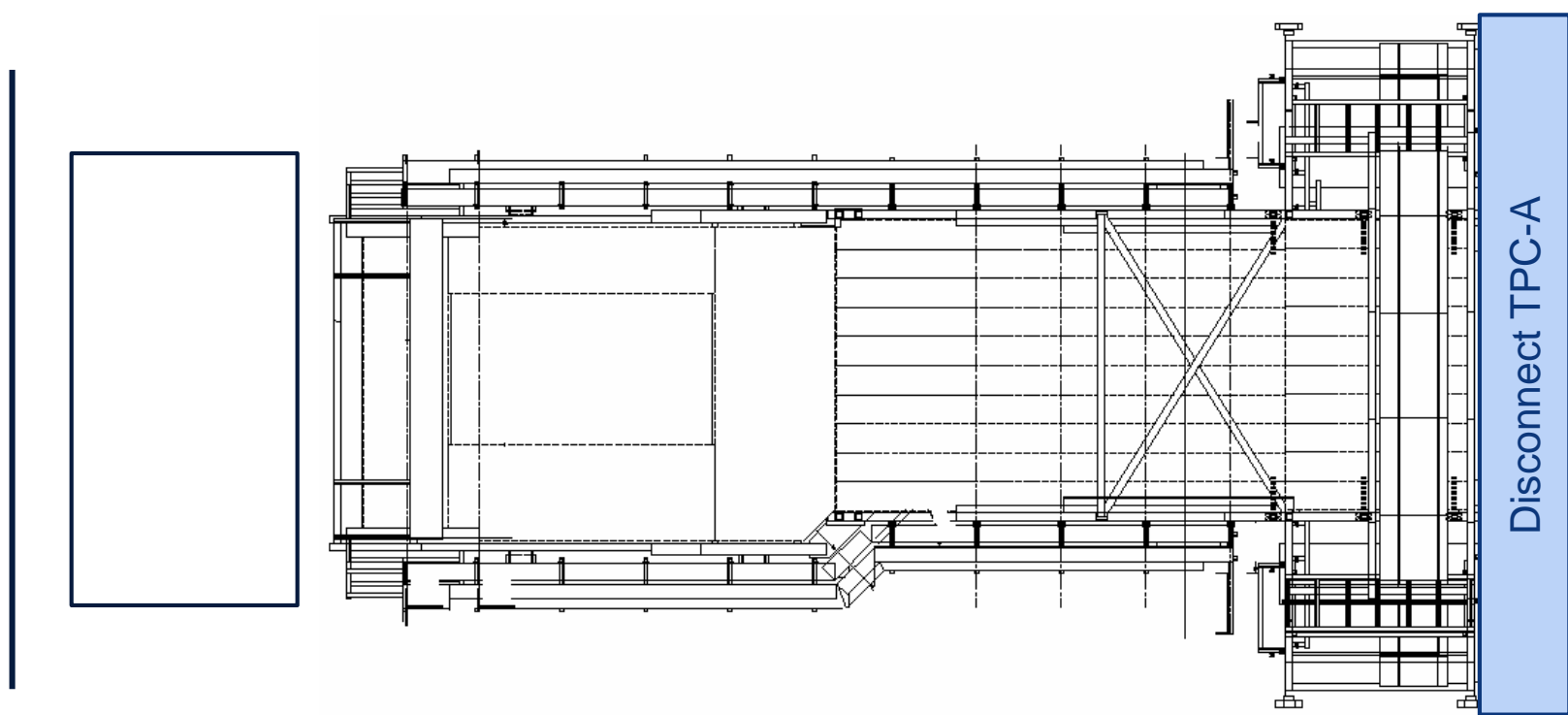

# Day-by-day sequence w50



# UX25 activities w50 – Mon 10 Dec 2018

**Cavern access from 10:00**

ALTEAD (SX2): start bringing big PX24 beams outside

Start emptying CR1

ALTEAD transport 2 ST2 quadrants to SX2 (1h)

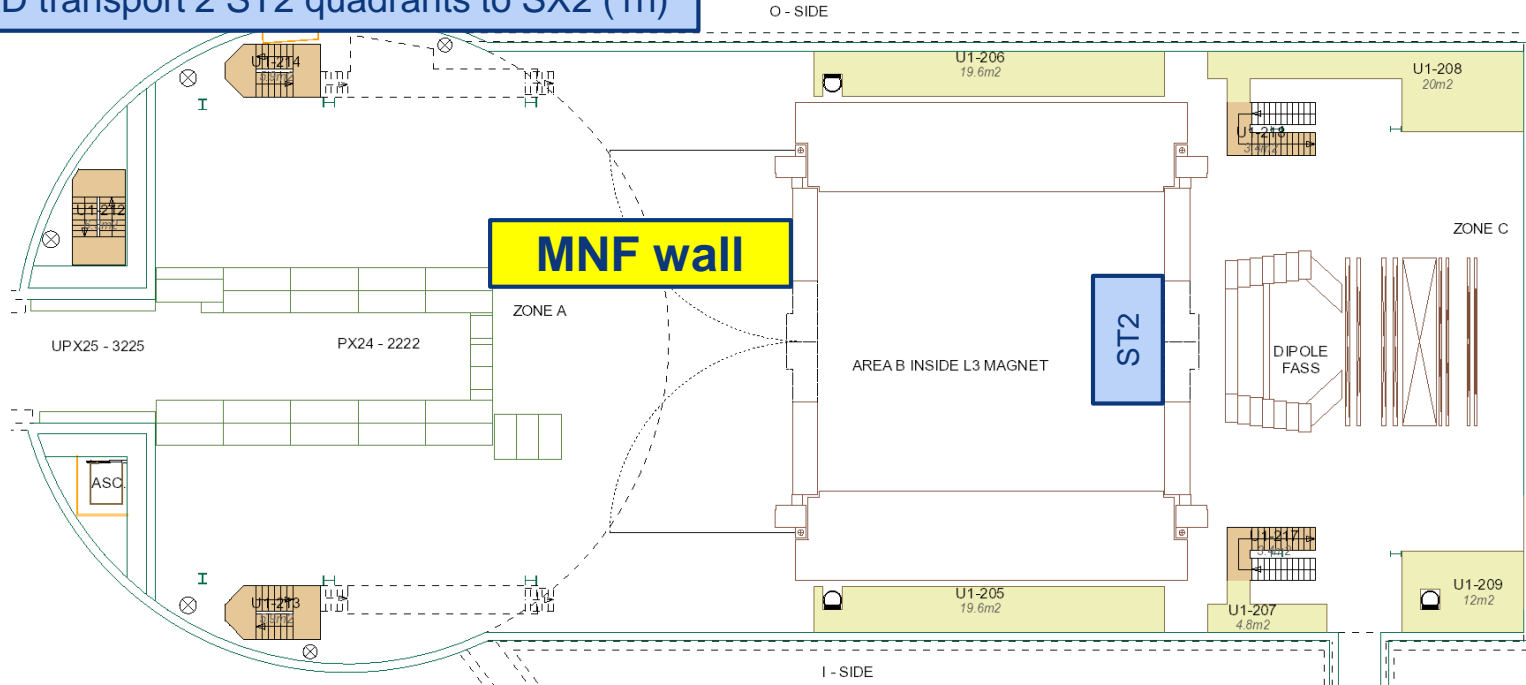

# Miniframe activities w50 – Mon 10 Dec 2018

Cavern access from 10:00

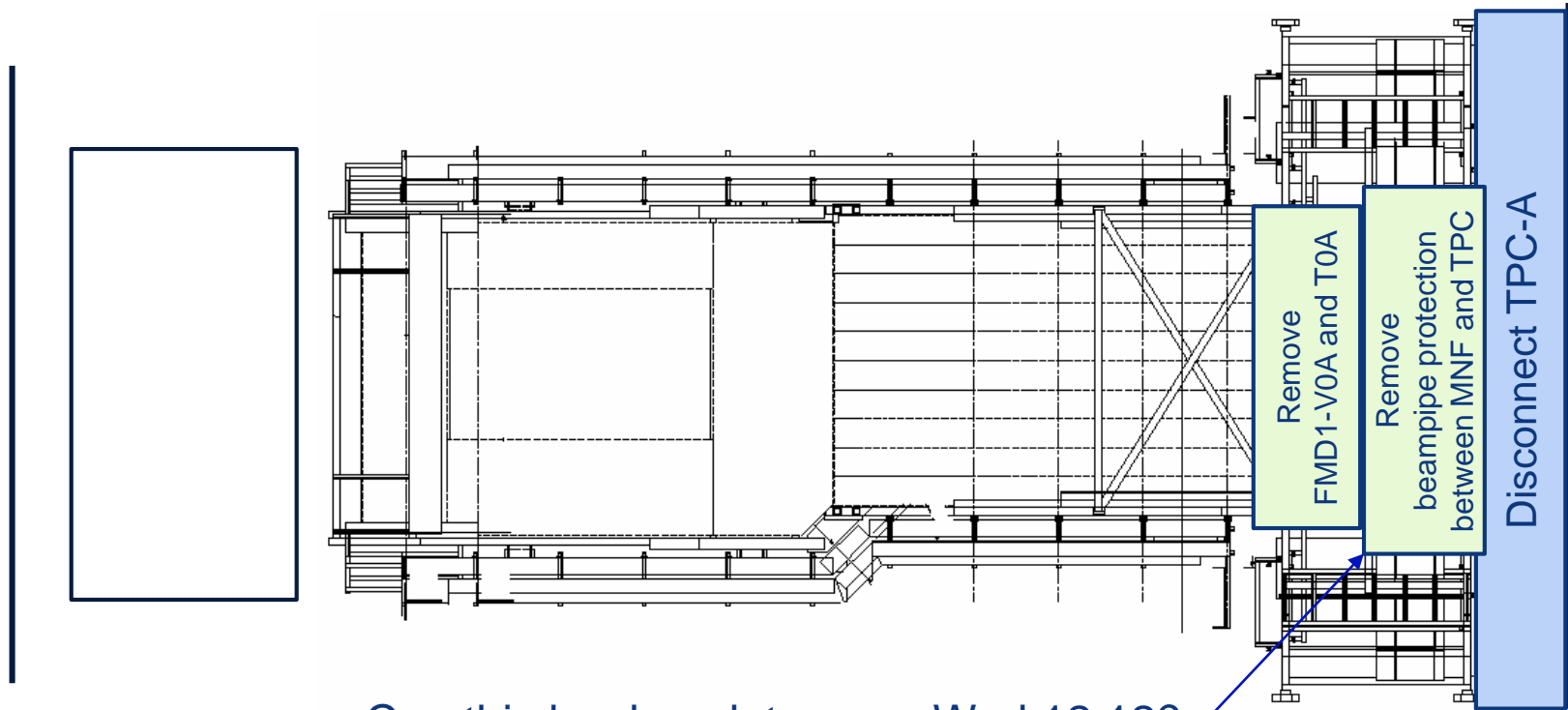

Can this be done later, e.g. Wed 12.12?

# UX25 activities w50 – Tue 11 Dec 2018

Unrestricted cavern access

Start LHC tunnel access

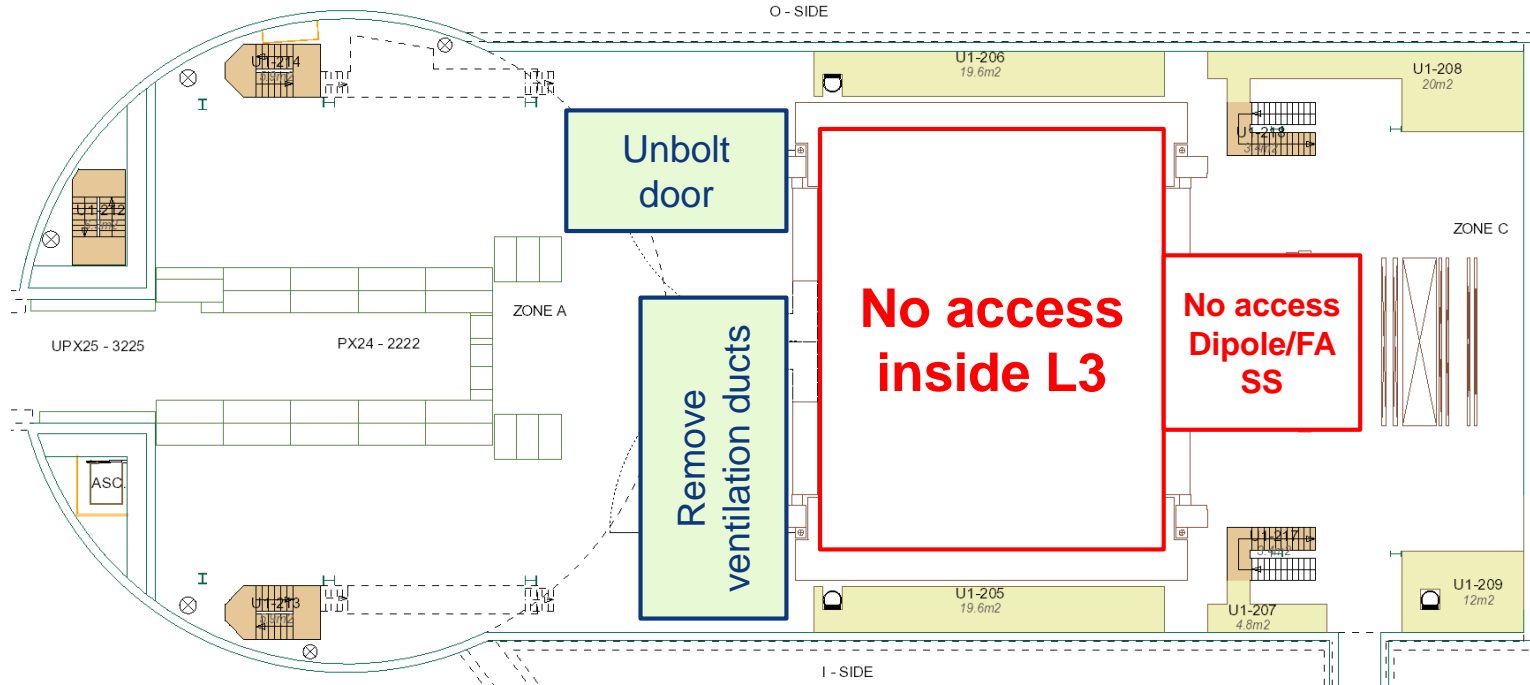

# Miniframe activities w50 – Tue 11 Dec 2018

## Unrestricted cavern access

Electrical lock-out compensator magnet (TE-MS)

Remove  
beampipe  
sticking out from  
LHC tunnel

Disconnect  
power and  
cooling  
comp.magnet

Disconnect ITS PP1  
(attach cables on TPC)

Disconnect TPC-A (after working hours)

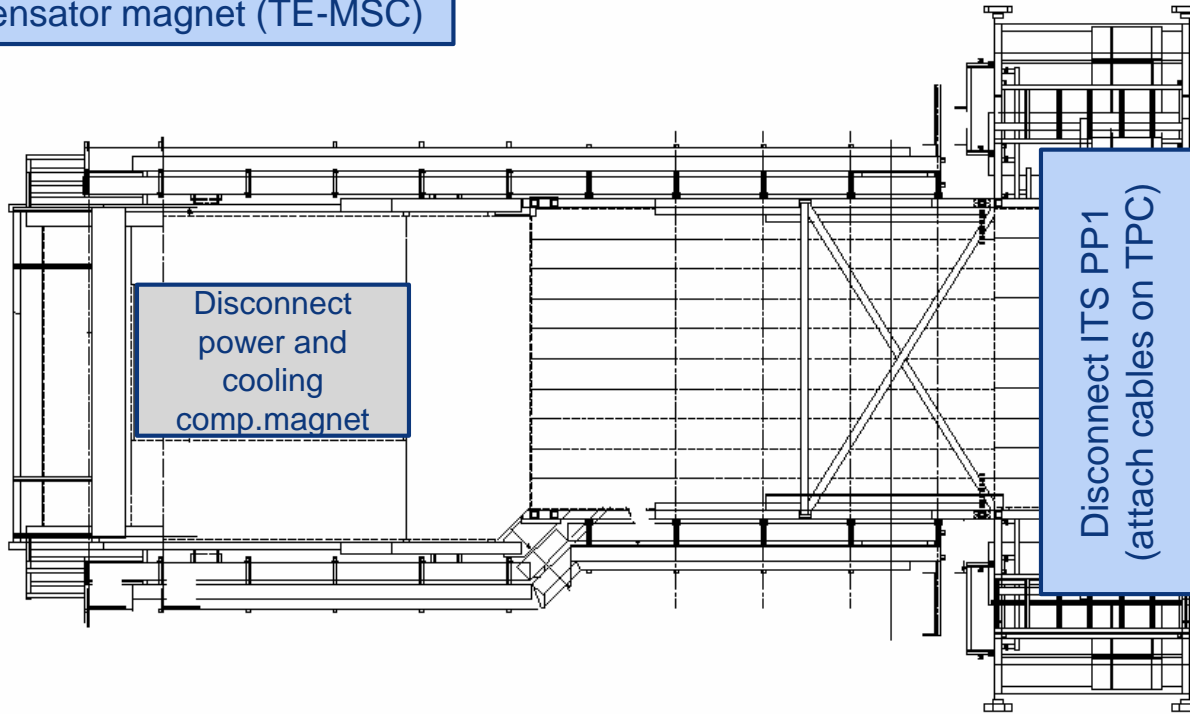



# UX25 activities w50 – Wed 12 Dec 2018

Unrestricted cavern access

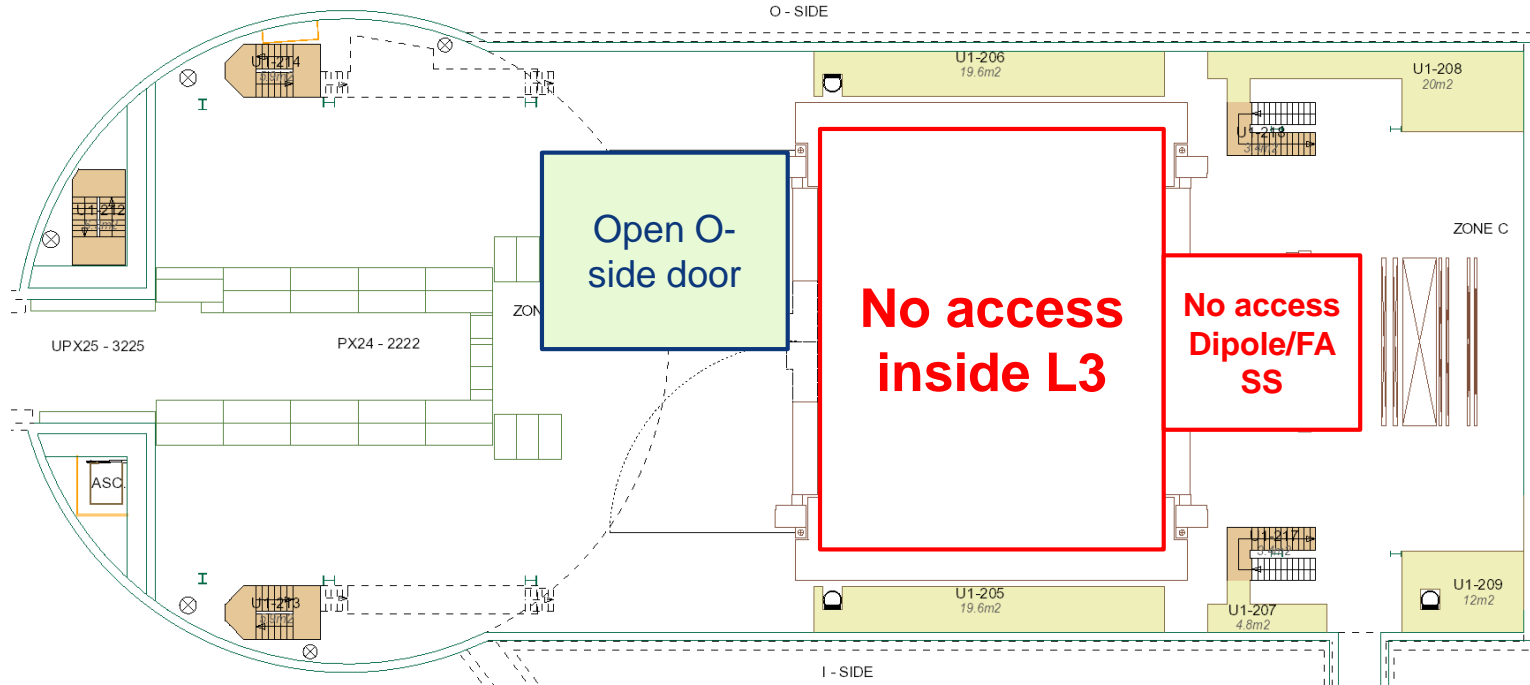

# Miniframe activities w50 – Wed 12 Dec 2018

## Unrestricted cavern access

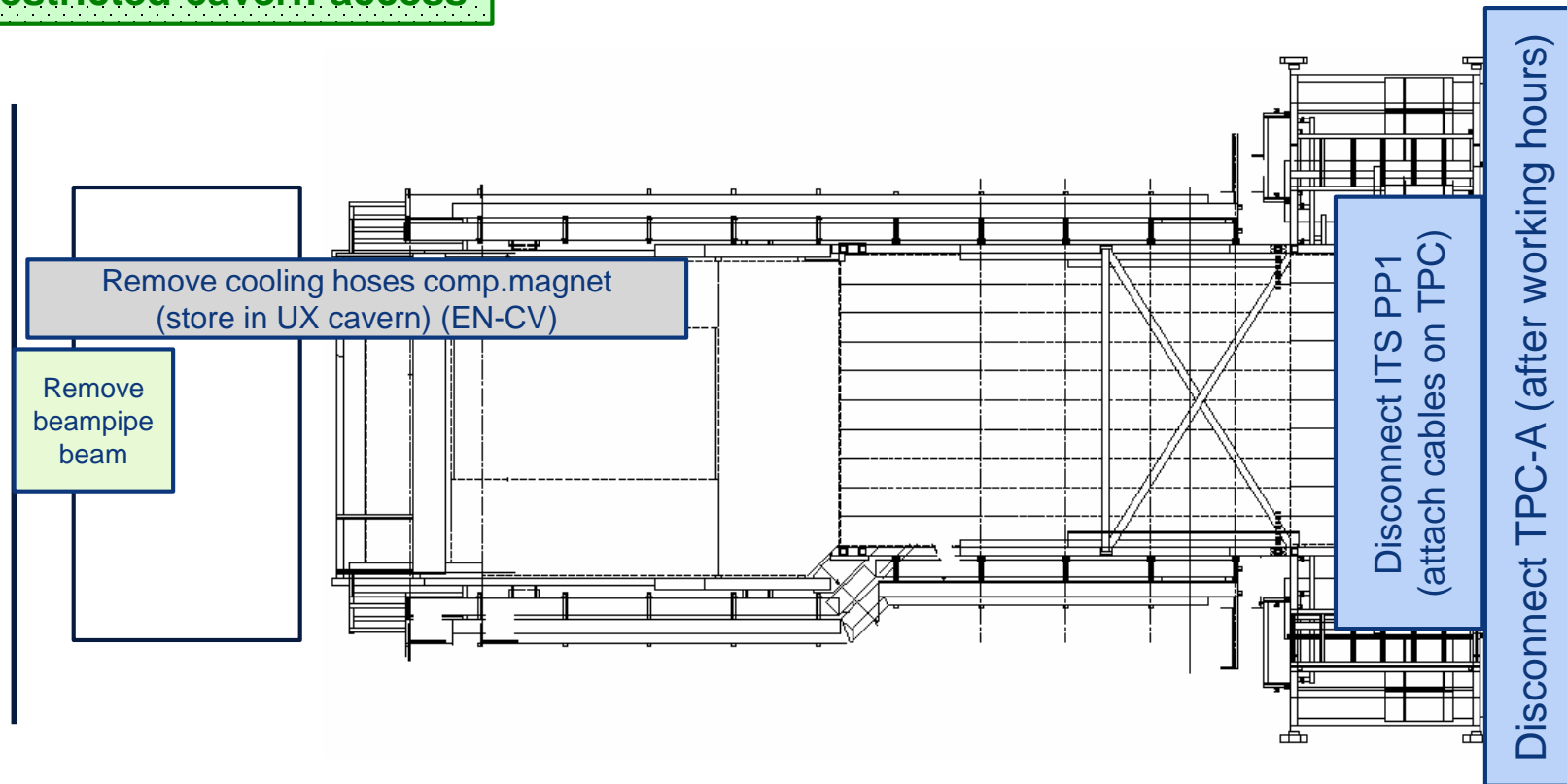

# UX25 activities w50 – Thu 13 Dec 2018

**Cavern access from 10:00**

**Start L3 access without watcher**

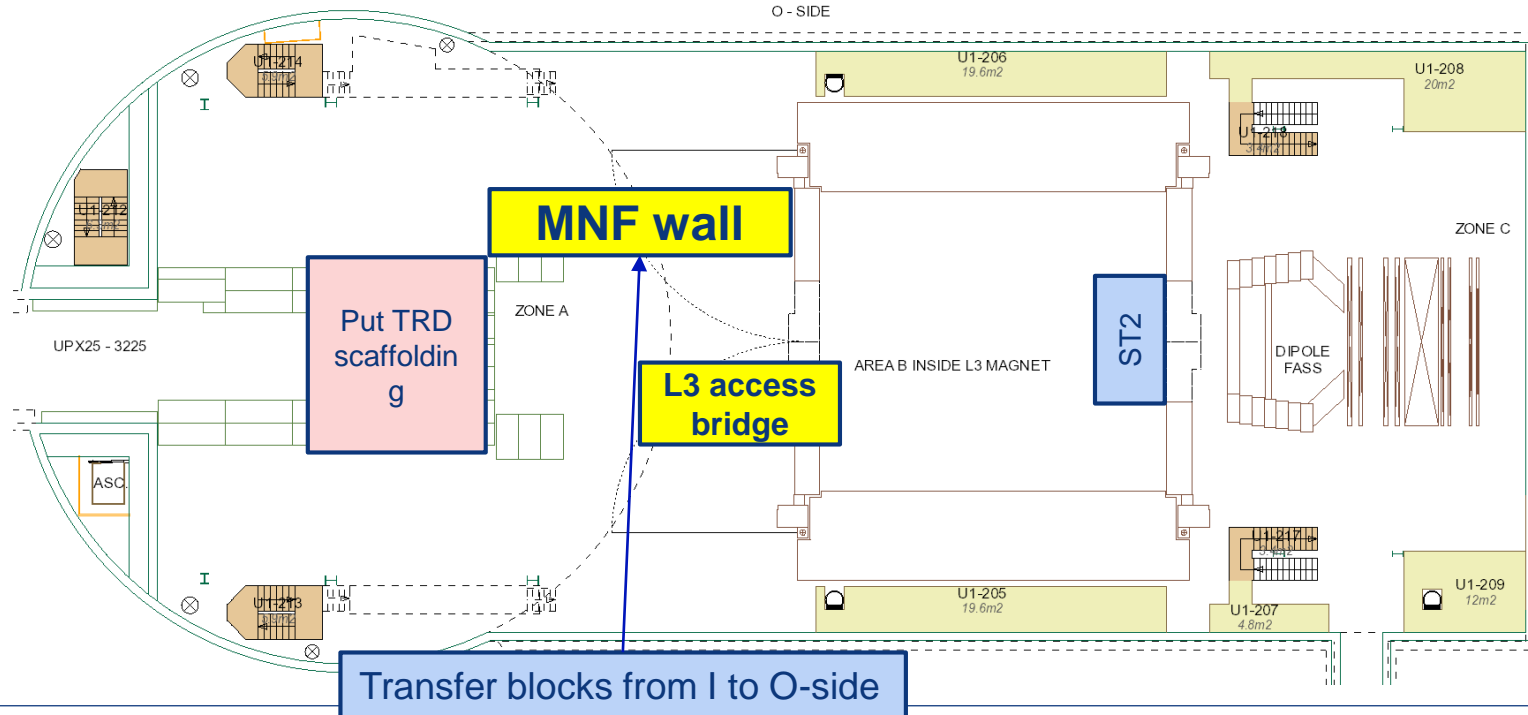

# Miniframe activities w50 – Thu 13 Dec 2018

Cavern access from 10:00

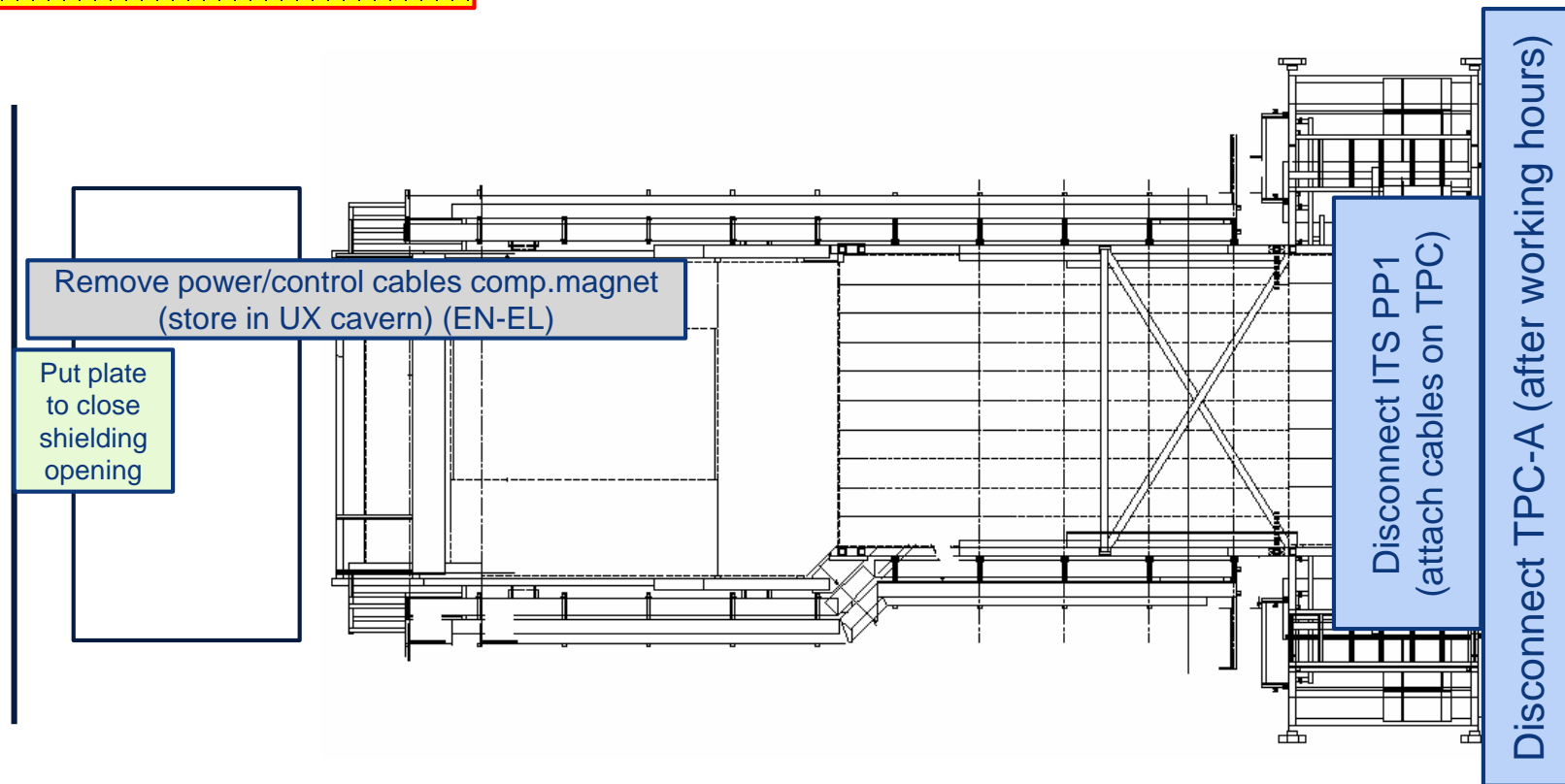

# UX25 activities w50 – Fri 14 Dec 2018

Unrestricted cavern access

ALTEAD transport 2 ST2 quadrants to SX2 (1h)

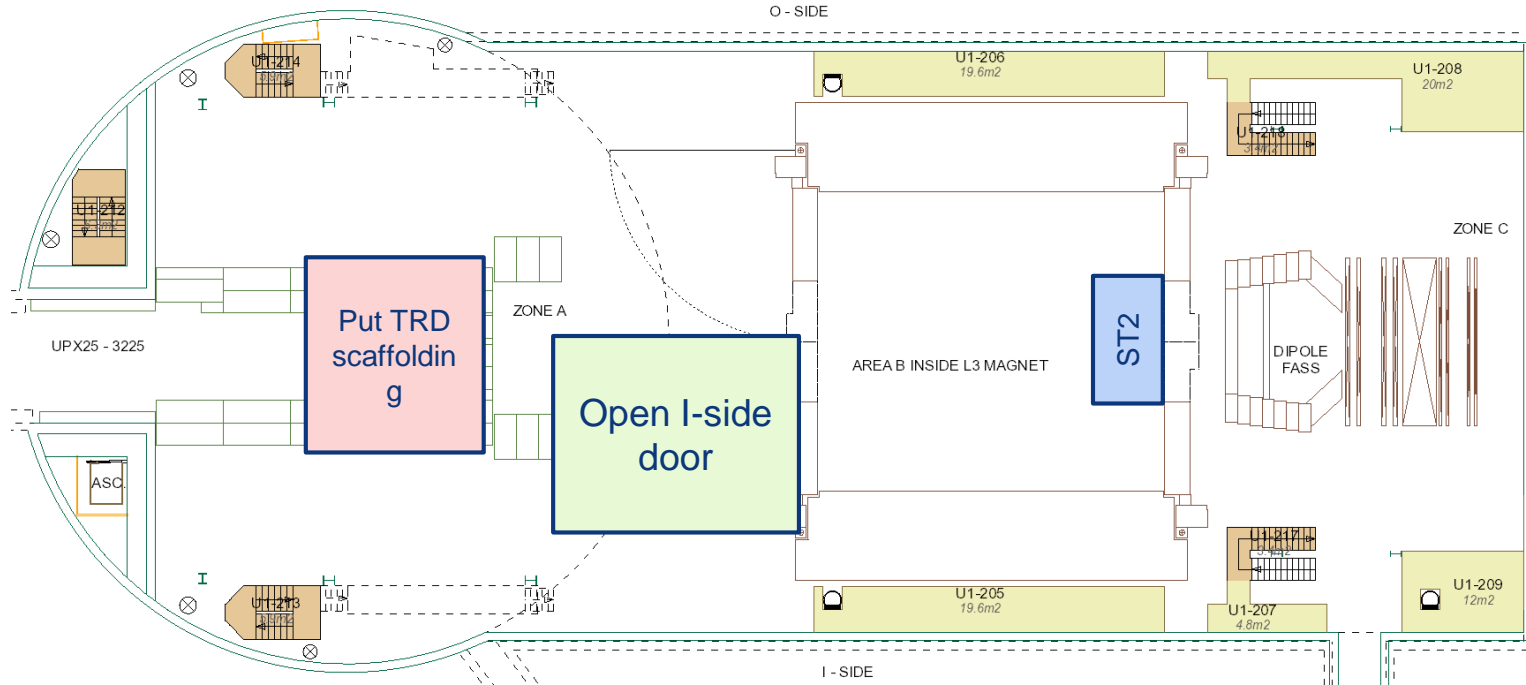

# Miniframe activities w50 – Fri 14 Dec 2018

Unrestricted cavern access

ALTEAD: bring compensator magnet to SX2

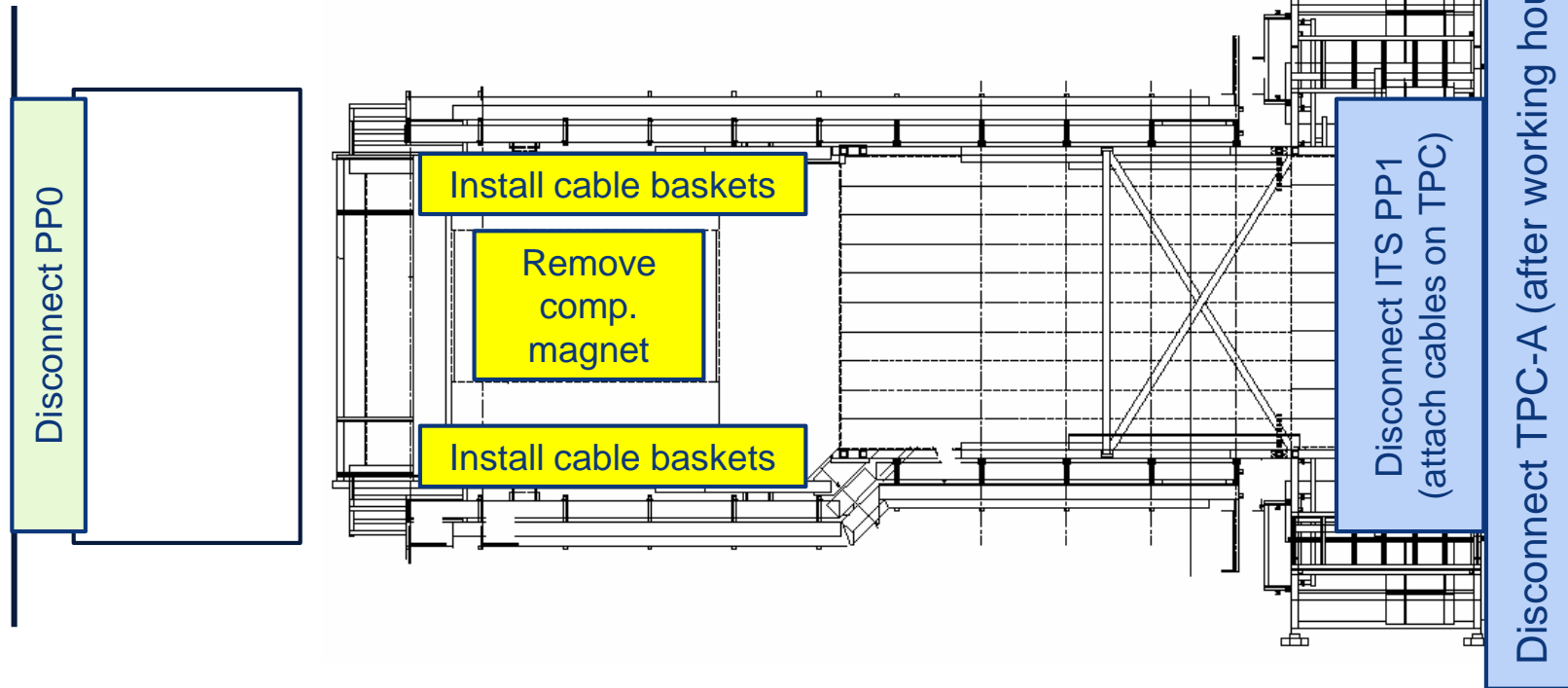

# Day-by-day sequence w51



# UX25 activities w51 – Mon 17 Dec 2018

Unrestricted cavern access

Start UX visits (Sunday 16 December)

TOF: disconnect some services in view of TRD extraction

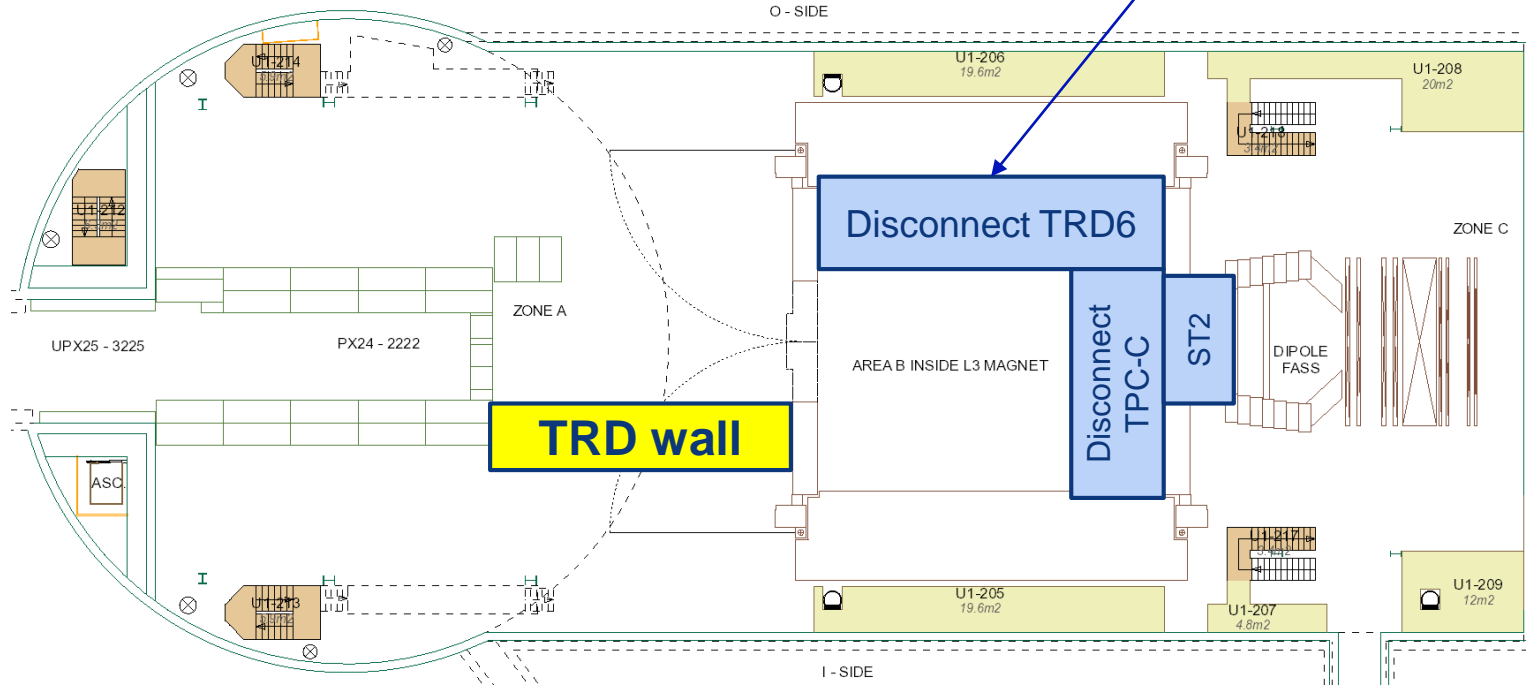



# Miniframe activities w51 – Mon 17 Dec 2018

Unrestricted cavern access

Disconnect TPC laser cables (tbc)

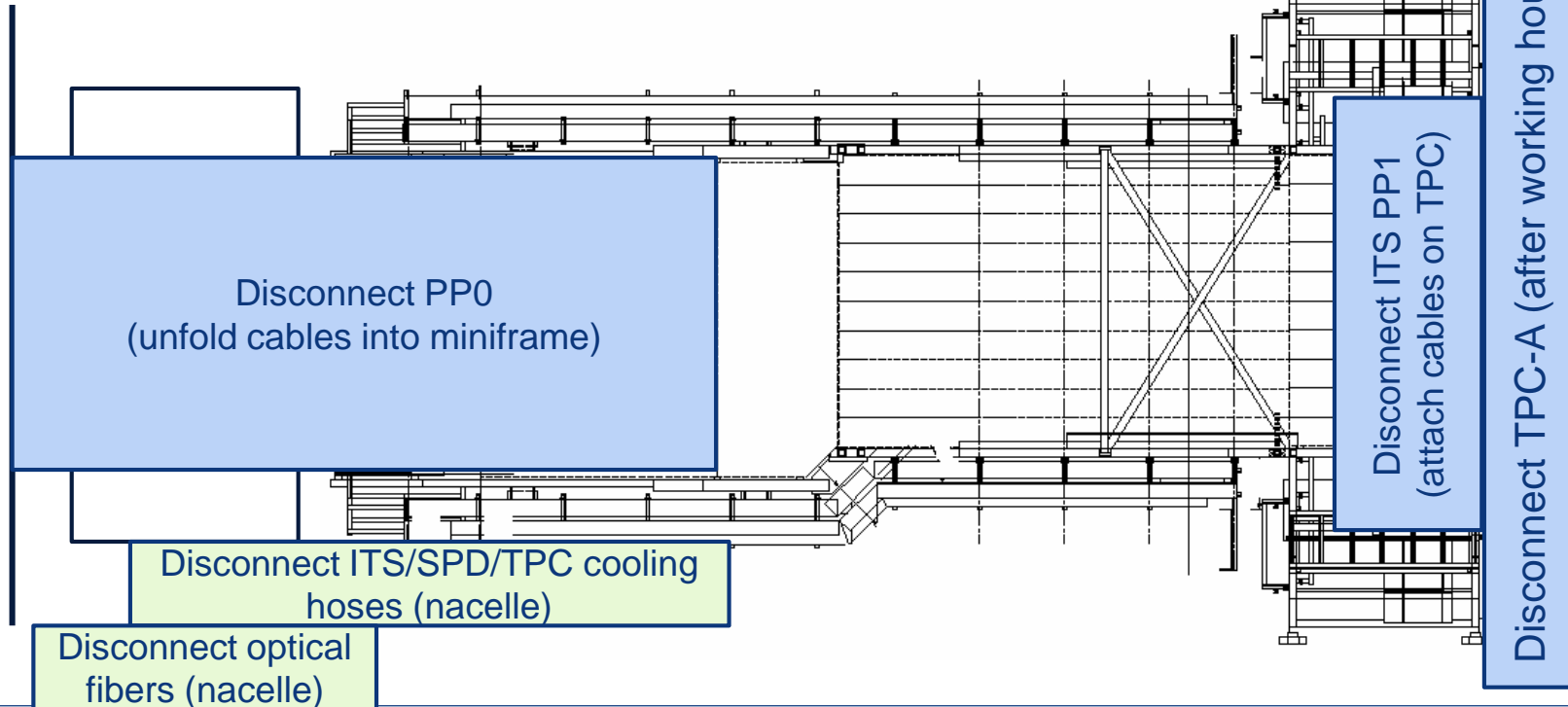

# UX25 activities w51 – Tue 18 Dec 2018

Unrestricted cavern access

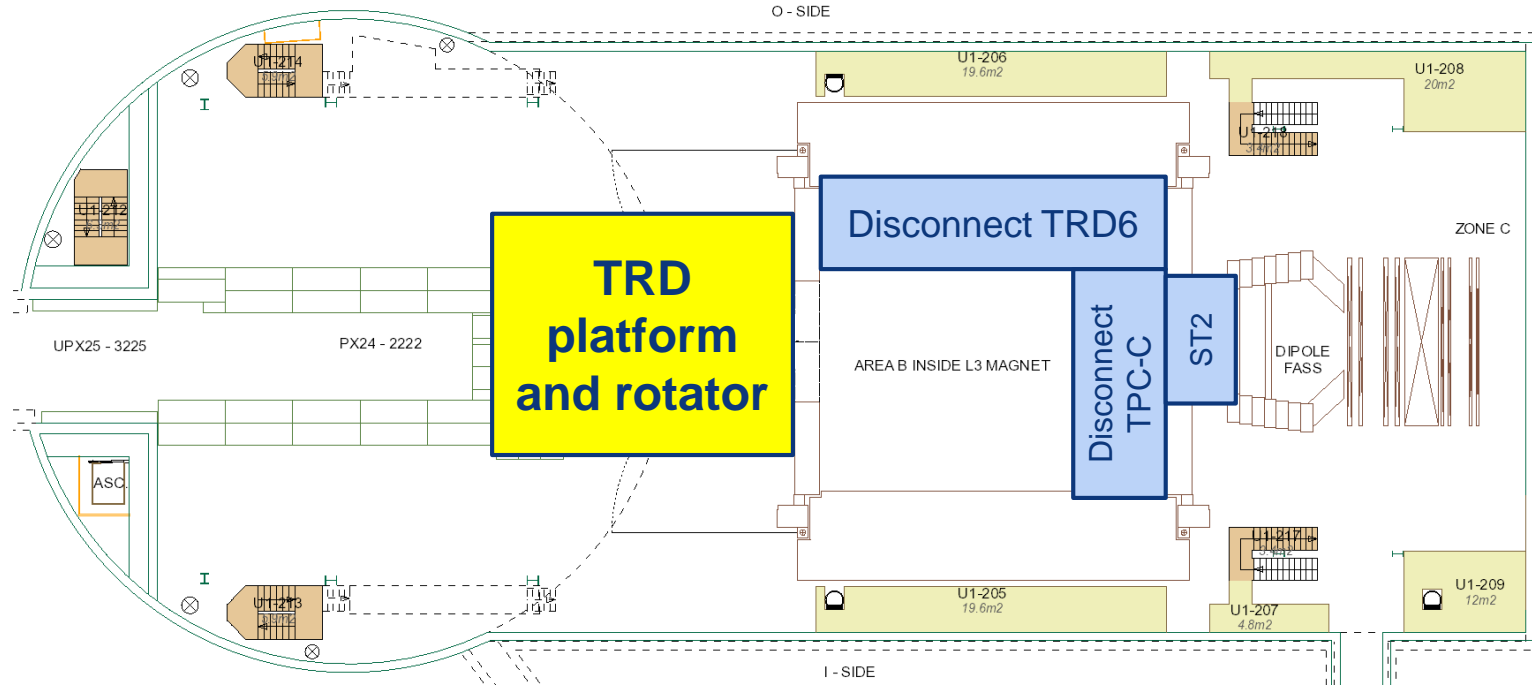

# Miniframe activities w51 – Tue 18 Dec 2018

## Unrestricted cavern access

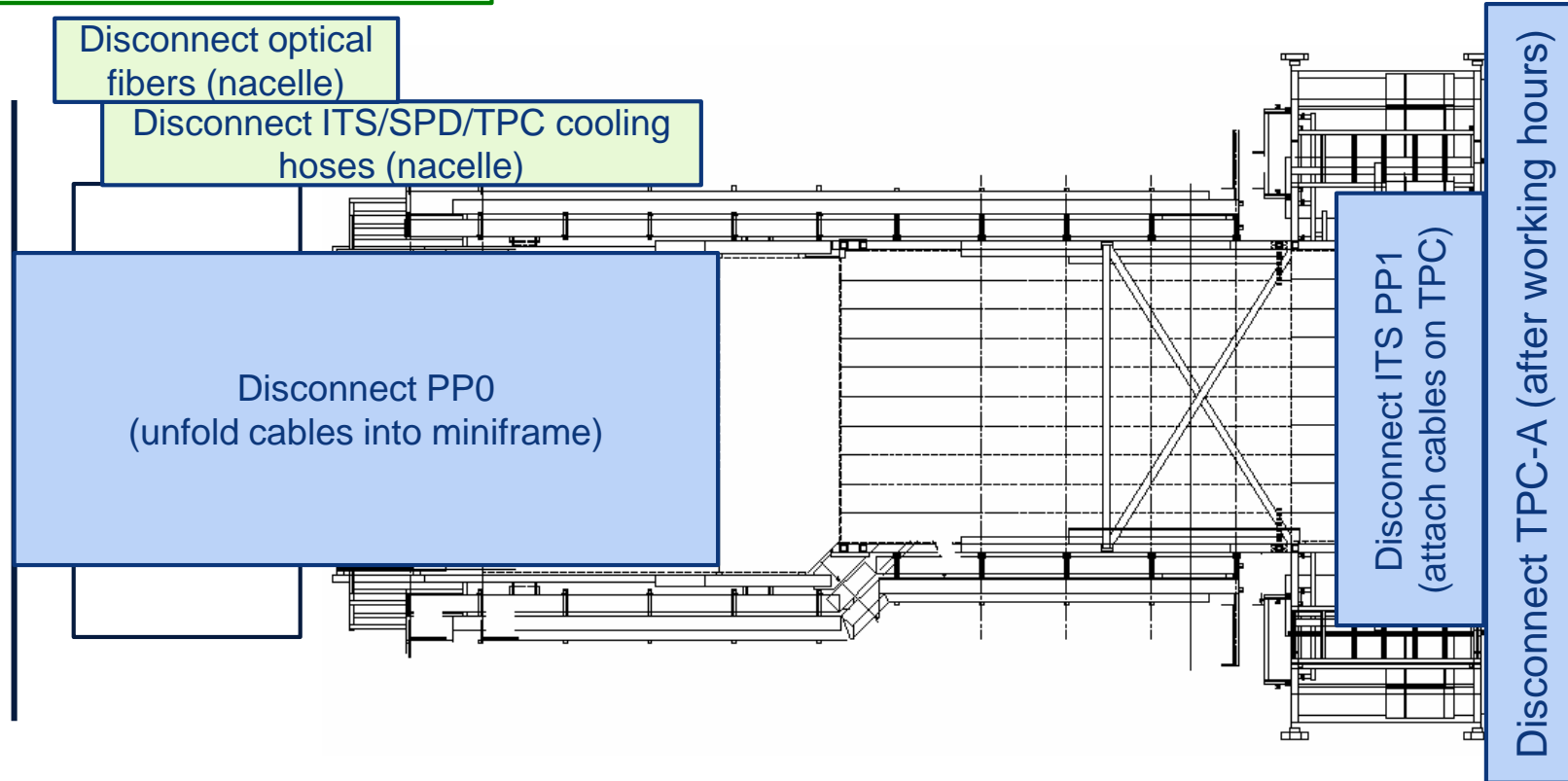

# UX25 activities w51 – Wed 19 Dec 2018

**Unrestricted cavern access**

ALTEAD: bring TRD6 in SXL2 (transfer into blue frame)

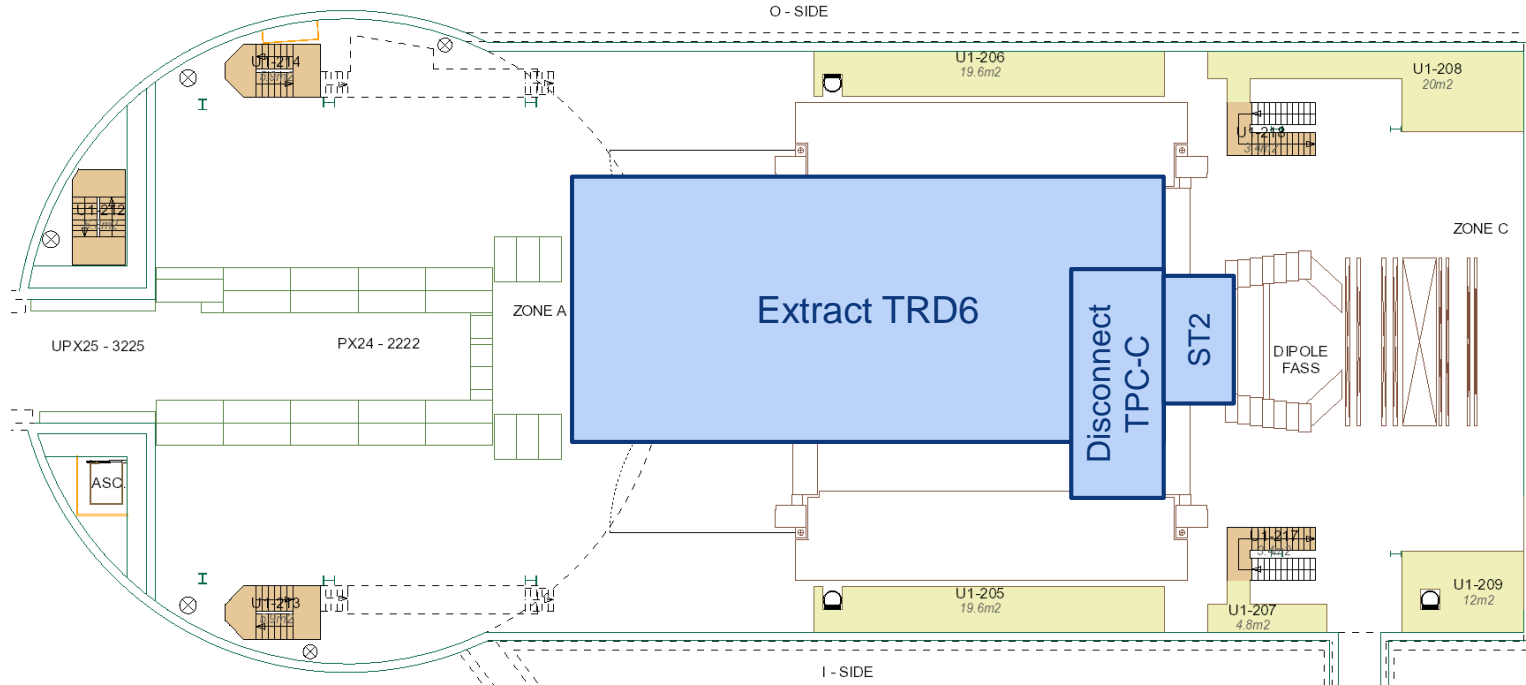

# Miniframe activities w51 – Wed 19 Dec 2018

Unrestricted cavern access

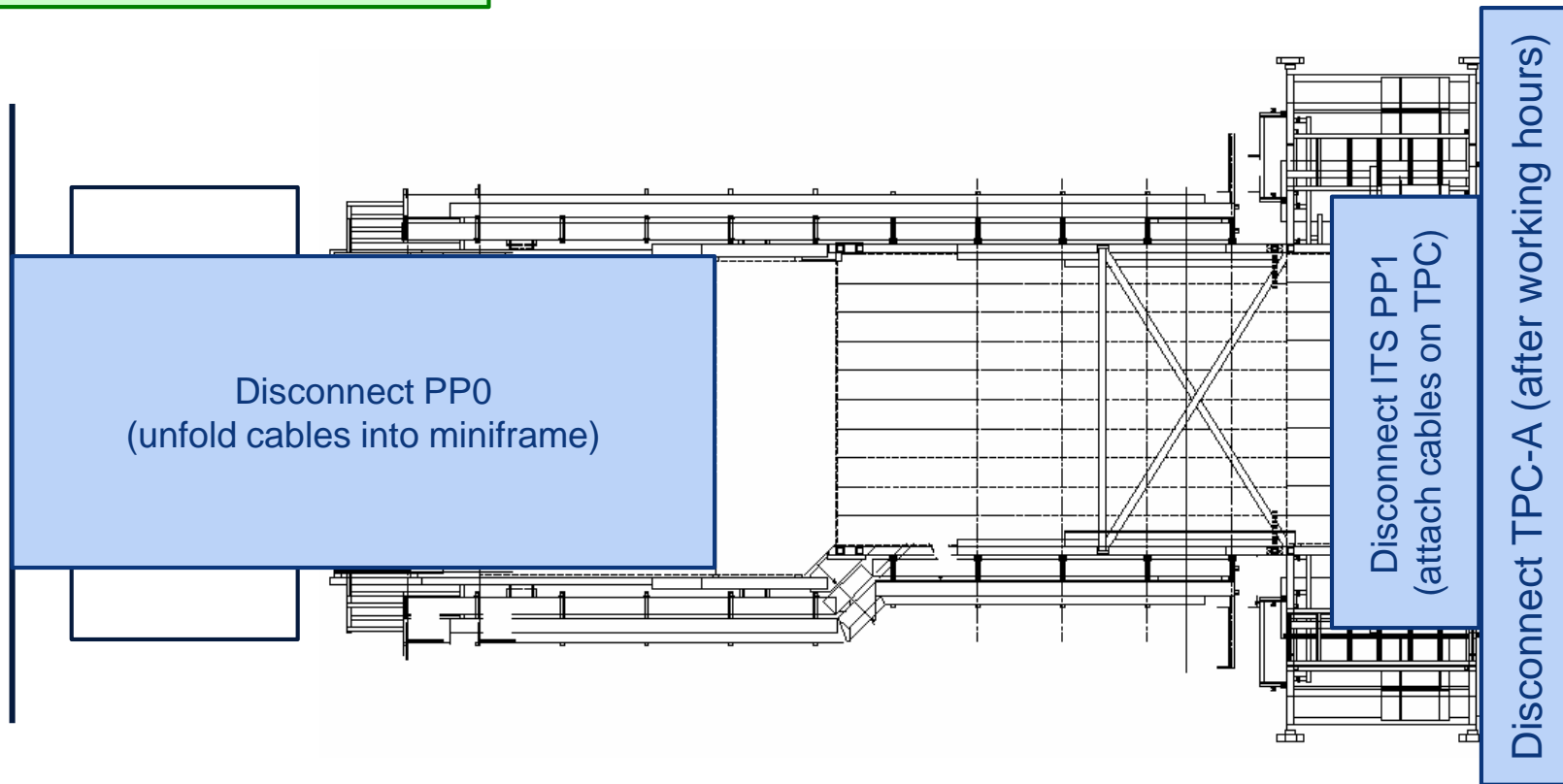

# UX25 activities w51 – Thu 20 Dec 2018

Unrestricted cavern access

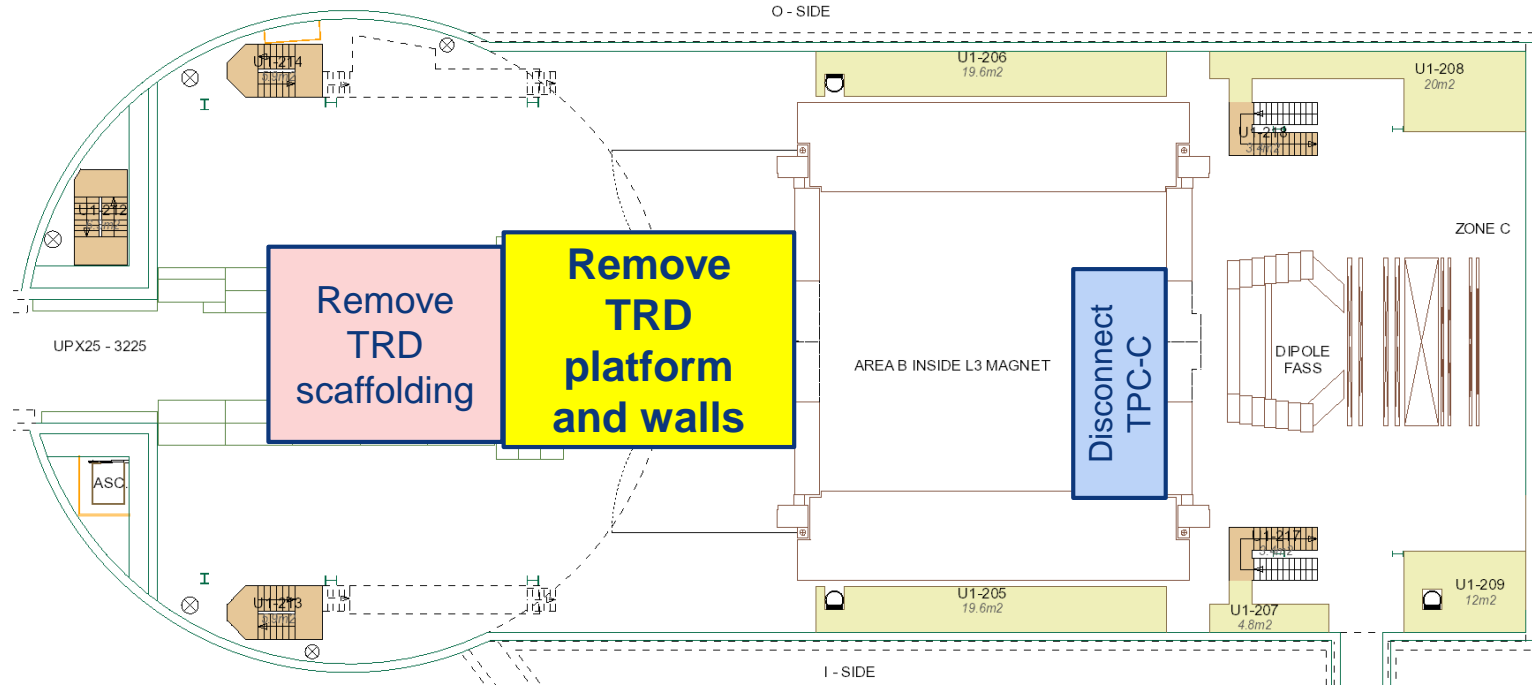

# Miniframe activities w51 – Thu 20 Dec 2018

Unrestricted cavern access

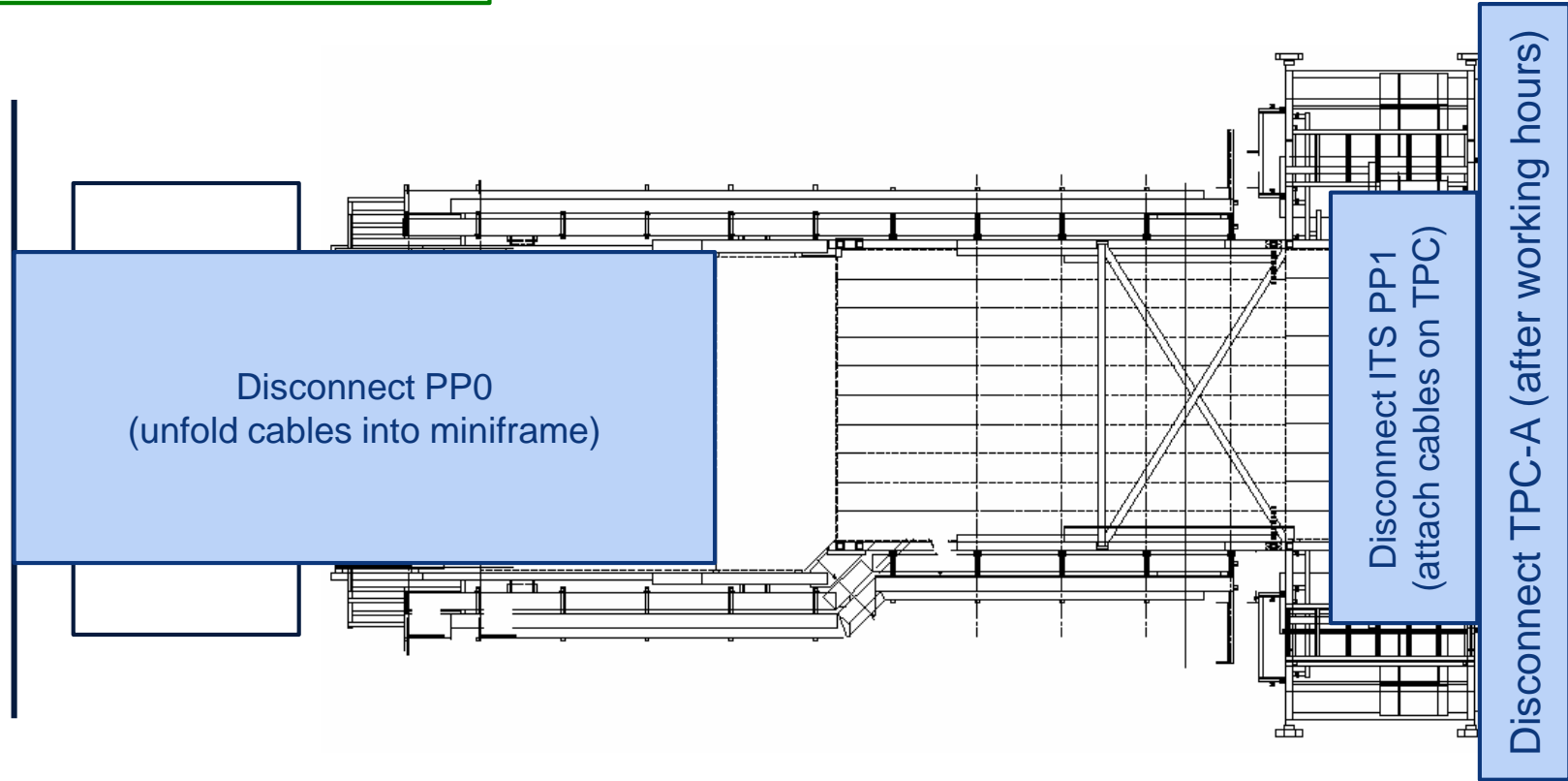

# UX25 activities w51 – Fri 21 Dec 2018

**No access cavern whole day (ALTEAD starts at 6:00 AM)**

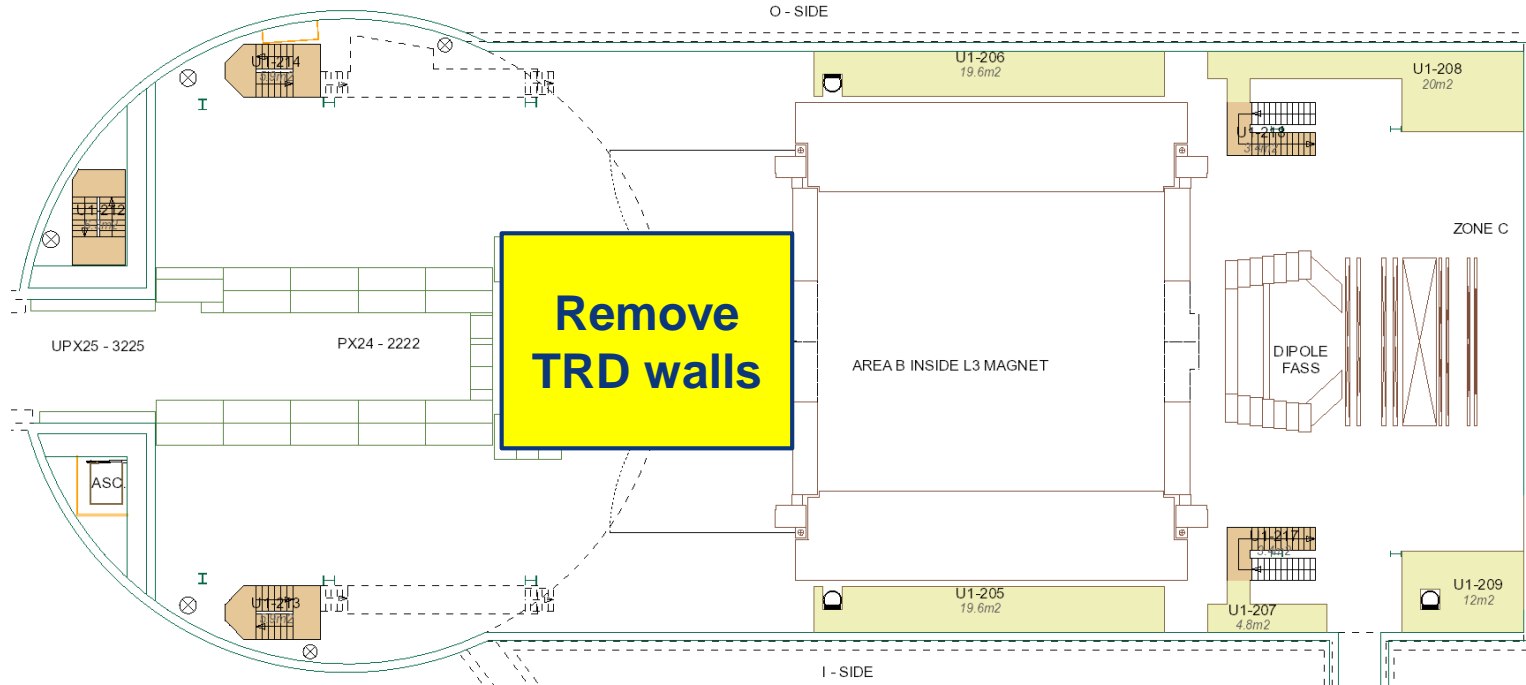



# Miniframe activities w51 – Fri 21 Dec 2018

**No access cavern whole day (ALTEAD starts at 6:00 AM)**

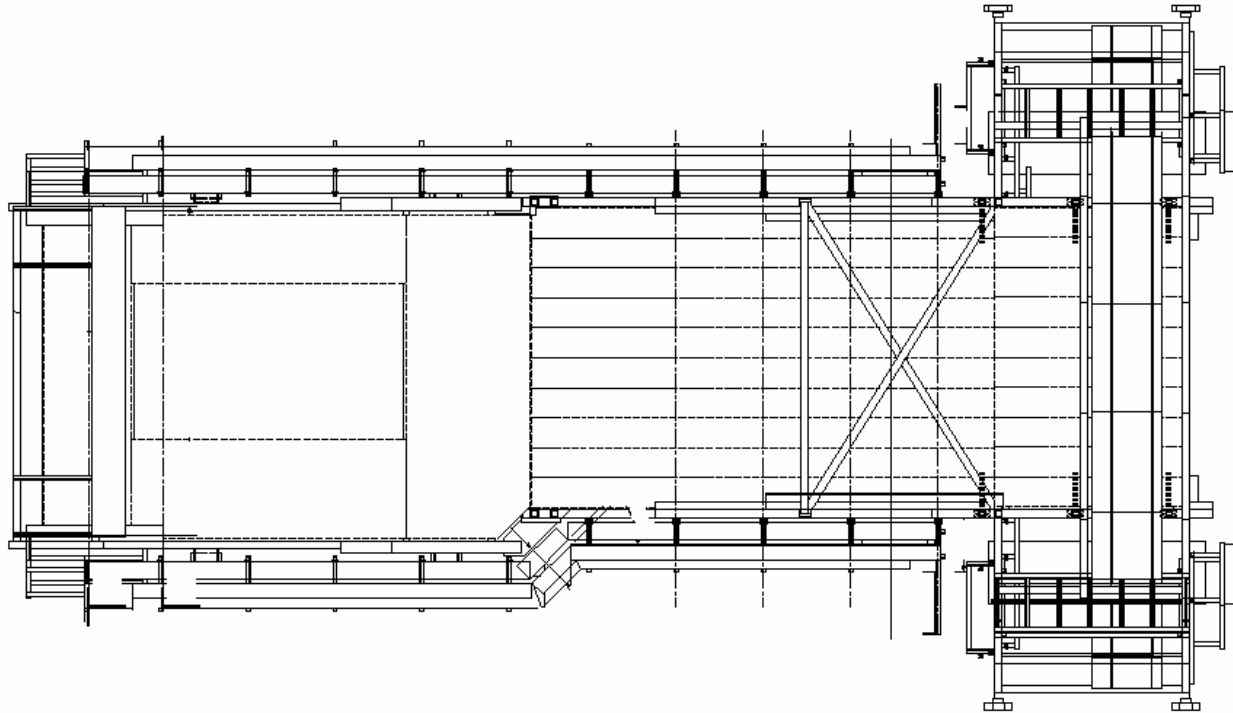
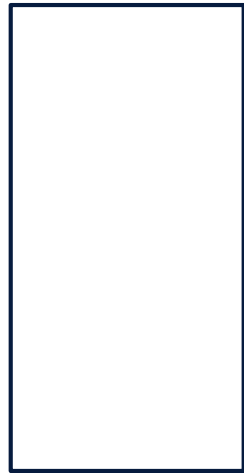

# Storage in December

# SX2 in December, storage

- VOA-FMD1 → FLEX
- ADA → 3297; ADA shielding → SU2
- PMD ventilation pipes → bin
- ZEM → 3297; ZEM table → SU2
- Beampipe + vacuum equip. → VSC
- Beampipe protection → SU2
- BCM → Pieter
- BLM → BLM team
- TPC black hoses and supports → 3297
- ITS PP1 and PP0 services → bin
- TRD table → outside behind tent

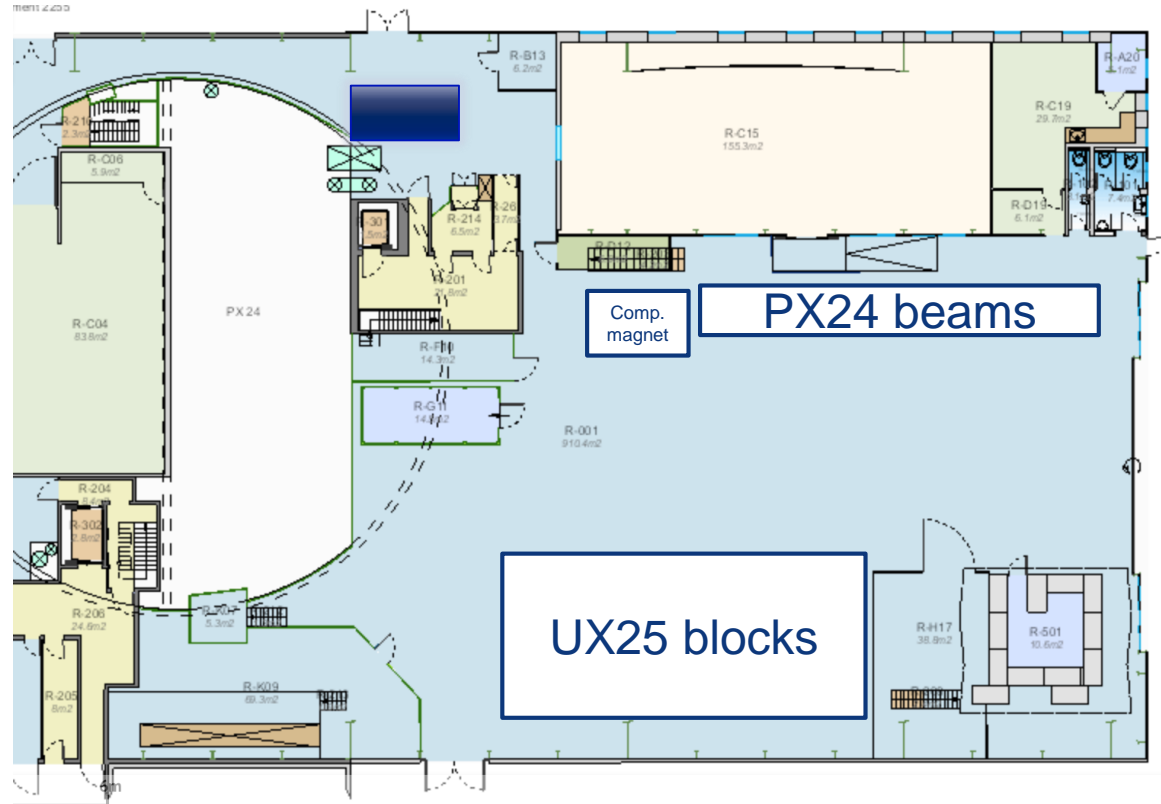
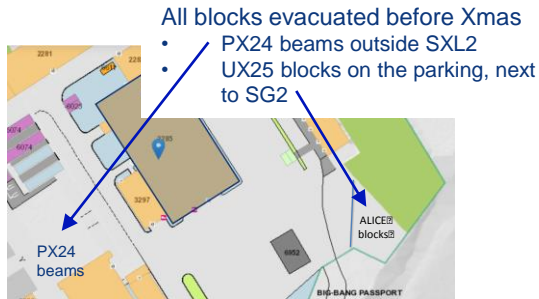

# SXL2 in December, storage

