

LS2 preparatory meeting

A.Tauro



General information

- LS2 duration: 27 months
- Access mode: general
- Underground visits: possible from 16 December 2018 (no visits during Xmas closure)
- IMPACT requests: possible to make one request per activity (e.g. TPC disconnection).
Not possible to make generic request to cover 1 year...
- RP: personal dosimeter needed (no declassification)

LS2 master plan

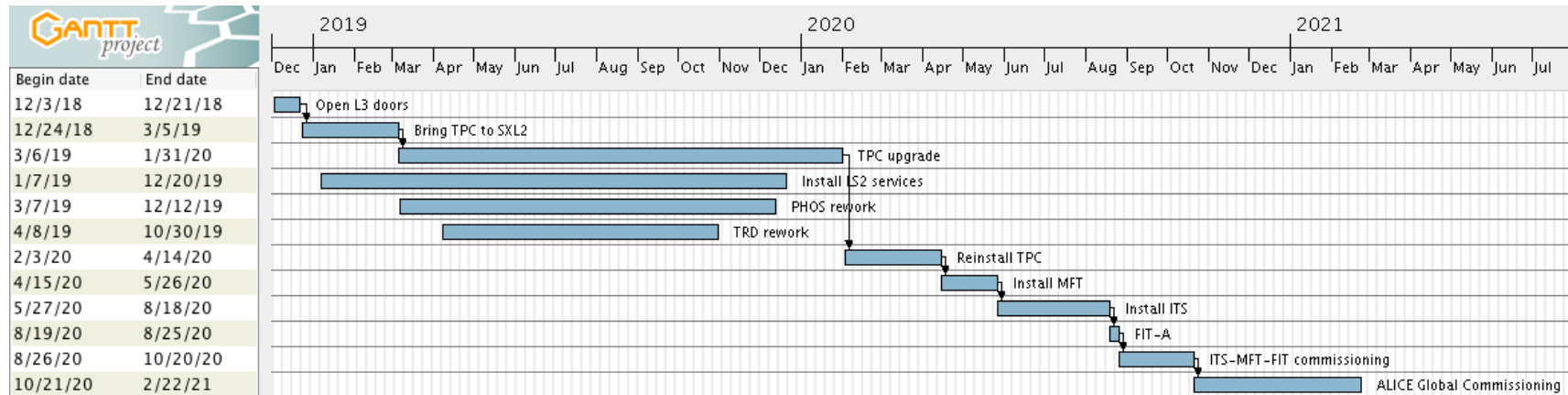

December timeline



**Remove
shieldings**

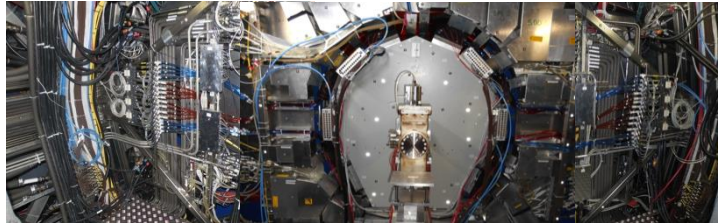

**Disconnect
PP0/PP1**

**Remove
forward
detectors
and
beampipe**



**Open L3
doors**

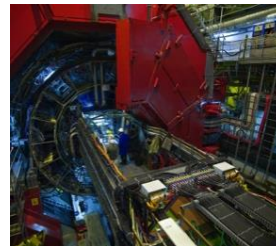

**Extract
TRD SM6**

**LS2 starts
3 Dec '18**

10 Dec

13 Dec

19 Dec

21 Dec '18

December key dates

- **ZEM** removal: 3 Dec
- **BLM** removal: 4 Dec
- **PMD** removal: 7 Dec
- **FMD1-V0A** and **T0A** removal: 10 Dec
- **ADA** removal: 10 Dec
- **TPC** disconnection: from 3 Dec
- **ITS** disconnection: from 11 Dec
- Open **L3 doors**: Friday 14 Dec
- **TRD6** disconnection: 17-18 Dec
- **TRD6** extraction: 19 Dec

Please make sure you are available on these dates!

Preparatory and follow-up meetings

- Dates LS2 preparatory meetings:
 - Fri 30 Nov
- Daily meetings from 3rd Dec 16h30
- Weekly Friday's meeting from 3rd Dec

Underground access in December

- w49:
 - **No access** between 6:00 AM and 10:00 AM (ALTEAD only)
 - **Restricted access** between 10:00 AM and 17:00 PM (Miniframe disconnection)
 - **Normal access** after 17:00 PM
- w50:
 - **No access** between 6:00 AM and 10:00 AM (ALTEAD only)
 - **Normal access** after 10:00 AM
- w51:
 - **Normal access**
- No activities foreseen during Xmas closure

EN-EL interventions

- AUG on Monday 25 March 2019 - no access on site (both surface and underground)
- 18kV, 3.3kV and LV network maintenance:
 - Mon 20 to Wed 22 Jan 2020: 3 days no general services - no access on site (both surface and underground)
 - Thu 23 to Fri 24 Jan 2020: 2 days "Limited access" → details being worked out
- AUG on Monday 27 January 2020 - no access on site (both surface and underground)
- Test secours: 19 Mar 2019
- Auto transfer test: 11 Apr 2020
- BIW test: 5 and 6 Oct 2020 from 18:00 to 00:00 – no access underground

EN-CV interventions

- **Big maintenance:**

- SF: from Nov 2019 to mid Jan 2020. NO impact on ALICE as both magnets will be OFF.
- UW: **stop UX mixed water** for 2 days in week 40/2019 (October).
- SU: various small perturbations + 1 day **stop all cooling UX** + 1 day **stop all cooling SXL2** in week 16/2020 (April).

- **Small maintenance:**

- UW: from mid Aug 2020 to mid Sep 2020. **Stop mixed water UX** for 1 day in week 37/2020 (September).
- SF+SU: weeks 45-47/2020: cleaning towers (stop SF 1 week) + 1 day **stop all cooling UX**.

- **Ventilation:**

- Maintenance SXL2 cleanroom before April 2019. Procedure to be established (CV).
- SG2: w7/2019
- Gas extraction: w8/2019
- UX25 cavern: May 2020 (tbc)
- MCH and MTG: Apr 2020 (tbc)
- L3: Apr 2020 (tbc)
- ITS: Apr 2020 (tbc)

- **Raw water:**

- Test after Apr 2019. Short interruption (1 day), can be used tap water during the test.

Safety systems maintenance

- Fire detection: w2-3/2019
- Gas detection: w7/2019 (in parallel to SG2 ventilation maintenance)
- Red emergency phones: 20/2/2019
- Fire detection (racks): w10/2019

CERN Open Days

- 14 and 15 September 2019

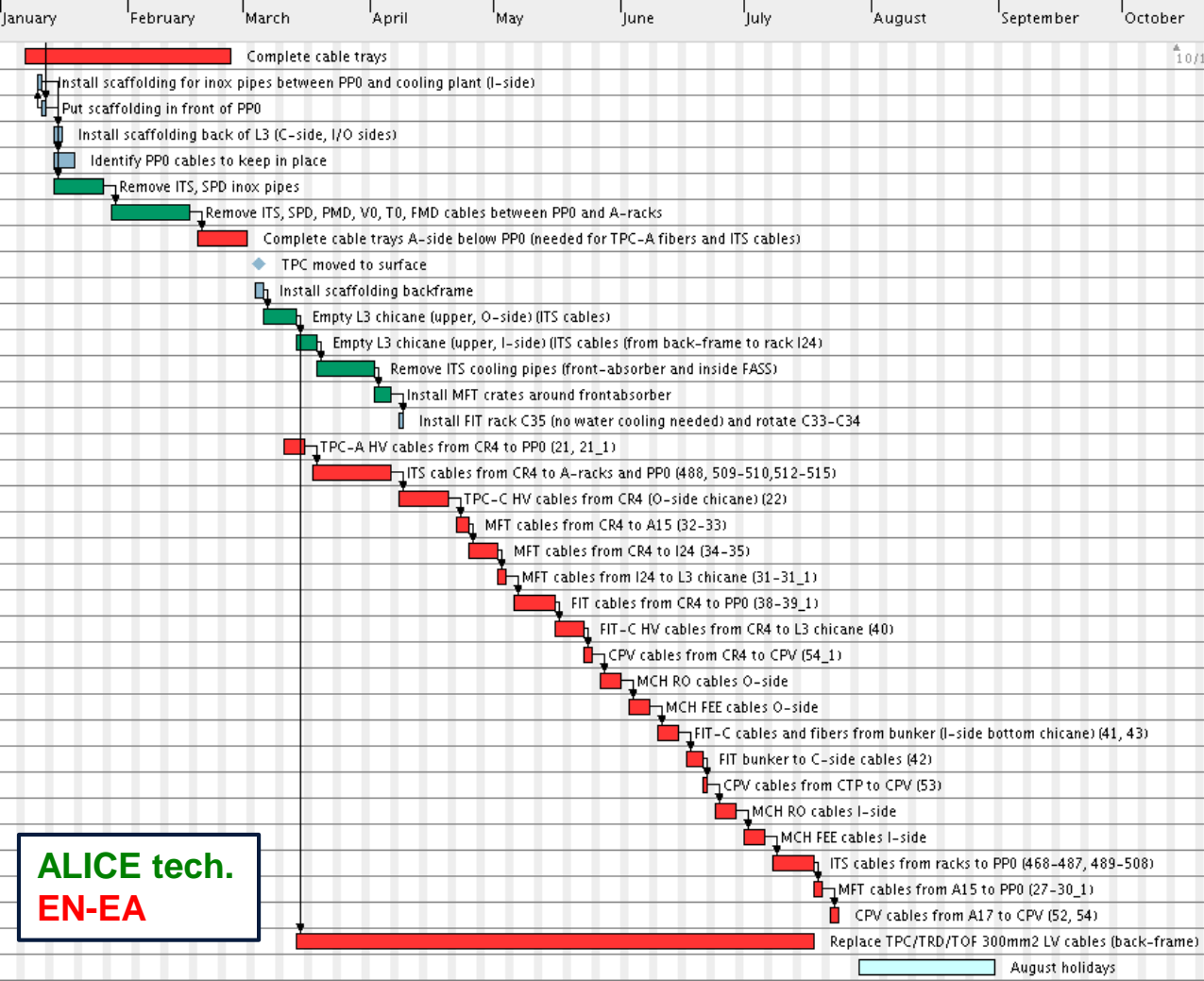

ALICE tech.
EN-EA

Planning copper cables (EN-EA)



ALICE

Mar to Aug: pull cables

Planning optical fibers (EN-EL)

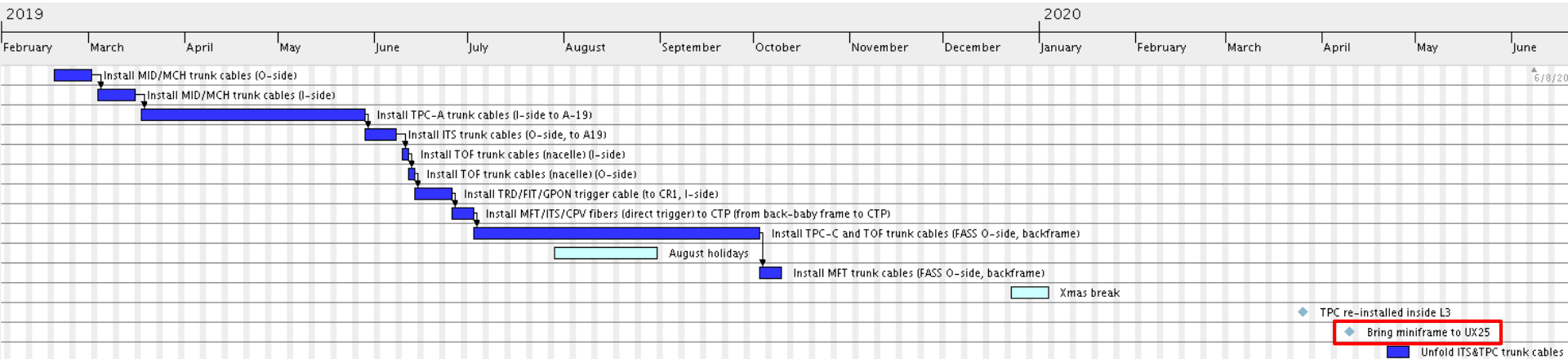

Feb to October: install and test all trunk cables

April 2019: install TPC/ITS fibers after Miniframe installation

April 2019: install TPC/ITS fibers after Miniframe installation

Miniframe planning (rework in SX2)

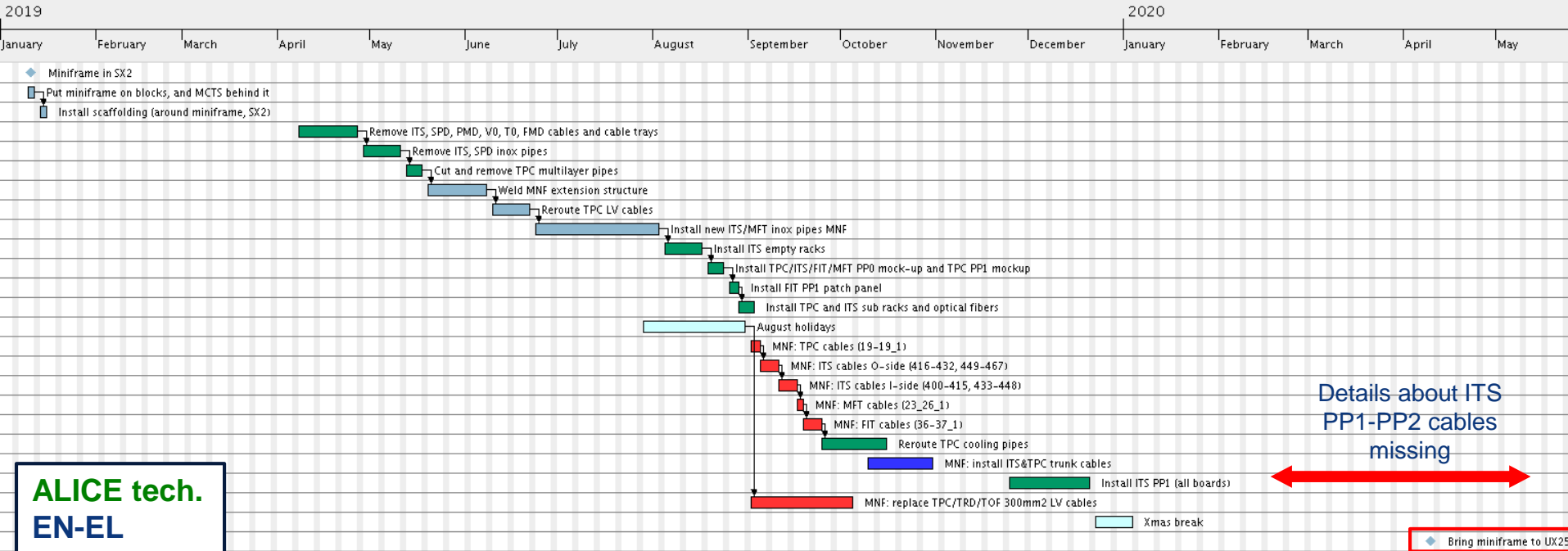

ALICE tech.
EN-EL
EN-EA

Day-by-day sequence w49



UX25 activities w49 – Mon 3 Dec 2018

Unrestricted cavern access starting at 8:30 (RP check)

Reinstall crane electronics

Stop flammable gases

Lockout racks

RP+CV analysis cooling fluids

TRD work in SXL2 (whole week)

EN-CV: put ITS cooling plant in Stand-by

ALICE TC + TPC: cut 150mm² cable for EN-EA test

Close sector valves and vent vacuum sector with air (TE-VSC), start at 8:00 AM

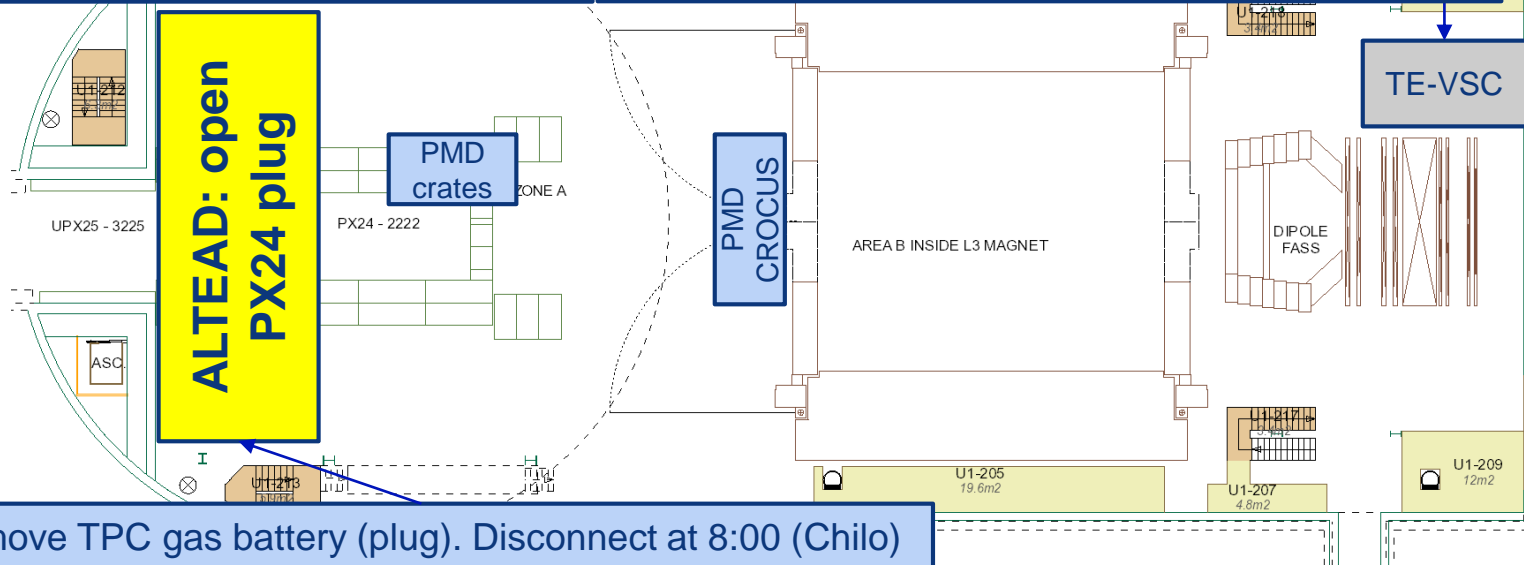

Remove TPC gas battery (plug). Disconnect at 8:00 (Chilo)

Miniframe activities w49 – Mon 3 Dec 2018 AM

Miniframe access from 10:00

TPC cooling water evacuation

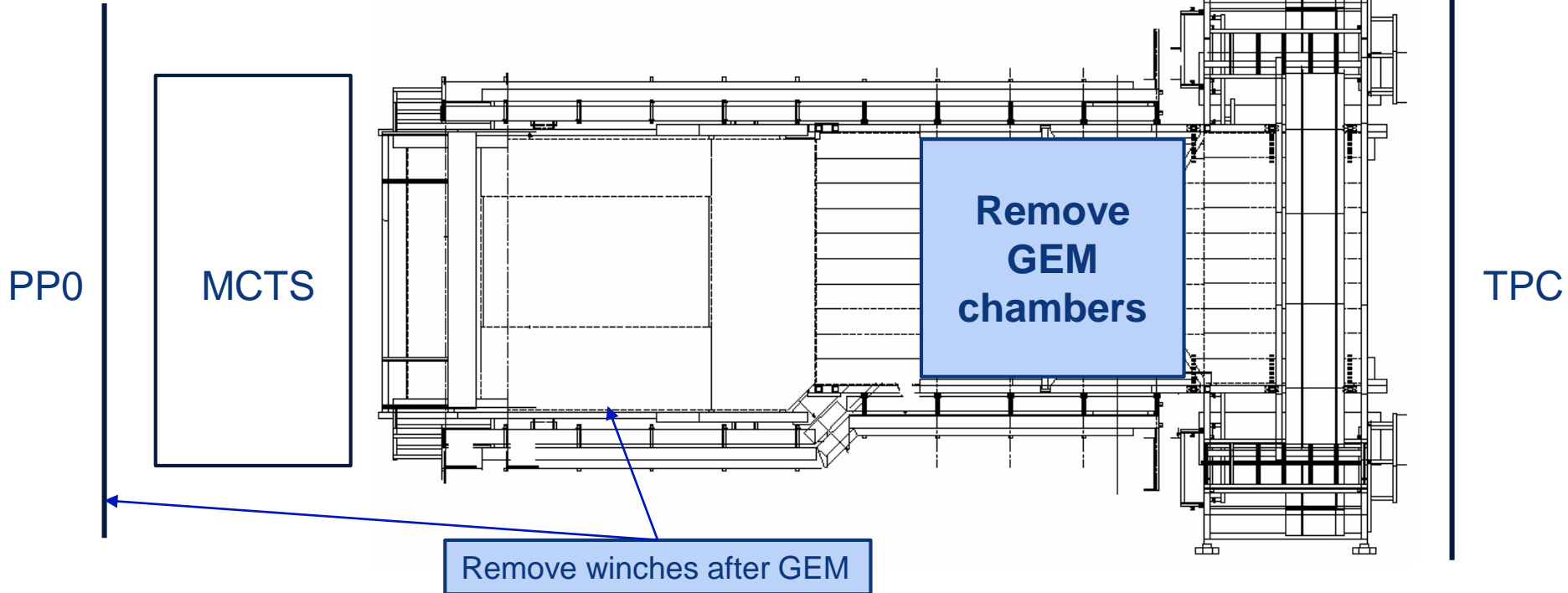

Miniframe activities w49 – Mon 3 Dec 2018 PM

Miniframe access from 10:00

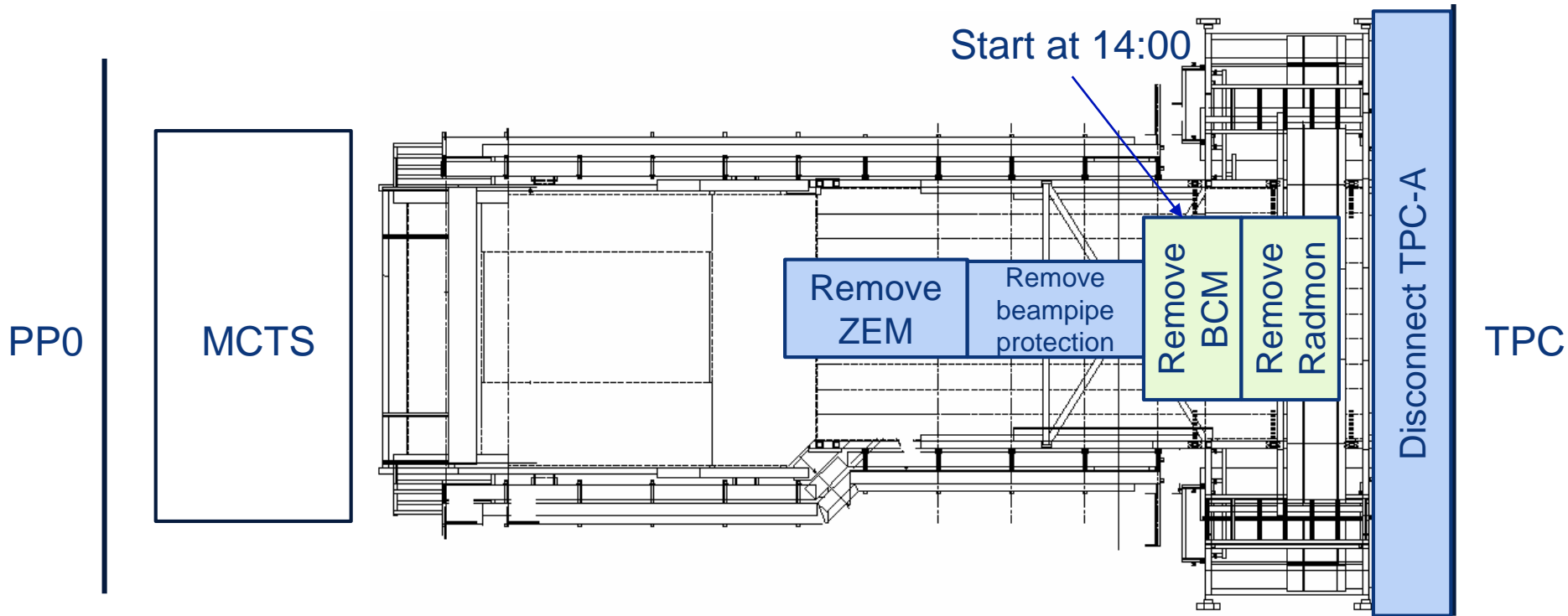

UX25 activities w49 – Tue 4 Dec 2018

Cavern access from 10:00, restricted access until 17:00

No access CR1-5

ALTEAD (SX2): start bringing concrete blocks outside

Surface: SX2-CR0 asphalt – until 7 Dec

After 17:00

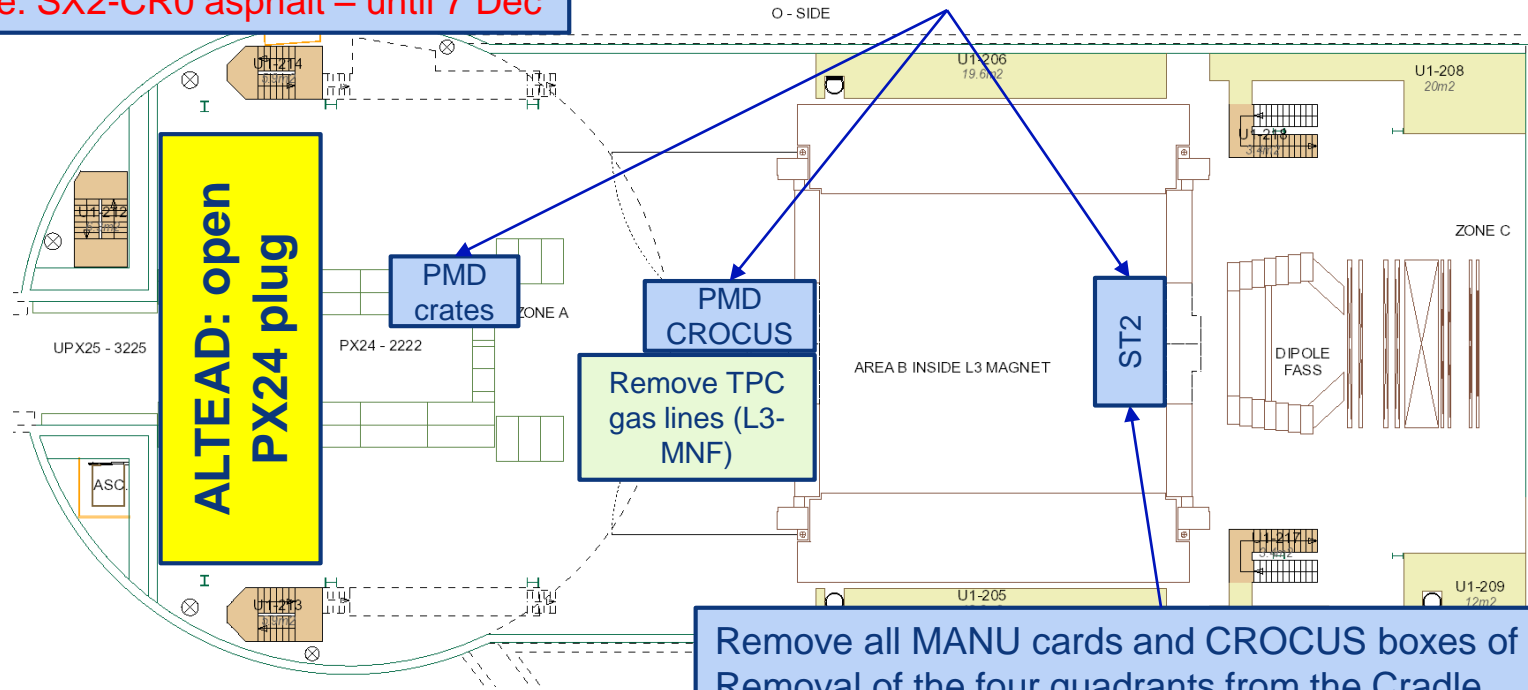

Miniframe activities w49 – Tue 4 Dec 2018

Cavern access from 10:00, restricted access until 17:00

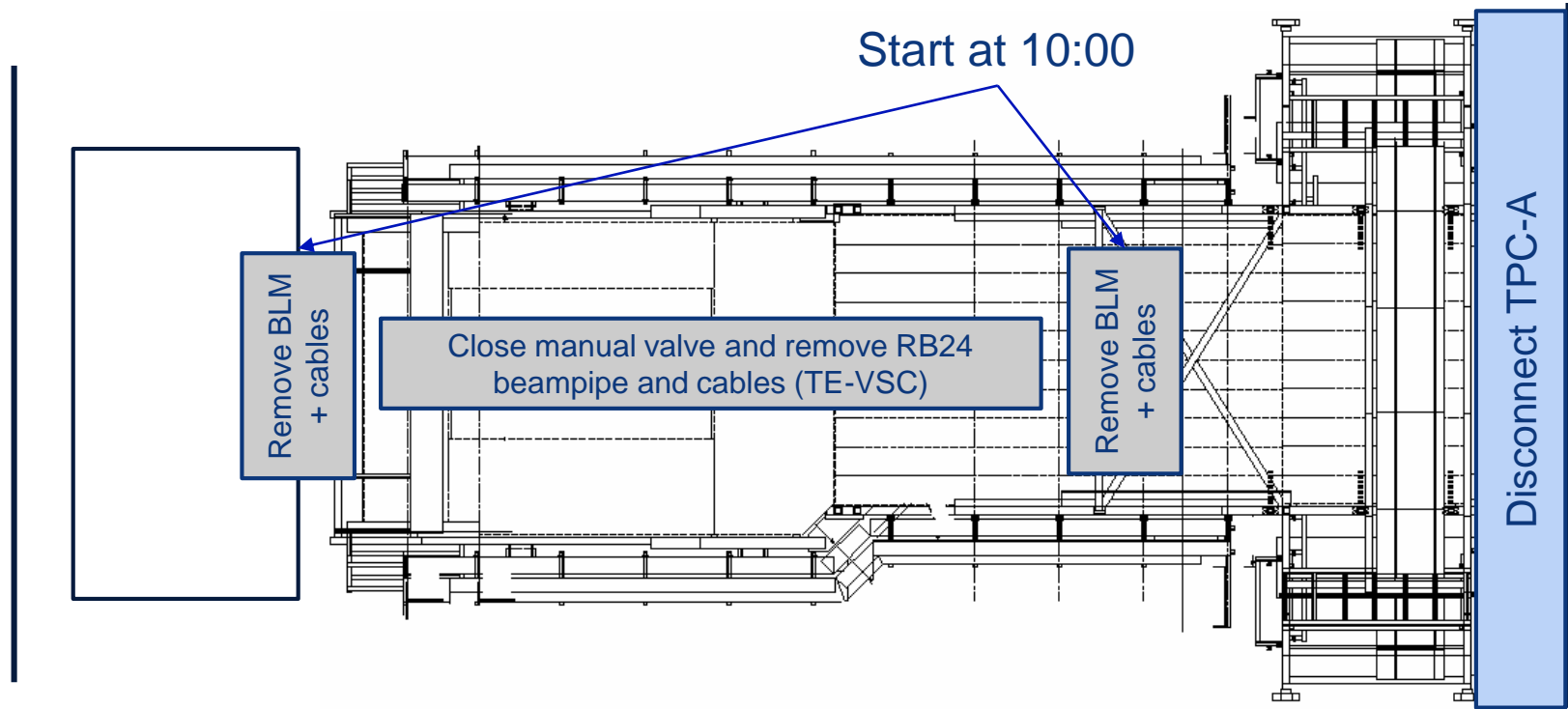

UX25 activities w49 – Wed 5 Dec 2018

Cavern access from 10:00, restricted access until 17:00

Bring down cherry pickers and transport boxes

Install 7 'pallets grillagées' for TPC

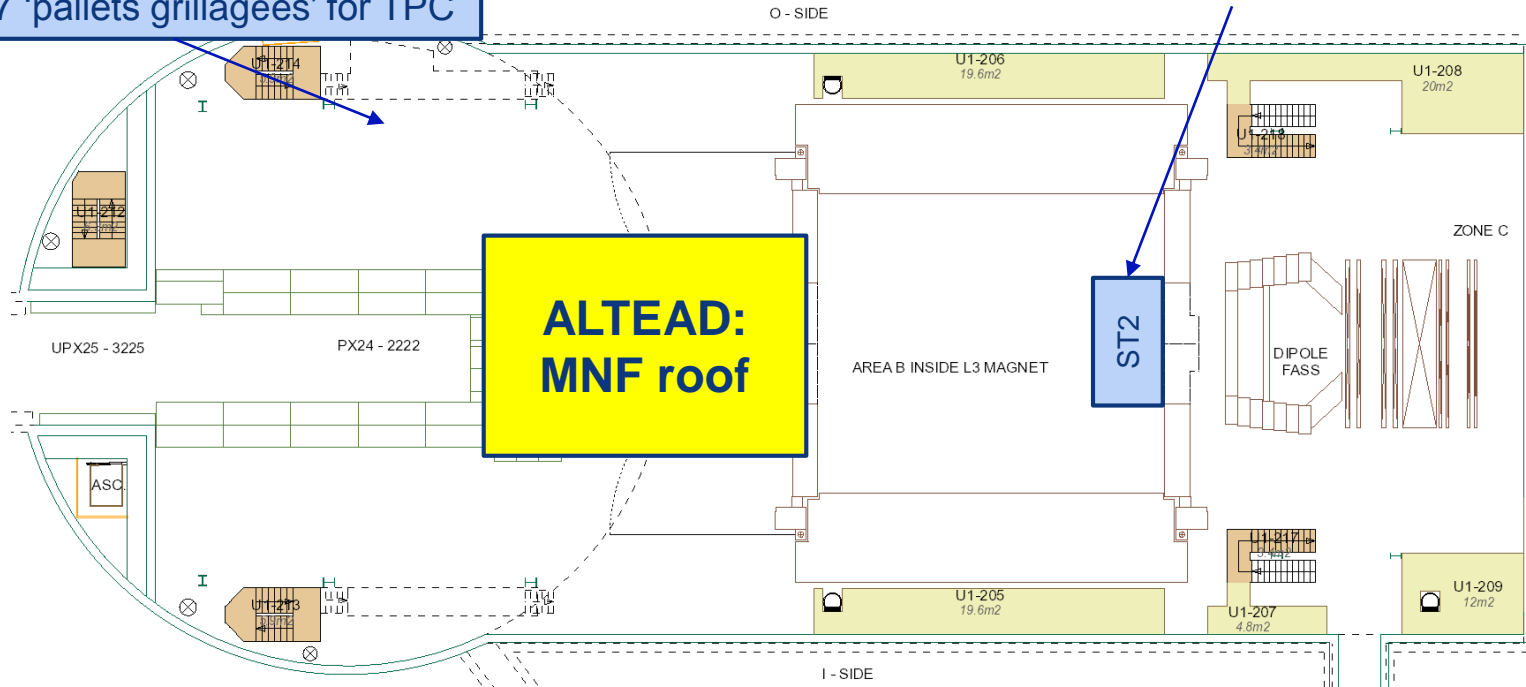

Miniframe activities w49 – Wed 5 Dec 2018

Cavern access from 10:00, restricted access until 17:00

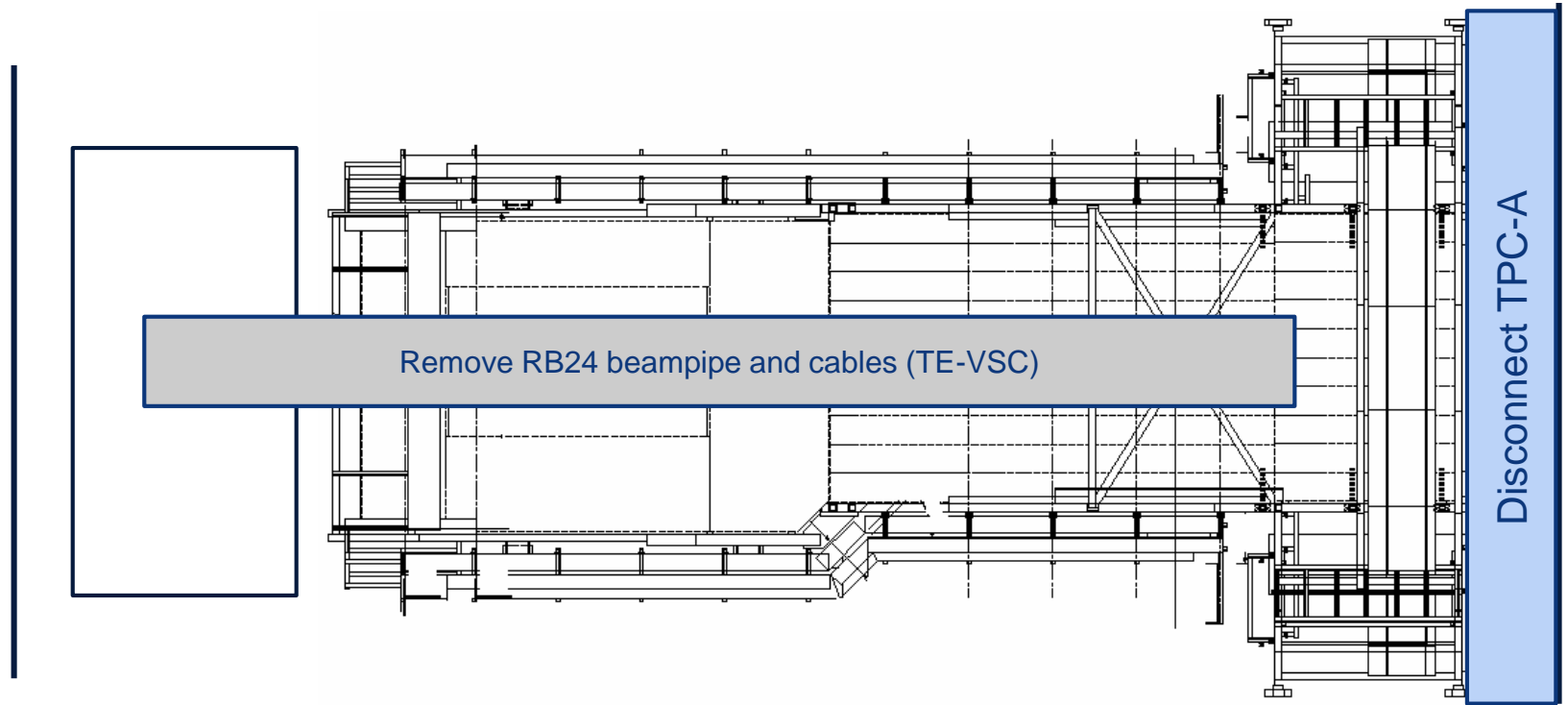

UX25 activities w49 – Thu 6 Dec 2018

Cavern access from 10:00, restricted access until 17:00

ALTEAD: bring down the VSC transportation box

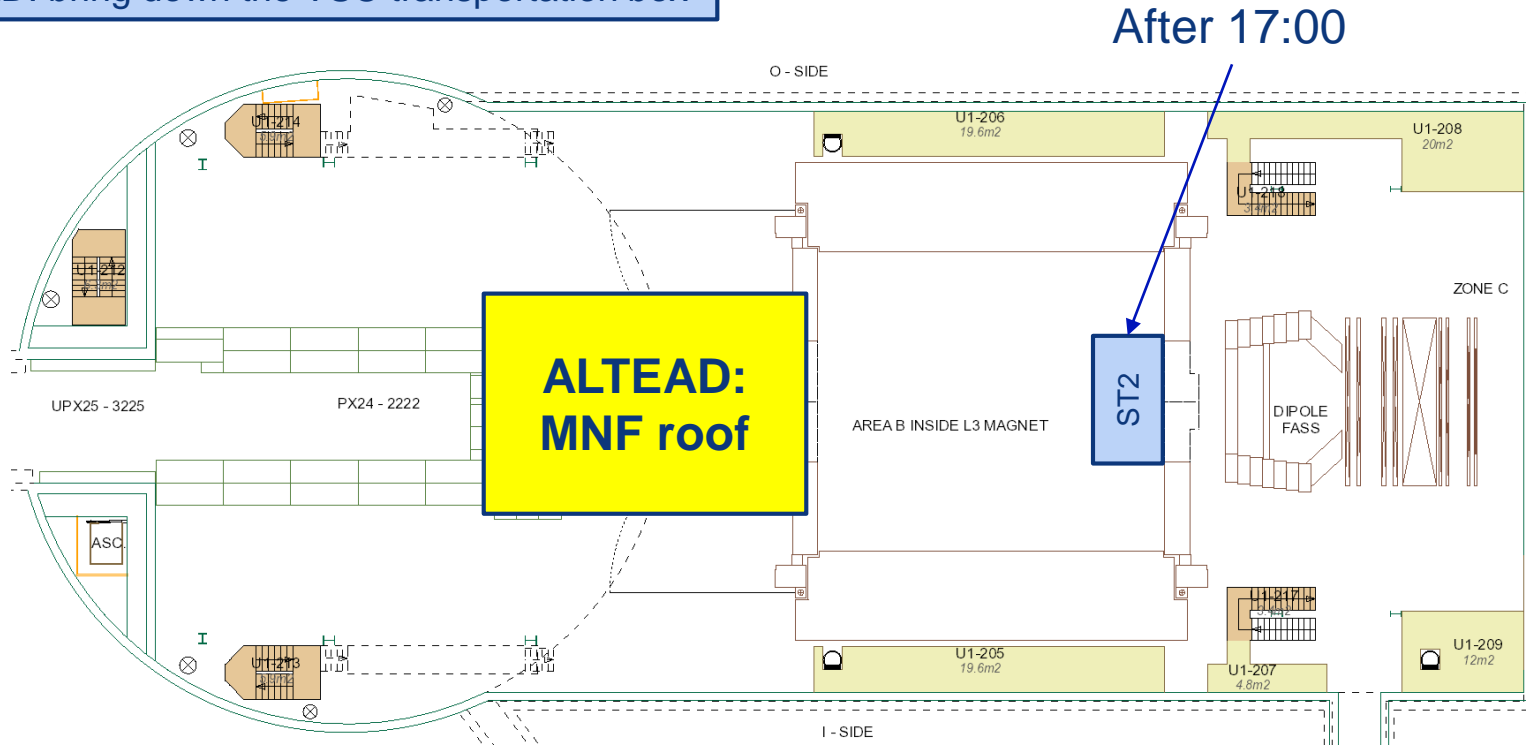

Miniframe activities w49 – Thu 6 Dec 2018

Cavern access from 10:00, restricted access until 17:00

ALTEAD: evacuate RB24 beampipe (→ FLEX)

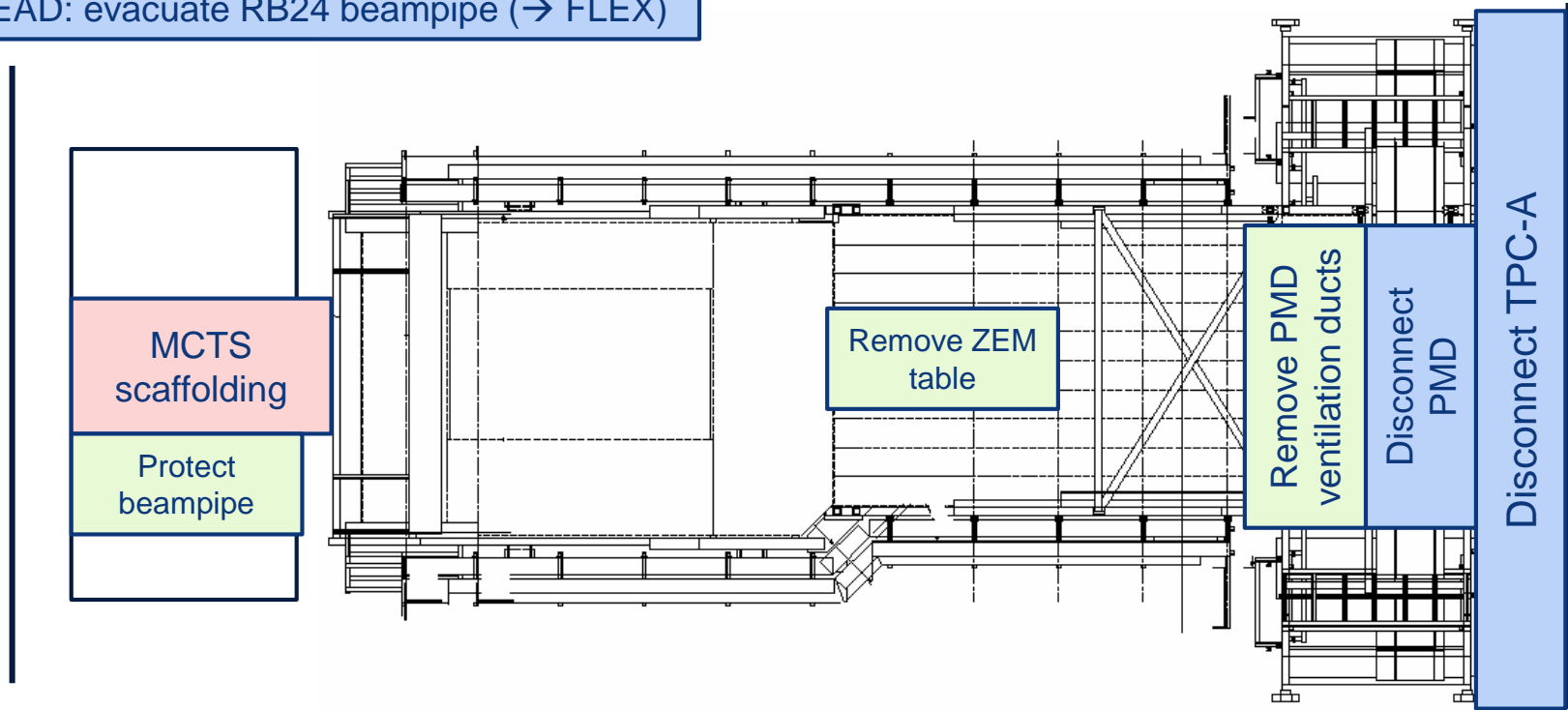

UX25 activities w49 – Fri 7 Dec 2018

Cavern access from 10:00, restricted access until 17:00

ALTEAD (SX2): bring down scaffolding for TRD

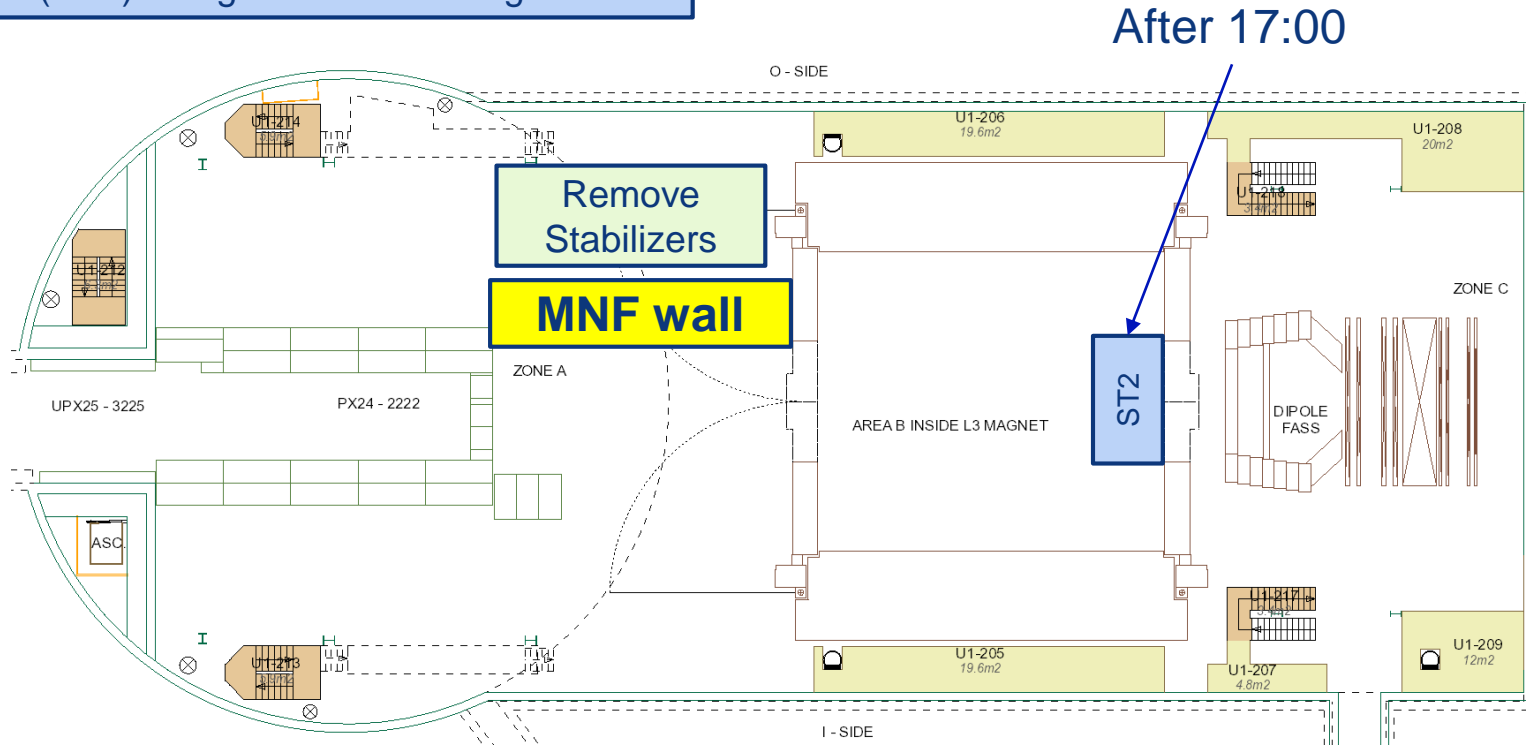

Miniframe activities w49 – Fri 7 Dec 2018

Cavern access from 10:00, restricted access until 17:00

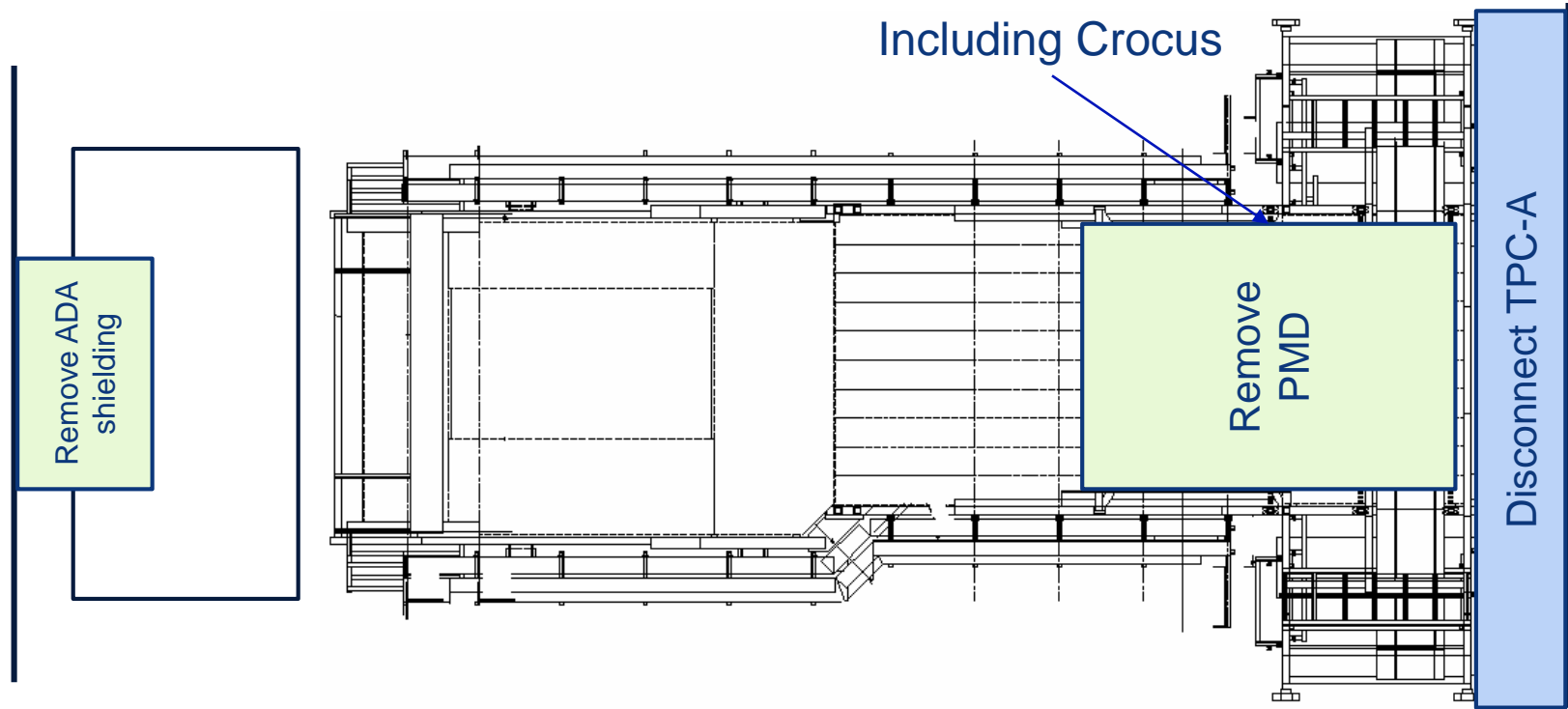

Miniframe activities w49 – Sat 8 and Sun 9 Dec

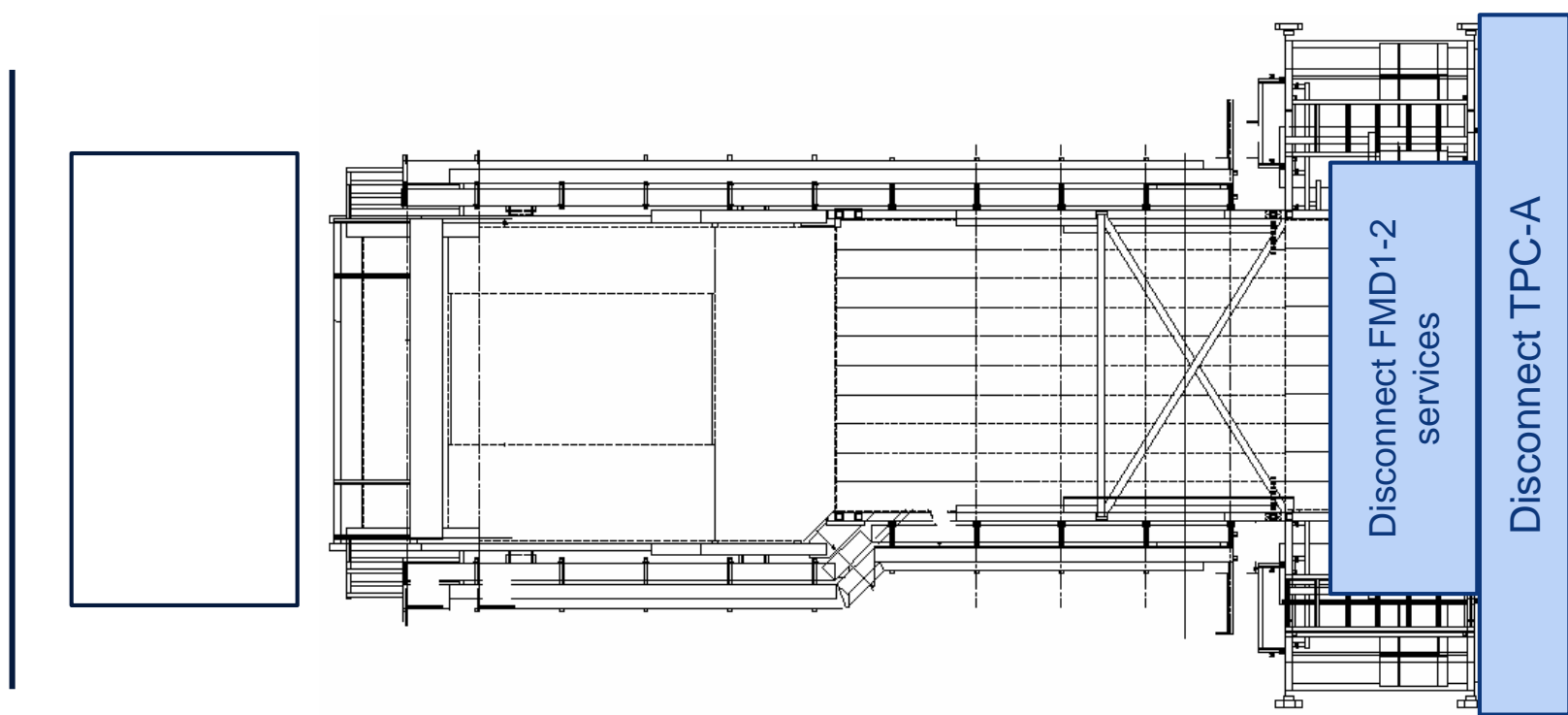

Day-by-day sequence w50



UX25 activities w50 – Mon 10 Dec 2018

Cavern access from 10:00

ALTEAD (SX2): start bringing big PX24 beams outside

Start emptying CR1

ALTEAD transport 2 ST2 quadrants to SX2 (1h)

EN-CV: empty ITS/SPD cooling plant tanks + lockout

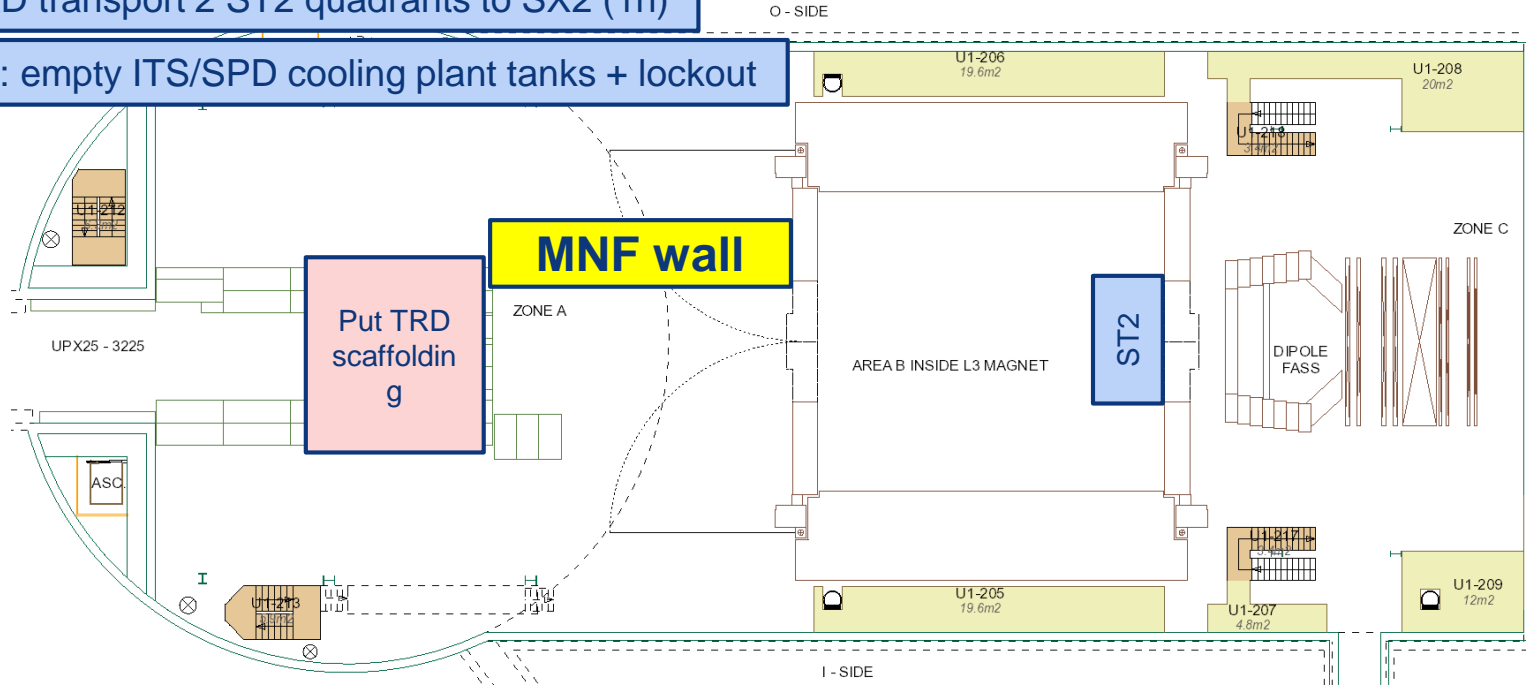

Miniframe activities w50 – Mon 10 Dec 2018

Cavern access from 10:00

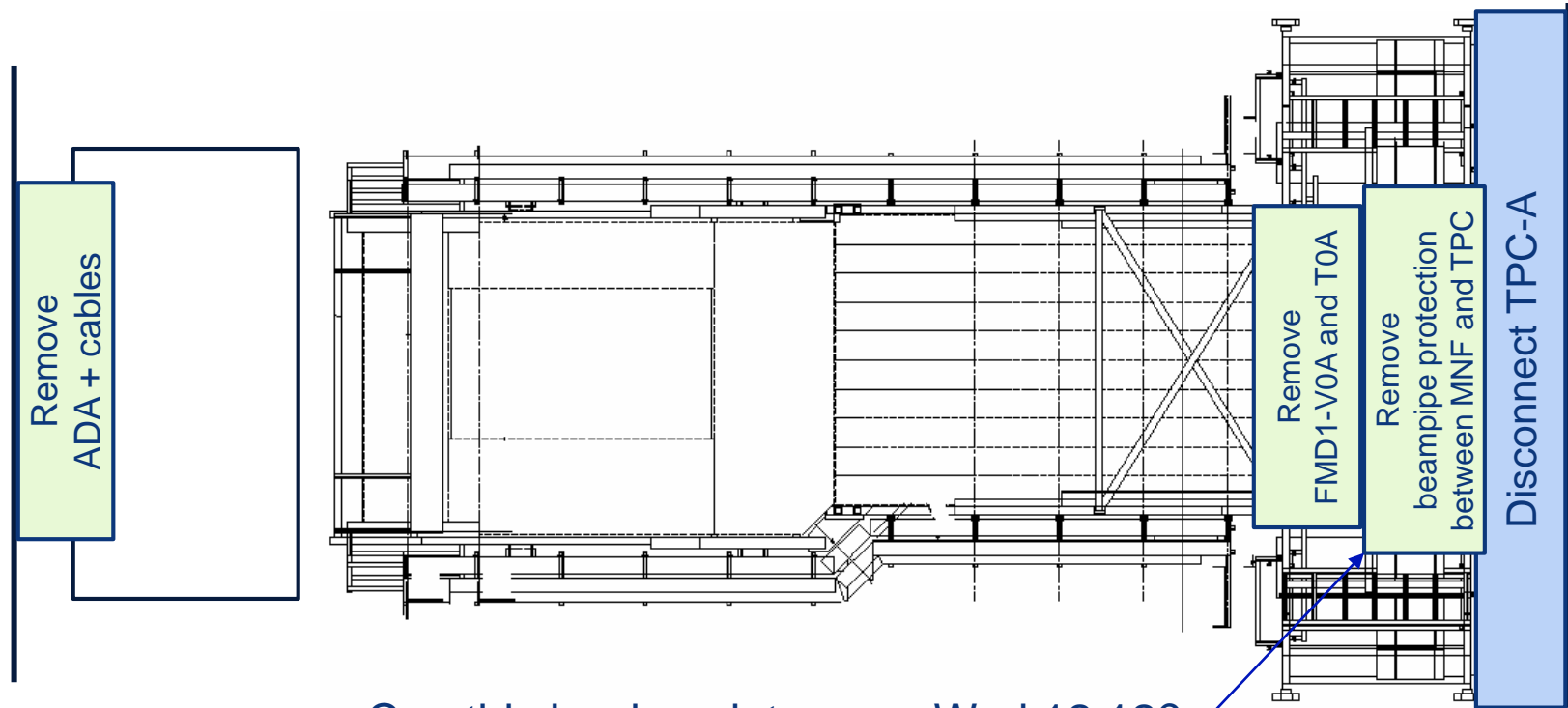

Can this be done later, e.g. Wed 12.12?

UX25 activities w50 – Tue 11 Dec 2018

Unrestricted cavern access

Start LHC tunnel access

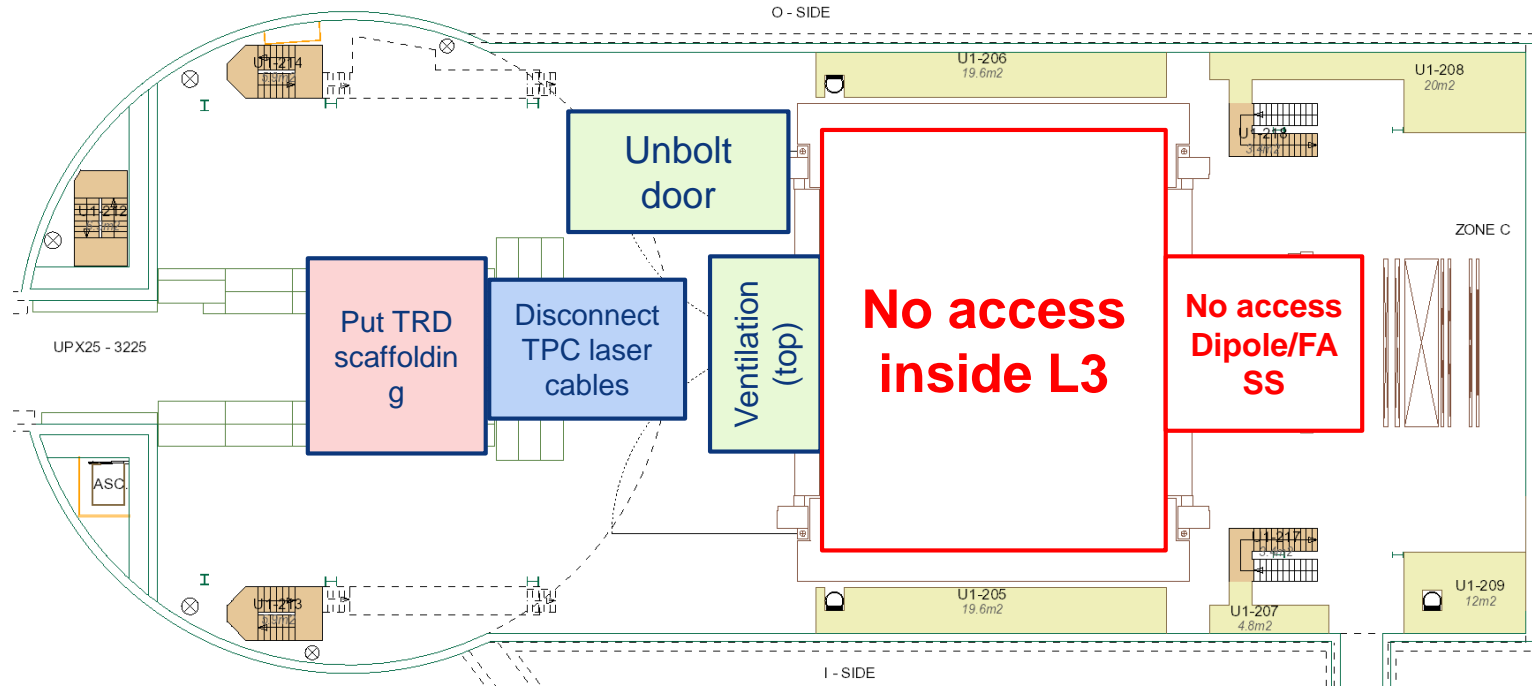

Miniframe activities w50 – Tue 11 Dec 2018

Unrestricted cavern access

Electrical lock-out compensator magnet (TE-MS)

Remove
beampipe shielding
behind ADA

Disconnect
power and
cooling
comp.magnet

Disconnect ITS PP1
(attach cables on TPC)

Disconnect TPC-A (after working hours)

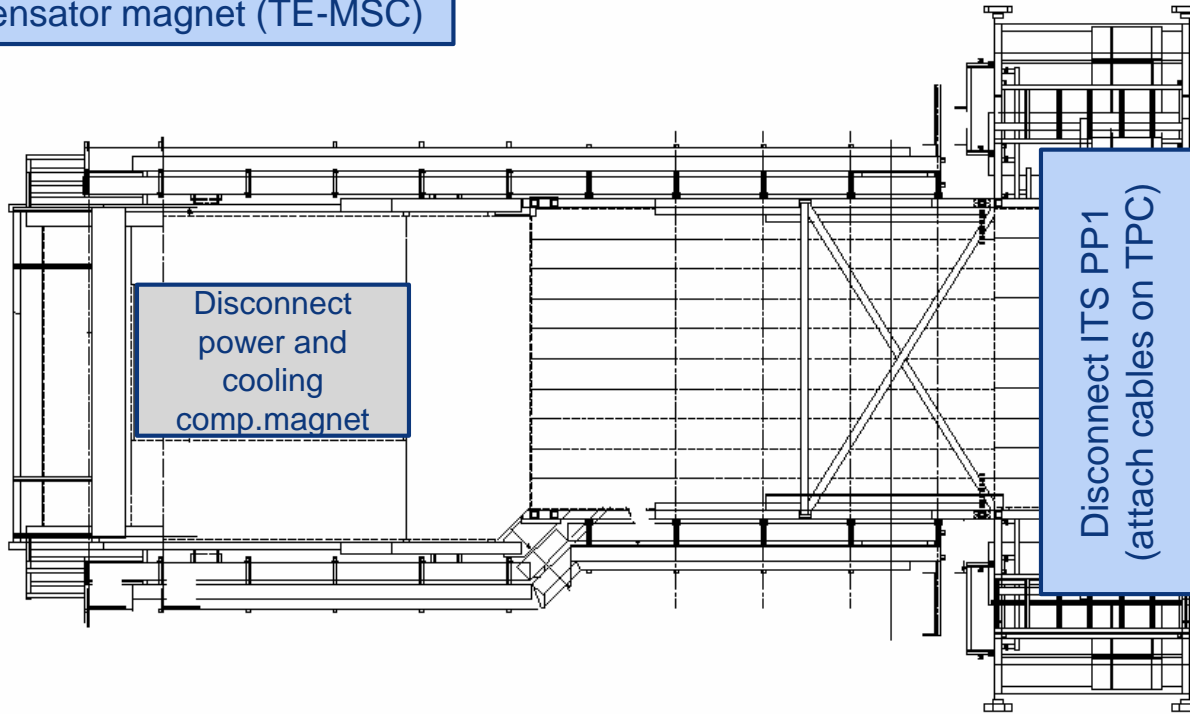

UX25 activities w50 – Wed 12 Dec 2018

Unrestricted cavern access

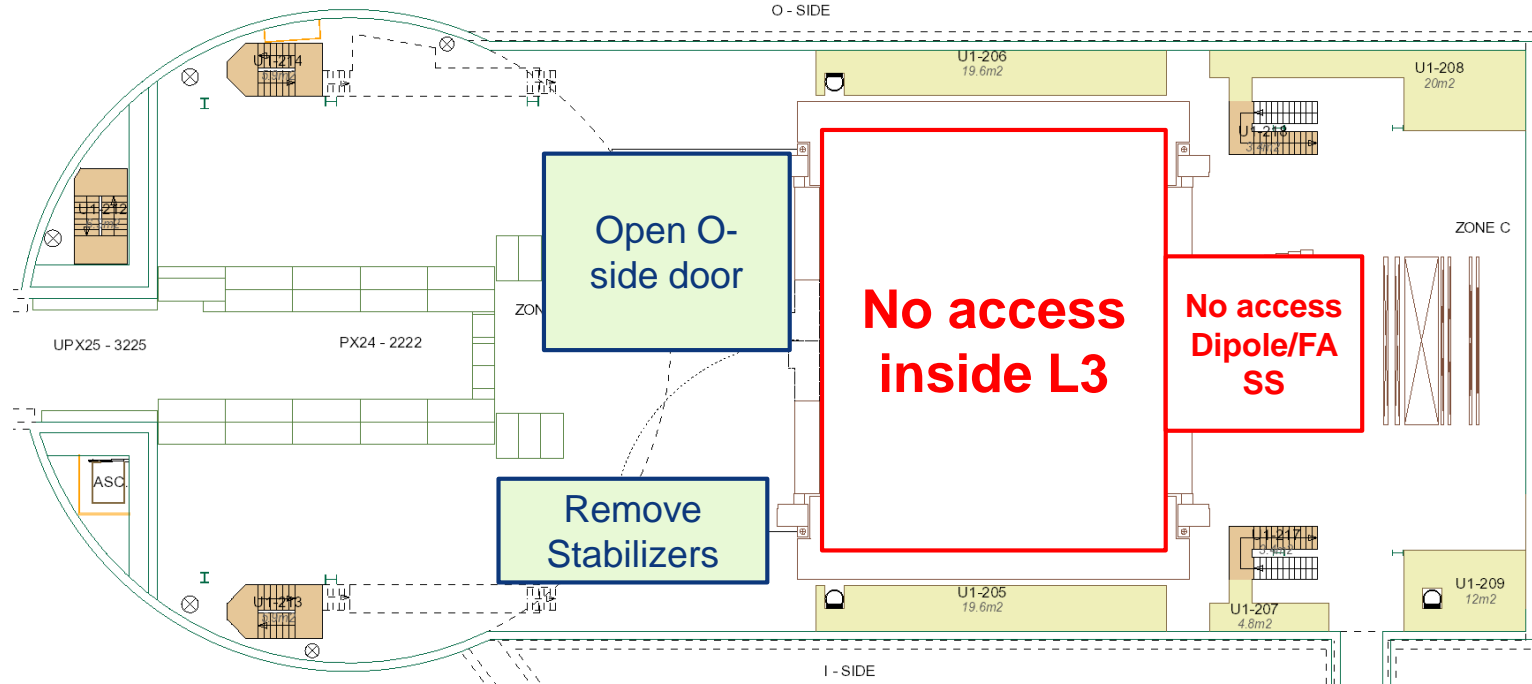

Miniframe activities w50 – Wed 12 Dec 2018

Unrestricted cavern access

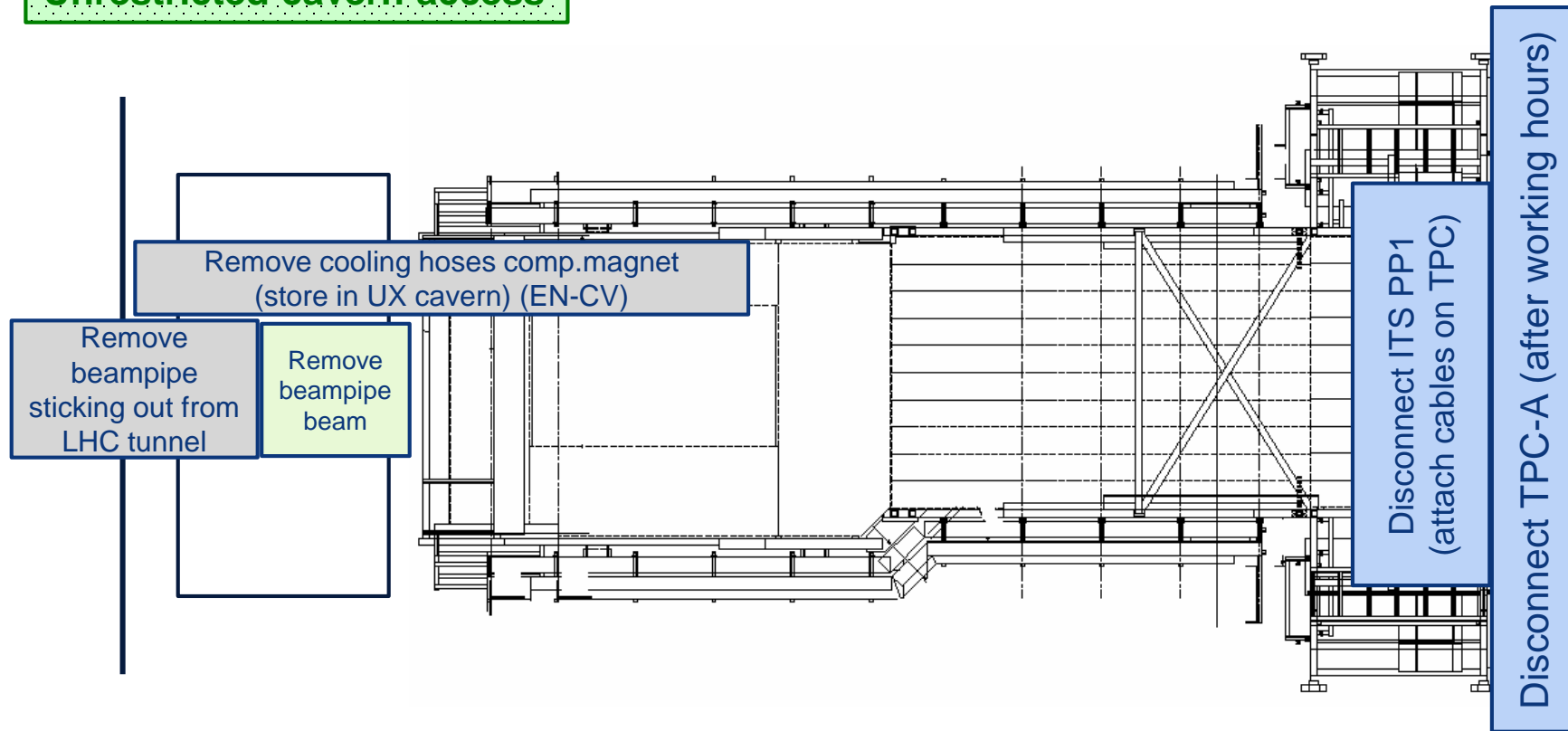

UX25 activities w50 – Thu 13 Dec 2018

Cavern access from 10:00

Start L3 access without watcher

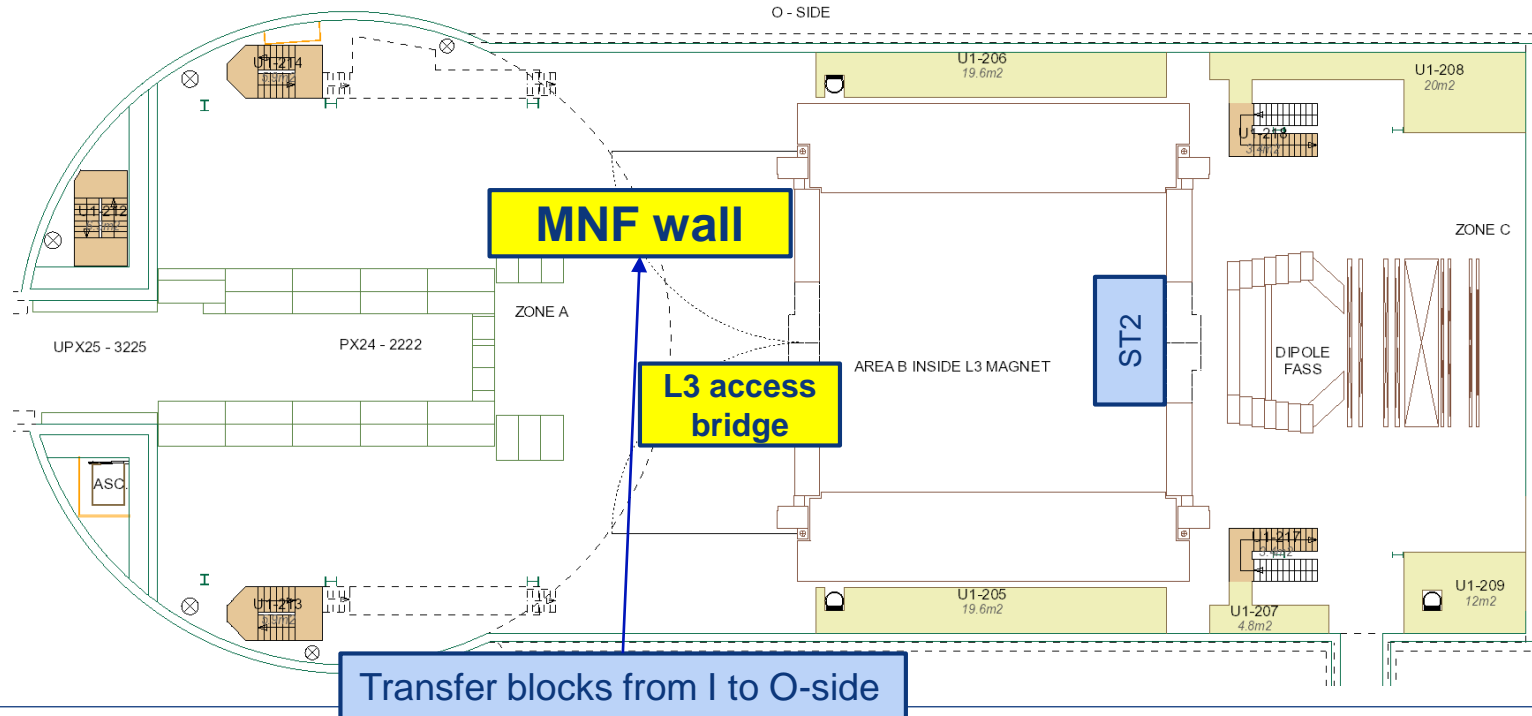

Miniframe activities w50 – Thu 13 Dec 2018

Cavern access from 10:00

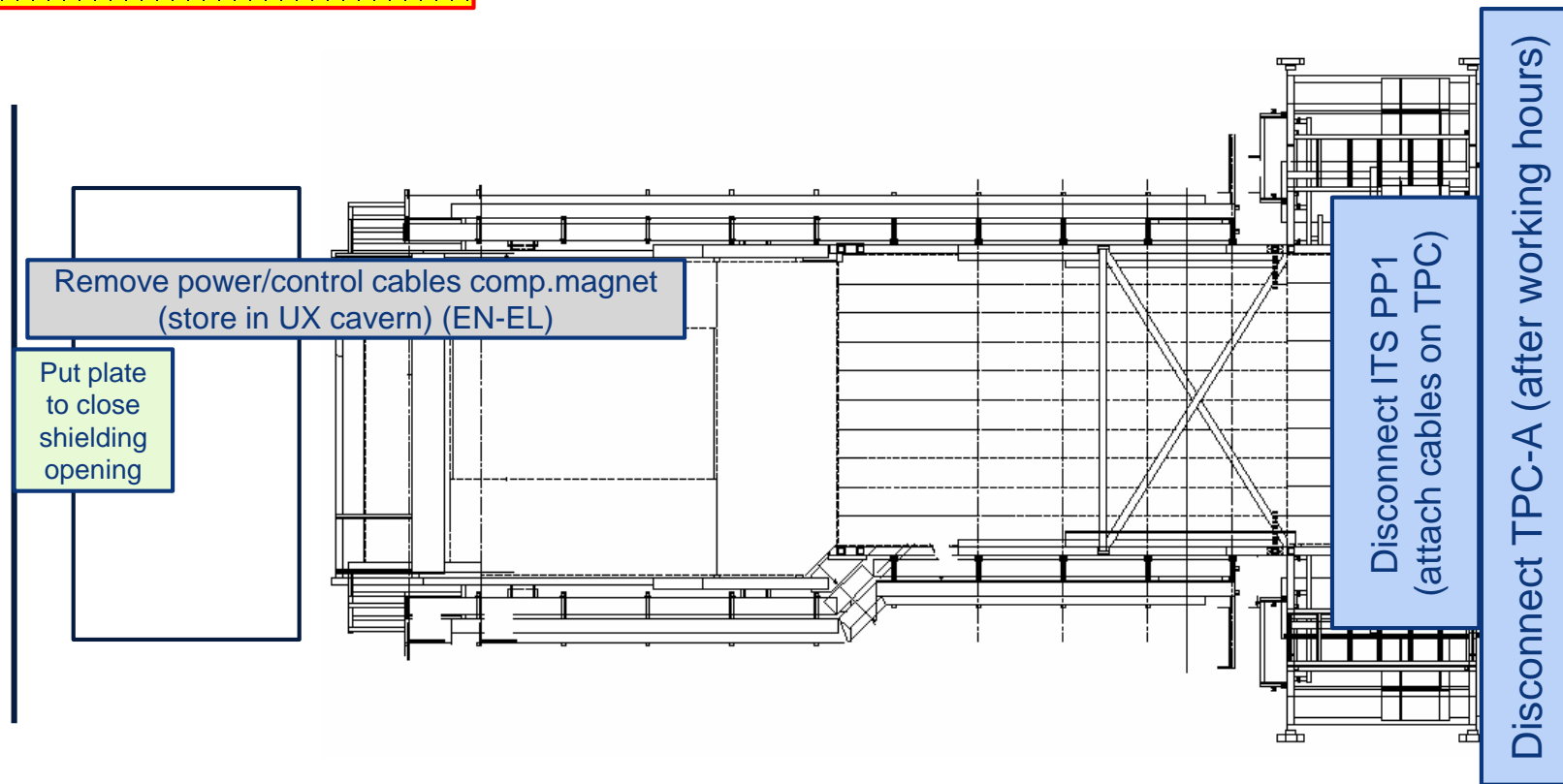

UX25 activities w50 – Fri 14 Dec 2018

Unrestricted cavern access

ALTEAD transport 2 ST2 quadrants to SX2 (1h)

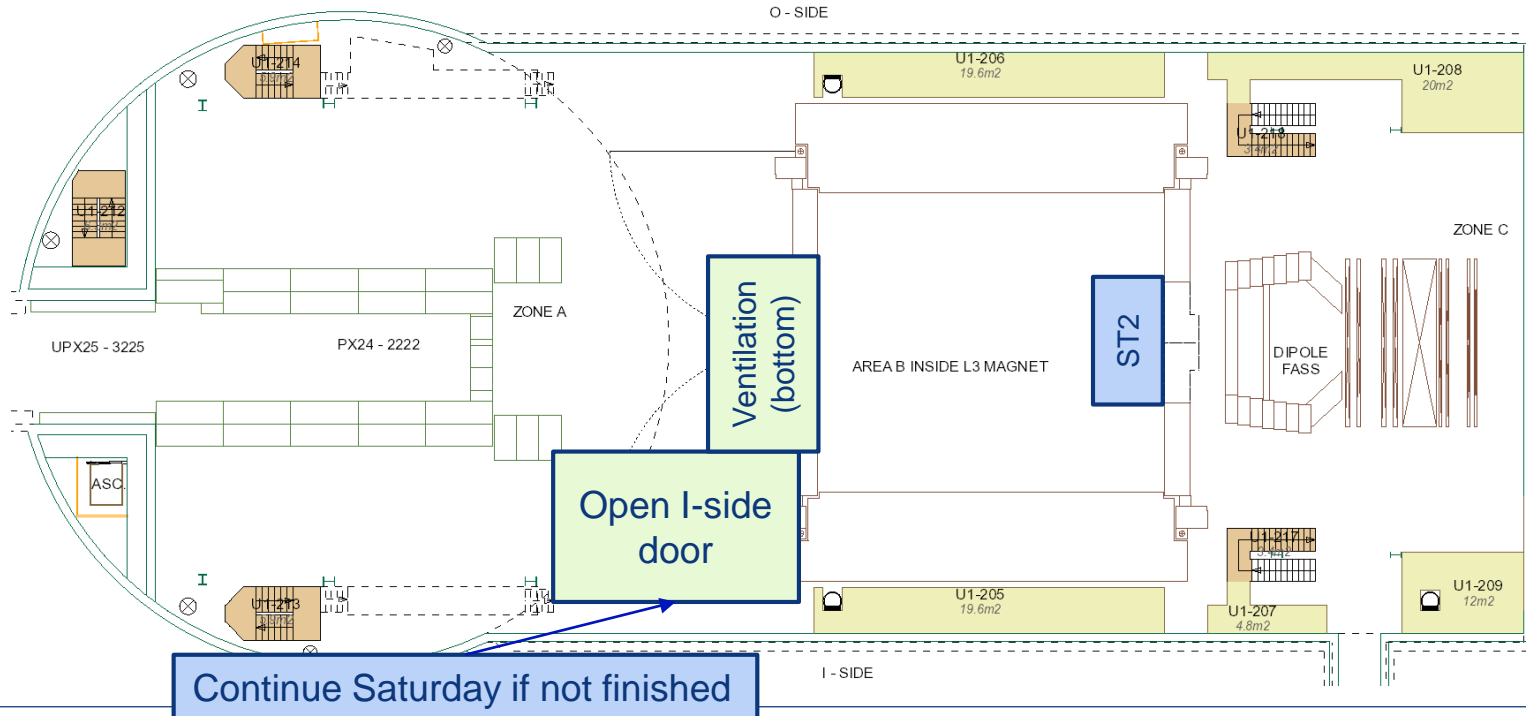

Miniframe activities w50 – Fri 14 Dec 2018

Unrestricted cavern access

ALTEAD: bring compensator magnet to SX2

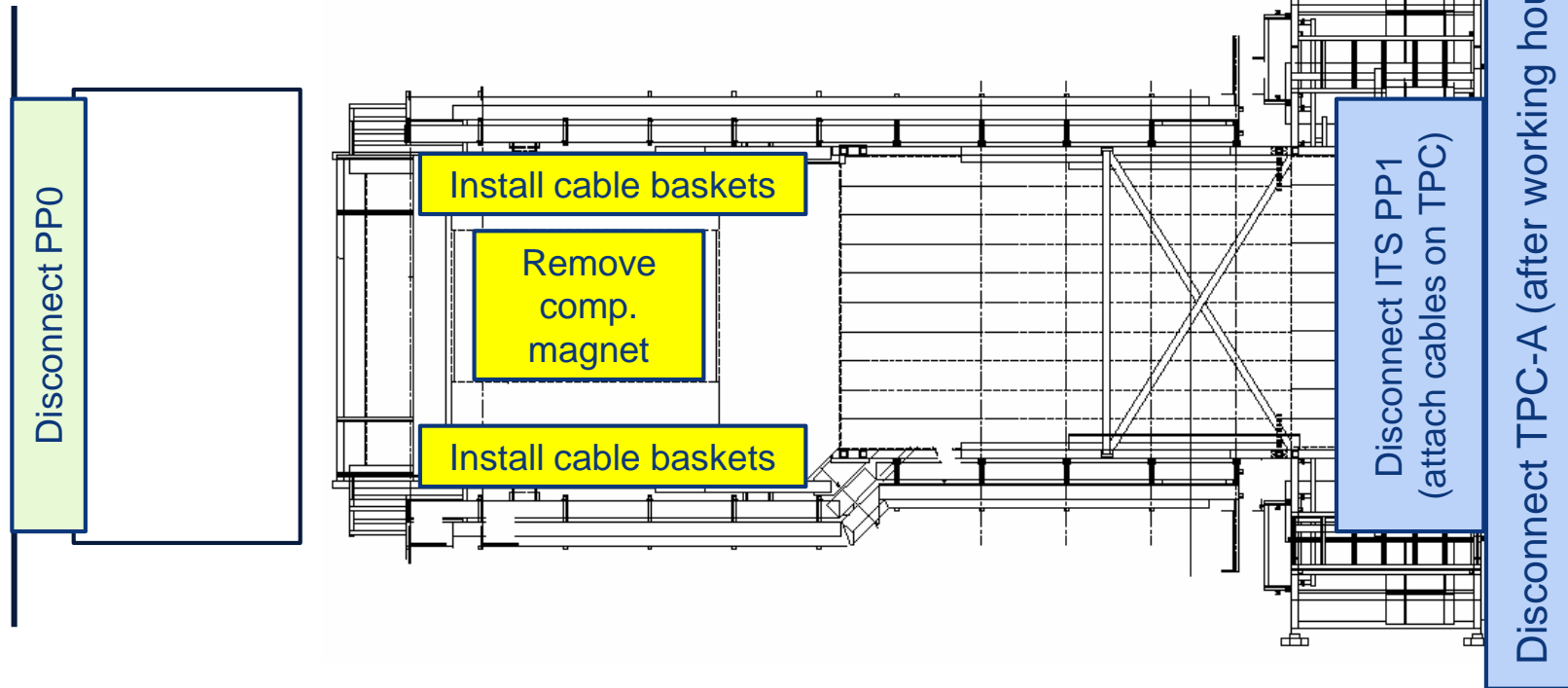

Day-by-day sequence w51



UX25 activities w51 – Mon 17 Dec 2018

Unrestricted cavern access

Start UX visits (Sunday 16 December)

Visit (77 people): Despina

TOF: disconnect some services in view of TRD extraction

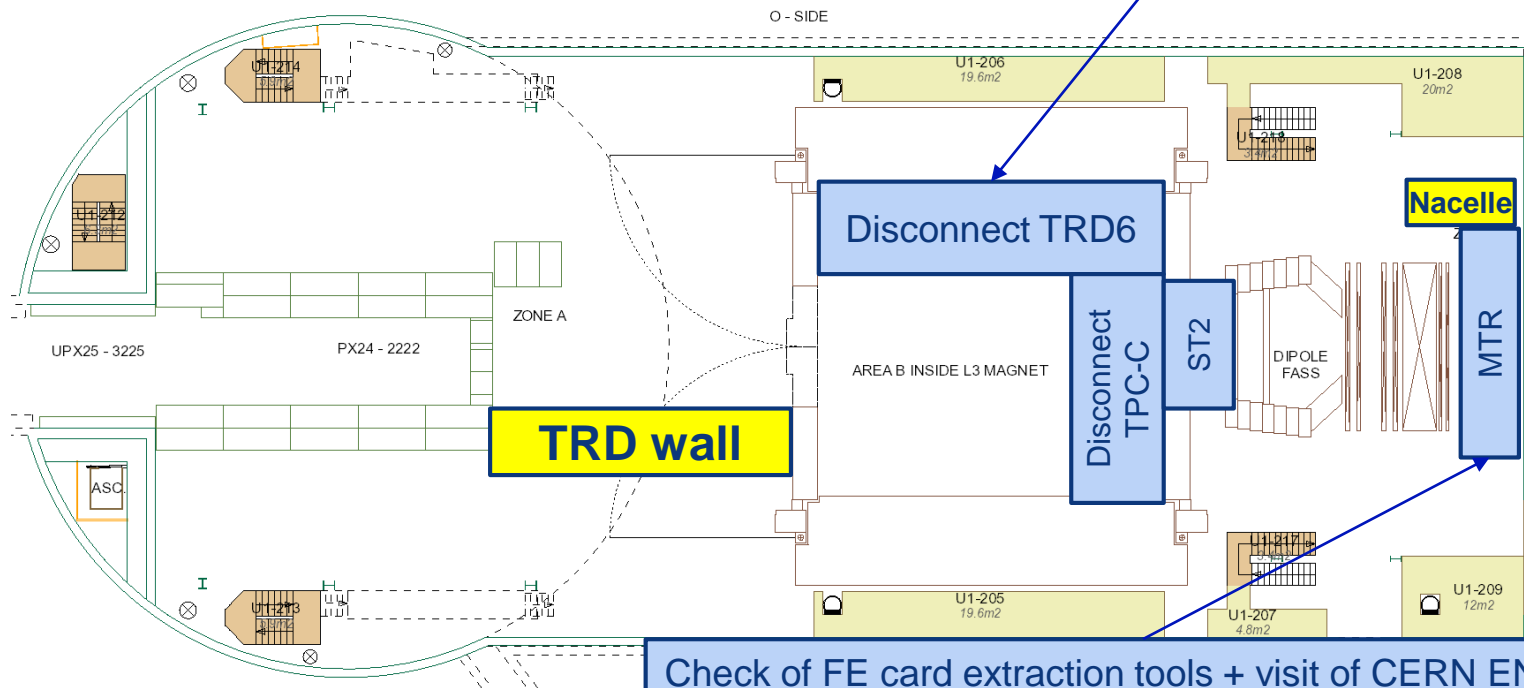

Check of FE card extraction tools + visit of CERN EN-EA-CT team. Need to open one half plane of MTR

Miniframe activities w51 – Mon 17 Dec 2018

Unrestricted cavern access

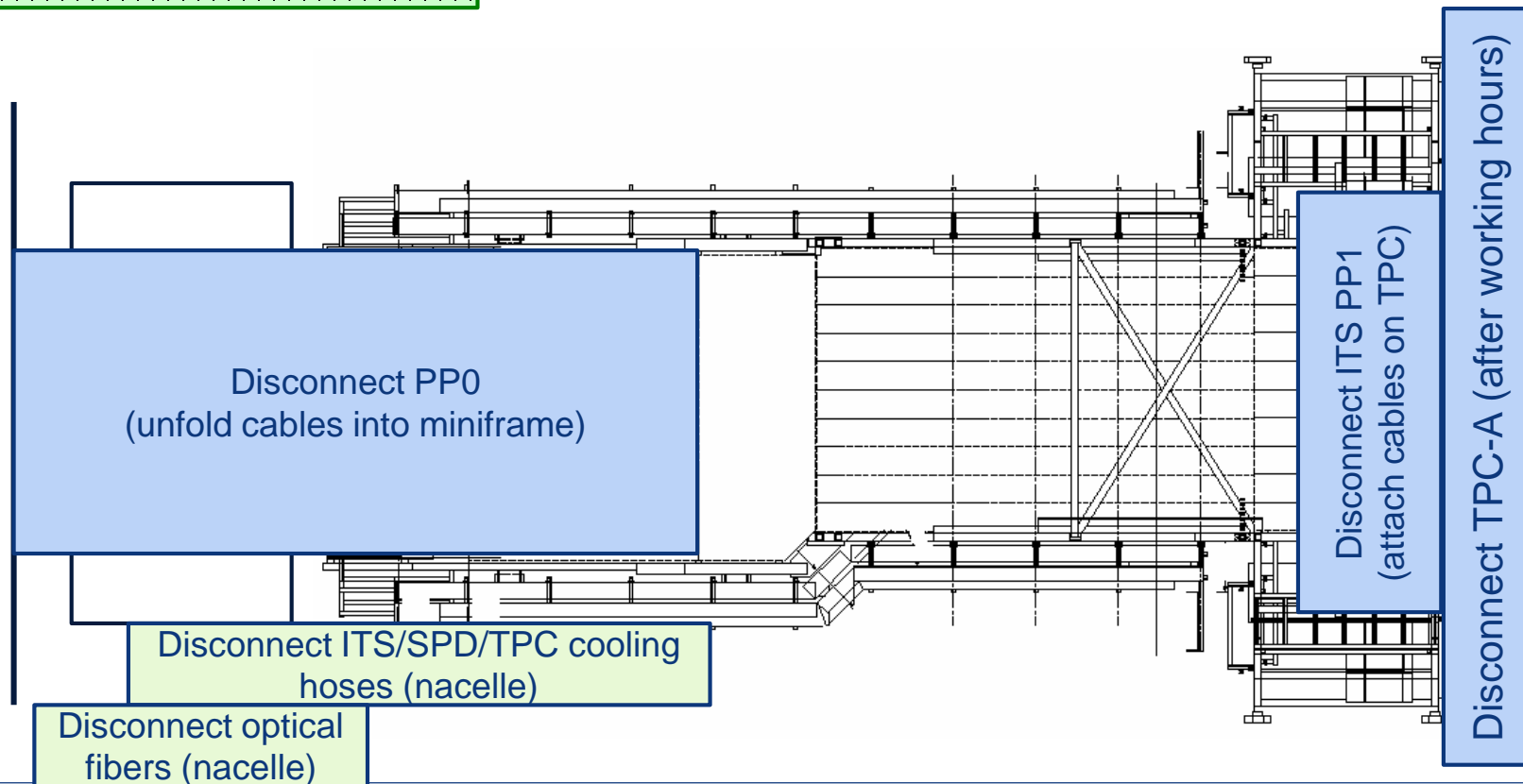

UX25 activities w51 – Tue 18 Dec 2018

Cavern lift maintenance from 6:00 AM to 8:00 AM, cavern access after 8:00 AM

Unrestricted cavern access

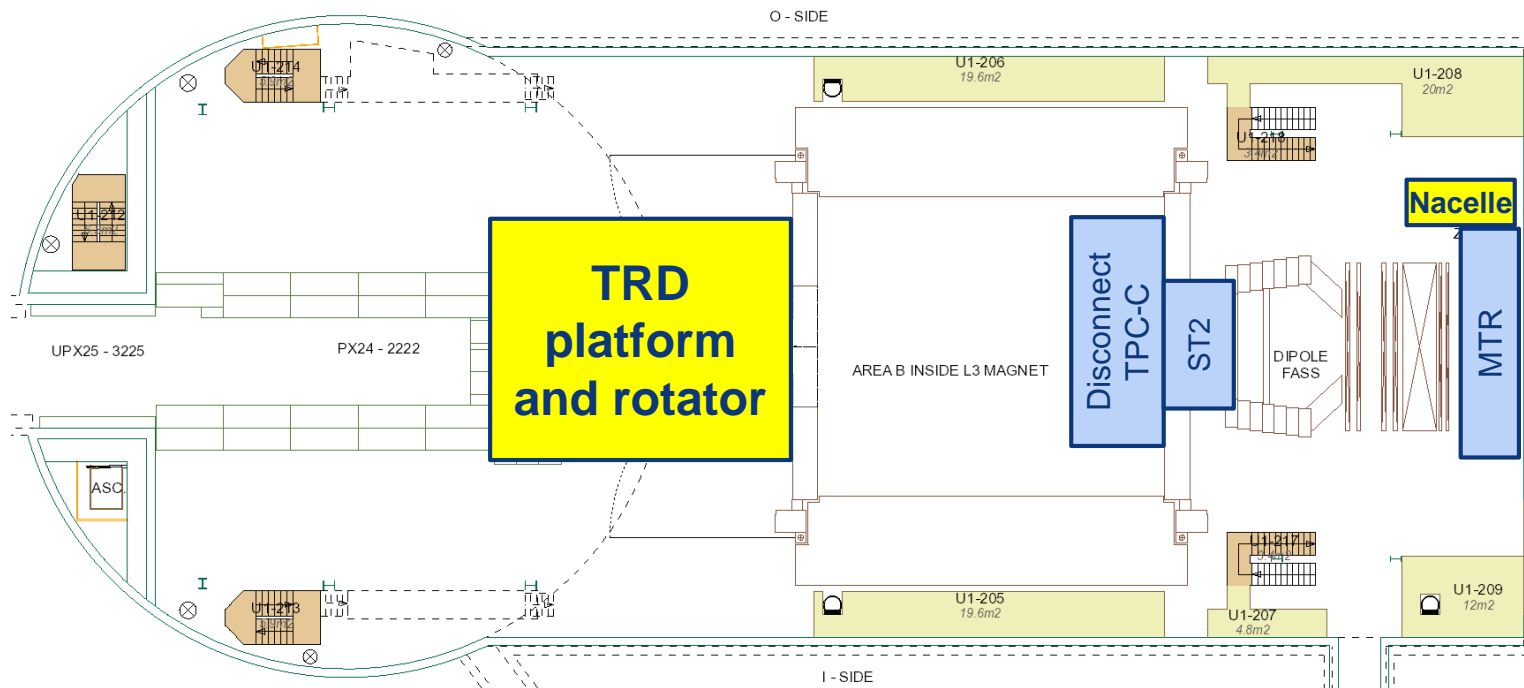

Miniframe activities w51 – Tue 18 Dec 2018

Cavern lift maintenance from 6:00 AM to 8:00 AM, cavern access after 8:00 AM

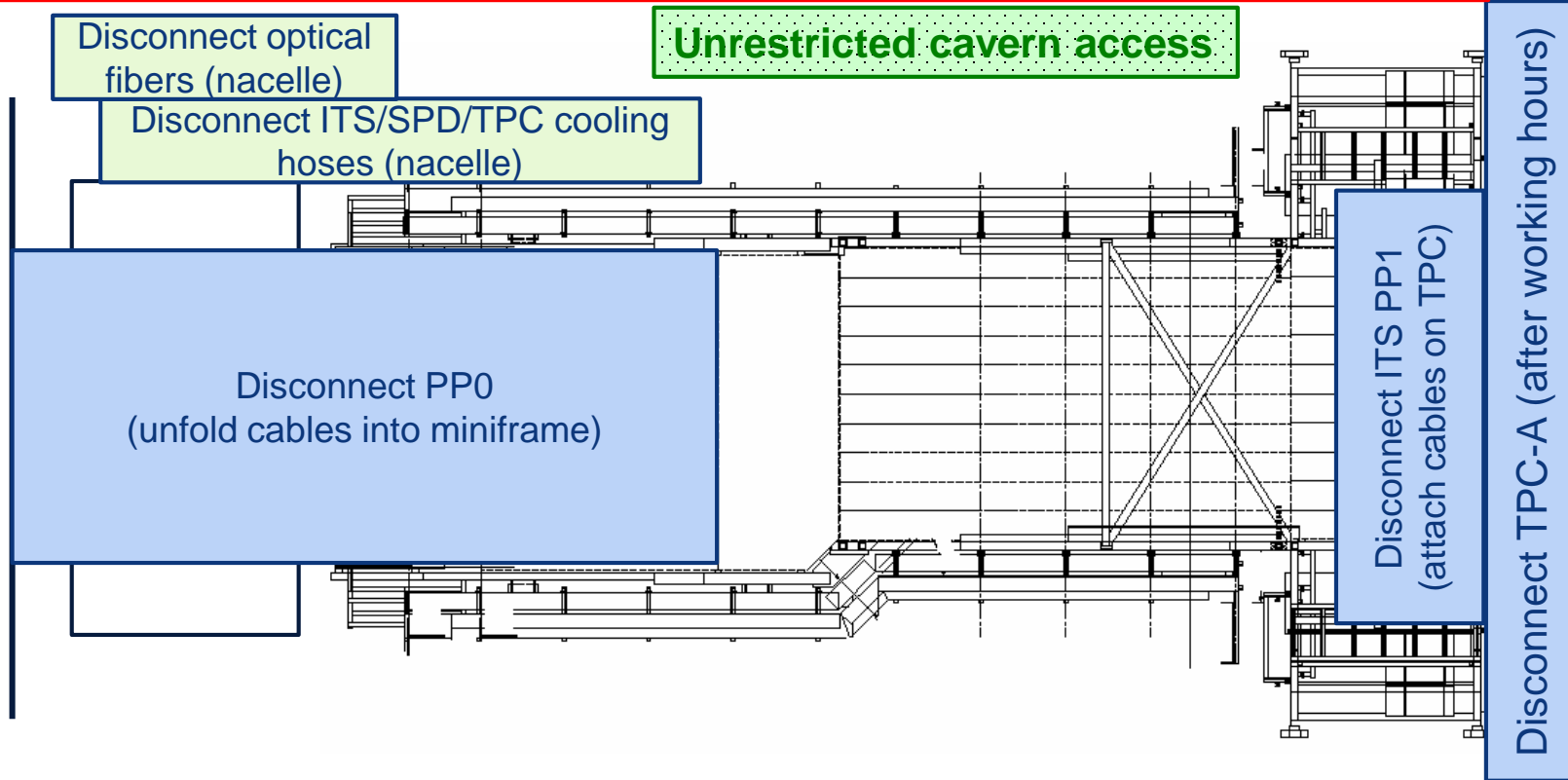

UX25 activities w51 – Wed 19 Dec 2018

Unrestricted cavern access

ALTEAD: bring TRD6 in SXL2 (transfer into blue frame)

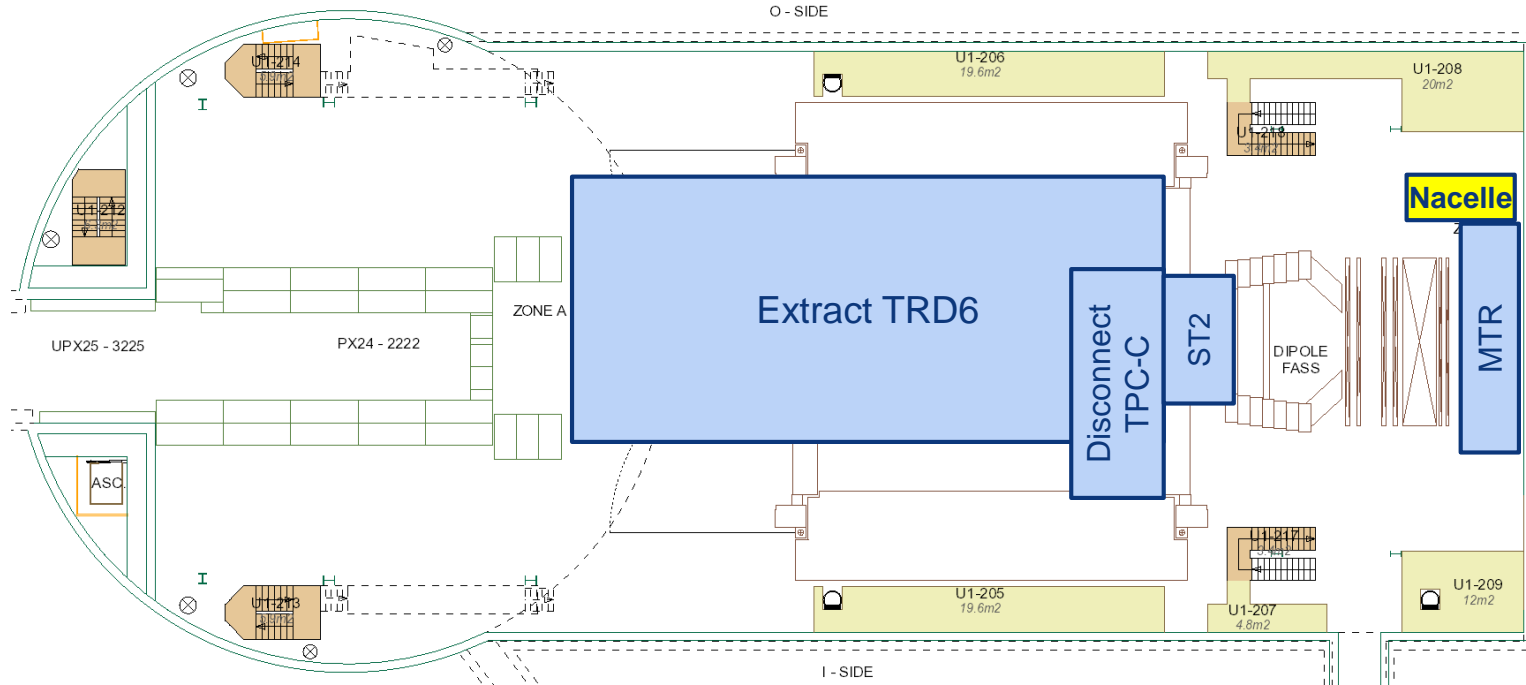

Miniframe activities w51 – Wed 19 Dec 2018

Unrestricted cavern access

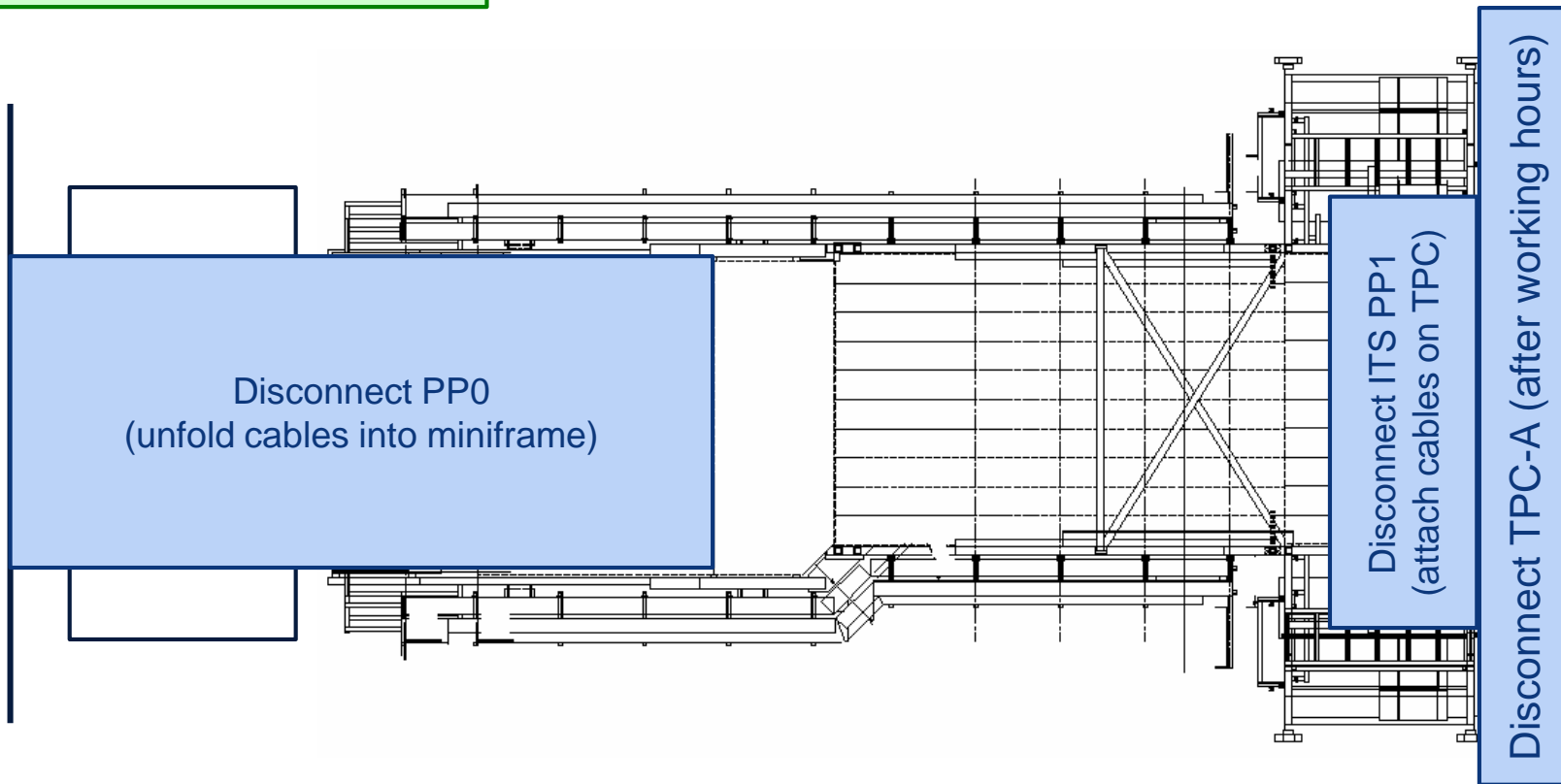

UX25 activities w51 – Thu 20 Dec 2018

Unrestricted cavern access

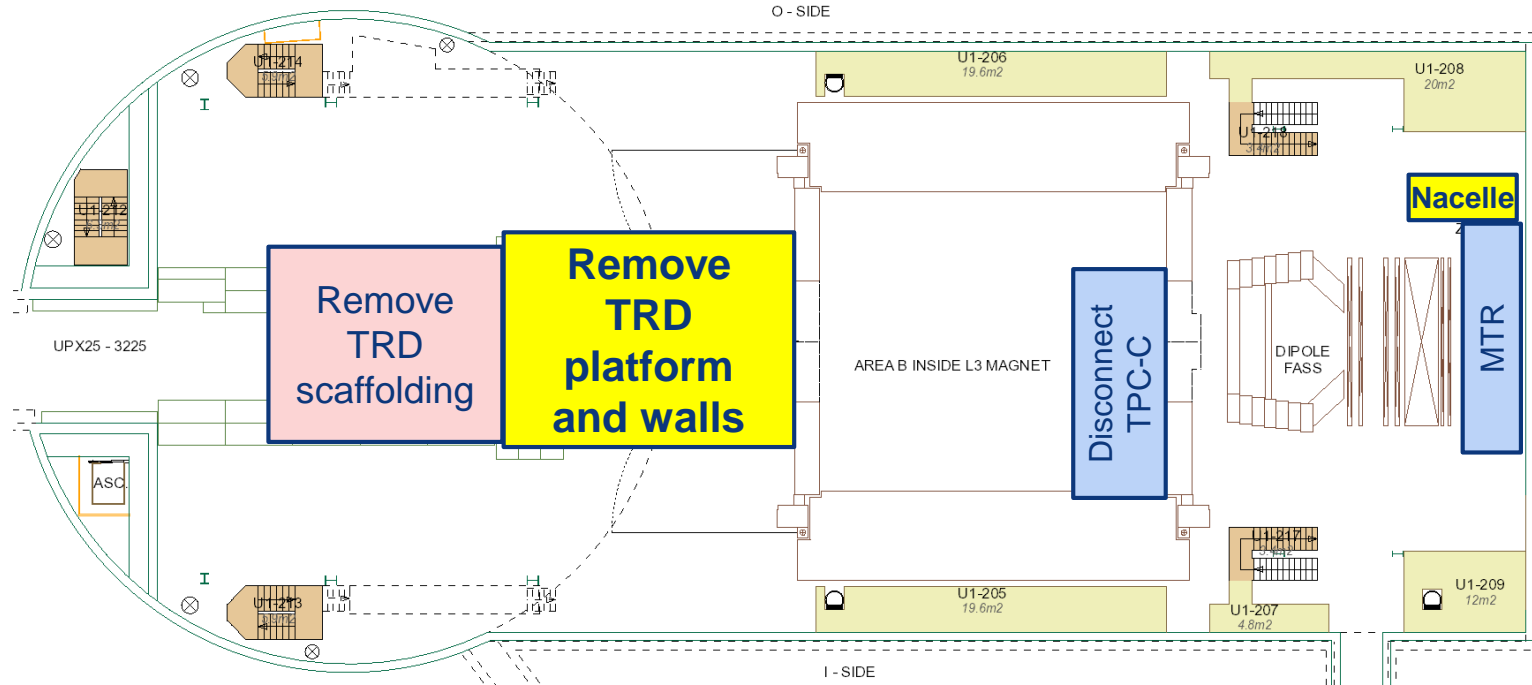

Miniframe activities w51 – Thu 20 Dec 2018

Unrestricted cavern access

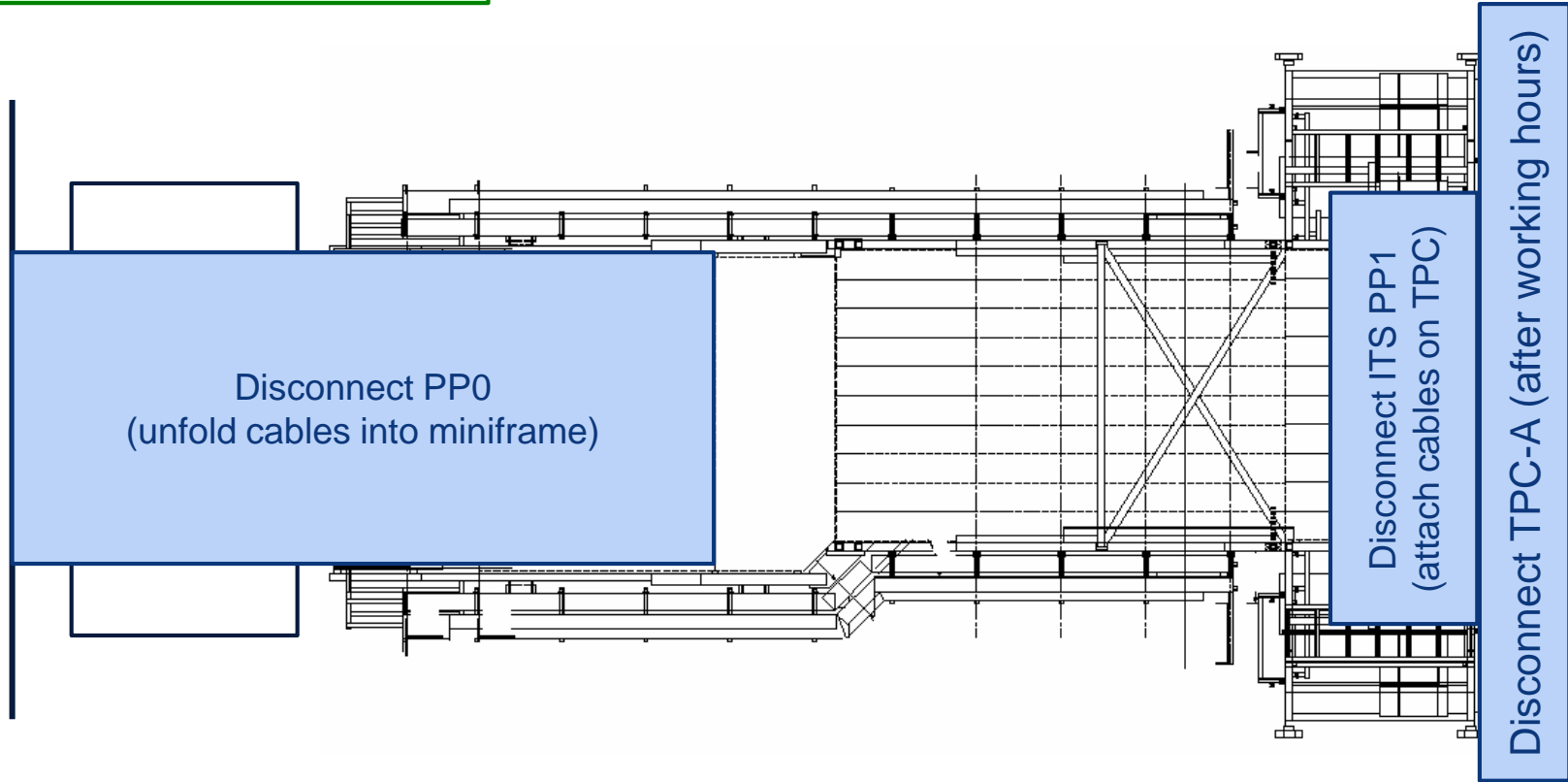

UX25 activities w51 – Fri 21 Dec 2018

No access cavern whole day (ALTEAD starts at 6:00 AM)

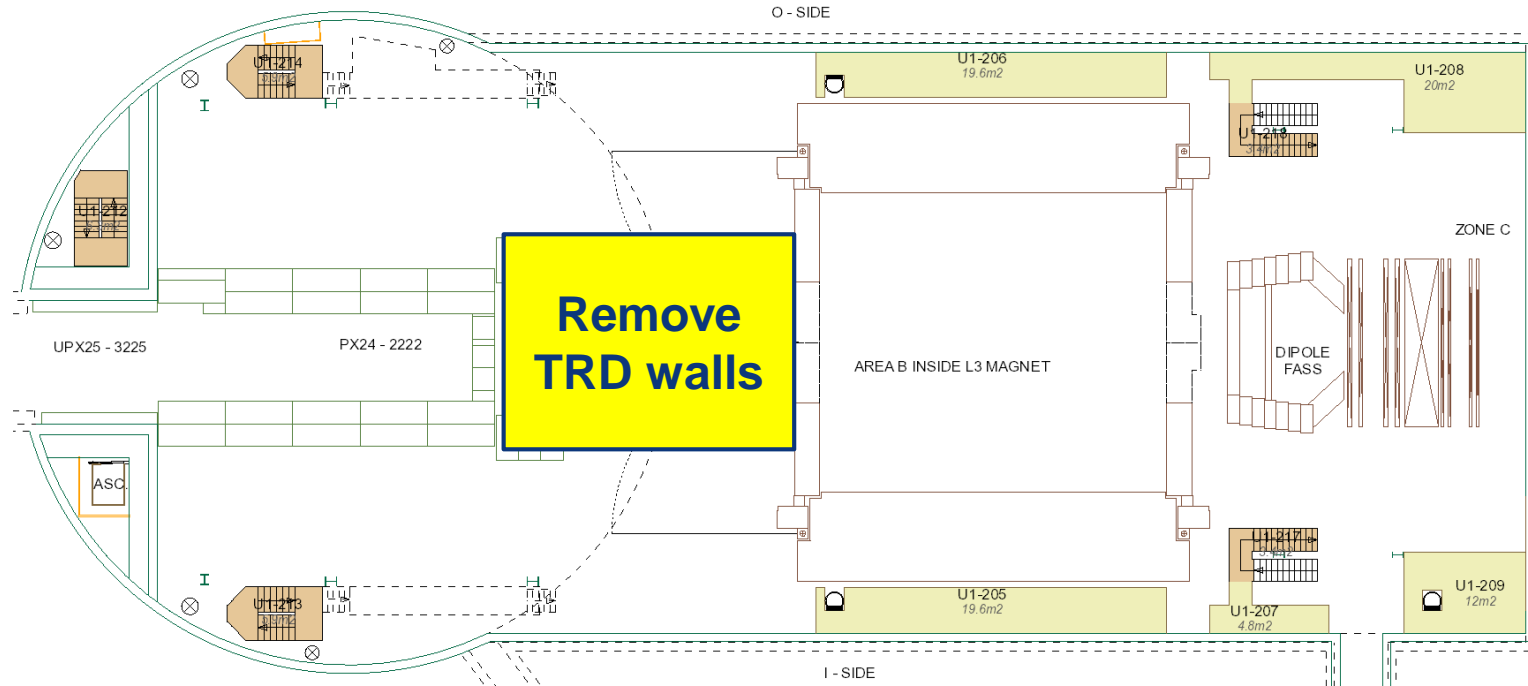

Miniframe activities w51 – Fri 21 Dec 2018

No access cavern whole day (ALTEAD starts at 6:00 AM)

Remove
MCTS
scaffolding

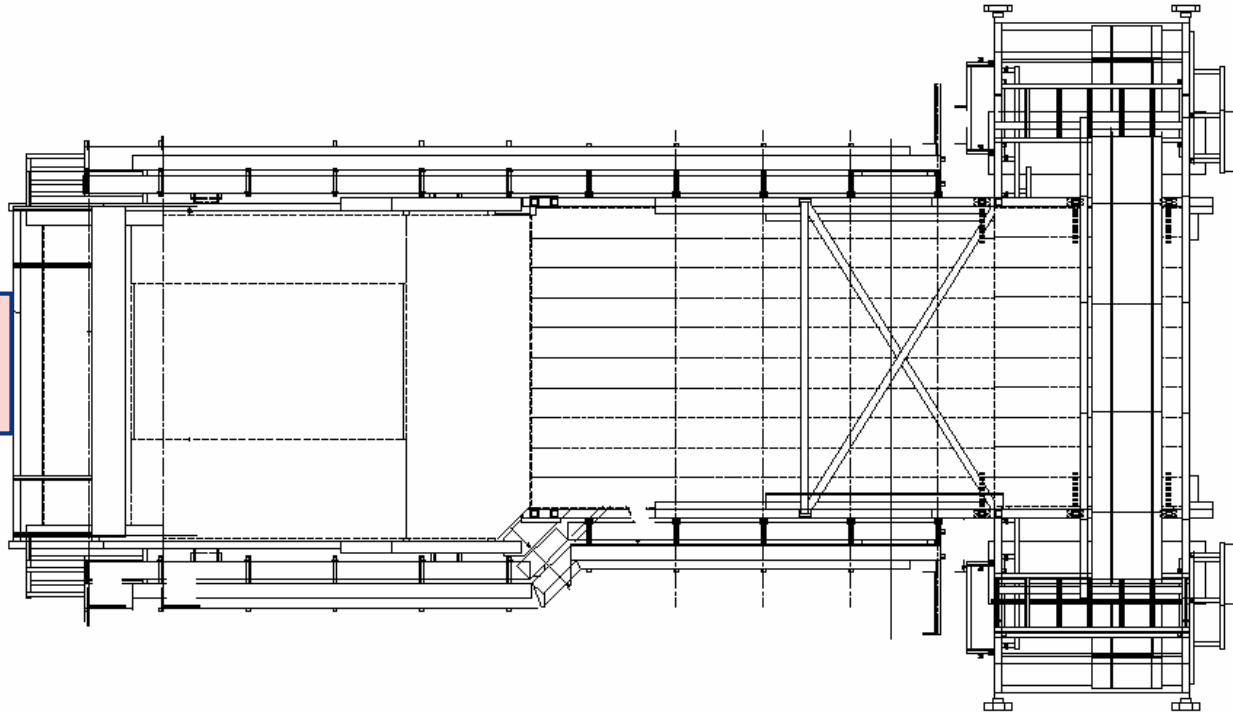

Activities Xmas closure

Activities Xmas closure

- BE-ICS: evacuation sirens tests – 27.12 from 8:00 to 12:00

Storage in December

SX2 in December, storage

- V0A-FMD1 → 610
- ADA → 3297; ADA shielding → SU2
- PMD ventilation pipes → bin
- ZEM → 3297; ZEM table → SU2
- RB24 beampipe + vacuum equip. → FLEX
- Beampipe protection → SU2
- BCM → Pieter
- BLM → BLM team
- TPC black hoses and supports → 3297
- ITS PP1 and PP0 services → bin
- TRD table → outside behind tent
- Detector crates → 610

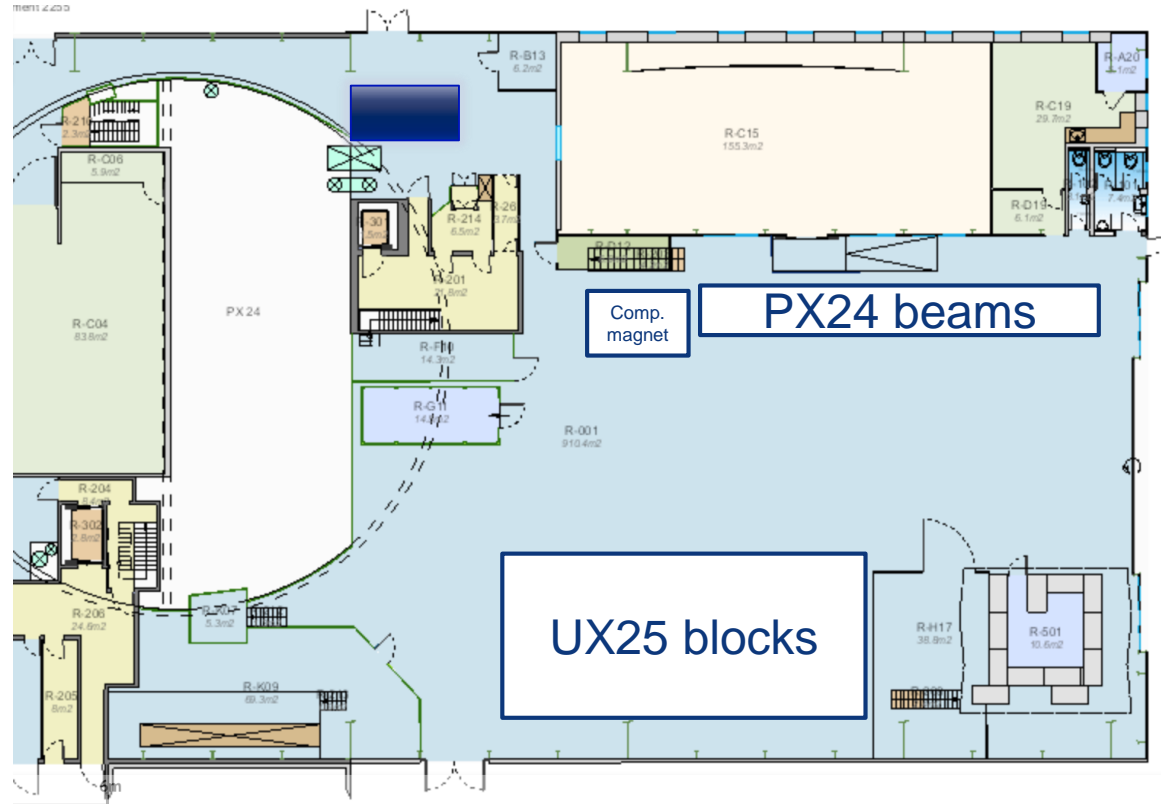
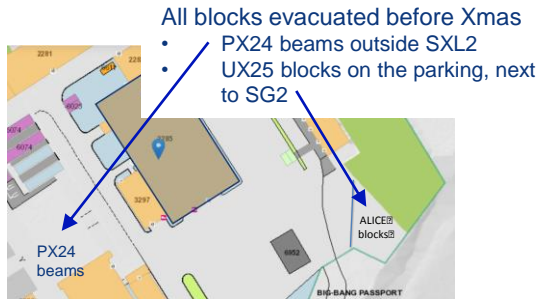

SXL2 in December, storage

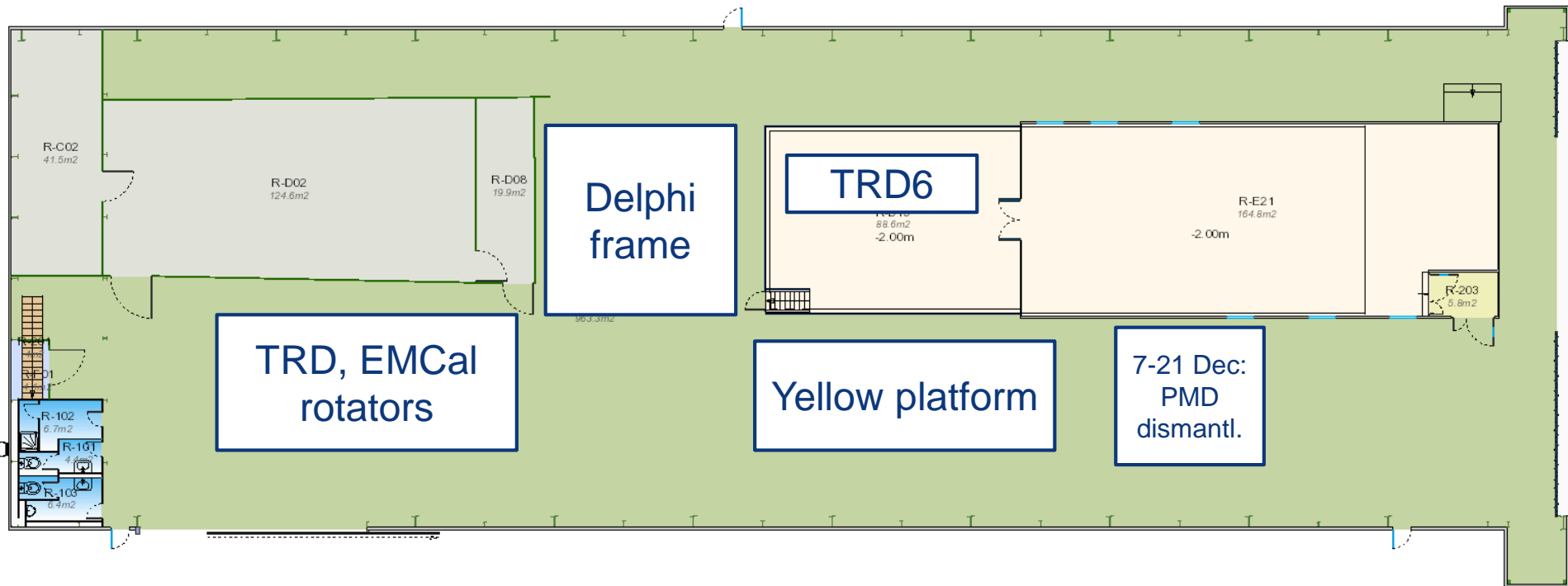

L3 ventilation pipes → SXL2 ?