



Linear Colliders

Lecture 3

Subsystems II



Frank Tecker – CERN

- Main Linac (cont.)
 - RF system and technology
 - Accelerating gradient
- Beam / bunch structure
- Beam Delivery System
- Alignment and Stabilization

- Particle production
 - Damping rings with wiggler magnets
 - Bunch compressor with magnetic chicane
- ⇒ **small, short bunches**
to be accelerated
w/o emittance blowup

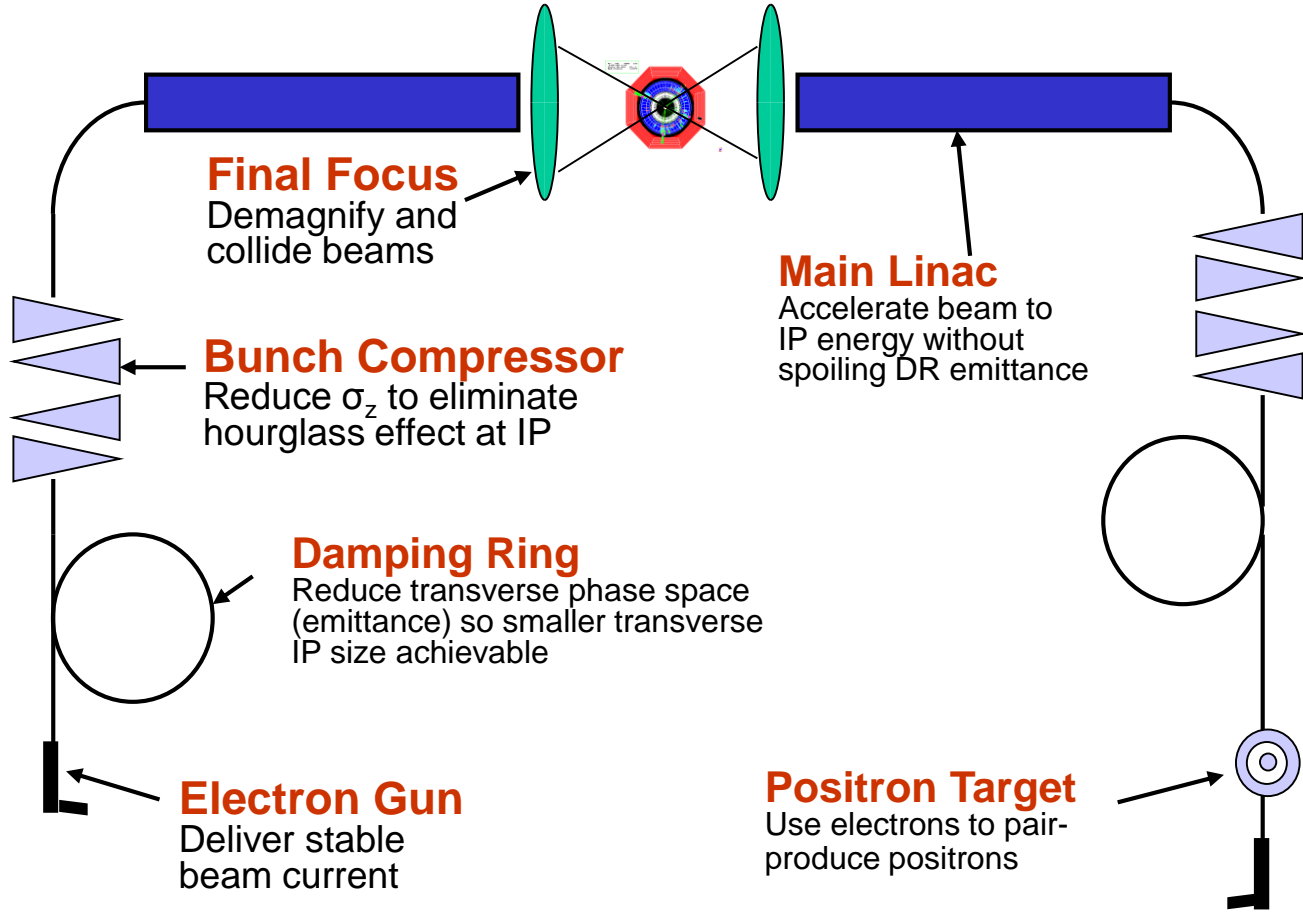

- Main linac: longitudinal wakefields cause energy spread
⇒ Chromatic effects
- Long-range (multi-bunch) wakefields are minimized by structure design

- Need **efficient acceleration** in main linac
- 4 primary components:
 - **Modulators:** convert line AC → pulsed DC for klystrons
 - **Klystrons:** convert DC → RF at given frequency
 - **RF distribution:** transport RF power → accelerating structures evtl. RF pulse compression
 - **Accelerating structures:** transfer RF power → beam

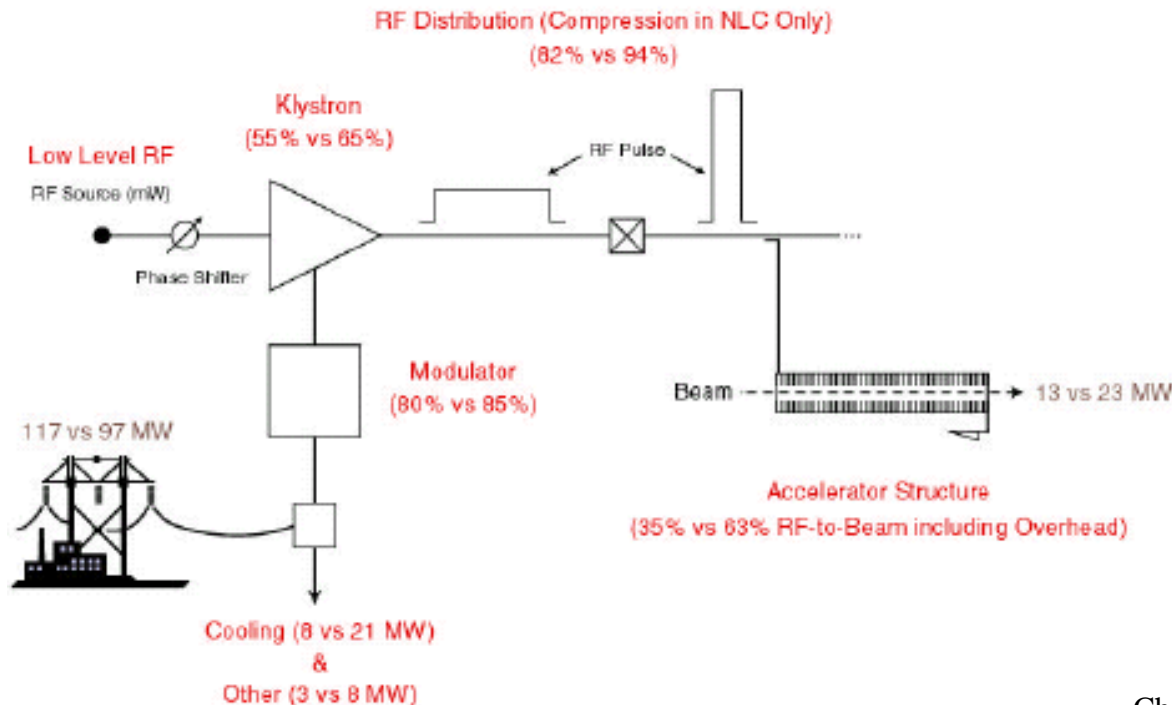

Modulator

Energy storage in capacitors
charged up to 20-50 kV (between pulses)

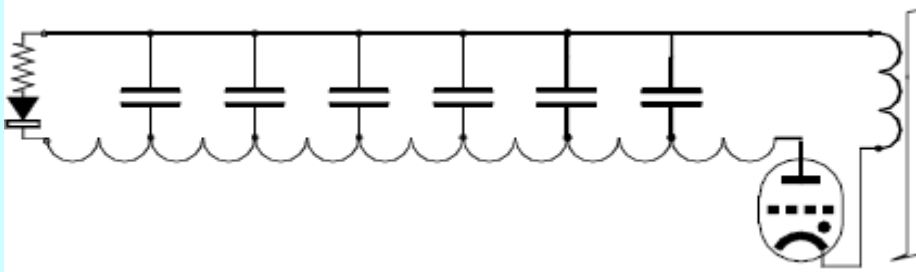

High voltage switching and
voltage transformer
rise time > 300 ns

Or solid state device

Klystron

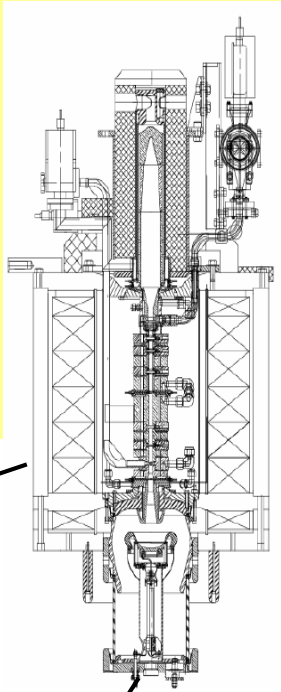

U 150 -500 kV
 I 100 -500 A
 f 0.2 -20 GHz

$P_{ave} < 1.5$ MW
 $P_{peak} < 150$ MW

efficiency 40-70%

***=> for power efficient operation
pulse length $t_p \gg 300$ ns favourable***

- narrow-band vacuum-tube amplifier at microwave frequencies (an electron-beam device).
- low-power signal at the design frequency excites input cavity
- Velocity modulation becomes time modulation in the drift tube
- Bunched beam excites output cavity

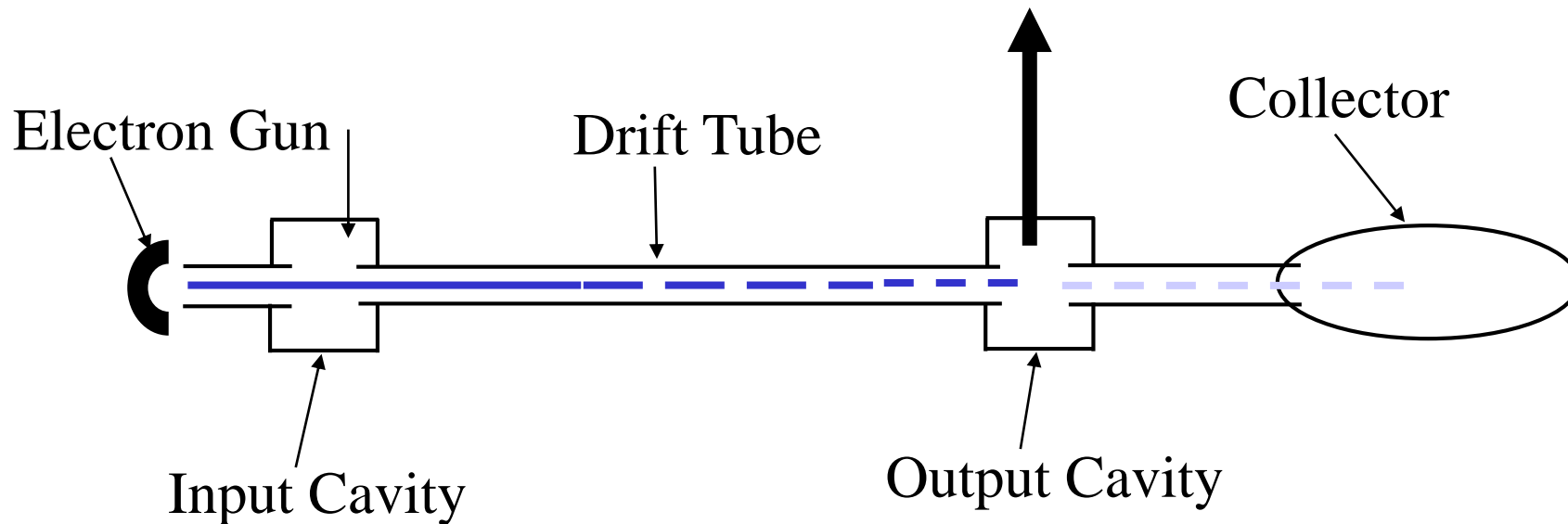

- Fields established after cavity filling time
- Only then the beam pulse can start
- Steady state: power to beam, cavity losses, and (for TW) output coupler

- Efficiency:
$$h_{RF \rightarrow beam} = \frac{P_{beam}}{P_{beam} + P_{loss} + P_{out}} \frac{T_{beam}}{T_{fill} + T_{beam}}$$

$$\approx 1 \text{ for SC SW cavities}$$

- NC TW cavities have smaller fill time T_{fill}

- In the past, SC gradient typically 5 MV/m and expensive cryogenic equipment
- TESLA development: new material specs, new cleaning and fabrication techniques, new processing techniques
- Significant cost reduction
- Gradient substantially increased
- Electropolishing technique has reached ~35 MV/m in 9-cell cavities
- 31.5 MV/m ILC baseline
- **limited by critical magnetic field H_{crit}** above which no superconductivity exists



Chemical polish

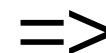

Electropolishing

- Large progress by R&D program to systematically understand and set procedures for the production process
- reached goal for a 50% yield at 35 MV/m by the end of 2010
- 90% yield at 28 MV/m exceeded in 2012
- Tests for higher gradient ongoing
- limited certainly below 50 MV/m (H_{crit})

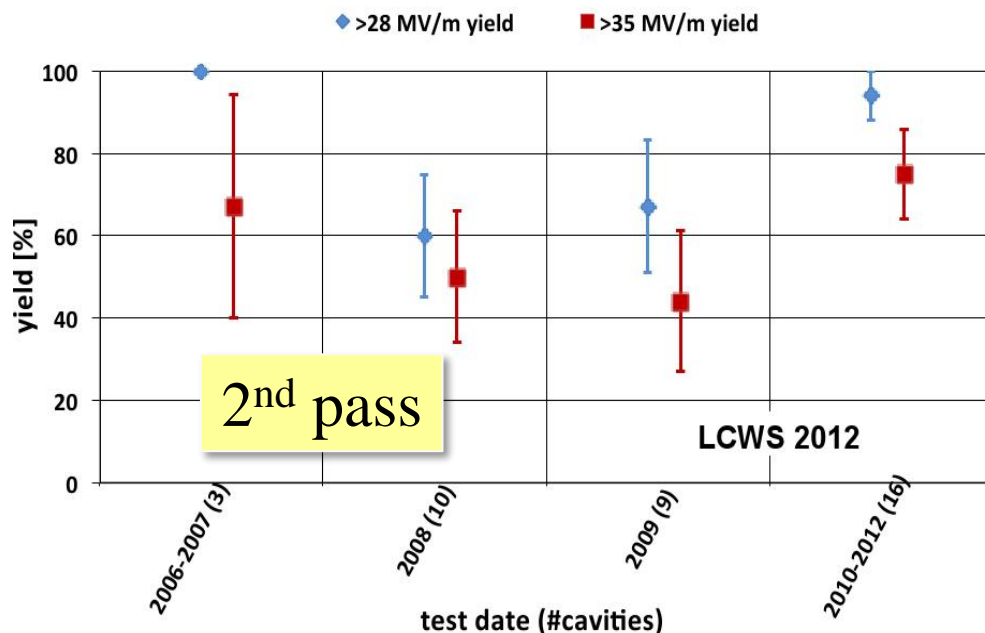
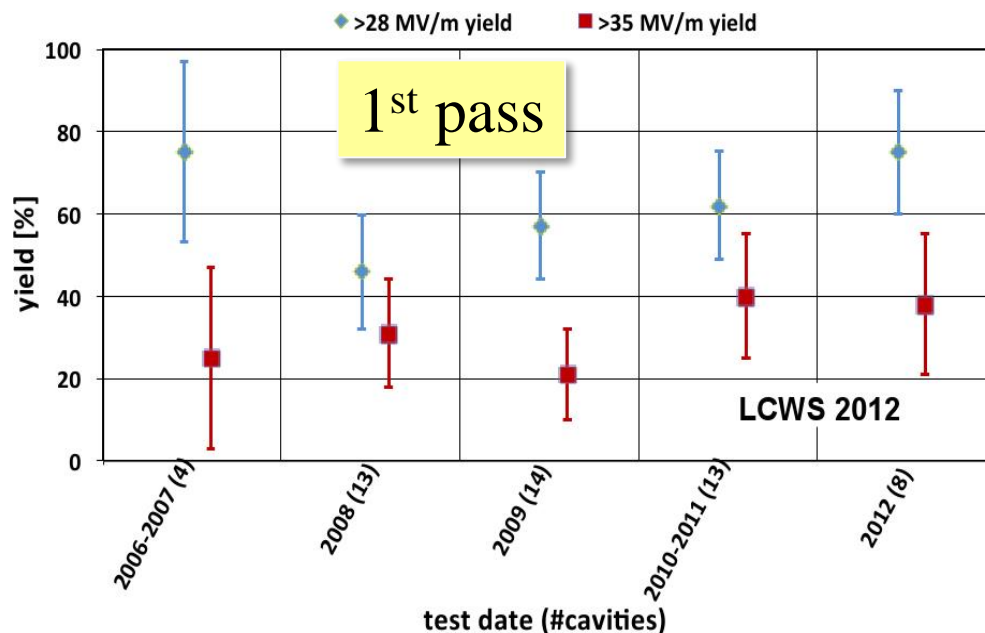

- Surface magnetic field

- SC structures become normal conducting above H_{crit}
- NC: Pulsed surface heating \Rightarrow material fatigue \Rightarrow cracks

- Field emission due to surface electric field

- Vacuum arcs - RF break downs
- Break down rate \Rightarrow Operation efficiency
- Local plasma triggered by field emission \Rightarrow Erosion of surface
- Dark current capture
 \Rightarrow Efficiency reduction, activation, detector backgrounds

- RF power flow

- RF power flow and/or iris aperture apparently have a strong impact on achievable E_{acc} and on surface erosion. Mechanism not fully understood

- Material surface has some intrinsic roughness (from machining)

- Leads to **field enhancement**
 β field enhancement factor

$$E_{\text{peak}} = \beta E_0$$

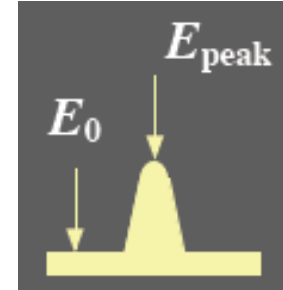

- Need **conditioning** to reach ultimate gradient
 RF power gradually increased with time

- RF processing can melt field emission points

from S.Doebert

- Surface becomes smoother
- field enhancement reduced
- => **higher fields**
less breakdowns

- More energy: Molten surface splatters and generates new field emission points!
- Excessive fields can also damage the structures

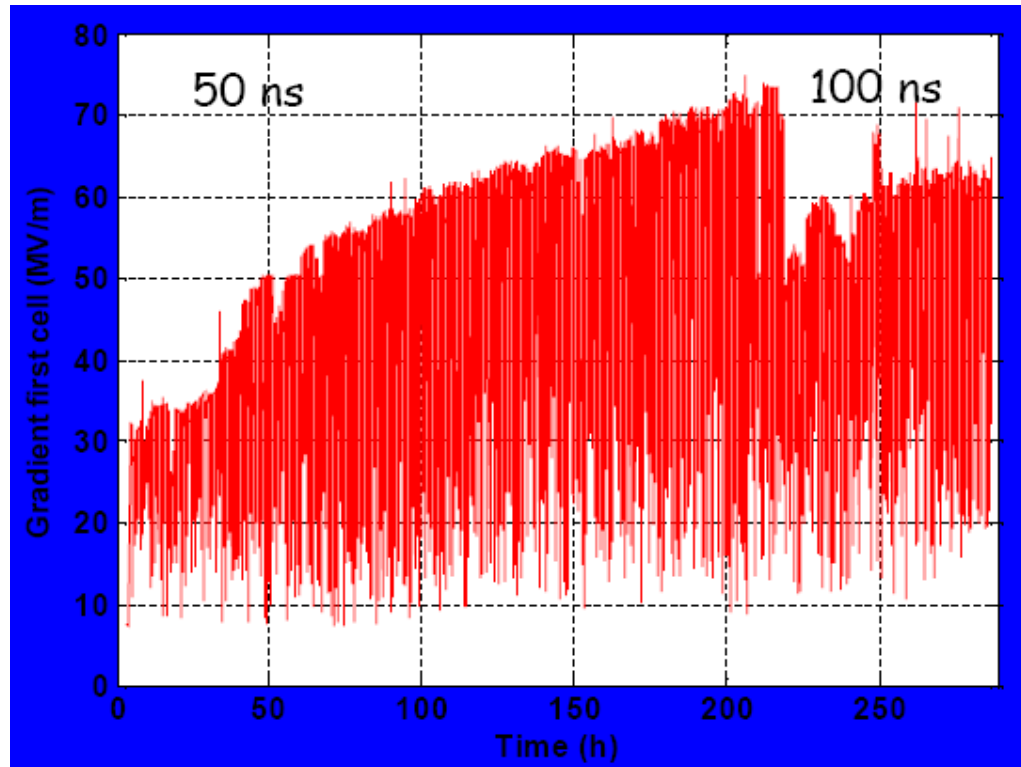

- Strong increase of breakdown rate for higher gradient

High Gradient Performance

5 Structures after ~ 500 hr of Operation and
8 Structure Average after > 1500 hr of Operation

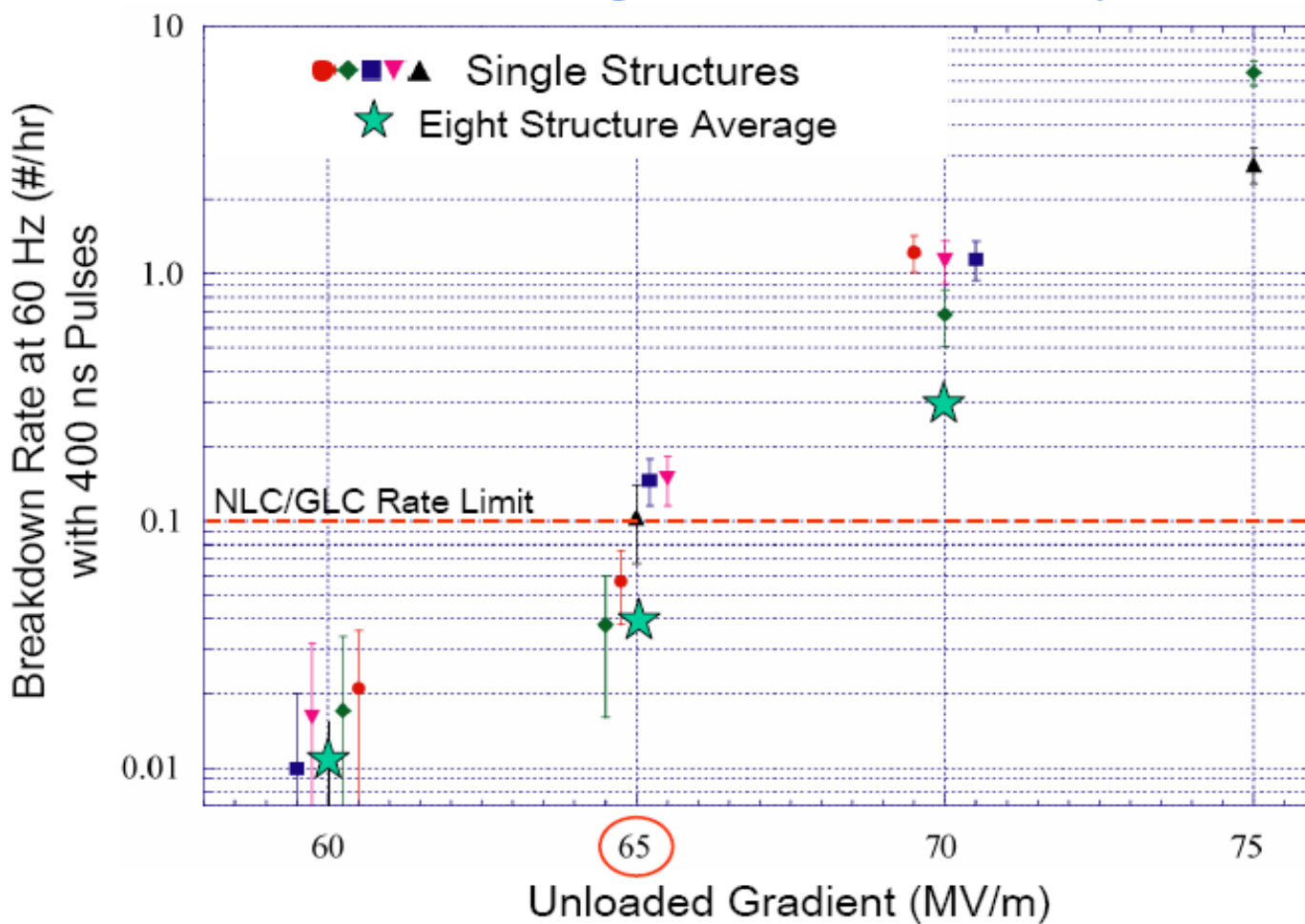

C. Adolphsen /SLAC

- Higher breakdown rate for longer RF pulses

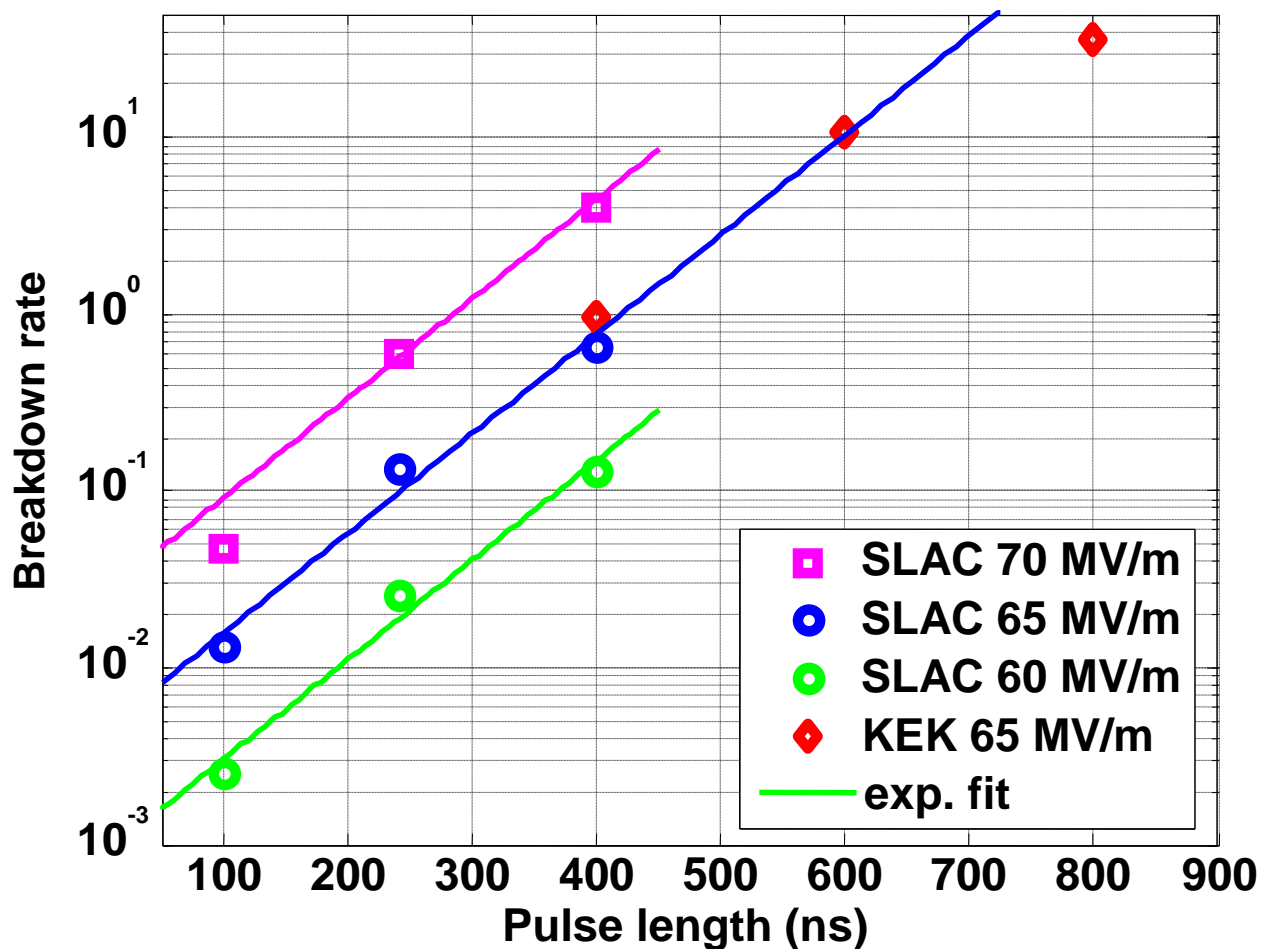

- Summary:** breakdown rate limits pulse length and gradient

- Normal conducting cavities have higher gradient with shorter RF pulse length
- Superconducting cavities have lower gradient (fundamental limit) with long RF pulse

Accelerating fields in Linear Colliders

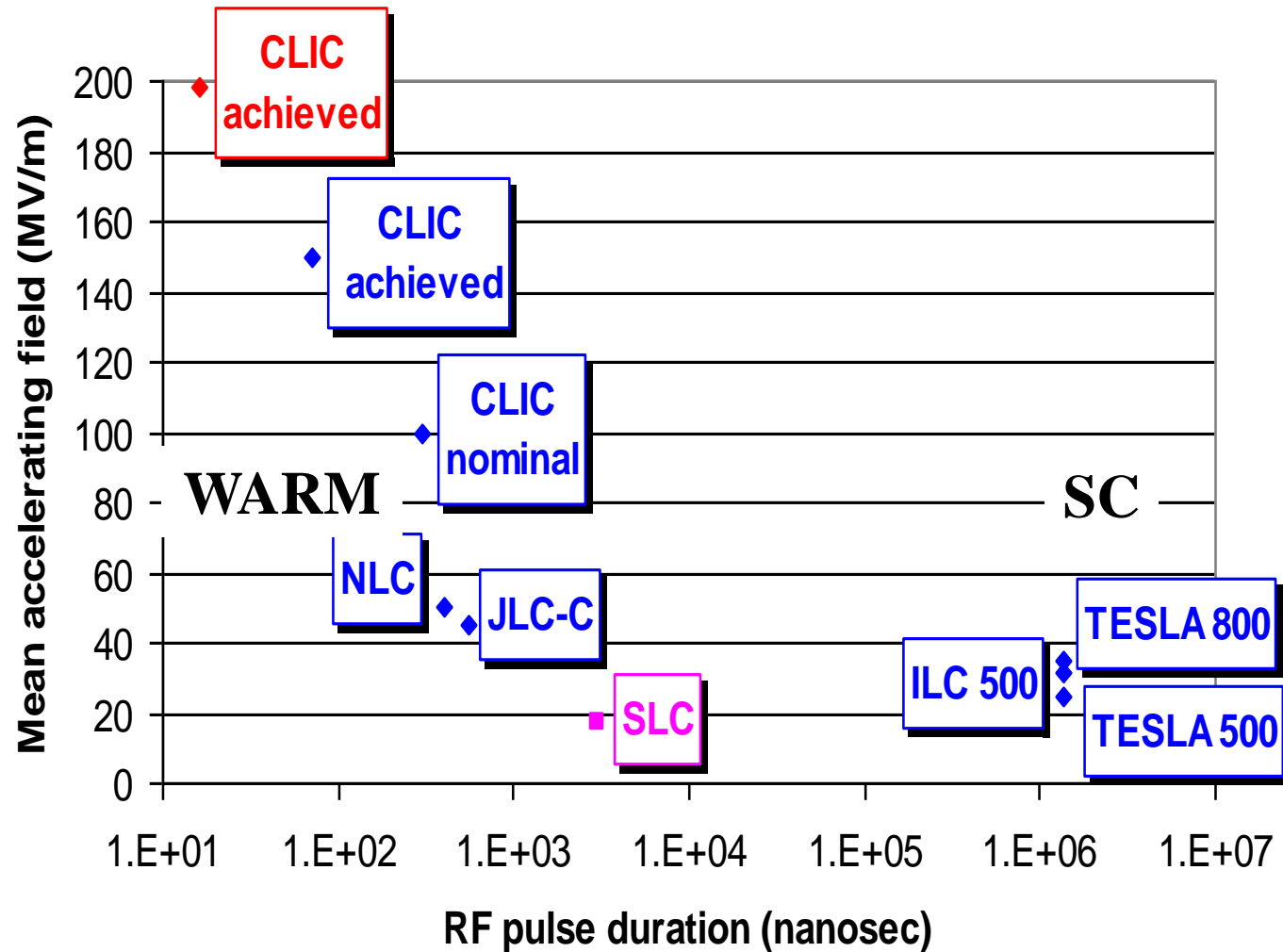

- **SC** allows long pulse, **NC** needs short pulse with smaller bunch charge

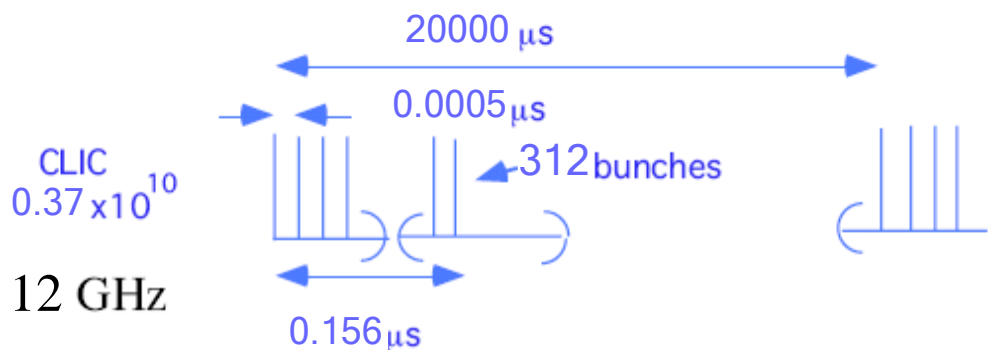
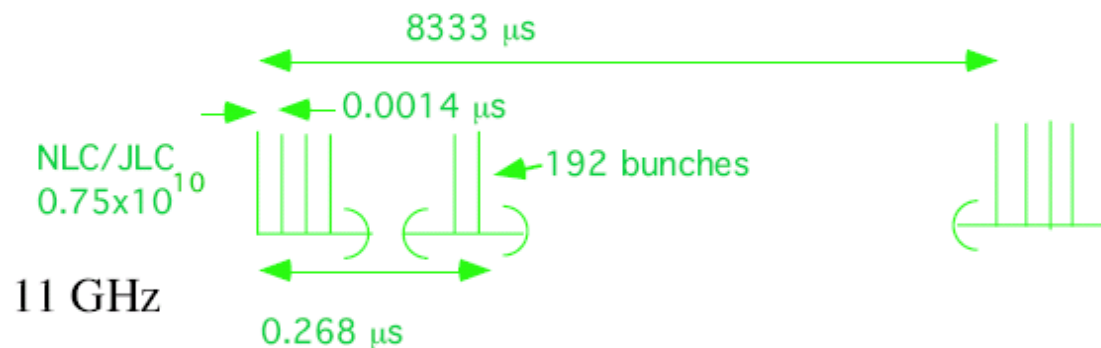
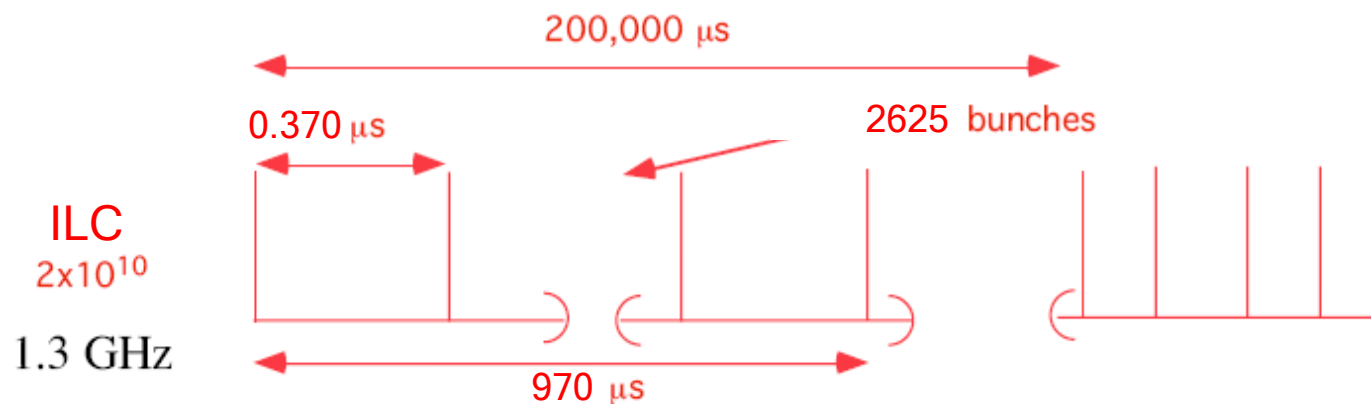

The different RF technologies used by ILC, NLC/JLC and CLIC require different packaging for the beam power

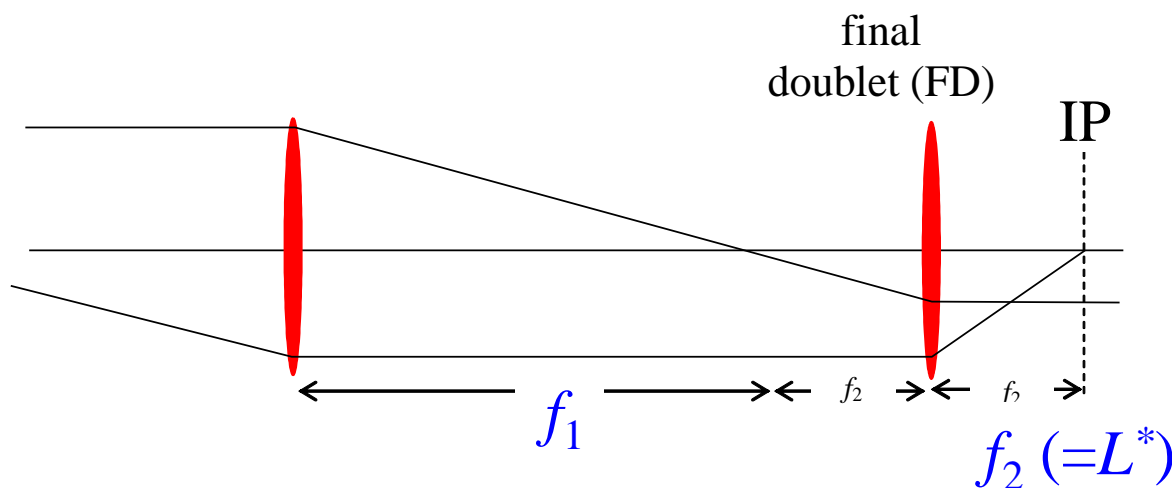

- Need **large demagnification** of the (mainly vertical) beam size

$$M = \sqrt{\beta_{linac} / \beta_y^*} = f_1 / f_2 \quad \text{typical value } \approx 300$$
- β_y^* of the order of the bunch length σ_z (hour-glass effect)
- Need **free space** around the **IP** for physics detector
- Assume $f_2 = 2 \text{ m} \Rightarrow f_1 \approx 600 \text{ m}$
- Can make shorter design but this roughly sets the length scale

- Need strong quadrupole magnets for the final doublet
- Typically hundreds of Tesla/m
- Get **strong chromatic aberrations**

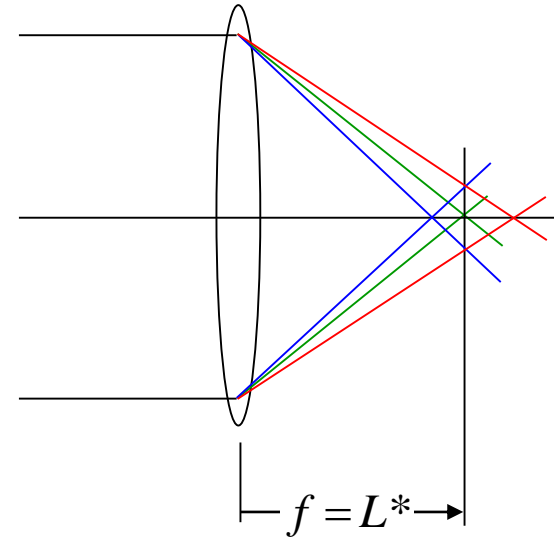

for a *thin-lens* of length l : $\frac{1}{f} \approx k_1 l$

change in deflection: $Dy'_{quad} \approx -k_1 l y_{quad} \frac{d}{1+d} \approx -k_1 l y_{quad} d$

change in IP position: $Dy_{IP} \approx f Dy'_{quad} = y_{quad} d$

RMS spot size: $\langle Dy_{IP}^2 \rangle = \langle y_{quad}^2 \rangle \langle d^2 \rangle = b_{quad} e_y d_{rms}^2$

- Small $\beta^* \Rightarrow \beta_{FD}$ very large (~ 100 km)

- for $\sigma_{rms}^{TM} \sim 0.3\%$

$$\sqrt{\langle \Delta y_{IP}^2 \rangle} \approx 20 - 40 \text{ nm}$$

- Definitely **much too large**
- We need to correct chromatic effects
- \Rightarrow introduce sextupole magnets

$$B_x = s x y$$

$$B_y = \frac{1}{2} s (x^2 + y^2)$$

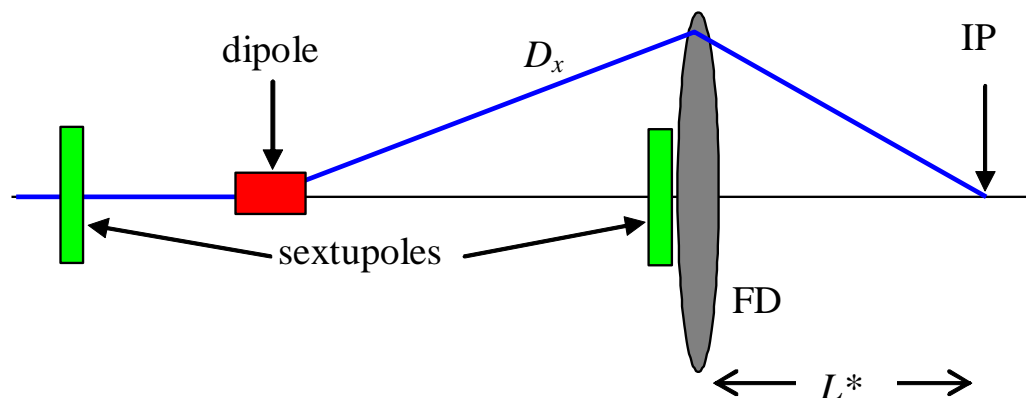

- Use dispersion D : $x = x_o + D\delta$

Combine quadrupole with sextupole and dispersion

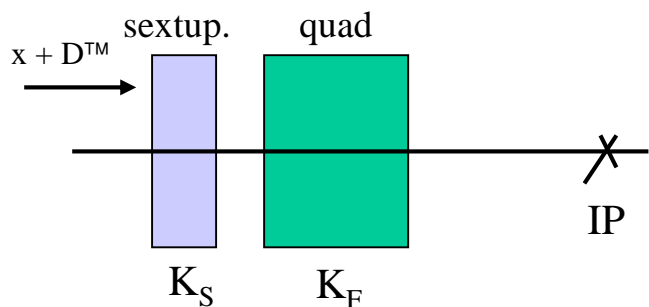

y plane straightforward
x plane more tricky

Second order dispersion

Quad:
$$Dx' = \frac{K_F}{(1+d)}(x + Dd) \Rightarrow K_F(-dx - Dd^2)$$

Sextupole:
$$Dx' = \frac{K_S}{2}(x + Dd)^2 \Rightarrow K_S D(dx + \frac{Dd^2}{2})$$

$$Dx' = \frac{K_F}{(1+d)}(x + Dd) + \frac{K_{b-match}}{(1+d)}x \Rightarrow 2K_F(-dx - \frac{Dd^2}{2})$$

$$K_{b-match} = K_F \quad K_S = \frac{2K_F}{D}$$

Could require $K_S = K_F/D$
 \Rightarrow 1/2 of second order dispersion left

Create as much chromaticity as FD upstream

\Rightarrow second order dispersion corrected

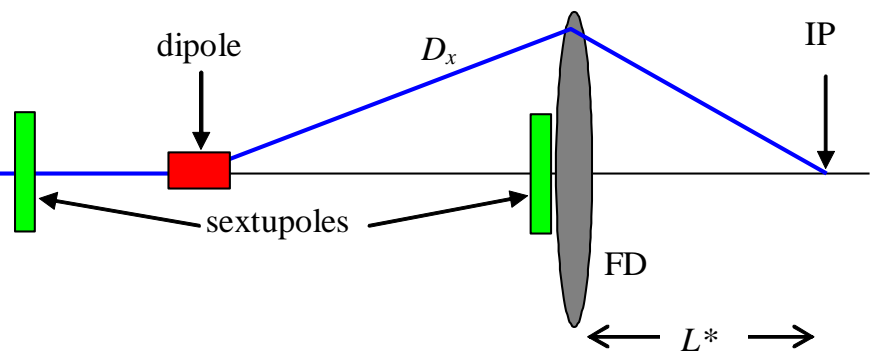

Correction in both planes

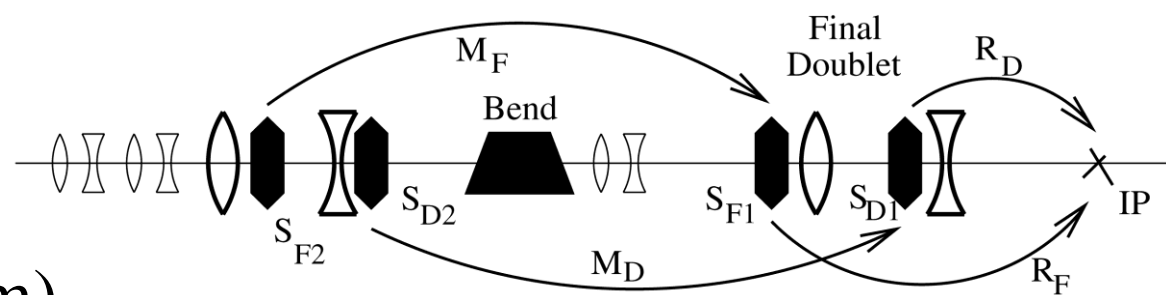

- Relatively short (few 100 m)
- Local chromaticity correction
- High bandwidth (energy acceptance)
- FF tested at ATF2 (KEK Japan)
 - 44 nm achieved (37 nm design)
 - scales to 6 nm at ILC (5 nm)

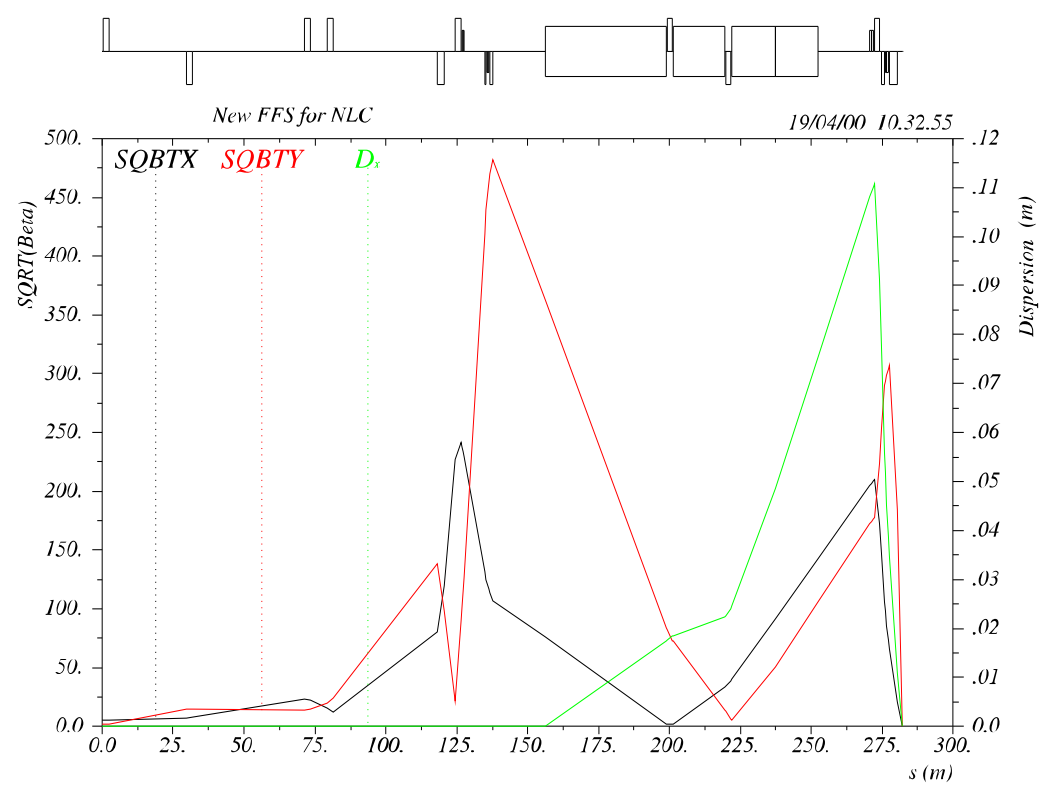

- From the hour-glass effect: $b_y @ S_z$
- For highest energies, additional fundamental limit:
synchrotron radiation in the **final** focusing **quadrupoles**
=> beamsize growth at the IP

- so-called *Oide Effect*:

minimum beam size:
$$\sigma \approx 1.83 \left(\frac{r_e \lambda_e}{2\pi} F \right)^{1/7} \epsilon_n^{5/7}$$

- for
$$\beta \approx 2.39 \left(\frac{r_e \lambda_e}{2\pi} F \right)^{2/7} \epsilon_n^{3/7}$$

λ_e is the Compton wavelength of the electron

F is a function of the focusing optics: typically $F \sim 7$ (minimum value ~ 0.1)

- $\sigma_{\text{oide}} = 0.85 \text{ nm}$ for 3 TeV CLIC

- **Tiny emittance** beams, nm vertical beam size at collision
- => **Tight component tolerances**
 - Field quality
 - Alignment
- Vibration and Ground Motion issues
- Active stabilisation
- Feedback systems
- Some numbers (CLIC):
 - Cavity alignment (RMS) 17 μm
 - Main Beam quad alignment: 14 μm
 - vert. MB quad stability: 1.5 nm @>1 Hz
 - hor. MB quad stability: 5 nm @>1 Hz
 - Final quadrupole: **0.15 nm** @>4 Hz !!!

- Any quadrupole misalignment and jitter will cause orbit oscillations and displacement at the IP

$$\Delta y^* = \sum_i^{Quads} k_{Q,i} \Delta y_{Q,i} \sqrt{\frac{\gamma_i}{\gamma^*}} \sqrt{\beta_i \beta^*} \sin(\Delta \phi_i)$$

- Precise mechanical alignment not sufficient
- Beam-based alignment**
- Dynamic effects of ground motion very important
- Demonstrate Luminosity performance in presence of motion

- **Site dependent** ground motion with decreasing amplitude for higher frequencies

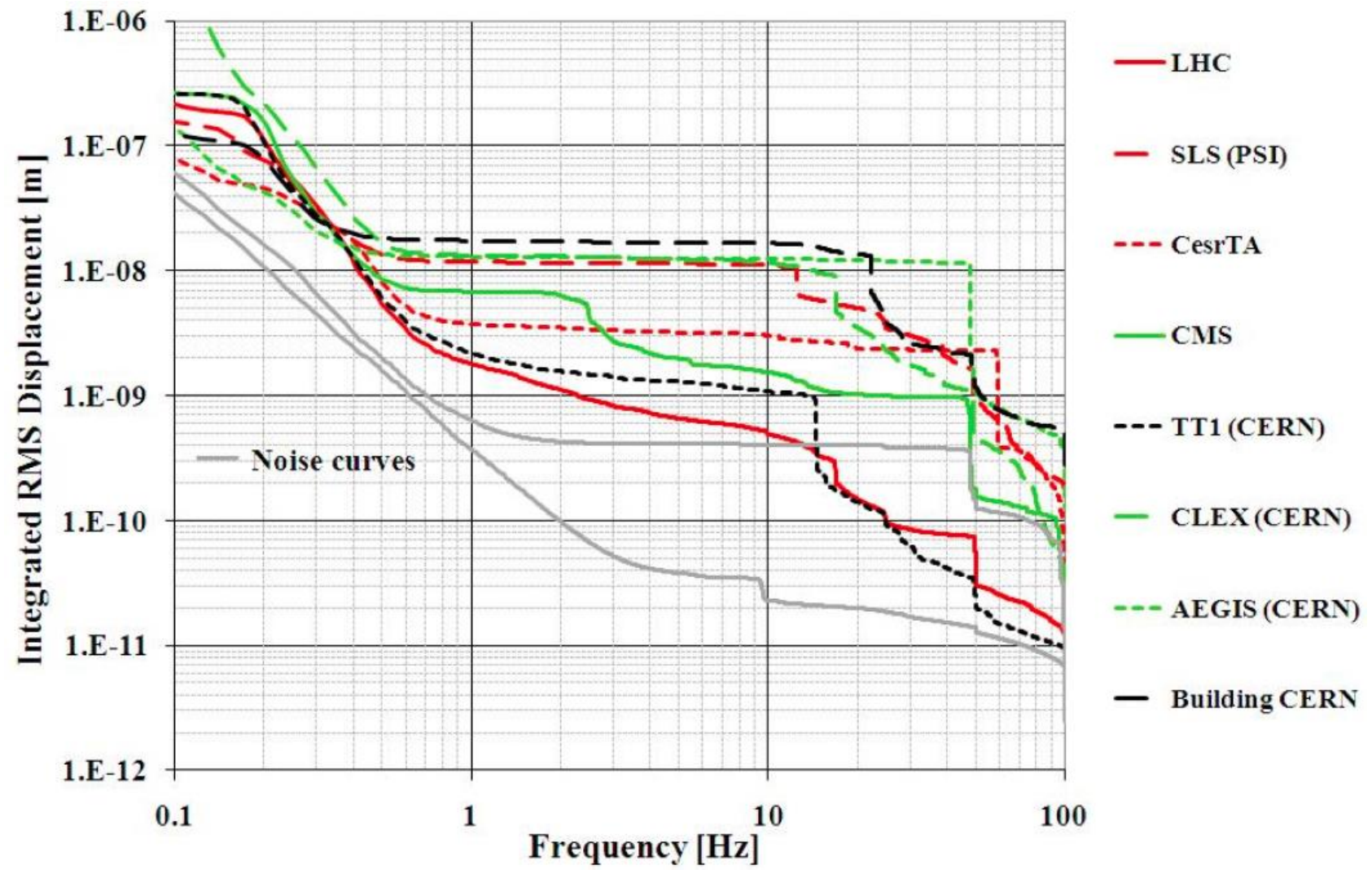

- Need to consider short and long term stability of the collider
- Ground motion model: **ATL law**

$$\langle \Delta y^2 \rangle = ATL$$

A site dependent constant

T time

L distance

A range 10^{-5} to $10^{-7} \text{ mm}^2/\text{m/s}$

- This allows you to simulate ground motion effects
- **Relative motion smaller**
- Long range motion less disturbing

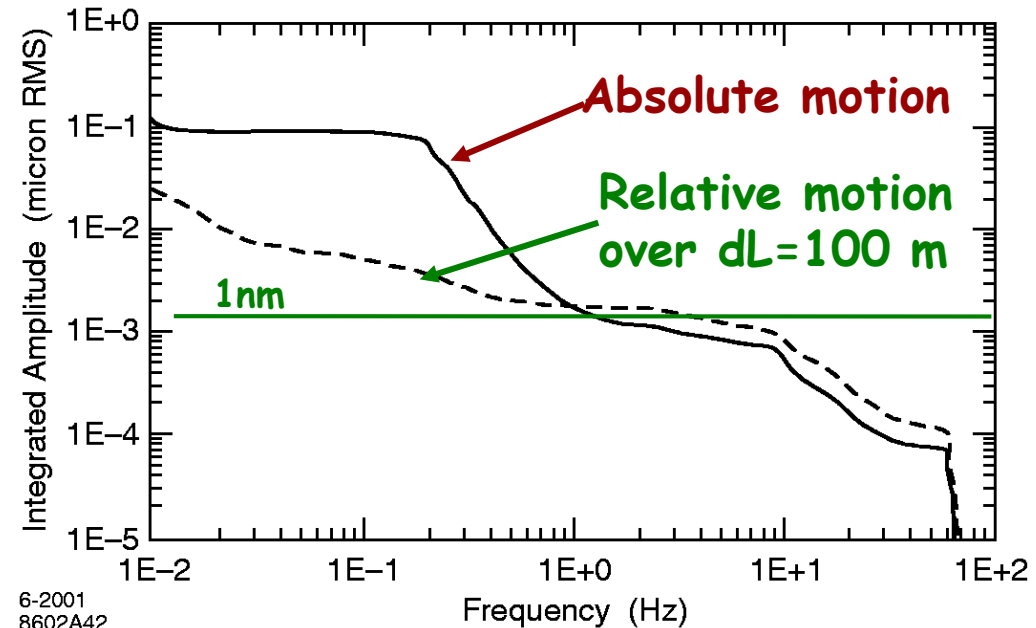

● Test bench reaches required stability of CLIC MB quadrupole

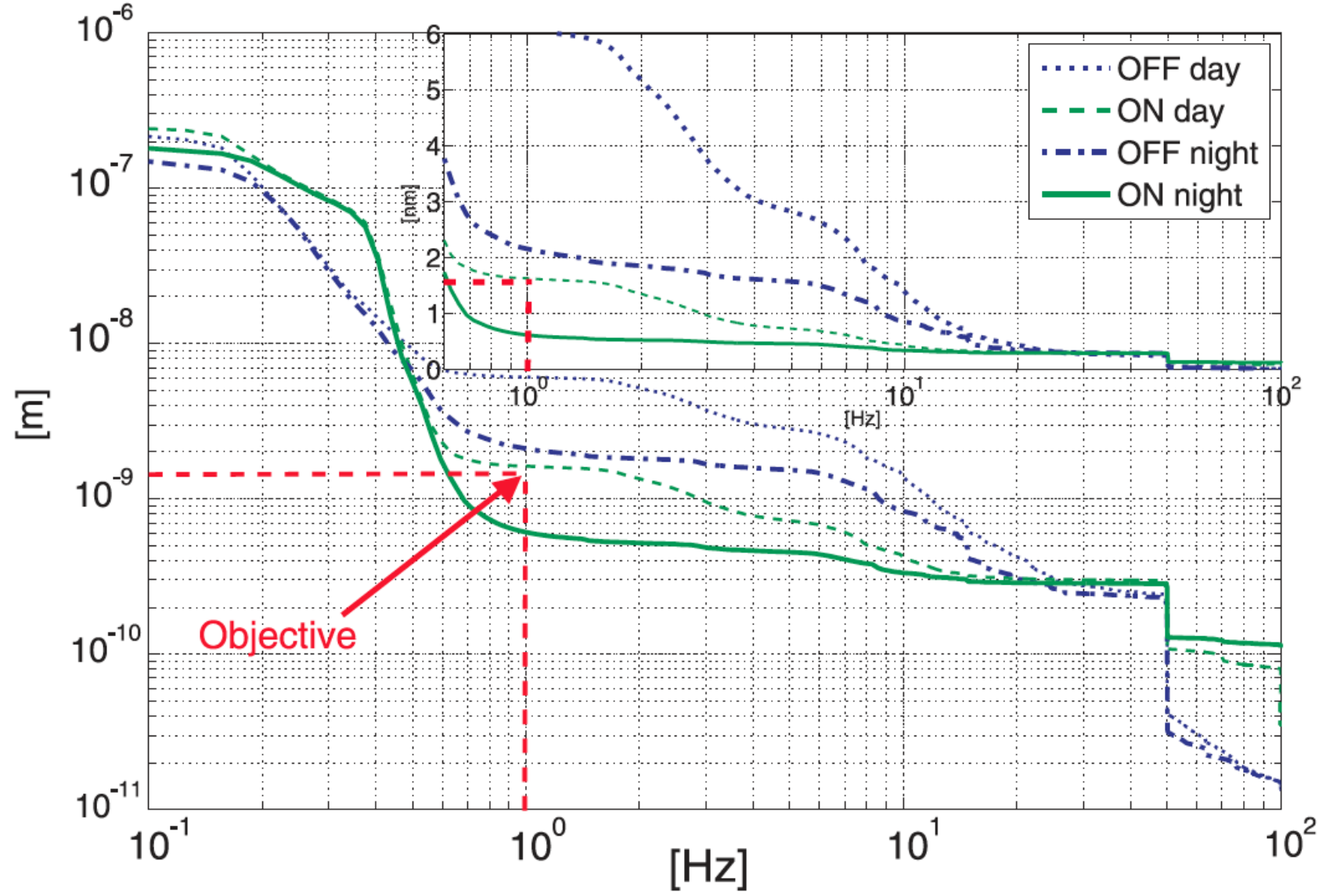

- Use the **strong beam-beam** deflection **kick** for keeping beams in collision
- Sub-nm offsets at IP cause well detectable offsets (micron scale) a few meters downstream

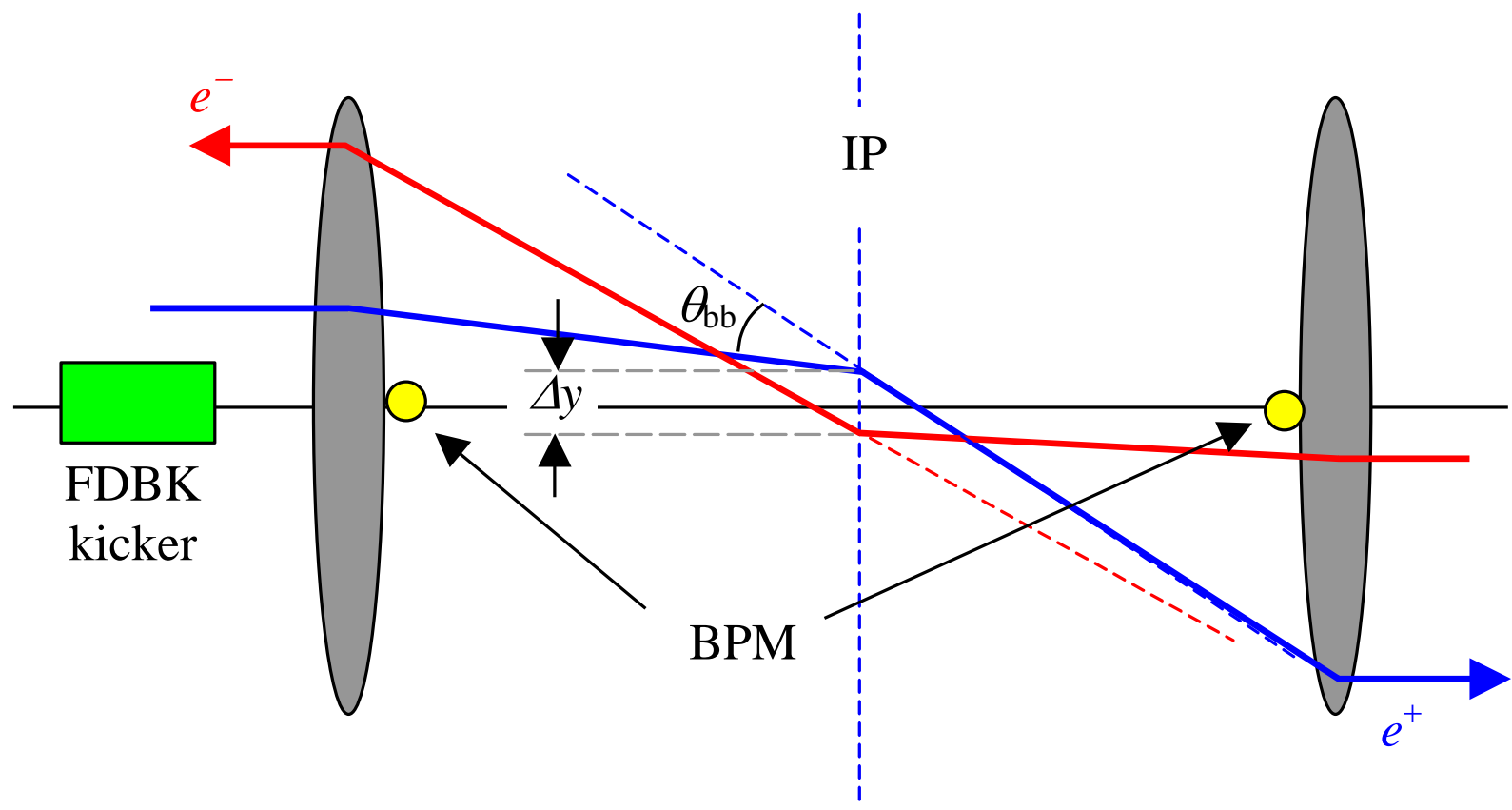

- IP feedback, orbit feedbacks can fight luminosity loss by ground motion

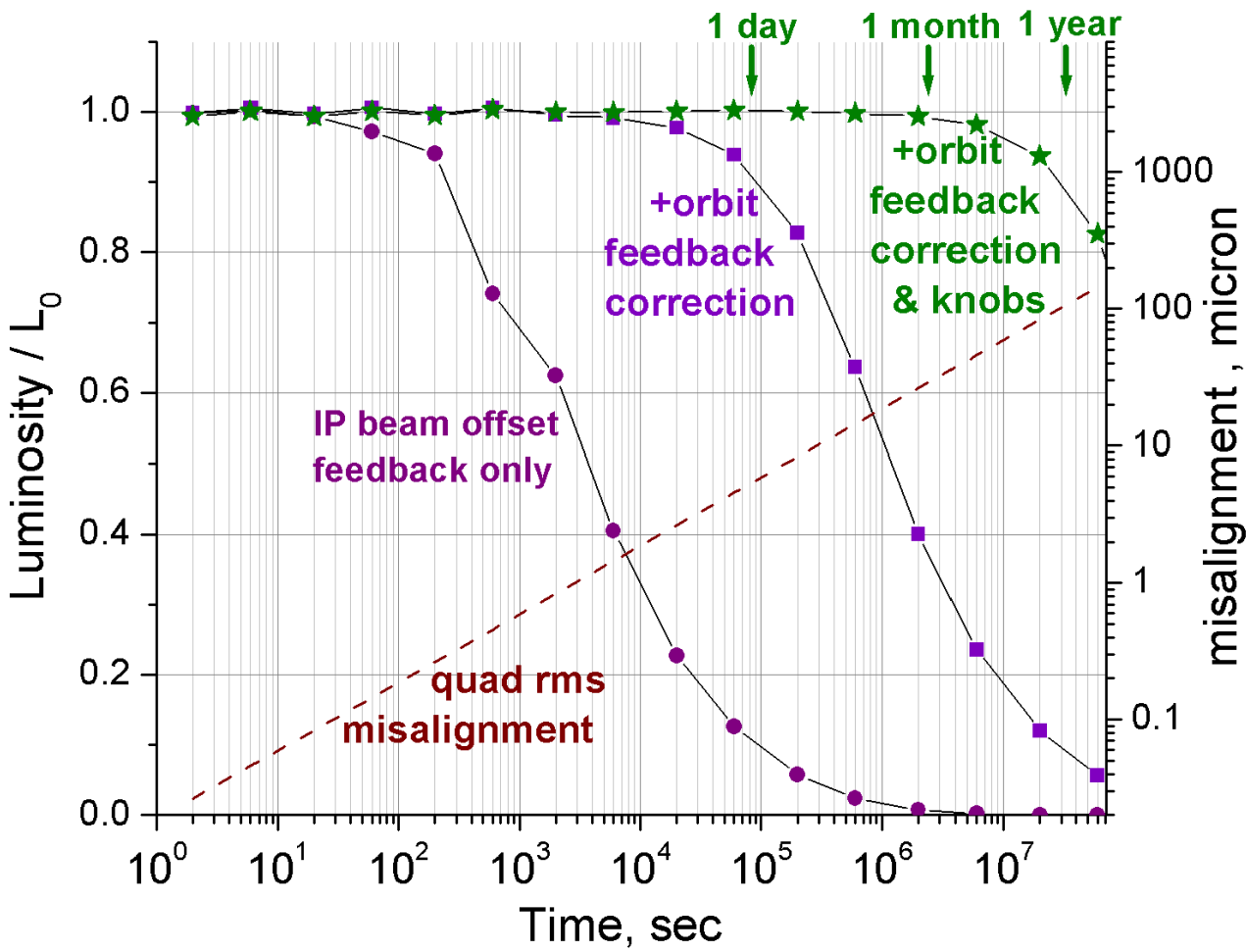

- Collimation:

- Beam halo will create background in detector
- Collimation section to eliminate off-energy and off-orbit particle
- Material and wakefield issues

- Crossing angle:

- NC small bunch spacing requires crossing angle at IP to avoid parasitic beam-beam deflections
- Luminosity loss ($\approx 10\%$ when $\langle = f_x / f_z$)

- Crab cavities

- Introduce additional time dependent transverse kick to improve collision

- Spent beam

- Large energy spread after collision
- Design for spent beam line not easy

R.B. Appleby, A. Ferrari, M.D. Salt and V. Ziemann, Phys. Rev. ST Accel. Beams 12 (2009) 021001.

Baseline: vertical chicane with 2x4 dipoles

1. Separation by dipole magnets of the disrupted beam, beamstrahlung photons and particles with opposite sign from coherent pairs, from low energy tails
 - Short line to prevent the transverse beam size from growing too much
 - Intermediate dumps and collimator systems
2. Back-bending region with dipoles to direct the beam onto the final dump
 - Long line allowing non-colliding beam to grow to acceptable size

