

CORPUSCULAR OPTICS

Jean-Marie De Conto

Université Grenoble-Alpes

Laboratoire de Physique Subatomique et de Cosmologie

deconto@lpsc.in2p3.fr

Scope

- Beam transport in long, \sim periodic machines (linacs, storage rings...) \rightarrow general beam dynamics, beta functions etc \rightarrow not here
- Beam transport in a short line
 - Beta functions not relevant (they suppose a quasi-harmonic motion) or unuseful
 - Geometrical optics is needed (ex: spectrometers)
- Programme
 - General matricial optics for accelerators
 - Description/matrix for standard focusing elements
 - Beam description (emittance) and transport
 - Basic properties (achromatic systems, spectrometers)
 - Exercises

Lorentz force

- General case
- Non relativistic case only
- Remark: If no acceleration, you can often do as for non-relativistic case with (see later)
- Electric field: focusing, bending and energy change (“ acceleration”)
- Magnetic field: focusing and bending only

$$\frac{dm\vec{v}}{dt} = q(\vec{E} + \vec{v} \wedge \vec{B})$$

$$\vec{F} = q(\vec{E} + \vec{v} \wedge \vec{B})$$

$$m = \gamma \cdot m_0$$

$$\beta = v/c$$

$$\gamma = \frac{1}{\sqrt{1 - \beta^2}}$$

Magnetic rigidity

- T is the kinetic energy in electronvolts
- n is the number of charge
- e is the elementary charge
- We consider the energy at rest V_0 and compute the Lorentz factors
- We get the radius of curvature in a magnetic field B

$$m_0 c^2 = eV_0$$

$$E = \gamma m_0 c^2 = \gamma eV_0 = eT + m_0 c^2$$

$$\Rightarrow \gamma = \frac{T + V_0}{V_0}$$

$$\Rightarrow \beta = \sqrt{1 - 1/\gamma^2}$$

$$B\rho = \frac{mv}{q} = \frac{\gamma m_0 \beta c}{ne} = \frac{\gamma \beta V_0}{nc}$$

General frame – Gauss conditions

- Coordinates relative to a reference particle

$$x' = \frac{dx}{ds} = \frac{p_x}{p_s} \quad y' = \frac{dy}{ds} = \frac{p_y}{p_s}$$

- Gauss conditions $\rightarrow x, x', y, y'$ small
 - First order calculations
 - Linéarities
 - Non linearities = high order terms
- Phase space $(x, x', y, y', \Delta L, \Delta p/p_0)$
- Set of canonical conjugate coordinates

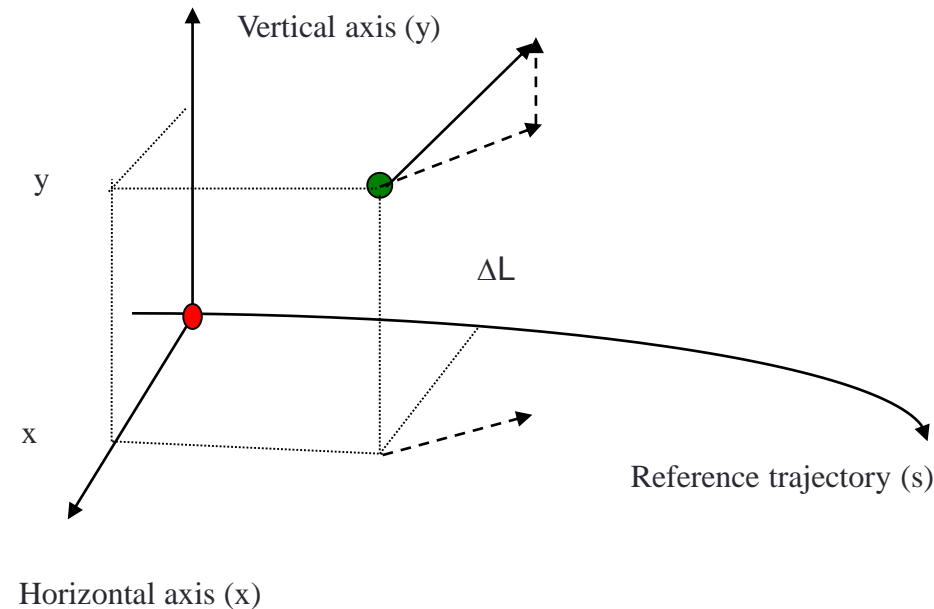

Please:

$$\frac{\Delta p}{p} \neq \frac{\Delta E}{E}$$

$$\frac{\Delta p}{p} \neq \frac{1}{2} \cdot \frac{\Delta E}{E}$$

We will work mainly with transverse coordinates

Equation of motion (illustration: one plane, non relativistic motion)

- Time → space transform

$$\dot{x} = \frac{dx}{ds} \frac{ds}{dt} = vx' \Rightarrow x' = \frac{\dot{x}}{v}$$

$$\frac{dx'}{dt} = \frac{dx'}{ds} \frac{ds}{dt} = vx'' = -\frac{1}{v^2} \frac{dv}{dt} \dot{x} + \frac{1}{v} x'' = -\frac{1}{v} \frac{dv}{dt} x' + \frac{1}{v} \ddot{x}$$

$$\frac{dv}{dt} = \frac{dv}{ds} \frac{ds}{dt} = v \frac{dv}{ds}$$

- « acceleration »

$$vx'' = -\frac{dv}{ds} x' + \frac{1}{v} \ddot{x}$$

$$\ddot{x} = v^2 x'' + vv'x'$$



$$x'' = \frac{\ddot{x}}{v^2} - \frac{v'}{v} x'$$

We suppose $v_s \sim v$

With a magnetic force (illustration, again)

- More generally:

$$x'' = \frac{\ddot{x}}{v^2} - \frac{v'}{v} x' \Rightarrow x'' = \frac{\ddot{x}}{v^2} - \frac{p'}{p} x' = \frac{\text{force}}{\gamma m_0 v^2} - \frac{p'}{p} x'$$

- The « force term » $\frac{\ddot{x}}{v^2}$ is linearized, for example:

$$x'' + \frac{p'}{p} x' = F(x) \Rightarrow x'' + \frac{p'}{p} x' \approx k(s)x$$

- The equation of motion is always the same

- Damping term related to acceleration
- The force term
- Calculation rather easy
- Relativistic equation

$$x'' + \frac{p'}{p} x' + k(s)x = \frac{1}{\rho_0 p_0} \Delta p$$

Keywords: damping, focussing, dispersion

General 2D solution

$$x'' + \frac{p'}{p} x' + k(s)x = \frac{1}{\rho_0} \frac{\Delta p}{p_0}$$

$$x'' + \frac{p'}{p} x' + k(s)x = 0$$



$$\begin{aligned} x(s) &= x_0 \cdot C(s) + x'_0 \cdot S(s) \\ x'(s) &= x_0 \cdot C'(s) + x'_0 \cdot S'(s) \end{aligned}$$

With $C(0)=1$, $C'(0)=0$, $S(0)=0$, $S'(0)=1$

$$X(s) = \begin{bmatrix} x(s) \\ x'(s) \end{bmatrix} = \begin{bmatrix} C(s) & S(s) \\ C'(s) & S'(s) \end{bmatrix} \cdot X_0$$

$$X(s) = M_{s \leftarrow 0} \cdot X_0$$



$$x'' + \frac{p'}{p} x' + k(s)x = \frac{1}{\rho_0} \frac{\Delta p}{p_0}$$

$$x(s) = x_0 \cdot C(s) + x'_0 \cdot S(s) + \frac{\Delta p}{\rho_0} \cdot D(s)$$

General conclusion

- We suppose the equation of motion to be linearized with a good enough approximation

- So, the general (first order) solution in 6D phase space is

$$X(s) = M_{s \leftarrow 0} \cdot X_0$$

M is the transfer (transport matrix) for abscissa 0 to abscissa s

- Transport to higher orders is much more complicated
- Composition: $M_{3 \leftarrow 1} = M_{3 \leftarrow 2} \cdot M_{2 \leftarrow 1}$
- We will often work in lower dimensions (2 or 4)
- Particular case: horizontal motion with magnetic dispersion

$$x(s) = x_0 \cdot C(s) + x'_0 \cdot S(s) + \frac{\Delta p}{p_0} \cdot D(s)$$

- D is the dispersion function
- Beam transport is a LEGO play: assembly on transfer matrixes
 - Calculation of elementary matrixes (lenses, drift space, bending magnet, edge focusing)
 - General properties of systems versus the properties of matrixes (point to point imaging...)
- It can be shown from hamiltonian mechanics that this is equivalent to geometrical optics (non only an analogy)

Magnetic force versus electric force

- $x''_M = \frac{qvB}{mv^2}$
- $x''_E = \frac{qE}{mv^2}$
- $\frac{x''_M}{x''_E} = \frac{B}{E} \cdot v$
- For $B=1\text{T}$ and $E=1\text{MV/m}$ $\frac{x''_M}{x''_E} = 10^{-6} \cdot v$
- Limit for $v = 10^6 \rightarrow \beta = 0.0033 \rightarrow \sim 10 \text{ keV protons}$
- Electrostatic focusing is used for low energy beams ($\sim 100 \text{ keV}$ protons –order of magnitude, please do the appropriate design-)
- $x''_E = \frac{qE}{mv^2} = \frac{qE}{2qV} = \frac{E}{2V}$: no charge separation (ex: solenoids at source exit)

GENERAL OPTICAL PROPERTIES OF MATRIXES

Goal:

- *Express a transport (optical property) in terms of matrix properties (coefficients)*
- *Choose and tune the optical elements to get these matrix properties (coefficients)*
- *Provide you the useful formulas*

Basic elements

Convention

- Distances are positive from left to right
- Focusing lengths are positive (with the appropriate sign for focussing/defocussing)

Fundamental property (2D case)

$$\det(M_{s \leftarrow 0}) = \frac{p_0}{p_s} = \Delta$$

Drift space

- $x(L) = x_0 + L \cdot x'_0$
- $x'(L) = x'_0$

- $M = \begin{bmatrix} 1 & L \\ 0 & 1 \end{bmatrix}$

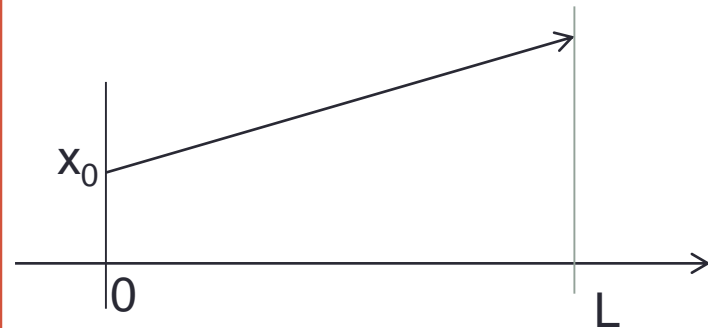

Thin lenses

Focusing thin lens

- Superposition (linear) of two elementary beams

- $x_s = x_e$

- $x'_s = x'_e - \frac{x_e}{f}$

- $M = \begin{bmatrix} 1 & 0 \\ -\frac{1}{f} & 1 \end{bmatrix}$

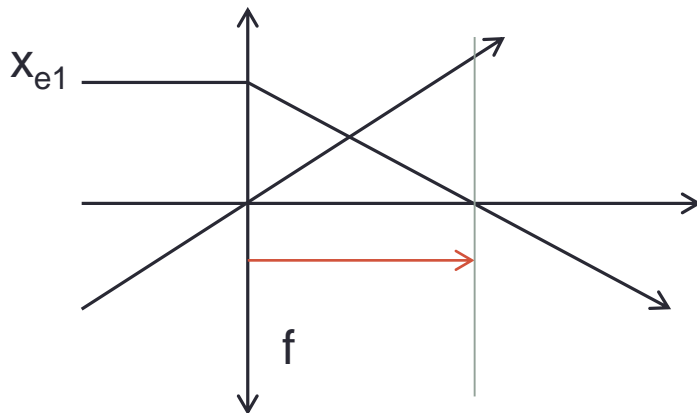

Defocusing thin lens

- $x_s = x_e$

- $x'_s = x'_e + \frac{x_e}{f}$

- $M = \begin{bmatrix} 1 & 0 \\ \frac{1}{f} & 1 \end{bmatrix}$

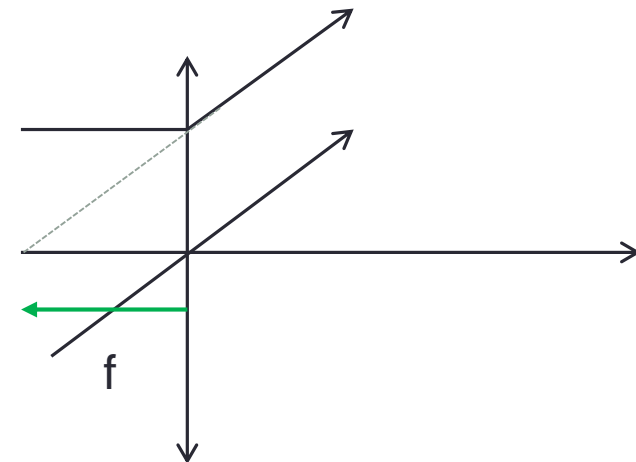

Point to point imaging

$$M_{s \leftarrow e} = \begin{bmatrix} M_{11} & 0 \\ M_{21} & M_{22} \end{bmatrix}$$

M_{11} is the magnification

$$M_{11} \cdot M_{22} = \frac{p_e}{p_s} = \Delta$$

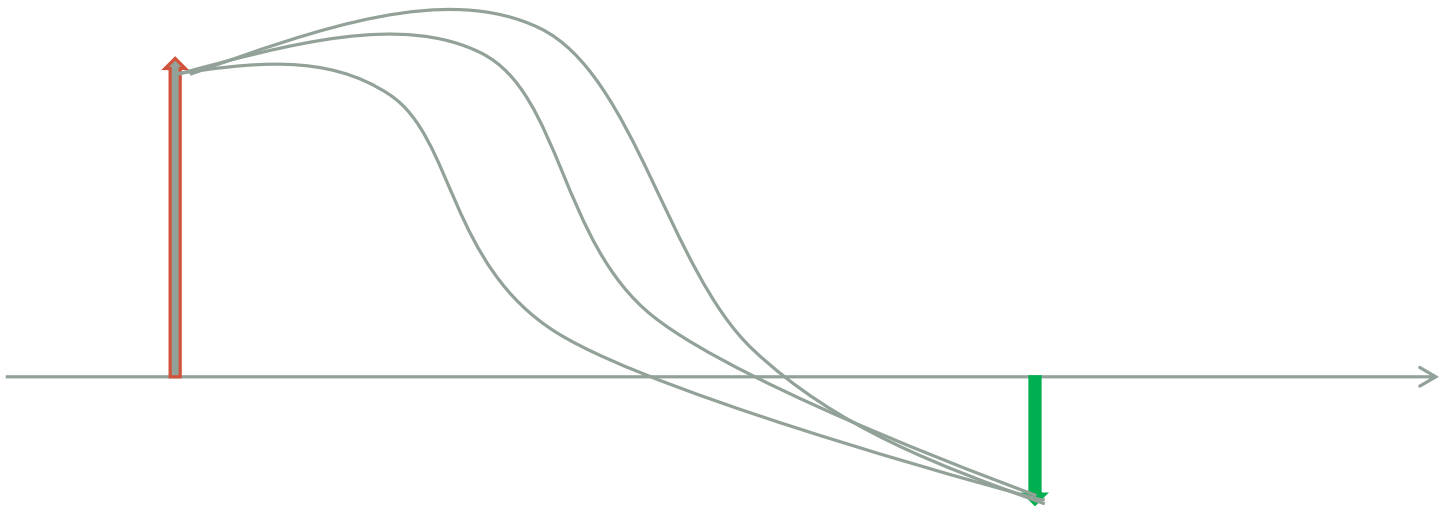

Focal points versus system edges

Object

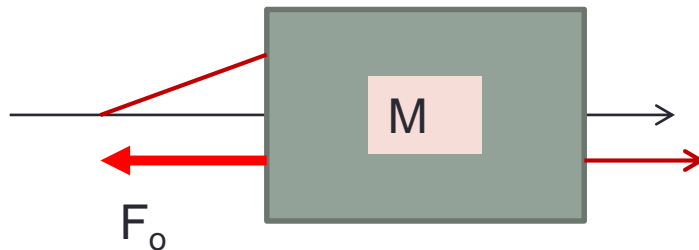

$$T = \begin{bmatrix} M_{11} & M_{12} \\ M_{21} & M_{22} \end{bmatrix} \cdot \begin{bmatrix} 1 & F_o \\ 0 & 1 \end{bmatrix}$$

$$\begin{bmatrix} x_s \\ 0 \end{bmatrix} = T \cdot \begin{bmatrix} 0 \\ x'_e \end{bmatrix}$$

$$\rightarrow (M_{21} \cdot F_o + M_{22}) = 0$$

$$\rightarrow F_o = -\frac{M_{22}}{M_{21}}$$

Positive if upstream

Image

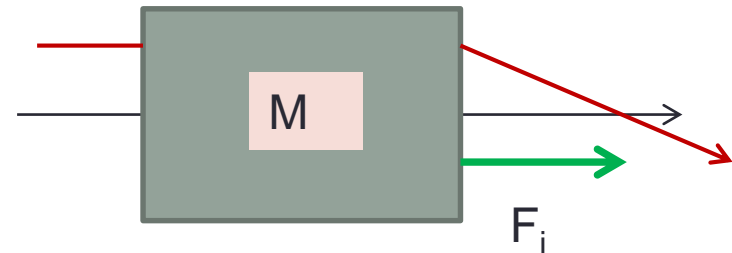

$$T = \begin{bmatrix} 1 & F_i \\ 0 & 1 \end{bmatrix} \cdot \begin{bmatrix} M_{11} & M_{12} \\ M_{21} & M_{22} \end{bmatrix}$$

$$\begin{bmatrix} 0 \\ x'_s \end{bmatrix} = T \cdot \begin{bmatrix} x_e \\ 0 \end{bmatrix}$$

$$\rightarrow (M_{21} \cdot F_i + M_{11}) = 0$$

$$\rightarrow F_i = -\frac{M_{11}}{M_{21}}$$

Positive if downstream

A useful formula: drift/matrix/drift

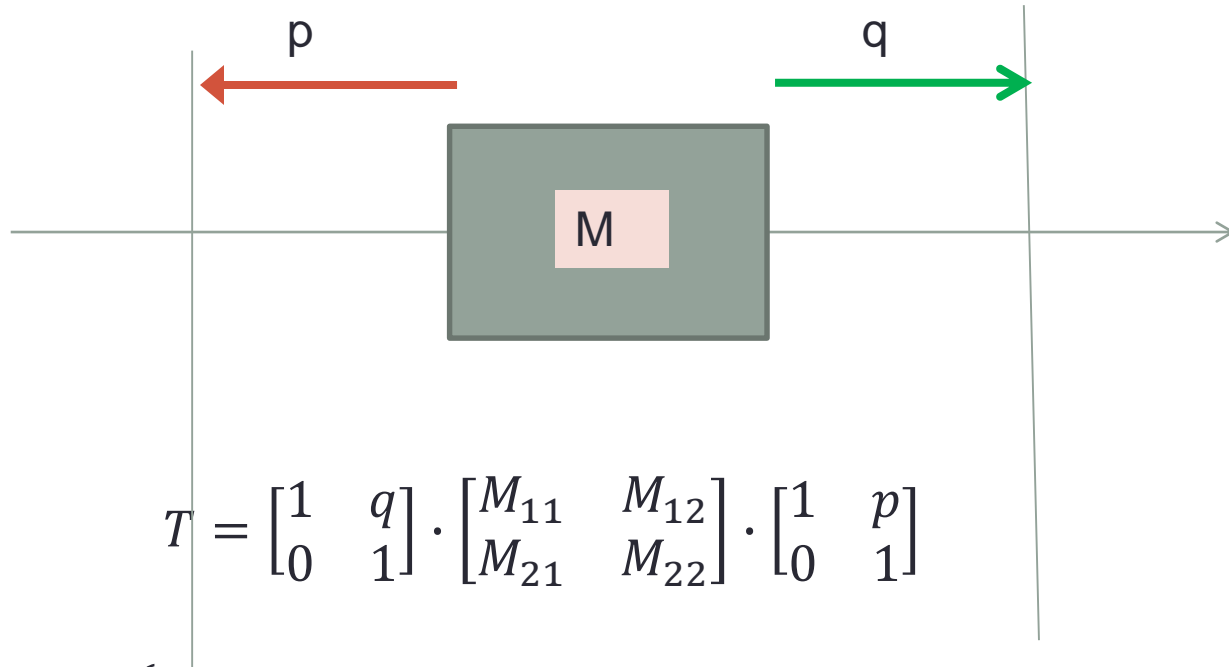

$$T = \begin{bmatrix} 1 & q \\ 0 & 1 \end{bmatrix} \cdot \begin{bmatrix} M_{11} & M_{12} \\ M_{21} & M_{22} \end{bmatrix} \cdot \begin{bmatrix} 1 & p \\ 0 & 1 \end{bmatrix}$$

$$\begin{cases} T_{11} = M_{11} + qM_{21} \\ T_{12} = pqM_{21} + pM_{11} + qM_{22} + M_{12} \\ T_{21} = M_{21} \\ T_{22} = pM_{21} + M_{22} \end{cases}$$

p positive if upstream, q positive if downstream (ie: if there are physical drift spaces)

Principal planes

- Position of the 2 planes H_1 and H_2 with
 - Point to point imaging from H_1 to H_2
 - Magnification equal to 1
- any incoming beam exits with the same position ($x_s = x_e$)

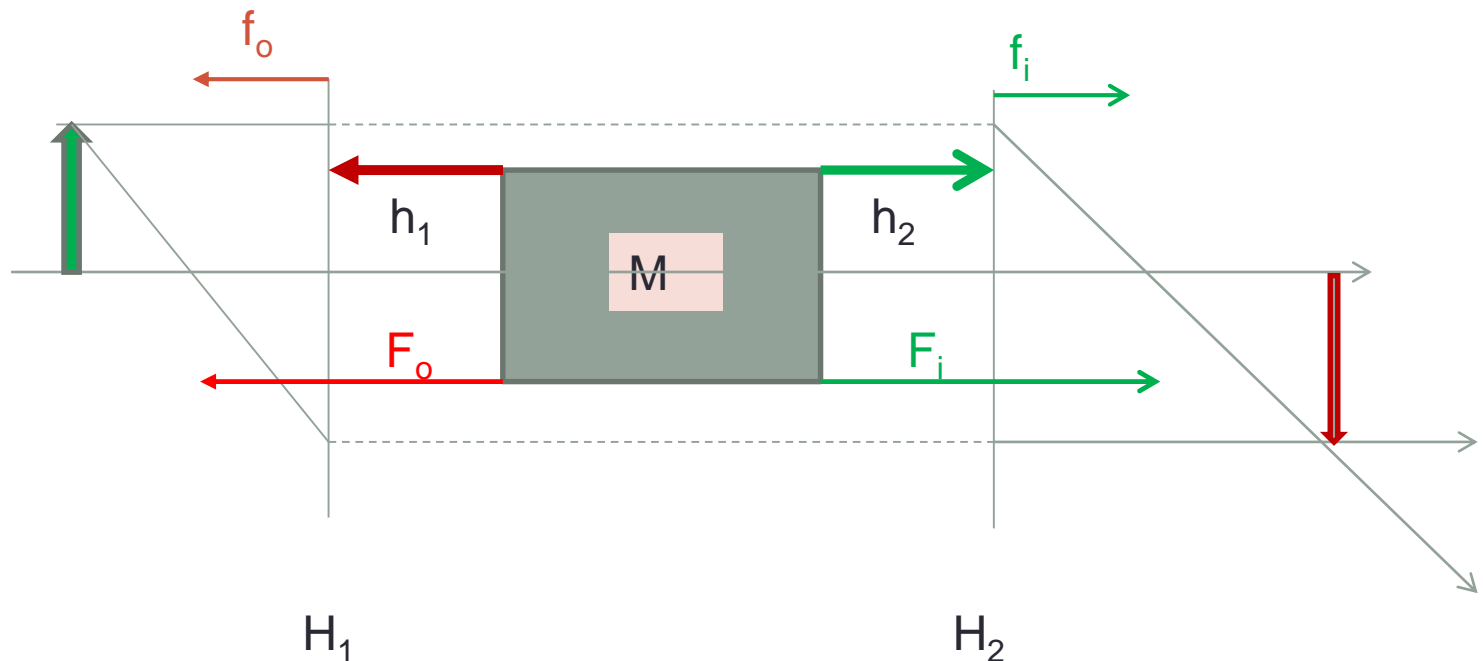

Position

$$\bullet \begin{cases} T_{11} = M_{11} + h_2 M_{21} = 1 \\ T_{12} = h_1 \cdot h_2 M_{21} + h_1 \cdot M_{11} + h_2 \cdot M_{22} + M_{12} = 0 \end{cases}$$

$$\bullet h_2 = \frac{1 - M_{11}}{M_{21}}$$

$$\bullet h_1 = \frac{\Delta - M_{22}}{M_{21}}$$

Warning: h_1 is positive upstream, h_2 is positive downstream

Foci vs principal planes

- We consider the T matrix instead of the M matrix

$$\bullet f_o = -\frac{T_{22}}{T_{21}} = -\frac{h_1 \cdot M_{21} + M_{22}}{M_{21}} = -\frac{\Delta}{M_{21}}$$

$$\bullet f_i = -\frac{T_{11}}{T_{21}} = -\frac{h_2 \cdot M_{21} + M_{11}}{M_{21}} = -\frac{1}{M_{21}}$$

$$\frac{f_o}{f_i} = \Delta$$

Use

- This description is useful when using non sharp edge elements like electrostatic lenses and to construct easily trajectories.
- It tells you “where” and “how” the system is. Ex H1 and H2 at the same location ↔ thin lens
- A tracking code provides the transfer matrix M between given planes (far enough in a low field region).
- The values of F_o and F_i depend on the choice of the plane: not constant not a real lens characteristic
- The position of H_o and H_i , the values of f_o and f_i are constant
- The focal lengths given by codes are f_o and f_i

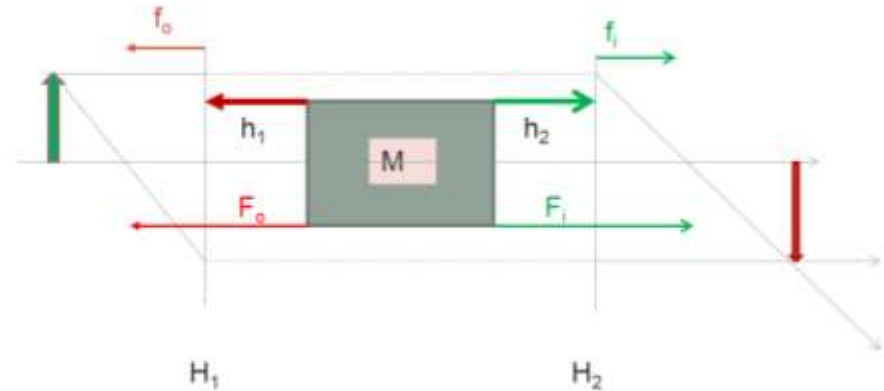

$$\frac{f_o}{f_i} = \Delta$$

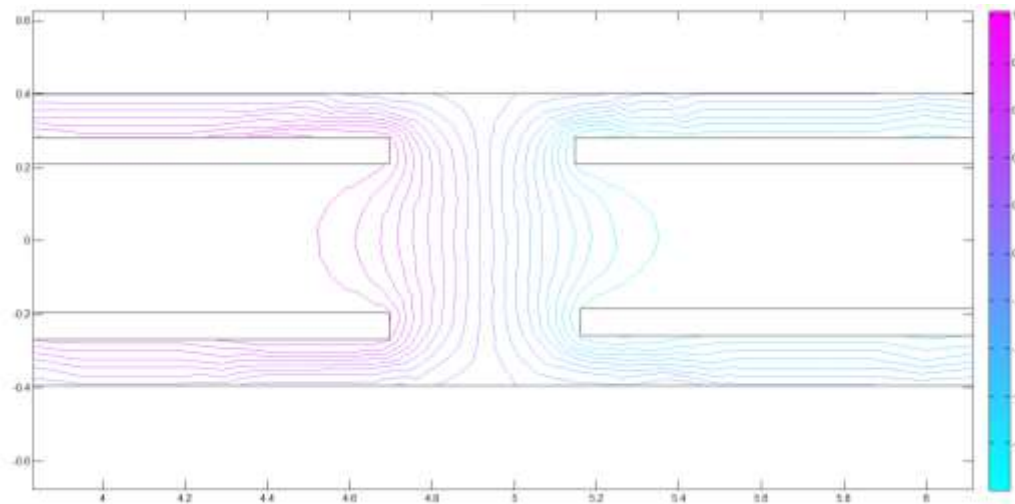

Symmetric system

- Backward motion is obtained by changing $x' \rightarrow -x'$

$$J = \begin{bmatrix} 1 & 0 \\ 0 & -1 \end{bmatrix} = J^{-1}$$

$$J \cdot X_m = M_1 \cdot J \cdot X_s = M_1 \cdot J \cdot M_2 \cdot X_m$$

$$M_2 = J \cdot M_1^{-1} \cdot J$$

$$T = J \cdot M_1^{-1} \cdot J \cdot M_1$$

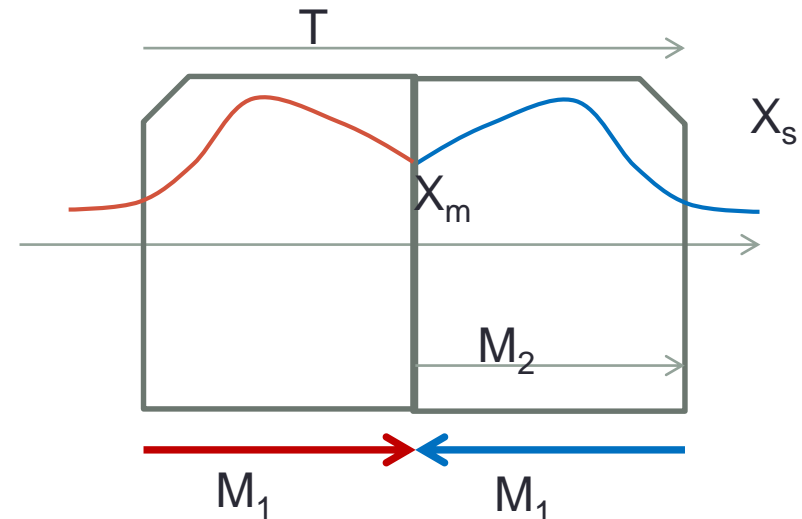

Warning: structure is symmetric, trajectory may be

$$\bullet T = \frac{1}{\det(M_1)} \begin{bmatrix} M_{11}M_{22} + M_{12}M_{21} & 2M_{22}M_{12} \\ 2M_{11}M_{21} & M_{11}M_{22} + M_{12}M_{21} \end{bmatrix}$$

Two last properties

- General expression of the transfer matrix

$$M = \frac{1}{f_i} \cdot \begin{bmatrix} F_i & f_i \cdot f_o - F_i \cdot F_o \\ -1 & F_o \end{bmatrix}$$

- **Point to point imaging for any system:** an objet is at a distance p from an optical system. Where is the image?

$$T_{12} = pqM_{21} + pM_{11} + qM_{22} + M_{12} = 0$$

$$\rightarrow (p - F_o) \cdot (q - F_i) = f_i \cdot f_o$$

$$\text{Classical thin lens } \frac{1}{p} + \frac{1}{q} = \frac{1}{f}$$

FOCUSING ELEMENTS

Electrostatic lenses

Electrostatic quadrupole

Magnetic quadrupole

Solenoid

Electrostatic lenses

- Can be flat, round (cylindrical)...
- Can be accelerating or decelerating
- Always focusing

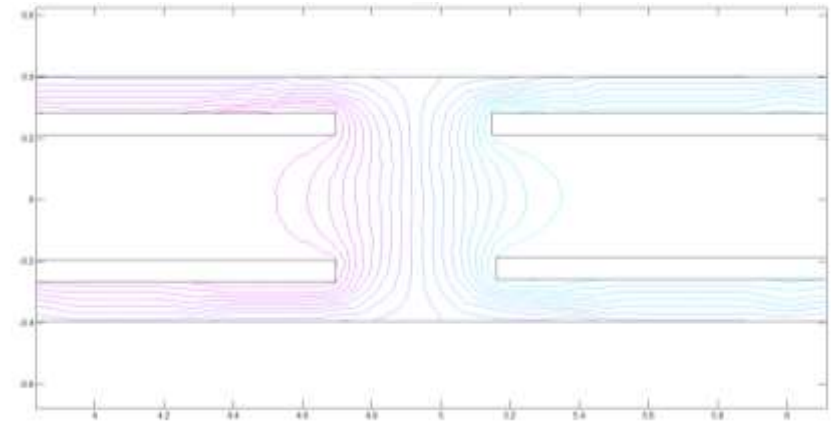

V1

V2

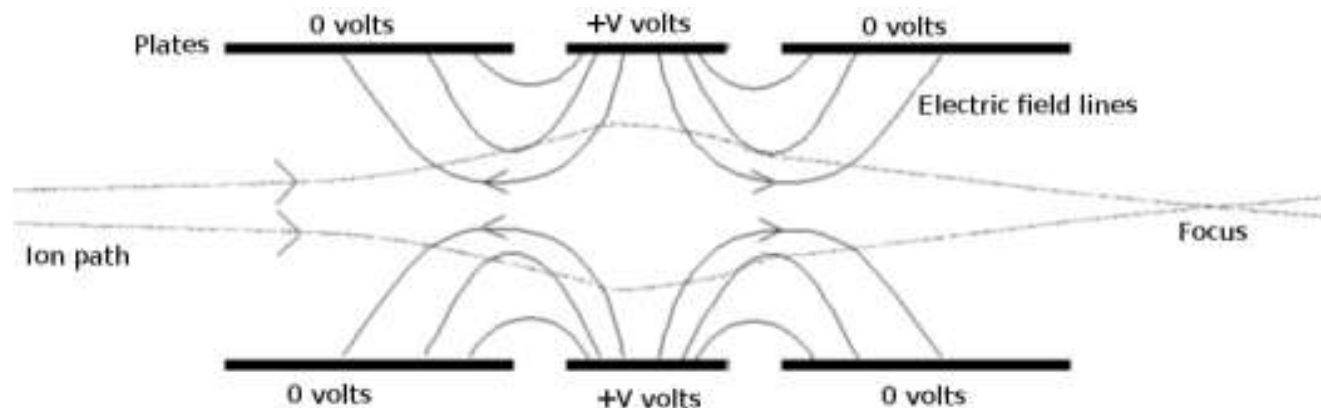
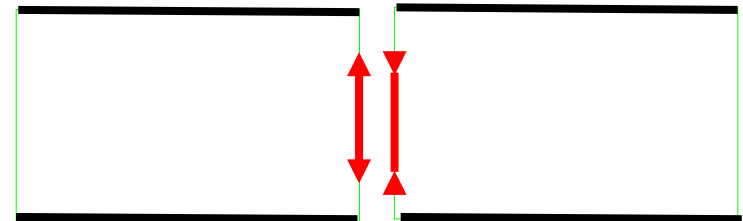

Equation of motion (non relativistic)

- Example on a cylindrical lens

- Poisson
- $A_0(s)$ = potential on axis
- Paraxial equation of motion

$$\Delta V = \frac{\partial^2 V}{\partial s^2} + \frac{1}{r} \cdot \frac{\partial}{\partial r} \cdot \left(r \cdot \frac{\partial V}{\partial r} \right) = 0$$

$$V(r, s) = \sum_{n=0}^{+\infty} A_n(s) \cdot r^{2n}$$

- Same equation for another lens

$$V(r, s) = A_0(s) - \frac{A''_0}{2^2} r^2 + \sum_{n=2}^{+\infty} (-1)^n \frac{A_0^{(2n)}}{(2n!)^2} r^{2n}$$

- In practise:

- No formula for transfer matrix
- Tables with principal planes and associated focal lengths
- Computer codes. Be careful with the numbers (meaning of the focal lengths, again)

$$r'' + \frac{A'_0}{2A_0} r' + \frac{A''_0}{4A_0} r = 0$$

$V=0$ **MUST** be for $v=0$

Electrostatic quadrupole: useful for non relativistic particles

- $\vec{F} = \begin{bmatrix} m\ddot{x} \\ m\ddot{y} \end{bmatrix} = -2q \frac{\Delta V}{R_0^2} \cdot \begin{bmatrix} x \\ -y \end{bmatrix}$
- $x'' = -2q \frac{\Delta V}{R_0^2 \cdot mv^2} x \equiv -K^2 \cdot x$ (case of x-focusing)
- $y'' = K^2 \cdot y$
- $x = x_0 \cdot \cos(KL) + x'_0 \cdot \frac{1}{K} \cdot \sin(KL)$
- $y = y_0 \cdot \operatorname{ch}(KL) + x'_0 \cdot \frac{1}{K} \cdot \operatorname{sh}(KL)$

Electrodes at $\pm\Delta V$

$$V(x, y) = \frac{\Delta V}{R_0^2} \cdot (x^2 - y^2)$$

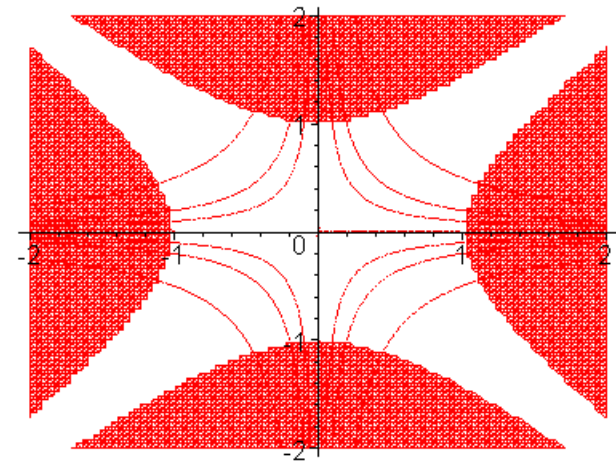

$$K^2 = \frac{\Delta V}{R_0^2 \cdot T_{ev}}$$

T_{ev} : kinetic energy in eV

$$M = \begin{bmatrix} \cos(KL) & \sin(KL)/K & 0 & 0 \\ -K\sin(KL) & \cos(KL) & 0 & 0 \\ 0 & 0 & \operatorname{ch}(KL) & \operatorname{sh}(KL)/K \\ 0 & 0 & K\operatorname{sh}(KL) & \operatorname{ch}(KL) \end{bmatrix}$$

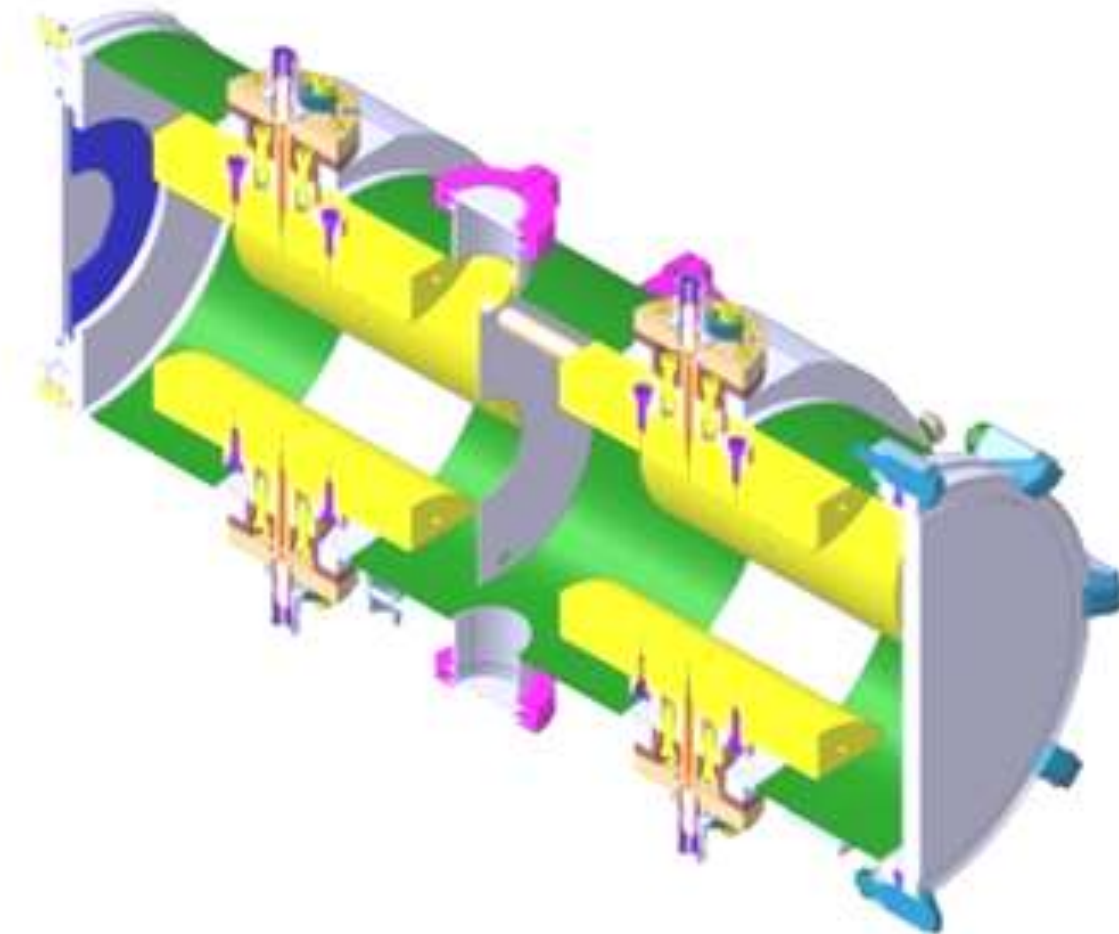

- Inside the vacuum chamber
- No power losses
- Insulators must be protected (collimators)

Magnetic quadrupoles

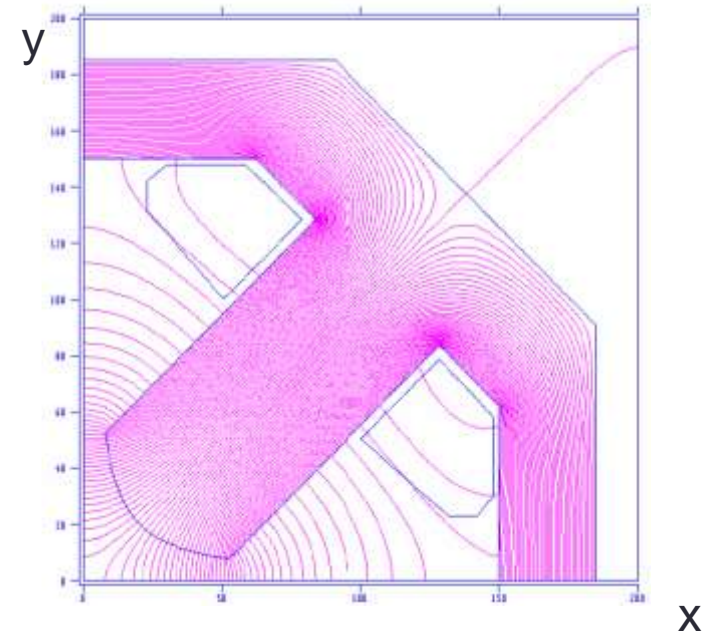
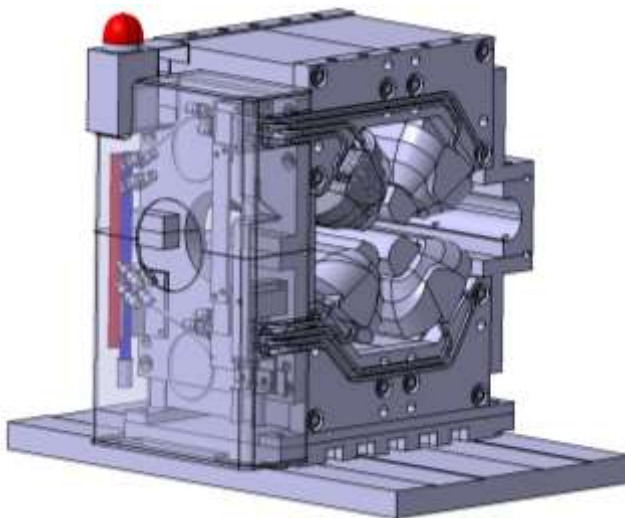
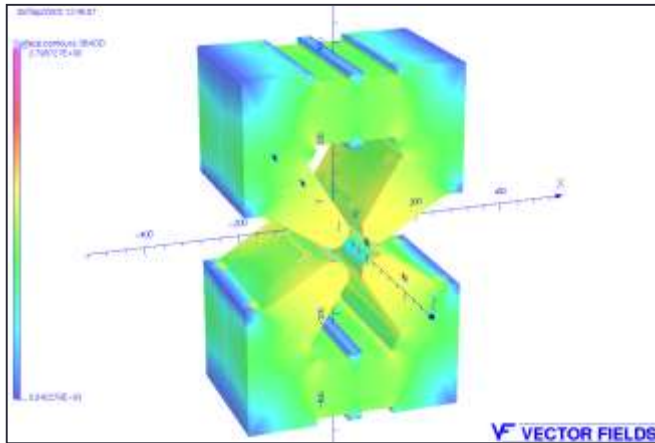

SOLEIL quadrupoles
Courtesy Bernard Launé

Magnetic quadrupole

- Scalar potential: $\phi = gxy$
- Field: $\vec{B} = \text{grad}\phi = \begin{bmatrix} gy \\ gx \end{bmatrix}$
- $g = B_0/R_0$
- Velocity: longitudinal
- $\vec{F} = q\vec{v} \wedge \vec{B}$
- $x'' = -\frac{qvgx}{mv^2} = -\frac{g}{(B\rho)}x$
- $x'' = -K^2x$
- $y'' = K^2y$

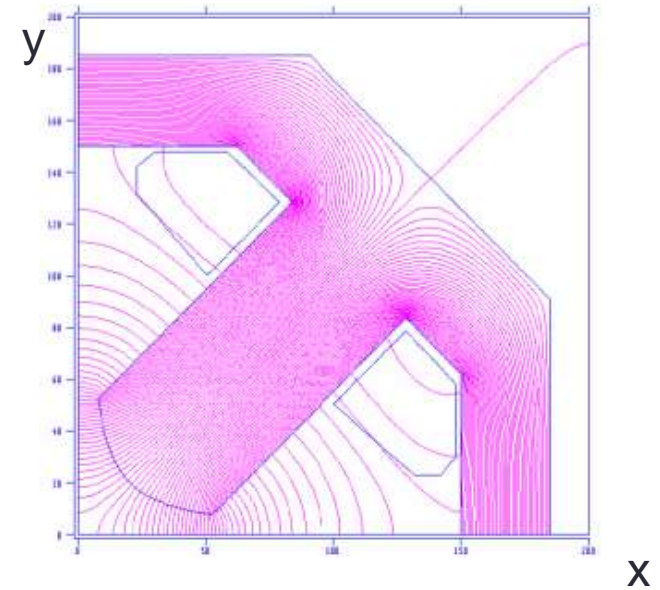

$$K^2 = \frac{g}{(B\rho)}$$

$$M = \begin{bmatrix} \cos(KL) & \sin(KL)/K & 0 & 0 \\ -K\sin(KL) & \cos(KL) & 0 & 0 \\ 0 & 0 & \text{ch}(KL) & \text{sh}(KL)/K \\ 0 & 0 & K\text{sh}(KL) & \text{ch}(KL) \end{bmatrix}$$

Optical properties of quadrupoles

- Principal planes (ex foc plane):
- $h_1 = h_2 = \frac{1-M_{11}}{M_{21}} = \frac{1-\cos(KL)}{-K\sin(KL)} \sim -\frac{K^2L^2}{2K^2L} = -\frac{L}{2}$
- A quadrupole is equivalent (up to the validity of the approximation before) to a thin lens surrounded by two drift spaces of half-length
- The focal length of the lens is given by:
- $\frac{1}{f} = K^2L$ ie $\frac{2\Delta V \cdot L}{v(B\rho)R_0^2} \sim \frac{\Delta V \cdot L}{TR_0^2}$ (electrostatic, then non relativistic)
and $\frac{gL}{(B\rho)} = \frac{B_0L}{R_0(B\rho)}$ (magnetic)
- A quadrupole is not stigmatic: $|M_{21}| \neq |M_{34}|$

Doublet and triplet of identical quads

- Doublet: FOD (focusing, drift, defocusing)

$$M = \begin{bmatrix} 1 - L/f & L \\ -L/f^2 & 1 + L/f \end{bmatrix}$$

$$h_1 = -f \quad \text{and} \quad h_2 = f$$

- A doublet is always convergent but never equivalent to a thin lens
- Symmetric triplet with identical focal lengths: FODOF

$$M = \begin{bmatrix} 1 - \frac{L}{f} - \frac{L^2}{f^2} & L\left(2 + \frac{L}{f}\right) \\ \frac{(L^2 - f^2)}{f^3} & 1 - L/f - \frac{L^2}{f^2} \end{bmatrix}$$

$$h_1 = h_2 = \frac{-L}{1-L/f} \sim -L \text{ if } f \gg L \text{ (thin lens)}$$

FODO structure

- A quadrupole focusing in one direction is defocusing in the other one
- The only way to have a stable system is to have an alternate gradient structure with identical quadrupoles : the FODO cell
- Exercise: show a FODO cell is always converging

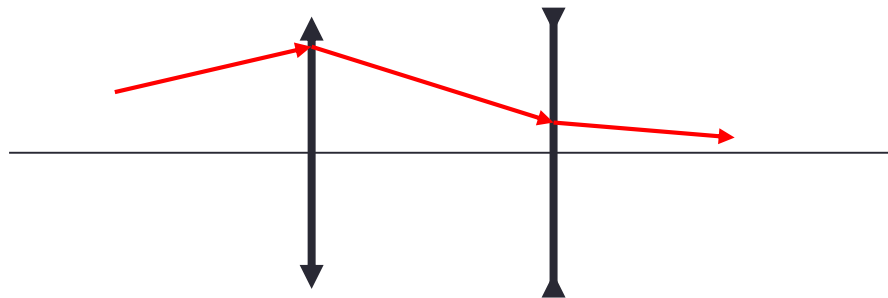

[fodo1.xls](#)

Solenoid – Glaser lenses

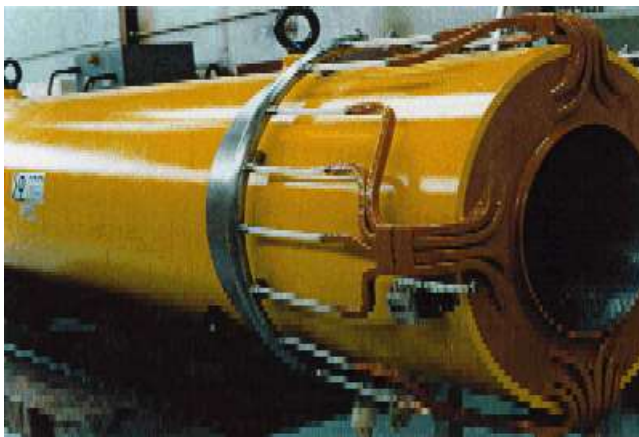
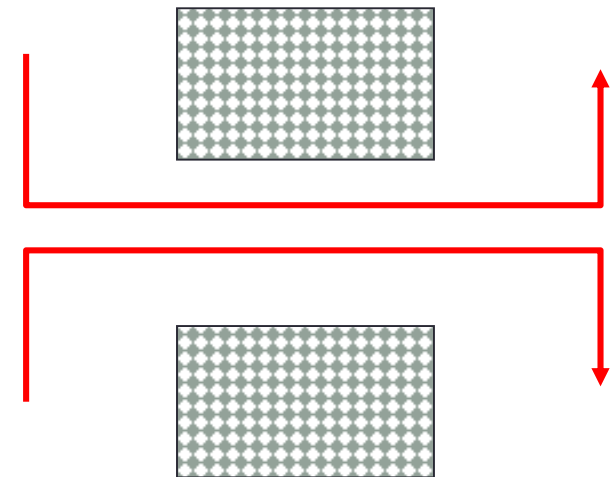
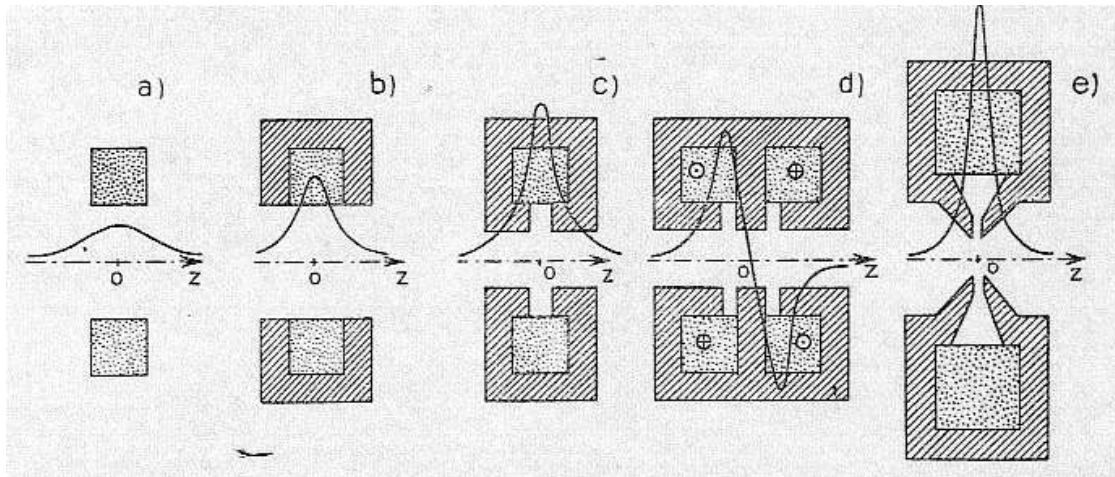

$$B_s \approx B_0 \left(1 + \frac{s^2}{a^2} \right)^{-1}$$

$$\frac{1}{f} = \frac{\pi a B_0^2}{8(B\rho)^2}$$

~equivalent to a thin lens

Transfer matrix

- Equation of radial motion
- Radial focusing+rotation.
- The transfer matrix is the product of a rotation R_{KL} and a focusing matrix N
- Coupling H/V

$$N = \begin{bmatrix} C & S/K & 0 & 0 \\ -KS & C & 0 & 0 \\ 0 & 0 & C & S/K \\ 0 & 0 & -KS & C \end{bmatrix}$$

$$r'' + \left[\frac{B_s}{2(B\rho)} \right]^2 \cdot r = 0$$

$$K = \frac{B_s}{2(B\rho)}$$

$$C = \cos(KL) \text{ and } S = \sin(KL)$$

$$M = \begin{bmatrix} C^2 & SC/K & SC & S^2/K \\ -KSC & C^2 & -KS^2 & SC \\ -SC & -S^2/K & C^2 & SC/K \\ KS^2 & -SC & -KSC & C^2 \end{bmatrix}$$

$$M = N \cdot R_{KL}$$

MAGNETS

Sector magnet

Field index

Edge focusing

Achromatic systems

Dipole magnet: beam bending and focusing

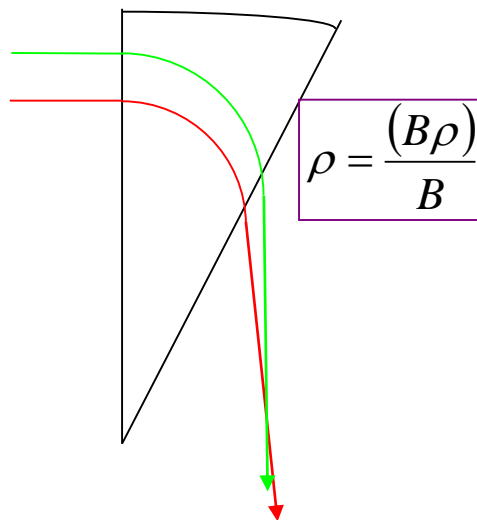

- Here: focusing in the deviation plane
- **Field index** : horizontal component out of the middle plane \rightarrow vertical focusing
- The choice of the index allows any kind of focusing
- No index: focusing in the deviation plane, drift space in the other one

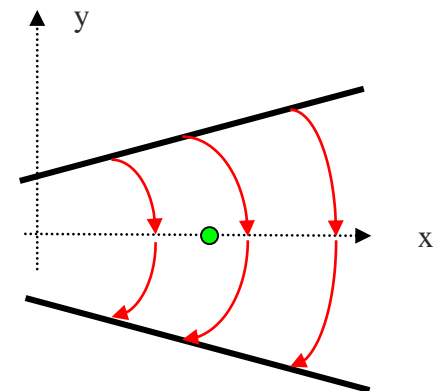

$$n = -\frac{R}{B_0} \frac{\partial B_y}{\partial x} = -\frac{R}{B_0} \frac{\partial B_x}{\partial y}$$

$$B_y \sim B_0 + \frac{\partial B_y}{\partial x} x = B_0 \cdot \left[1 - \frac{n}{R} x \right]$$

$$B_x = -B_0 \cdot \frac{n}{R} y$$

$$x'' + \frac{1-n}{R^2} x = \frac{1}{R} \frac{\Delta p}{p_0}$$

$$y'' + \frac{n}{R^2} y = 0$$

$$x'' + \frac{1-n}{R^2} x = \frac{1}{R} \frac{\Delta p}{p_0}$$

$$y'' + \frac{n}{R^2} y = 0$$

$$1 - n > 0 \text{ and } n > 0$$

$$K_x = \sqrt{\frac{1-n}{R^2}}, K_y = \sqrt{\frac{n}{R^2}}, \theta_x = K_x L, \theta_y = K_y L$$

$$C_x = \cos(\theta_x), S_x = \sin(\theta_x), C_y = \cos(\theta_y), S_y = \sin(\theta_y),$$

$$\begin{bmatrix} C_x & S_x/K_x & 0 & 0 & 0 & \frac{(1-C_x)}{RK_x^2} \\ -K_x S_x & C_x & 0 & 0 & 0 & \frac{S_x}{RK_x} \\ 0 & 0 & C_y & S_y/K_y & 0 & 0 \\ 0 & 0 & -K_y S_y & C_y & 0 & 0 \\ S_x/RK_x & -(1-C_x)/K_x^2 & 0 & 0 & 1 & -\frac{\theta_x - S_x}{R^2 K_x^3} \\ 0 & 0 & 0 & 0 & 0 & 1 \end{bmatrix}$$

$$x'' + \frac{1-n}{R^2}x = \frac{1}{R} \frac{\Delta p}{p_0}$$

$$y'' + \frac{n}{R^2}y = 0$$

$$1 - n < 0 \text{ and } n > 0$$

$$K_x = \sqrt{\frac{1-n}{R^2}}, K_y = \sqrt{\frac{n}{R^2}}, \theta_x = K_x L, \theta_y = K_y L$$

$$C_x = ch(\theta_x), S_x = sh(\theta_x), C_y = \cos(\theta_y), S_y = \sin(\theta_y),$$

$$\begin{bmatrix} C_x & S_x/K_x & 0 & 0 & 0 & -\frac{(1-C_x)}{RK_x^2} \\ K_x S_x & C_x & 0 & 0 & 0 & \frac{S_x}{RK_x} \\ 0 & 0 & C_y & S_y/K_y & 0 & 0 \\ 0 & 0 & -K_y S_y & C_y & 0 & 0 \\ S_x/RK_x & (1-C_x)/K_x^2 & 0 & 0 & 1 & \frac{\theta_x - S_x}{R^2 K_x^3} \\ 0 & 0 & 0 & 0 & 0 & 1 \end{bmatrix}$$

$$x'' + \frac{1-n}{R^2}x = \frac{1}{R} \frac{\Delta p}{p_0}$$

$$y'' + \frac{n}{R^2}y = 0$$

$$1 - n < 0 \text{ and } n < 0$$

$$K_x = \sqrt{\frac{1-n}{R^2}}, K_y = \sqrt{\frac{n}{R^2}}, \theta_x = K_x L, \theta_y = K_y L$$

$$C_x = ch(\theta_x), S_x = sh(\theta_x), C_y = ch(\theta_y), S_y = sh(\theta_y),$$

$$\begin{bmatrix} C_x & S_x/K_x & 0 & 0 & 0 & -\frac{(1-C_x)}{RK_x^2} \\ K_x S_x & C_x & 0 & 0 & 0 & \frac{S_x}{RK_x} \\ 0 & 0 & C_y & S_y/K_y & 0 & 0 \\ 0 & 0 & K_y S_y & C_y & 0 & 0 \\ S_x/RK_x & (1-C_x)/K_x^2 & 0 & 0 & 1 & \frac{\theta_x - S_x}{R^2 K_x^3} \\ 0 & 0 & 0 & 0 & 0 & 1 \end{bmatrix}$$

Edge focusing

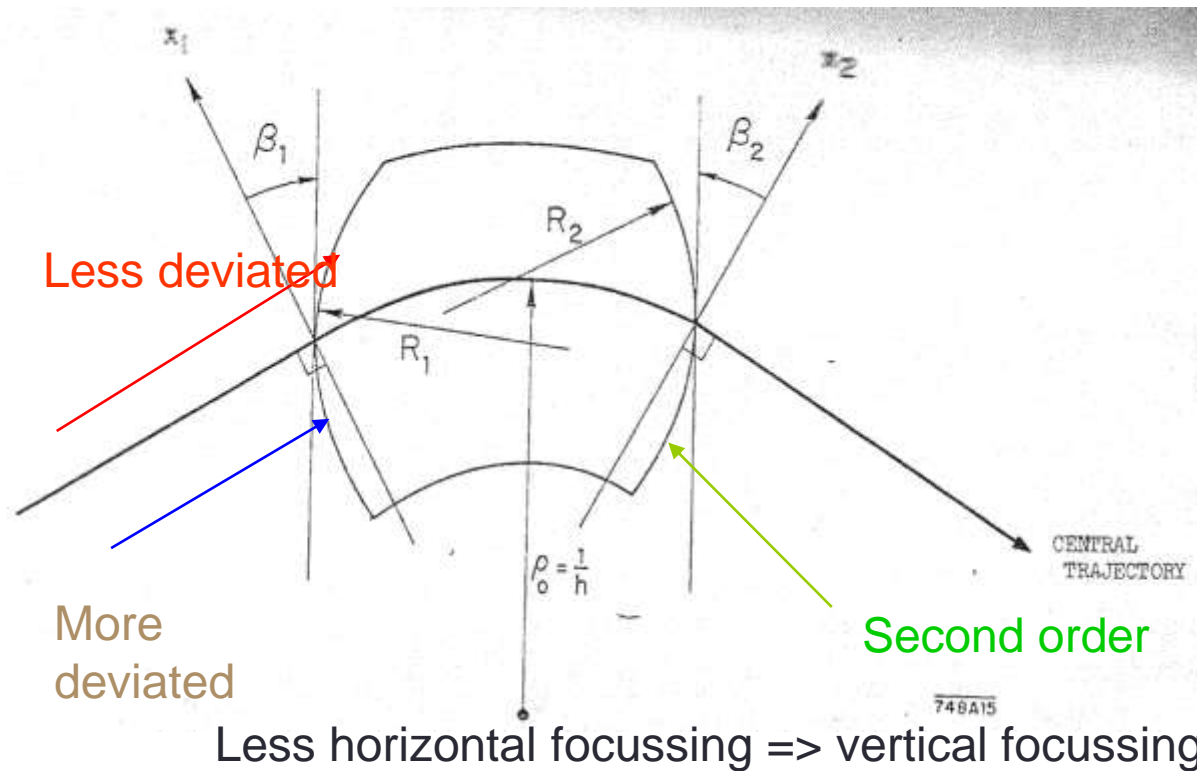

Edge focusing provides more focusing in one plane and the opposite (less focusing) in the other plane

$$\left| \frac{1}{f} \right| \approx \frac{1}{\rho} \tan \beta$$

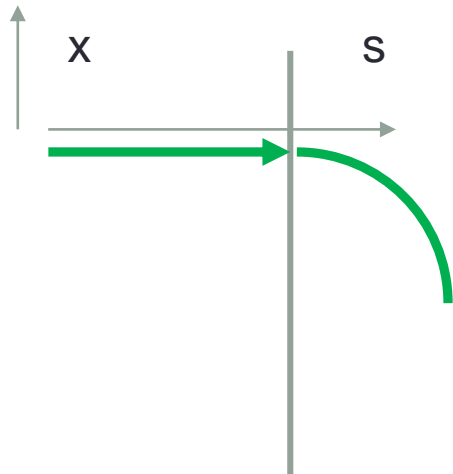

Focussing in x
No focussing in y
No edge focussing

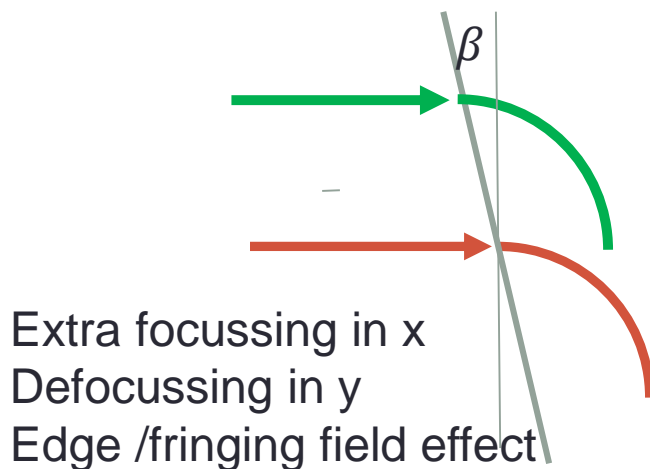
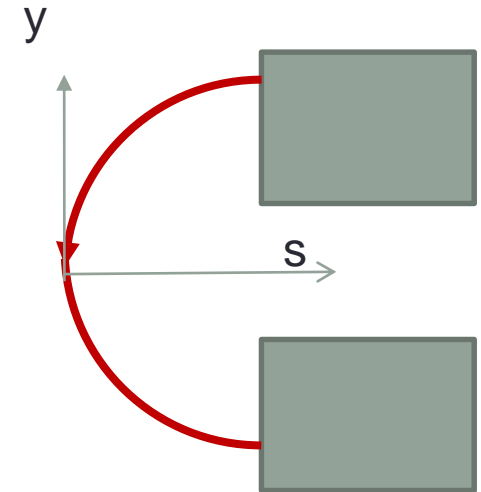
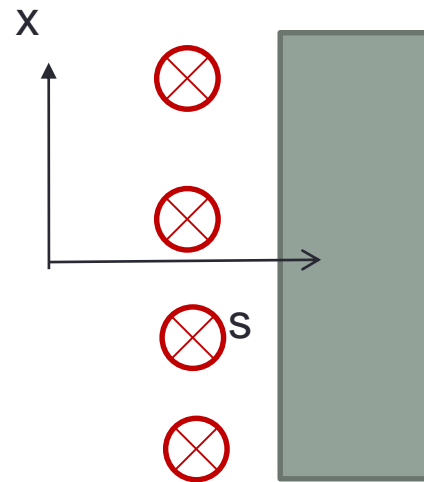

Extra focussing in x
Defocussing in y
Edge /fringing field effect

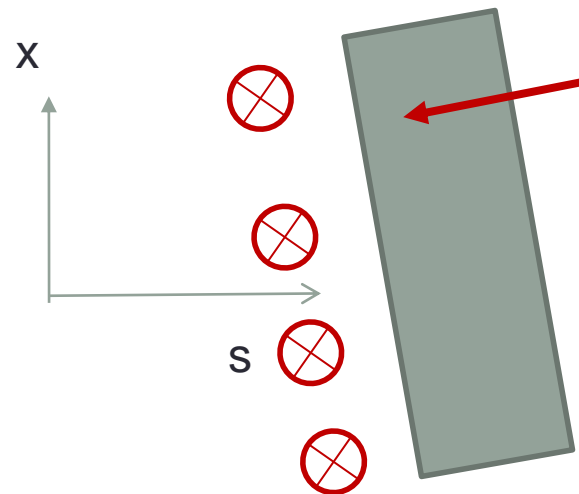

Can add/subtract focussing in x/y

Opposite effect x/y

$$\left| \frac{1}{f} \right| \approx \tan \left(\frac{\beta}{R} \right)$$

A little bit more complicated in y vs fringing field extent

remark

- If the edge angle is defocusing in the deviation plane and equal to $\frac{1}{4}$ rotation angle, the global focusing is ~identical in each plane
- If the edge angle is defocusing in the deviation plane and equal to $\frac{1}{2}$ rotation angle, there no longer focusing in the deviation plane (drift) : use of rectangular magnets

$\frac{1}{4}$ angle sur chaque face: ~même focalisation x/y

$$\begin{bmatrix} 4 \cos\left(\frac{\theta}{4}\right)^2 - 3 & r_0 \sin(\theta) & 0 & 0 \\ -\frac{2 \sin\left(\frac{\theta}{4}\right)}{\cos\left(\frac{\theta}{4}\right) r_0} & 4 \cos\left(\frac{\theta}{4}\right)^2 - 3 & 0 & 0 \\ 0 & 0 & 1 - \tan\left(\frac{\theta}{4}\right) \theta & r_0 \theta \\ 0 & 0 & \frac{\tan\left(\frac{\theta}{4}\right) \left(-2 + \tan\left(\frac{\theta}{4}\right) \theta\right)}{r_0} & 1 - \tan\left(\frac{\theta}{4}\right) \theta \end{bmatrix}$$

Angle $\frac{1}{2}$ on chaque face : espace de glissement dans le plan de déviation

$$\begin{bmatrix} 1 & r_0 \sin(\theta) & 0 & 0 \\ 0 & 1 & 0 & 0 \\ 0 & 0 & 1 - \tan\left(\frac{\theta}{2}\right) \theta & r_0 \theta \\ 0 & 0 & \frac{\tan\left(\frac{\theta}{2}\right) \left(-2 + \tan\left(\frac{\theta}{2}\right) \theta\right)}{r_0} & 1 - \tan\left(\frac{\theta}{2}\right) \theta \end{bmatrix}$$

Dispersion, achromats

- Let the system to be dispersive
- D = Dispersion function
- Separation versus momentum
- Spot size is increased

$$\sigma_x = \sqrt{\sigma_0^2 + D^2 \sigma_{\Delta p / p_0}^2}$$

$$x'' + \frac{p'}{p} x' + k(s)x = \frac{1}{\rho} \frac{\Delta p}{p_0}$$

$$\begin{cases} x(s) = C(s)x_0 + S(s)x'_0 + D(s) \frac{\Delta p}{p_0} \\ x'(s) = C'(s)x_0 + S'(s)x'_0 + D'(s) \frac{\Delta p}{p_0} \end{cases}$$

- Make $D=D'=0$
→ Achromatic system

Achromats

- Dispersive system

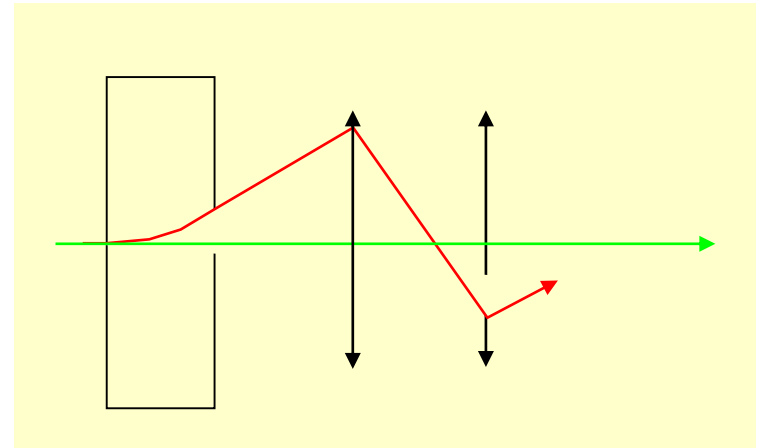

- One example

And for counterwise rotation?

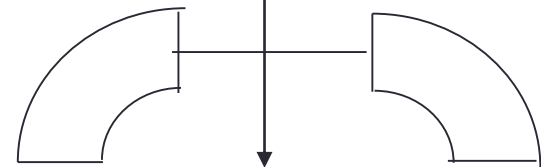
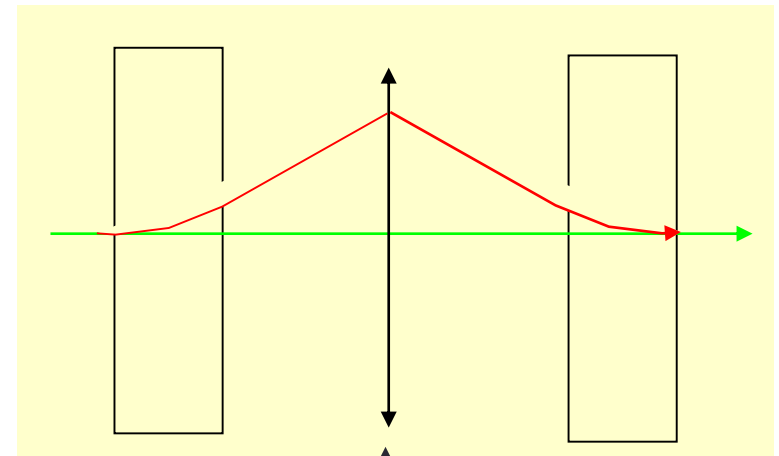

Example

$$D_{dip} = \rho(1 - \cos \theta)$$

$$D'_{dip} = \sin \theta$$

$$\Rightarrow \begin{cases} D_{in} = \rho(1 - \cos \theta) + L \sin \theta \\ D'_{in} = \sin \theta \end{cases}$$

$$\Rightarrow \begin{cases} D_{out} = D_{in} \\ D'_{out} = D'_{in} - \frac{D_{in}}{f} \equiv -D'_{in} \end{cases}$$

$$\Rightarrow f = \frac{D_{in}}{2D'_{in}} = \frac{\rho(1 - \cos \theta) + L \sin \theta}{2 \sin \theta}$$

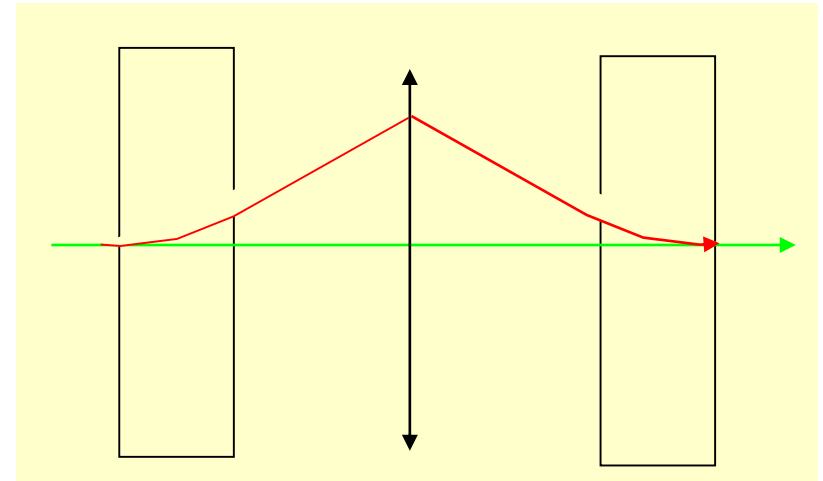

- One lens is needed
- In fact: one triplet
- Achromat+foc

The achromatic chicane

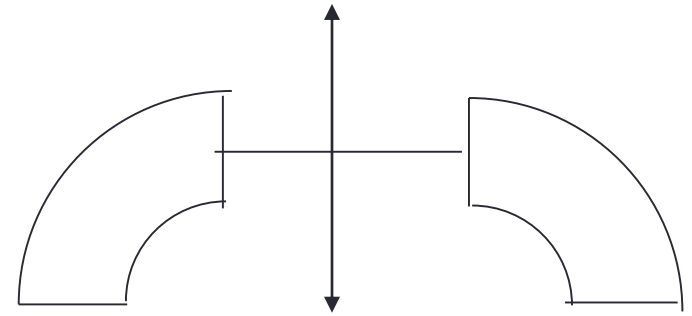
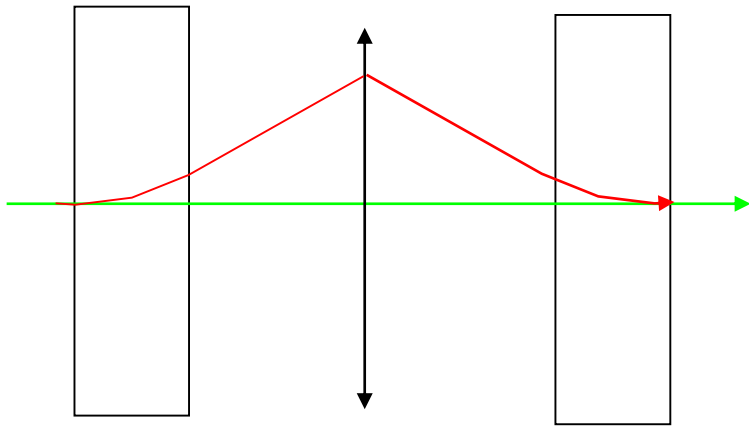

?

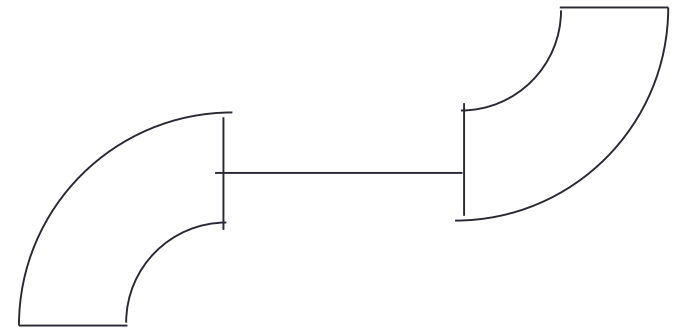

examples

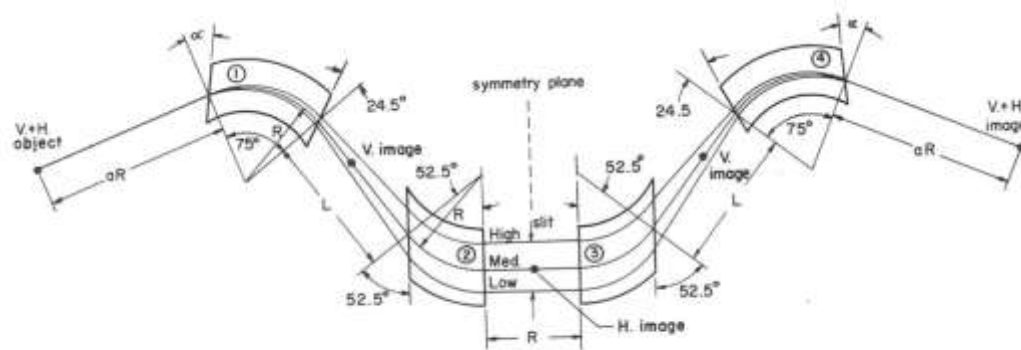
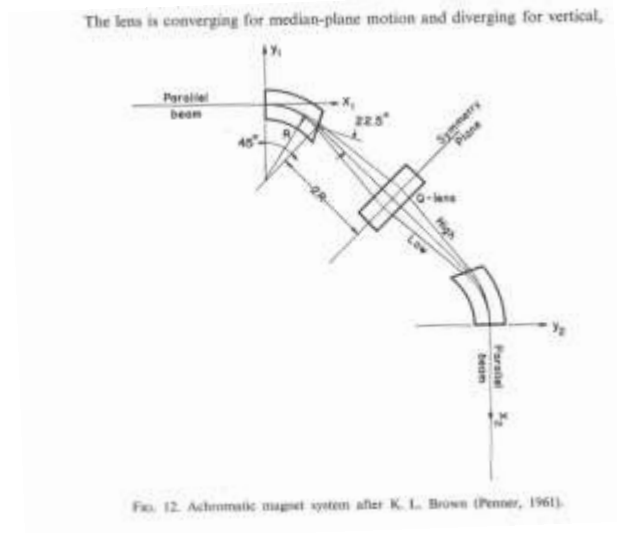
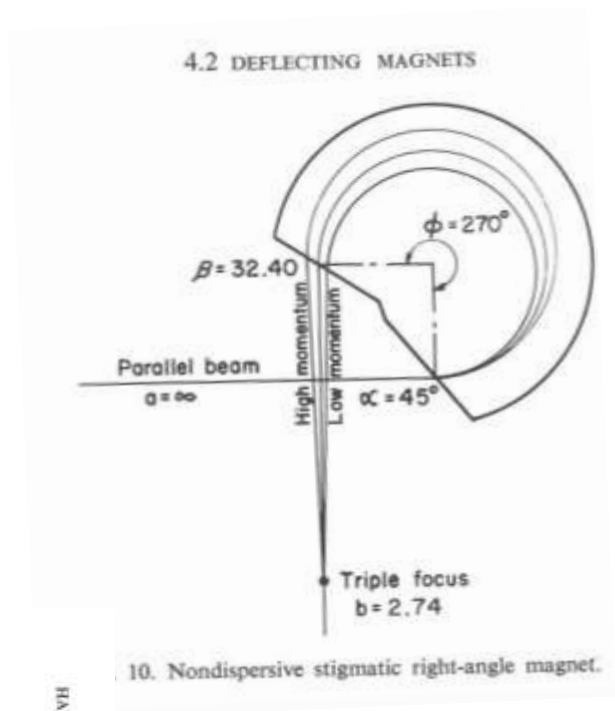

Fig. 13. Achromatic magnet system after H. A. Enge (1961).



Courtesy Bernard Launé

BEAM TRANSPORT

Beam description: emittance, RMS emittance

Emittance transport, Liouville theorem

Courant-Snyder invariant – Twiss matrix

Emittance matching

Emittance measurements(examples)

Collimators

Global description of a beam (2D case)

- Ex: trajectories of individual particles in a drift space
- Need of a global description
- Need to describe convergence, divergence, beam envelope
- Need to describe extrema beam envelope (“waist”)
- RMS description of the beam

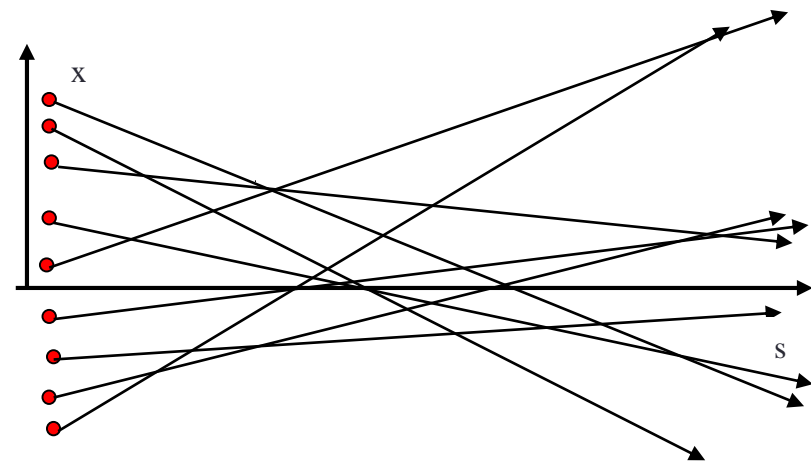
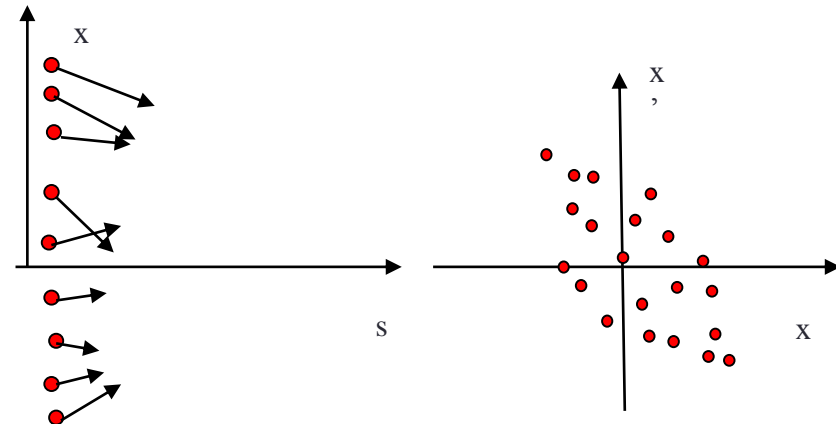

Beam matrix

- Beam matrix
 - Covariance matrix in phase space
 - Here (x, x') only
 - RMS beam extension in phase space (nD variance)

$$X = \begin{bmatrix} x \\ x' \end{bmatrix} \rightarrow \tilde{X} = [x \quad x']$$

$$X\tilde{X} = \begin{bmatrix} x^2 & xx' \\ xx' & x'^2 \end{bmatrix} \rightarrow \langle X\tilde{X} \rangle = \begin{bmatrix} \langle x^2 \rangle & \langle xx' \rangle \\ \langle xx' \rangle & \langle x'^2 \rangle \end{bmatrix} \equiv \Sigma$$

- Linear transport easy
- Transformation is a tensorial transform
 - Not a matrix but a tensor
 - Matrix: transformation
 - Tensor: property (here: RMS extent)

$$Y = MX \Rightarrow Y\tilde{Y} = MX\tilde{X}\tilde{M}$$

$$\Rightarrow \langle Y\tilde{Y} \rangle = M \langle X\tilde{X} \rangle \tilde{M}$$

$$\Rightarrow \Sigma_1 = M\Sigma_0\tilde{M}$$

Emittance (Twiss) parameters

- From the beam matrix
- Defines the ellipses including n% of the beam in an RMS (intuitive) sense.
- The ellipse corresponding to ε_{RMS} is the concentration ellipse
- Warning; RMS emittance definition changes upon authors, by a factor $\frac{1}{2}$, 2 or 4...

$$\Sigma = \begin{bmatrix} \langle x^2 \rangle & \langle xx' \rangle \\ \langle xx' \rangle & \langle x'^2 \rangle \end{bmatrix} \equiv \begin{bmatrix} \beta \varepsilon_{RMS} & -\alpha \varepsilon_{RMS} \\ -\alpha \varepsilon_{RMS} & \gamma \varepsilon_{RMS} \end{bmatrix}$$

$$\beta\gamma - \alpha^2 \equiv 1$$

$$\Rightarrow \left\{ \begin{array}{l} \varepsilon_{RMS} = \sqrt{\det(\Sigma)} = \sqrt{\langle x^2 \rangle \langle x'^2 \rangle - (\langle xx' \rangle)^2} \\ \beta = \frac{\langle x^2 \rangle}{\varepsilon_{RMS}} \\ \alpha = -\frac{\langle xx' \rangle}{\varepsilon_{RMS}} \end{array} \right.$$

Not to be confused with Lorentz factors

Ellipses

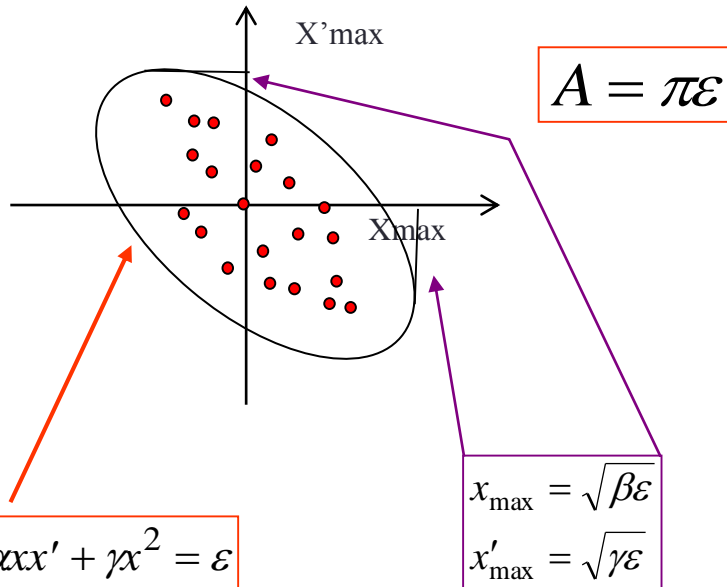

- RMS ellipses
- Include more or less (ex : 95%) particles.
- 4 parameters ($\alpha, \beta, \gamma, \epsilon$) – in fact 3.
- Ex: if the beam is gaussian in two dimensions, the number of particles in the ellipse is $N_0 \cdot [1 - \exp(-\epsilon/$

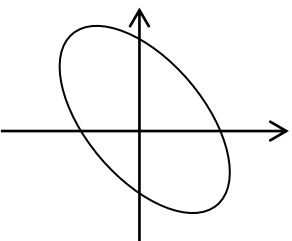

$\alpha > 0$ (convergent)

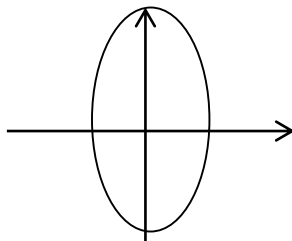

$\alpha = 0$ (waist)

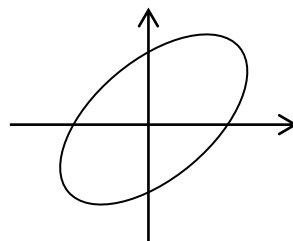

$\alpha < 0$ (divergent)

Emittance transport

- Explicit formula

$$\begin{bmatrix} \beta \\ \alpha \\ \gamma \end{bmatrix}_1 = \frac{1}{\Delta} \begin{bmatrix} M_{11}^2 & -2M_{11}M_{12} & M_{12}^2 \\ -M_{11}M_{21} & M_{12}M_{21} + M_{11}M_{22} & -M_{22}M_{12} \\ M_{21}^2 & -2M_{22}M_{21} & M_{22}^2 \end{bmatrix} \begin{bmatrix} \beta \\ \alpha \\ \gamma \end{bmatrix}_0$$

- Beam RMS envelope

$$\sqrt{\langle x^2 \rangle} = \sqrt{\beta \cdot \varepsilon_{rms}}$$

- α versus β

$$x(s + ds) = x(s) + x'(s)ds \rightarrow M_{ds} = \begin{bmatrix} 1 & ds \\ \dots & \dots \end{bmatrix}$$

$$\beta(s + ds) = \beta(s) - 2\alpha \cdot ds$$

$$\alpha = -\frac{\beta'}{2}$$

- Enveloppe extremum if $\alpha=0$ (waist)

Liouville Theorem (2D)

- Let X_1 and X_2 be two vectors in phase space

$$Y_1 = M \cdot X_1 \text{ and } Y_2 = M \cdot X_2$$

$$\det[Y_1 \quad Y_2] = \det(M) \cdot \det[X_1 \quad X_2] = \frac{p_e}{p_s} \cdot \det[X_1 \quad X_2]$$

- The area in phase space varies accordingly to momentum
- \rightarrow the area is constant if there is no acceleration
- $\rightarrow \beta_{Lorentz} \cdot \gamma_{Lorentz} \cdot \varepsilon$ is constant (normalized emittance)
- **Warning:** if the motion is not linear, the “apparent” RMS emittance varies, even the surface in phase space is constant

Spectrometer (magnetic separation only)

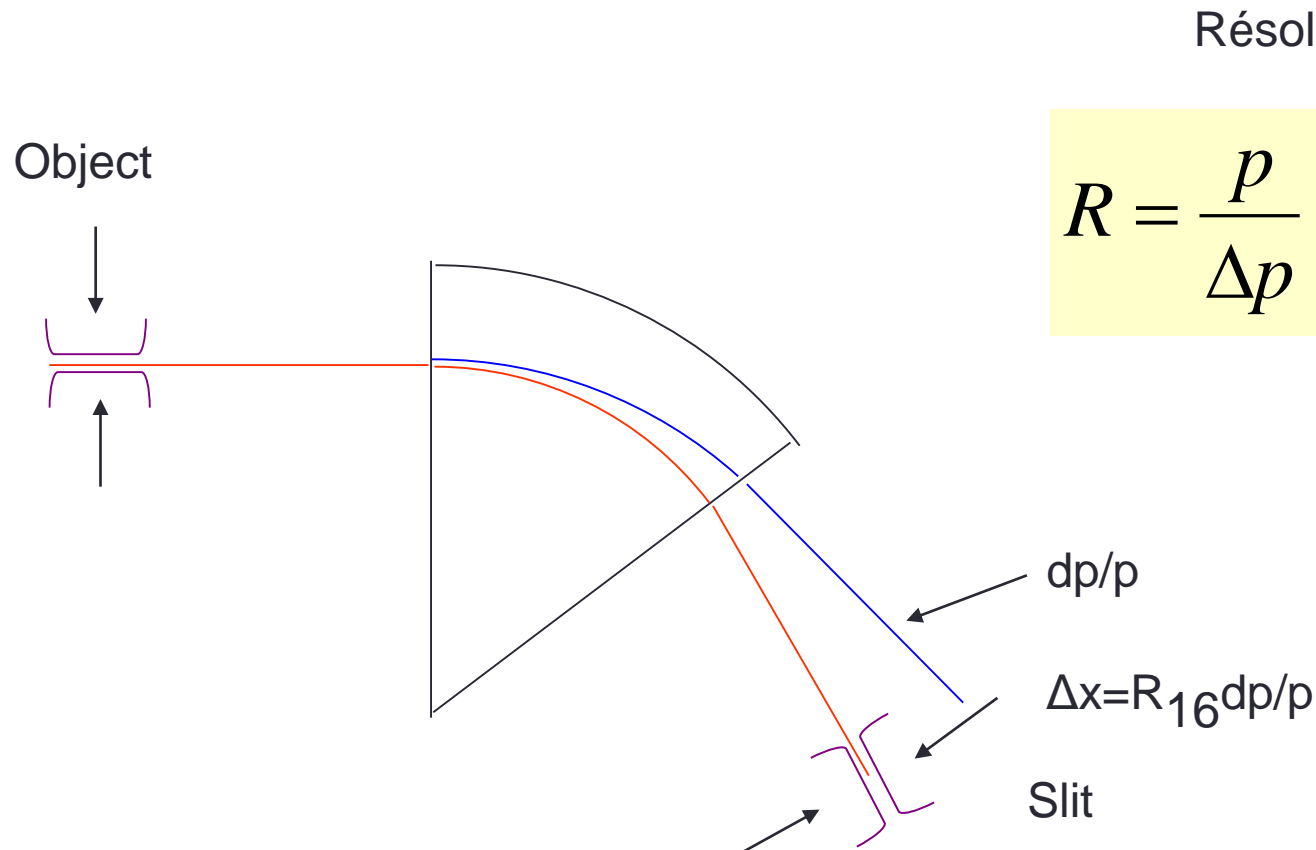

Spectrometer design

- Point to point imaging → system size
- Waist to Waist imaging
- Beam size: $R_S = |M_{11}| \cdot R_E$
- Analysis if $D \frac{\Delta P}{P} = 2R_S$

$$\frac{p}{\Delta p} = \frac{D}{2|M_{11}| \cdot R_E}$$

- Resolution is directly depending on the magnetic area covered by the beam, not by optics
- Optics has operational aspects (ex: achievable slit size) and low effect on resolution

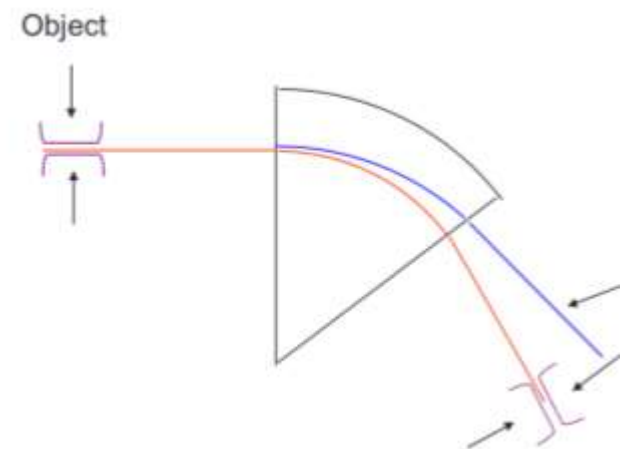
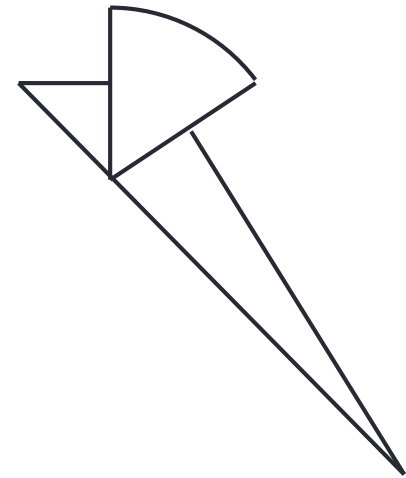

SPEG spectrometer (GANIL)

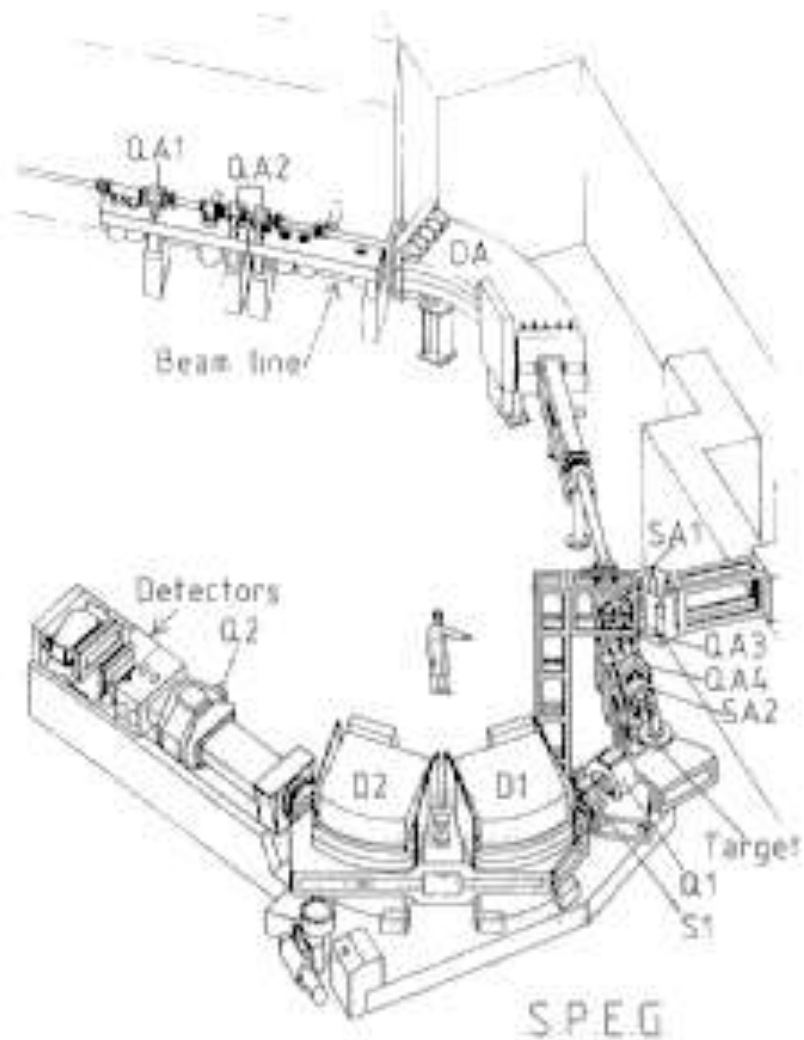

Courant/Snyder invariant – Emittance matching

- Consider a periodic system made of identical cells (no acceleration). Let M be the matrix of each cell. M has 2 eigenvalues λ and $1/\lambda$ (determinant is 1)
- Suppose the motion to be stable, then λ^n and $1/\lambda^n$ must be bounded for any value of n (integer)
- The only way is $|\lambda| = 1 = |1/\lambda| \rightarrow \lambda = e^{i\mu}$
- $\rightarrow \text{Tr}(M) = \lambda + \frac{1}{\lambda} = 2 \cos(\mu)$
- The motion is stable if and only if $-1 \leq \frac{1}{2} \text{Tr}(M) < 1$
- Ex: stability for FODO cell (L between lenses):

$$\cos\mu = 1 - \frac{L^2}{2f^2} > -1 \rightarrow f > \frac{L}{2}$$

Courant/Snyder invariant – Emittance matching

- Suppose the motion to be stable
- The following formulas are straightforward, with the transfer matrix TWISS parameters

$$M = \begin{bmatrix} \cos \mu + \alpha^* \sin \mu & \beta^* \sin \mu \\ \gamma^* \sin \mu & \cos \mu - \alpha^* \sin \mu \end{bmatrix}$$

$$M = \cos \mu \cdot \begin{bmatrix} 1 & 0 \\ 0 & 1 \end{bmatrix} + \sin \mu \cdot \begin{bmatrix} \alpha^* & \beta^* \\ \gamma^* & -\alpha^* \end{bmatrix} \equiv \cos \mu \cdot I + \sin \mu \cdot J$$

$$J^2 = -1$$

$$M \cdot \begin{bmatrix} \beta^* & -\alpha^* \\ -\alpha^* & \gamma^* \end{bmatrix} \cdot \tilde{M} = \begin{bmatrix} \beta^* & -\alpha^* \\ -\alpha^* & \gamma^* \end{bmatrix}$$

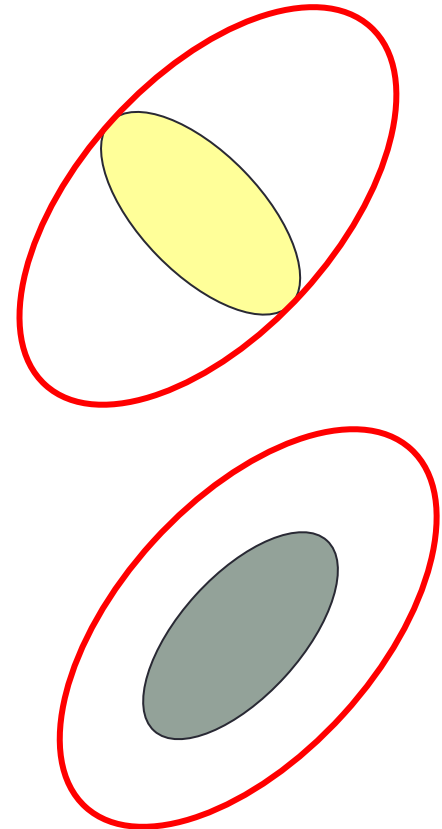

Emittance matching: if the injected emittance Twiss parameters are equal to the system Twiss parameters, the oscillations of the beam envelope are minimized, and the beam occupies less space in phase space.

Beam matching (envelope)

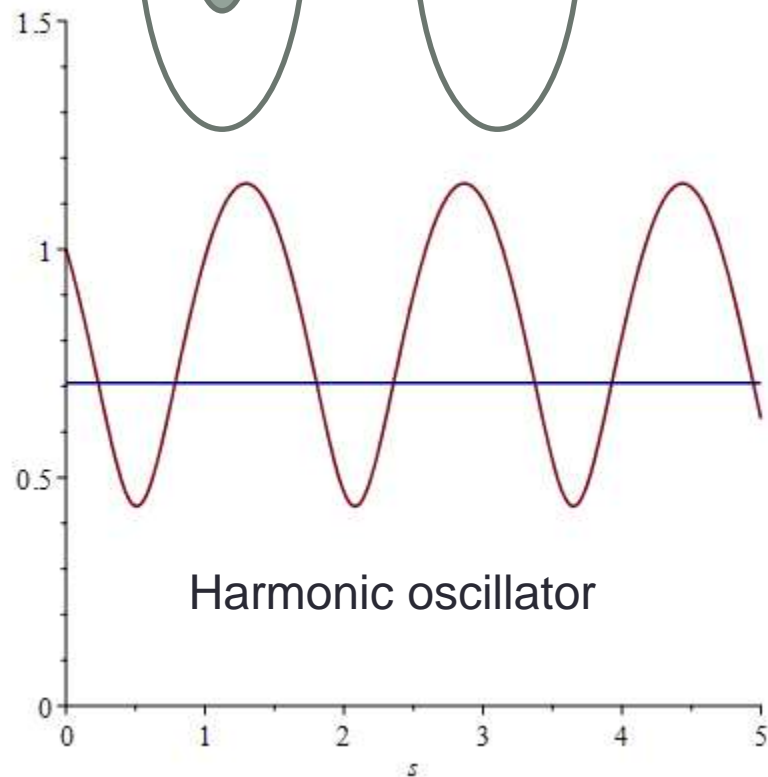
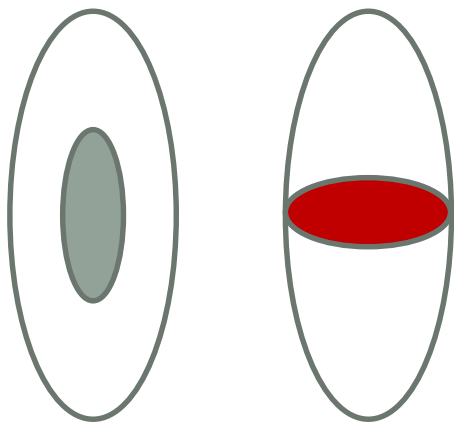

FODO (pseudo-harmonic motion)

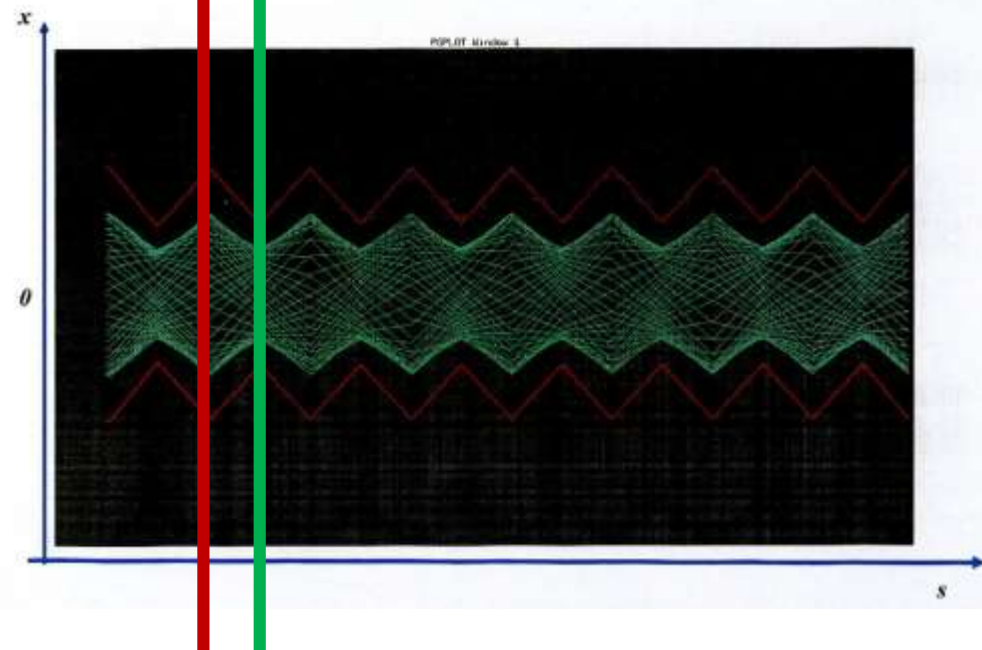

A few words about emittance measurements

- The RMS envelope varies with focusing
- It is related to the initial emittance parameters
- A known lens (system) is used with different tunings
- N profile (RMS) measurements are made
- N equation with 4 unknown are obtained
- Warning: numerically unstable with solenoids (even if a theoretical solution exists)

$$\langle x^2 \rangle = \sigma_0^2 = \beta_0 \varepsilon_{RMS}$$

$$\sigma^2 = (A\beta + B\alpha + C\gamma) \varepsilon_{RMS}$$

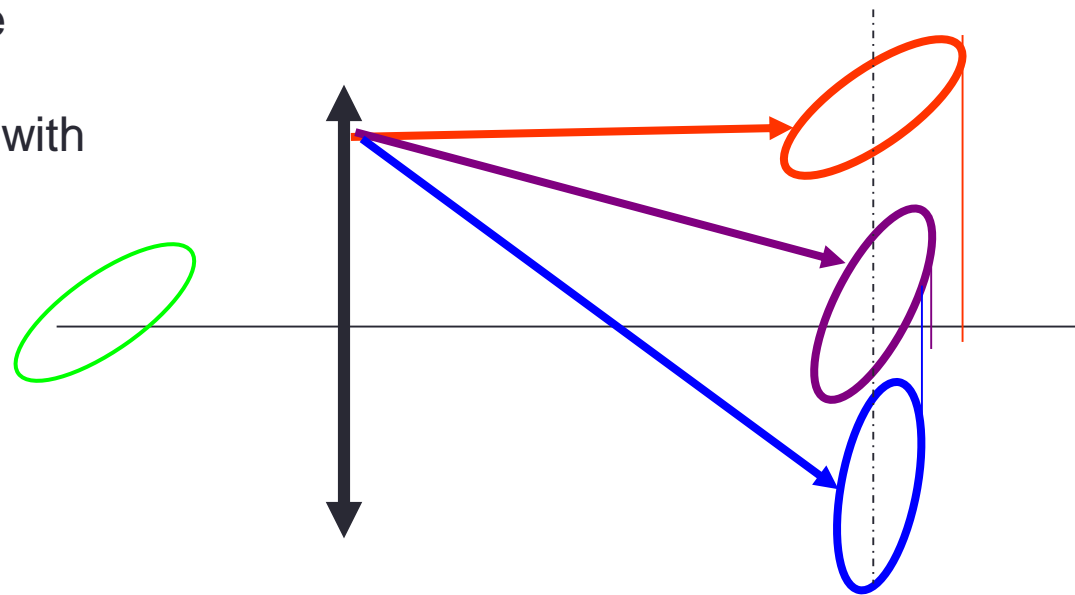

Moving slit (real phase picture)

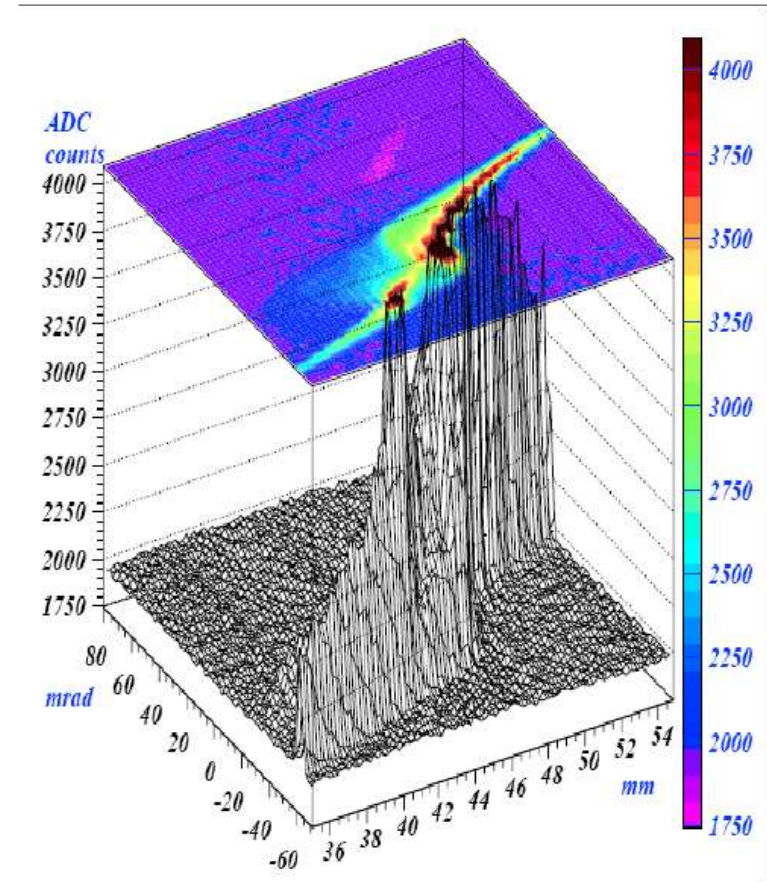
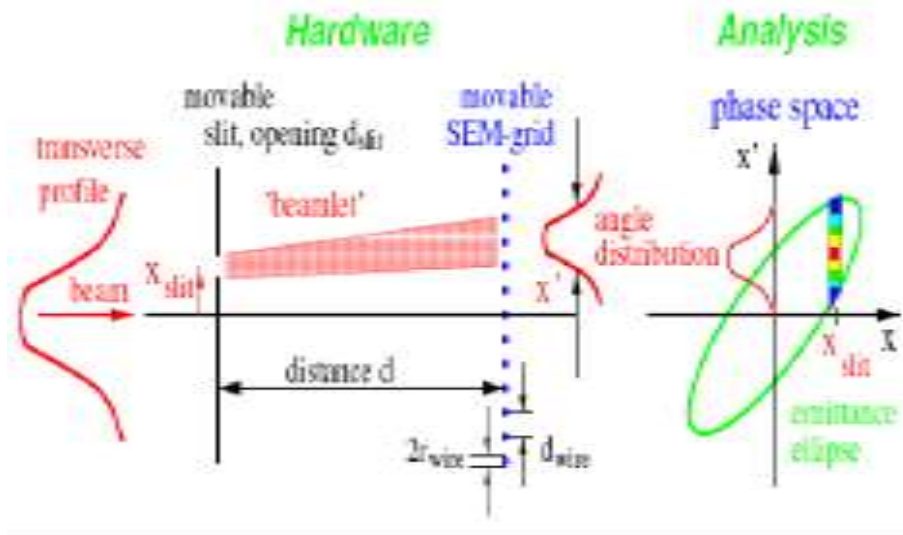

Elliptic shape might be far from reality at low energy

Courtesy Bernard Launé

The reality (SILHI source, Saclay)

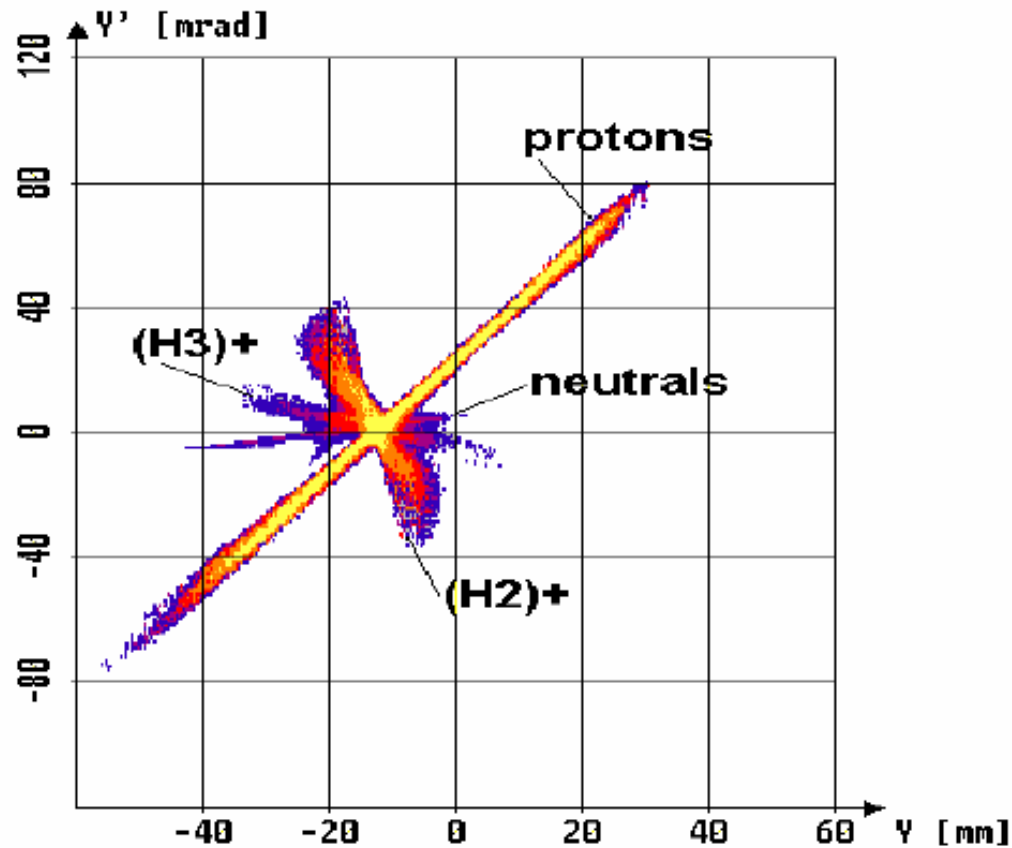

Saclay source SILHI

Courtesy Bernard Launé

Collimators on some examples

- Collimator: $\begin{bmatrix} A \\ \lambda \end{bmatrix}$ (A =aperture, $\lambda \in \mathbb{R}$)
- M : transfer matrix from collimator to target
- Case 1: $M_{22} = 0$. A vertical line is transformed to an horizontal one. No effect on beam size
- Case 2: $M_{12} = 0$. A vertical line is transformed to a vertical one. Effect is maximum. In this case $R_{target} = |M_{11}| \cdot A$

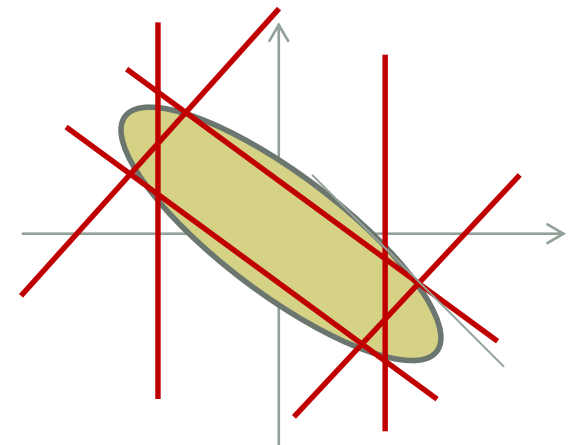
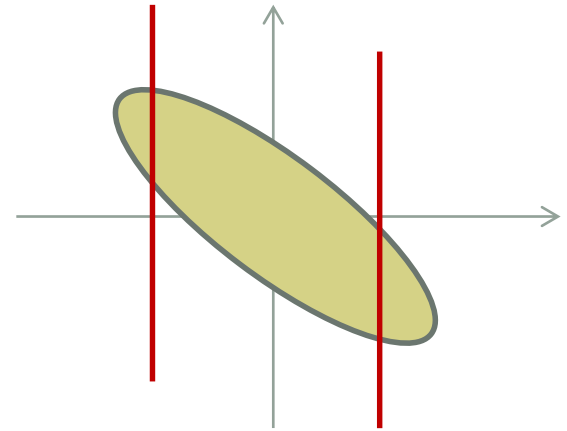

Thank you!