

Vacuum Systems

Lecture 5

V. Baglin

CERN TE-VSC, Geneva



Outline

1. Beam-gas interactions
2. Pressure profiles
3. The LHC case
4. Some studies related to LHC, HL-LHC, FCC etc. vacuum systems

1. Beam-gas interactions

Cross section

- The cross section σ , is the **probability** the beam interacts with the atoms of target
- When a beam of intensity I , cross a target of thickness dx with a density of atoms n , the change in beam current is:

$$dI = -I \sigma n dx$$

- The cross section is a constant having the **dimension of an area**

- The unit is 1 barn = $10^{-28} \text{ m}^2 = 10^{-24} \text{ cm}^2$

- The beam moves at a speed v , thus the thickness of target traversed during the time dt equals: $v dt$

- using the previous equation, this gives:

$$\frac{dI}{dt} = -I n v \sigma$$

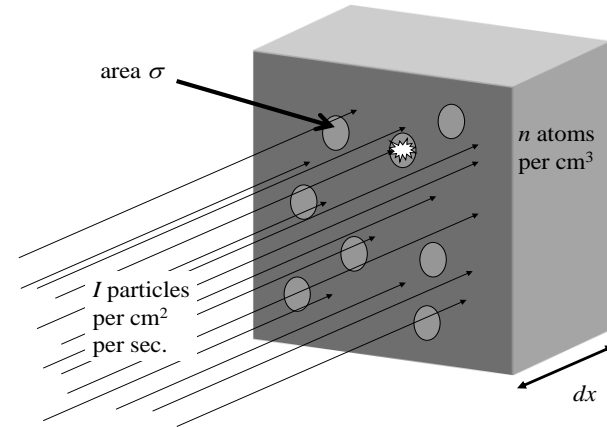

Beam residual gas interactions, SP Møller, CAS, CERN 99-05
Lifetime, cross-section and activation, P. Grasström, CAS, CERN 2007-003

Life time

- The evolution of the beam current is given by the integration of the previous equation:

$$I = I_0 e^{-\frac{t}{\tau}} \quad \text{with} \quad \tau = \frac{1}{n \sigma v}$$

- During the interaction process, the beam current decrease exponentially with a time constant inversely proportional to the gas density and the cross section
- In a vacuum system, the beams interacted differently with the different gas species of density n_i according to their respective cross sections σ_i :

$$\tau_i = \frac{1}{n_i \sigma_i v}$$

- Summing up the interaction process on the different gas species gives:

$$\sum \frac{dI_i}{dt} = -Iv \sum n_i \sigma_i$$

- Thus:

$$\frac{1}{\tau} = \sum \frac{1}{\tau_i}$$

For a vacuum system: $\frac{1}{\tau} = \frac{1}{\tau_{H_2}} + \frac{1}{\tau_{CH_4}} + \frac{1}{\tau_{H_2O}} + \frac{1}{\tau_{CO}} + \frac{1}{\tau_{CO_2}}$

The vacuum life time must be much larger (*i.e.* $\gg 24$ h) than other life times such as *e.g.* the particle loss due to the collisions

Beam-gas interactions

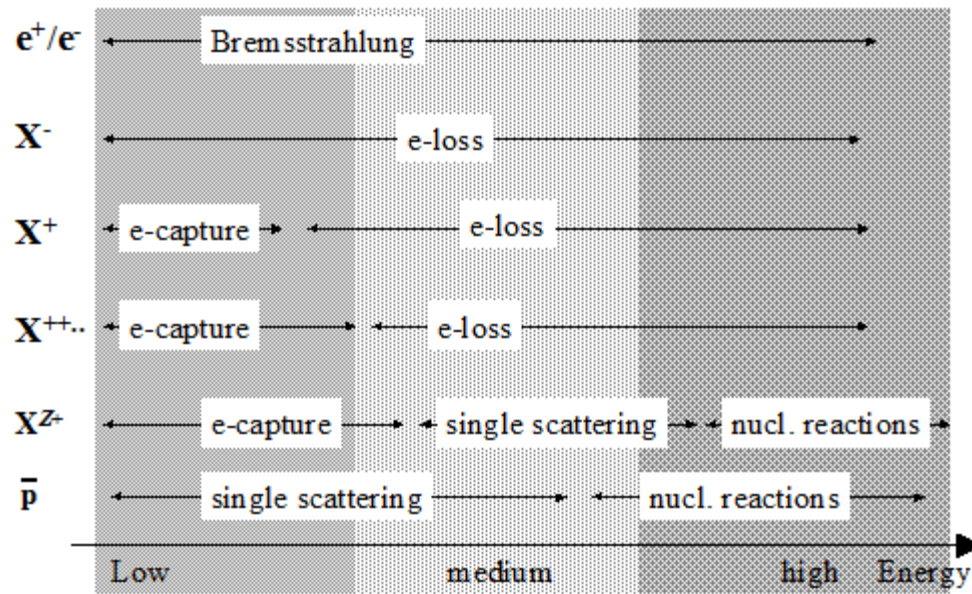
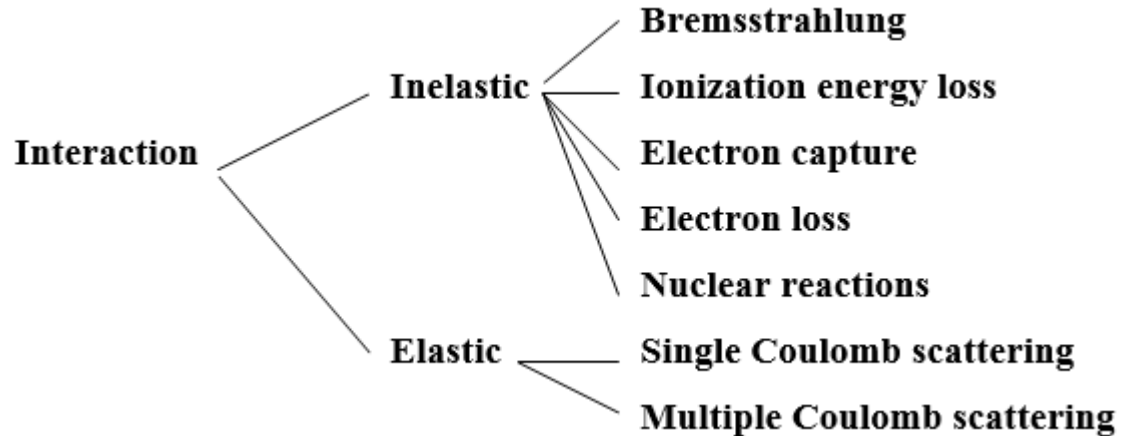

Beam residual gas interactions, SP Møller, CAS, CERN 99-05

Proton storage ring

- At high energy, the proton beam can interact with the nuclei of the atom. The scattered proton change its direction or loses so much energy that it is lost from the beam
- The **nuclear scattering cross section** increases with beam energy :

7 TeV values

Gas	A	$\sigma(\text{mb})$	$\sigma_{\text{rel},i}$
H ₂	2	95	1
He	2	126	1.33
CH ₄	16	566	5.96
H ₂ O	18	565	5.96
CO	28	854	8.99
N ₂	14	820	8.63
O ₂	32	924	9.73
CO ₂	44	1317	13.86
Kr	84	2177	22.92
Xe	131	3231	34.01

$$\sigma_{\text{rel},i} = \frac{\sigma_i}{\sigma_{\text{H}_2}}$$

$$\sigma_{pA} = \sigma_{pp} A^{0.7}$$

H	$\sigma(\text{mb})$
450 GeV	32.5
7 TeV	47.5
50 TeV	65

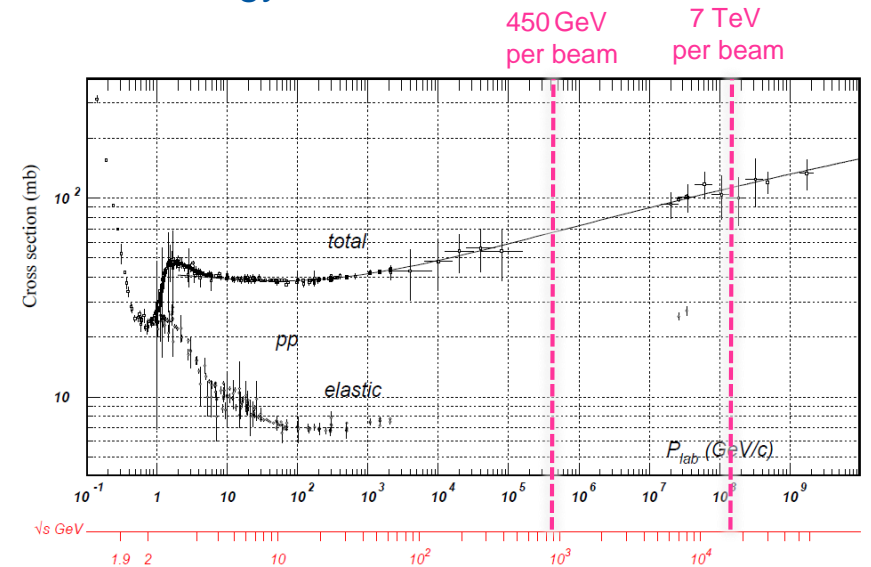

Total and elastic cross sections for pp collisions as a function of laboratory beam momentum and total centre of mass energy

- In a vacuum system, it is convenient to express the gas density in H₂ equivalent as if there were one specie of gas.

$$n_{\text{H}_2 \text{ eq}} = \sum n_i \sigma_{\text{rel},i}$$

Application: LHC vacuum life time

- In the LHC, the vacuum life time is defined by nuclear scattering set to 100 h:
 - The corresponding H₂ gas density is:

$$n_{H_2} = \frac{1}{\tau \sigma_{H_2} c} = \frac{1}{3.6 \cdot 10^5 \times 95 \cdot 10^{-31} \times 3 \cdot 10^8} = 10^{15} \text{ H}_2 \cdot \text{m}^{-3}$$

- *i.e.* 4 10⁻⁸ mbar

- Assuming the residual gas composition is dominated by CO, this would correspond to:

$$n_{CO} = \frac{n_{H_2}}{\sigma_{rel,i}} = \frac{10^{15}}{8.99} = 10^{14} \text{ CO} \cdot \text{m}^{-3}$$

- *i.e.* 4 10⁻⁹ mbar

- Assume a gas mixture of H₂ and CO, with 2 10¹⁴ H₂·m⁻³ and 5 10¹³ CO·m⁻³ *i.e.* a total pressure of 10⁻⁸ mbar, what would be the vacuum life time?

- compute the equivalent H₂ gas density:

$$n_{H_2 \text{ eq}} = n_{H_2} + n_{CO} \sigma_{rel,co} = 2 \cdot 10^{14} + 8.99 \times 5 \cdot 10^{13} = 6.4 \cdot 10^{14}$$

- compute the vacuum life time:

$$\tau = \frac{1}{3600} \frac{1}{n_{H_2 \text{ eq}} \sigma_{H_2} c} = \frac{1}{3600} \frac{1}{6.4 \cdot 10^{14} \times 95 \cdot 10^{-31} \times 3 \cdot 10^8} = 150 \text{ h}$$

2. Pressure profiles

Gas flow in an elemental chamber

- We assume an elemental vacuum chamber pipe of length dx , with specific conductance c , into which gas desorbs at a rate a .
- The gas flow, Q , through the elemental chamber is:

$$Q = -c \frac{dP}{dx}$$

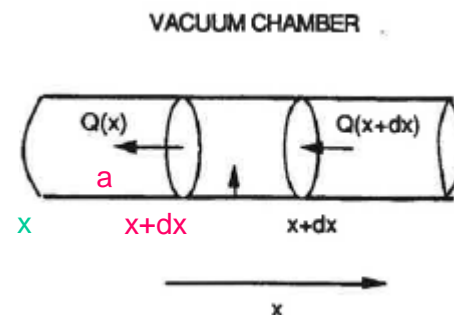

- The change of gas density in the volume element Vdx between x and $x+dx$ is:

$$Vdx \frac{dP}{dt} = +adx + c \left[\frac{dP}{dx} \right]_{x+dx} - c \left[\frac{dP}{dx} \right]_x$$

$$V \frac{dP}{dt} = a + c \left[\frac{d^2P}{dx^2} \right]$$

- In steady state condition ($dP/dt = 0$), we have:

$$\frac{d^2P}{dx^2} = -\frac{a}{c}$$

- Which solution is a **parabolic function**.

Vacuum system design, A.G. Mathewson, CAS, CERN 94-041

Simple machine

- We assume a simple machine with pumps of speed $2S$, regularly spaced by a distance $2L$.

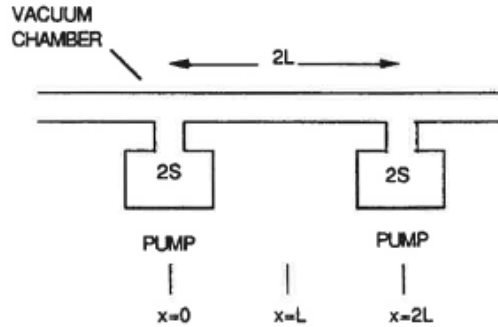

- boundary conditions:

$$\left[\frac{dP}{dx} \right]_{x=L} = 0 \quad \text{and} \quad P(0) = P(L) = \frac{aL}{S}$$

- So:

$$P(x) = \frac{aL}{S} + \frac{aL}{c}x - \frac{a}{2c}x^2$$

- The maximum pressure is given by:

$$P_{max} = \frac{aL}{S} + \frac{aL^2}{2c}$$

- The average pressure is given by:

$$P_{av} = \frac{1}{2L} \int_0^{2L} P(x) dx = aL \left[\frac{1}{S} + \frac{L}{3c} \right]$$

Vacuum system design, A.G. Mathewson, CAS, CERN 94-041

Simple machine: application

- P is the gas pressure (mbar)
- V is the volume per unit of length (l m^{-1})
- c is the specific conductance of the tube ($\text{l s}^{-1} \text{ m}$)
- a is the gas desorption per unit length of tube ($\text{mbar l s}^{-1} \text{ m}^{-1}$)
- $2L$ is the distance between the pumps (m)
- $2S$ is the pumping speed (l s^{-1})

	$P1(x)$	$P2(x)$	$P(3)$
D (cm)	10	10	5
c ($\text{l s}^{-1} \text{ m}$)	121	121	15.1
$2S$ (l s^{-1})	30	300	300
P_{max} (mbar)	$6 \cdot 10^{-9}$	$3 \cdot 10^{-9}$	$1 \cdot 10^{-8}$
P_{av} (mbar)	$3 \cdot 10^{-9}$	$2 \cdot 10^{-9}$	$7 \cdot 10^{-9}$

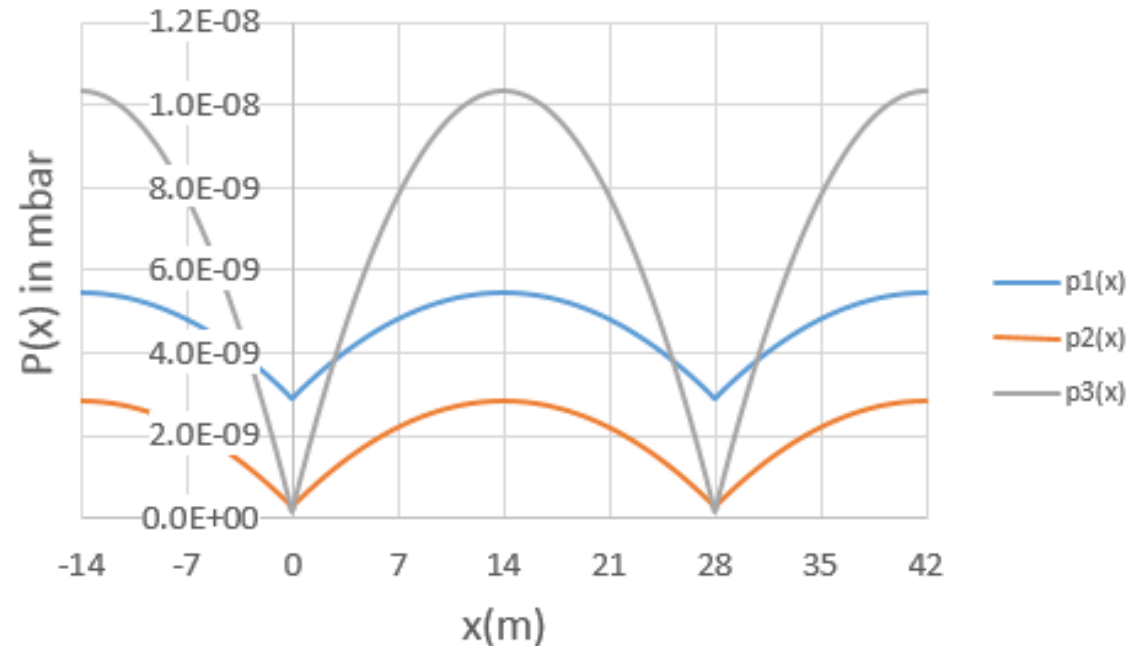

The average pressure is dominated by the conductance

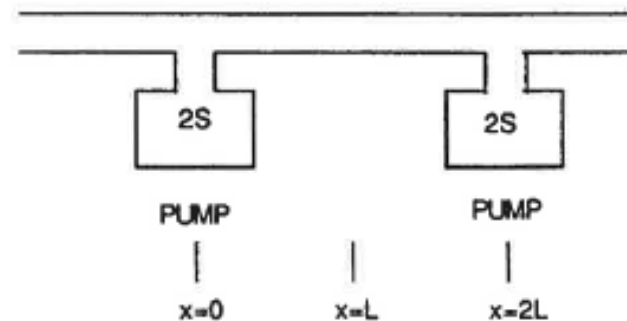

Simple machine with distributed pumping, s

$$V \frac{dP}{dt} = a + (b - s)P + C \frac{d^2P}{dx^2}$$

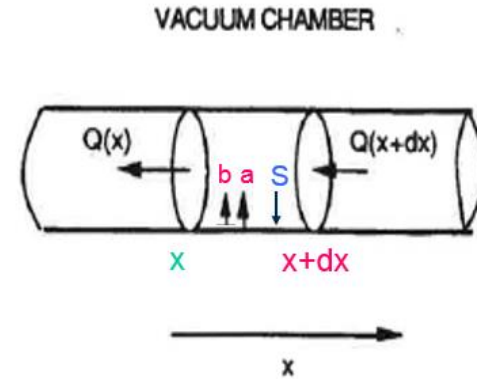

- Where:

a is the linear outgassing rate (includes thermal desorption and photon stimulated desorption) in Torr.l/s/m

s is the linear pumping speed in l/s/m

b is the ion induced desorption; $b = 10^3 \eta \sigma I / e$ in l/s/m

I is the proton beam current in A

C is the specific conductance of the vacuum chamber in l.m/s

V is the volume per unit of length in l/m

- In quasi static conditions:

$$\frac{d^2P}{dx^2} = \left(\frac{s - b}{C} \right) P - \frac{a}{C}$$

- For long tubes $Cd^2P/dx^2 = 0$:

$$P_{inf} = \frac{a}{s - b}$$

- So the vacuum system is stable if $s-b > 0$ i.e. $s > b$

Simple machine with distributed pumping, s

- For short tubes $Cd^2P/dx^2 \neq 0$:

$$P(x) = Ae^{-\lambda x} + Be^{\lambda x} + \frac{a}{\lambda^2 C} \quad \text{with} \quad \lambda^2 = \frac{s-b}{C}$$

- With the following boundary conditions:

$$C \left[\frac{dP}{dx} \right]_{x=\mp L} = \pm P(\mp L) 2S$$

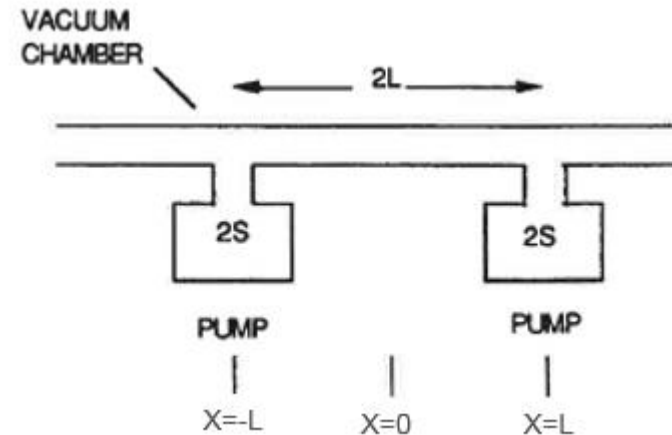

- It gives:

$$P(x) = P_{inf} \left(1 - \frac{\cosh(\lambda x)}{\cosh(\lambda L) \left(1 + \frac{C}{2S} \lambda \tanh(\lambda L) \right)} \right)$$

Simple machine with distributed pumping: application

- P is the gas pressure (mbar)
- V is the volume per unit of length (l m⁻¹)
- c is the specific conductance of the tube (l s⁻¹ m)
- b is set to zero
- a is the gas desorption per unit length of tube (mbar l s⁻¹ m⁻¹)
- 2L is the distance between the pumps (m)
- 2S is the pumping speed (l s⁻¹)

	P1(x)	P2(x)	P(3)
D (cm)	10	10	5
c (l s ⁻¹ m)	121	121	15.1
2S (l s ⁻¹)	30	300	300
a (mbar l /s / m)	3 10 ⁻⁹	3 10 ⁻⁹	1.5 10 ⁻⁹
S (l s ⁻¹ m ⁻¹)	1834	1834	917
P _{inf} (mbar)	2 10 ⁻¹²	2 10 ⁻¹²	2 10 ⁻¹²

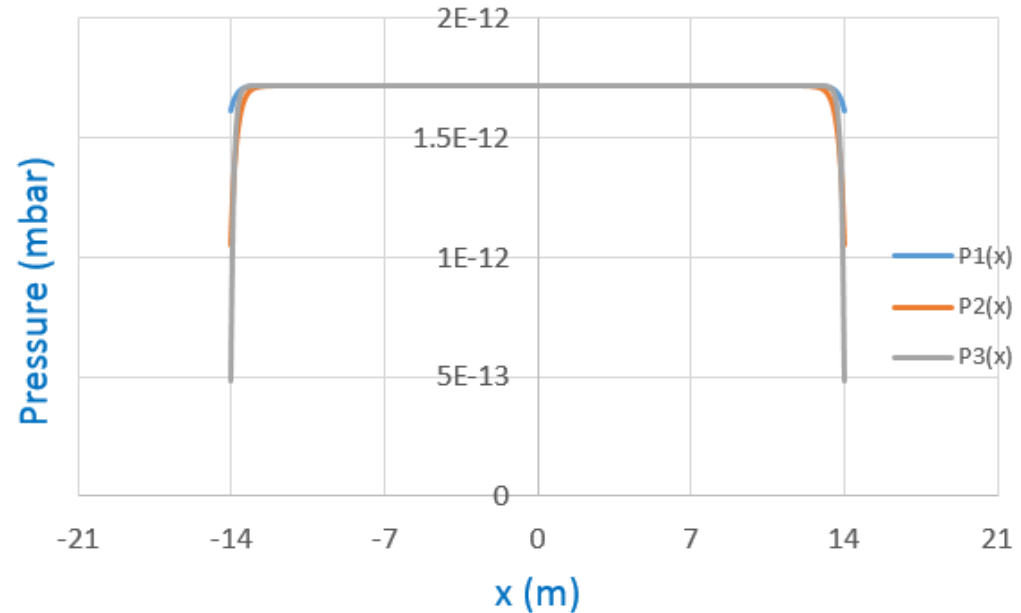

- 50 cm away from the pump, the pressure is independent of its pumping speed

The average pressure is dominated by the long tube pressure P_{inf}

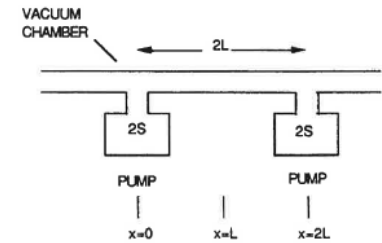

VASCO : a code to study vacuum stability

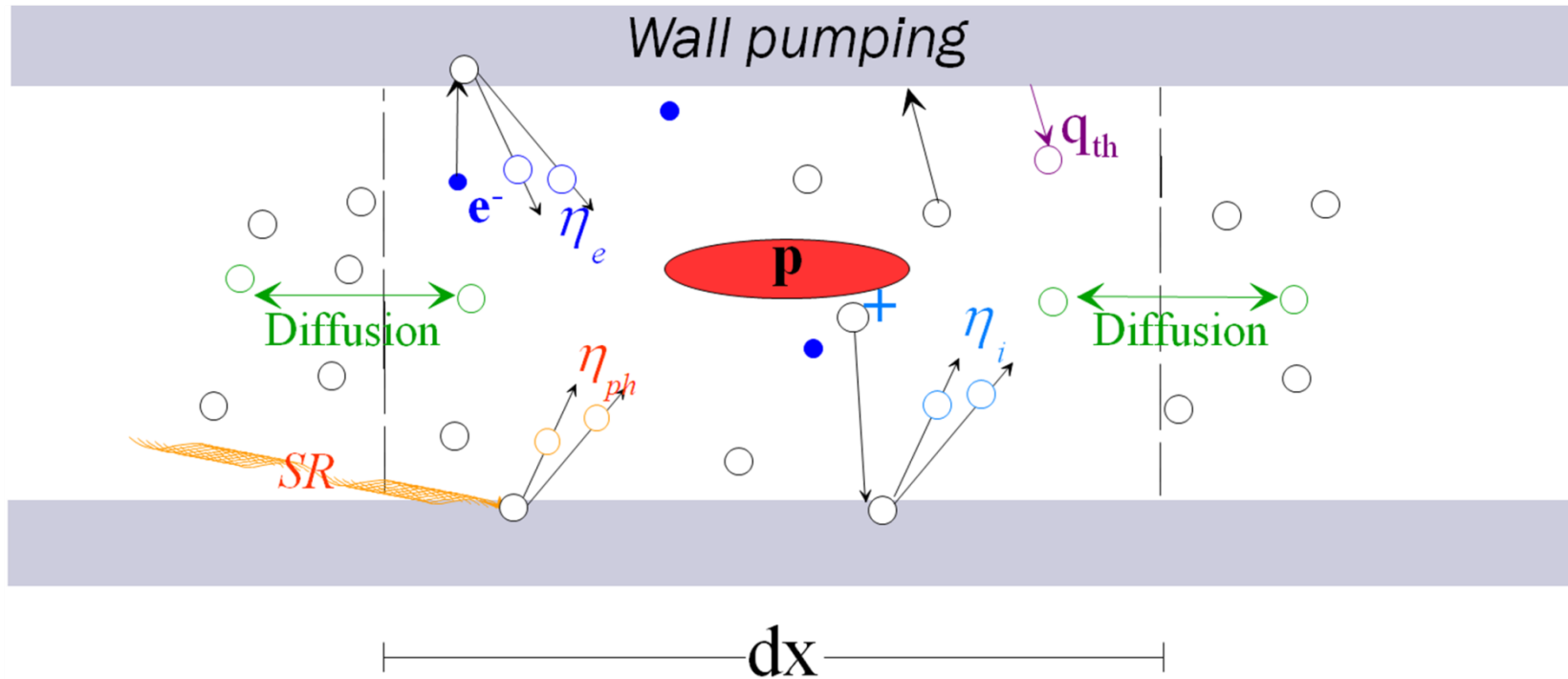

The changing rate of the number of molecules per unit volume:

- ◆ Molecular diffusion
- ◆ Beam induced dynamic effects: ion, electron and photon induced molecular desorption.
- ◆ Gas pumping distributed along the beam pipe: NEG and Cryo
- ◆ Gas lumped pumping: Sputtered ion pumps

Gas Balance Equation

VASCO: Multi-gas code to calculate gas density profile in uhv system, A. Rossi. CERN LHC Project Note 341, 2004

$$V \frac{\partial n_g}{\partial t} = a \cdot D_g \cdot \frac{\partial^2 n_g}{\partial x^2} + \frac{I}{e} \sum_j \left\{ \eta_{i,j^+ \rightarrow g} \sigma_j^b \cdot n_j \right\} - \left(\frac{A \cdot v_g}{4} \cdot \alpha_g + C_g \right) \cdot n_g + \eta_{ph,g} \cdot \dot{\Gamma}_{ph} + \eta_{e,g} \cdot \dot{\Gamma}_e + A \cdot q_g$$

Time variation of particles in volume V
Diffusion through surface a

Ionization by beam and desorption by the ions
Distributed pumping of NEG or Cryo
Desorption by photons
Desorption by electron
Thermal desorption

Multi Gas Model

MULTI GAS MODEL

- ❖ Dominant gas species present in a vacuum system: H₂, CH₄, CO and CO₂
- ❖ The “multi gas” model takes into account that each of the gas species, once ionized, can desorbs any species both from the wall beam pipes or the condensed gas layer in a cryogenic system
- ❖ The equation of each species depends on the gas densities of other species, and all the equations results inter-dependent

Gas density profile around ATLAS

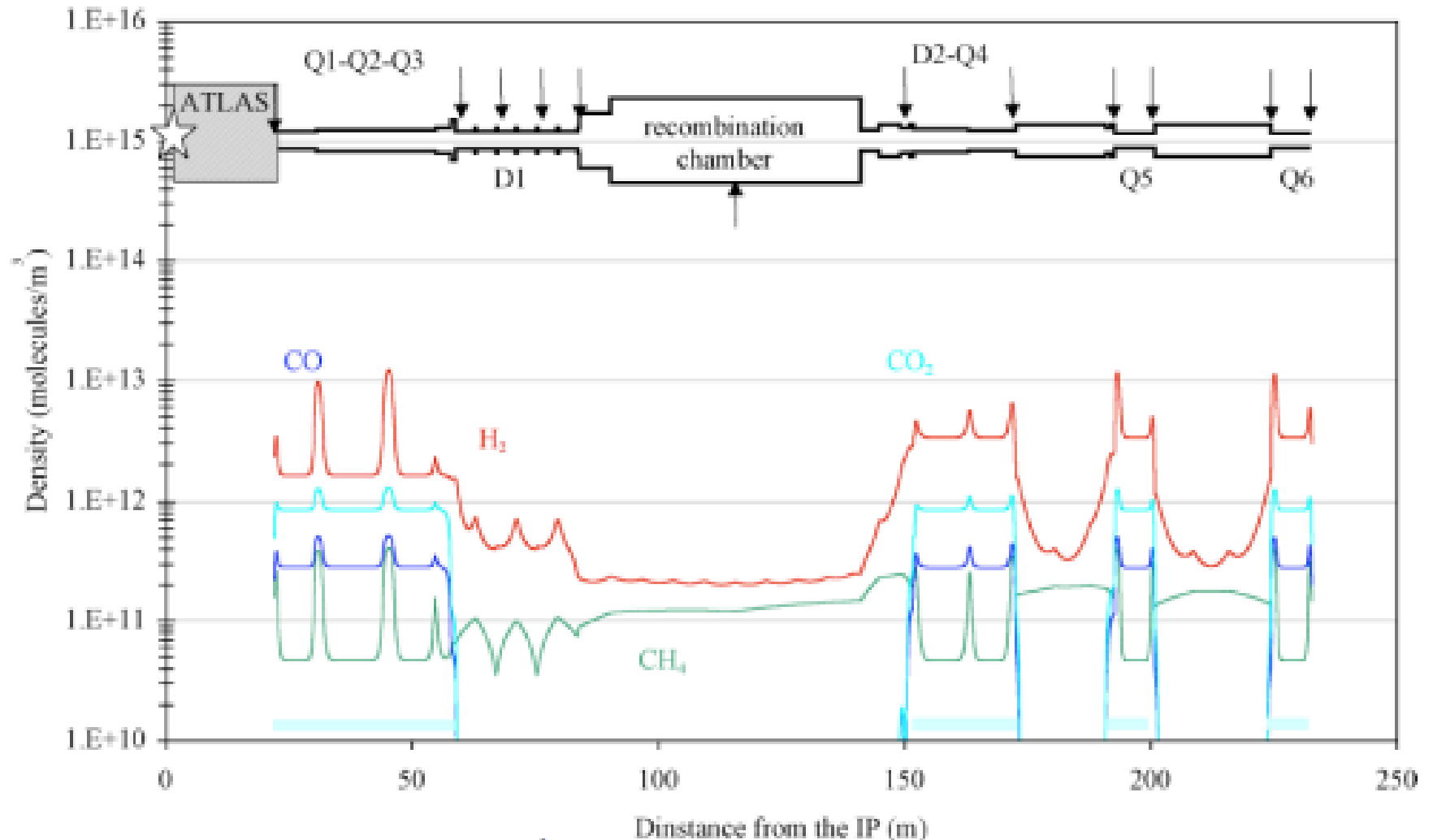

A. Rossi, CERN LHC PR 783, 2004.

Gas density profile simulation: Molflow+

A Test-Particle Monte-Carlo Simulator for Ultra-High Vacuum systems

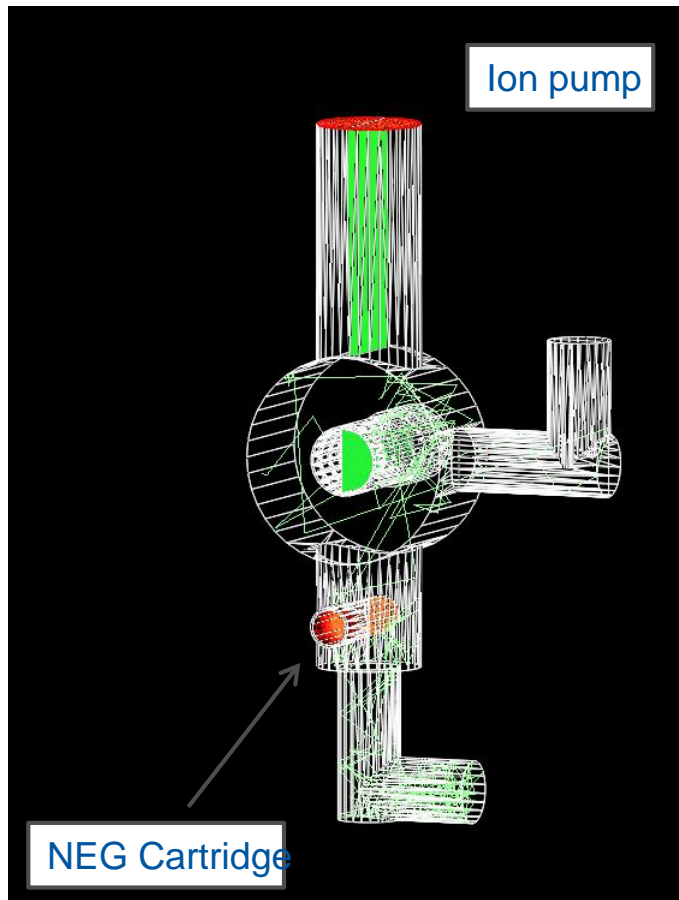

Simulation done with a flow of 1×10^{-8} mbar*l/s coming from the VAX insert

	Pressure in the beam line [mbar]	Pressure in the SVT gauge [mbar]
Ion Pump	2×10^{-8}	2×10^{-8}
Ion Pump + D400 NEG cartridge	6×10^{-9}	6×10^{-9}

Data from G.Bregliozzi – TE-VSC

For info: <http://test-molflow.web.cern.ch/content/about-molflow>

3. The LHC case

3.1 Design

Design value : a challenge with circulating beams

- **Life time limit** due to nuclear scattering ~ 100 h
 - $n \sim 10^{15}$ H₂/m³
 - $\langle P_{arc} \rangle < 10^{-8}$ mbar H₂ equivalent
 - ~ 80 mW/m heat load in the cold mass due to proton scattering

$$\tau = \frac{1}{\sigma c n} \qquad P_{cold\ mass} = \frac{I E}{c \tau}$$

- **Minimise background** to the LHC experiments

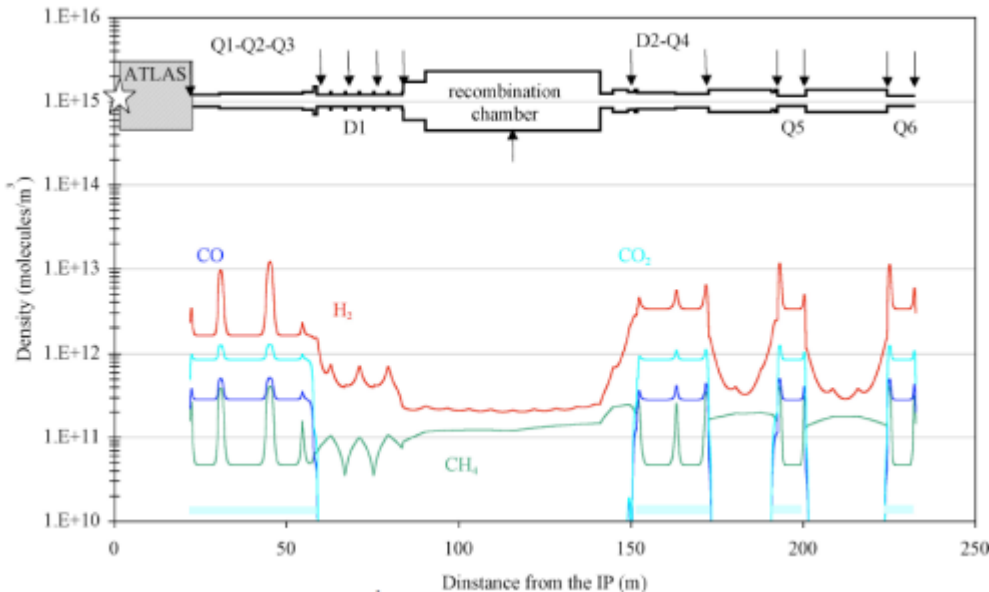

	H2_eq / m3	mbar
$\langle LSS_{1\ or\ 5} \rangle$	$\sim 5 \cdot 10^{12}$	10^{-10}
$\langle ATLAS \rangle$	$\sim 10^{11}$	10^{-11}
$\langle CMS \rangle$	$\sim 5 \cdot 10^{12}$	10^{-10}

A. Rossi, CERN LHC PR 783, 2004.

New System: LHC Beam Screens Functionalities

- An **innovative and complex** system, produced at several 10 km scale !
- **Intercept the heat load** induced by the circulating beam
- Operate between 5 and 20 K
- Pumping holes to **control the gas density**

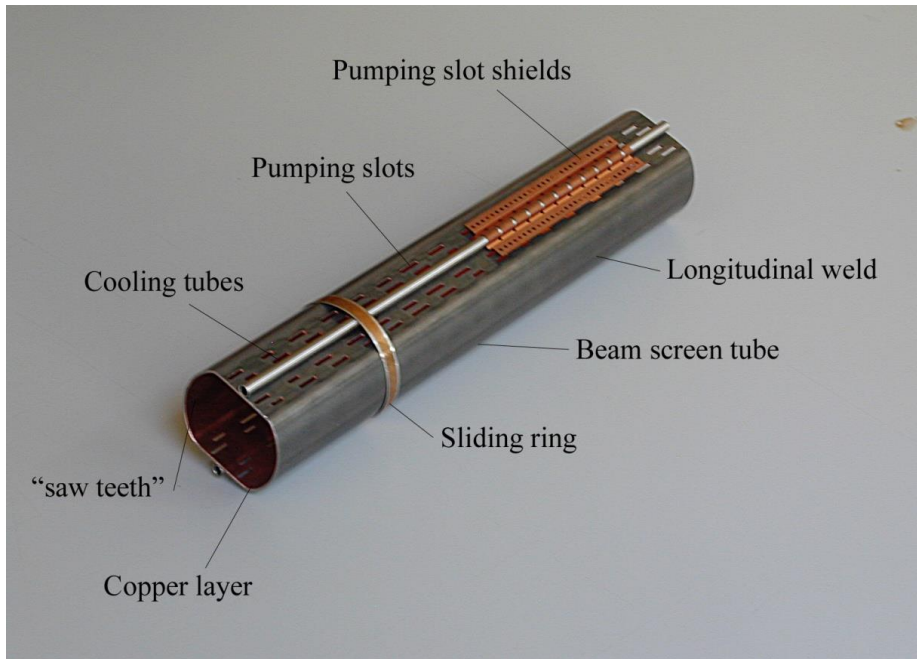

Courtesy N. Kos CERN TE/VSC

Functional design map of beam screen

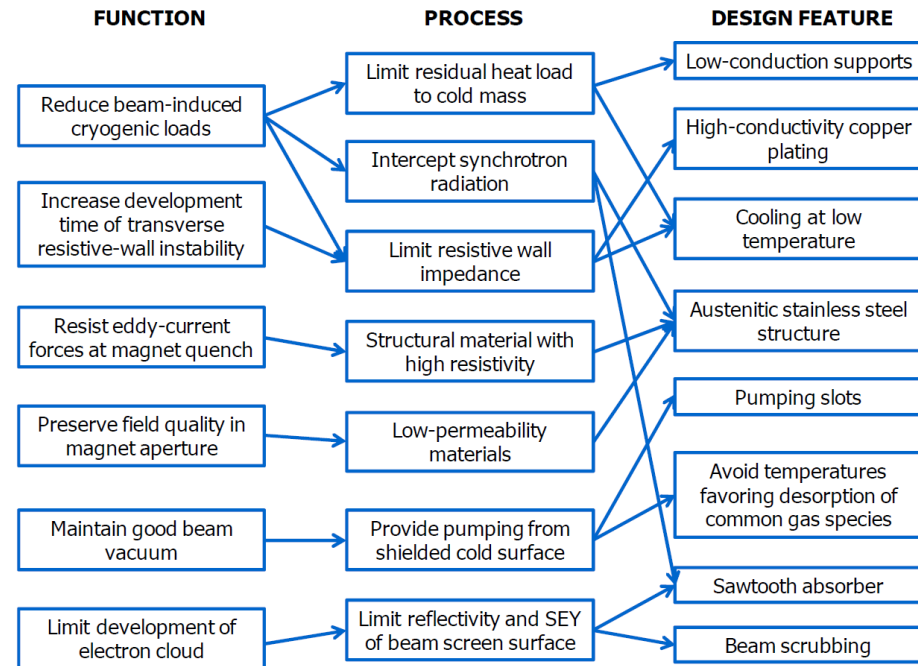

P. Lebrun et al.

Why Perforated Beam Screen ?

• SSC studies in 1994

V.V. Anashin *et al.* J. Vac. Sci. Technol. A. 12(5) , Sep/Oct 194

No perforations

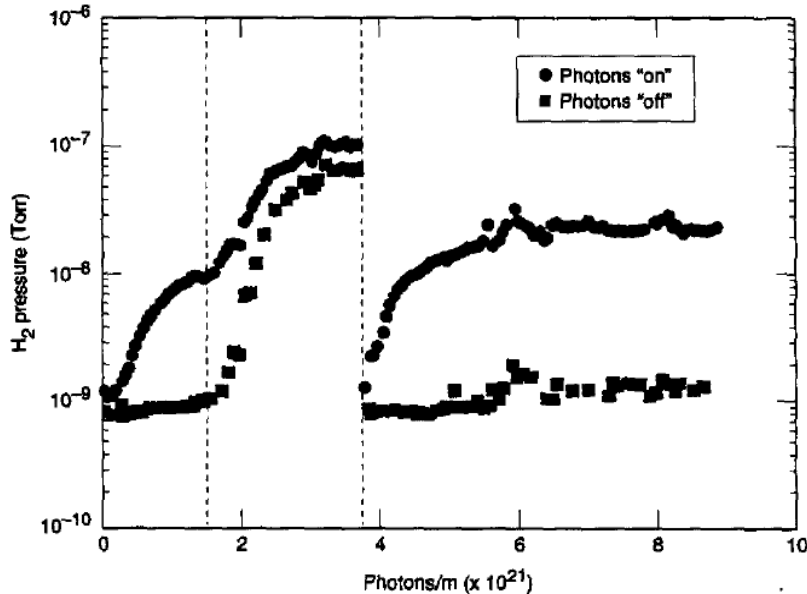

FIG. 1. Room-temperature RGA H₂ pressure measured at the center of the 4.2-K beam tube vs integrated photon flux with photons on and photons off. The raw pressure difference "on" minus "off" has been normalized to 1×10^{16} photons/m/s. The vertical dashed lines correspond to features discussed in the text.

With perforations

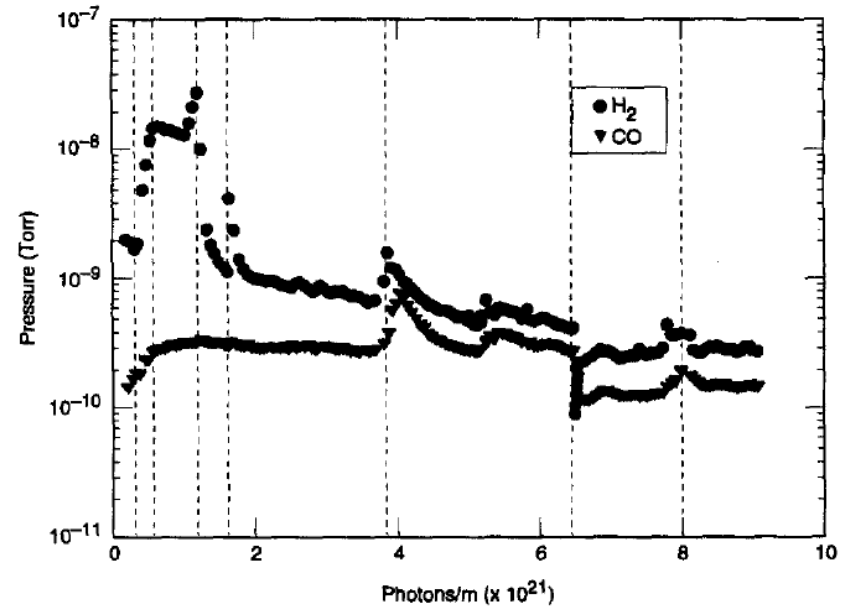

FIG. 2. Room-temperature RGA H₂ and CO dynamic pressures measured at the center of the liner configuration. Dynamic pressure is normalized to 1×10^{16} photons/m/s.

**A perforated beam screen
allows to control the gas density**

Gas density & surface coverage equations

V.V. Anashin *et al.* J. Vac. Sci. Technol. A. 12(5) , Sep/Oct 194

$$V \frac{\partial n}{\partial t} = \underbrace{\eta \dot{\Gamma}}_{\text{Photodesorption}} + \underbrace{\eta' \dot{\Gamma}}_{\text{Recycling}} + \underbrace{\frac{A \Theta}{\tau}}_{\text{Vapour pressure}} - \underbrace{\sigma S n}_{\text{Wall pumping}} - \underbrace{C n}_{\text{Holes pumping}} + \underbrace{A_c D \frac{\partial^2 n}{\partial z^2}}_{\text{Diffusion}}$$

$$A \frac{\partial \Theta}{\partial t} = \sigma S n - \eta' \dot{\Gamma} - \frac{A \Theta}{\tau}$$

• with:

n gas density, s surface coverage, V volume per unit length, A surface per unit length, $A_c D$ axial diffusion term of molecules, σ sticking probability, S ideal speed per unit length, C beam screen holes pumping speed per unit length, τ sojourn time of physisorbed molecule, η desorption yield of chemisorbed molecules, η' recycling desorption yield of physisorbed molecules,

Cryosorbing tube without holes

- Infinitely long tube ($A_c D=0$), without beam screen ($C=0$) and quasi static conditions:
 → Three terms adds: primary, recycling desorption and vapour pressure

$$n = \frac{\eta \dot{\Gamma}}{\sigma S} + \frac{\eta' \dot{\Gamma}}{\sigma S} + \frac{1}{\sigma S} \frac{A \Theta}{\tau}$$

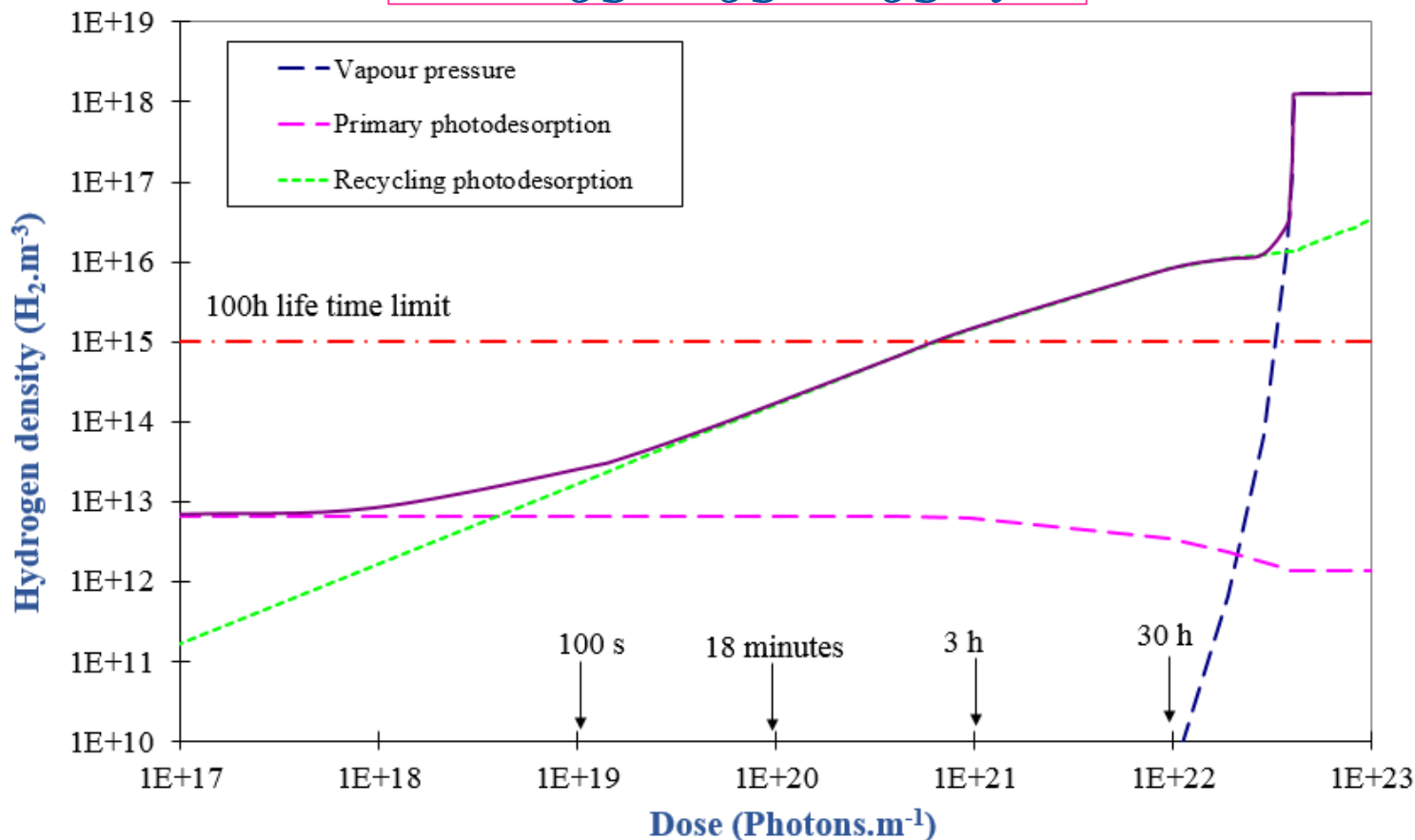

Cryosorbing tube without holes

$$n = \frac{\eta \dot{\Gamma}}{\sigma S} + \frac{\eta'(\Theta) \dot{\Gamma}}{\sigma S} + \frac{1}{\sigma S} \frac{A \Theta}{\tau}$$

← Increase with the surface coverage, Θ

$$\Theta = \frac{1}{A} \int_0^{\Gamma} \eta d\Gamma$$

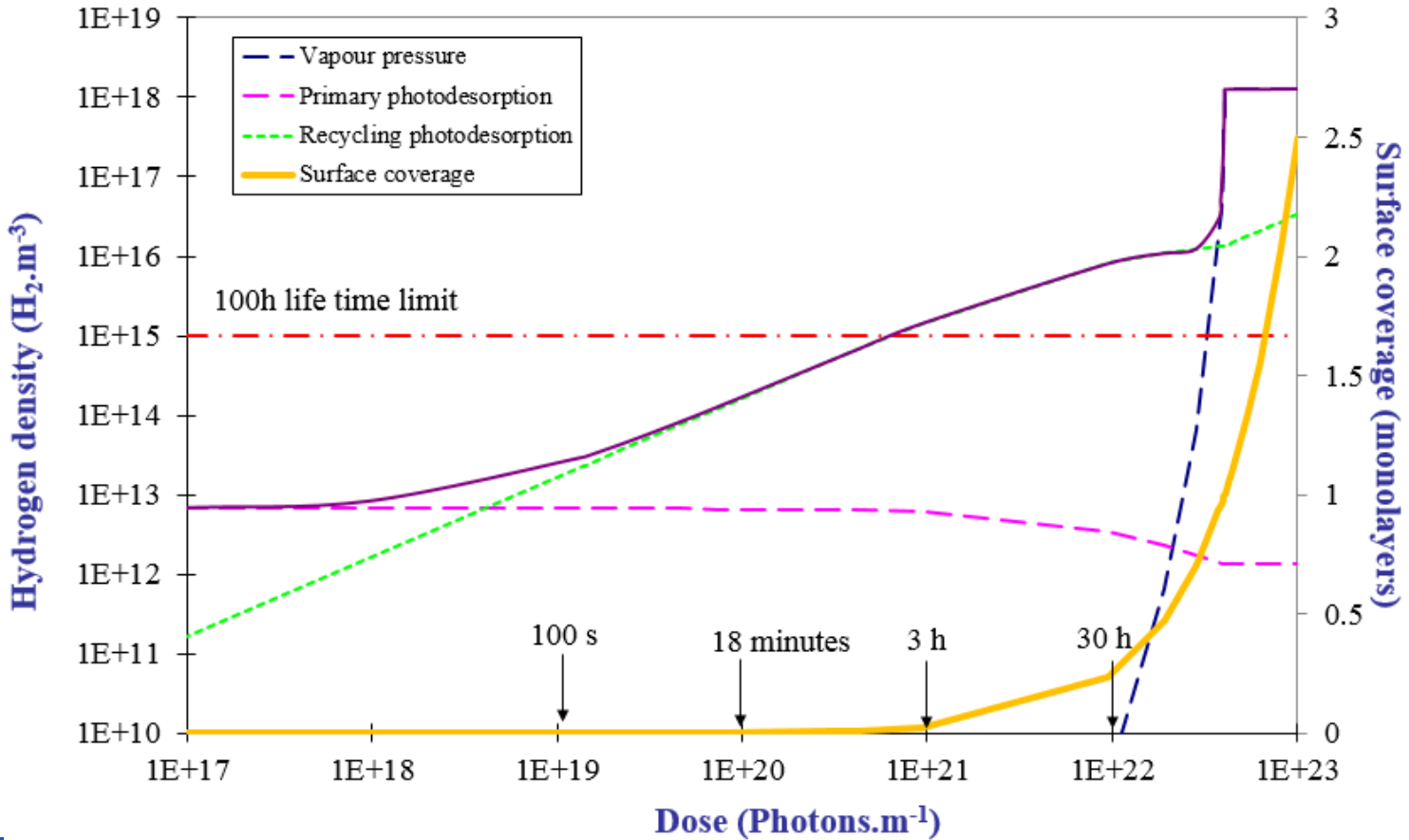

Perforated beam screen

- Infinitely long tube ($A_c D=0$), with a beam screen ($C=0$) and quasi static conditions:
 - The equilibrium pressure n_{eq} is defined by the perforation conductance

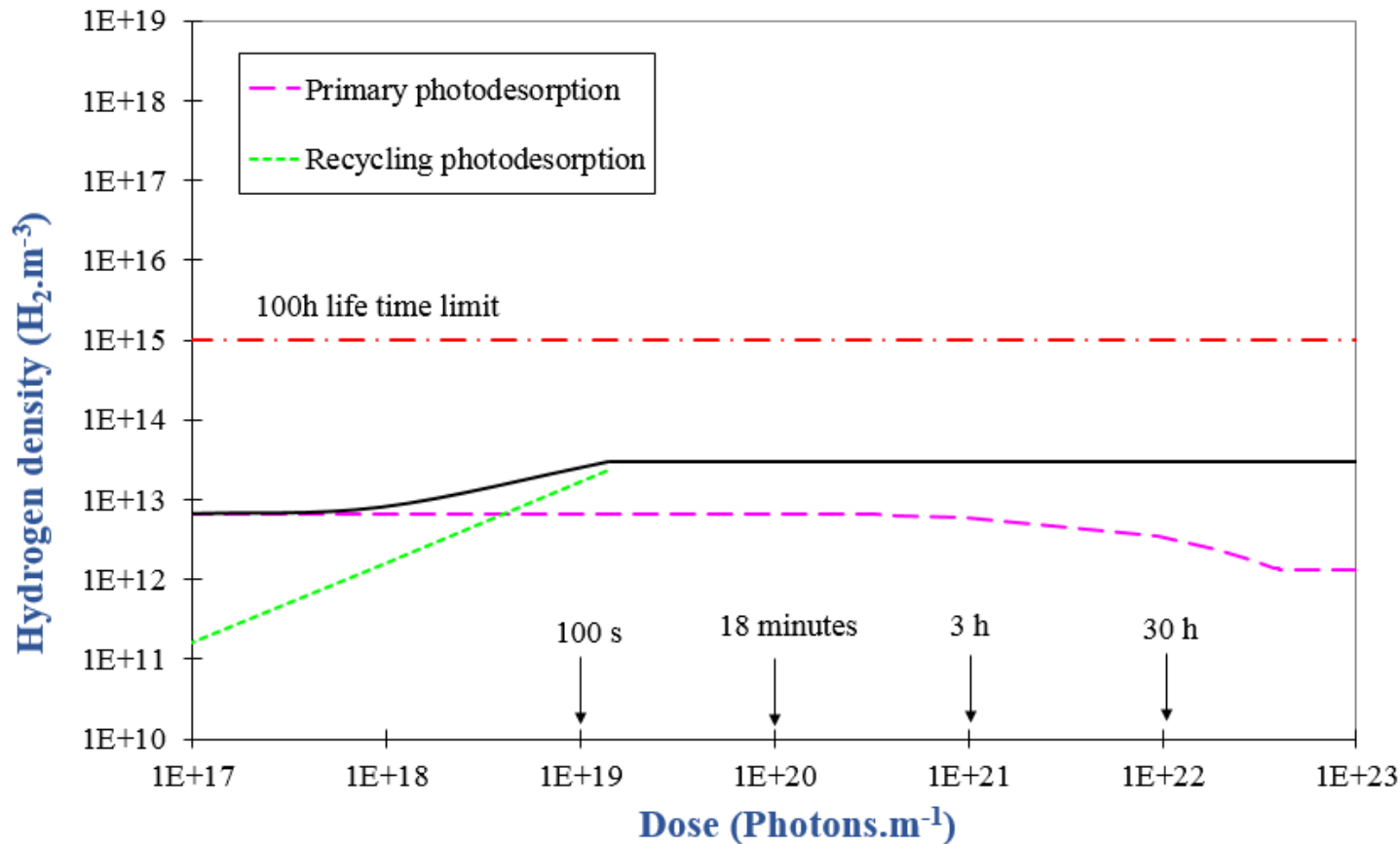

$$n_{eq} = \frac{\eta \dot{\Gamma}}{C}$$

A perforated beam screen allows to control the gas density

Perforated beam screen

- Infinitely long tube ($A_c D=0$), with a beam screen ($C=0$) and quasi static conditions:
 - The equilibrium coverage is a fraction of a monolayer

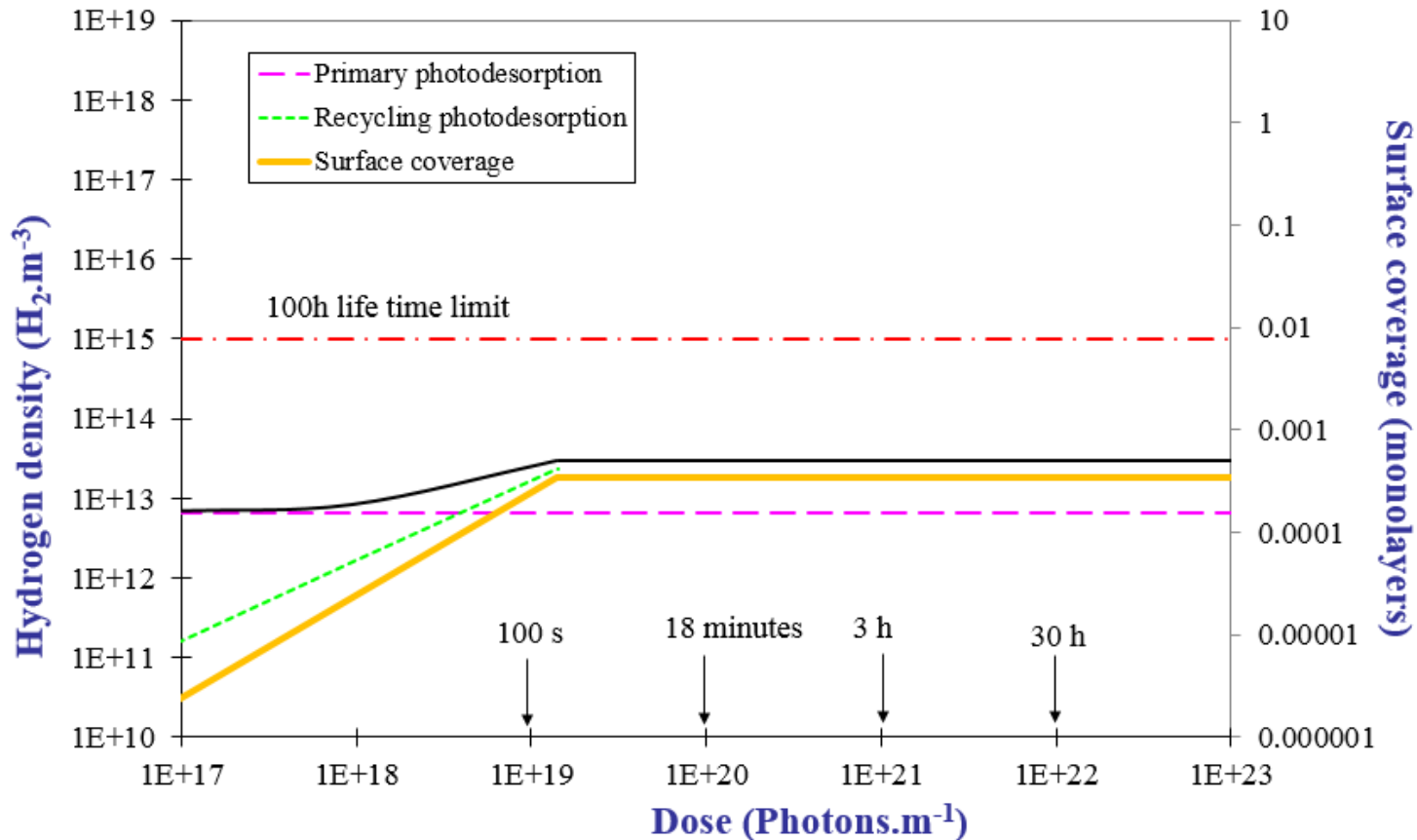

$$\theta_{eq} = \left(\frac{\sigma S}{C} \frac{\eta}{\eta_0} \right) \theta_m$$

A perforated beam screen allows to control the surface coverage

3.2 Arc Vacuum System

Cryogenic Beam Vacuum

2 independent beam pipes per arc:
8 arcs of 2.8 km each

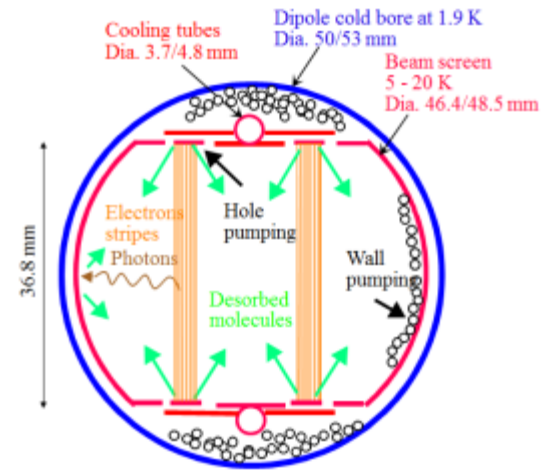
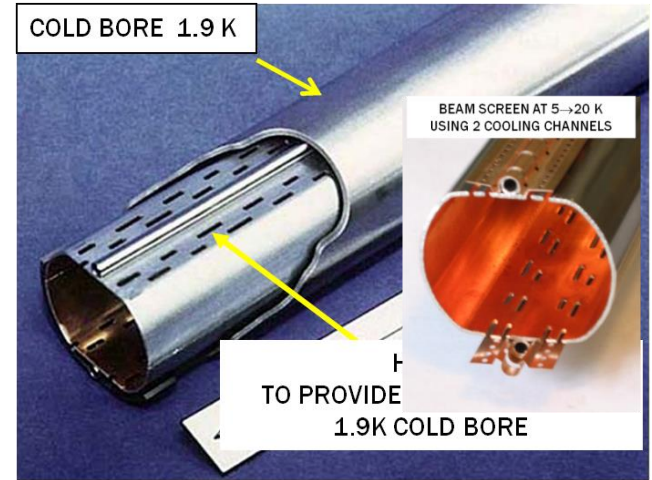
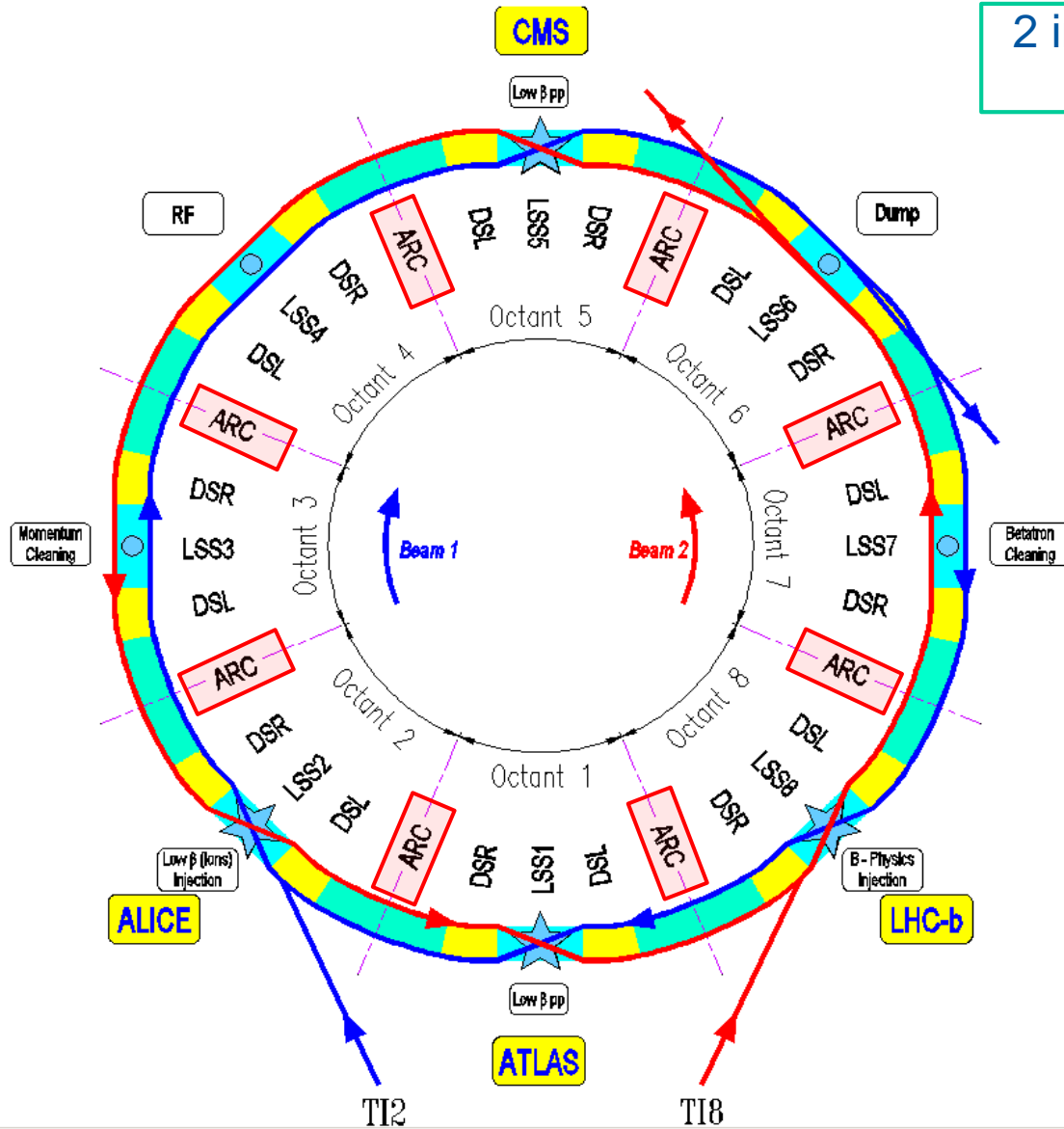

First Observation of Synchrotron Radiation: Aug-2010

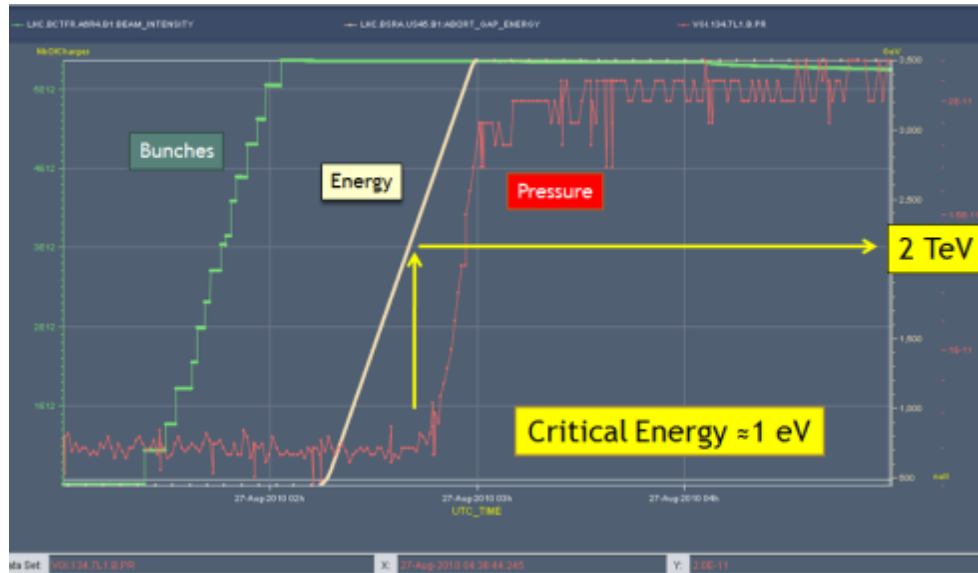

- Pressure rise during the beam energy ramp
- At E= 2 TeV, Critical energy 1 eV, pressure starts to rise

- Dynamic pressure increases with beam current
- $\Delta P = 2 \cdot 10^{-10}$ mbar

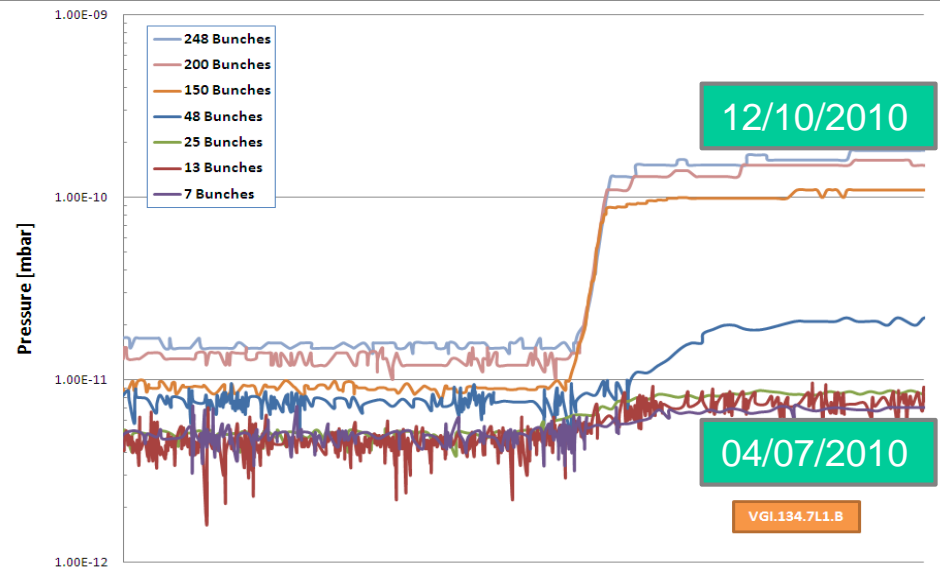

Beam conditioning in the LHC arcs

- Dynamic pressure reduction during LHC commissioning.

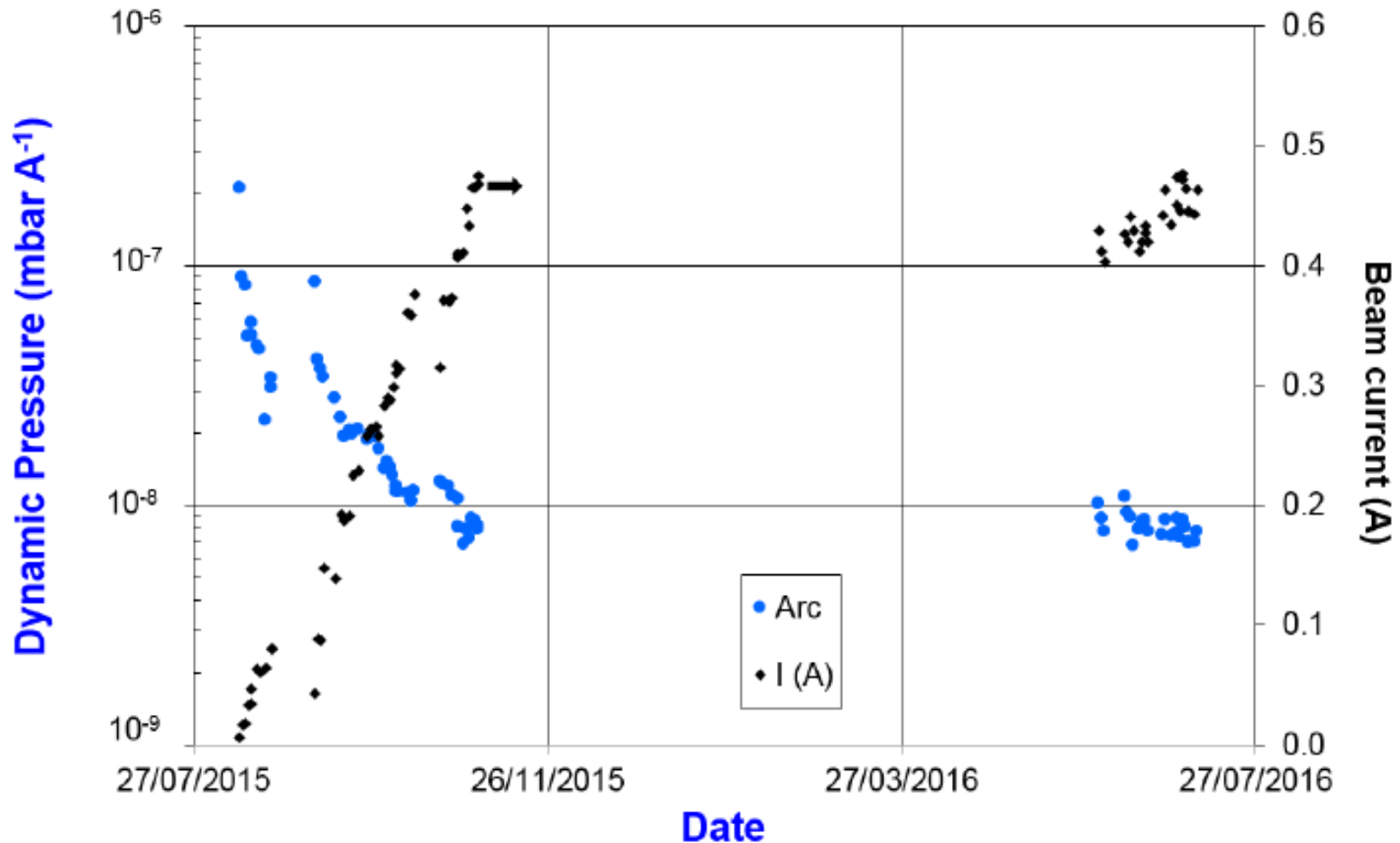

V. Baglin, Vacuum, 2016

3.3 RT Vacuum System

Room Temperature Beam Vacuum

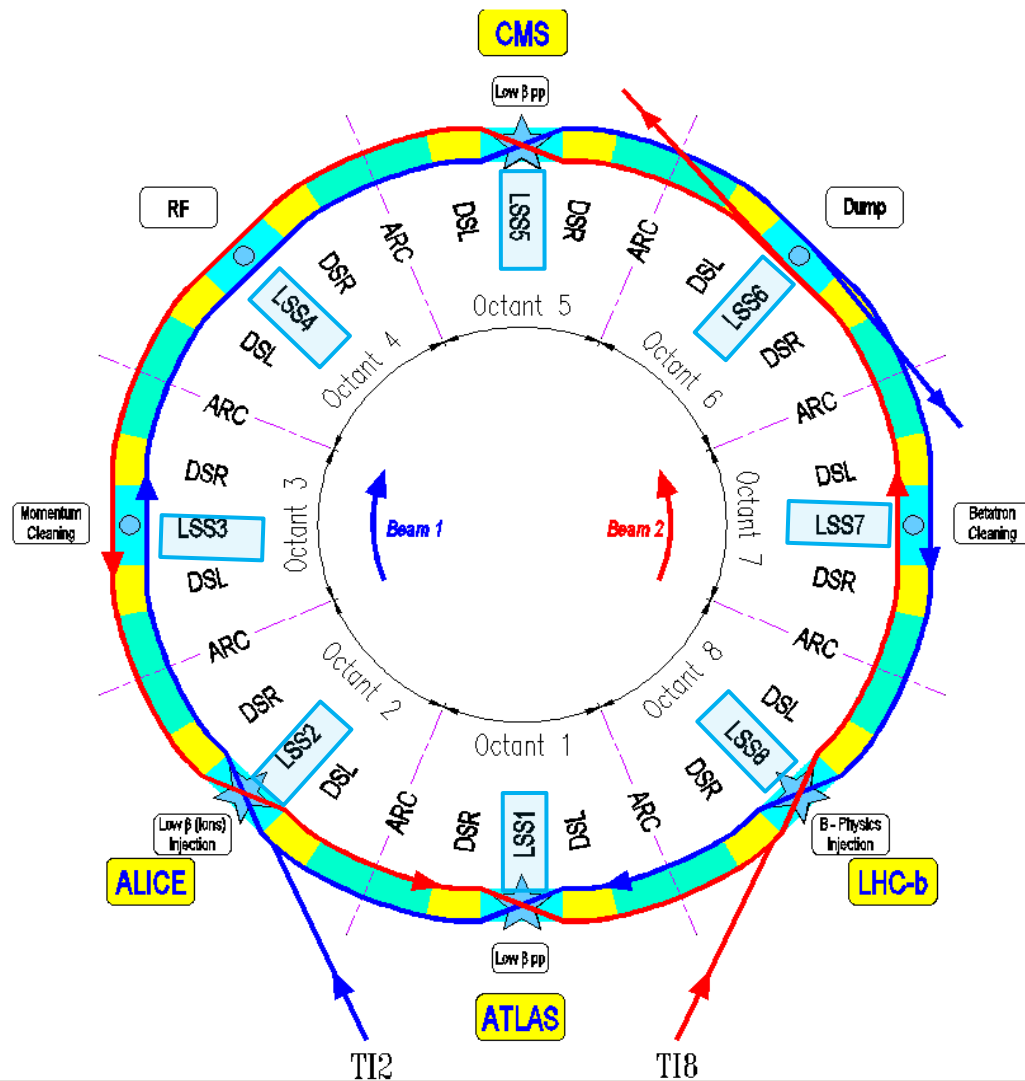

6 km of RT beam vacuum in the long straight sections

Extensive use of NEG coatings

Pressure $<10^{-11}$ mbar after vacuum activation

New System: NEG film coating

- Invention of low activation temperature getter film
=> **full** pumping across the beam pipe
- Some vacuum chambers were constructed and getter coated ...
- ~ 1 200 vacuum chambers produced

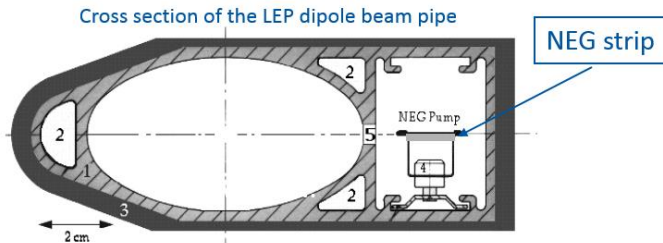

Cross section of an LHC warm dipole beam pipe

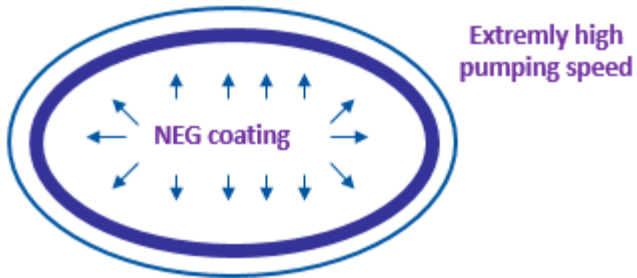

C. Benvenuti *et al.*



Courtesy R.Veness and P. Chiggiato

Room Temperature Vacuum System

- and installed inside the LHC tunnel
- to bring the separated beams from the arcs into a single beam pipe for the experiments (held at room temperature !)

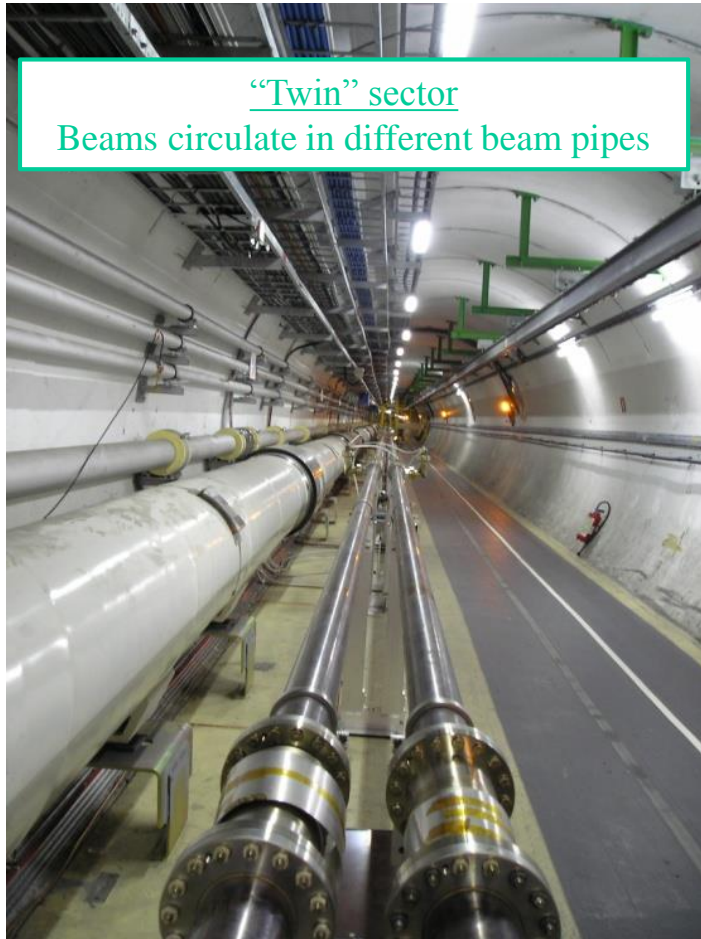

“Twin” sector
Beams circulate in different beam pipes

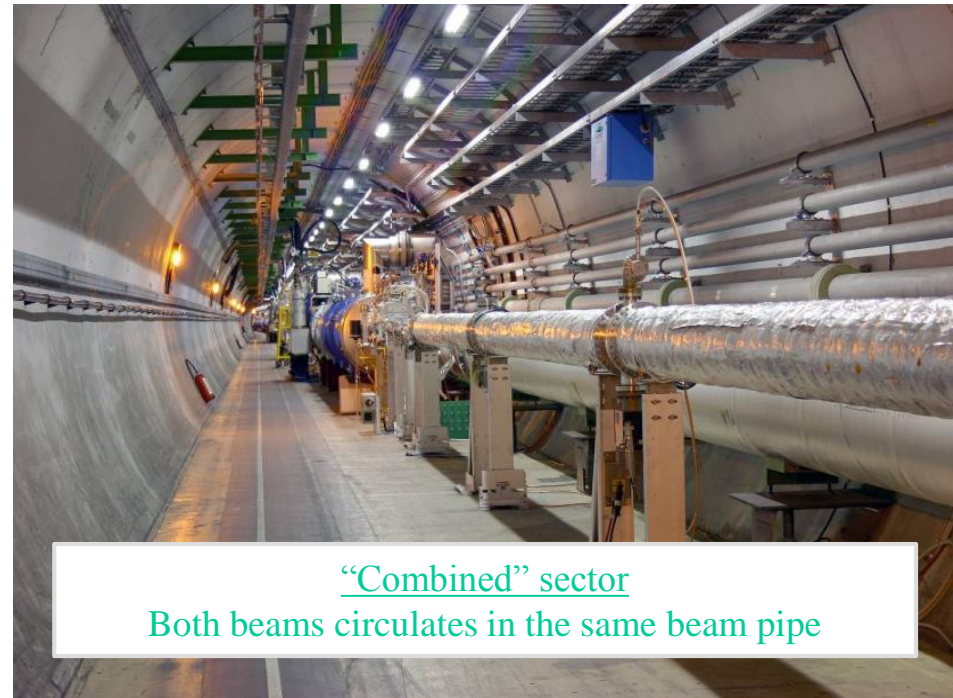

“Combined” sector
Both beams circulates in the same beam pipe

Room Temperature Vacuum Sectors

- 185 vacuum sectors at RT
- From 1 m till 150 m long
- Contains : kickers, septum, collimators, masks, beam instrumentation
- **Separation** of baked from cryogenic unbaked vacuum sectors

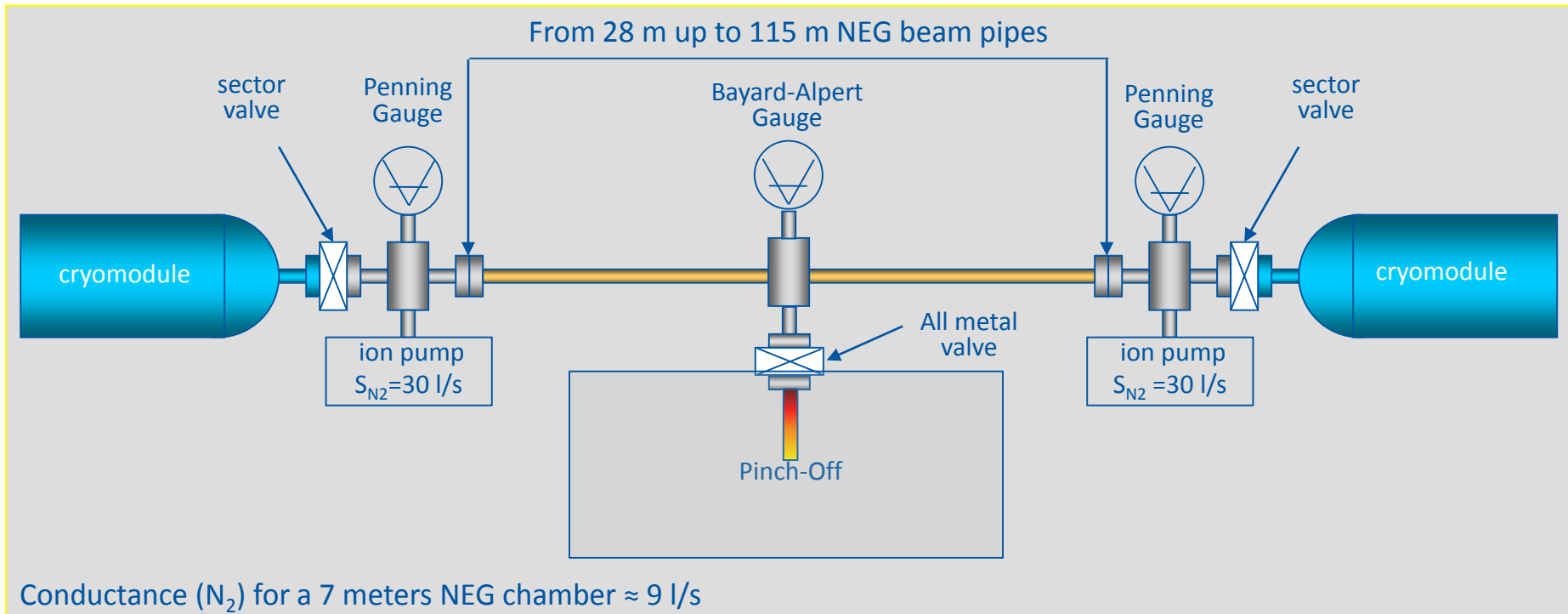

Room Temperature Vacuum Sectors

- 185 vacuum sectors at RT
- From 1 m till 150 m long
- Contains : kickers, septum, collimators, masks, beam instrumentation
- **Separation** of baked from cryogenic unbaked vacuum sectors

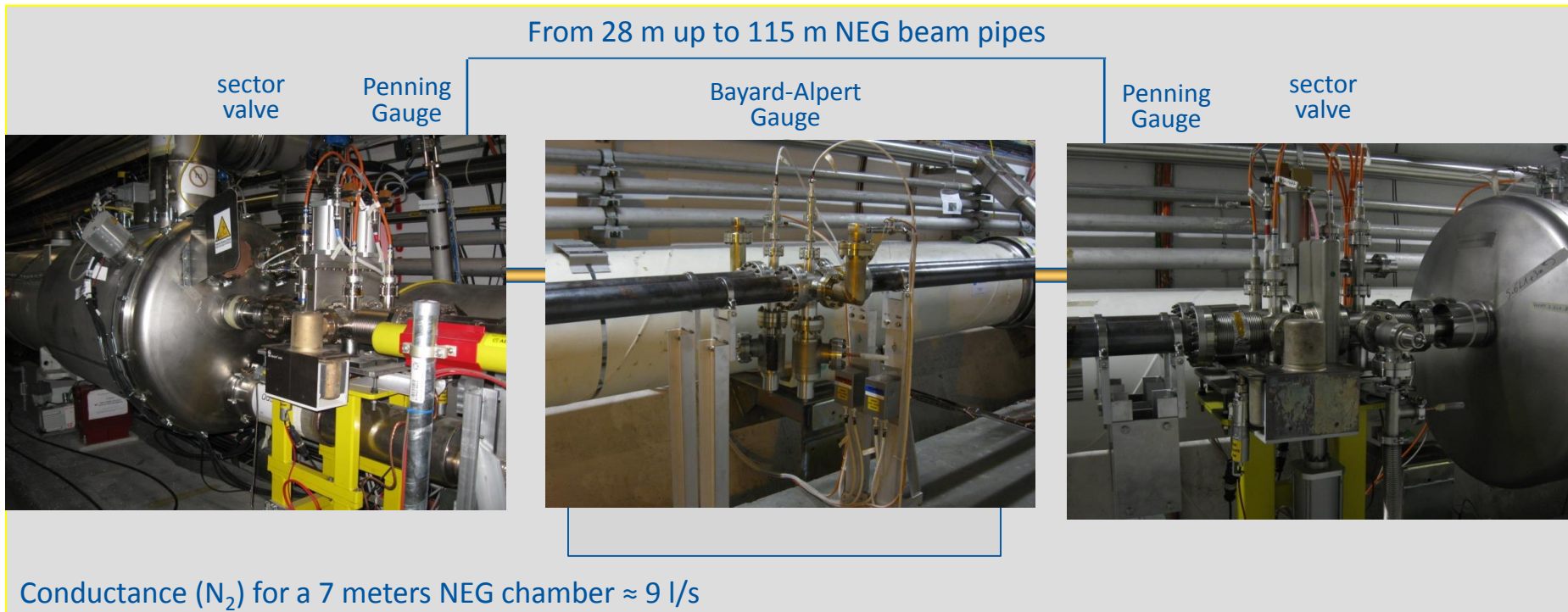

Principle of leak detection

- Detection method : He is sprayed around the test piece and a helium leak detector (i.e. a RGA tune to He signal) is connected to the device under test.

Design in LHC:

leak rate $< 10^{-9}$ mbar.l/s for a vacuum sector so
the leak rate per component $< 10^{-10}$ mbar.l/s

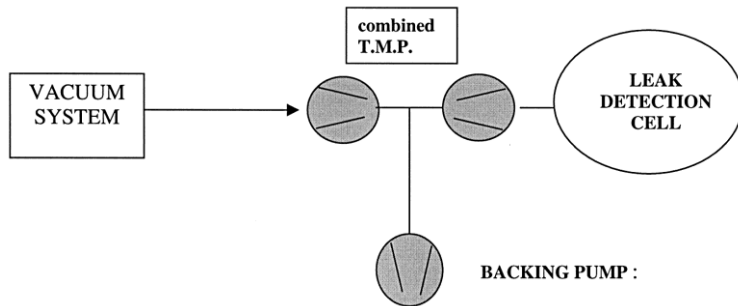

Counter flow method

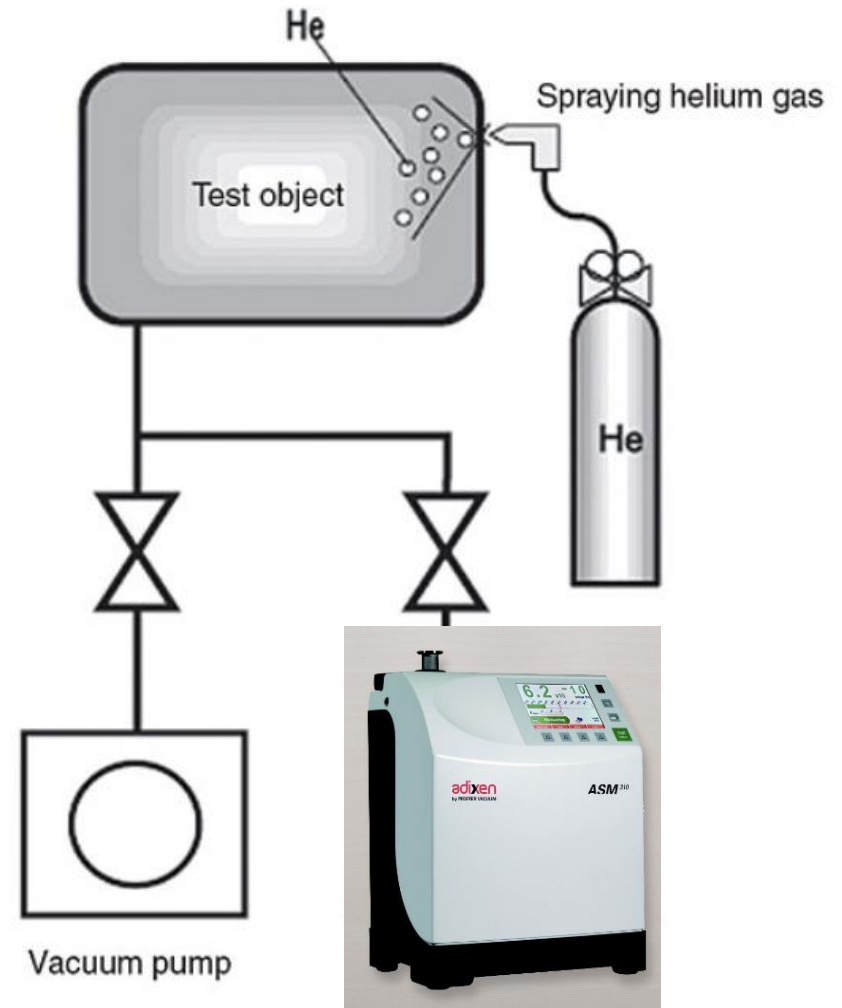

He leak detector

Commissioning of the NEG coated vacuum system

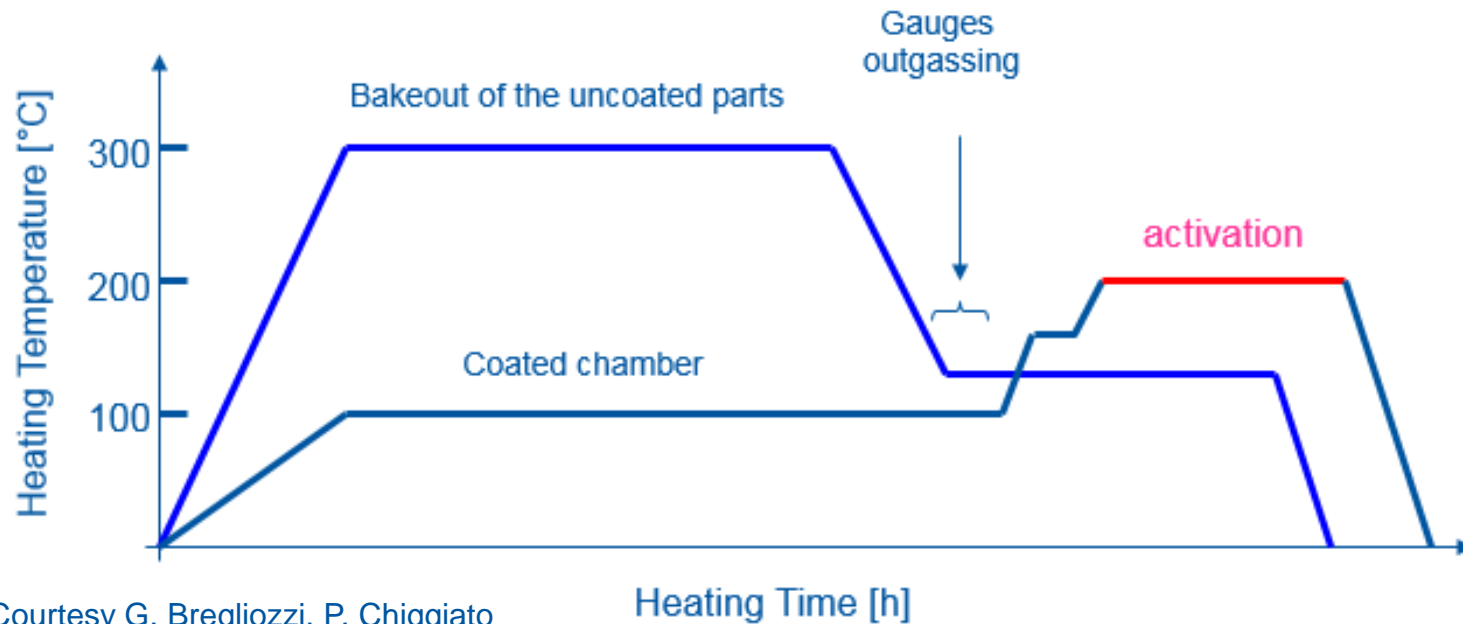

Courtesy G. Bregliozi, P. Chigiato

Heating Time [h]

- Bake out of stainless steel part first
- Followed by NEG activation at $\sim 200\text{ }^{\circ}\text{C}$
- **Acceptance criteria** rely on :
 - Temperature monitoring during activation
 - Aperture pumping speed measurement
 - Residual gas analysis
 - Leak rate below $\sim 10^{-9}$ mbar.l/s

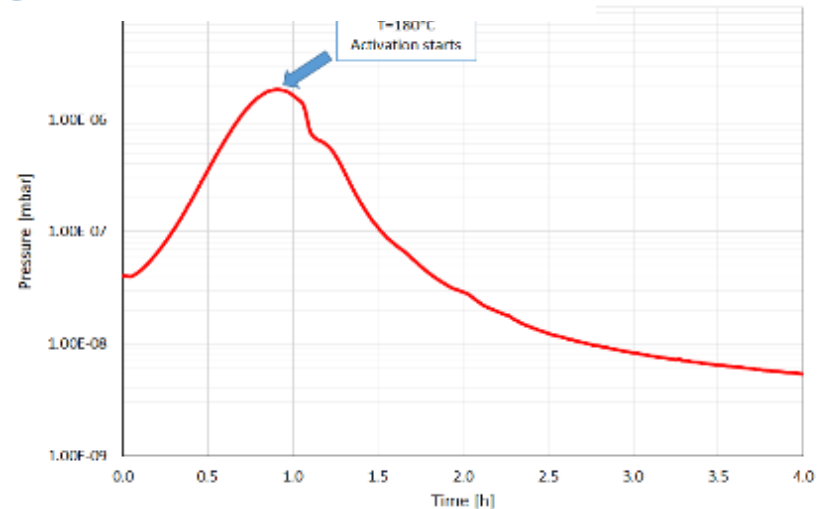

Courtesy G. Bregliozi, V. Bencini

Non-Evaporable Getter (NEG)

- Getters are materials capable of chemically adsorbing gas molecules. To do so their surface must be clean. For Non-Evaporable Getters a clean surface is obtained by **heating to a temperature high enough** to dissolve the native oxide layer into the bulk.

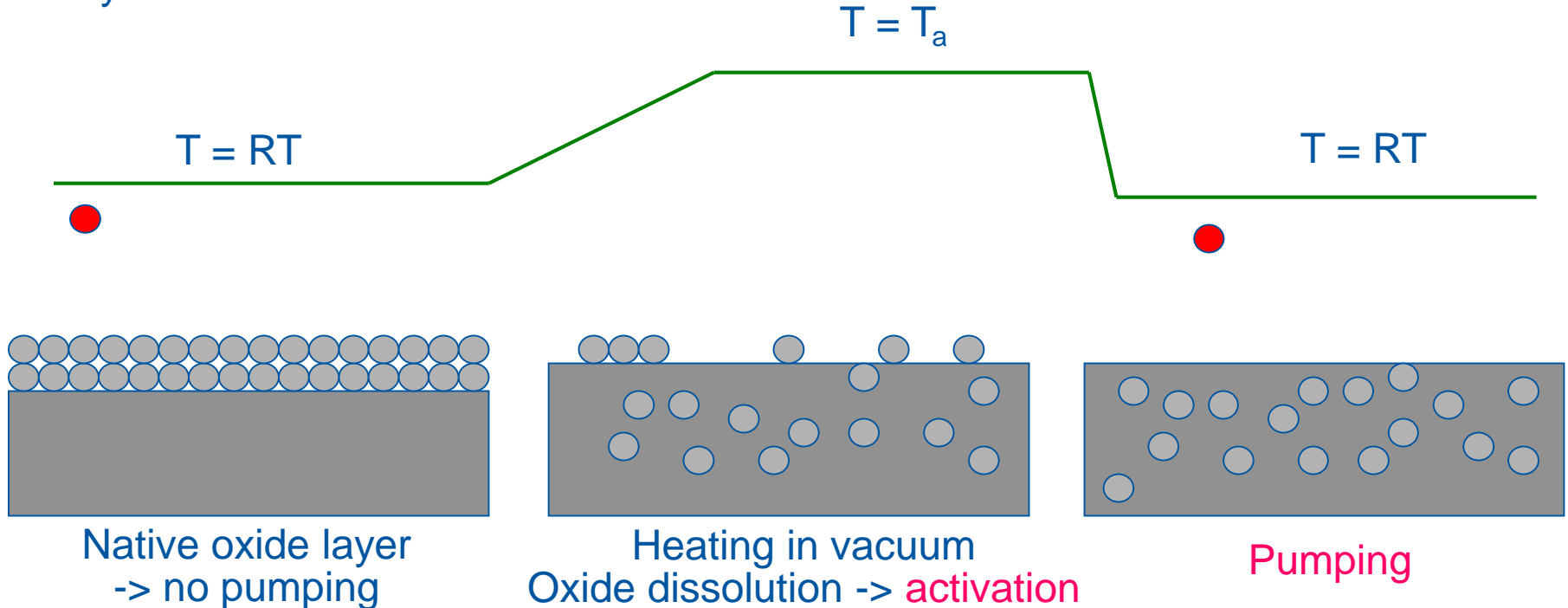

- NEGs pump most of the gas except rare gases and methane at room temperature

P. Chiggiato and P. Costa Pinto, Thin Solid Films, 515 (2006) 382-388

TiZrV Vacuum Performances

Pumping Speed

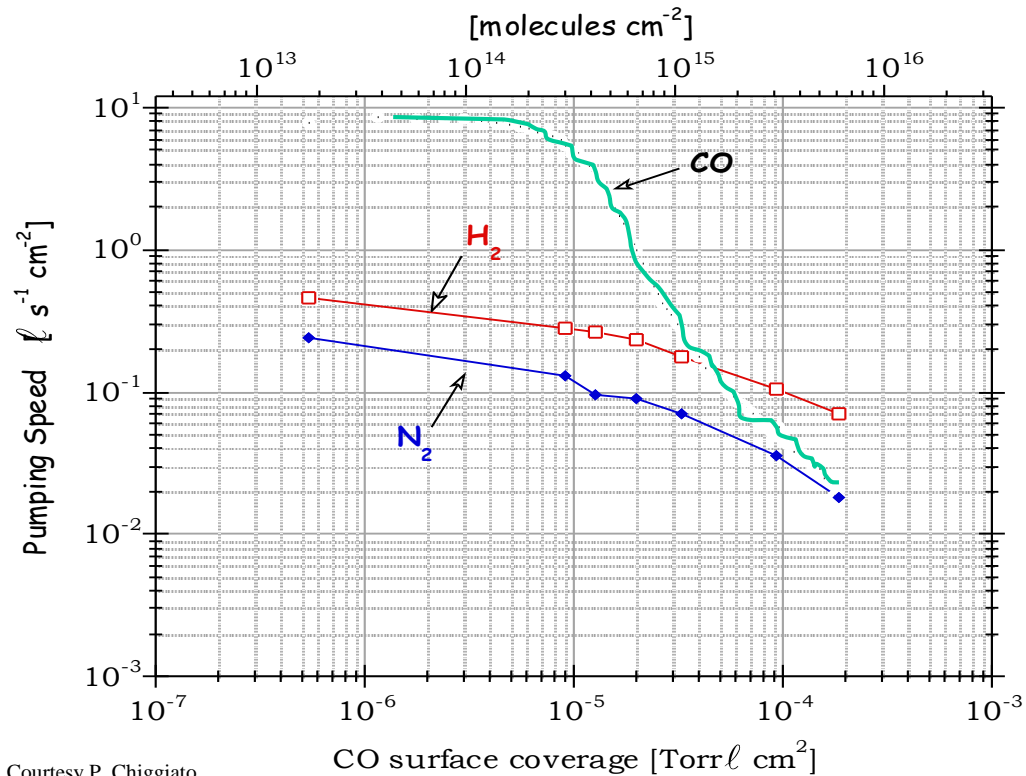

Courtesy P. Chiggiato

- Very large pumping speed : $\sim 250 \text{ l/s/m}$ for H_2 , $20\,000 \text{ l/s.m}$ for CO
- Very low outgassing rate
- **But** : limited capacity and fragile coating sensitive to pollutant (hydrocarbons, Fluor ...)

And of Course ... Through the LHC Experiments

CMS Ready to Close: Aug 2008

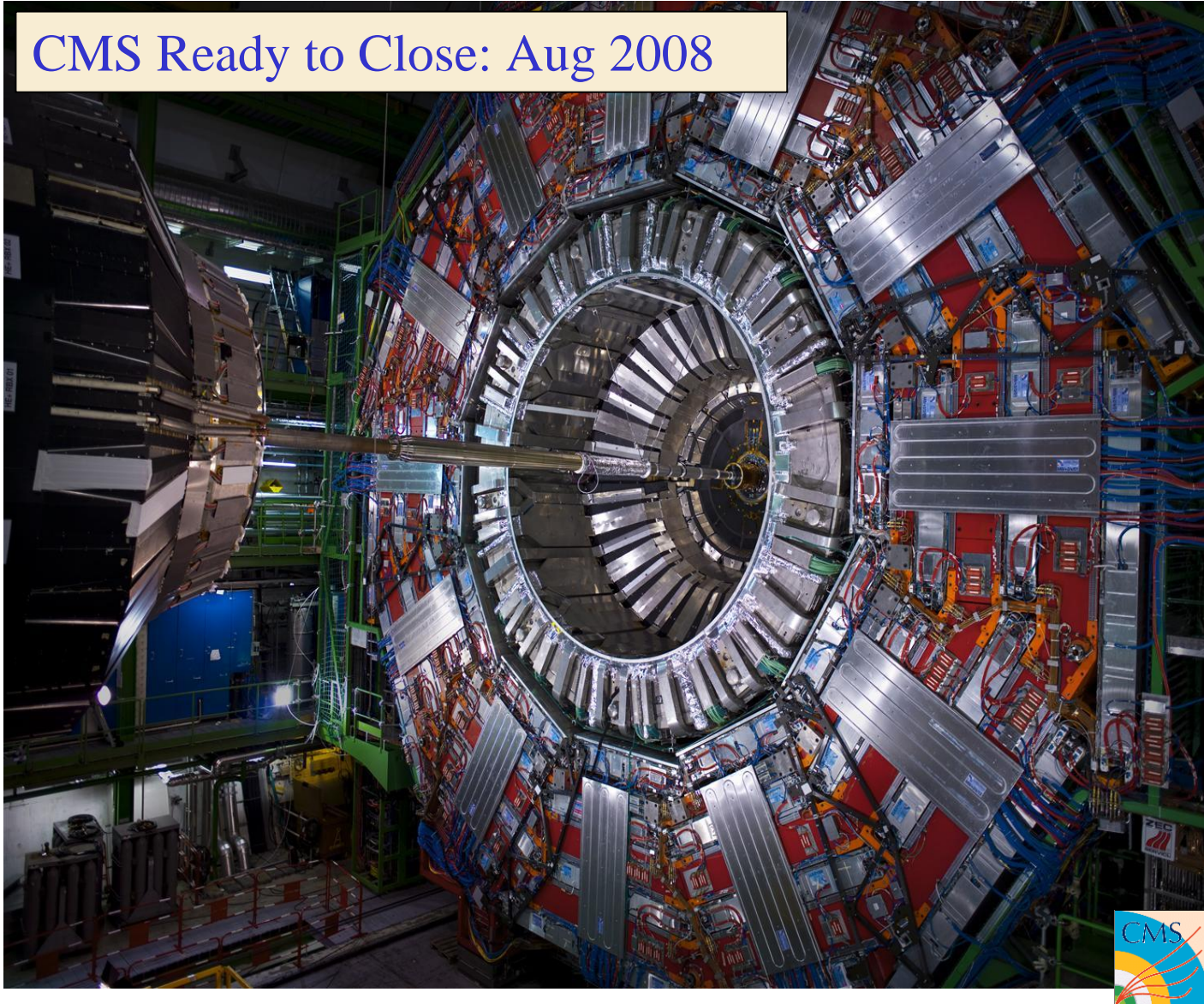

Beam Pipe Installation in ATLAS Before Closure



LHC Experimental Areas

- NEG coated vacuum system
=> Large pumping speeds, low SEY and desorption yields
- $\langle P_{\text{LHC Experiments}} \rangle \sim 5 \cdot 10^{-10}$ mbar => with 25 ns bunch spacing and 450 mA
=> No background issues: within specifications
- $\langle P_{\text{LHC Experiments}} \rangle$ with 50 ns beams
 - ~ $5 \cdot 10^{-10}$ mbar in 2011 at 375 mA
 - ~ $3 \cdot 10^{-11}$ mbar in 2012 at 400 mA
- $\langle P_{\text{LHC Experiments}} \rangle$ with 25 ns beams
 - ~ $5 \cdot 10^{-10}$ mbar in at 450 mA and 25 ns bunch spacing

2012: LHC Experiments Average Pressure with 50 ns Beam (IP only)

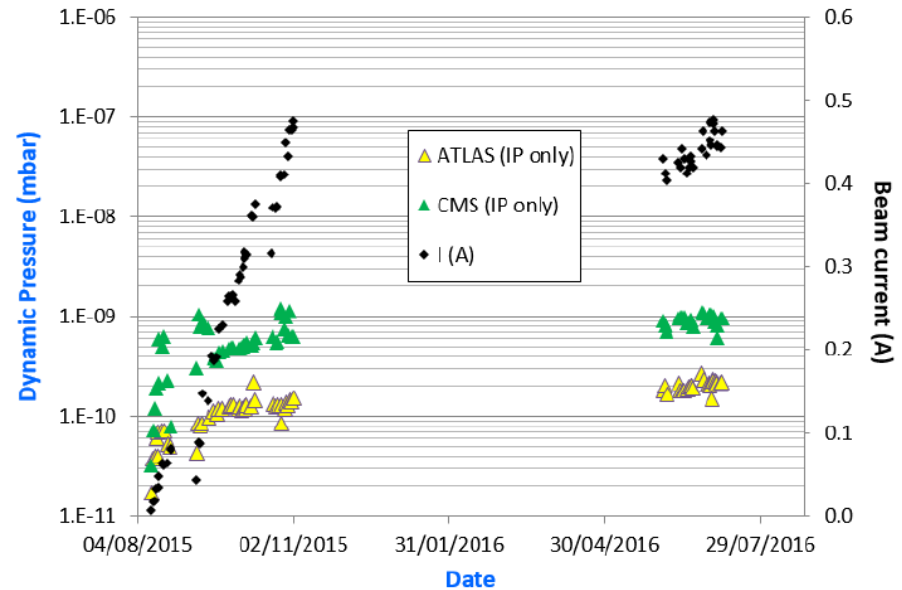
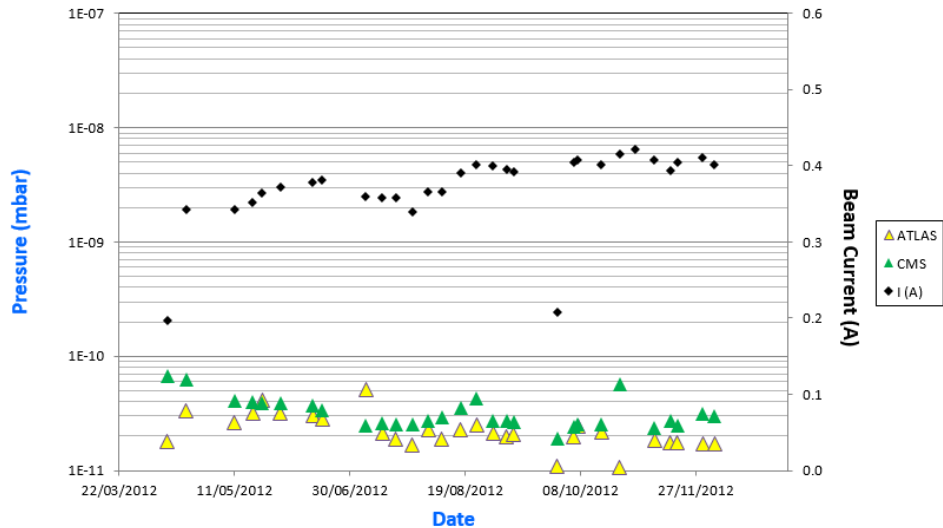

V. Baglin., Vacuum 138 (2017) 112-119

First Observation of Electron Cloud : 29-9-2010

- The position at 45 m from the IP is the **longest unbaked** area (operating at RT) in LHC, so the first candidate to trigger electron cloud
- Reduction of 1 order of magnitude when **solenoids** are ON

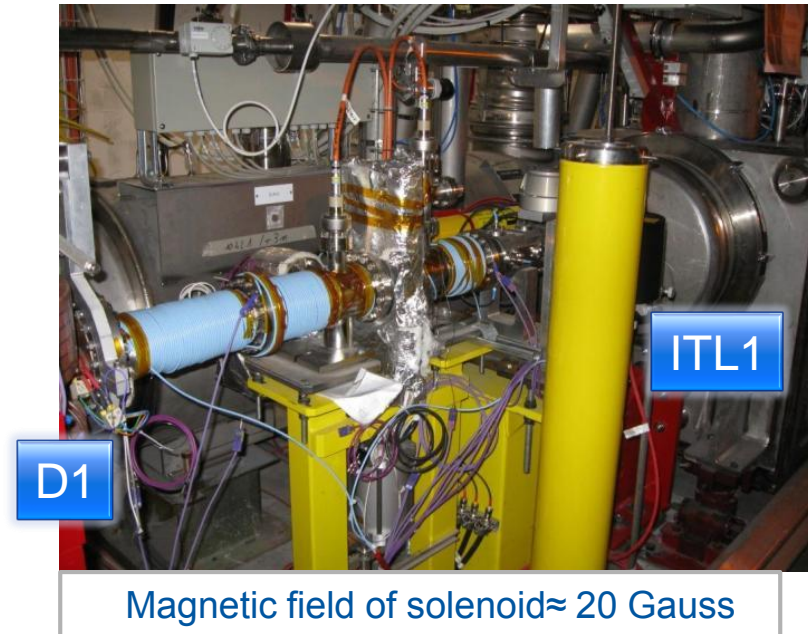
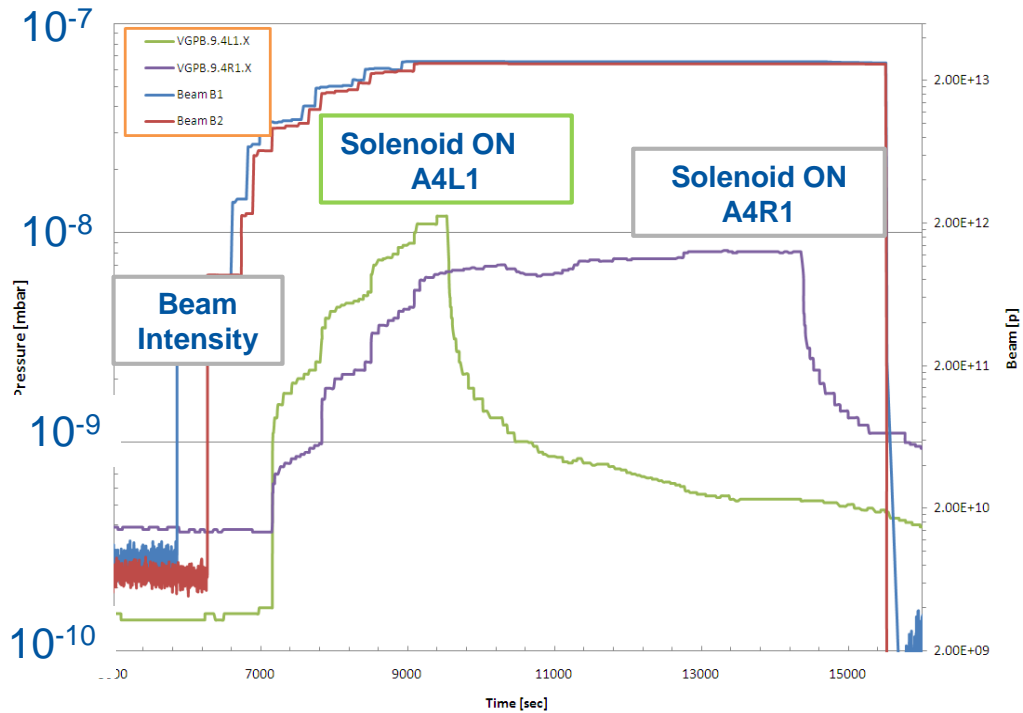

G. Bregliozzi *et al.*, IPAC San Sebastian, 2011

Appropriate mechanical design is vital

- Design extrapolated and not mechanically validated before installation in the ring
- **Pressure spikes** located beside inner triplets generated interlocks and background

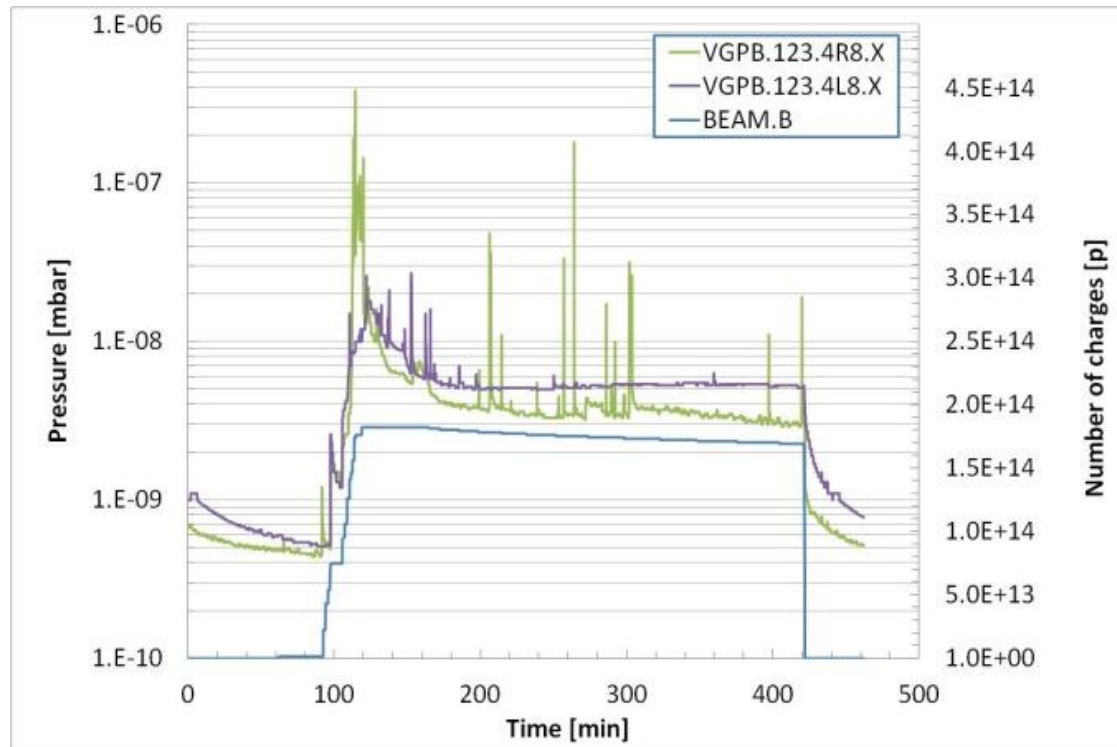

Observed Pressure spikes during a physics fill

Vacuum Modules or what can you do with beam heating

- X-rays done in May showed a conform module, in November the module was broken
- The RF bridge was destroyed by the beam !
- 8 out of a total of 20 in LHC were damaged i.e. 40 %

Typical default, DCUM 3259.3524

Left side

Side view (xray from corridor to QRL)

b) Metallic noise due to loose spring when hitting vacuum chamber

c) RF fingers falling due to broken spring

d) aperture reduced ?

Non Conform

Spring was broken between May and November 2011

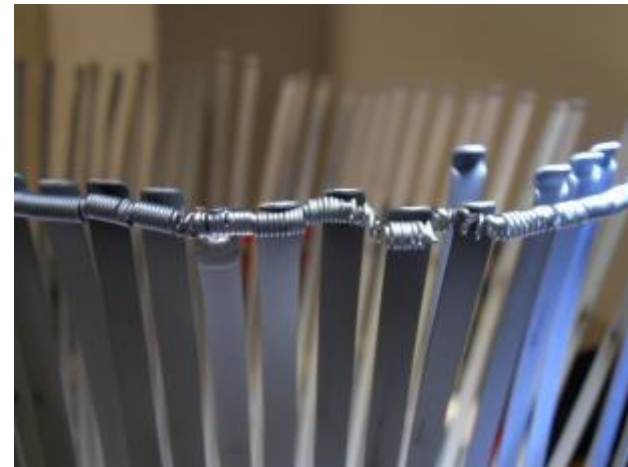
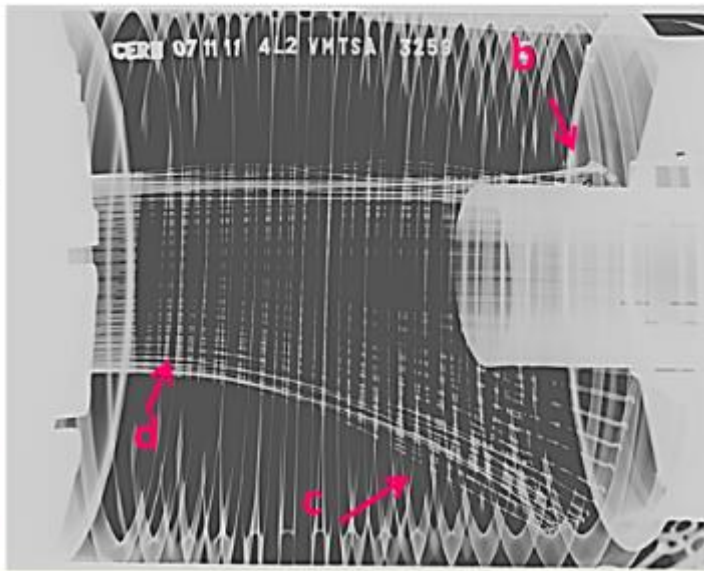



Typical default, DCUM 3259.3524

Left side:

- Side view (ray from corridor to DRL)
- if metallic noise due to loose spring when filling vacuum chamber
- if RF fingers filling due to broken coating
- if aperture reduces?

Fixes Confirmed

Spring was broken between May and November 2011

HOM induced RF finger deformation

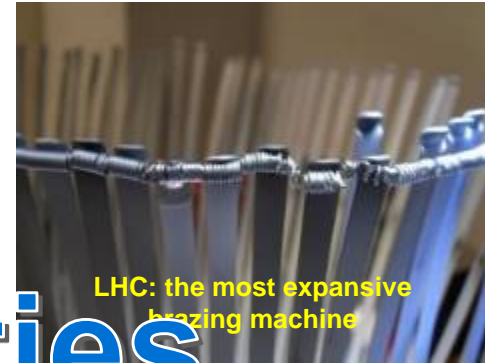

Many opportunities to do mistakes



Beam Screens with MLI and Fibers

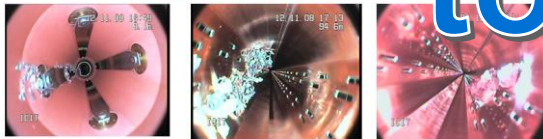

Sector 3-4 incident: soot and superinsulation debris along ~ 6 km !

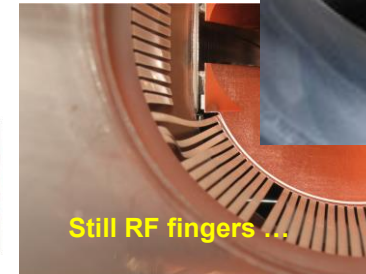

Fast Repair: Ne venting

- 5 days intervention
- Ne flow to reduce air back streaming
- This method avoids the NEG saturation (remember Ne is an inert gas).

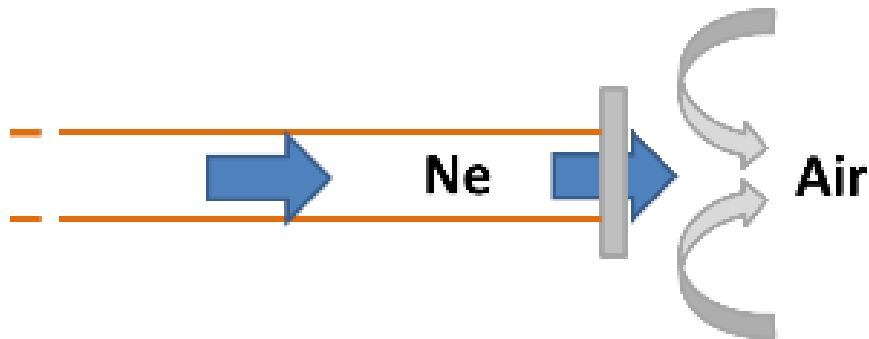

The new piece/chamber will need **conditioning** :
→ temporary local pressure rise when a new piece is installed



Neon trolley

Ne venting to save the 2012 CMS Run !

- Vacuum system performance recovered even following the dismantling of 2 m long vacuum chambers

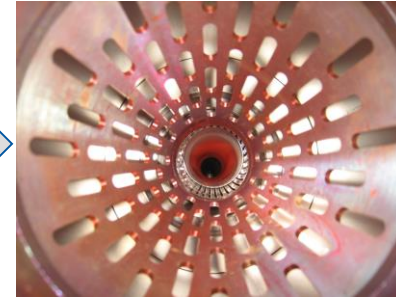
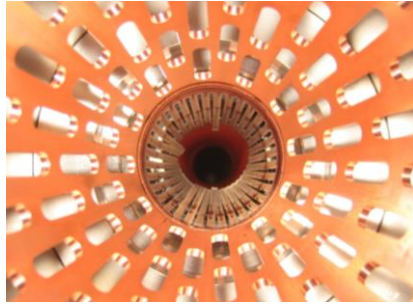

CMS

16 m & 18 m flanges were opened while Ne flushing

Forward chamber

Ne

Air

October 18th, 2012

3rd Vacuum Symposium UK



January 2012

4. Some studies related to LHC, HL-LHC, FCC etc. Vacuum systems

Laboratory

- Studies at **cryogenic temperature** down to 10 K
- Isotherm, TDS, sticking coefficient, beam induced desorption from electrons, ions etc.

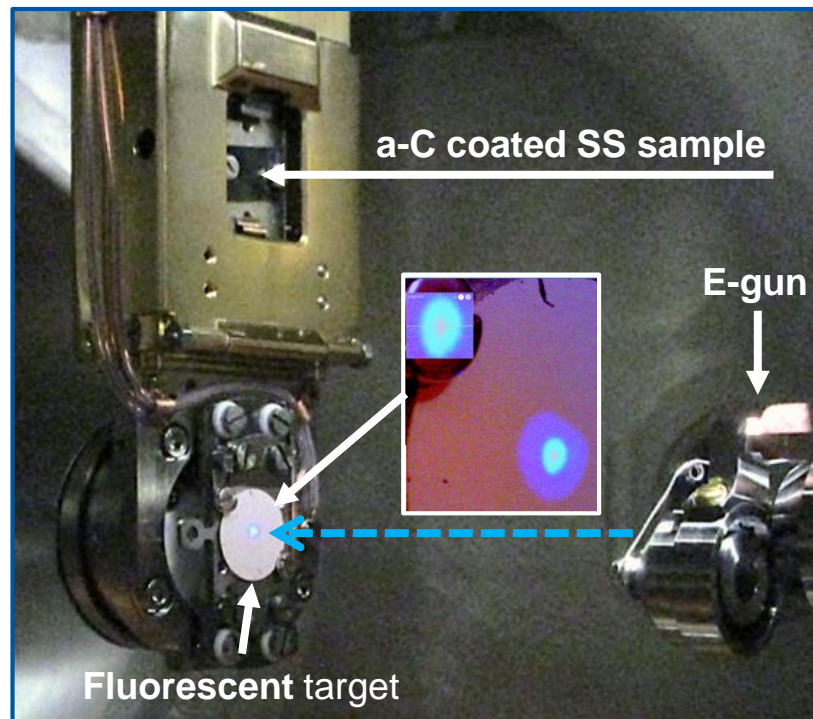
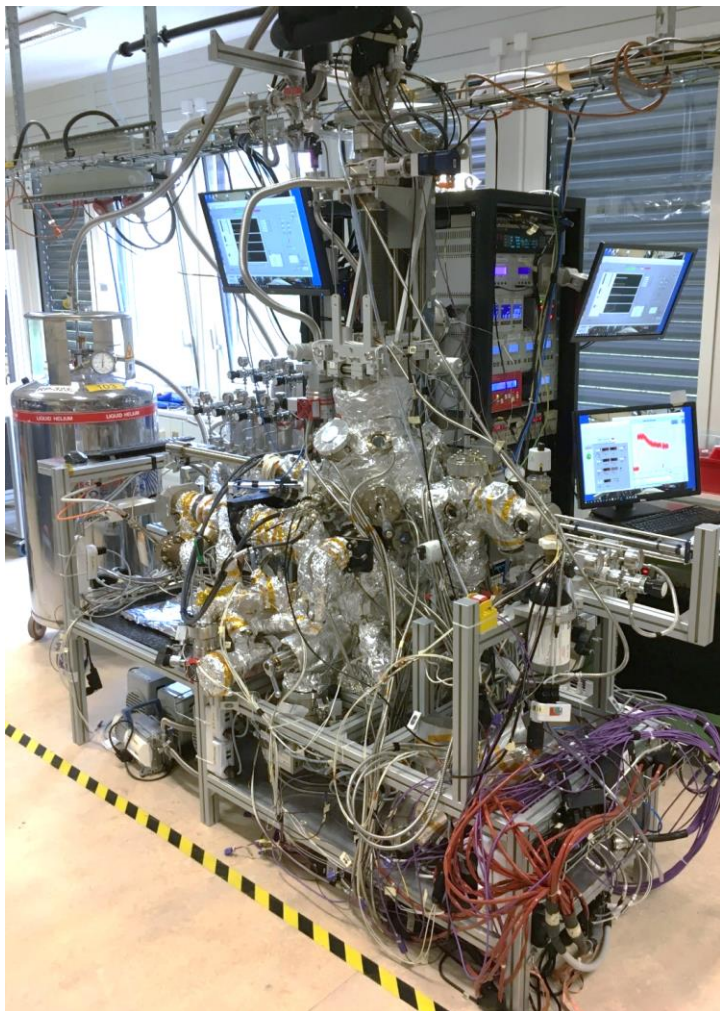

LHC Vacuum pilot sector

- Total and partial pressure, photoelectron current, electron cloud flux pick-ups, calorimetry etc. for **electron cloud** characterisation
- Liners can be modified : Cu, NEG, a-C coating, Laser Engineered Samples etc.

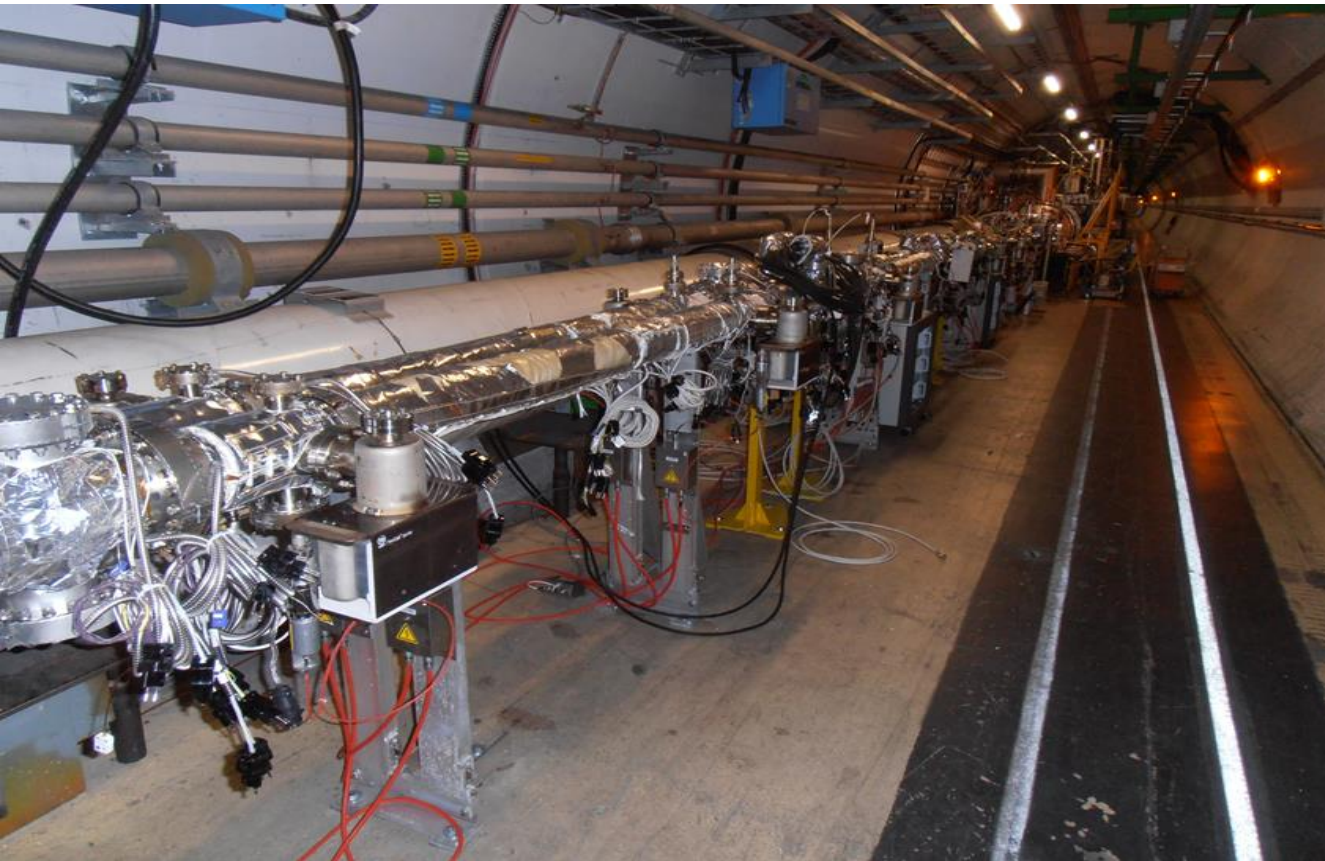

VQM



BA

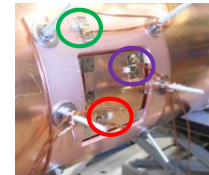

Heat load

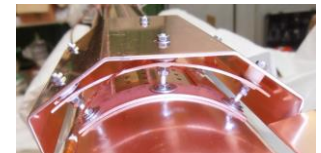

Electron collection

COLDEX: A Bench to Study Electron Cloud

- A system to simulate a LHC type vacuum system: perforated beam screen with cold bore
- BS ~ 5 to 100 K, CB ~ 3 to 5 K
- Pressure measurement, gas composition, calorimetric measurement, current measurement

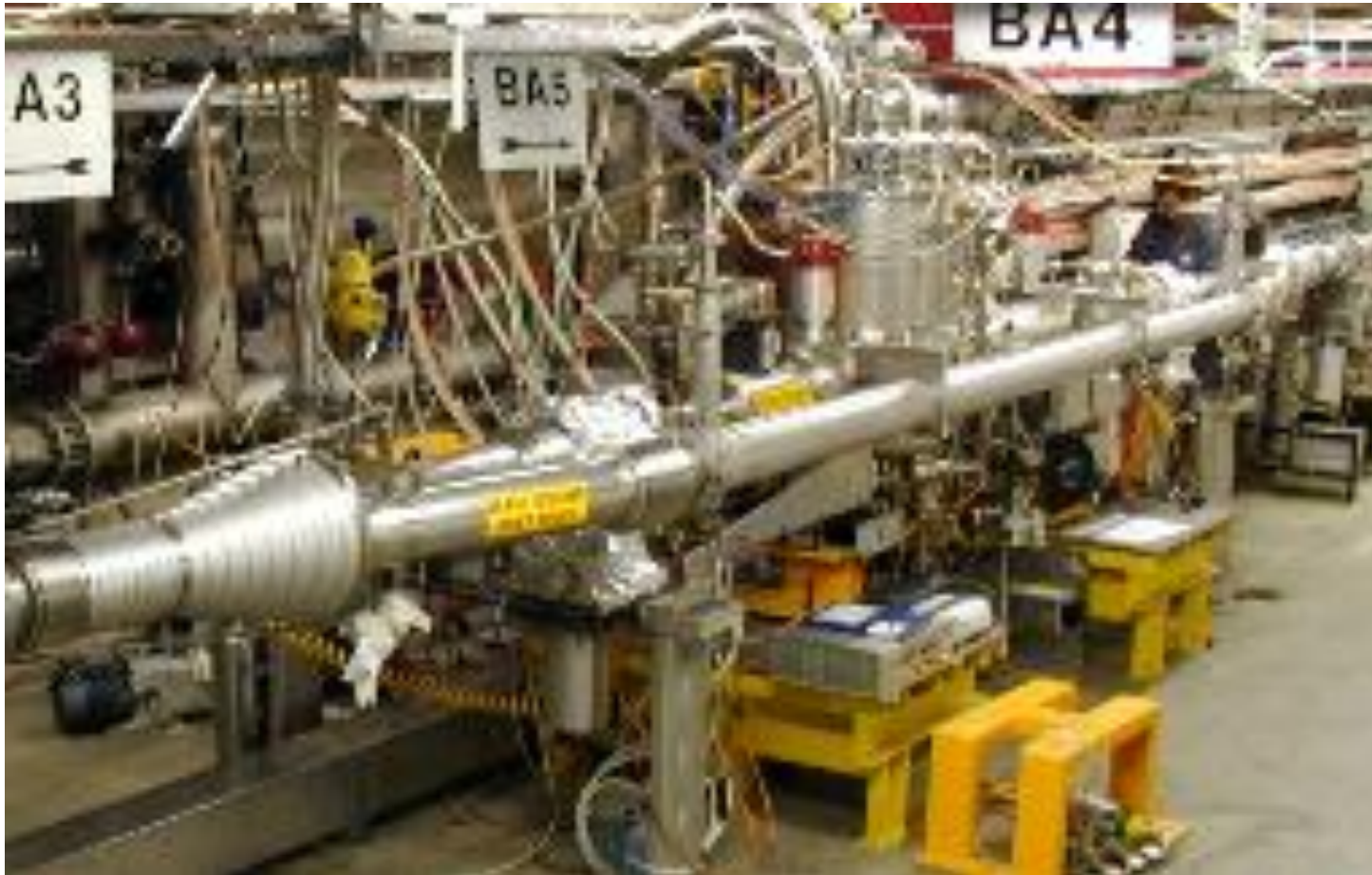

How LESS surfaces are behaving?

Lecture 5 summary

- The **vacuum life time** in an accelerator is driven by elastic & inelastic **interactions**
- Accelerator vacuum systems can be **modeled** by simple sets of equations
- Accurate pressure profiles can be **computed**
- Accelerators **operate as designed** but there is always room for **mistakes!**
- **Smart solutions** have to be developed for specific issues
- **Laboratory studies** are needed to properly design a machine

WE NEED YOU!

Some References

- Cern Accelerator School, Vacuum technology, CERN 99-05
- Cern Accelerator School, Vacuum in accelerators, CERN 2007-03
- Vacuum system design, A.G. Mathewson, CERN-94-01
- The physical basis of ultra-high vacuum, P.A. Redhead, J.P. Hobson, E.V. Kornelsen. AVS.
- Scientific foundations of vacuum technique, S. Dushman, J.M Lafferty. J. Wiley & sons. Elsevier Science.
- Vacuum Technology, A. Roth. Elsevier Science
- Handbook of accelerator physics and engineering, World Scientific, 2013
- Accelerators and Colliders, Springer, 2013
- Design and modelling of UHV systems of particle accelerators, Wiley, 2019

Some Journals Related to Vacuum Technology and Accelerators

- Journal of Vacuum Science and Technology
- Vacuum
- Applied Surface Science
- Nuclear Instruments and Methods in Physics Research
- Physical Review Accelerators and Beams

Thank you for your attention !!!



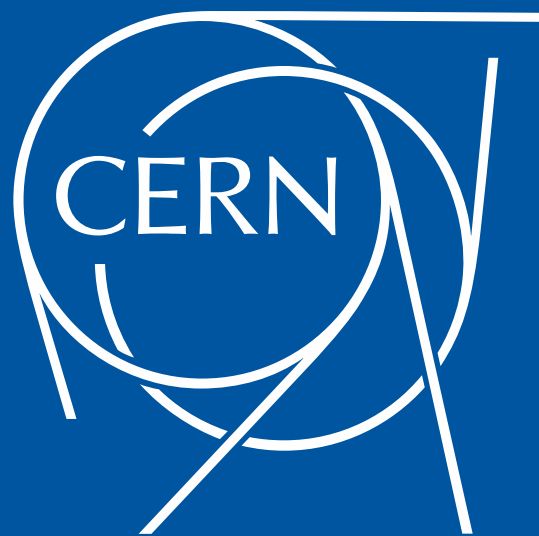

Complementary information



1. Beam-gas interactions

Proton storage ring

Complementary information

- A single Coulomb scattering event is due to the elastic scattering via electromagnetic forces of an incoming particle on a nuclei.

- Multiple Coulomb scattering** is due to the successive events of small angle scattering which leads to the gradual blow up of the beam emittance, ϵ and thus its dimension transverse σ .

$$\sigma = \sigma_0 e^{-\frac{t}{\tau_m}}$$

- The multiple scattering characteristic time, τ_m , is directly proportional to the beam momentum

$$\tau_m [hour] = 1.13 \cdot 10^{22} \frac{\epsilon}{G \langle \beta \rangle} \frac{p^2}{n} \propto \frac{p^2}{\gamma} \propto p$$

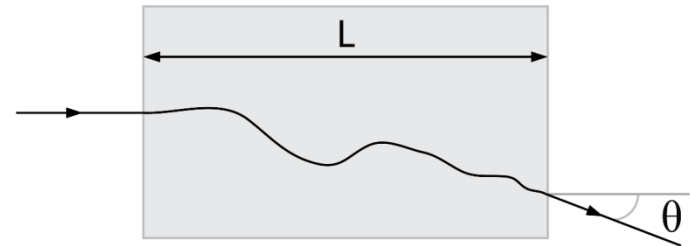

Comparison of Coulomb & nuclear scattering lifetimes

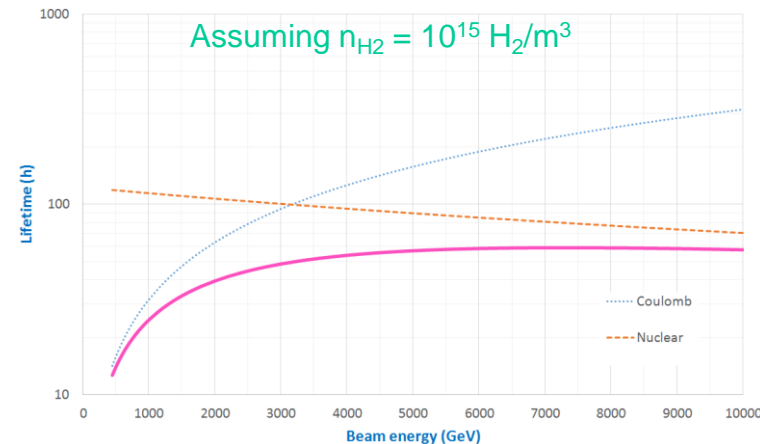

- With:
 - G the gas factor,
 - n the gas density (molecules/m³)
 - P the particle momentum (GeV/c)
 - $\langle \beta \rangle$ the average beta function (m)
 - $\epsilon = \epsilon_0/\gamma$ the beam emittance (m rad)

Gas	Mass	Gas Factor
H ₂	2	21.10
He	4	39.45
CH ₄	16	370.86
H ₂ O	18	593.10
CO	28	900.66
N ₂	28	884.60
O ₂	32	1144.00
Ar	40	2709.26
CO ₂	44	1472.66

- The **nuclear** cross section **dominates** above 3 TeV

Electron storage ring

Complementary information

- The beam life time depends on 4 scattering cross sections

$$\sigma = \sigma_1 + \sigma_2 + \sigma_3 + \sigma_4$$

$$\tau = \frac{1}{n \sigma c}$$

- Nuclear elastic scattering:

$$\sigma_1 = 1.305 \cdot 10^{-35} \frac{Z^2}{E^2} \left[\left(\frac{\langle \beta_H \rangle}{a} \right)^2 + \left(\frac{\langle \beta_V \rangle}{b} \right)^2 \right]$$

With:

σ_i cross section in m^2

Z atomic number (i.e. 6 for C)

E the beam energy (GeV)

a semi-horizontal chamber dimension (m)

b semi-vertical chamber dimension (m)

$\langle \beta \rangle$ Average beta in H and V plane (m)

$\epsilon_{RF} = \chi_{RF} E$ is the maximum allowable energy spread in the RF ($\chi_{RF} \ll 1$)

- Nuclear inelastic scattering:

$$\sigma_2 = 3.09 \cdot 10^{-31} Z^2 \ln \left(\frac{183}{Z^{1/3}} \right) \left[\ln \left(\frac{1}{\chi_{RF}} \right) - \frac{5}{8} \right]$$

- Elastic scattering from electrons surrounding the nucleus of the residual gas:

$$\sigma_3 = 2.55 \cdot 10^{-32} \frac{Z}{\chi_{RF} E}$$

- Inelastic scattering from electrons surrounding the nucleus of the residual gas:

$$\sigma_4 = 3.09 \cdot 10^{-31} Z \left[\ln \left(\frac{4.89 \cdot 10^3 E}{\chi_{RF}} \right) - 1.4 \right] \left[\ln \left(\frac{1}{\chi_{RF}} \right) - \frac{5}{8} \right]$$

3. The LHC case

3.1 Design

	LHC Current Parameters						Complementary information	
	Design		Commissioning					
	Nominal	Ultimate	2010	2011 (Fill 2256)	2012 (Fill 3250)	2015 (Fill 4569)		2016 (Fill 5045)
Energy [TeV]	7		3.5	3.5	4	6.5	6.5	
Luminosity [$\times 10^{34} \text{ cm}^{-2} \cdot \text{s}^{-1}$]	1.0	2.3	0.02	0.36	0.75	0.6	1.0	
Int. Luminosity [$\text{fb}^{-1}/\text{year}$]	80	120	0.0	5.9	23.3	4.2	16	
Current [mA]	584	860	80	362	420	468	447	
Proton per bunch [$\times 10^{11}$]	1.15	1.7	1.2	1.45	1.6	1.15	1.19	
Number of bunches	2808		368	1380	1378	2244	2076	
Bunch spacing [ns]	25		150 (75-50)*	50 (25)*	50 (25)*	25	25	
Normalised emittance [$\mu\text{m} \cdot \text{rad}$]	3.75		~ 3	~ 2.3	~ 2.2	~ 3	~ 3	
β^* [m]	0.55		3.5	1	0.6	0.8	0.4	
Total crossing angle [μrad]	285		240	240	290	290	185	
Critical energy [eV]	44.1		5.5		8.2	35.3	35.3	
Photon flux [ph/m/s]	$1 \cdot 10^{17}$	$1.5 \cdot 10^{17}$	$0.06 \cdot 10^{17}$	$0.3 \cdot 10^{17}$	$0.4 \cdot 10^{17}$	$0.8 \cdot 10^{17}$	$0.8 \cdot 10^{17}$	
SR power [W/m]	0.22	0.33	0.002	0.01	0.02	0.13	0.13	
Photon dose [ph/m/year]	$1 \cdot 10^{24}$	$1.5 \cdot 10^{24}$	$1 \cdot 10^{21}$	$0.1 \cdot 10^{24}$	$0.3 \cdot 10^{24}$	$0.1 \cdot 10^{24}$	$0.2 \cdot 10^{24}$	
Beam dose per year [A.h]	2800 MD per year	4100	3	314	569	126	255	

Fit to measured data at 10 K with 194 eV crit. energy

Complementary information

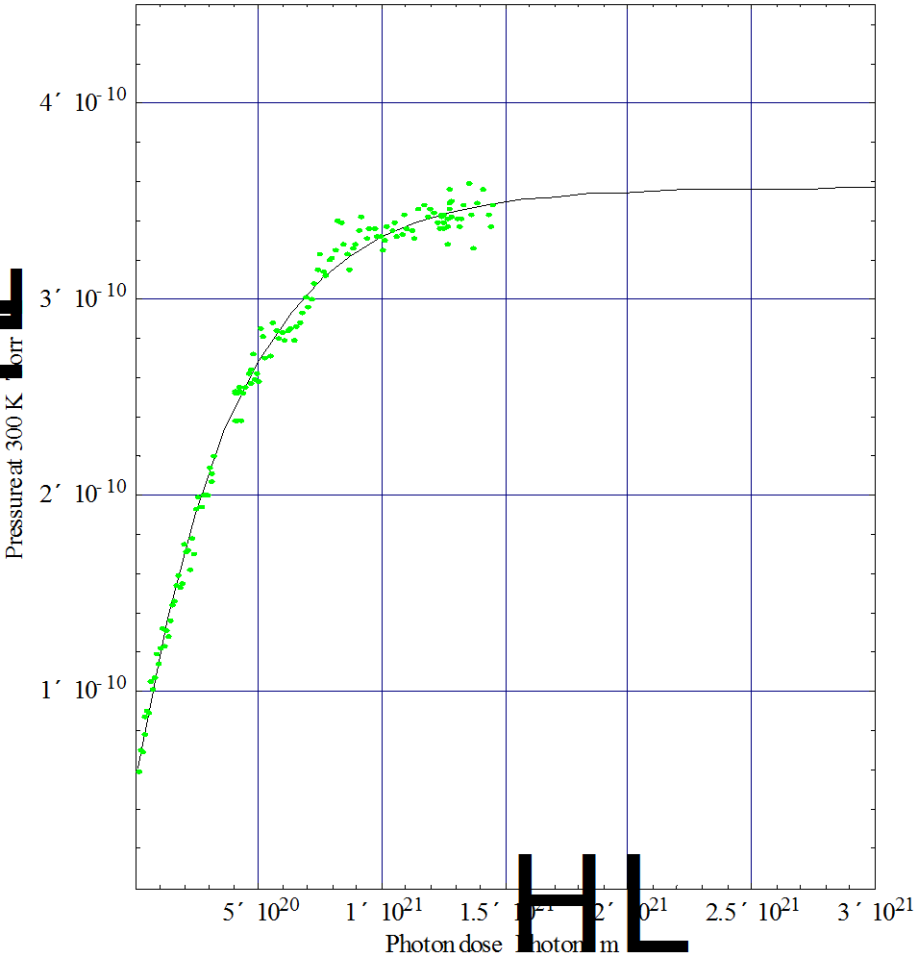

$$\eta = 2.6 \cdot 10^{-4} \text{ H}_2/\text{ph}$$

$$\eta' = 0.08 \text{ H}_2/\text{ph/monolayer}$$

$$\sigma = 0.08$$

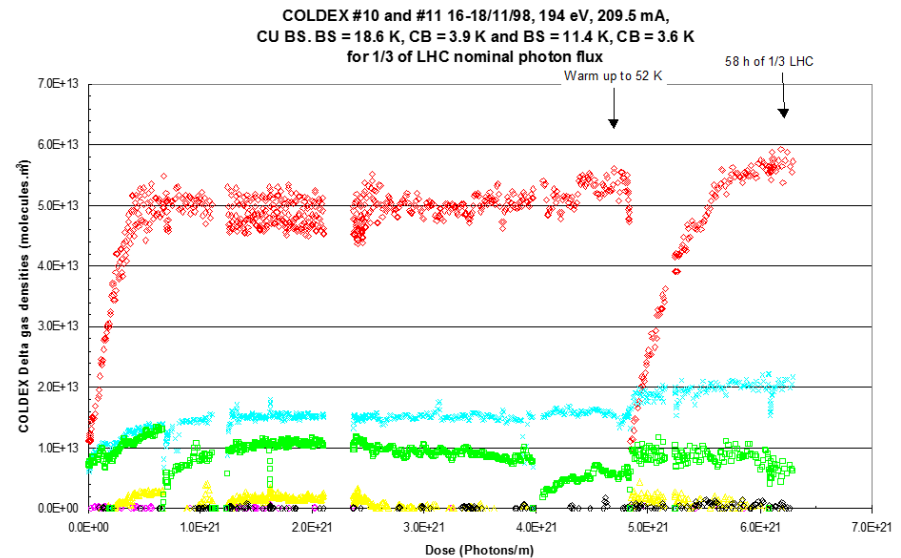

3.2 Arc Vacuum System

Arc : Some Numbers

Complementary
information

Item	Total
Vacuum sectors (cryogenic)	16
Vacuum sector valves	32
Roughing valves (arc)	844
Ion pumps	0
Bayard Alpert gauges	0
Penning gauges (arc)	108
Pirani gauges	108

Item	Length (m)
Unbaked Arc @ cryo T	~ 45 000

Beam Conditioning under SR

Complementary information

- Arc extremity's vacuum gauges : unbaked Cu and cryogenic beam screen
- Reduction by **2 orders of magnitude** since October 2010

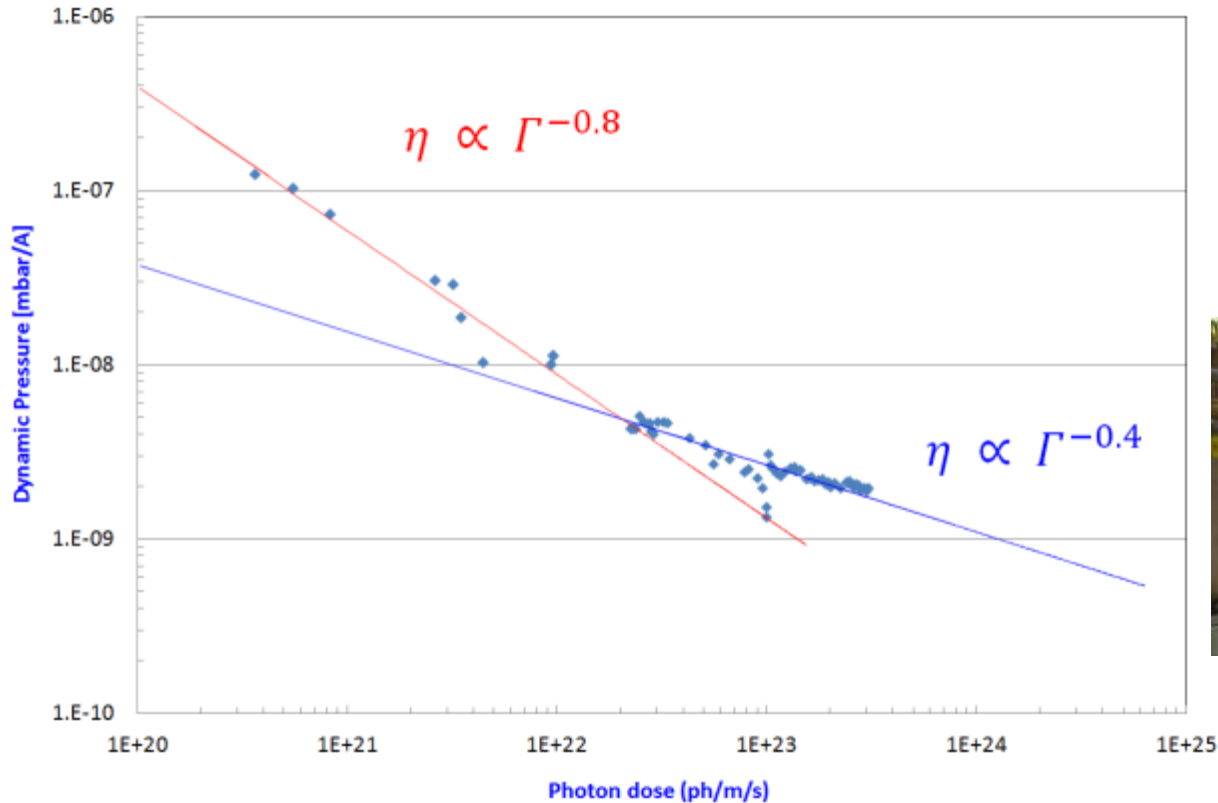

- 2 trends :
 - Room temperature
 - Cryogenic temperature

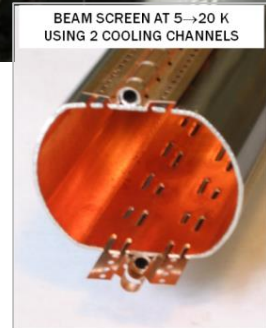

- Inside the arc, at 5-20 K, $\square P < 10^{-10}$ mbar (i.e. **below detection limit**)
- The photodesorption yield at **cryogenic temperature** is estimated to be $< 10^{-4}$ molecules/photon

3.3 RT Vacuum System

LSS: Some Numbers

Complementary
information

Component	Total
Vacuum sectors (cryogenic / RT)	84 / 185
Vacuum sector valves (all LHC)	295
Roughing valves (LSS)	309
Ion pumps (special /30 / 60 / 400 l/s)	12 / 550/ 168 / 49
Bayard Alpert gauges (LSS)	178
Penning gauges (LSS)	502
Pirani gauges (LSS)	289

Item in LSS	Length (m)	% wrt to total
SAM @ cryo T	~ 1 365	19
LSS @ RT baked	~ 1 000	14
LSS @ RT with baked NEG	~ 4 800	67
Total length under vacuum	7 227	100

- ~ 85 % of the baked vacuum system is NEG coated

Flanges and Gaskets

Complementary information

- For **primary vacuum**, elastomer seals and clamp flanges are used

- KF type components:

Many fittings (elbows, bellows, T, cross, flanges with short pipe, reductions, blank flanges ...)

ISO diameters

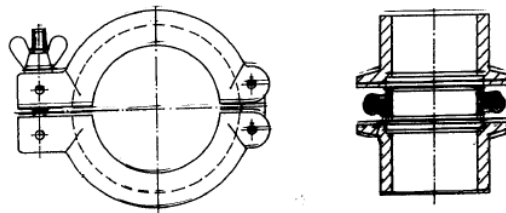

- For **ultra high vacuum**, metallic gaskets and bolts flanges are used

- Conflat® Type components :

Copper gaskets, blank flanges, rotatable flanges, welding flanges, elbows, T, crosses, adaptators, zero length double side flanges, windows ...

ISO diameters

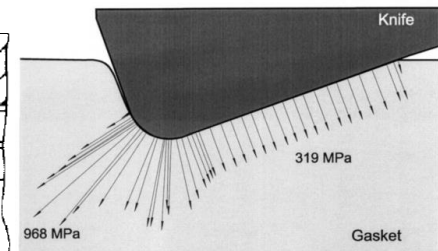
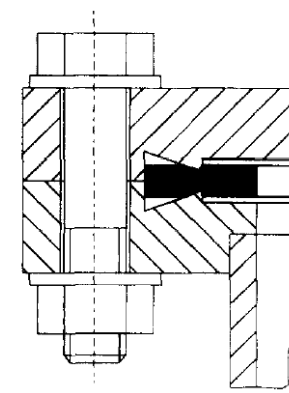

P. Lutkiewicz, C. Rathjen.
J.Vac.Sci. 26(3), May/Jun 2008, 537-544

Tubes, Bellows, Valves

Complementary information

- Metallic tubes are preferred (low outgassing rate)
- Stainless steel is appreciated for mechanical reason (machining, welding)



Copper tubes

- Bellows are equipped with RF fingers (impedance)

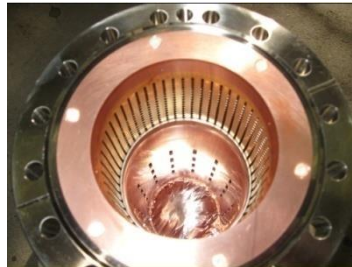

- Valves are used for roughing and sectorisation

Roughing valve

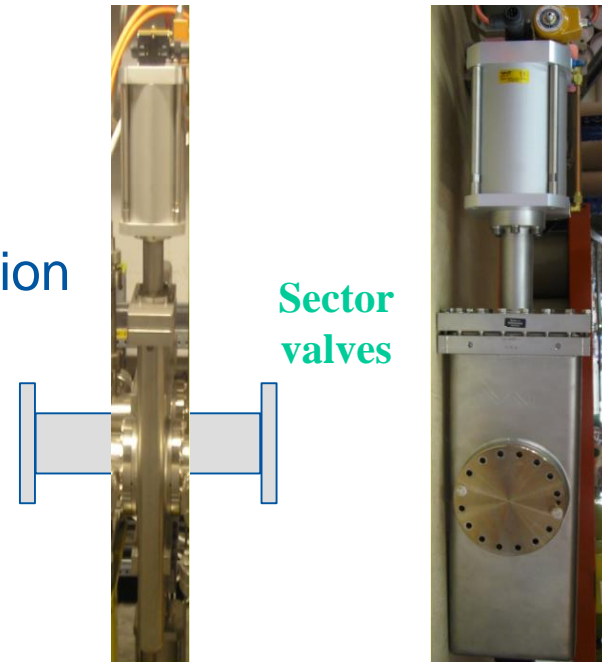

Sector valves

Leak Detection

Complementary
information

- The vacuum system of an accelerator must be **leak tight** !
- All vacuum components must follow **acceptance tests** (leak detection, bake out, residual gas composition and outgassing rate) before installation in the tunnel
- **Virtual leaks**, due to a closed volume, must be eliminated during the **design phase**. Diagnostic can be made with a RGA by measuring the gas composition before and after venting with argon.
- As a result of virtual leaks, the leak detection sensitivity limit in the concerned vacuum sector is altered
- Leaks could appear :
 - during components constructions at welds (cracks or porosity)
 - due to porosity of the material
 - during the assembly and the bake-out of the vacuum system (gaskets)
 - during beam operation due to thermal heating or corrosion

LSS Coating System

Complementary information

- Ti-Zr-V is coated by **magnetron sputtering** with Kr gas
- ~ 1 μm thick
- All room temperature vacuum chamber including the experimental beam pipe are coated with Ti-Zr-V
- Performances are validated by XPS on **witness sample**

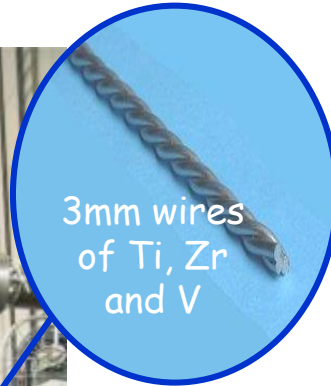
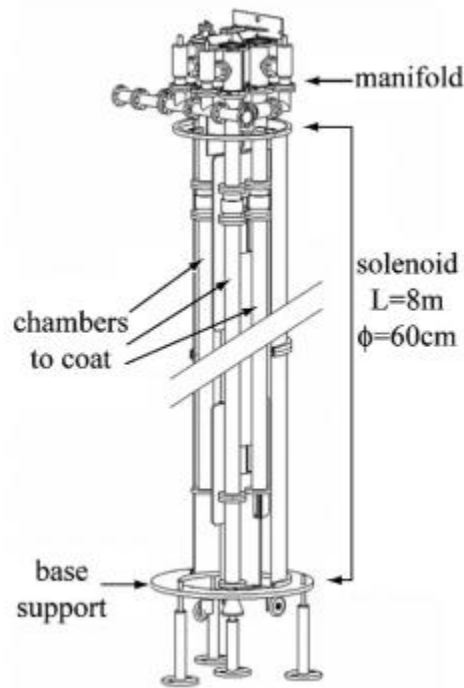

P. Costa Pinto, P. Chiggiato / Thin Solid Films 515 (2006) 382-388

TiZrV Vacuum Performances

Complementary information

- Very low stimulated desorption yield
- SEY $\sim 1.1 \Rightarrow$ very low multipacting
- **But** : limited capacity and fragile coating sensitive to pollutant (hydrocarbons, Fluor ...)

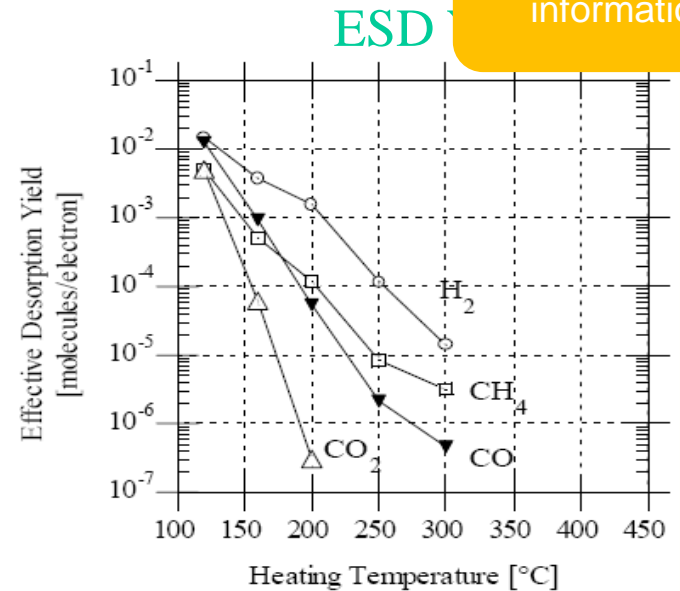

C. Benvenuti *et al.* J.Vac.Sci.Technol A 16(1) 1998

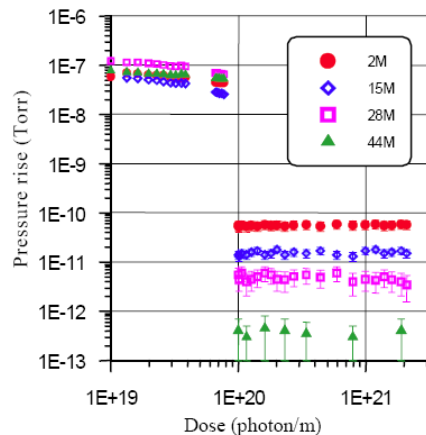

Figure 2: Pressure rise measured in the centre of the TiZrV coated test chamber before activation ($<1 \cdot 10^{20}$ photons/m) and after activation ($>1 \cdot 10^{20}$ photons/m).

PSD Yields

Table 2: Summary of results from the activated test chamber

Gas	Sticking probability	Photodesorption yield (molecules/photon)
H ₂	~ 0.007	$\sim 1.5 \cdot 10^{-5}$
CH ₄	0	$2 \cdot 10^{-7}$
CO (28)	0.5	$< 1 \cdot 10^{-5}$
C _x H _y (28)	0	$< 3 \cdot 10^{-8}$
CO ₂	0.5	$< 2 \cdot 10^{-6}$

V. Anashin *et al.* EPAC 2002

Secondary Electron Yield

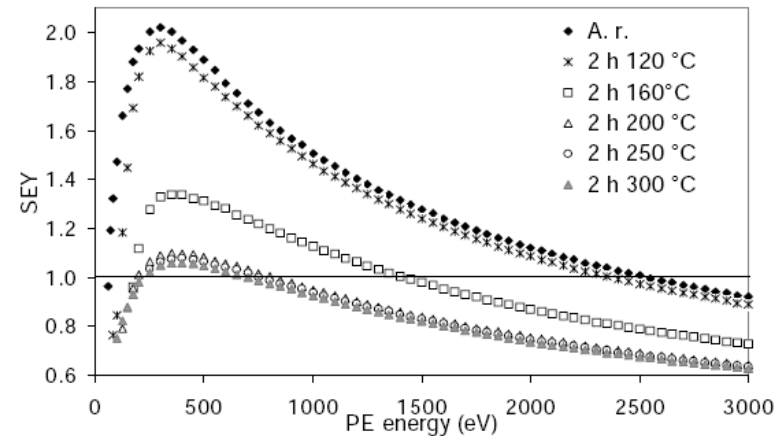

C. Scheuerlein *et al.* Appl.Surf.Sci 172(2001)

4. Some studies related to LHC, HL-LHC, FCC etc. Vacuum systems

NEG Pilot Sectors : LSS2 , 7 and 8

Complementary information

- Three NEG pilot sectors with 2 modules each :
 - A6L8.R&B located in a full NEG coated sector
 - A5L2.R&B located beside a collimator
 - IP7.R&B located beside a sector valve

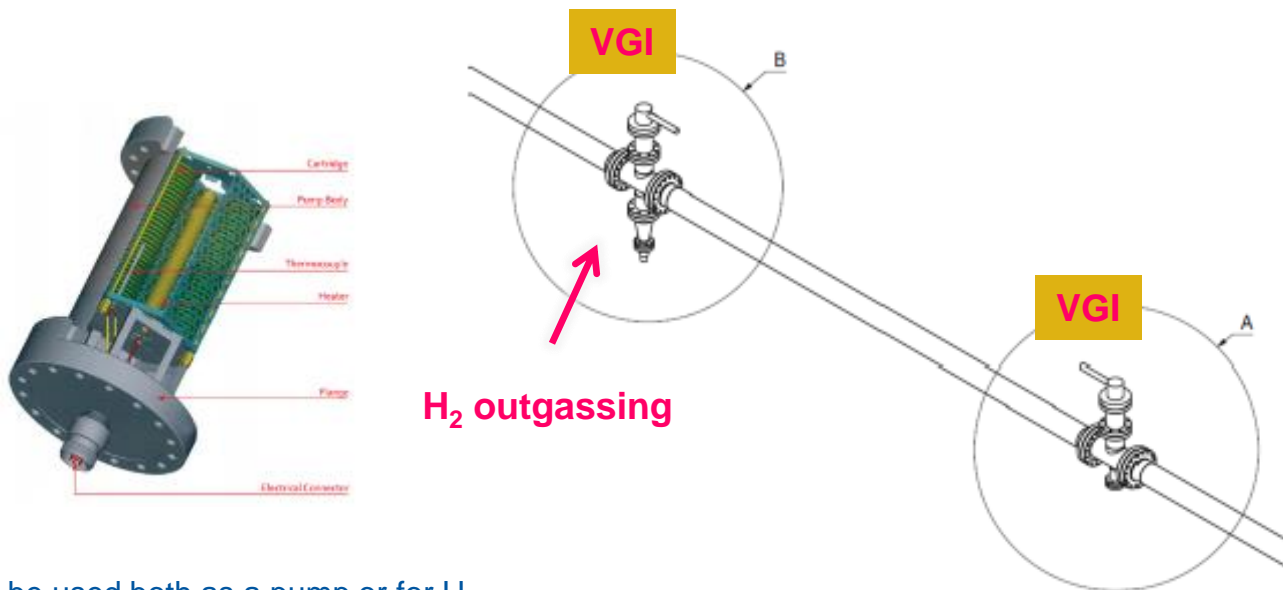

NEG cartridge: can be used both as a pump or for H₂ injections (thermal outgassing).

Figure 1: Pilot sector schematic

Monitor and qualify the ageing of NEG coatings due to the circulating beam

NEG Pilot Sectors : Typical Observat

Complementary information

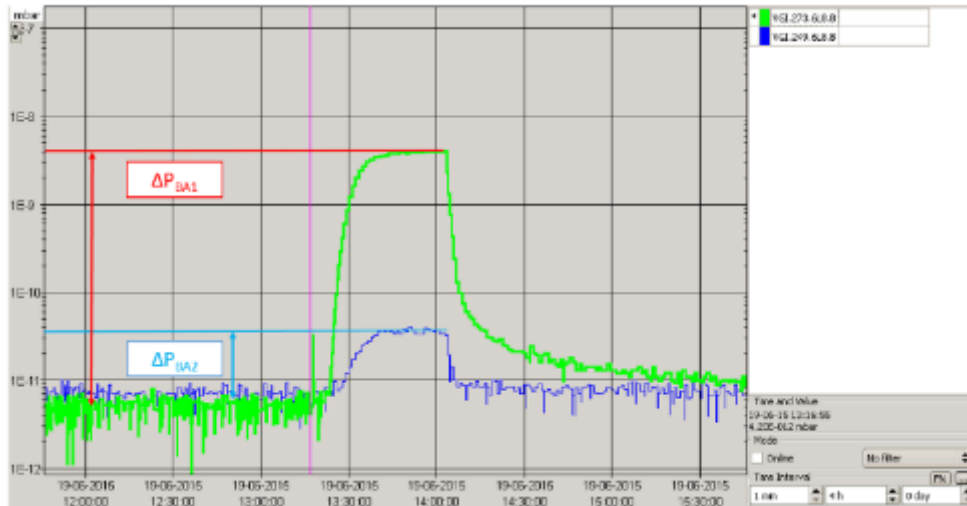

- H₂ injections are performed remotely
- The amount of injected gas is proportional to the current flowing in the NEG cartridge
- Injections are performed during LHC Technical Stop

- Pressure ratio *i.e.* transmission give the sticking factor
- Transmission are computed by monte carlo

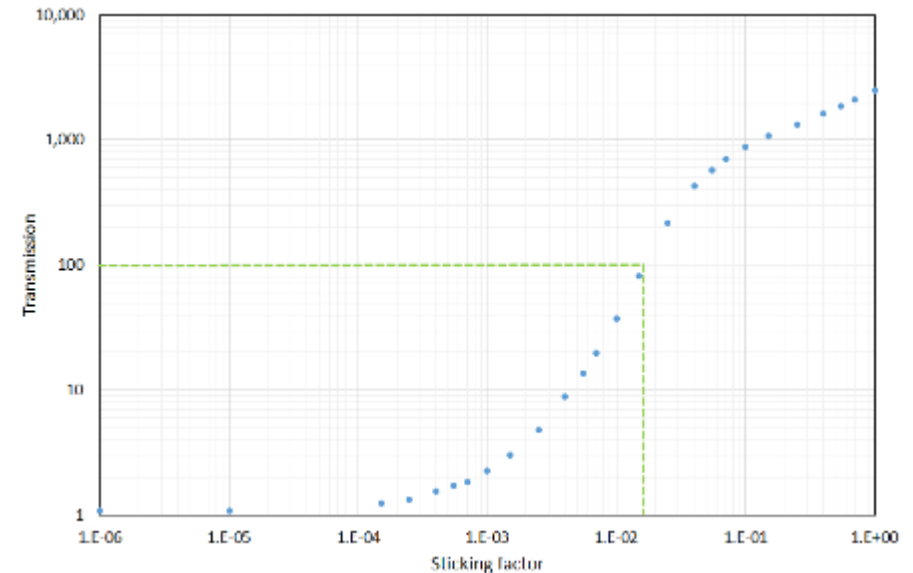

Courtesy G. Bregliozzi, V. Bencini

$$\sigma_{H_2} = 0.02$$