

# DETECTOR TECHNOLOGIES

## Lecture 3 : Radiation Detectors

- Scintillation
- Čerenkov
- TRD

# DETECTOR TECHNOLOGIES

## Lecture 3 : Radiation Detectors

- **Scintillation and Detection**
- Čerenkov
- TRD

## Scintillation : principles

**Scintillator** : a material which emits light (photons), when stimulated

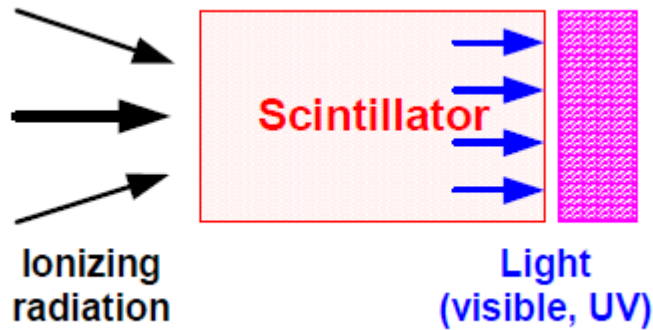

Light sensor  
Of course, we need a light sensor to transform the light in an electric signal

$\tau \approx \text{nsec.} - \mu\text{sec.}$

$\tau \approx \mu\text{sec.} - \text{mins}$

**Fluorescence**  
**Phosphorescence**

Light intensity :  $L(t) = L_0 e^{-\frac{t}{\tau}}$

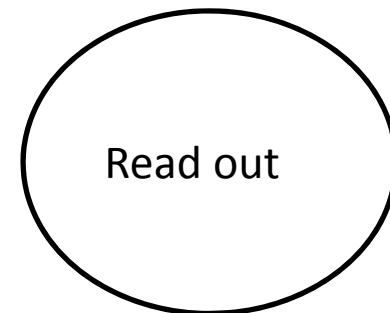
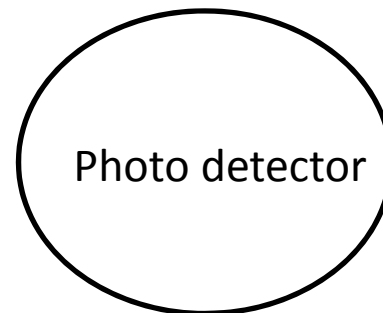
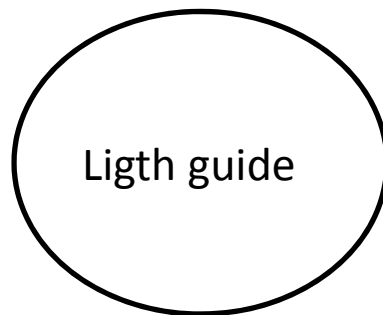
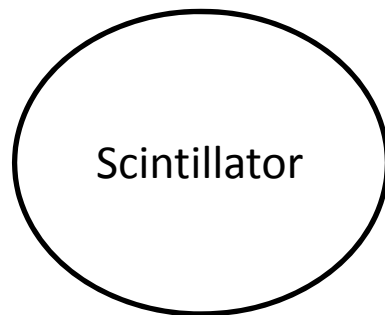

## Scintillation : principles

For a scintillator, what is important ?

- **Scintillation efficiency** : energy needed for 1  $\gamma$  - emission
- **Light spectrum** : in order to adapt the read out system to the proper wavelength
- **Light decay time**
- **$\gamma$  absorption**
- **Transparency** : the emitted  $\gamma$  should not be re-absorbed.

### 2 types of scintillators :

Organics (liquids, plastics)

Advantage : Fast

Disadvantages : rather inefficient  
non-linear (need quenching)  
not good for  $\gamma$  's

Used mainly for trigger purpose

Inorganics (crystals, liquids)

Advantages : good efficiency  
good linearity  
radiation tolerance

Disadvantages : relatively slow  
expensive (if crystals)

Used mainly for measurements

## Scintillation : Organic scintillators

### Organic Scintillators :

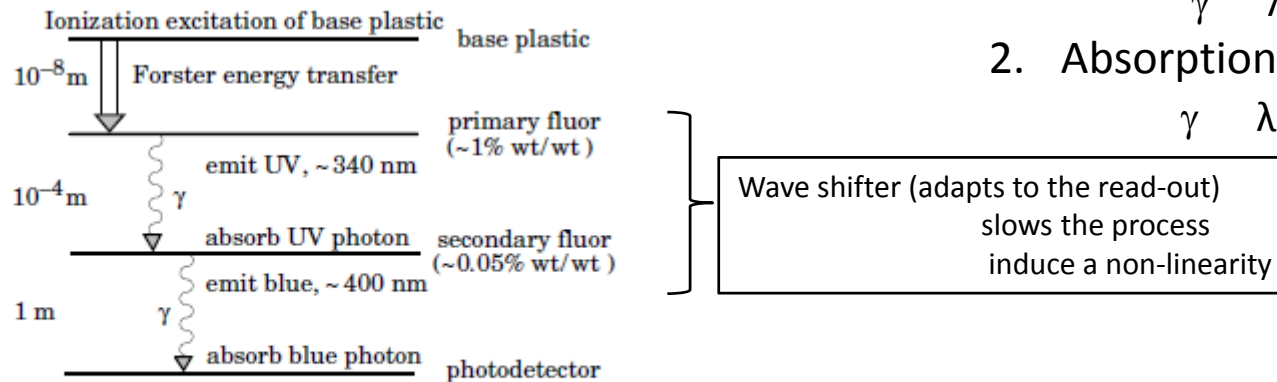

**Figure 28.1:** Cartoon of scintillation “ladder” depicting the operating mechanism of organic scintillator. Approximate fluor concentrations and energy transfer distances for the separate sub-processes are shown.

### 1. Excitation of organic molecules

Yield  $\approx 1 \gamma$  per loss of 100 eV

$\gamma \quad \lambda \approx 100 \text{ nm}$  (UV)

### 1. Absorption and re-emission

$\gamma \quad \lambda \approx 300 \text{ nm}$  (UV)

### 2. Absorption and re-emission

$\gamma \quad \lambda \approx 400 \text{ nm}$  (Blue)

### Luminescence (Birk's law) per length

$$\frac{dL}{dx} = \frac{S \frac{dE}{dx}}{1 + KB \frac{dE}{dx}}$$

S = emission efficiency

KB = Birk's constant (exp.)

Low Z (organic = Hydrogen + Carbon)

low efficiency for HE  $\gamma$  (only Compton effect)

but good efficiency for neutrons

# Scintillation : Organic scintillators

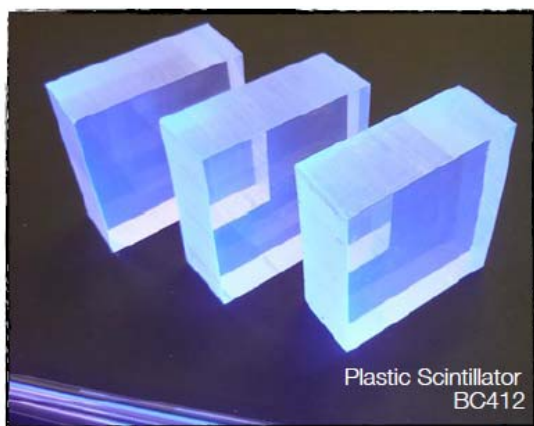
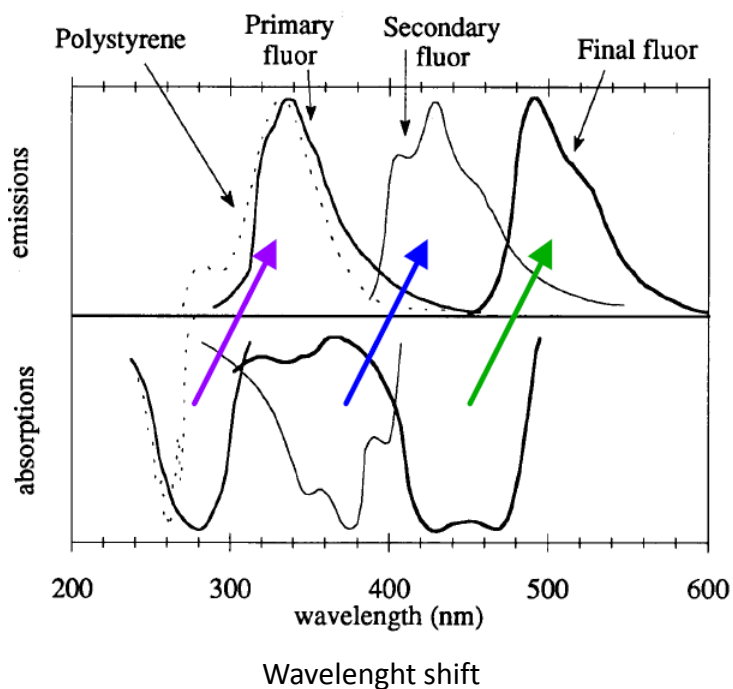
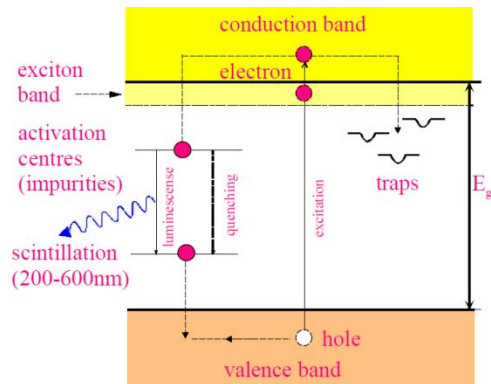

Table A6.3 Properties of some organic scintillators

scintillator	density (g/cm <sup>3</sup> )	index of refraction	wavelength of maximum emission (nm)	decay time constant (ns)	scintillation pulse height <sup>1)</sup>	H/C ratio <sup>2)</sup>
<b>Monocrystals</b>						
naphthalene	1.15	1.58	348	11	11	0.800
anthracene	1.25	1.59	448	30-32	100	0.714
trans-stilbene	1.16	1.58	384	3-8	46	0.857
p-terphenyl	1.23		391	6-12	30	0.778
<b>Plastics <sup>3)</sup></b>						
NE 102 A	1.032	1.58	425	2.5	65	1.105
NE 104	1.032	1.58	405	1.8	68	1.100
NE 110	1.032	1.58	437	3.3	60	1.105
NE 111	1.032	1.58	370	1.7	55	1.096
<b>Plastics <sup>4)</sup></b>						
BC-400	1.032	1.581	423	2.4	65	1.103
BC-404	1.032	1.58	408	1.8	68	1.107
BC-408	1.032	1.58	425	2.1	64	1.104
BC-412	1.032	1.58	434	3.3	60	1.104
BC-414	1.032	1.58	392	1.8	68	1.110
BC-416	1.032	1.58	434	4.0	50	1.110
BC-418	1.032	1.58	391	1.4	67	1.100
BC-420	1.032	1.58	391	1.5	64	1.100
BC-422	1.032	1.58	370	1.6	55	1.102
BC-422Q	1.032	1.58	370	0.7	11	1.102
BC-428	1.032	1.58	480	12.5	50	1.103
BC-430	1.032	1.58	580	16.8	45	1.108
BC-434	1.049	1.58	425	2.2	60	0.995

## Scintillation : Inorganic scintillators : crystals

### Crystals (NaI, CsI, BGO, PbWO4...)



Energy loss will induce electron-hole pairs creation  
 migration to activation centers (fast)  
 - excitation – transition -  $\gamma$  emission  
 trapping (slow)

Activator is chosen for visible emission  
 2 or more wavelengths (addition of activator)

### Liquid noble gases (Lar, Lxe, LKr)

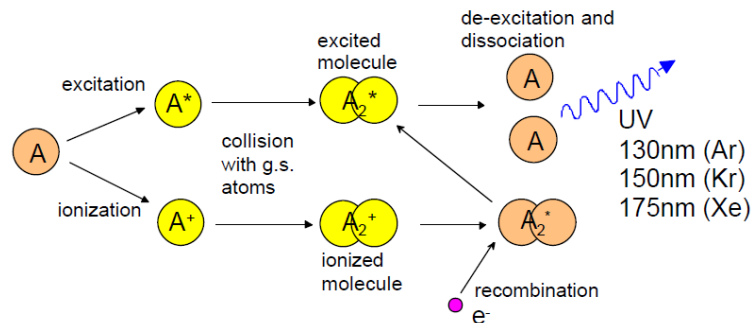

Still 2 time constants  
 Same wavelengths (pure gases)

Precision measurements

## Scintillation : Inorganic scintillators

**Table A6.2 Properties of some inorganic scintillators**

scintillator composition	density (g/cm <sup>3</sup> )	index of refraction	wavelength of maximum emission (nm)	decay time constant (μs)	scintillation pulse height <sup>1)</sup>	notes	Photons/ MeV
NaI	3.67	1.78	303	0.06	190	2)	4 × 10 <sup>4</sup>
NaI(Tl)	3.67	1.85	410	0.25	100	3)	
CsI	4.51	1.80	310	0.01	6	3)	
CsI(Tl)	4.51	1.80	565	1.0	45	3)	1.1 × 10 <sup>4</sup>
CaI(Na)	4.51	1.84	420	0.63	85	3)	1.4 × 10 <sup>4</sup>
KI(Tl)	3.13	1.71	410	0.24/2.5	24	3)	
<sup>6</sup> LiI(Eu)	4.06	1.96	470-485	1.4	35	3)	
CaF <sub>2</sub> (Eu)	3.19	1.44	435	0.9	50		6.5 × 10 <sup>3</sup> 2 × 10 <sup>3</sup>
BaF <sub>2</sub>	4.88	1.49	190/220 310	0.0006 0.63	5 15		
Bi <sub>4</sub> Ge <sub>3</sub> O <sub>12</sub>	7.13	2.15	480	0.30	10		2.8 × 10 <sup>3</sup>
CaWO <sub>4</sub>	6.12	1.92	430	0.5/20	50		
ZnWO <sub>4</sub>	7.87	2.2	480	5.0	26		
CdWO <sub>4</sub>	7.90	2.3	540	5.0	40		
CsF	4.65	1.48	390	0.005	5	3)	
CeF <sub>3</sub>	6.16	1.68	300 340	0.005 0.020	5		
ZnS(Ag)	4.09	2.35	450	0.2	150	4)	
GSO	6.71	1.9	440	0.060	20		
ZnO(Ga)	5.61	2.02	385	0.0004	40	4)	
YSO	4.45	1.8	420	0.035	50		
YAP	5.50	1.9	370	0.030	40		

<sup>1)</sup> relative to NaI(Tl) <sup>2)</sup> at 80 K <sup>3)</sup> hygroscopic <sup>4)</sup> polycrystalline

PbWO <sub>4</sub>	8.28	1.82	440, 530	0.01			100
-------------------	------	------	----------	------	--	--	-----

LAr	1.4	1.29 <sup>5)</sup>	120-170	0.005 / 0.860			
LKr	2.41	1.40 <sup>5)</sup>	120-170	0.002 / 0.085			
LXe	3.06	1.60 <sup>5)</sup>	120-170	0.003 / 0.022			4 × 10 <sup>4</sup>

<sup>5)</sup> at 170 nm

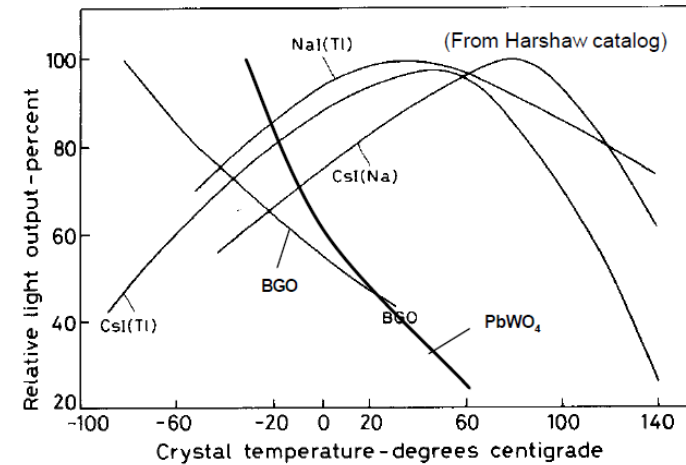

Inorganic crystals are temperature-sensitive (calorimeters have to be cooled)

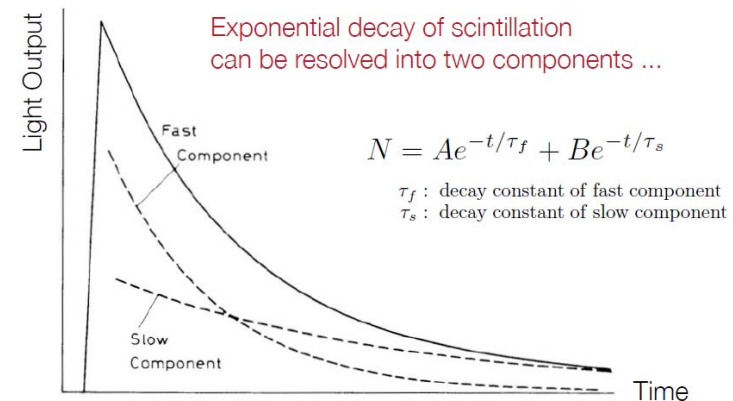



## Scintillation : Inorganic scintillators

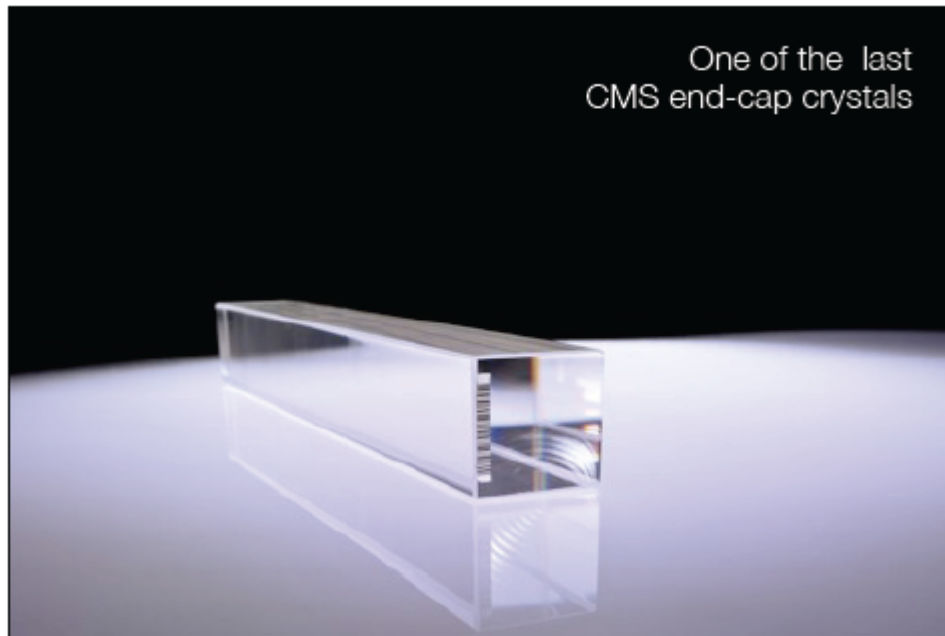

## Scintillation : Transport of light

The readout has to be adapted to geometry and emission spectrum of the scintillator.

### Light guide

Total reflection  
inside the light guide

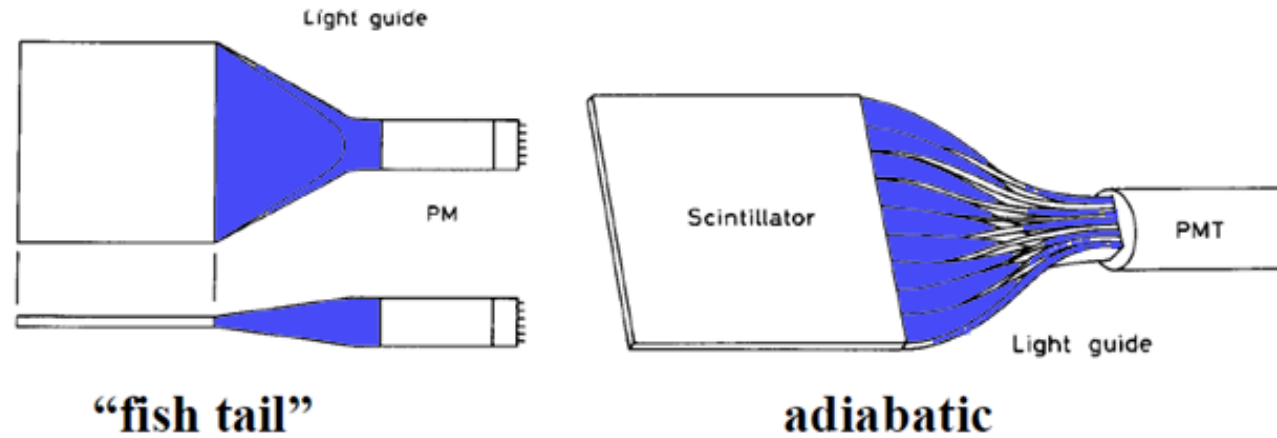

“fish tail”

adiabatic

### Material :

PPMA (Polymethylmethacrylat)

Plexiglas ( $C_5O_2H_8$ )<sub>n</sub>

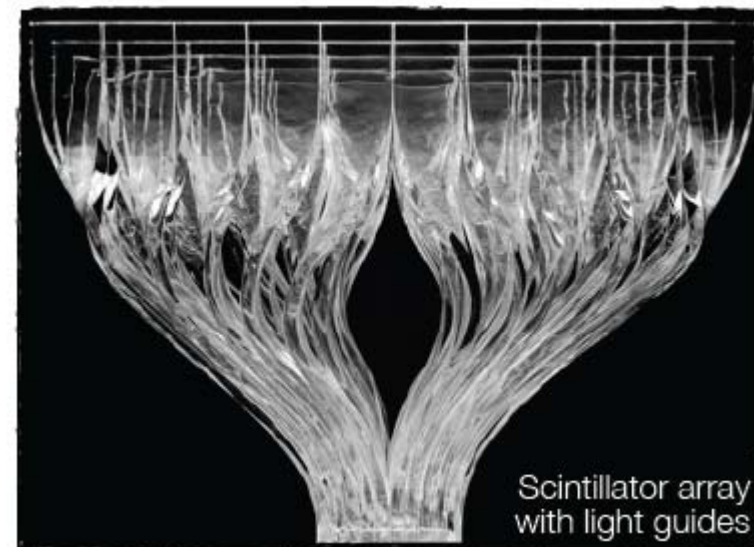

# Scintillation : Transport of light

## Optical fiber

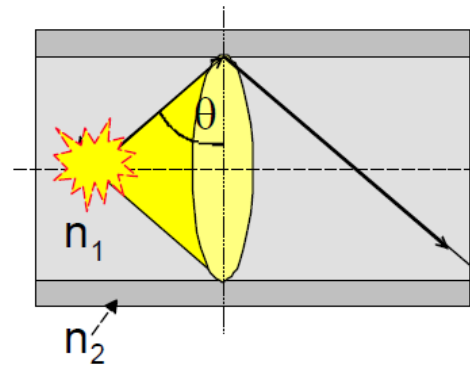
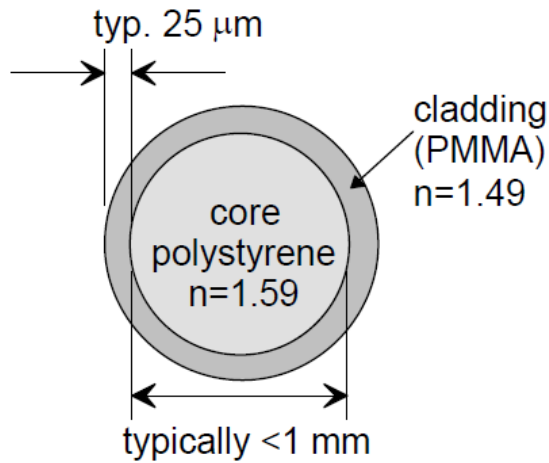

$$NA = \sqrt{n_{\text{core}}^2 - n_{\text{clad}}^2}$$

$$\theta \geq \arcsin \frac{n_2}{n_1} \approx 69.6^\circ$$

$$\frac{d\Omega}{4\pi} = 3.1\% \quad \text{in one direction}$$

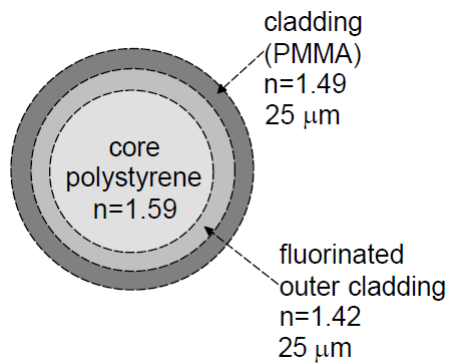
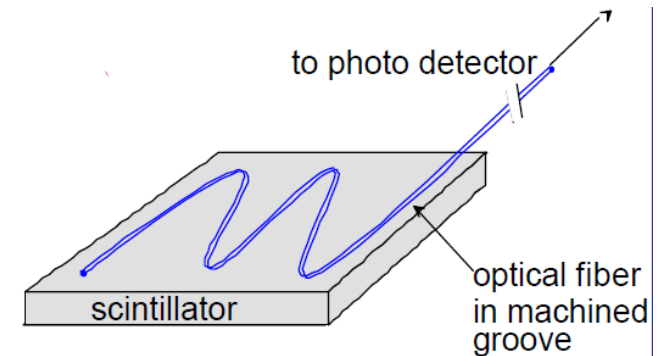

Improved aperture with multi-cladding

$$\frac{d\Omega}{4\pi} = 5.3\%$$

# Scintillation : Transport of light

Scintillating fiber : optical fiber filled with scintillator (plastic or liquid)

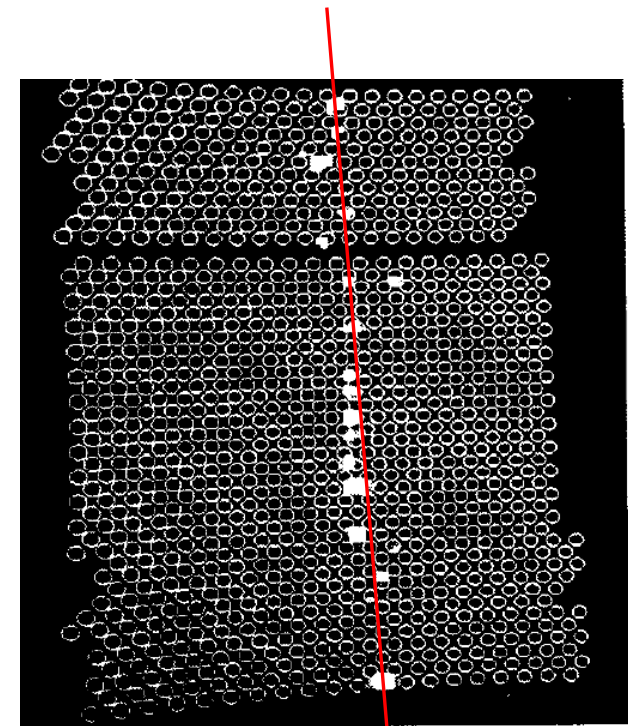
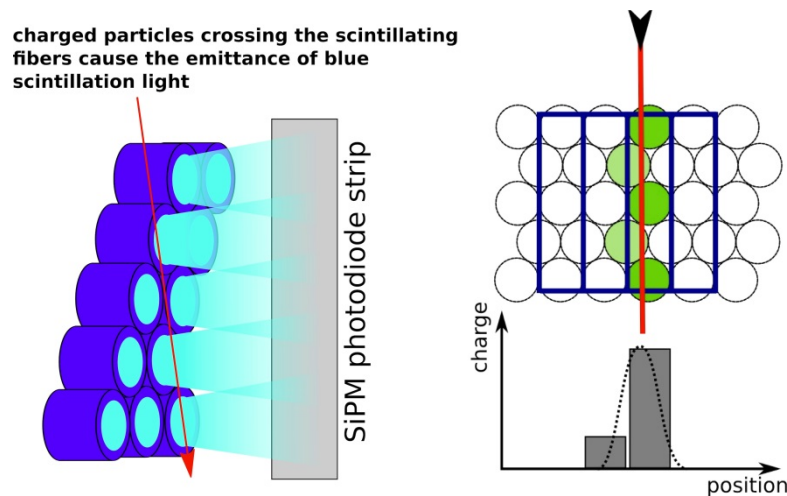

Stack of Sci Fibers (UA2)

Fiber	Emission Color	Emission Peak, nm	Decay Time, ns	1/e Length m*	# of Photons per MeV**	Characteristics/ Applications
BCF-10	blue	432	2.7	2.2	~8000	General purpose; optimized for diameters >250μm
BCF-12	blue	435	3.2	2.7	~8000	Improved transmission for use in long lengths
BCF-20	green	492	2.7	>3.5	~8000	Fast green scintillator
BCF-60	green	530	7	3.5	~7100	3HF formulation for radiation hardness
BCF-91A	green	494	12	>3.5	n/a	Shifts blue to green
BCF-92	green	492	2.7	>3.5	n/a	Fast blue to green shifter
BCF-98	n/a	n/a	n/a	n/a	n/a	Clear waveguide

## Scintillation : Photodetector

**Photodetector** : Convert the scintillating light into usable electronic signal  
(HE Physics : usually visible and UV spectrum)  
= Convert UV and visible photons in electrons

Requirement : High conversion efficiency

$$QE = N_{\text{photo-electrons}} / N_{\text{photons}}$$

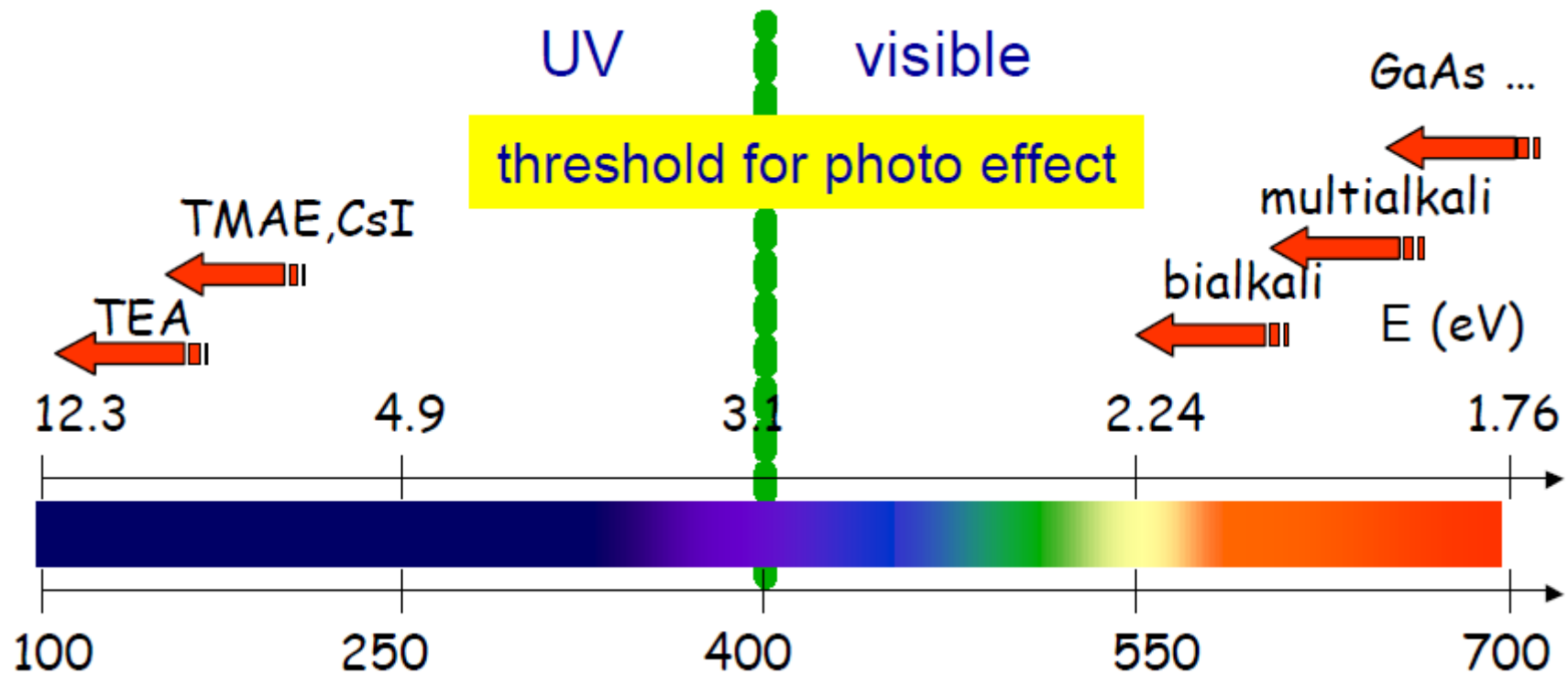

## Scintillation : Photomultiplier

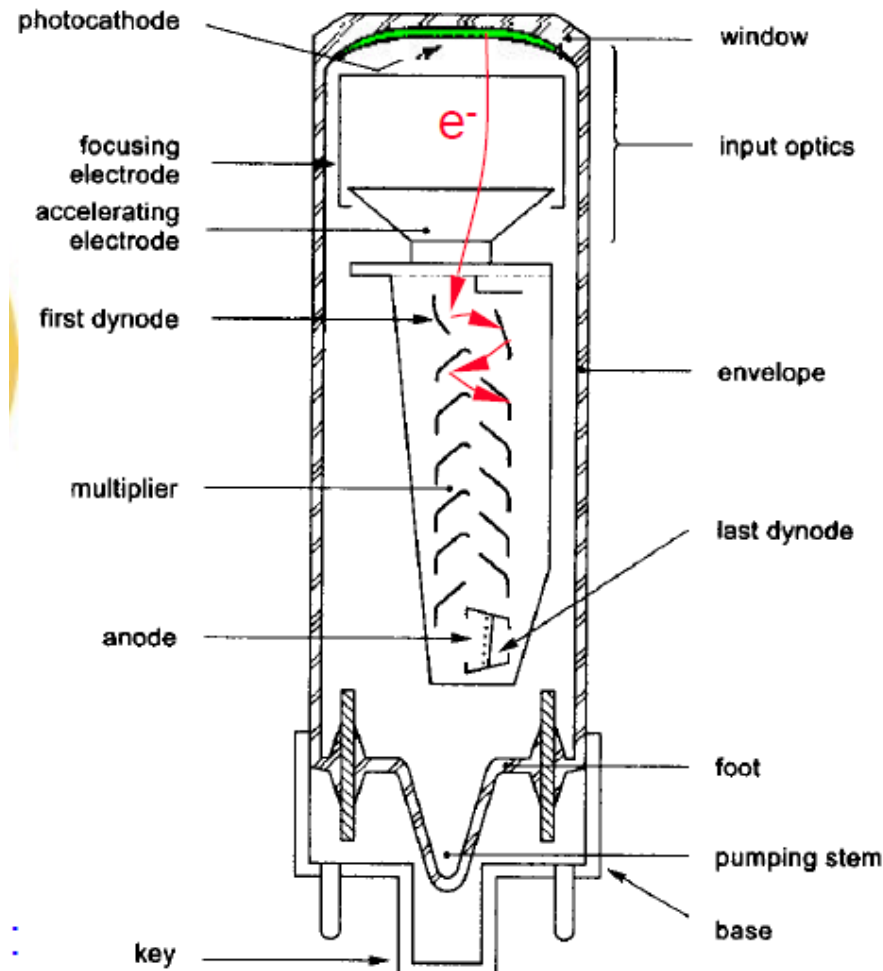

### Principle:

Electron emission  
from photo cathode

Secondary emission  
from dynodes; dynode gain: 3-50 [f(E)]

Typical PMT Gain:  $> 10^6$   
[PMT can see single photons ...]



## Scintillation : Photomultiplier

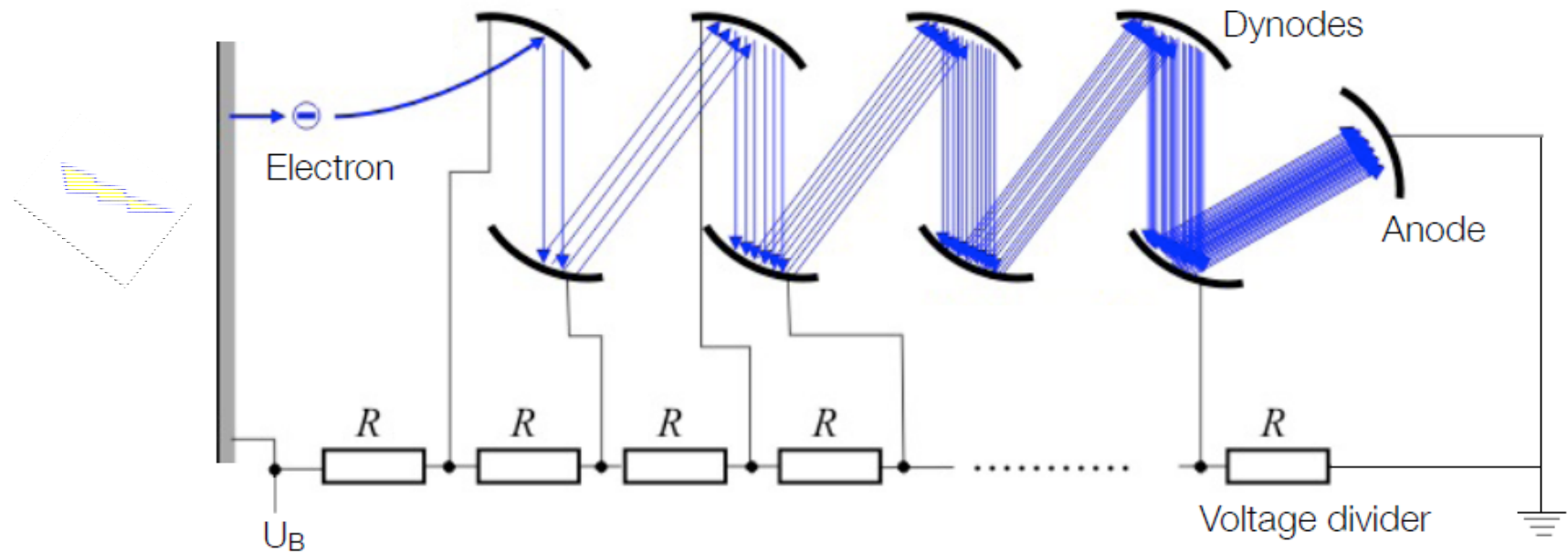

Requirement : High conversion efficiency

$$QE = N_{\text{photo-electrons}} / N_{\text{photons}}$$

Total gain :

$$\left. \begin{array}{l} \text{Typical: } \delta = 2 - 10 \\ n = 8 - 15 \end{array} \right] \rightarrow G = \delta^n = 10^6 - 10^8$$

$$\delta = N_{\text{electrons produced}} / N_{\text{electrons incoming}}$$

$n = \text{number of dynodes}$

Resolution : linearity  
statistics

And ... Sensitivity to magnetic field

## Scintillation : Photomultiplier

Type	Head-on type
Tube Size	Dia.13 mm
Photocathode Area Shape	Round
Photocathode Area Size	Dia.10 mm
Wavelength (Short)	185 nm
Wavelength (Long)	650 nm
Wavelength (Peak)	420 nm
Spectral Response Curve Code	400U
Photocathode Material	Bialkali
Window Material	UV glass
Dynode Structure	Linear-focused
Dynode Stages	10
[Max. Rating] Anode to Cathode Voltage	1250 V
[Max. Rating] Average Anode Current	0.1 mA
Anode to Cathode Supply Voltage	1000 V
[Cathode] Luminous Sensitivity Min.	40 $\mu\text{A}/\text{lm}$
[Cathode] Luminous Sensitivity Typ.	110 $\mu\text{A}/\text{lm}$
[Cathode] Blue Sensitivity Index (CS 5-58) Typ.	10
[Cathode] Radiant Sensitivity Typ.	80 mA/W
[Anode] Luminous Sensitivity Min.	30 A/lm
[Anode] Luminous Sensitivity Typ.	110 A/lm
[Anode] Radiant Sensitivity Typ.	$8.0 \times 10^4$ A/W
[Anode] Gain Typ.	$1.0 \times 10^6$
[Anode] Dark Current (after 30min.) Typ.	1 nA
[Anode] Dark Current (after 30min.) Max.	15 nA
[Time Response] Rise Time Typ.	2.1 ns
[Time Response] Transit Time Typ.	22 ns

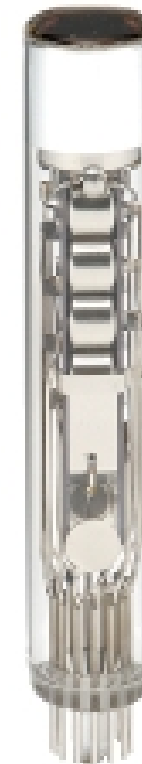



### Multi anode PMT

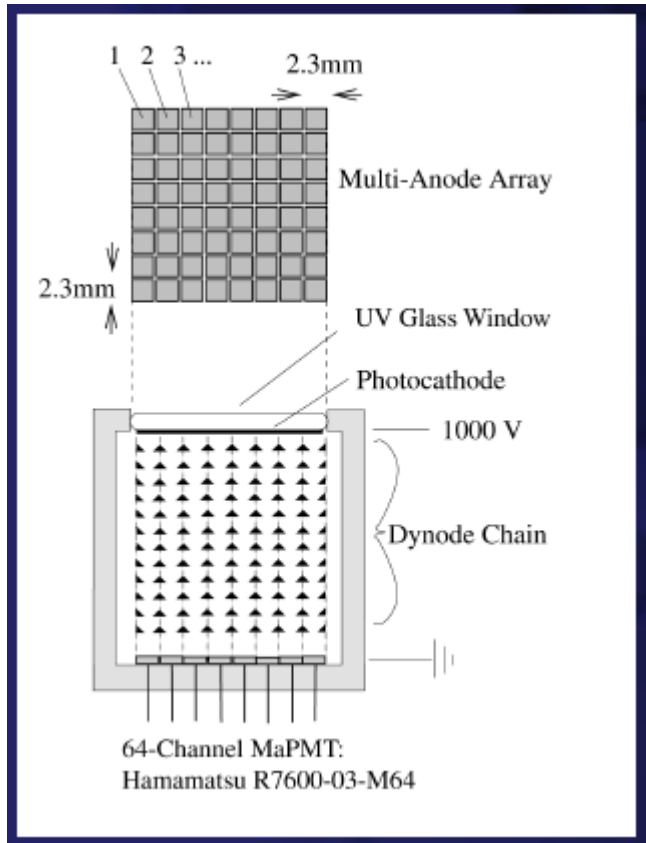

Resistant to magnetic field

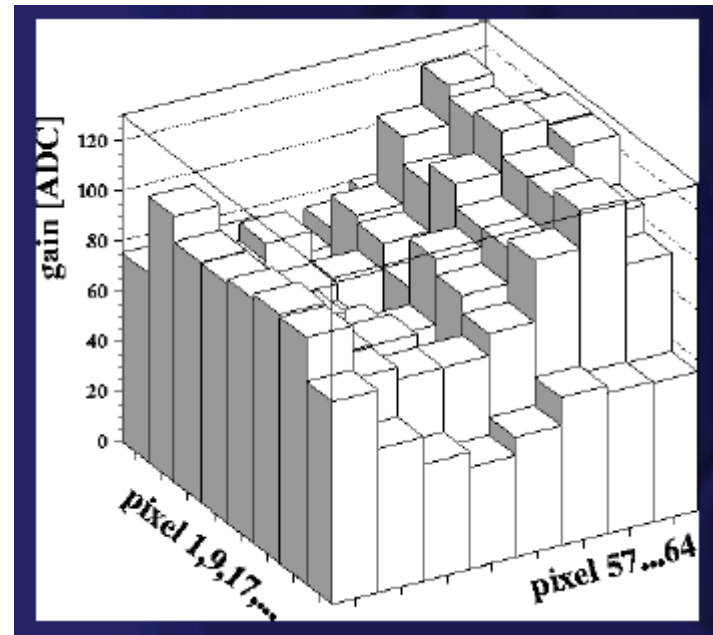
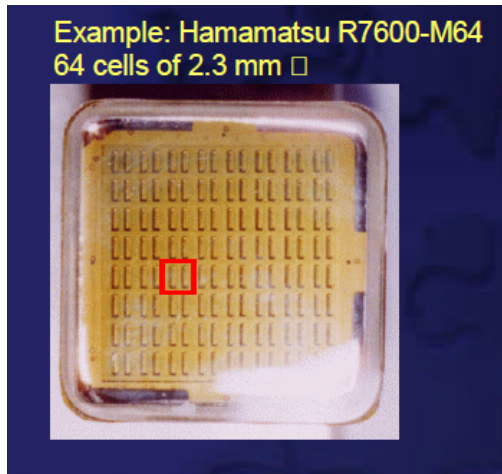

### Hybrid Photo Diode (HPD) highly segmented read out

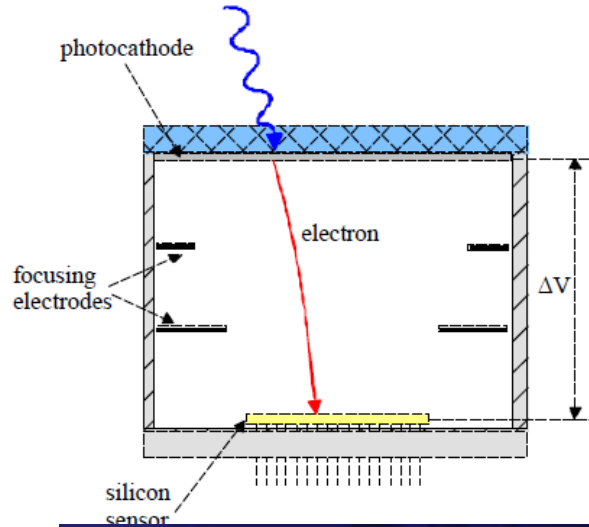

$$G = \frac{e\Delta V}{W_{Si}} = \frac{20 \text{ keV}}{3.6 \text{ eV}} \approx 5 \cdot 10^3 \quad (\text{for } \Delta V = 20 \text{ kV})$$

photo cathode + p.e. acceleration + silicon det. (pixel, strip, pads)

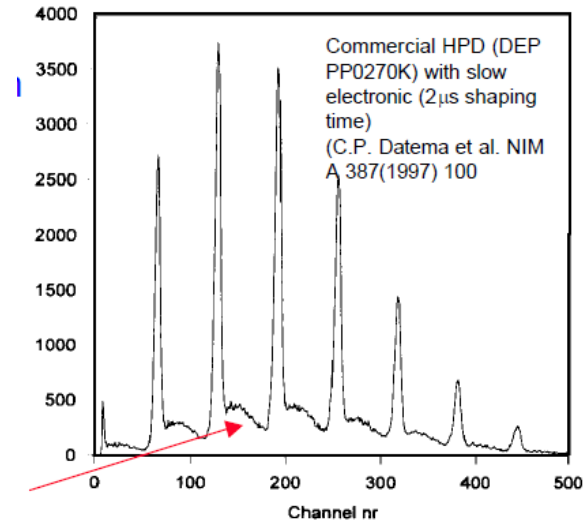

**Classical HPD designs**

- Proximity focused
- 1:1 imaging
- Operates in axial magnetic fields.

- 'Fountain' focused
- Demagnification D
- No real focusing → ballistic point spread
- Intolerant to magnetic fields

- 'Cross' focused
- Demagnification D
- Focusing leads to small point spread
- Intolerant to magnetic fields

Good sensitivity (PMT like)  
 Speed  
 Less sensitive to Mag. Field  
 Precision

## Scintillation : HPD

### LHCb : Cerenkovs read-out with HPDS

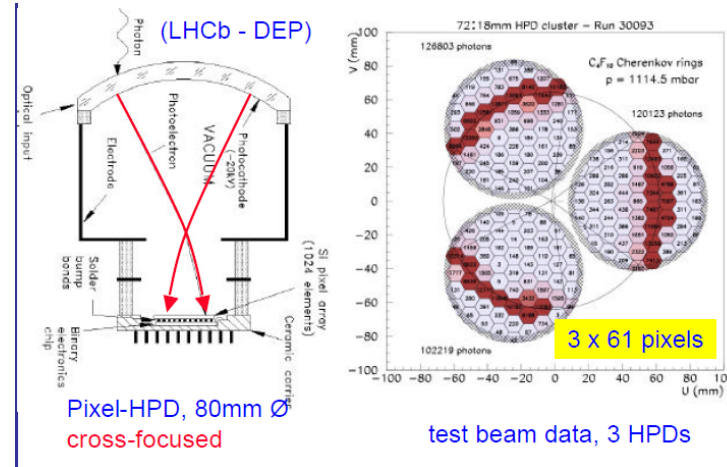

- 484 HPDs (Hybrid Photon Detector) :  
196 for RICH1 and 288 for RICH2
- ~3.3 m<sup>2</sup> total surface
- Granularity: 2.5 x 2.5 mm<sup>2</sup>  
(almost 0.5 million pixels)
- Active area coverage >65 %
- Single-photon sensitivity between 200-600 nm
- Magnetic fringe field <25 G
- Read-out:
  - Compatible with LHC 40MHz bunch crossing frequency
  - 10% occupancy (worst case)

Cms /HCAL read-out with HPDs

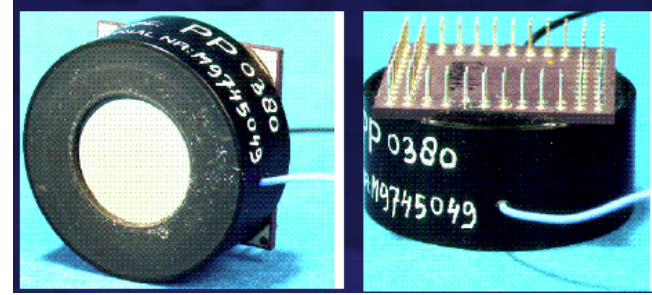
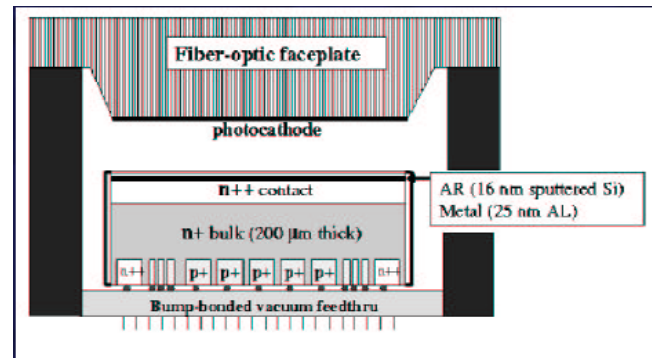
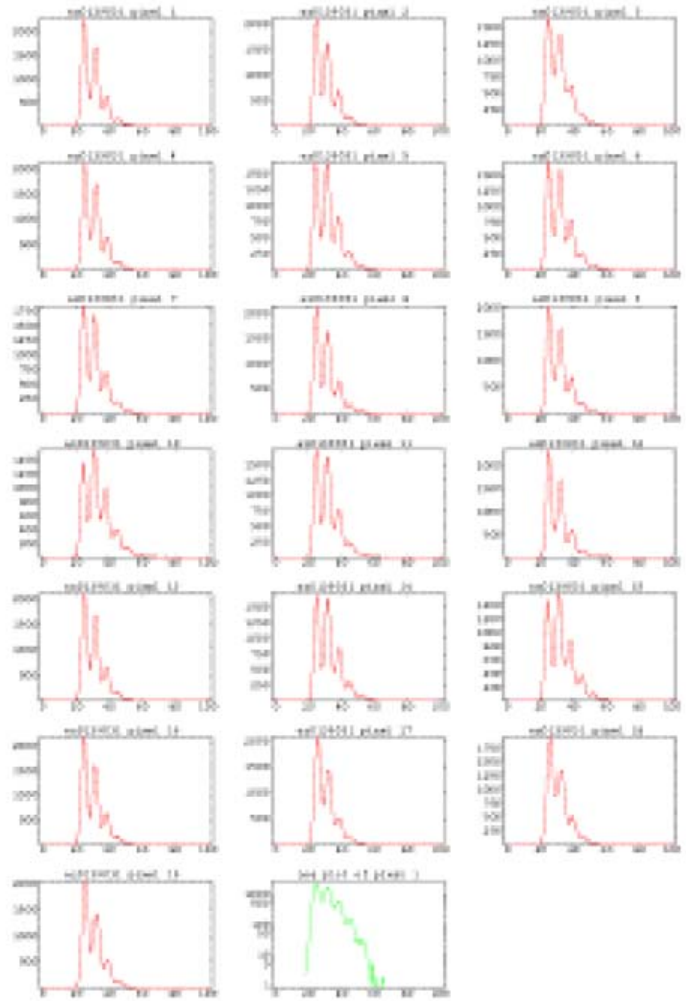

- Proximity focused optics.
- 27 mm active diameter
- S20 photocathode
- 19 or 73 hex pixels,  
5.4 or 2.68 mm flat-to-flat
- Very small acceleration gap  
(3.3 mm)
- Gain = 2500 (12 kV)
- External electronics

## Scintillation : APD

**Avalanche Photo Diode (APD) : an all-silicon device.**

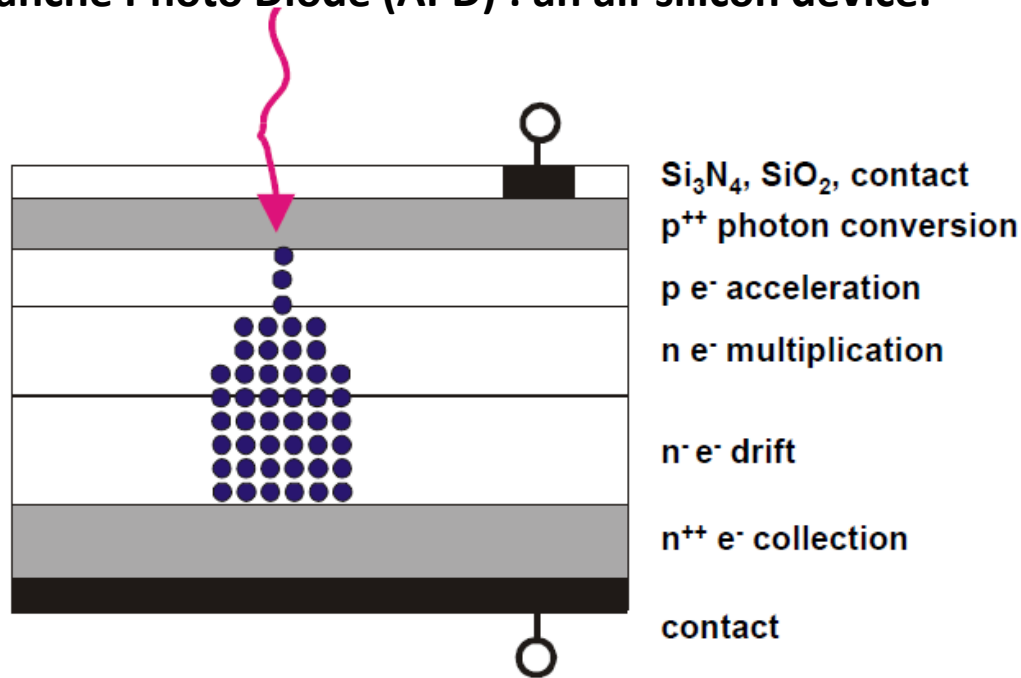

- high photo conversion

$$Q_{\text{eff}} \approx 0.7$$

- Very high electric field

$10^5$  V/m (avalanche mode)

- Thick

- Linear mode

Good tolerance with mag. Field  
good (?) tolerance to radiation

**Avalanche photodiodes** have internal gain which improves the signal to noise ratio but still some 20 photons are needed for a detectable signal. The excess noise, the fluctuations of the avalanche multiplication limits the useful range of gain. CMS is the first big experiment that uses APD's.

## Scintillation : APD

CMS APDs :  $\approx 141\,500$  Pieces for the ECAL (scintillator :  $\text{PWBO}_4$ )

Active size :  $5 \times 5 \text{ mm}^2$

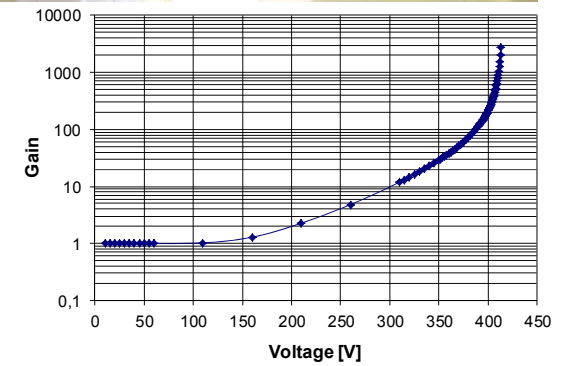
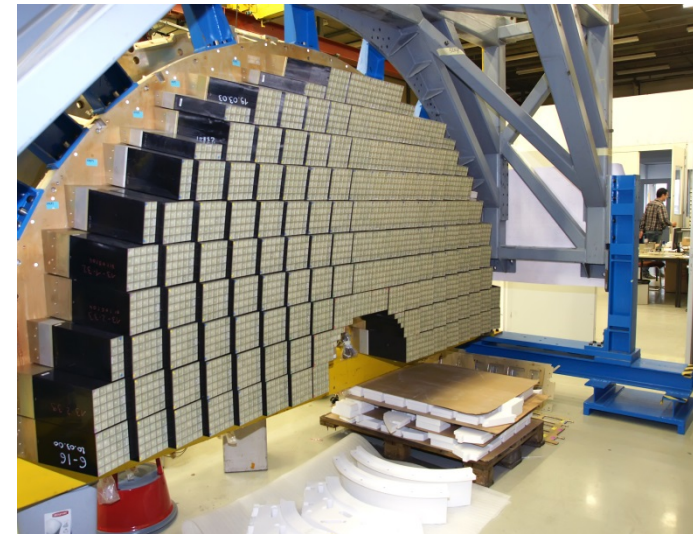
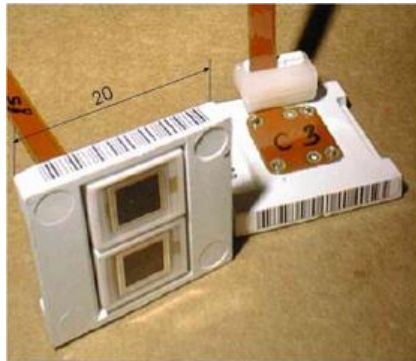
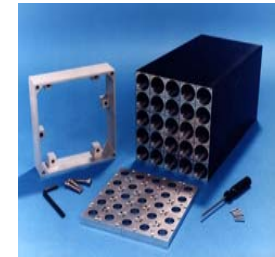

## Scintillation : SiPM

PPD : Pixelized Photon Detector = SiPM : Silicon Photomultiplier

= APDs in parallel with resistors

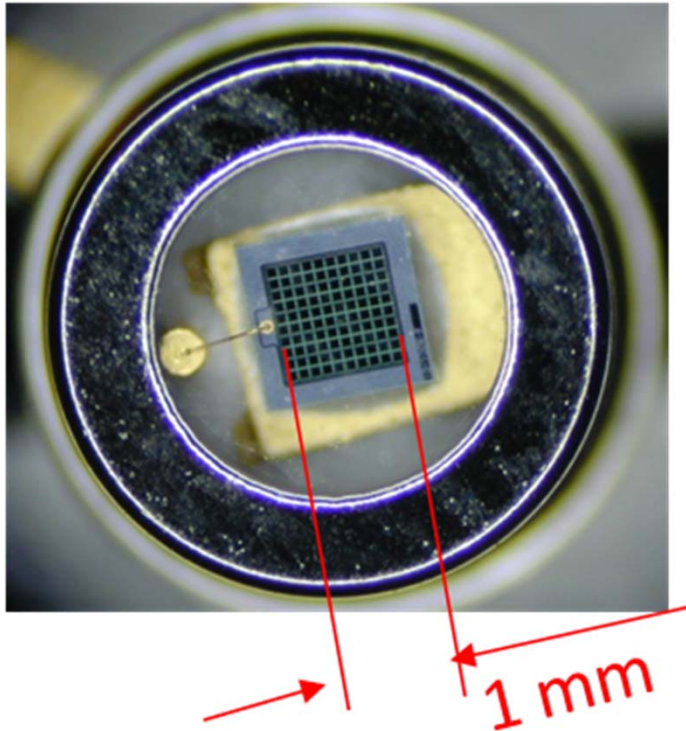

- high photo conversion  
 $Q_{\text{eff}} \approx 0.7$
- Very high Gain ( $10^5$ )
- Geiger mode
- Pixellized
- Not a proportional counter
- Very good position counter
- Adapted to fibers (small surface)

SiPM's can detect single photons. They have been developed and described since the beginning of this millennium (patent of Z. Sadygov 1996).

# Scintillation : SiPM

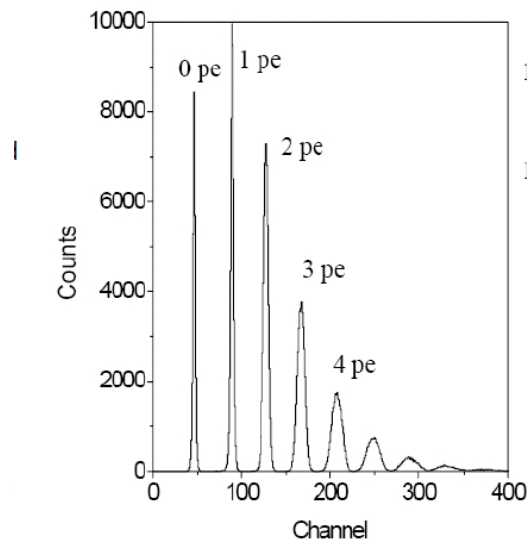
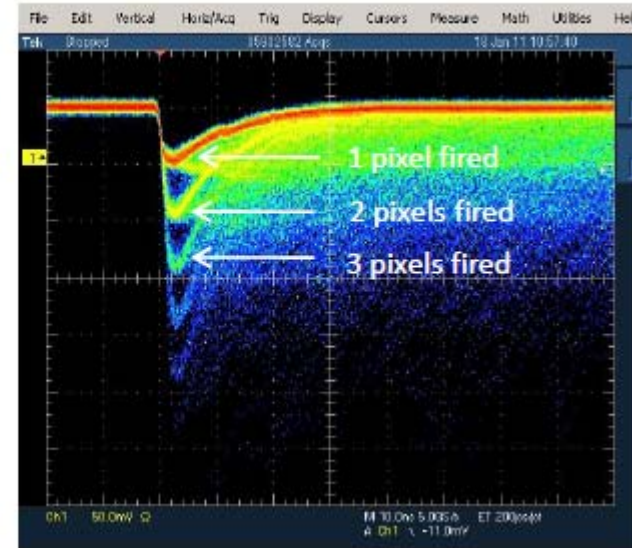
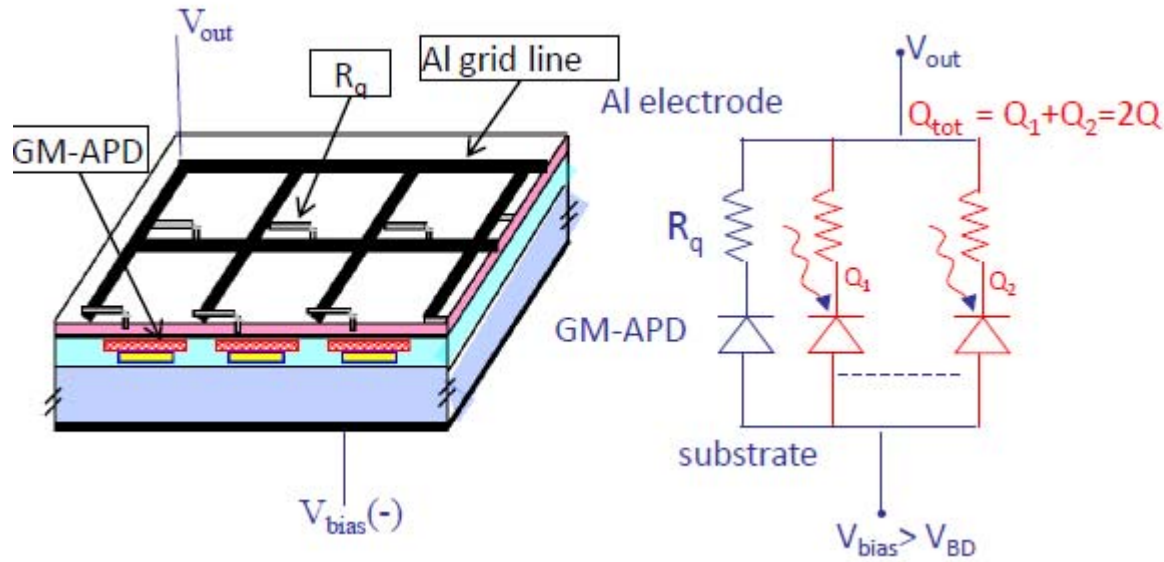



## Scintillation : SiPM

### Advantages

- ☺ high gain ( $10^5$ - $10^6$ ) with low voltage (<80V)
- ☺ low power consumption (< $75\mu\text{W}/\text{mm}^2$ )
- ☺ fast (timing resolution  $\sim 50$  ps RMS for single photons)
- ☺ insensitive to magnetic field (tested up to 7 T)
- ☺ high photon detection efficiency (30-40% blue-green)
- ☺ mechanically robust and compact

### Possible drawbacks

- ☹ high dark count rate (DCR)
  - early productions:  $\sim 100\text{kHz} - 1\text{MHz}/\text{mm}^2$  at  $T \sim 25^\circ\text{C}$ ;  $t_h = 0.5\text{pe}$
  - today productions:  $\sim 20\text{kHz}$  at  $T \sim 25^\circ\text{C}$ ;  $t_h = 0.5\text{pe}$
  - thermal carriers, cross-talk, after-pulses
- ☹ temperature dependence
  - $V_{\text{BD}}$ , signal shape,  $R_q$ , DCR, PDE

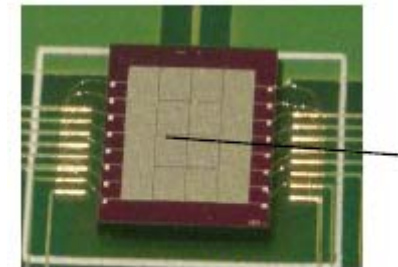

Each channel:  $1 \times 1 \text{ mm}^2$   
625 cells,  $40 \times 40 \mu\text{m}^2/\text{cell}$

## Scintillation : Devices

	PMT	APD	HPD	SiPM
Photon detection efficiency:				
blue	20%	50%	20%	12%
green - yellow	a few %	60-70%	a few %	15%
red	<1%	80%	<1%	15%
Gain	$10^6$ - $10^7$	100-200	$10^3$	$10^6$
High voltage	1-2 kV	100-500 V	20 kV	25 V
Operation in the magnetic field	problematic	OK	OK	OK
Threshold sensitivity	1 ph.e.	~10 ph.e.	1 ph.e.	1 ph.e.
$S/N \gg 1$				
Timing /10 ph.e.	~100 ps	a few ns	~100 ps	30 ps
Dynamic range	~ $10^6$	large	large	~ $10^3$ /mm <sup>2</sup>
Complexity	high (vacuum, HV)	medium (low noise electronics)	very high (hybrid technology, very HV)	relatively low

	ATLAS	CMS
Magnetic field	2 T solenoid + toroid: 0.5 T (barrel), 1 T (endcap)	4 T solenoid + return yoke
Tracker	Silicon pixels and strips + transition radiation tracker $\sigma/p_T \approx 5 \cdot 10^{-4} p_T + 0.01$	Silicon pixels and strips (full silicon tracker) $\sigma/p_T \approx 1.5 \cdot 10^{-4} p_T + 0.005$
EM calorimeter	Liquid argon + Pb absorbers $\sigma/E \approx 10\%/\sqrt{E} + 0.007$	PbWO <sub>4</sub> crystals $\sigma/E \approx 3\%/\sqrt{E} + 0.003$
Hadronic calorimeter	Fe + scintillator / Cu+LAr (10λ) $\sigma/E \approx 50\%/\sqrt{E} + 0.03$ GeV	Brass + scintillator (7 λ + catcher) $\sigma/E \approx 100\%/\sqrt{E} + 0.05$ GeV
Muon	$\sigma/p_T \approx 2\%$ @ 50GeV to $10\%$ @ 1TeV (Inner Tracker + muon system)	$\sigma/p_T \approx 1\%$ @ 50GeV to $10\%$ @ 1TeV (Inner Tracker + muon system)
Trigger	L1 + HLT (L2+EF)	L1 + HLT (L2 + L3)

## Scintillation : HPD vs SiPM

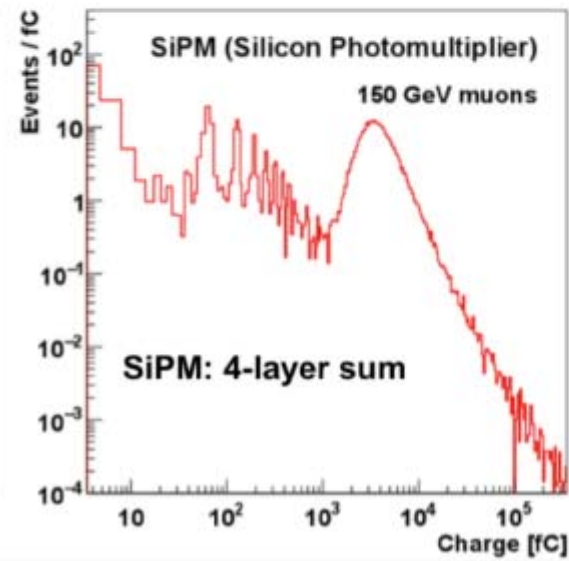
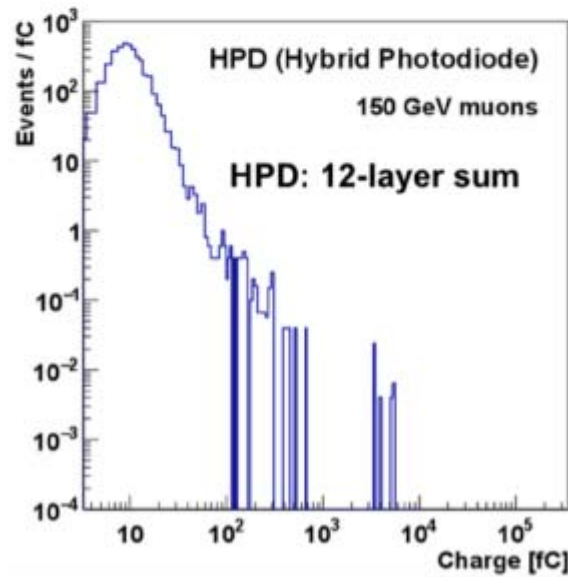
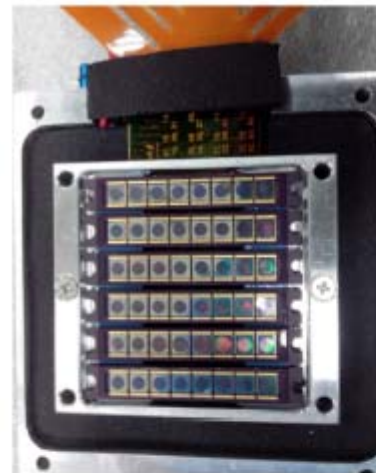

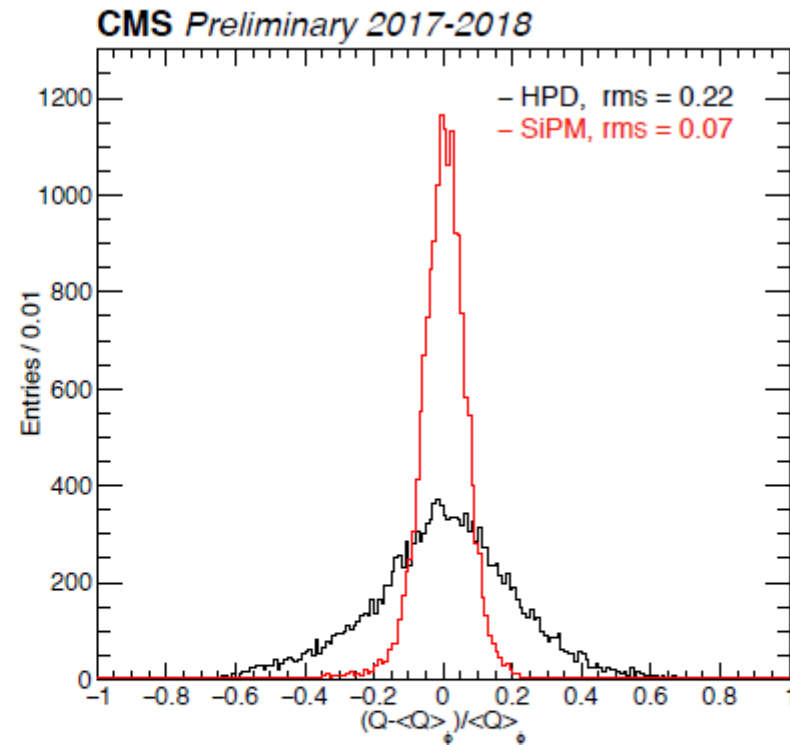

**Figure 4.** The signal from  $^{60}\text{Co}$  wire-source inserted into tubes embedded in HE megatiles is used to compare the relative response of channels at the same eta and depth. After the channels readout based on HPDs (black) was replaced with SiPMs (red), a much improved uniformity of the raw response is achieved.

# DETECTOR TECHNOLOGIES

## Lecture 3 : Radiation Detectors

- Scintillation and Detection
- **Čerenkov**
- TRD

## Čerenkov Detectors

Particle travelling faster than light in a given medium emits radiation (photons)

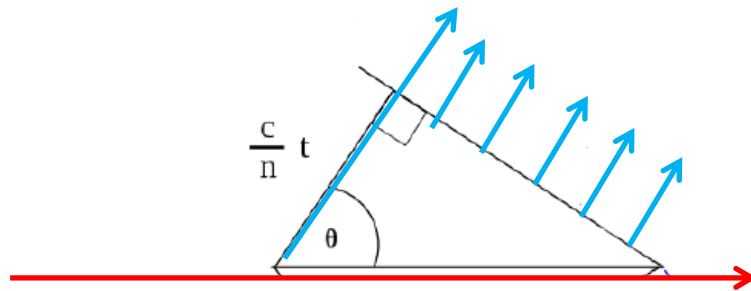

$$\cos \theta_c = \frac{\frac{c}{nt}}{\beta ct} = \frac{1}{\beta n}$$

$$\cos \theta_c \leq 1 \longrightarrow \beta \geq \frac{1}{n} \quad N = 370L \int \epsilon \sin^2 \theta_c \, dE \quad \triangleright \quad \theta_c < \theta_{max}$$

$$\theta_{max} = \cos^{-1} \left( \frac{1}{n} \right)$$

The emission of Čerenkov light depends directly from the speed of the particle  
 depends indirectly from the mass of the particle (  $p = m \quad \quad$  )

The maximum angle depends only from the medium.

Typical :  $0.35 \mu\text{m} < \lambda_{\text{cerenkov}} < 0.55 \mu\text{m}$  (usual medium :  $1 < n < 2$ )

Radiation intensity (Franck-Tamm formula) :

$$\frac{d^2 N_{phot}}{dLd\lambda} = \frac{2\pi\alpha \sin^2\theta}{\lambda^2}$$

$$\alpha = 1 / 137$$

$\lambda$  = Čerenkov light

$\theta$  = Čerenkov angle

in a wavelength interval 350-500 nm (photomultiplier tube),  $\frac{dN}{dx} = 390 \sin^2\theta \text{ photons/cm}$

Medium	n	$\Theta_{max}$	$N_{photons}$
He	1.000035	0.48	0.39
Air	1.000283	1.36	3.12
Freon (gas)	1.00072	2.17	7.95
Isobutane	1.00127	2.89	14.91
Freon (liquid)	1.233	35.8	1899
Water	1.33	41.2	2407
Plexigas	1.5	48.2	3084

For a charged (1) particle,  $\beta = 1$

## Threshold Čerenkov

Threshold Čerenkov detectors make a simple decision on whether the particle is above or below the Čerenkov threshold velocity.

Used for differentiating heavy particles ( $\pi$ , K, p)

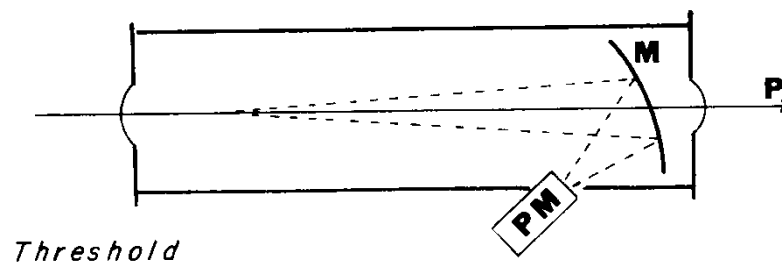
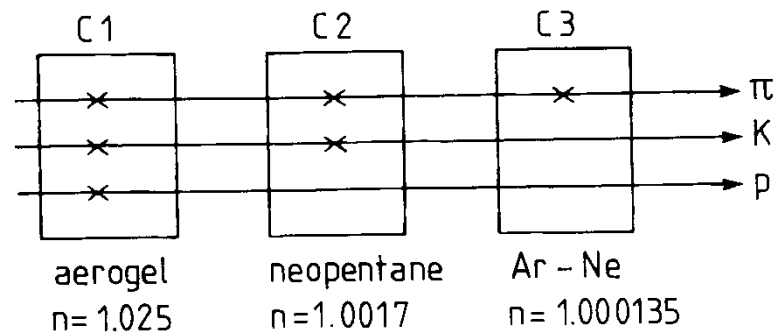

Changing the the gas pressure  
Changes the refractive index



# Threshold Čerenkov

Aerogel : silicate gel (99.8% Air)

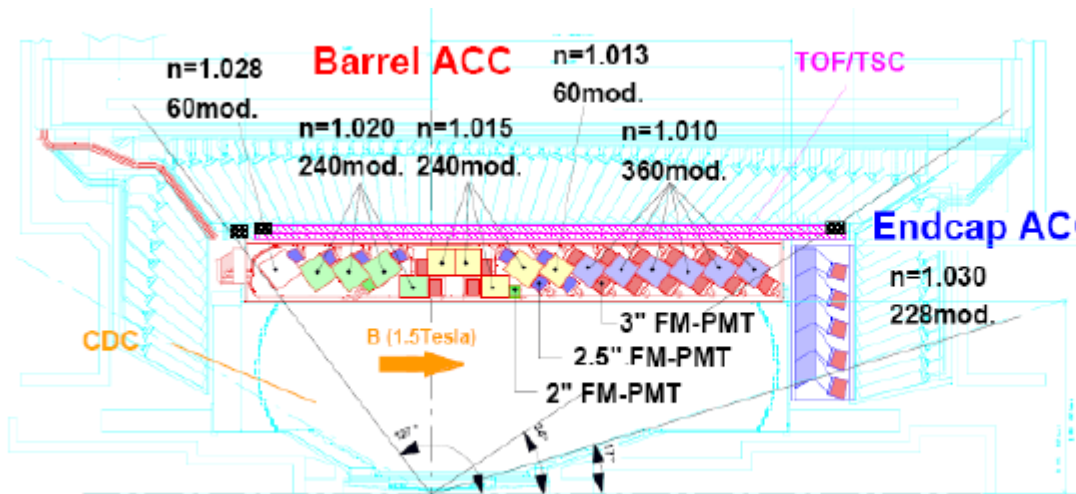
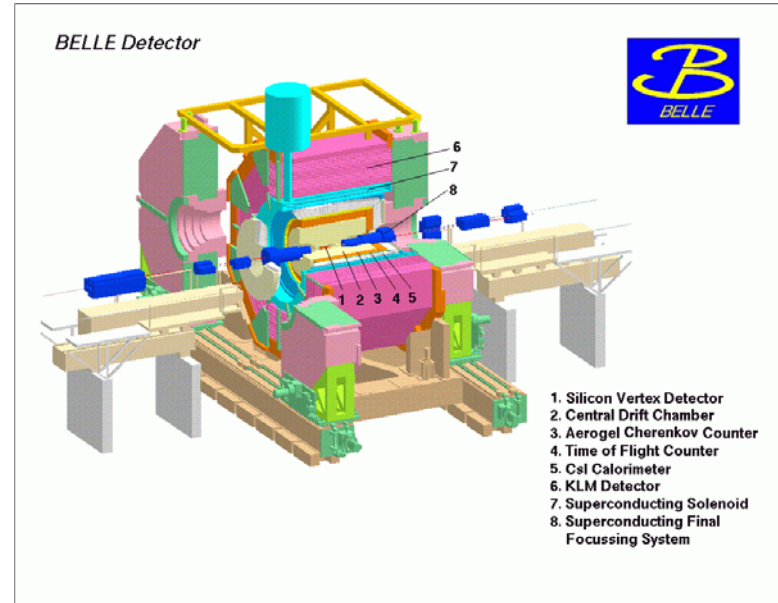
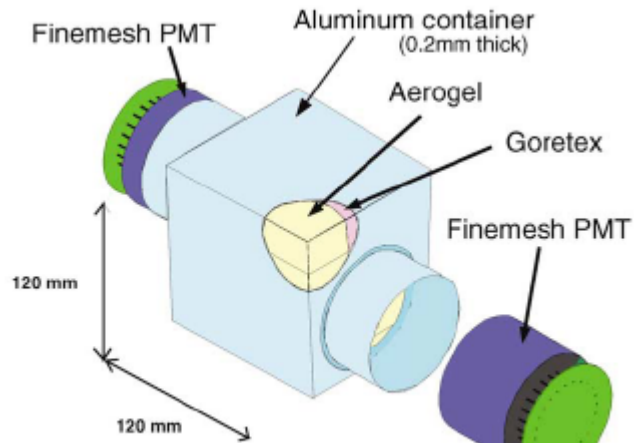

- Five aerogel tiles inside an aluminum box lined with a white reflector(Goretex reflector)
- Performance from test-beam

## Threshold Čerenkov

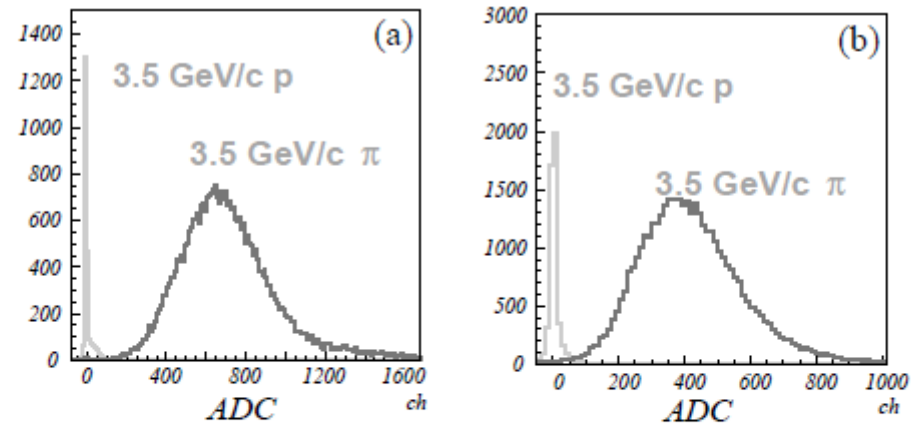
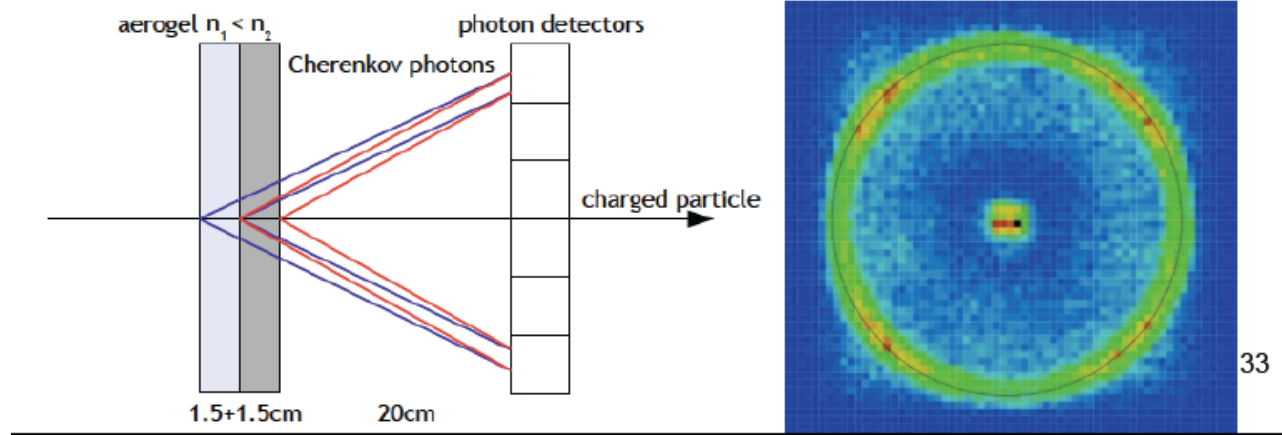
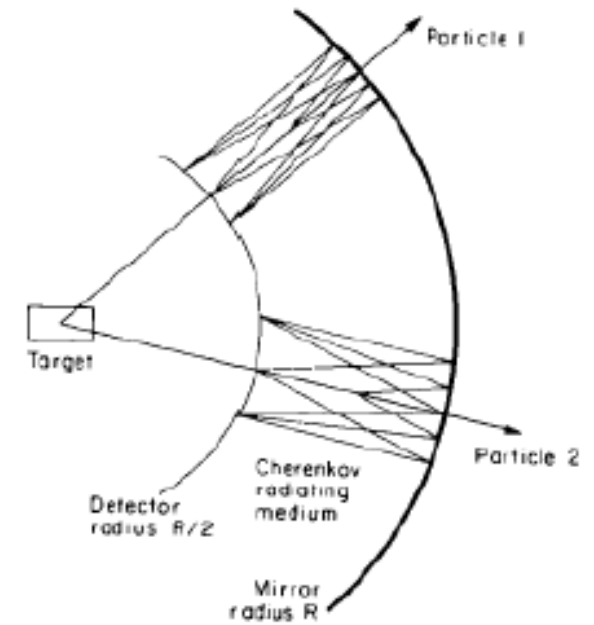

Fig. 47. Pulse-height spectra for 3.5 GeV/ $c$  pions (above threshold) and protons (below threshold) obtained by a single module of ACC in (a) non-magnetic field and (b) a magnetic field of 1.5 T. Silica aerogels with  $n = 1.015$  were stacked to form the module.

### Ring Imaging Cherenkov (Ypsilantis and Seguinot -1977)

- Measures both the Cherenkov angle and the number of photoelectrons detected.
- Can be used over particle identification over large surfaces.
- Requires photodetectors with single photon identification capability.



33

### The LHCb RICH

$C_4F_{10}$  in RICH 1 ( $n = 1.0014$ )

$CF_4$  in RICH 2 ( $n = 1.005$ )

Read-out : HPDs

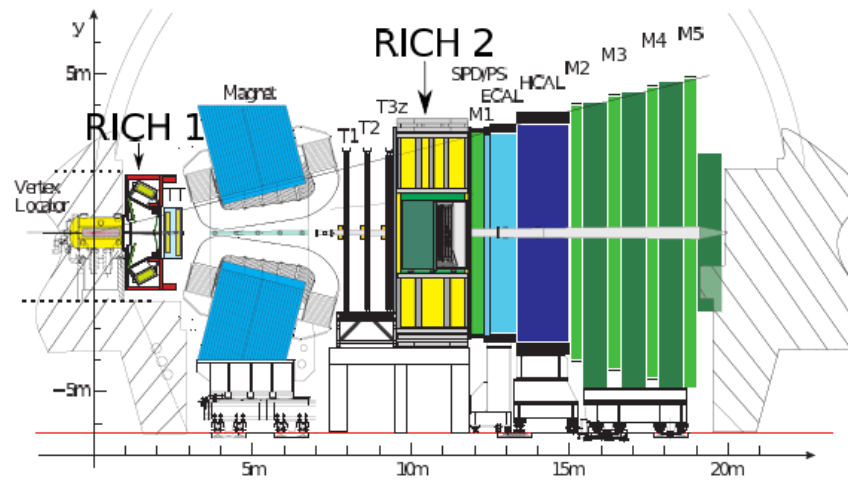
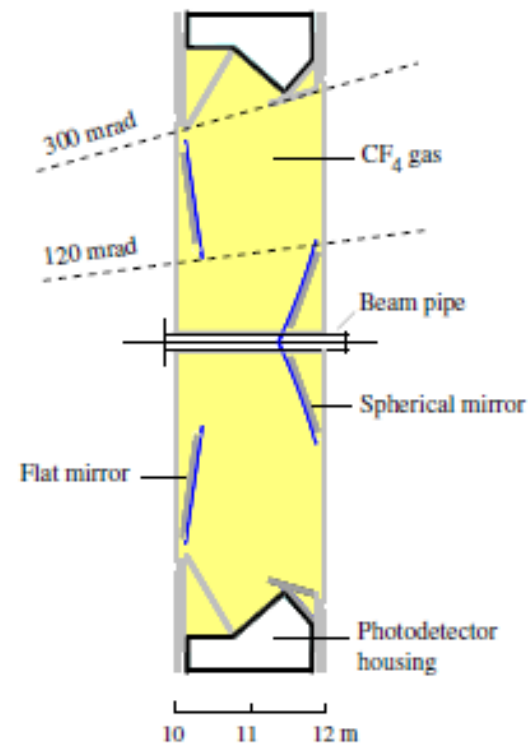
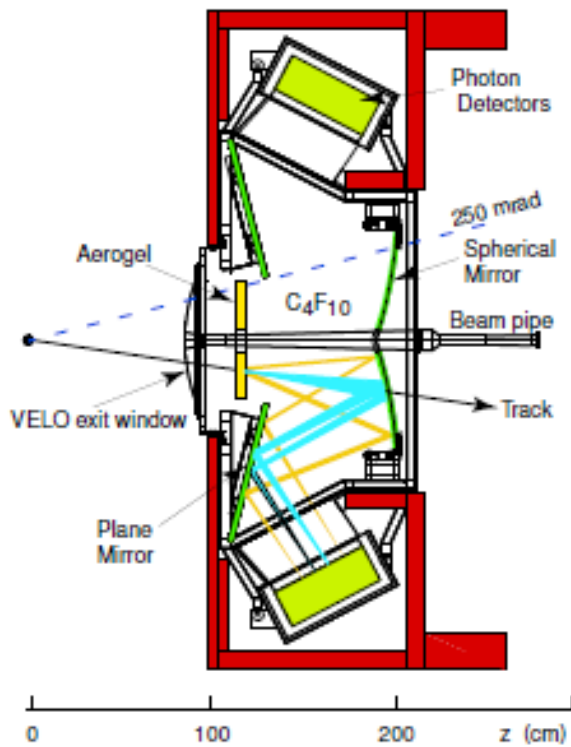
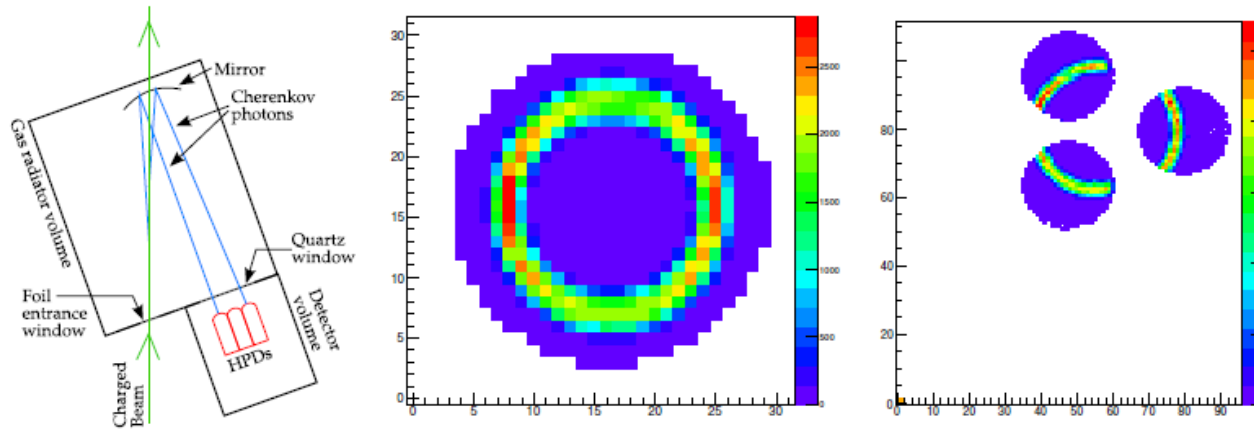

Figure 1: Side view of the LHCb spectrometer, with the two RICH detectors indicated



# RICH Čerenkov



**Figure 6:** LEFT: View from above of the arrangement of apparatus for the beam tests at Frascati and CERN. Electrons or charged pions enter the radiator, and produce Cherenkov photons in the Cherenkov radiator medium, which are reflected by the mirror and can then be detected by the HPDs. CENTRE: Display of Cherenkov ring in  $N_2$  radiator, integrated over a run of  $\sim 38,500$  events; RIGHT: Cherenkov ring in  $C_4F_{10}$  split across three HPDs ( $\sim 35,000$  events).

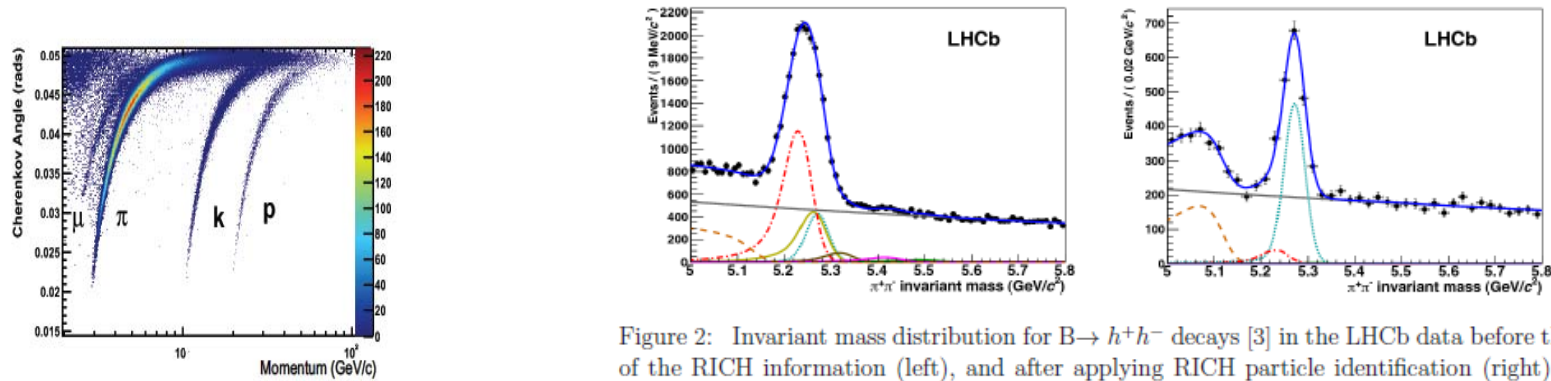

Figure 14: Reconstructed Cherenkov angle as a function of track momentum in the  $C_4F_{10}$  radiator

**Figure 2:** Invariant mass distribution for  $B \rightarrow h^+ h^-$  decays [3] in the LHCb data before the use of the RICH information (left), and after applying RICH particle identification (right). The signal under study is the decay  $B^0 \rightarrow \pi^+ \pi^-$ , represented by the turquoise dotted line. The contributions from different  $b$ -hadron decay modes ( $B^0 \rightarrow K\pi$  red dashed-dotted line,  $B^0 \rightarrow 3$ -body orange dashed-dashed line,  $B_s \rightarrow KK$  yellow line,  $B_s \rightarrow K\pi$  brown line,  $\Lambda_b \rightarrow pK$  purple line,  $\Lambda_b \rightarrow p\pi$  green line), are eliminated by positive identification of pions, kaons and protons and only the signal and two background contributions remain visible in the plot on the right. The grey solid line is the combinatorial background

# DETECTOR TECHNOLOGIES

## Lecture 3 : Radiation Detectors

- Scintillation and Detection
- Čerenkov
- **TRD**

## Transition Radiation Detector

**Transition radiation** is a photon emission ( $X$ ) occurring when a charged particle passes through inhomogeneous media, such as a boundary between two different media with different dielectric properties

Emission at an angle  $\cos \theta = \frac{1}{\gamma}$

Very low rate  $\sim 1/2 \alpha$  (fine structure constant)

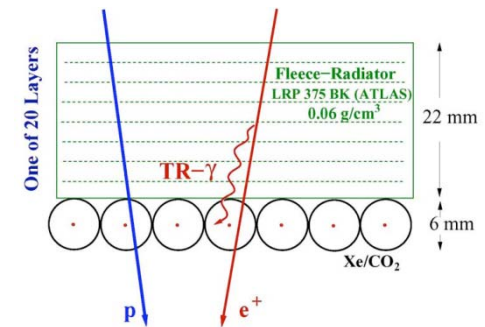

# Transition Radiation Detector

## ALICE TRD

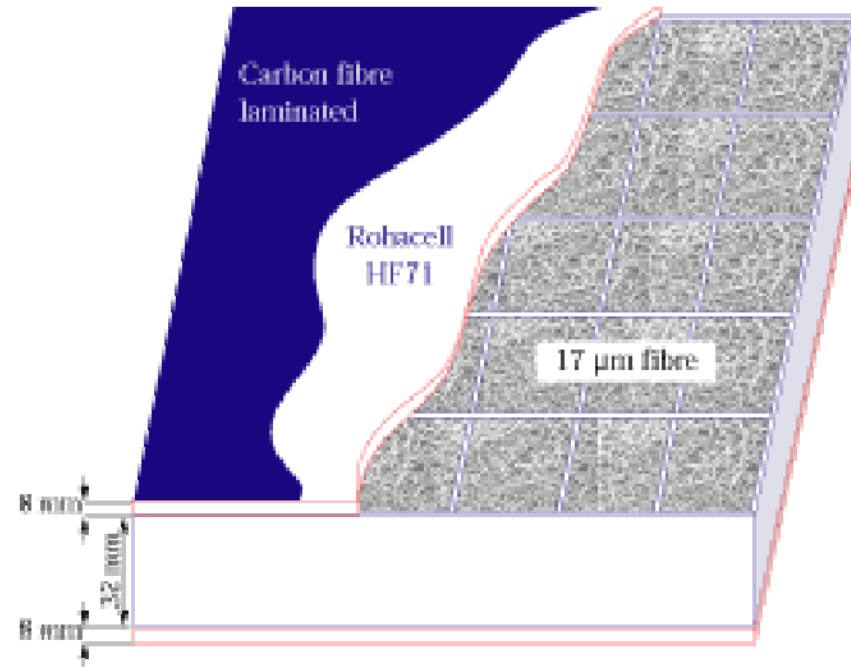
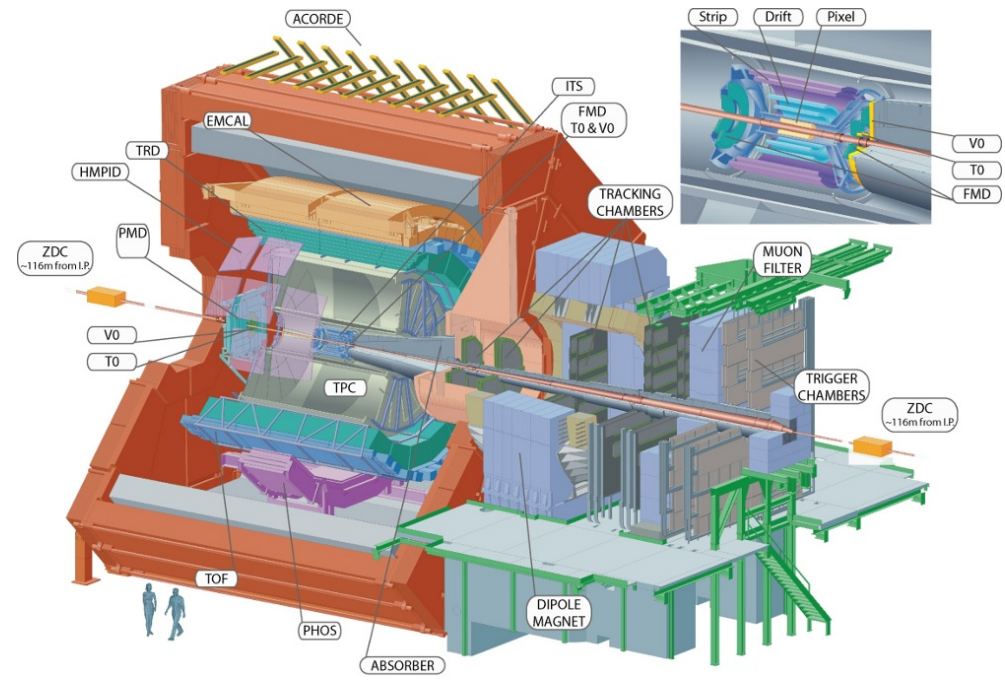
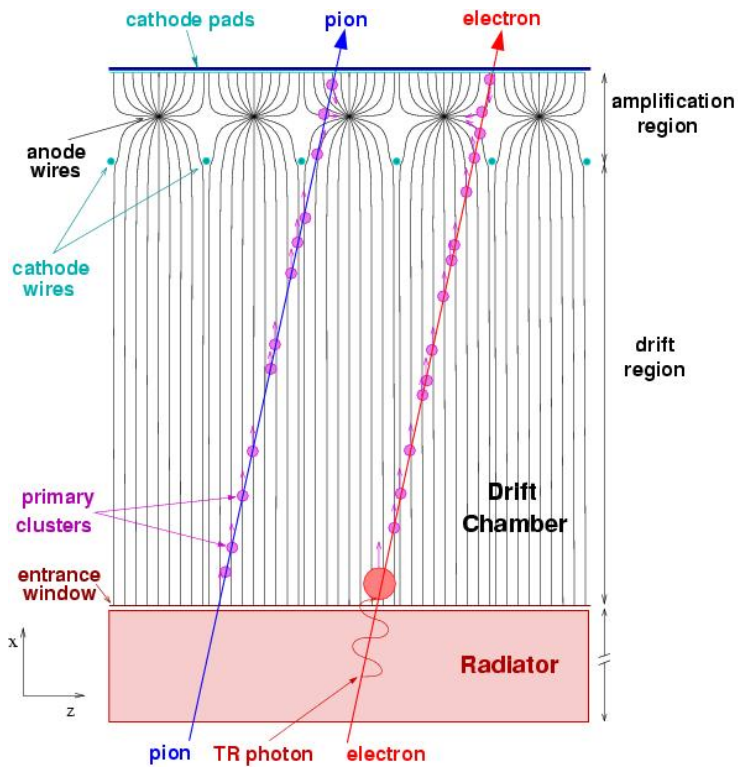



ALICE TRD

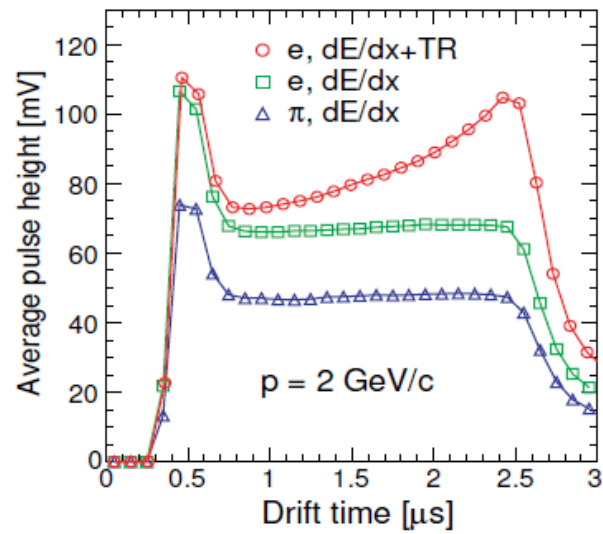

Figure 4: Average pulse height as function of the drift time.

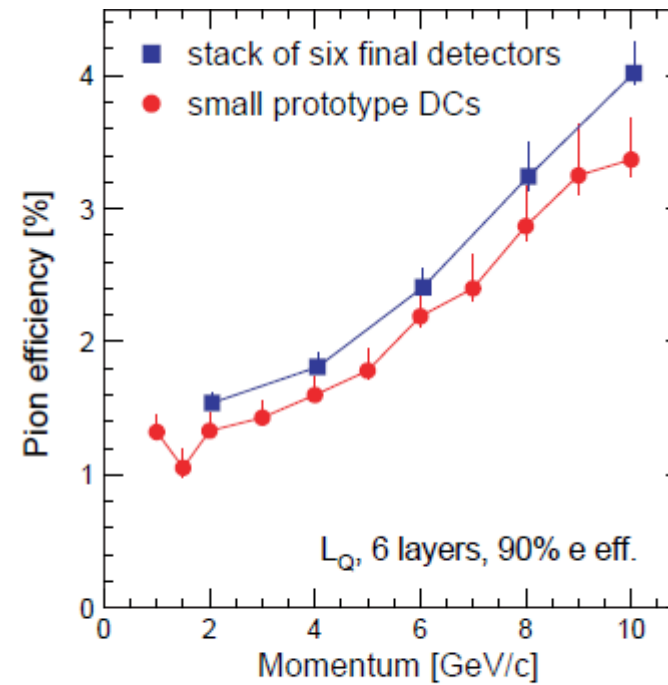
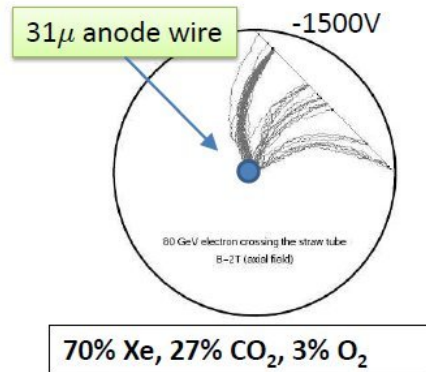

Figure 9: Measured electron identification performance.

## ATLAS TRT : Combination Tracker / TRD

About 300 000 Straw tubes : position measurement by  $dE/dX$   
radiation occurs on the wall of the tube



- Energy deposited in TRT, average event:  
Sum of ionization losses of charged particles:  $\sim 2.5$  keV  
Deposition due to transition radiation photon absorption:  $>5$  keV

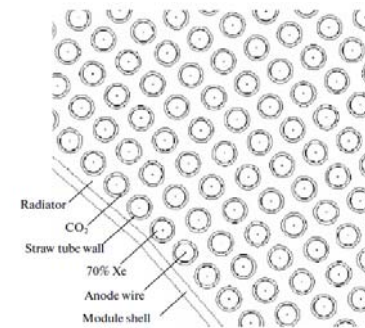

Fig. 5. Arrangement of straws in the module of the TRT

Table 1. Parameters of the barrel and end-cap modules

	$ z _{\min}$ , mm	$ z _{\max}$ , mm	$R_{\min}$ , mm	$R_{\max}$ , mm	Modules	Layers	Straws in a module
<b>Barrel (both sides)</b>	<b>0</b>	<b>780</b>	<b>554</b>	<b>1082</b>	<b>96</b>	<b>73</b>	<b>52544</b>
Module of type 1 (inner)	400	712.1	563	624	32	9	329
Module of type 1 (outer)	7.5	712.1	625	694		10	
Module of type 2	7.5	712.1	697	860	32	24	520
Module of type 3	7.5	712.1	863	1066	32	30	793
<b>End-cap modules (one side)</b>	<b>827</b>	<b>2744</b>	<b>615</b>	<b>1106</b>	<b>20</b>	<b>160</b>	<b>122880</b>
Module of type A	848	1705	644	1004	12	8	6144
Module of type B	1740	2710	644	1004	8	8	6144

### ATLAS TRT : Combination Tracker / TRD

About 300 000 Straw tubes : position measurement by  $dE/dX$   
radiation occurs on the wall of the tube

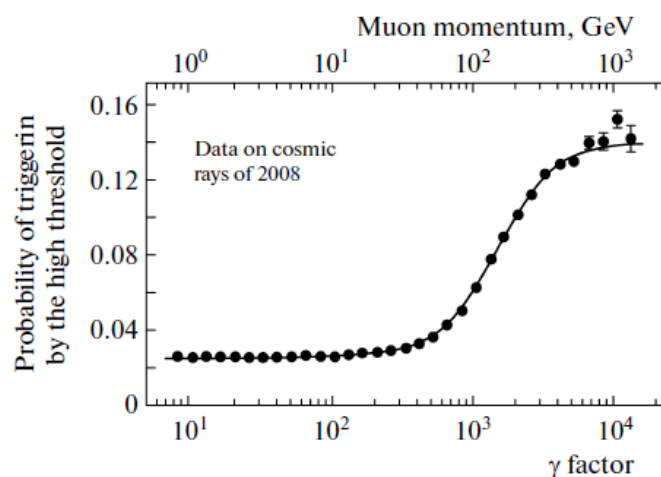
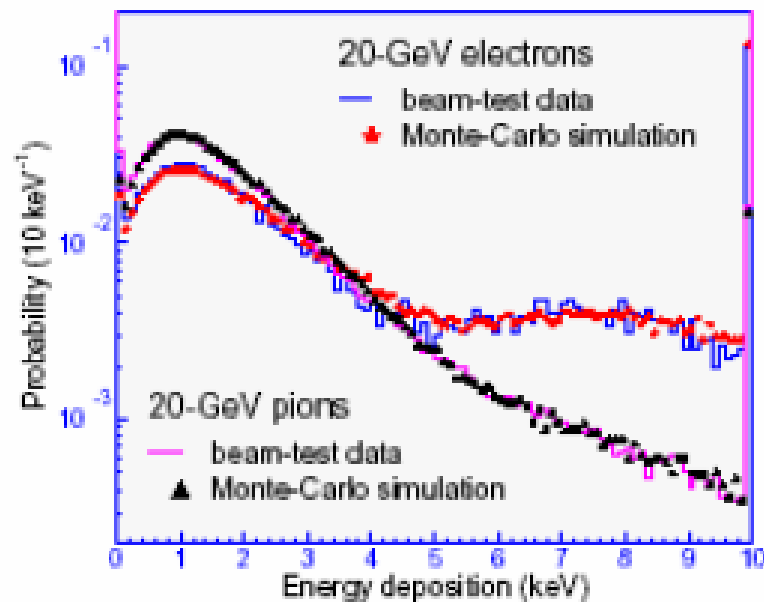

Fig. 14. Probability that a transition radiation photon will be produced in the ATLAS TRT vs. the Lorentz factor of the cosmic muon: the experimental data are shown with dots, and the fit is presented with a solid line.



Differential energy spectra from data and simulation for a single straw with radiator



*That's all Folks!*